

# SAR EVALUATION REPORT

For

## DT Research Inc.

6F., NO.1, Ning-Po E. Street, Taipei 100, Taiwan.

**FCC ID: YE3800D**

**Model: DT311**

<b>Report Type:</b> Original Report	<b>Product Type:</b> Mobile Tablet
<b>Test Engineer:</b> Terry XiaHou	<i>Terry XiaHou</i>
<b>Report Number:</b> RDG150615001-20A	
<b>Report Date:</b> 2015-06-24	
<b>Reviewed By:</b> SAR Engineer	<i>Bell Hu</i>
<b>Prepared By:</b> Bay Area Compliance Laboratories Corp. (Shenzhen) 6/F, the 3rd Phase of WanLi Industrial Building, ShiHua Road, FuTian Free Trade Zone Shenzhen, Guangdong, China Tel: +86-755-33320018 Fax: +86-755-33320008 <a href="http://www.baclcorp.com.cn">www.baclcorp.com.cn</a>	

Attestation of Test Results		
<b>EUT Information</b>	<b>Company Name</b>	DT Research Inc.
	<b>EUT Description</b>	Mobile Tablet
	<b>Product name</b>	Mobile Tablet
	<b>FCC ID</b>	YE3800D
	<b>Model Number</b>	DT311
	<b>Test Date</b>	2015-06-16
<b>Frequency</b>	<b>Max. SAR Level(s) Reported</b>	<b>Limit(W/Kg)</b>
<b>LTE Band 13</b>	0.494 W/kg 1g Body SAR	<b>1.6</b>
<b>WiFi 5G</b>	0.412 W/kg 1g Body SAR	
<b>Simultaneous</b>	1.502 W/kg 1g Body SAR	
<b>Applicable Standards</b>	<b>ANSI / IEEE C95.1 : 2005</b> IEEE Standard for Safety Levels with Respect to Human Exposure to Radio Frequency Electromagnetic Fields,3 kHz to 300 GHz.	
	<b>ANSI / IEEE C95.3 : 2002</b> IEEE Recommended Practice for Measurements and Computations of Radio Frequency Electromagnetic Fields With Respect to Human Exposure to Such Fields,100 kHz—300 GHz.	
	<b>IEEE1528:2013</b> IEEE Recommended Practice for Determining the Peak Spatial-Average Specific Absorption Rate (SAR) in the Human Head from Wireless Communications Devices: Measurement Techniques	
	<b>IEC62209-2:2010</b> Human exposure to radio frequency fields from hand-held and body-mounted wireless communication devices – Human models, instrumentation, and procedures – Part 2: Procedure to determine the specific absorption rate (SAR) for wireless communication devices used in close proximity to the human body (frequency range of 30 MHz to 6 GHz)	
	<b>KDB procedures</b> KDB 447498 D01 General RF Exposure Guidance v05r02. KDB 616217 D04 SAR for laptop and tablets v01r01 KDB 865664 D01 SAR measurement 100 MHz to 6 GHz v01r03 KDB 865664 D02 RF Exposure Reporting v01r01 KDB 941225 D01 3G SAR Procedures v03 KDB 941225 D05 SAR for LTE Devices v02r03 KDB 941225 D06 Hotspot Mode v02 KDB 248227 D01-SAR Measurement Procedures for 802.11a/b/g Transmitters	
<p><b>Note:</b> This wireless device has been shown to be capable of compliance for localized specific absorption rate (SAR) for General Population/Uncontrolled Exposure limits specified in ANSI/IEEE Standards and has been tested in accordance with the measurement procedures specified in IEEE 1528-2013 and RF exposure KDB procedures.</p> <p><b>The results and statements contained in this report pertain only to the device(s) evaluated.</b></p>		

## TABLE OF CONTENTS

**DOCUMENT REVISION HISTORY .....4**

**EUT DESCRIPTION .....5**

TECHNICAL SPECIFICATION .....5

**REFERENCE, STANDARDS, AND GUIDELINES .....6**

SAR LIMITS .....7

**FACILITIES .....8**

**DESCRIPTION OF TEST SYSTEM .....9**

**EQUIPMENT LIST AND CALIBRATION .....16**

EQUIPMENTS LIST & CALIBRATION INFORMATION .....16

**SAR MEASUREMENT SYSTEM VERIFICATION .....17**

LIQUID VERIFICATION .....17

SYSTEM ACCURACY VERIFICATION .....19

SAR SYSTEM VALIDATION DATA .....20

**EUT TEST STRATEGY AND METHODOLOGY .....28**

TEST POSITIONS FOR DEVICE OPERATING NEXT TO A PERSON’S EAR .....28

CHEEK/TOUCH POSITION .....29

EAR/TILT POSITION .....29

TEST POSITIONS FOR BODY-WORN AND OTHER CONFIGURATIONS .....30

SAR EVALUATION PROCEDURE .....31

TEST METHODOLOGY .....31

**CONDUCTED OUTPUT POWER MEASUREMENT .....32**

PROVISION APPLICABLE .....32

TEST PROCEDURE .....32

MAXIMUM OUTPUT POWER AMONG PRODUCTION UNITS .....33

TEST RESULTS: .....34

PROXIMITY SENSOR OPERATION .....34

**SAR MEASUREMENT RESULTS .....41**

SAR TEST DATA .....41

SAR PLOTS (SUMMARY OF THE HIGHEST SAR VALUES) .....46

**APPENDIX A MEASUREMENT UNCERTAINTY .....51**

**APPENDIX B – PROBE CALIBRATION CERTIFICATES .....53**

**APPENDIX C DIPOLE CALIBRATION CERTIFICATES .....63**

**APPENDIX D EUT TEST POSITION PHOTOS .....99**

**APPENDIX E EUT PHOTOS .....100**

**APPENDIX F INFORMATIVE REFERENCES .....101**

---

**DOCUMENT REVISION HISTORY**

---

Revision Number	Report Number	Description of Revision	Date of Revision
0	RDG150615001-20A	Original Report	2015-06-24

**Note:**

For CDMA850, CDMA1900, LTE Band 4, WiFi 2.4G data, please refer to the report RDG150615001-20.  
For SAR simultaneous transmission description, please refer to the report RDG150615001-20.

## EUT DESCRIPTION

This report has been prepared on behalf of DT Research Inc. and their product, FCC ID: YE3800D, Model: DT311 or the EUT (Equipment under Test) as referred to in the rest of this report.

### Technical Specification

<b>Product Type</b>	Portable
<b>Exposure Category:</b>	Population / Uncontrolled
<b>Antenna Type(s):</b>	Internal Antenna
<b>Body-Worn Accessories:</b>	Headset
<b>Face-Head Accessories:</b>	None
<b>Multi-slot Class:</b>	None
<b>Operation Mode :</b>	CDMA Data, LTE Data WiFi 2.4G/5G and Bluetooth
<b>Frequency Band:</b>	CDMA 850 : 824-849 MHz(TX) ; 869-894 MHz(RX) CDMA 1900: 1850-1910 MHz(TX) ; 1930-1990 MHz(RX) LTE Band 4: 1710-1785 MHz(TX) ; 2110-2155 MHz(RX) LTE Band 13: 777-787 MHz(TX) ; 746-756 MHz(RX) Wi-Fi 2.4G: 2412MHz-2462MHz Wi-Fi 5G: 5150-5250 MHz/5250-5350 MHz/5470-5725 MHz/5725-5850 MHz Bluetooth : 2402MHz-2480MHz
<b>Conducted RF Power:</b>	CDMA 850 : 23.71 dBm CDMA 1900: 22.96 dBm LTE Band 4: 22.36 dBm LTE Band 13: 22.48 dBm Wi-Fi 2.4G: 17.97 dBm Wi-Fi 5G: 14.32 dBm Bluetooth : 4.81 dBm
<b>Dimensions (L*W*H):</b>	315 mm (L) × 212 mm (W) × 42 mm (H)
<b>Power Source:</b>	7.2 V <sub>DC</sub> Rechargeable Battery
<b>Normal Operation:</b>	Body-worn

#### Note:

- 1, For CDMA850,CDMA1900,LTE Band 4, WiFi 2.4G data, please refer to the report RDG150615001-20.
- 2, The overall diagonal dimension of the EUT > 200mm, so test procedures in KDB616217 should be applicable.

---

## REFERENCE, STANDARDS, AND GUIDELINES

---

### **FCC:**

The Report and Order requires routine SAR evaluation prior to equipment authorization of portable transmitter devices, including portable telephones. For consumer products, the applicable limit is 1.6 mW/g as recommended by the ANSI/IEEE standard C95.1-1992 [6] for an uncontrolled environment (Paragraph 65). According to the Supplement C of OET Bulletin 65 "Evaluating Compliance with FCC Guide-lines for Human Exposure to Radio frequency Electromagnetic Fields", released on Jun 29, 2001 by the FCC, the device should be evaluated at maximum output power (radiated from the antenna) under "worst-case" conditions for normal or intended use, incorporating normal antenna operating positions, device peak performance frequencies and positions for maximum RF energy coupling.

This report describes the methodology and results of experiments performed on wireless data terminal. The objective was to determine if there is RF radiation and if radiation is found, what is the extent of radiation with respect to safety limits. SAR (Specific Absorption Rate) is the measure of RF exposure determined by the amount of RF energy absorbed by human body (or its parts) – to determine how the RF energy couples to the body or head which is a primary health concern for body worn devices. The limit below which the exposure to RF is considered safe by regulatory bodies in North America is 1.6 mW/g average over 1 gram of tissue mass.

### **CE:**

The order requires routine SAR evaluation prior to equipment authorization of portable transmitter devices, including portable telephones. For consumer products, the applicable limit is 2 mW/g as recommended by EN62209-1 for an uncontrolled environment. According to the Standard, the device should be evaluated at maximum output power (radiated from the antenna) under "worst-case" conditions for normal or intended use, incorporating normal antenna operating positions, device peak performance frequencies and positions for maximum RF energy coupling.

This report describes the methodology and results of experiments performed on wireless data terminal. The objective was to determine if there is RF radiation and if radiation is found, what is the extent of radiation with respect to safety limits. SAR (Specific Absorption Rate) is the measure of RF exposure determined by the amount of RF energy absorbed by human body (or its parts) – to determine how the RF energy couples to the body or head which is a primary health concern for body worn devices. The limit below which the exposure to RF is considered safe by regulatory bodies in Europe is 2 mW/g average over 10 gram of tissue mass.

The test configurations were laid out on a specially designed test fixture to ensure the reproducibility of measurements. Each configuration was scanned for SAR. Analysis of each scan was carried out to characterize the above effects in the device.

**SAR Limits**

FCC Limit (1g Tissue)

EXPOSURE LIMITS	SAR (W/kg)	
	(General Population / Uncontrolled Exposure Environment)	(Occupational / Controlled Exposure Environment)
Spatial Average (averaged over the whole body)	0.08	0.4
Spatial Peak (averaged over any 1 g of tissue)	1.60	8.0
Spatial Peak (hands/wrists/feet/ankles averaged over 10 g)	4.0	20.0

CE Limit (10g Tissue)

EXPOSURE LIMITS	SAR (W/kg)	
	(General Population / Uncontrolled Exposure Environment)	(Occupational / Controlled Exposure Environment)
Spatial Average (averaged over the whole body)	0.08	0.4
Spatial Peak (averaged over any 10 g of tissue)	2.0	10
Spatial Peak (hands/wrists/feet/ankles averaged over 10 g)	4.0	20.0

Population/Uncontrolled Environments are defined as locations where there is the exposure of individual who have no knowledge or control of their exposure.

Occupational/Controlled Environments are defined as locations where there is exposure that may be incurred by people who are aware of the potential for exposure (i.e. as a result of employment or occupation).

General Population/Uncontrolled environments Spatial Peak limit 1.6W/kg (FCC) & 2 W/kg (CE) applied to the EUT.

## **FACILITIES**

---

The test site used by Bay Area Compliance Laboratories Corp. (Shenzhen) to collect data is located at 6/F, the 3rd Phase of WanLi Industrial Building, Shi Hua Road, Fu Tian Free Trade Zone, Shenzhen, Guangdong, P.R. of China



## DESCRIPTION OF TEST SYSTEM

These measurements were performed with ALSAS 10 Universal Integrated SAR Measurement system from APREL Laboratories.

### ALSAS-10U System Description

ALSAS-10-U is fully compliant with the technical and scientific requirements of IEEE 1528, IEC 62209, CENELEC, ARIB, ACA, and the Federal Communications Commission. The system comprises of a six axes articulated robot which utilizes a dedicated controller.

ALSAS-10U uses the latest methodologies. And FDTD modeling to provide a platform which is repeatable with minimum uncertainty.

### Applications

Predefined measurement procedures compliant with the guidelines of CENELEC, IEEE, IEC, FCC, etc are utilized during the assessment for the device. Automatic detection for all SAR maxima are embedded within the core architecture for the system, ensuring that peak locations used for centering the zoom scan are within a 1mm resolution and a 0.05mm repeatable position. System operation range currently available up-to 6 GHz in simulated tissue.

### Area Scans

Area scans are defined prior to the measurement process being executed with a user defined variable spacing between each measurement point (integral) allowing low uncertainty measurements to be conducted. Scans defined for FCC applications utilize a 10mm<sup>2</sup> step integral, with 1mm interpolation used to locate the peak SAR area used for zoom scan assessments.

Where the system identifies multiple SAR peaks (which are within 25% of peak value) the system will provide the user with the option of assessing each peak location individually for zoom scan averaging.

### Zoom Scan (Cube Scan Averaging)

The averaging zoom scan volume utilized in the ALSAS-10U software is in the shape of a cube and the side dimension of a 1 g or 10 g mass is dependent on the density of the liquid representing the simulated tissue. A density of 1000 kg/m<sup>3</sup> is used to represent the head and body tissue density and not the phantom liquid density, in order to be consistent with the definition of the liquid dielectric properties, i.e. the side length of the 1 g cube is 10mm, with the side length of the 10 g cube 21,5mm.

When the cube intersects with the surface of the phantom, it is oriented so that 3 vertices touch the surface of the shell or the center of a face is tangent to the surface. The face of the cube closest to the surface is modified in order to conform to the tangent surface.

The zoom scan integer steps can be user defined so as to reduce uncertainty, but normal practice for typical test applications (including FCC) utilize a physical step of 5x5x8 (8mmx8mmx5mm) providing a volume of 32mm in the X & Y axis, and 35mm in the Z axis.



**ALSAS-10U Interpolation and Extrapolation Uncertainty**

The overall uncertainty for the methodology and algorithms the used during the SAR calculation was evaluated using the data from IEEE 1528 based on the example f3 algorithm:

$$f_3(x, y, z) = A \frac{a^2}{\frac{a^2}{4} + x'^2 + y'^2} \cdot \left( e^{-\frac{2z}{a}} + \frac{a^2}{2(a + 2z)^2} \right)$$

**Isotropic E-Field Probe**

The isotropic E-Field probe has been fully calibrated and assessed for isotropicity, and boundary effect within a controlled environment. Depending on the frequency for which the probe is calibrated the method utilized for calibration will change.

The E-Field probe utilizes a triangular sensor arrangement as detailed in the diagram below:

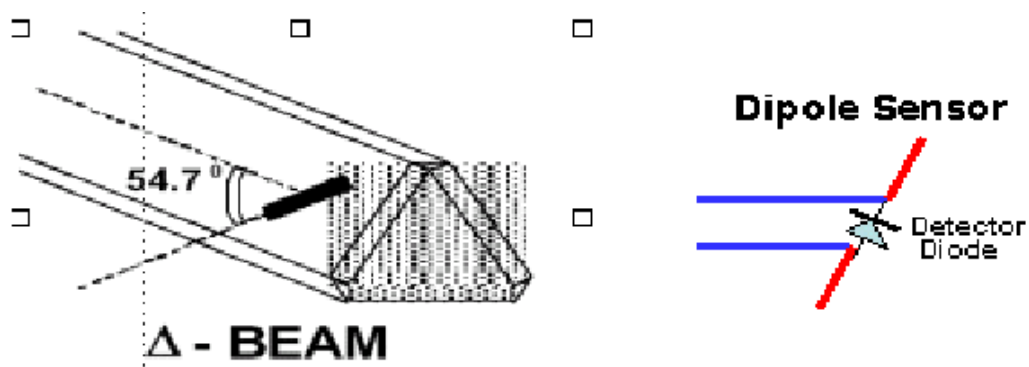

SAR is assessed with a calibrated probe which moves at a default height of 5mm from the center of the diode, which is mounted to the sensor, to the phantom surface (in the Z Axis). The 5mm offset height has been selected so as to minimize any resultant boundary effect due to the probe being in close proximity to the phantom surface.

The following algorithm is an example of the function used by the system for linearization of the output from the probe when measuring complex modulation schemes.

$$V_i = U_i + U_i^2 \cdot \frac{cf}{dcp_i}$$

### Isotropic E-Field Probe Specification

<b>Calibration Method</b>	Frequency Dependent Below 1 GHz Calibration in air performed in a TEM Cell Above 1 GHz Calibration in air performed in waveguide
<b>Sensitivity</b>	0.70 $\mu\text{V}/(\text{V}/\text{m})^2$ to 0.85 $\mu\text{V}/(\text{V}/\text{m})^2$
<b>Dynamic Range</b>	0.0005 W/kg to 100 W/kg
<b>Isotropic Response</b>	Better than 0.1 dB
<b>Diode Compression Point (DCP)</b>	Calibration for Specific Frequency
<b>Probe Tip Diameter</b>	< 2.9 mm
<b>Sensor Offset</b>	1.56 (+/- 0.02 mm)
<b>Probe Length</b>	289 mm
<b>Video Bandwidth</b>	@ 500 Hz: 1 dB @ 1.02 kHz: 3 dB
<b>Boundary Effect</b>	Less than 2.1% for distance greater than 0.58 mm
<b>Spatial Resolution</b>	The spatial resolution uncertainty is less than 1.5% for 4.9mm diameter probe. The spatial resolution uncertainty is less than 1.0% for 2.5mm diameter probe

### Boundary Detection Unit and Probe Mounting Device

ALSAS-10U incorporates a boundary detection unit with a sensitivity of 0.05mm for detecting all types of surfaces. The robust design allows for detection during probe tilt (probe normalize) exercises, and utilizes a second stage emergency stop. The signal electronics are fed directly into the robot controller for high accuracy surface detection in lateral and axial detection modes (X, Y, & Z).

The probe is mounted directly onto the Boundary Detection unit for accurate tooling and displacement calculations controlled by the robot kinematics. The probe is connect to an isolated probe interconnect where the output stage of the probe is fed directly into the amplifier stage of the Daq-Paq.

### Daq-Paq (Analog to Digital Electronics)

ALSAS-10U incorporates a fully calibrated Daq-Paq (analog to digital conversion system) which has a 4 channel input stage, sent via a 2 stage auto-set amplifier module. The input signal is amplified accordingly so as to offer a dynamic range from 5 $\mu\text{V}$  to 800mV. Integration of the fields measured is carried out at board level utilizing a Co-Processor which then sends the measured fields down into the main computational module in digitized form via an RS232 communications port. Probe linearity and duty cycle compensation is carried out within the main Daq-Paq module.

<b>ADC</b>	12 Bit
<b>Amplifier Range</b>	20 mV to 200 mV and 150 mV to 800 mV
<b>Field Integration</b>	Local Co-Processor utilizing proprietary integration algorithms
<b>Number of Input Channels</b>	4 in total 3 dedicated and 1 spare
<b>Communication</b>	Packet data via RS232

**Axis Articulated Robot**

ALSAS-10U utilizes a six axis articulated robot, which is controlled using a Pentium based real-time movement controller. The movement kinematics engine utilizes proprietary (Thermo CRS) interpolation and extrapolation algorithms, which allow full freedom of movement for each of the six joints within the working envelope. Utilization of joint 6 allows for full probe rotation with a tolerance better than 0.05mm around the central axis.



<b>Robot/Controller Manufacturer</b>	Thermo CRS
<b>Number of Axis</b>	Six independently controlled axis
<b>Positioning Repeatability</b>	0.05 mm
<b>Controller Type</b>	Single phase Pentium based C500C
<b>Robot Reach</b>	710 mm
<b>Communication</b>	RS232 and LAN compatible

**ALSAS Universal Workstation**

ALSAS Universal workstation allows for repeatability and fast adaptability. It allows users to do calibration, testing and measurements using different types of phantoms with one set up, which significantly speeds up the measurement process.

**Universal Device Positioner**

The universal device positioner allows complete freedom of movement of the EUT. Developed to hold a EUT in a free-space scenario any additional loading attributable to the material used in the construction of the positioner has been eliminated. Repeatability has been enhanced through the linear scales which form the design used to indicate positioning for any given test scenario in all major axes. A 15° tilt indicator is included for the of aid cheek to tilt movements for head SAR analysis. Overall uncertainty for measurements have been reduced due to the design of the Universal device positioner, which allows positioning of a device in as near to a free-space scenario as possible, and by providing the means for complete repeatability.



**Phantom Types**

The ALSAS-10U allows the integration of multiple phantom types. SAM Phantoms fully compliant with IEEE 1528, Universal Phantom, and Universal Flat.

**APREL SAM Phantoms**

The SAM phantoms developed using the IEEE SAM CAD file. They are fully compliant with the requirements for both IEEE 1528 and FCC Supplement C. Both the left and right SAM phantoms are interchangeable, transparent and include the IEEE 1528 grid with visible NF and MB lines.

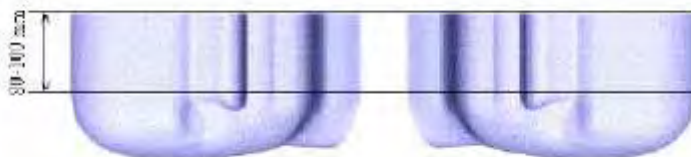

**APREL Laboratories Universal Phantom**

The Universal Phantom is used on the ALSAS-10U as a system validation phantom. The Universal Phantom has been fully validated both experimentally from 800MHz to 6GHz and numerically using XFDTD numerical software.

The shell thickness is 2mm overall, with a 4mm spacer located at the NF/MB intersection providing an overall thickness of 6mm in line with the requirements of IEEE-1528.

The design allows for fast and accurate measurements, of handsets, by allowing the conservative SAR to be evaluated at on frequency for both left and right head experiments in one measurement.



### Tissue Dielectric Parameters for Head and Body Phantoms

The head tissue dielectric parameters recommended by the IEEE SCC-34/SC-2 in P1528 have been incorporated in the following table. These head parameters are derived from planar layer models simulating the highest expected SAR for the dielectric properties and tissue thickness variations in a human head. Other head and body tissue parameters that have not been specified in P1528 are derived from the tissue dielectric parameters computed from the 4-Cole-Cole equations described in Reference [12] and extrapolated according to the head parameters specified in P1528.

Ingredients (% by weight)	Frequency (MHz)									
	450		835		915		1900		2450	
Tissue Type	Head	Body	Head	Body	Head	Body	Head	Body	Head	Body
Water	38.56	51.16	41.45	52.4	41.05	56.0	54.9	40.4	62.7	73.2
Salt (Nacl)	3.95	1.49	1.45	1.4	1.35	0.76	0.18	0.5	0.5	0.04
Sugar	56.32	46.78	56.0	45.0	56.5	41.76	0.0	58.0	0.0	0.0
HEC	0.98	0.52	1.0	1.0	1.0	1.21	0.0	1.0	0.0	0.0
Bactericide	0.19	0.05	0.1	0.1	0.1	0.27	0.0	0.1	0.0	0.0
Triton x-100	0.0	0.0	0.0	0.0	0.0	0.0	0.0	0.0	36.8	0.0
DGBE	0.0	0.0	0.0	0.0	0.0	0.0	44.92	0.0	0.0	26.7
Dielectric Constant	43.42	58.0	42.54	56.1	42.0	56.8	39.9	54.0	39.8	52.5
Conductivity (s/m)	0.85	0.83	0.91	0.95	1.0	1.07	1.42	1.45	1.88	1.78

### Recommended Tissue Dielectric Parameters for Head and Body

Frequency (MHz)	Head Tissue		Body Tissue	
	$\epsilon_r$	$\sigma$ (S/m)	$\epsilon_r$	$\sigma$ (S/m)
150	52.3	0.76	61.9	0.80
300	45.3	0.87	58.2	0.92
450	43.5	0.87	56.7	0.94
835	41.5	0.90	55.2	0.97
900	41.5	0.97	55.0	1.05
915	41.5	0.98	55.0	1.06
1450	40.5	1.20	54.0	1.30
1610	40.3	1.29	53.8	1.40
1800-2000	40.0	1.40	53.3	1.52
2450	39.2	1.80	52.7	1.95
3000	38.5	2.40	52.0	2.73
5800	35.3	5.27	48.2	6.00

## EQUIPMENT LIST AND CALIBRATION

### Equipments List & Calibration Information

Equipment	Model	Calibration Date	S/N
CRS F3 robot	ALS-F3	N/A	RAF0805352
CRS F3 Software	ALS-F3-SW	N/A	N/A
CRS C500C controller	ALS-C500	N/A	RCF0805379
Probe mounting device & Boundary	ALS-PMDPS-3	N/A	120-00270
Universal Work Station	ALS-UWS	N/A	100-00157
Data Acquisition Package	ALS-DAQ-PAQ-3	2014-10-14	110-00212
Miniature E-Field Probe	ALS-E-020	2014-10-14	500-00283
Dipole, 750MHz	ALS-D-750-S-2	2013-10-08	177-00505
Dipole,5250MHz	ALS-D-5250-S-2	2013-10-08	230-00805
Dipole,5600MHz	ALS-D-5600-S-2	2013-10-08	234-00703
Dipole,5800MHz	ALS-D-5800-S-2	2013-10-08	240-00855
Dipole Spacer	ALS-DS-U	N/A	250-00907
Device holder/Positioner	ALS-H-E-SET-2	N/A	170-00510
Left ear SAM phantom	ALS-P-SAM-L	N/A	130-00311
Right ear SAM phantom	ALS-P-SAM-R	N/A	140-00359
UniPhantom	ALS-P-UP-1	N/A	150-00413
Simulated Tissue 750 MHz Body	ALS-TS-750-B	Each Time	269-02107
Simulated Tissue 5250 MHz Body	ALS-TS-5250-B	Each Time	520-00705
Simulated Tissue 5600 MHz Body	ALS-TS-5600-B	Each Time	560-00308
Simulated Tissue 5800 MHz Body	ALS-TS-5800-B	Each Time	580-00718
Directional couple	DC6180A	N/A	0325849
Power Amplifier	5S1G4	N/A	71377
Dielectric probe kit	HP85070B	2015-06-12	N/A
Attenuator	3dB	2015-05-07	5402
Network analyzer	8752C	2015-06-02	3410A02356
Synthesized Sweeper	HP 8341B	2015-06-02	2624A00116
WIDEBAND RADIO COMMUNICATION TESTER	CMW500	2015-04-18	114772
EMI Test Receiver	ESCI	2015-06-12	101746



# SAR MEASUREMENT SYSTEM VERIFICATION

## Liquid Verification

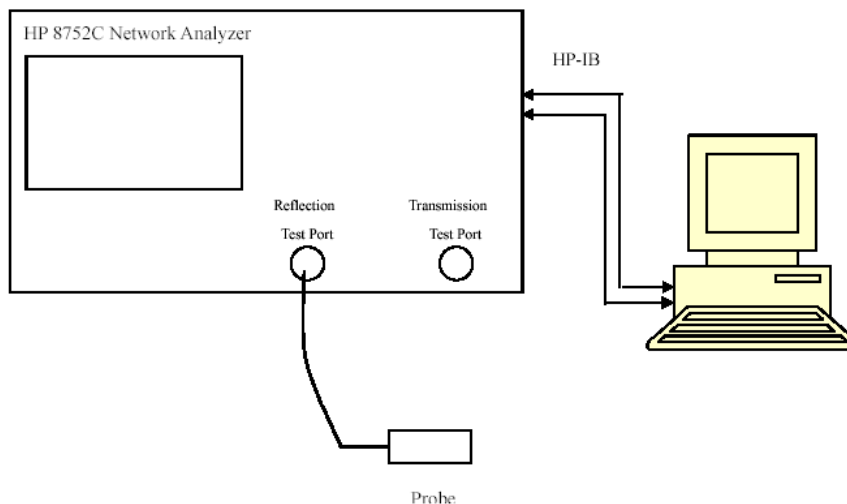

Liquid Verification Setup Block Diagram

## Liquid Verification Results

Frequency	Liquid Type	Liquid Parameter		Target Value		Delta (%)		Tolerance (%)
		$\epsilon_r$	$\sigma$ (S/m)	$\epsilon_r$	$\sigma$ (S/m)	$\Delta\epsilon_r$	$\Delta\sigma$ (S/m)	
782.0	Body	54.66	0.98	55.50	0.96	-1.514	2.083	±5
5180	Body	48.15	5.47	48.90	5.36	-1.534	2.052	±5
5220	Body	48.10	5.50	48.90	5.36	-1.636	2.612	±5
5240	Body	48.07	5.51	48.90	5.36	-1.697	2.799	±5
5260	Body	48.06	5.53	48.90	5.36	-1.718	3.172	±5
5300	Body	48.01	5.56	48.90	5.36	-1.820	3.731	±5
5320	Body	47.98	5.57	48.90	5.36	-1.881	3.918	±5
5500	Body	47.78	5.70	48.50	5.77	-1.485	-1.213	±5
5560	Body	47.72	5.74	48.50	5.77	-1.608	-0.520	±5
5620	Body	47.64	5.78	48.50	5.77	-1.773	0.173	±5
5745	Body	47.51	5.86	48.20	6.00	-1.432	-2.333	±5
5785	Body	47.46	5.88	48.20	6.00	-1.535	-2.000	±5
5805	Body	47.44	5.90	48.20	6.00	-1.577	-1.667	±5

\*Liquid Verification was performed on 2015-06-16.

Please refer to the following tables.

750 MHz Body			5GHz Body		
Frequency (MHz)	e'	e''	Frequency (MHz)	e'	e''
751.0	54.6256	22.7292	5150.0	48.1790	19.0290
752.0	54.6219	22.5866	5164.0	48.1637	19.0134
753.0	54.6480	22.5441	5177.0	48.1484	18.9978
754.0	54.6124	22.7151	5191.0	48.1331	18.9822
755.0	54.5551	22.7407	5204.0	48.1178	18.9666
756.0	54.6553	22.6846	5218.0	48.1025	18.9510
757.0	54.6416	22.4260	5231.0	48.0872	18.9354
758.0	54.5553	22.5323	5245.0	48.0719	18.9198
759.0	54.5778	22.4995	5258.0	48.0566	18.9042
760.0	54.6486	22.6683	5272.0	48.0413	18.8886
761.0	54.5533	22.5453	5285.0	48.0260	18.8730
762.0	54.6451	22.4358	5299.0	48.0107	18.8574
763.0	54.5849	22.5965	5312.0	47.9954	18.8418
764.0	54.5696	22.6868	5326.0	47.9801	18.8262
765.0	54.6118	22.5906	5339.0	47.9648	18.8106
766.0	54.6520	22.3998	5353.0	47.9495	18.7950
767.0	54.5911	22.3961	5366.0	47.9342	18.7794
768.0	54.5802	22.6690	5380.0	47.9189	18.7638
769.0	54.6345	22.6567	5393.0	47.9036	18.7482
770.0	54.6182	22.7146	5407.0	47.8883	18.7326
771.0	54.5815	22.5092	5420.0	47.8730	18.7170
772.0	54.5973	22.6413	5434.0	47.8577	18.7014
773.0	54.6411	22.4399	5447.0	47.8424	18.6858
774.0	54.6327	22.7152	5461.0	47.8271	18.6702
775.0	54.5937	22.5194	5474.0	47.8118	18.6546
776.0	54.6281	22.7102	5488.0	47.7965	18.6390
777.0	54.5699	22.4515	5501.0	47.7812	18.6234
778.0	54.5622	22.6096	5515.0	47.7659	18.6078
779.0	54.6460	22.6273	5528.0	47.7506	18.5922
780.0	54.6595	22.4154	5542.0	47.7353	18.5766
781.0	54.6143	22.6619	5555.0	47.7200	18.5610
782.0	54.6594	22.5507	5569.0	47.7047	18.5454
783.0	54.6469	22.4523	5582.0	47.6894	18.5298
784.0	54.6460	22.6392	5596.0	47.6741	18.5142
785.0	54.6601	22.5736	5609.0	47.6588	18.4986
786.0	54.6412	22.4843	5623.0	47.6435	18.4830
787.0	54.6543	22.3715	5636.0	47.6282	18.4674
788.0	54.5872	22.6925	5650.0	47.6129	18.4518
789.0	54.6352	22.4089	5663.0	47.5976	18.4362
790.0	54.6627	22.5430	5677.0	47.5823	18.4206
791.0	54.5940	22.3628	5690.0	47.5670	18.4050
792.0	54.6051	22.3627	5704.0	47.5517	18.3894
793.0	54.5932	22.5633	5717.0	47.5364	18.3738
794.0	54.6352	22.4651	5731.0	47.5211	18.3582
795.0	54.5836	22.4283	5744.0	47.5058	18.3426
796.0	54.6288	22.4971	5758.0	47.4905	18.3270
797.0	54.6212	22.4644	5771.0	47.4752	18.3114
798.0	54.6160	22.6520	5785.0	47.4599	18.2958
799.0	54.6066	22.7287	5798.0	47.4446	18.2802
800.0	54.6059	22.4866	5812.0	47.4293	18.2646
801.0	54.5708	22.5495	5825.0	47.4140	18.2490

### System Accuracy Verification

Prior to the assessment, the system validation kit was used to test whether the system was operating within its specifications of  $\pm 10\%$ . The validation results are tabulated below. And also the corresponding SAR plot is attached as well in the SAR plots files.

### System Verification Setup Block Diagram

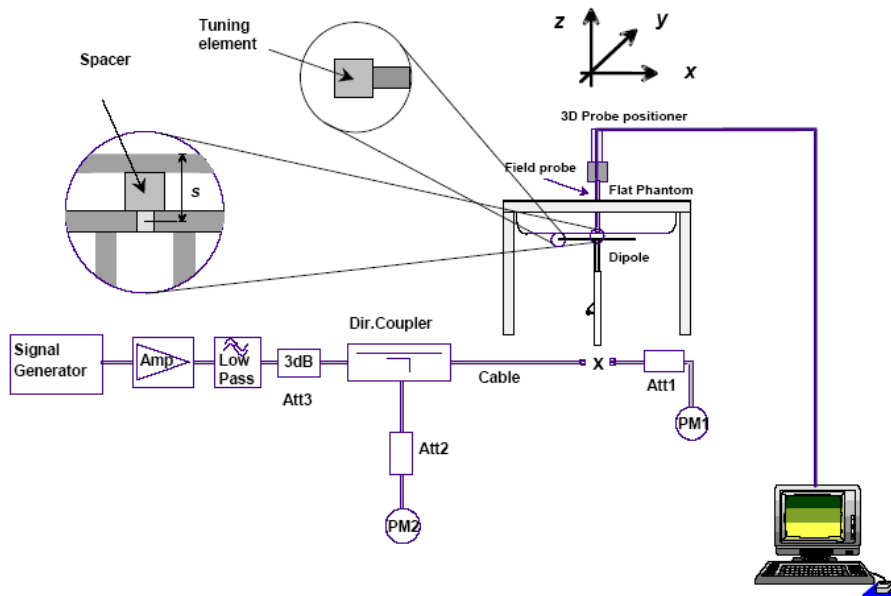

### Probe and dipole antenna List and Detail

Manufacturer	Description	Model	Serial Number	Calibration Date	Calibration Due Date
APREL	Probe	ALS-E-020	500-00283	2014-10-14	2015-10-13
APREL	Dipole antenna(750MHz)	ALS-D-750-S-2	177-00505	2013-10-08	2016-10-07
APREL	Dipole antenna(5250MHz)	ALS-D-5250-S-2	230-00805	2013-10-08	2016-10-07
APREL	Dipole antenna(5600MHz)	ALS-D-5600-S-2	234-00703	2013-10-08	2016-10-07
APREL	Dipole antenna(5800MHz)	ALS-D-5800-S-2	240-00855	2013-10-08	2016-10-07

### System Accuracy Check Results

Date	Frequency Band	Liquid Type	Measured SAR (W/Kg)		Target Value (W/Kg)	Delta (%)	Tolerance (%)
2015-06-16	750	Body	1g	8.596	8.540	6.347	$\pm 10$
	5250	Body	1g	16.491*4	64.00	0.575	$\pm 10$
	5600	Body	1g	16.135*4	64.59	1.112	$\pm 10$
	5800	Body	1g	16.032*4	62.84	2.610	$\pm 10$

\*All SAR values are normalized to 1 Watt forward power.

**SAR SYSTEM VALIDATION DATA****Test Laboratory: Bay Area Compliance Lab Corp. (Shenzhen)****System Performance Check 750 MHz Body Liquid****Dipole 750 MHz; Type: ALS-D-750-S-2; S/N: 177-00505**

## Product Data

Device Name : Dipole 750 MHz  
Serial No. : 177-00505  
Type : Dipole  
Model : ALS-D-750-S-2  
Frequency Band : 750  
Max. Transmit Pwr : 1 W  
Drift Time : 3 min(s)  
Power Drift-Start : 8.203 W/kg  
Power Drift-Finish : 8.269 W/kg  
Power Drift (%) : 0.794

## Phantom Data

Name : APREL-Uni  
Type : Uni-Phantom  
Serial No. : System Default  
Location : Center  
Description : Default  
Phantom Data

## Tissue Data

Type : Body  
Serial No. : 269-02107  
Frequency : 750.0 MHz  
Last Calib. Date : 16-Jun-2015  
Temperature : 20.00 °C  
Ambient Temp. : 21.00 °C  
Humidity : 56.00 RH%  
Epsilon : 54.59 F/m  
Sigma : 0.98 S/m  
Density : 1000.00 kg/cu. m

## Probe Data

Name : E-Field  
Model : E-020  
Type : E-Field Triangle  
Serial No. : 500-00283  
Last Calib. Date : 14-Oct-2014  
Frequency Band : 750  
Duty Cycle Factor : 1  
Conversion Factor : 5.5  
Probe Sensitivity : 1.20 1.20 1.20  $\mu\text{V}/(\text{V}/\text{m})^2$   
Compression Point : 95.00 mV  
Offset : 1.56 mm

## Measurement Data

Crest Factor : 1  
Scan Type : Complete  
Tissue Temp. : 21.00 °C  
Ambient Temp. : 21.00 °C  
Area Scan : 7x9x1 : Measurement x=10mm, y=10mm, z=4mm  
Zoom Scan : 7x7x7 : Measurement x=5mm, y=5mm, z=5mm

1 gram SAR value : 9.082 W/kg  
10 gram SAR value : 5.597 W/kg  
Area Scan Peak SAR : 10.757 W/kg  
Zoom Scan Peak SAR : 14.884 W/kg

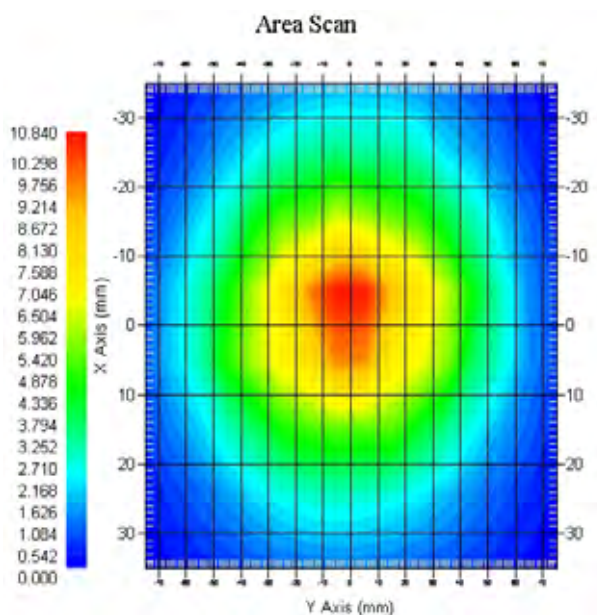

**750 MHz System Validation with Body Tissue**

**Test Laboratory: Bay Area Compliance Lab Corp. (Shenzhen)****System Performance Check 5250 MHz Body Liquid****Dipole 5250 MHz; Type: ALS-D-5250-S-2; S/N: 230-00805**

## Product Data

Device Name : Dipole 5250MHz  
Serial No. : 230-00805  
Type : Dipole  
Model : ALS-D-5250-S-2  
Frequency : 5250 MHz  
Max. Transmit Pwr : 0.25 W  
Drift Time : 3 min(s)  
Power Drift-Start : 7.259 W/kg  
Power Drift-Finish : 7.269 W/kg  
Power Drift (%) : 0.698

## Phantom Data

Name : APREL-Uni  
Type : Uni-Phantom  
Size (mm) : 280 x 280 x 200  
Serial No. : System Default  
Location : Center  
Description : Default

## Tissue Data

Type : BODY  
Serial No. : 520-00705  
Frequency : 5250 MHz  
Last Calib. Date : 16-Jun-2015  
Temperature : 20.00 °C  
Ambient Temp. : 21.00 °C  
Humidity : 50.00 RH%  
Epsilon : 48.10 F/m  
Sigma : 5.55 S/m  
Density : 1000.00 kg/cu. M

## Probe Data

Name : E-Field  
Model : E-020  
Type : E-Field Triangle  
Serial No. : 500-00283  
Last Calib. Date : 08-Oct-2013  
Frequency : 5250 MHz  
Duty Cycle Factor : 1  
Conversion Factor : 2.6  
Probe Sensitivity : 1.20 1.20 1.20  $\mu\text{V}/(\text{V}/\text{m})^2$   
Compression Point : 95.00 mV  
Offset : 1.56 mm

## Measurement Data

Crest Factor : 1  
Scan Type : Complete  
Tissue Temp. : 20.00 °C  
Ambient Temp. : 20.00 °C  
Area Scan : 7x7x1 : Measurement x=10mm, y=10mm, z=4mm  
Zoom Scan : 7x7x7 : Measurement x=5mm, y=5mm, z=5mm

1 gram SAR value : 16.092 W/kg  
10 gram SAR value : 6.727 W/kg  
Area Scan Peak SAR : 17.253 W/kg  
Zoom Scan Peak SAR : 42.157 W/kg

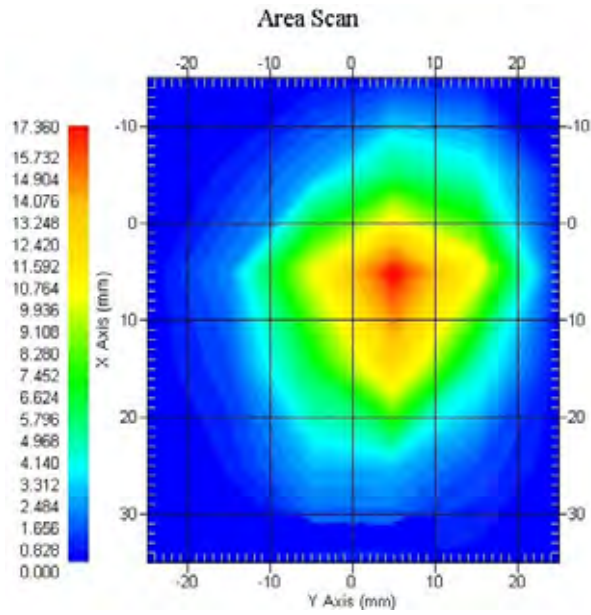

**5250 MHz System Validation**

**Test Laboratory: Bay Area Compliance Lab Corp. (Shenzhen)****System Performance Check 5600 MHz Body Liquid****Dipole 5600 MHz; Type: ALS-D-5600-S-2; S/N: 234-00703**

## Product Data

Device Name : Dipole 5600MHz  
Serial No. : 234-00703  
Type : Dipole  
Model : ALS-D-5600-S-2  
Frequency : 5600 MHz  
Max. Transmit Pwr : 0.25 W  
Drift Time : 3 min(s)  
Power Drift-Start : 6.358 W/kg  
Power Drift-Finish : 6.388 W/kg  
Power Drift (%) : 0.569

## Phantom Data

Name : APREL-Uni  
Type : Uni-Phantom  
Size (mm) : 280 x 280 x 200  
Serial No. : System Default  
Location : Center  
Description : Default

## Tissue Data

Type : BODY  
Serial No. : 560-00308  
Frequency : 5600 MHz  
Last Calib. Date : 16-Jun-2015  
Temperature : 20.00 °C  
Ambient Temp. : 21.00 °C  
Humidity : 50.00 RH%  
Epsilon : 47.65 F/m  
Sigma : 5.78 S/m  
Density : 1000.00 kg/cu. M

## Probe Data

Name : E-Field  
Model : E-020  
Type : E-Field Triangle  
Serial No. : 500-00283  
Last Calib. Date : 08-Oct-2013  
Frequency : 5600 MHz  
Duty Cycle Factor : 1  
Conversion Factor : 2.2  
Probe Sensitivity : 1.20 1.20 1.20  $\mu\text{V}/(\text{V}/\text{m})^2$   
Compression Point : 95.00 mV  
Offset : 1.56 mm

## Measurement Data

Crest Factor : 1  
Scan Type : Complete  
Tissue Temp. : 20.00 °C  
Ambient Temp. : 20.00 °C  
Area Scan : 7x7x1 : Measurement x=10mm, y=10mm, z=4mm  
Zoom Scan : 7x7x7 : Measurement x=5mm, y=5mm, z=5mm



1 gram SAR value : 16.327 W/kg  
10 gram SAR value : 7.852 W/kg  
Area Scan Peak SAR : 16.555 W/kg  
Zoom Scan Peak SAR : 41.188 W/kg

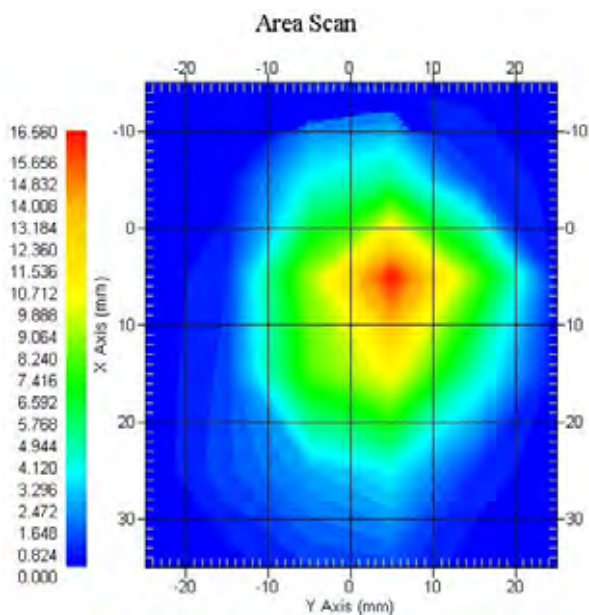

**5600 MHz System Validation**

**Test Laboratory: Bay Area Compliance Lab Corp. (Shenzhen)****System Performance Check 5800 MHz Body Liquid****Dipole 5800 MHz; Type: ALS-D-5800-S-2; S/N: 240-00855**

## Product Data

Device Name : Dipole 5800MHz  
Serial No. : 240-00855  
Type : Dipole  
Model : ALS-D-5800-S-2  
Frequency : 5800 MHz  
Max. Transmit Pwr : 0.25 W  
Drift Time : 3 min(s)  
Power Drift-Start : 4.659 W/kg  
Power Drift-Finish : 4.669 W/kg  
Power Drift (%) : 0.057

## Phantom Data

Name : APREL-Uni  
Type : Uni-Phantom  
Size (mm) : 280 x 280 x 200  
Serial No. : System Default  
Location : Center  
Description : Default

## Tissue Data

Type : BODY  
Serial No. : 580-00718  
Frequency : 5800 MHz  
Last Calib. Date : 16-Jun-2015  
Temperature : 20.00 °C  
Ambient Temp. : 21.00 °C  
Humidity : 50.00 RH%  
Epsilon : 47.43 F/m  
Sigma : 5.92 S/m  
Density : 1000.00 kg/cu. M

## Probe Data

Name : E-Field  
Model : E-020  
Type : E-Field Triangle  
Serial No. : 500-00283  
Last Calib. Date : 08-Oct-2013  
Frequency : 5800 MHz  
Duty Cycle Factor : 1  
Conversion Factor : 2.5  
Probe Sensitivity : 1.20 1.20 1.20  $\mu\text{V}/(\text{V}/\text{m})^2$   
Compression Point : 95.00 mV  
Offset : 1.56 mm

## Measurement Data

Crest Factor : 1  
Scan Type : Complete  
Tissue Temp. : 20.00 °C  
Ambient Temp. : 20.00 °C  
Area Scan : 7x7x1 : Measurement x=10mm, y=10mm, z=4mm  
Zoom Scan : 7x7x7 : Measurement x=5mm, y=5mm, z=5mm

1 gram SAR value : 16.120 W/kg  
10 gram SAR value : 08.072 W/kg  
Area Scan Peak SAR : 17.301 W/kg  
Zoom Scan Peak SAR : 37.567 W/kg

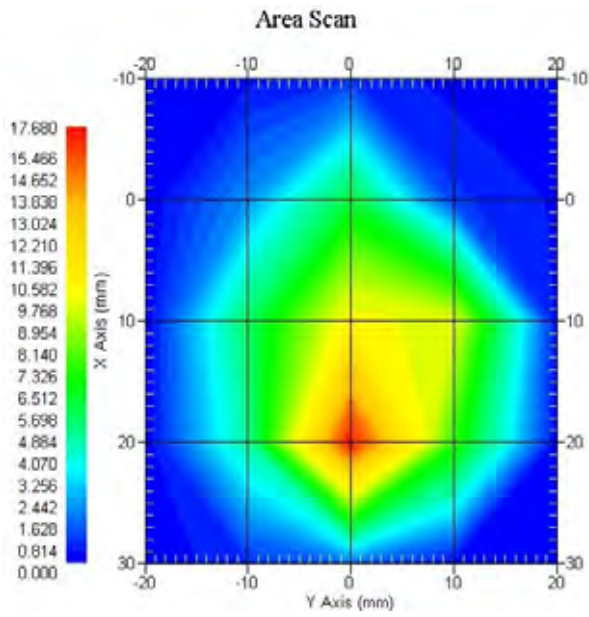

**5800 MHz System Validation**

## EUT TEST STRATEGY AND METHODOLOGY

### Test Positions for Device Operating Next to a Person’s Ear

This category includes most wireless handsets with fixed, retractable or internal antennas located toward the top half of the device, with or without a foldout, sliding or similar keypad cover. The handset should have its earpiece located within the upper ¼ of the device, either along the centerline or off-centered, as perceived by its users. This type of handset should be positioned in a normal operating position with the “test device reference point” located along the “vertical centerline” on the front of the device aligned to the “ear reference point”. The “test device reference point” should be located at the same level as the center of the earpiece region. The “vertical centerline” should bisect the front surface of the handset at its top and bottom edges. A “ear reference point” is located on the outer surface of the head phantom on each ear spacer. It is located 1.5 cm above the center of the ear canal entrance in the “phantom reference plane” defined by the three lines joining the center of each “ear reference point” (left and right) and the tip of the mouth.

A handset should be initially positioned with the earpiece region pressed against the ear spacer of a head phantom. For the SCC-34/SC-2 head phantom, the device should be positioned parallel to the “N-F” line defined along the base of the ear spacer that contains the “ear reference point”. For interim head phantoms, the device should be positioned parallel to the cheek for maximum RF energy coupling. The “test device reference point” is aligned to the “ear reference point” on the head phantom and the “vertical centerline” is aligned to the “phantom reference plane”. This is called the “initial ear position”. While maintaining these three alignments, the body of the handset is gradually adjusted to each of the following positions for evaluating SAR:

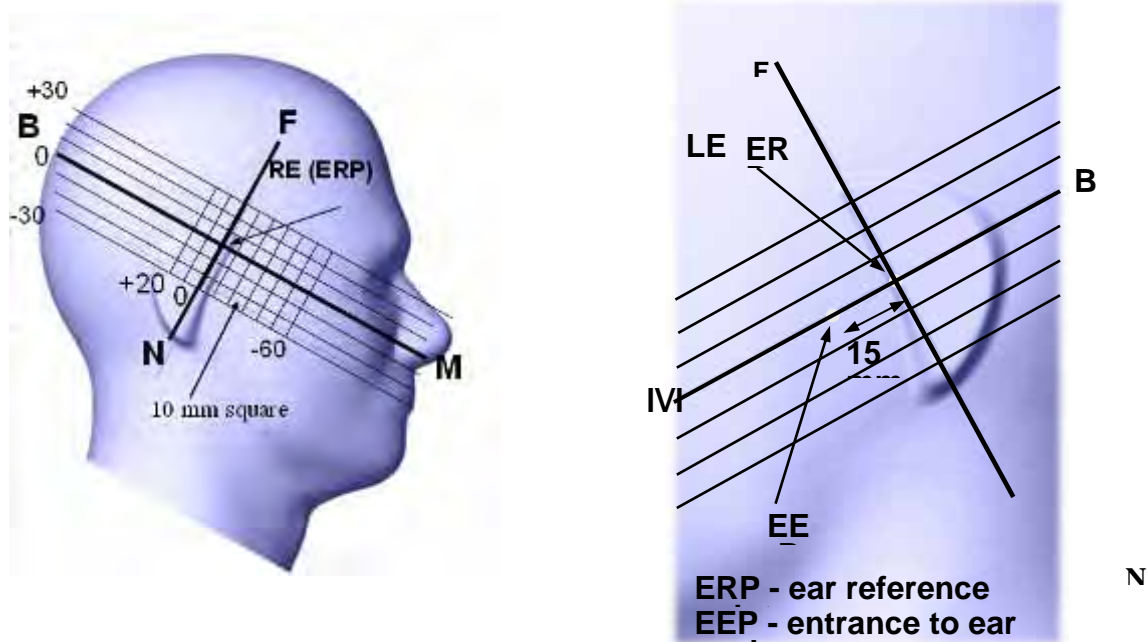

## Cheek/Touch Position

The device is brought toward the mouth of the head phantom by pivoting against the “ear reference point” or along the “N-F” line for the SCC-34/SC-2 head phantom.

This test position is established:

- When any point on the display, keypad or mouthpiece portions of the handset is in contact with the phantom.
- (or) When any portion of a foldout, sliding or similar keypad cover opened to its intended self-adjusting normal use position is in contact with the cheek or mouth of the phantom.

For existing head phantoms – when the handset loses contact with the phantom at the pivoting point, rotation should continue until the device touches the cheek of the phantom or breaks its last contact from the ear spacer.

### Cheek /Touch Position

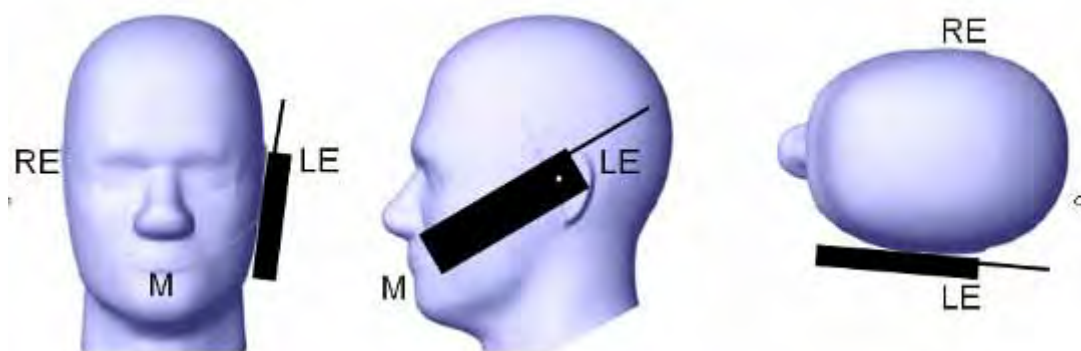

## Ear/Tilt Position

With the handset aligned in the “Cheek/Touch Position”:

1) If the earpiece of the handset is not in full contact with the phantom’s ear spacer (in the “Cheek/Touch position”) and the peak SAR location for the “Cheek/Touch” position is located at the ear spacer region or corresponds to the earpiece region of the handset, the device should be returned to the “initial ear position” by rotating it away from the mouth until the earpiece is in full contact with the ear spacer.

2) (otherwise) The handset should be moved (translated) away from the cheek perpendicular to the line passes through both “ear reference points” (note: one of these ear reference points may not physically exist on a split head model) for approximate 2-3 cm. While it is in this position, the device handset is tilted away from the mouth with respect to the “test device reference point” until the inside angle between the vertical centerline on the front surface of the phone and the horizontal line passing through the ear reference point is by 15 80°. After the tilt, it is then moved (translated) back toward the head perpendicular to the line passes through both “ear reference points” until the device touches the phantom or the ear spacer. If the antenna touches the head first, the positioning process should be repeated with a tilt angle less than 15° so that the device and its antenna would touch the phantom simultaneously. This test position may require a device holder or positioner to achieve the translation and tilting with acceptable positioning repeatability.

If a device is also designed to transmit with its keypad cover closed for operating in the head position, such positions should also be considered in the SAR evaluation. The device should be tested on the left and right side of the head phantom in the “Cheek/Touch” and “Ear/Tilt” positions. When applicable, each configuration should be tested with the antenna in its fully extended and fully retracted positions. These test configurations should be tested at the high, middle and low frequency channels of each operating mode; for example, AMPS, CDMA, and TDMA. If the SAR measured at the middle channel for each test configuration (left, right, Cheek/Touch, Tilt/Ear, extended and retracted) is at least 2.0 dB lower than the SAR limit, testing at the high and low channels is optional for such test configuration(s). If the transmission band of the test device is less than 10 MHz, testing at the high and low frequency channels is optional.

**Ear /Tilt 15° Position**

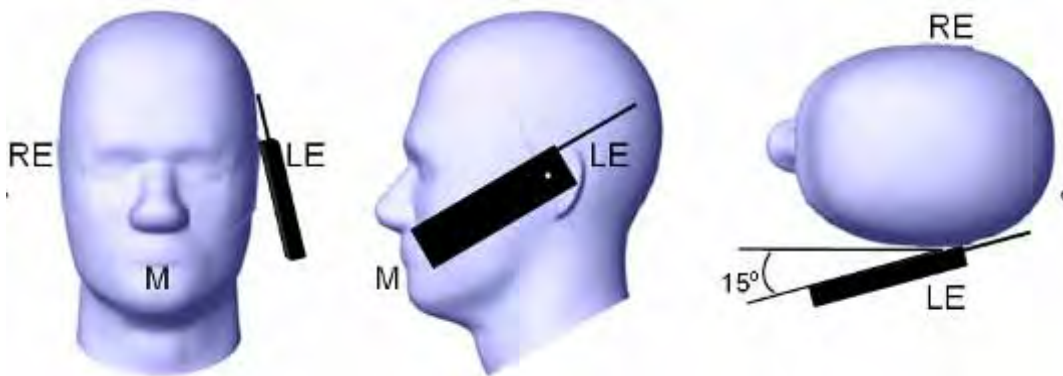

**Test positions for body-worn and other configurations**

Body-worn operating configurations should be tested with the belt-clips and holsters attached to the device and positioned against a flat phantom in normal use configurations. Devices with a headset output should be tested with a headset connected to the device. When multiple accessories that do not contain metallic components are supplied with the device, the device may be tested with only the accessory that dictates the closest spacing to the body. When multiple accessories that contain metallic components are supplied with the device, the device must be tested with each accessory that contains a unique metallic component. If multiple accessories share an identical metallic component (e.g., the same metallic belt-clip used with different holsters with no other metallic components), only the accessory that dictates the closest spacing to the body must be tested.

Body-worn accessories may not always be supplied or available as options for some devices that are intended to be authorized for body-worn use. A separation distance of 1.5 cm between the back of the device and a flat phantom is recommended for testing body-worn SAR compliance under such circumstances. Other separation distances may be used, but they should not exceed 2.5 cm. In these cases, the device may use body-worn accessories that provide a separation distance greater than that tested for the device provided however that the accessory contains no metallic components.

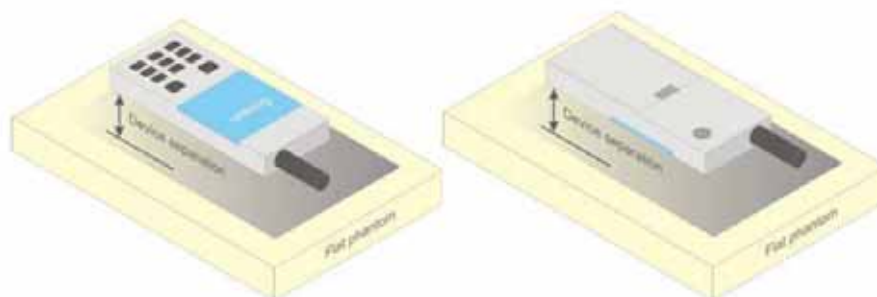

**Figure 5 – Test positions for body-worn devices**

## SAR Evaluation Procedure

The evaluation was performed with the following procedure:

Step 1: Measurement of the SAR value at a fixed location above the ear point or central position was used as a reference value for assessing the power drop. The SAR at this point is measured at the start of the test and then again at the end of the testing.

Step 2: The SAR distribution at the exposed side of the head was measured at a distance of 4 mm from the inner surface of the shell. The area covered the entire dimension of the head or EUT and the horizontal grid spacing was 10 mm x 10 mm. Based on these data, the area of the maximum absorption was determined by spline interpolation. The first Area Scan covers the entire dimension of the EUT to ensure that the hotspot was correctly identified.

Step 3: Around this point, a volume of 35 mm x 35 mm x 35 mm was assessed by measuring 7x 7 x 7 points. On the basis of this data set, the spatial peak SAR value was evaluated under the following procedure:

- 1) The data at the surface were extrapolated, since the center of the dipoles is 1.2 mm away from the tip of the probe and the distance between the surface and the lowest measuring point is 1.3 mm. The extrapolation was based on a least square algorithm. A polynomial of the fourth order was calculated through the points in z-axes. This polynomial was then used to evaluate the points between the surface and the probe tip.
- 2) The maximum interpolated value was searched with a straightforward algorithm. Around this maximum the SAR values averaged over the spatial volumes (1 g or 10 g) were computed by the 3D-Spline interpolation algorithm. The 3D-Spline is composed of three one dimensional splines with the "Not a knot"-condition (in x, y and z-directions). The volume was integrated with the trapezoidal-algorithm. One thousand points (10 x 10 x 10) were interpolated to calculate the averages.

All neighboring volumes were evaluated until no neighboring volume with a higher average value was found.

Step 4: Re-measurement of the SAR value at the same location as in Step 1. If the value changed by more than 5%, the evaluation was repeated.

## Test methodology

KDB 447498 D01 General RF Exposure Guidance v05r02.  
KDB 865664 D01 SAR measurement 100 MHz to 6 GHz v01r03  
KDB 865664 D02 RF Exposure Reporting v01r01  
KDB 941225 D01 3G SAR Procedures v03  
KDB 941225 D05 SAR for LTE Devices v02r03  
KDB 941225 D06 Hotspot Mode v02  
KDB 248227 D01-SAR Measurement Procedures for 802.11a/b/g Transmitters



## CONDUCTED OUTPUT POWER MEASUREMENT

---

### Provision Applicable

The measured peak output power should be greater and within 5% than EMI measurement.

### Test Procedure

The RF output of the transmitter was connected to the input of the EMI Test Receiver through sufficient attenuation.

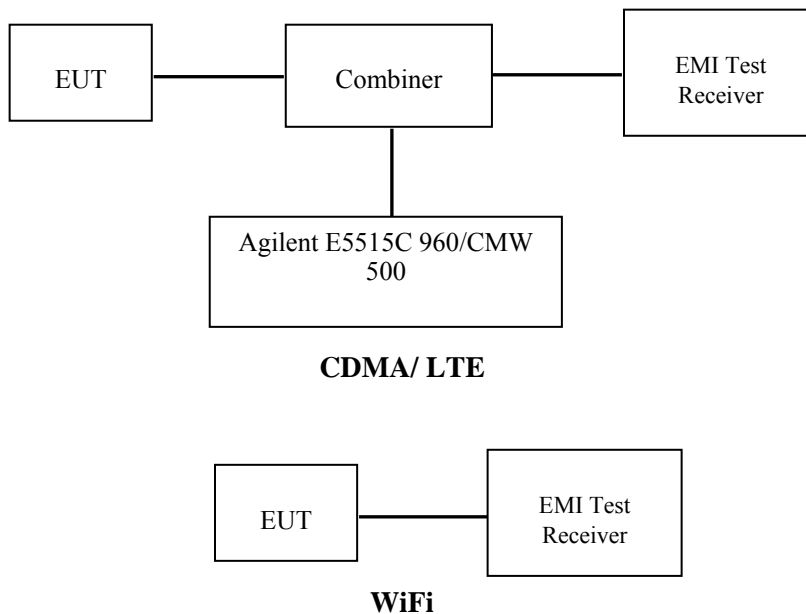



**Maximum Output Power among production units**

<b>Max Target Power for Production Unit (dBm)</b>			
<b>Mode/Band</b>	<b>Channel</b>		
	<b>Low</b>	<b>Middle</b>	<b>High</b>
LTE Band 13	22.5	22.5	22.5
LTE Band 13 P-Sensor Triggered	17.7	17.7	17.7
WLAN 5.2G Band SISO Chain 0(Main)	11.70	11.70	11.70
WLAN 5.2G Band SISO Chain 1(Aux)	12.70	12.70	12.70
WLAN 5.2G Band MIMO	13.60	13.60	13.60
WLAN 5.3G Band SISO Chain 0(Main)	13.20	13.20	13.20
WLAN 5.3G Band SISO Chain 1(Aux)	13.40	13.40	13.40
WLAN 5.3G Band MIMO	13.50	13.50	13.50
WLAN 5.6G Band SISO Chain 0(Main)	11.40	11.40	11.40
WLAN 5.6G Band SISO Chain 1(Aux)	11.30	11.30	11.30
WLAN 5.6G Band MIMO	13.70	13.70	13.70
WLAN 5.8G Band SISO Chain 0(Main)	13.90	13.90	13.90
WLAN 5.8G Band SISO Chain 1(Aux)	13.40	13.40	13.40
WLAN 5.8G Band MIMO	14.60	14.60	14.60

Note: the device employed a proximity sensor for WWAN, according to KDB 616217 D04, the proximity sensor triggering is 21mm for EUT both back and top side, the separation distance determined by the smallest triggering distance on top and back side is used to access the tilt angle influence and the sensor does not release during +/- 45 degree.

**Test Results:**

**Proximity Sensor Operation**

A Proximity sensor for power reduction is implemented in this device to address RF exposure compliance when the WWAN antenna is positioned close to the user’s body. This design combines the antenna and proximity sensor into a single FPC (Flexible Printed Circuit). The sensor operation area is the back and top side of the device.

The minimum detection distances for Top side and back side determined as below:

**Proximity Sensor Status Table**

**Top edge**

<b>Distance (mm)</b>	15	16	17	18	19	20	21	22	23	24	25	26	27
<b>Toward</b>	on	on	on	on	on	on	on	off	off	off	off	off	off
<b>Away</b>	on	on	on	on	on	on	on	on	off	off	off	off	off

**Back edge**

<b>Distance (mm)</b>	15	16	17	18	19	20	21	22	23	24	25	26	27
<b>Toward</b>	on	on	on	on	on	on	on	off	off	off	off	off	off
<b>Away</b>	on	on	on	on	on	on	on	on	off	off	off	off	off

Note: each side minimum detection distance was performed with below:

Toward: moving toward the phantom

Away: Moving away from the phantom

**Power Reduction Values**

The power reduction values in each edge are the same as below power table at the separation distance P-sensor triggering on, please refer to the below test results.

Base on the minimum separation triggering distance is 21mm for both back and top edge, a additional SAR measurements were required at 20cm for back and top edge.

**LTE**

The following tests were conducted according to the test requirements outlined in section 6.2 of the 3GPP TS36.101 specification.

UE Power Class; 3 (23 +/- 2dBm). The allowed Maximum Power Reduction (MPR) for the maximum output power due to higher order modulation and transmit bandwidth configuration (resource blocks) is specified in Table 6.2.3-1 of the 3GPP TS36.101.

**Table 6.2.3-1: Maximum Power Reduction (MPR) for Power Class 3**

Modulation	Channel bandwidth / Transmission bandwidth (RB)						MPR (dB)
	1.4 MHz	3.0 MHz	5 MHz	10 MHz	15 MHz	20 MHz	
QPSK	> 5	> 4	> 8	> 12	> 16	> 18	≤ 1
16 QAM	≤ 5	≤ 4	≤ 8	≤ 12	≤ 16	≤ 18	≤ 1
16 QAM	> 5	> 4	> 8	> 12	> 16	> 18	≤ 2

The allowed A-MPR values specified below in Table 6.2.4.-1 of 3GPP TS36.101 are in addition to the allowed MPR requirements. All the measurements below were performed with A-MPR disabled, by using Network Signaling Value of "NS\_01".

**Table 6.2.4-1: Additional Maximum Power Reduction (A-MPR)**

Network Signalling value	Requirements (sub-clause)	E-UTRA Band	Channel bandwidth (MHz)	Resources Blocks (N <sub>RB</sub> )	A-MPR (dB)
NS_01	6.6.2.1.1	Table 5.5-1	1.4, 3, 5, 10, 15, 20	Table 5.6-1	NA
NS_03	6.6.2.2.1	2, 4, 10, 23, 25, 35, 36	3	>5	≤ 1
			5	>6	≤ 1
			10	>6	≤ 1
			15	>8	≤ 1
			20	>10	≤ 1
NS_04	6.6.2.2.2	41	5	>6	≤ 1
			10, 15, 20	See Table 6.2.4-4	
NS_05	6.6.3.3.1	1	10,15,20	≥ 50	≤ 1
NS_06	6.6.2.2.3	12, 13, 14, 17	1.4, 3, 5, 10	Table 5.6-1	n/a
NS_07	6.6.2.2.3	13	10	Table 6.2.4-2	Table 6.2.4-2
	6.6.3.3.2				
NS_08	6.6.3.3.3	19	10, 15	> 44	≤ 3
NS_09	6.6.3.3.4	21	10, 15	> 40	≤ 1
				> 55	≤ 2
NS_10		20	15, 20	Table 6.2.4-3	Table 6.2.4-3
NS_11	6.6.2.2.1	23 <sup>1</sup>	1.4, 3, 5, 10	Table 6.2.4-5	Table 6.2.4-5
NS_32	--	--	--	--	--

Note 1: Applies to the lower block of Band 23, i.e. a carrier placed in the 2000-2010 MHz region

**LTE Band 13 EUT without Power Reduction (P-Sensor NOT Triggered):**

Test Bandwidth	Test Modulation	Resource Block & RB offset	Low Channel (dBm)	Middle Channel (dBm)	High Channel (dBm)
5M	QPSK	1#0	22.13	22.44	22.42
		1#12	22.25	22.71	22.81
		1#24	22.33	22.52	22.43
		12#0	20.54	21.09	21.13
		12#6	21.37	21.52	21.64
		12#11	21.29	21.43	21.39
		25#0	20.96	21.46	20.88
	16-QAM	1#0	21.70	21.88	21.87
		1#12	21.89	21.53	21.30
		1#24	21.34	21.49	21.42
		12#0	21.31	21.24	21.46
		12#6	21.41	21.38	21.37
		12#11	21.15	21.33	21.22
		25#0	21.12	21.26	21.28
10M	QPSK	1#0	\	22.05	\
		1#24	\	<b>22.48</b>	\
		1#49	\	22.17	\
		25#0	\	21.26	\
		25#12	\	21.32	\
		25#24	\	21.25	\
		50#0	\	21.23	\
	16-QAM	1#0	\	21.71	\
		1#24	\	21.11	\
		1#49	\	22.06	\
		25#0	\	21.33	\
		25#12	\	21.29	\
		25#24	\	21.28	\
		50#0	\	21.24	\

**LTE Band 13 EUT with Power Reduction (P-Sensor Triggered):**

Test Bandwidth	Test Modulation	Resource Block & RB offset	Low Channel (dBm)	Middle Channel (dBm)	High Channel (dBm)
5M	QPSK	1#0	17.29	17.63	17.61
		1#12	17.41	17.9	18
		1#24	17.49	17.7	17.6
		12#0	15.74	16.3	16.36
		12#6	16.54	16.71	16.86
		12#11	16.52	16.67	16.6
		25#0	16.2	16.64	16.09
	16-QAM	1#0	16.91	17.1	17.06
		1#12	17.06	16.77	16.46
		1#24	16.52	16.71	16.62
		12#0	16.5	16.46	16.71
		12#6	16.6	16.59	16.58
		12#11	16.36	16.51	16.44
		25#0	16.32	16.43	16.49
10M	QPSK	1#0	\	17.2	\
		1#24	\	<b>17.67</b>	\
		1#49	\	17.35	\
		25#0	\	16.43	\
		25#12	\	16.51	\
		25#24	\	16.47	\
		50#0	\	16.47	\
	16-QAM	1#0	\	16.92	\
		1#24	\	16.34	\
		1#49	\	17.31	\
		25#0	\	16.56	\
		25#12	\	16.47	\
		25#24	\	16.45	\
		50#0	\	16.43	\

Note:

- 1.SAR for LTE band exposure configurations is measured according to the procedures of KDB 941225 D05 SAR for LTE Devices v02.
- 2.The CMW500 Wideband Radio Communication tester is used for LTE output power measurements and SAR testing. Closed loop power control is used to keep the radio transmitters the max output power during the test.
- 3.KDB941225D05v02- SAR for higher order modulation is required only when the highest maximum output power for the configuration in the higher order modulation is > ½ dB higher than the same configuration in QPSK or when the reported SAR for the QPSK configuration is > 1.45 W/kg

**WLAN 5G, SISO Mode:**

UNII Band	Mode	Channel	Frequency(MHz)	RMS Channel Power(dBm)(Single)	
				Chain 0	Chain 1
5150-5250MHz	802.11 a	Low	5180	9.87	11.12
		Middle	5200	10.99	12.46
		High	5240	11.63	12.67
	5G 802.11 n20	Low	5180	9.71	11.01
		Middle	5200	10.74	12.33
		High	5240	11.38	12.17
	5G 802.11 n40	Low	5190	7.42	10.53
		High	5230	11.56	12.52
	802.11 ac80	Middle	5210	10.02	10.5
5250-5350MHz	802.11 a	Low	5260	12.86	13.35
		Middle	5280	13.19	13.06
		High	5320	11.26	10.35
	5G 802.11 n20	Low	5260	12.25	13.21
		Middle	5280	12.66	13.02
		High	5320	10.87	10.22
	5G 802.11 n40	Low	5270	12.46	12.87
		High	5310	10.73	10.59
	802.11 ac80	Middle	5290	10.9	10.38
5470-5725MHz	802.11 a	Low	5500	10.37	8.75
		Middle	5580	11.35	11.22
		High	5700	11	11.07
	5G 802.11 n20	Low	5500	10.22	8.57
		Middle	5580	11.24	11.01
		High	5700	10.96	10.76
	5G 802.11 n40	Low	5510	10.05	8.65
		Middle	5550	11.24	10.67
		High	5670	11.14	11.15
802.11 ac80	Low	5530	9.75	8.79	
Cross Band	802.11ac20	High	5720	10.62	10.26
	802.11ac40	High	5710	10.45	10.26
	802.11ac80	High	5690	9.74	9.45
5725-5850MHz	802.11 a	Low	5745	13.85	13.4
		Middle	5785	13.43	13.01
		High	5825	13.37	12.75
	5G 802.11 n20	Low	5745	13.45	12.75
		Middle	5785	13.41	12.93
		High	5825	13.28	12.6
	5G 802.11 n40	Low	5755	13.80	13.26
		High	5795	13.81	13.07
	802.11 ac80	Middle	5775	13.72	13.37

**WLAN 5G, MIMO Mode:**

UNII Band	Mode	Channel	Frequency(MHz)	RMS Channel Power(dBm)(Mimo)		
				Chain	Chain	Total
5150-5250MHz	802.11 a	Low	5180	7.24	7.98	10.64
		Middle	5200	6.8	8.59	10.8
		High	5240	7.39	9.37	11.5
	5G 802.11 n20	Low	5180	6.87	7.61	10.27
		Middle	5200	7.13	8.12	10.66
		High	5240	8.02	9.35	11.75
	5G 802.11 n40	Low	5190	6.48	6.44	9.47
		High	5230	9.73	11.17	13.52
	802.11 ac80	Middle	5210	5.91	8.15	10.18
5250-5350MHz	802.11 a	Low	5260	9.28	10.42	12.9
		Middle	5280	9.62	10.4	13.04
		High	5320	8.21	8.39	11.31
	5G 802.11 n20	Low	5260	10.07	10.85	13.49
		Middle	5280	10.49	10.4	13.46
		High	5320	8.95	8.7	11.84
	5G 802.11 n40	Low	5270	6.42	10.73	12.1
		High	5310	6.1	8.62	10.55
	802.11 ac80	Middle	5290	7.99	9.69	11.93
5470-5725MHz	802.11 a	Low	5500	6.99	5.35	9.26
		Middle	5580	8.62	8.51	11.58
		High	5700	8.3	8.87	11.6
	5G 802.11 n20	Low	5500	6.96	4.75	9
		Middle	5580	8.72	8.47	11.61
		High	5700	8.5	8.58	11.55
	5G 802.11 n40	Low	5510	7.58	5.47	9.66
		Middle	5550	9.12	7.78	11.51
		High	5670	9.99	11.14	13.61
802.11 ac80	Low	5530	6.7	6.31	9.52	
Cross Band	802.11ac20	High	5720	9.24	9.14	12.20
	802.11ac40	High	5710	8.98	8.74	11.87
	802.11ac80	High	5690	6.87	6.87	9.88
5725-5850MHz	802.11 a	Low	5745	11.36	11.31	14.35
		Middle	5785	11.44	11.72	14.59
		High	5825	11.05	11.56	14.32
	5G 802.11 n20	Low	5745	11.44	11.52	14.49
		Middle	5785	11.21	11.38	14.31
		High	5825	10.68	11.11	13.91
	5G 802.11 n40	Low	5755	9.99	11.36	13.74
		High	5795	9.75	11.24	13.57
	802.11 ac80	Middle	5775	10.03	11.42	13.79

**Note:**

1. The output power was tested under data rate 1Mbps for 802.11b, 6Mbps for 802.11g, 6.5Mbps for 802.11n HT20, 13.5Mbps for 802.11n HT40.
2. KDB 248227- SAR is not required for 802.11g/n channels when the maximum average output power is less than  $\frac{1}{4}$  dB higher than that measured on the corresponding 802.11b/a channels.



## SAR MEASUREMENT RESULTS

This page summarizes the results of the performed dosimetric evaluation.

### SAR Test Data

#### Environmental Conditions

<b>Temperature:</b>	21-24
<b>Relative Humidity:</b>	50-53 %
<b>ATM Pressure:</b>	1001-1002 mbar

Testing was performed by Terry XiaHou on 2015-06-16

### Mobile Hot-Spot Test Result

The DUT is capable of functioning as a Wi-Fi to Cellular Mobile hotspot. Additional SAR testing was performed according to KDB 941225 D06. Testing was performed with a separation of 0cm between the DUT and the flat phantom. The DUT was positioned for SAR tests with the front and back surfaces facing the phantom, and also with the edges facing the phantom in which the transmitting antenna is <2.5 cm from the edge. Each transmit band was utilized for SAR testing. The tested mode has been selected within each band that exhibits the highest time average output power.

#### LTE Band 13 EUT with Power Reduction (P-Sensor Triggered):

EUT Position	Frequency (MHz)	Test Mode	Power Drift (%)	Max. Meas. Power (dBm)	Max. Rated Power (dBm)	1g SAR (W/Kg)			
						Scaled Factor	Meas. SAR	Scaled SAR	Plot
Body-Back (0mm)	782	1RB,offset=24	-1.622	17.67	17.70	1.007	0.359	0.361	/
	782	25% RB,offset=12	1.616	17.67	17.70	1.007	0.362	0.365	/
Body-Left (0mm)	782	1RB,offset=24	-1.645	17.67	17.70	1.007	0.307	0.309	/
	782	25% RB,offset=12	1.242	17.67	17.70	1.007	0.295	0.297	/
Body- Top (0mm)	782	1RB,offset=24	0.390	17.67	17.70	1.007	0.491	<b>0.494</b>	<b>1#</b>
	782	25% RB,offset=12	0.111	17.67	17.70	1.007	0.432	0.435	/

#### LTE Band 13 EUT without Power Reduction (P-Sensor NOT Triggered):

EUT Position	Frequency (MHz)	Test Mode	Power Drift (%)	Max. Meas. Power (dBm)	Max. Rated Power (dBm)	1g SAR (W/Kg)			
						Scaled Factor	Meas. SAR	Scaled SAR	Plot
Body-Back (20mm)	782	1RB,offset=24	-4.965	22.48	22.50	1.005	0.259	0.260	/
	782	25% RB,offset=12	-4.031	22.48	22.50	1.005	0.216	0.217	/
Body- Top (20mm)	782	1RB,offset=24	-3.107	22.48	22.50	1.005	0.397	0.399	/
	782	25% RB,offset=12	-1.007	22.48	22.50	1.005	0.362	0.364	/

#### Note:

1. When the 1-g SAR is  $\leq 0.8$ W/Kg, testing for other channels are optional.
2. SAR for LTE band exposure configurations is measured according to the procedures of KDB 941225 D05 SAR for LTE Devices v02.
3. KDB941225D05- SAR for higher order modulation is required only when the highest maximum output power for the configuration in the higher order modulation is  $> \frac{1}{2}$  dB higher than the same configuration in QPSK or when the reported SAR for the QPSK configuration is  $> 1.45$  W/kg

4. KDB941225D05- For QPSK with 100% RB allocation, when the reported SAR measured for the Highest output power channel is <1.45 W/kg, tests for the remaining required test channels are optional.
5. KDB941225D05- For QPSK with 100% RB allocation, SAR is not required when the highest maximum output power for 100 % RB allocation is less than the highest maximum output power in 50% and 1 RB allocations and the highest reported SAR for 1 RB and 50% RB allocation are 0.8 W/kg.
6. KDB941225D05- Start with the largest channel bandwidth and measure SAR for QPSK with 1 RB allocation, using the RB offset and required test channel combination with the highest maximum output power among RB offset the upper edge, middle and lower edge of each required test channel.
7. Worst case SAR for 50% RB allocation is selected to be tested.

**Wi-Fi 802.11a (5150-5250MHz)**

EUT Position	Frequency (MHz)		Power Drift (%)	Meas. Avg. Power (dBm)	Max. Rated Avg. Power (dBm)	1 g SAR Value (W/Kg)			
	Channel	MHz				Scaled Factor	Meas. SAR	Scaled SAR	Plot
Body-worn-Left (0mm) Main Antenna	36	5180	/	/	/	/	/	/	/
	44	5220	/	/	/	/	/	/	/
	48	5240	0.413	11.63	11.70	1.016	0.279	<b>0.284</b>	<b>2#</b>
Body-worn-Back (0mm) Main Antenna	36	5180	/	/	/	/	/	/	/
	44	5220	/	/	/	/	/	/	/
	48	5240	-4.606	11.63	11.70	1.016	0.189	0.192	/
Body-worn-Top (0mm) Main Antenna	36	5180	/	/	/	/	/	/	/
	44	5220	/	/	/	/	/	/	/
	48	5240	2.630	11.63	11.70	1.016	0.205	0.208	/
Body-worn-Left (0mm) AUX Antenna	36	5180	/	/	/	/	/	/	/
	44	5220	/	/	/	/	/	/	/
	48	5240	4.162	12.67	12.70	1.007	0.253	0.255	/
Body-worn-Back (0mm) AUX Antenna	36	5180	/	/	/	/	/	/	/
	44	5220	/	/	/	/	/	/	/
	48	5240	2.622	12.67	12.70	1.007	0.167	0.168	/
Body-worn-Bottom (0mm) AUX Antenna	36	5180	/	/	/	/	/	/	/
	44	5220	/	/	/	/	/	/	/
	48	5240	-3.333	12.67	12.70	1.007	0.227	0.229	/

**Wi-Fi 802.11a (5250-5350MHz)**

EUT Position	Frequency (MHz)		Power Drift (%)	Meas. Avg. Power (dBm)	Max. Rated Avg. Power (dBm)	1 g SAR Value (W/Kg)			
	Channel	MHz				Scaled Factor	Meas. SAR	Scaled SAR	Plot
Body-worn-Left (0mm) Main Antenna	52	5260	/	/	/	/	/	/	/
	60	5300	0.463	13.19	13.20	1.002	0.209	<b>0.209</b>	<b>3#</b>
	64	5320	/	/	/	/	/	/	/
Body-worn-Back (0mm) Main Antenna	52	5260	/	/	/	/	/	/	/
	60	5300	0.429	13.19	13.20	1.002	0.155	0.155	/
	64	5320	/	/	/	/	/	/	/
Body-worn-Top (0mm) Main Antenna	52	5260	/	/	/	/	/	/	/
	60	5300	0.653	13.19	13.20	1.002	0.173	0.173	/
	64	5320	/	/	/	/	/	/	/
Body-worn-Left (0mm) AUX Antenna	52	5260	3.732	13.35	13.40	1.012	0.177	0.179	/
	60	5300	/	/	/	/	/	/	/
	64	5320	/	/	/	/	/	/	/
Body-worn-Back (0mm) AUX Antenna	52	5260	4.085	13.35	13.40	1.012	0.135	0.137	/
	60	5300	/	/	/	/	/	/	/
	64	5320	/	/	/	/	/	/	/
Body-worn-Bottom (0mm) AUX Antenna	52	5260	4.037	13.35	13.40	1.012	0.159	0.161	/
	60	5300	/	/	/	/	/	/	/
	64	5320	/	/	/	/	/	/	/

**Wi-Fi 802.11a (5470-5725MHz)**

EUT Position	Frequency (MHz)		Power Drift (%)	Meas. Avg. Power (dBm)	Max. Rated Avg. Power (dBm)	1 g SAR Value (W/Kg)			
	Channel	MHz				Scaled Factor	Meas. SAR	Scaled SAR	Plot
Body-worn-Left (0mm) Main Antenna	100	5500	/	/	/	/	/	/	/
	112	5560	-1.562	11.35	11.40	1.012	0.407	<b>0.412</b>	<b>4#</b>
	124	5620	/	/	/	/	/	/	/
Body-worn-Back (0mm) Main Antenna	100	5500	/	/	/	/	/	/	/
	112	5560	0.832	11.35	11.40	1.012	0.332	0.336	/
	124	5620	/	/	/	/	/	/	/
Body-worn-Top (0mm) Main Antenna	100	5500	/	/	/	/	/	/	/
	112	5560	2.087	11.35	11.40	1.012	0.24	0.243	/
	124	5620	/	/	/	/	/	/	/
Body-worn-Left (0mm) AUX Antenna	100	5500	/	/	/	/	/	/	/
	112	5560	3.021	11.22	11.30	1.019	0.372	0.379	/
	124	5620	/	/	/	/	/	/	/
Body-worn-Back (0mm) AUX Antenna	100	5500	/	/	/	/	/	/	/
	112	5560	-4.512	11.22	11.30	1.019	0.329	0.335	/
	124	5620	/	/	/	/	/	/	/
Body-worn-Bottom (0mm) AUX Antenna	100	5500	/	/	/	/	/	/	/
	112	5560	2.418	11.22	11.30	1.019	0.287	0.292	/
	124	5620	/	/	/	/	/	/	/

**Wi-Fi 802.11a (5725-5850MHz)**

EUT Position	Frequency (MHz)		Power Drift (%)	Meas. Avg. Power (dBm)	Max. Rated Avg. Power (dBm)	1 g SAR Value (W/Kg)			
	Channel	MHz				Scaled Factor	Meas. SAR	Scaled SAR	Plot
Body-worn-Left (0mm) Main Antenna	149	5745	0.851	13.85	13.90	1.012	0.352	<b>0.356</b>	<b>5#</b>
	157	5785	/	/	/	/	/	/	/
	161	5805	/	/	/	/	/	/	/
Body-worn-Back (0mm) Main Antenna	149	5745	-1.043	13.85	13.90	1.012	0.205	0.207	/
	157	5785	/	/	/	/	/	/	/
	161	5805	/	/	/	/	/	/	/
Body-worn-Top (0mm) Main Antenna	149	5745	1.514	13.85	13.90	1.012	0.192	0.194	/
	157	5785	/	/	/	/	/	/	/
	161	5805	/	/	/	/	/	/	/
Body-worn-Left (0mm) AUX Antenna	149	5745	-3.901	13.40	13.40	1.000	0.332	0.332	/
	157	5785	/	/	/	/	/	/	/
	161	5805	/	/	/	/	/	/	/
Body-worn-Back (0mm) AUX Antenna	149	5745	4.658	13.40	13.40	1.000	0.257	0.257	/
	157	5785	/	/	/	/	/	/	/
	161	5805	/	/	/	/	/	/	/
Body-worn-Bottom (0mm) AUX Antenna	149	5745	0.239	13.40	13.40	1.000	0.237	0.237	/
	157	5785	/	/	/	/	/	/	/
	161	5805	/	/	/	/	/	/	/

**Note:**

1. When the 1-g SAR is  $\leq 0.8\text{W/Kg}$ , testing for other channel is optional.
2. When SAR or MPE is not measured at the maximum power level allowed for production units, the results must be scaled to the maximum tune-up tolerance limit according to the power applied to the individual channels tested to determine compliance.
3. The SISO mode is selected to be tested since it was unrealizable for the Chain 0# and Chain 1# transmitting simultaneously at the SAR testing.
4. KDB 248227- SAR is not required for 802.11g/n channels when the maximum average output power is less than  $\frac{1}{4}$  dB higher than that measured on the corresponding 802.11b/a channels.

**SAR Plots (Summary of the Highest SAR Values)**

**Test Laboratory: Bay Area Compliance Lab Corp. (Shenzhen)**

**LTE FDD Band13; Body-Worn-Top (782 MHz Middle Channel);**

Measurement Data

Test mode : 1RB  
 Crest Factor : 1  
 Scan Type : Complete  
 Area Scan : 8x11x1 : Measurement x=10mm, y=10mm, z=4mm  
 Zoom Scan : 7x7x7 : Measurement x=5mm, y=5mm, z=5mm  
 Power Drift-Start : 0.513 W/kg  
 Power Drift-Finish : 0.515 W/kg  
 Power Drift (%) : 0.390

Tissue Data

Type : Body  
 Frequency : 782 MHz  
 Epsilon : 54.66 F/m  
 Sigma : 0.98 S/m  
 Density : 1000.00 kg/cu. m

Probe Data

Serial No. : 500-00283  
 Frequency Band : 750  
 Duty Cycle Factor : 1  
 Conversion Factor : 5.5  
 Probe Sensitivity : 1.20 1.20 1.20  $\mu\text{V}/(\text{V}/\text{m})^2$   
 Compression Point : 95.00 mV  
 Offset : 1.56 mm

1 gram SAR value : 0.491 W/kg  
 10 gram SAR value : 0.325 W/kg  
 Area Scan Peak SAR : 0.532 W/kg  
 Zoom Scan Peak SAR : 0.634 W/kg

**Plot 1#**

**Area Scan**

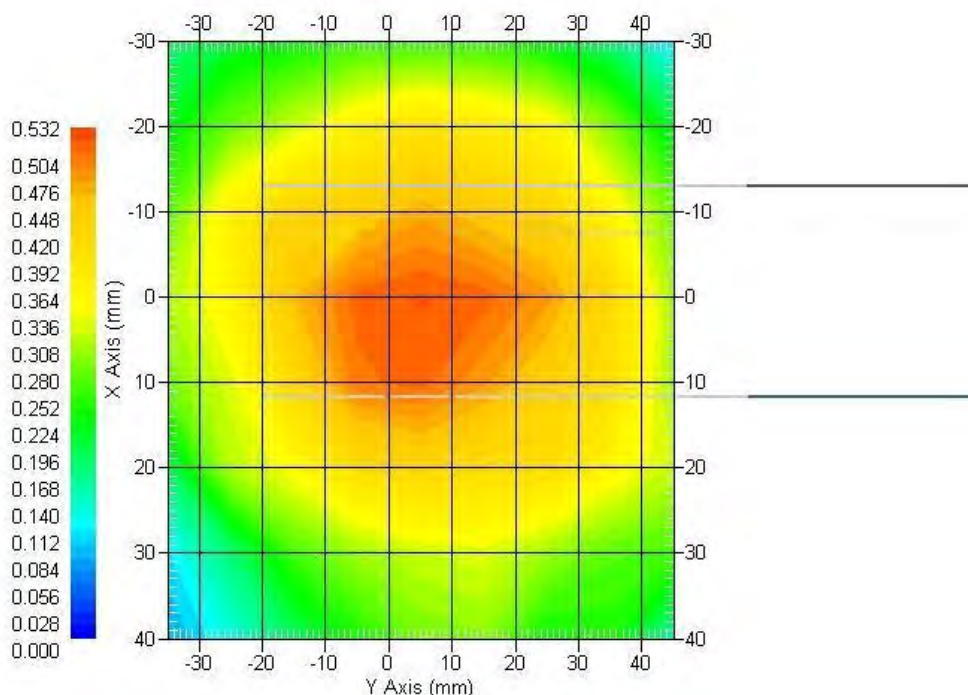

**Test Laboratory: Bay Area Compliance Lab Corp. (Shenzhen)**

**802.11a; Body-worn-Left; Main Antenna (5240 MHz Channel 48)**

Measurement Data

Crest Factor : 1  
 Scan Type : Complete  
 Area Scan : 8x11x1 : Measurement x=10mm, y=10mm, z=4mm  
 Zoom Scan : 7x7x7 : Measurement x=5mm, y=5mm, z=5mm  
 Power Drift-Start : 0.242 W/kg  
 Power Drift-Finish : 0.243 W/kg  
 Power Drift (%) : 0.413

Tissue Data

Type : Body  
 Frequency : 5240 MHz  
 Epsilon : 48.07 F/m  
 Sigma : 5.51 S/m  
 Density : 1000.00 kg/cu. m

Probe Data

Serial No. : 500-00283  
 Frequency Band : 5250 MHz  
 Duty Cycle Factor : 1  
 Conversion Factor : 2.6  
 Probe Sensitivity : 1.20 1.20 1.20  $\mu\text{V}/(\text{V}/\text{m})^2$   
 Compression Point : 95.00 mV  
 Offset : 1.56 mm

1 gram SAR value : 0.279 W/kg  
 10 gram SAR value : 0.175 W/kg  
 Area Scan Peak SAR : 0.285 W/kg  
 Zoom Scan Peak SAR : 0.357 W/kg

**Plot 2#**

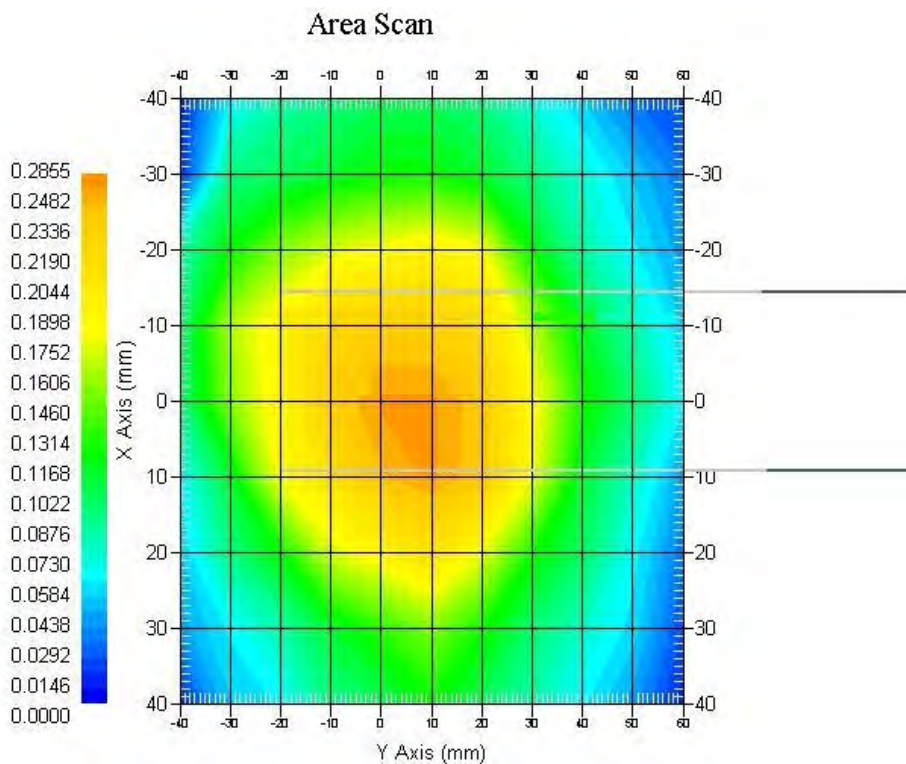



**Test Laboratory: Bay Area Compliance Lab Corp. (Shenzhen)**

**802.11a; Body-worn-Left; Main Antenna (5300 MHz Channel 60)**

Measurement Data

Crest Factor : 1  
 Scan Type : Complete  
 Area Scan : 8x11x1 : Measurement x=10mm, y=10mm, z=4mm  
 Zoom Scan : 7x7x7 : Measurement x=5mm, y=5mm, z=5mm  
 Power Drift-Start : 0.215 W/kg  
 Power Drift-Finish : 0.216 W/kg  
 Power Drift (%) : 0.463

Tissue Data

Type : Body  
 Frequency : 5300 MHz  
 Epsilon : 48.01 F/m  
 Sigma : 5.56 S/m  
 Density : 1000.00 kg/cu. m

Probe Data

Serial No. : 500-00283  
 Frequency Band : 5250 MHz  
 Duty Cycle Factor : 1  
 Conversion Factor : 2.6  
 Probe Sensitivity : 1.20 1.20 1.20  $\mu\text{V}/(\text{V}/\text{m})^2$   
 Compression Point : 95.00 mV  
 Offset : 1.56 mm

1 gram SAR value : 0.209 W/kg  
 10 gram SAR value : 0.133 W/kg  
 Area Scan Peak SAR : 0.218 W/kg  
 Zoom Scan Peak SAR : 0.255 W/kg

**Plot 3#**

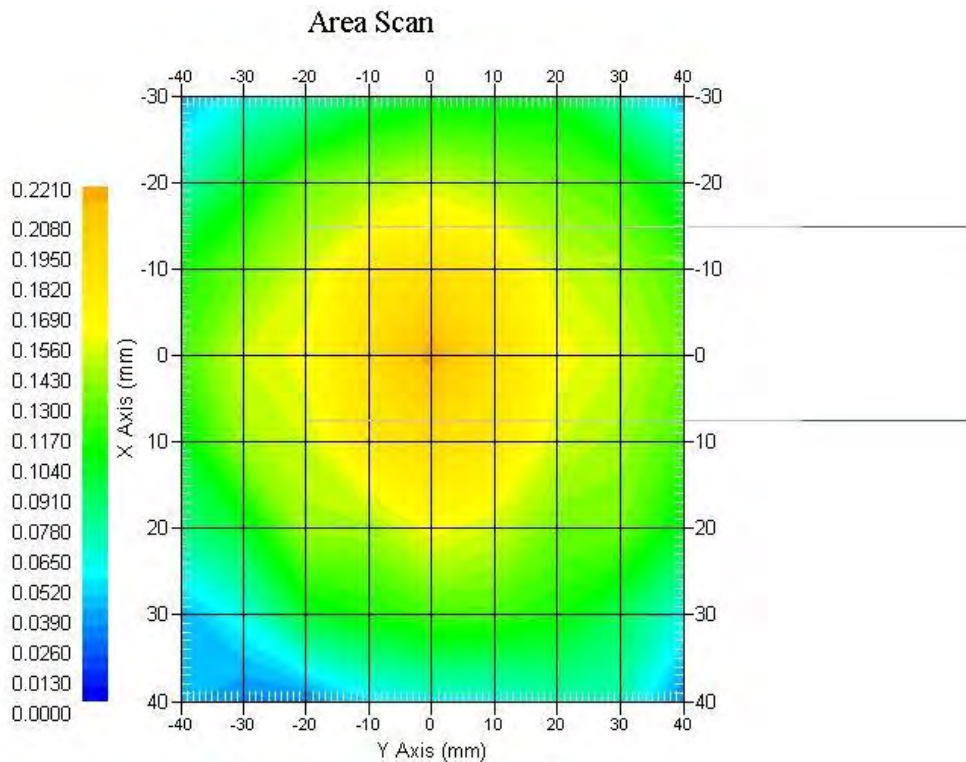



**Test Laboratory: Bay Area Compliance Lab Corp. (Shenzhen)**

**802.11a; Body-worn-Left; Main Antenna (5560 MHz Channel 112)**

Measurement Data

Crest Factor : 1  
 Scan Type : Complete  
 Area Scan : 8x11x1 : Measurement x=10mm, y=10mm, z=4mm  
 Zoom Scan : 7x7x7 : Measurement x=5mm, y=5mm, z=5mm  
 Power Drift-Start : 0.375 W/kg  
 Power Drift-Finish : 0.369 W/kg  
 Power Drift (%) : -1.562

Tissue Data

Type : Body  
 Frequency : 5560 MHz  
 Epsilon : 47.72 F/m  
 Sigma : 5.74 S/m  
 Density : 1000.00 kg/cu. m

Probe Data

Serial No. : 500-00283  
 Frequency Band : 5600 MHz  
 Duty Cycle Factor : 1  
 Conversion Factor : 2.2  
 Probe Sensitivity : 1.20 1.20 1.20  $\mu\text{V}/(\text{V}/\text{m})^2$   
 Compression Point : 95.00 mV  
 Offset : 1.56 mm

1 gram SAR value : 0.407 W/kg  
 10 gram SAR value : 0.259 W/kg  
 Area Scan Peak SAR : 0.418 W/kg  
 Zoom Scan Peak SAR : 0.627 W/kg

**Plot 4#**

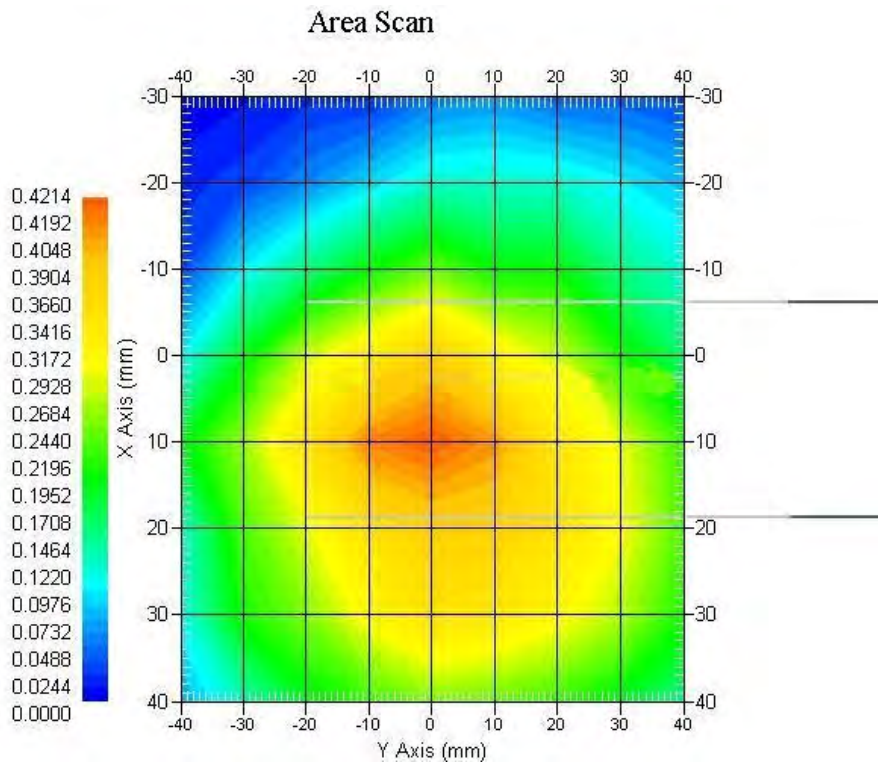

**Test Laboratory: Bay Area Compliance Lab Corp. (Shenzhen)**

**802.11a; Body-worn-Left; Main Antenna (5745 MHz Channel 149)**

Measurement Data

Crest Factor : 1  
 Scan Type : Complete  
 Area Scan : 8x11x1 : Measurement x=10mm, y=10mm, z=4mm  
 Zoom Scan : 7x7x7 : Measurement x=5mm, y=5mm, z=5mm  
 Power Drift-Start : 0.235 W/kg  
 Power Drift-Finish : 0.237 W/kg  
 Power Drift (%) : 0.851

Tissue Data

Type : Body  
 Frequency : 5745 MHz  
 Epsilon : 47.51 F/m  
 Sigma : 5.86 S/m  
 Density : 1000.00 kg/cu. m

Probe Data

Serial No. : 500-00283  
 Frequency Band : 5800 MHz  
 Duty Cycle Factor : 1  
 Conversion Factor : 2.5  
 Probe Sensitivity : 1.20 1.20 1.20  $\mu\text{V}/(\text{V}/\text{m})^2$   
 Compression Point : 95.00 mV  
 Offset : 1.56 mm

1 gram SAR value : 0.352 W/kg  
 10 gram SAR value : 0.191 W/kg  
 Area Scan Peak SAR : 0.367 W/kg  
 Zoom Scan Peak SAR : 0.452 W/kg

**Plot 5#**

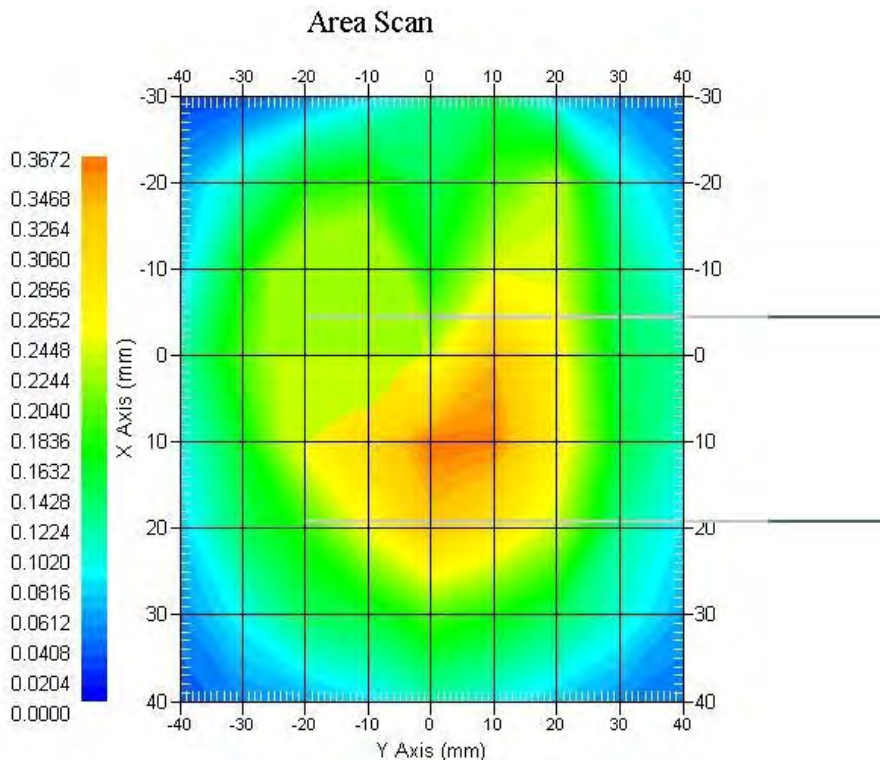

## APPENDIX A MEASUREMENT UNCERTAINTY

According to **IEEE1528:2013**, the uncertainty budget has been determined for the Head SAR measurement system and is given in the following Table.

Source of Uncertainty	Tolerance Value	Probability Distribution	Divisor	$c_i^1$ (1-g)	$c_i^1$ (10-g)	Standard Uncertainty (1-g) %	Standard Uncertainty (10-g) %
<b>Measurement System</b>							
Probe Calibration	3.5	normal	1	1	1	3.5	3.5
Axial Isotropy	3.7	rectangular	$\sqrt{3}$	$(1-cp)^{1/2}$	$(\frac{1-cp}{2})^1$	1.5	1.5
Hemispherical Isotropy	10.9	rectangular	$\sqrt{3}$	$\sqrt{cp}$	$\sqrt{cp}$	4.4	4.4
Boundary Effect	1.0	rectangular	$\sqrt{3}$	1	1	0.6	0.6
Linearity	4.7	rectangular	$\sqrt{3}$	1	1	2.7	2.7
Detection Limit	1.0	rectangular	$\sqrt{3}$	1	1	0.6	0.6
Readout Electronics	1.0	normal	1	1	1	1.0	1.0
Response Time	0.8	rectangular	$\sqrt{3}$	1	1	0.5	0.5
Integration Time	1.7	rectangular	$\sqrt{3}$	1	1	1.0	1.0
RF Ambient Condition -Noise	0.6	rectangular	$\sqrt{3}$	1	1	0.3	0.3
RF Ambient Condition - Reflections	3.0	rectangular	$\sqrt{3}$	1	1	1.7	1.7
Probe Positioner Mech. Restrictions	0.4	rectangular	$\sqrt{3}$	1	1	0.2	0.2
Probe Positioning with respect to Phantom Shell	2.9	rectangular	$\sqrt{3}$	1	1	1.7	1.7
Extrapolation and Integration	3.7	rectangular	$\sqrt{3}$	1	1	2.1	2.1
<b>Test sample related</b>							
Test sample positioning	2.0	normal	1	1	1	2.0	2.0
Device Holder Uncertainty	4.0	normal	1	1	1	6.215	6.215
Drift of Output Power	5.0	rectangular	$\sqrt{3}$	1	1	2.67	2.67
<b>Phantom and Setup</b>							
Phantom Uncertainty	3.4	rectangular	$\sqrt{3}$	1	1	2.0	2.0
SAR correction in permittivity and conductivity	1.2	normal	1	1	0.85	1.2	1.0
Liquid conductivity measurement	5.0	normal	1	0.78	0.71	3.9	3.6
Liquid permittivity measurement	5.0	normal	1	0.25	0.29	1.3	1.5
conductivity—temperature	1.1	rectangular	$\sqrt{3}$	0.78	0.71	0.5	0.5
permittivity—temperature	1.3	rectangular	$\sqrt{3}$	0.23	0.23	0.2	0.2
Combined Uncertainty		RSS				10.78	10.55
Expanded uncertainty (coverage factor=2)		Normal(k=2)				21.56	21.10

According to **IEC62209-2:2010**, the uncertainty budget has been determined for the Body SAR measurement system and is given in the following Table.

Source of Uncertainty	Tolerance Value	Probability Distribution	Divisor	$c_i^1$ (1-g)	$c_i^1$ (10-g)	Standard Uncertainty (1-g) %	Standard Uncertainty (10-g) %
<b>Measurement System</b>							
Probe Calibration	3.5	normal	1	1	1	3.5	3.5
Axial Isotropy	3.7	rectangular	$\sqrt{3}$	1	1	1.5	1.5
Boundary Effect	1.0	rectangular	$\sqrt{3}$	1	1	0.6	0.6
Linearity	4.7	rectangular	$\sqrt{3}$	1	1	2.7	2.7
Detection Limit	1.0	rectangular	$\sqrt{3}$	1	1	0.6	0.6
Readout Electronics	1.0	normal	1	1	1	1.0	1.0
Response Time	0.8	rectangular	$\sqrt{3}$	1	1	0.5	0.5
Integration Time	1.7	rectangular	$\sqrt{3}$	1	1	1.0	1.0
RF Ambient Condition -Noise	0.6	rectangular	$\sqrt{3}$	1	1	0.3	0.3
RF Ambient Condition - Reflections	3.0	rectangular	$\sqrt{3}$	1	1	1.7	1.7
Probe Positioner Mech. Restrictions	0.4	rectangular	$\sqrt{3}$	1	1	0.2	0.2
Probe Positioning with respect to Phantom Shell	2.9	rectangular	$\sqrt{3}$	1	1	1.7	1.7
Extrapolation and Integration	3.7	rectangular	$\sqrt{3}$	1	1	2.1	2.1
<b>Test sample related</b>							
Test sample positioning	2.0	normal	1	1	1	2.0	2.0
Device Holder Uncertainty	4.0	normal	1	1	1	6.215	6.215
Drift of Output Power	5.0	rectangular	$\sqrt{3}$	1	1	2.67	2.67
<b>Phantom and Setup</b>							
Phantom Uncertainty	3.4	rectangular	$\sqrt{3}$	1	1	2.0	2.0
SAR correction in permittivity and conductivity	1.2	normal	1	1	0.84	1.2	1.0
Liquid conductivity measurement	5.0	normal	1	0.78	0.71	3.9	3.6
Liquid permittivity measurement	5.0	normal	1	0.23	0.26	1.3	1.5
conductivity—temperature	1.1	rectangular	$\sqrt{3}$	0.78	0.71	0.5	0.5
permittivity—temperature	1.3	rectangular	$\sqrt{3}$	0.23	0.26	0.2	0.2
Combined Uncertainty		RSS				9.58	9.49
Expanded uncertainty (coverage factor=2)		Normal(k=2)				19.16	18.98

## APPENDIX B – PROBE CALIBRATION CERTIFICATES

### NCL CALIBRATION LABORATORIES

Calibration File No.: PC-1598

Task No: BACL-5778

## CERTIFICATE OF CALIBRATION

It is certified that the equipment identified below has been calibrated in the  
NCL CALIBRATION LABORATORIES by qualified personnel following recognized  
procedures and using transfer standards traceable to NRC/NIST.

Equipment: Miniature Isotropic RF Probe

Record of Calibration

Head and Body

Manufacturer: APREL Laboratories

Model No.: E-020

Serial No.: 500-00285

Calibration Procedure: D01-032-E020-V2, D22-012-Tissue, D28-002-Dipole

Project No: BACL-5745

Calibrated: 14<sup>th</sup> October 2014.

Released on: 14<sup>th</sup> October 2014

This Calibration Certificate is incomplete unless accompanied with the Calibration Results Summary

Released By: \_\_\_\_\_



Art Brennan, Quality Manager

### **NCL** CALIBRATION LABORATORIES

Suite 102, 303 Terry Fox Dr.  
OTTAWA, ONTARIO  
CANADA K2K 5J1

Division of APREL Lab.  
TEL: (613) 435-8300  
FAX: (613) 435-8306

## **NCL Calibration Laboratories**

Division of APREL, Inc.

### **Introduction**

This Calibration Report reproduces the results of the calibration performed in line with the references listed below. Calibration is performed using accepted methodologies as per the references listed below. Probes are calibrated for air, and tissue and the values reported are the results from the physical quantification of the probe through meteorological practices.

### **Calibration Method**

Probes are calibrated using the following methods.

<1000MHz

TEM Cell for sensitivity in air

Standard phantom using temperature transfer method for sensitivity in tissue

>1000MHz

Waveguide\* method to determine sensitivity in air and tissue

\*Waveguide is numerically (simulation) assessed to determine the field distribution and power

The boundary effect for the probe is assessed using a standard flat phantom where the probe output is compared against a numerically simulated series of data points

### **References**

- IEEE Standard 1528
- IEEE Recommended Practice for Determining the Peak Spatial-Average Specific Absorption Rate (SAR) in the Human Head from Wireless Communications Devices: Measurement Techniques
- EN 62209-1
- Human Exposure to RF Fields from hand-held and body-mounted wireless communication devices - Human models, instrumentation, and procedures-Part 1: Procedure to measure the Specific Absorption Rate (SAR) for hand-held mobile wireless devices
- IEC 62209-2
- Human exposure to RF fields from hand-held and body-mounted wireless devices - Human models, instrumentation, and procedures - Part 2: specific absorption rate (SAR) for wireless communication devices (30 MHz - 6 GHz)
- TP-D01-032-E020-V2 E-Field probe calibration procedure
- D22-012-Tissue dielectric tissue calibration procedure
- D28-002-Dipole procedure for validation of SAR system using a dipole
- IEEE 1309 Standard for Calibration of Electromagnetic Field Sensors and Probes, Excluding Antennas, from 9kHz to 40GHz

---

Page 2 of 10

This page has been reviewed for content and attested to on Page 2 of this document.



**NCL Calibration Laboratories**

Division of APREL, Inc.

**Conditions**

Probe 500-00283 was a recalibration.

**Ambient Temperature of the Laboratory:** 22 °C +/- 1.5°C  
**Temperature of the Tissue:** 21 °C +/- 1.5°C  
**Relative Humidity:** < 60%

**Primary Measurement Standards**

Instrument	Serial Number	Cal due date
Tektronix USB Power Meter	11C940	May 14, 2015
Signal Generator HP 83640B	3844A00689	Feb 12, 2015

**Secondary Measurement Standards**

Network Analyzer Anritsu 37347C	002106	Feb. 20, 2015
---------------------------------	--------	---------------

**Attestation**

The below named signatories have conducted the calibration and review of the data which is presented in this calibration report.

We the undersigned attest that to the best of our knowledge the calibration of this subject has been accurately conducted and that all information contained within the results pages have been reviewed for accuracy.

  
 \_\_\_\_\_  
 Art Brennan, Quality Manager

  
 \_\_\_\_\_  
 Dan Brooks, Test Engineer

Page 3 of 10  
 This page has been reviewed for content and attested to on Page 2 of this document.

**NCL Calibration Laboratories**

Division of APREL, Inc.

**Probe Summary**

<b>Probe Type:</b>	E-Field Probe E020
<b>Serial Number:</b>	500-00283
<b>Frequency:</b>	As presented on page 5
<b>Sensor Offset:</b>	1.56
<b>Sensor Length:</b>	2.5
<b>Tip Enclosure:</b>	Composite*
<b>Tip Diameter:</b>	< 2.9 mm
<b>Tip Length:</b>	55 mm
<b>Total Length:</b>	289 mm

\*Resistive to recommended tissue recipes per IEEE-1528.

**Sensitivity in Air**

<b>Channel X:</b>	1.2 $\mu\text{V}/(\text{V}/\text{m})^2$
<b>Channel Y:</b>	1.2 $\mu\text{V}/(\text{V}/\text{m})^2$
<b>Channel Z:</b>	1.2 $\mu\text{V}/(\text{V}/\text{m})^2$
<b>Diode Compression Point:</b>	95 mV

---

Page 4 of 10  
This page has been reviewed for content and attested to on Page 2 of this document.



**NCL Calibration Laboratories**

Division of APREL, Inc.

Calibration for Tissue (Head H, Body B)

Frequency	Tissue Type	Measured Epsilon	Measured Sigma	Standard Uncertainty (%)	Calibration Frequency Range (MHz)	Conversion Factor
450 H	Head	43.59	0.86	3.5	±50	5.7
450 B	Body	56.74	0.94	3.5	±50	5.8
750 H	Head	42.98	0.92	3.5	±50	6.0
750 B	Body	43.05	0.93	3.5	±50	5.5
835 H	Head	43.42	0.94	3.5	±50	5.9
835 B	Body	55.77	1.01	3.5	±50	5.9
900 H	Head	41.87	1.06	3.5	±50	6.0
900 B	Body	55.62	1.05	3.5	±50	5.9
1450 H	Head	X	X	X	X	X
1450 B	Body	X	X	X	X	X
1500 H	Head	X	X	X	X	X
1500 B	Body	X	X	X	X	X
1640 H	Head	X	X	X	X	X
1640 B	Body	X	X	X	X	X
1750 H	Head	38.23	1.38	3.5	±75	5.4
1750 B	Body	52.86	1.54	3.5	±75	5.3
1800 H	Head	X	X	X	X	X
1800 B	Body	X	X	X	X	X
1900 H	Head	40.20	1.38	3.5	±75	4.8
1900 B	Body	52.63	1.46	3.5	±75	4.5
2000 H	Head	X	X	X	X	X
2000 B	Body	X	X	X	X	X
2100 H	Head	X	X	X	X	X
2100 B	Body	X	X	X	X	X
2300 H	Head	X	X	X	X	X
2300 B	Body	X	X	X	X	X
2450 H	Head	37.26	1.84	3.5	±75	4.9
2450 B	Body	53.61	1.9	3.5	±75	4.3
3000 H	Head	X	X	X	X	X
3000 B	Body	X	X	X	X	X
3600 H	Head	37.49	3.16	3.5	±100	4.5
3600 B	Body	49.94	3.86	3.5	±100	4.0
5250 H	Head	35.51	4.78	3.5	±100	3.0
5250 B	Body	47.54	5.11	3.5	±100	2.8
5600 H	Head	36.05	5.15	3.5	±100	2.8
5600 B	Body	46.49	5.72	3.5	±100	2.2
5800 H	Head	45.99	6.01	3.5	±100	3.2
5800 B	Body	35.6	5.37	3.5	±100	2.5

**NCL Calibration Laboratories**

---

Division of APREL, Inc.

**Boundary Effect:**

Uncertainty resulting from the boundary effect is less than 2.1% for the distance between the tip of the probe and the tissue boundary, when less than 0.58mm.

**Spatial Resolution:**

The spatial resolution uncertainty is less than 1.5% for 4.9mm diameter probe.  
The spatial resolution uncertainty is less than 1.0% for 2.5mm diameter probe.

**DAQ-PAQ Contribution**

To minimize the uncertainty calculation all tissue sensitivity values were calculated using a load impedance of 5 M $\Omega$ .

---

Page 6 of 10

This page has been reviewed for content and attested to on Page 2 of this document.

**NCL Calibration Laboratories**

Division of APREI, Inc.

**Receiving Pattern Air**

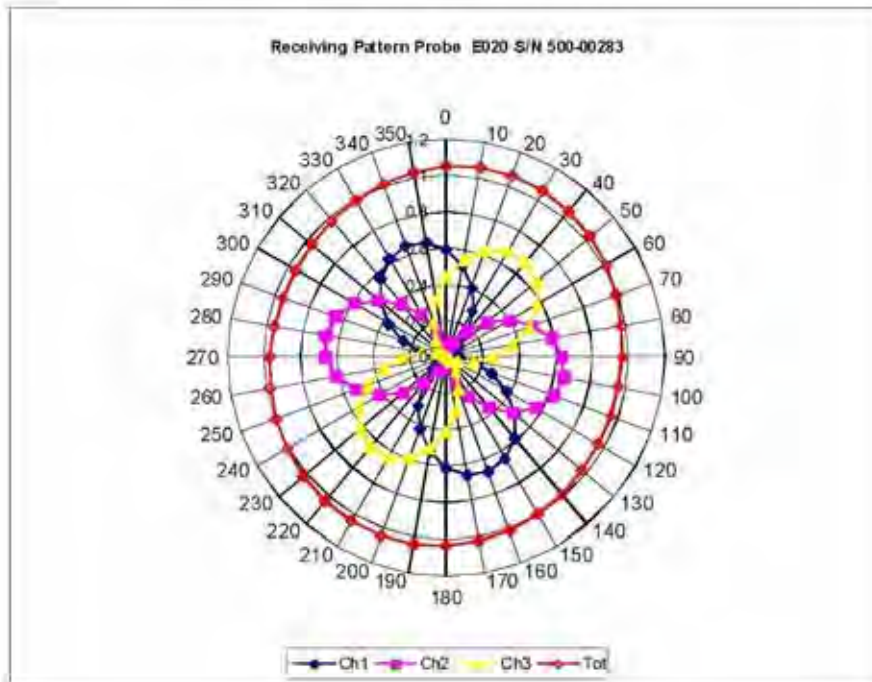

Page 7 of 10

This page has been reviewed for content and attested to on Page 2 of this document.

**NCL Calibration Laboratories**

Division of APREI, Inc.

**Isotropy Error Air**

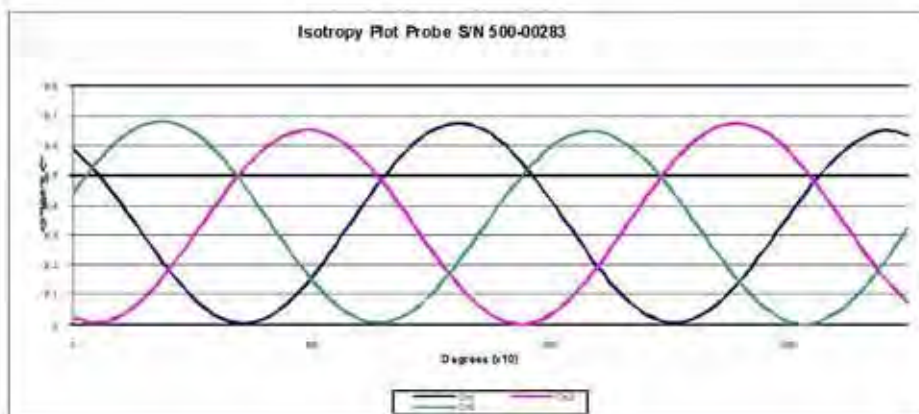
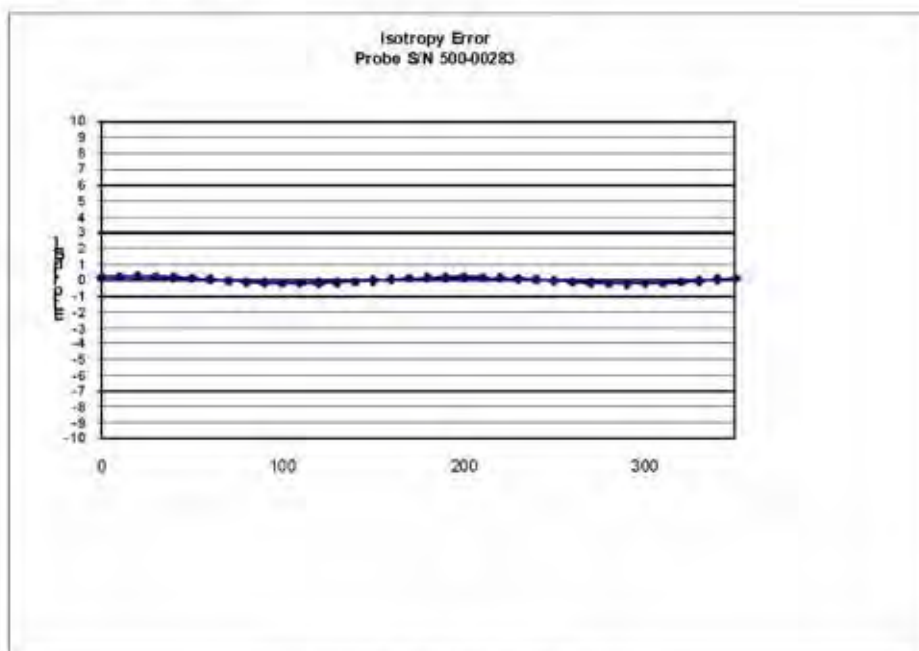

**Isotropicity Tissue:** 0.10 dB

Page 8 of 10  
This page has been reviewed for content and attested to on Page 2 of this document.

**NCL Calibration Laboratories**

Division of APREI, Inc.

**Dynamic Range**

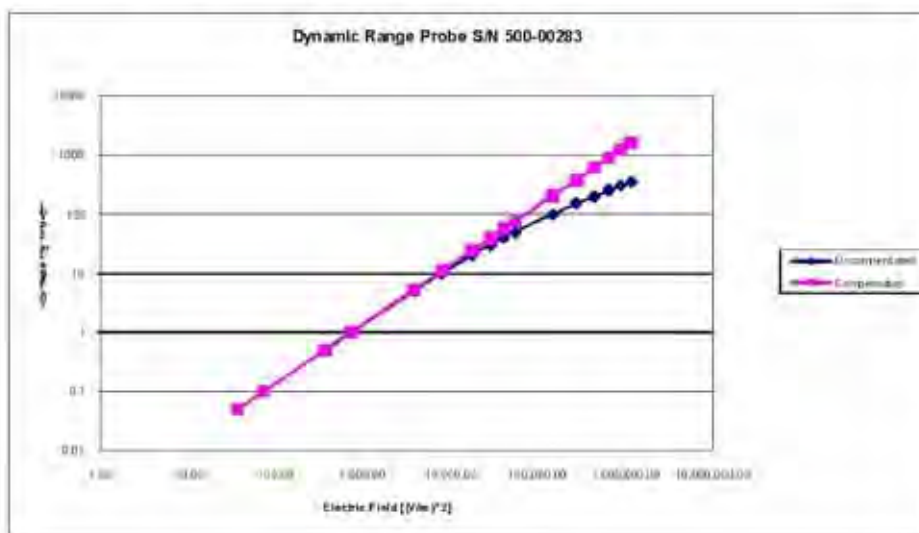

Page 9 of 10

This page has been reviewed for content and attested to on Page 2 of this document.



**NCL Calibration Laboratories**

Division of APREL, Inc.

**Video Bandwidth**

**Probe Frequency Characteristics**

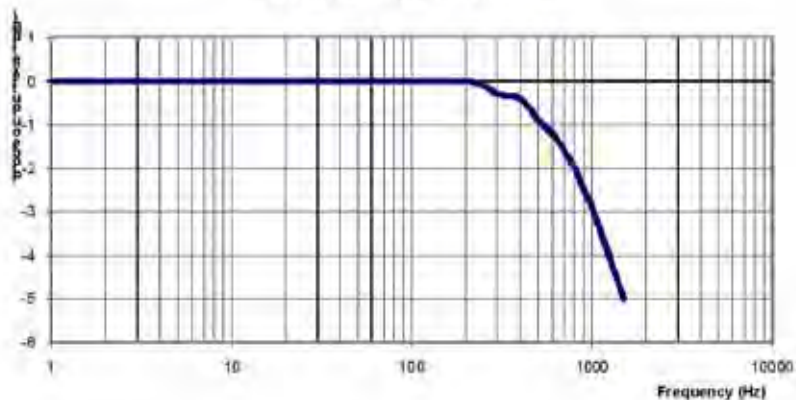

Video Bandwidth at 500 Hz: 1 dB  
Video Bandwidth at 1.02 KHz: 3 dB

**Test Equipment**

The test equipment used during Probe Calibration, manufacturer, model number and, current calibration status are listed and located on the main APREL server R:\NCL\Calibration Equipment\Instrument List May 2014.

Page 10 of 10  
This page has been reviewed for content and attested to on Page 2 of this document.

## APPENDIX C DIPOLE CALIBRATION CERTIFICATES

### NCL CALIBRATION LABORATORIES

Calibration File No: DC-1532

Project Number: BACL-5745

## CERTIFICATE OF CALIBRATION

It is certified that the equipment identified below has been calibrated in the **NCL CALIBRATION LABORATORIES** by qualified personnel following recognized procedures and using transfer standards traceable to NRC/NIST.

Validation Dipole

Manufacturer: APREL Laboratories

Part number: ALS-D-750-S-2

Frequency: 750 MHz

Serial No: 177-00505

Customer: BACL

Calibrated: 8<sup>th</sup> of October 2013

Released on: 8<sup>th</sup> of October 2013

This Calibration Certificate is Incomplete Unless Accompanied with the Calibration Results Summary

Released By: \_\_\_\_\_

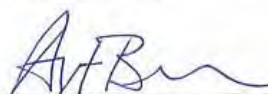

Art Brennan, Quality Manager

### **NCL** CALIBRATION LABORATORIES

303 Terry Fox Drive, Suite 102  
Kanata, Ontario  
CANADA K2K 3J1

Division of APREL  
TEL: (613) 435-8300  
FAX: (613) 435-8308

**NCL Calibration Laboratories**

Division of APREL Laboratories.

**Conditions**

Dipole 177-00505 was a new calibration, removed from stock.

**Ambient Temperature of the Laboratory:** 22 °C +/- 0.5°C

**Temperature of the Tissue:** 21 °C +/- 0.5°C

**We the undersigned attest that to the best of our knowledge the calibration of this device has been accurately conducted and that all information contained within this report has been reviewed for accuracy.**

We the undersigned attest that to the best of our knowledge the calibration of this subject has been accurately conducted and that all information contained within the results pages have been reviewed for accuracy.



Art Brennan, Quality Manager



Dan Brooks, Test Engineer

This page has been reviewed for content and attested to by signature within this document.



**NCL Calibration Laboratories**

Division of APREL Laboratories.

**Calibration Results Summary**

The following results relate the Calibrated Dipole and should be used as a quick reference for the user.

**Mechanical Dimensions**

**Length:** 180.2 mm  
**Height:** 97.0 mm

**Electrical Calibration**

Test	Result Head	Result Body
S11 R/L	-27.621 dB	-21.672 dB
SWR	1.106 U	1.201 U
Impedance	52.505 Ω	55.933 Ω

**System Validation Results**

Frequency	1 Gram	10 Gram
750 MHz		
Head	8.5	54.0
Body	8.54	5.42

**Head**

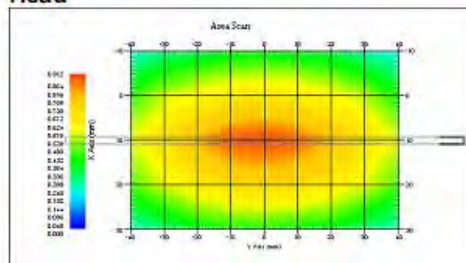

**Body**

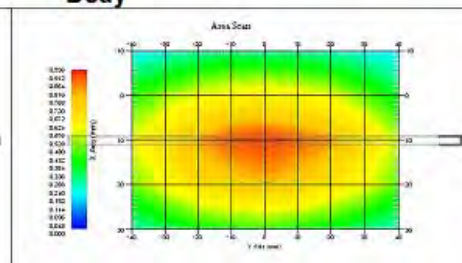

This page has been reviewed for content and attested to by signature within this document.

**NCL Calibration Laboratories**

Division of APREL Laboratories.

**Introduction**

This Calibration Report has been produced in line with the SSI Dipole Calibration Procedure SSI-TP-018-ALSAS. The results contained within this report are for Validation Dipole 177-00505. The calibration routine consisted of a three-step process. Step 1 was a mechanical verification of the dipole to ensure that it meets the mechanical specifications. Step 2 was an Electrical Calibration for the Validation Dipole, where the SWR, Impedance, and the Return loss were assessed. Step 3 involved a System Validation using the ALSAS-10U, along with APREL E-020 130 MHz to 26 GHz E-Field Probe Serial Number 2225.

**References**

- SSI-TP-018-ALSAS Dipole Calibration Procedure
- SSI-TP-016 Tissue Calibration Procedure
- IEEE 1528 "Recommended Practice for Determining the Peak Spatial-Average Specific Absorption Rate (SAR) in the Human Body Due to Wireless Communications Devices: Experimental Techniques"
- IEC-62209 "Human exposure to radio frequency fields from hand-held and body-mounted wireless communication devices – Human models, instrumentation, and procedures"
- Part 1: "Procedure to determine the Specific Absorption Rate (SAR) for hand-held devices used in close proximity of the ear (frequency range of 300 MHz to 3 GHz)"
- IEC-62209 "Human exposure to radio frequency fields from hand-held and body-mounted wireless communication devices – Human models, instrumentation, and procedures"
- Part 2: "Procedure to determine the Specific Absorption Rate (SAR) for hand-held devices used in close proximity of the ear (frequency range of 30 MHz to 6 GHz)"
- TP-D01-032-E020-V2 E-Field probe calibration procedure
- D22-012-Tissue dielectric tissue calibration procedure
- D28-002-Dipole procedure for validation of SAR system using a dipole
- IEEE 1309 Draft Standard for Calibration of Electromagnetic Field Sensors and Probes, Excluding Antennas, from 9kHz to 40GHz

**Conditions**

Dipole 177-00505 was a new calibration.

**Ambient Temperature of the Laboratory:** 22 °C +/- 0.5°C  
**Temperature of the Tissue:** 20 °C +/- 0.5°C

4

This page has been reviewed for content and attested to by signature within this document.

**NCL Calibration Laboratories**

Division of APREL Laboratories.

**Dipole Calibration Results**

**Mechanical Verification**

APREL Length	APREL Height	Measured Length	Measured Height
180.0 mm	97.8 mm	180.2 mm	97.0 mm

**Tissue Validation**

Tissue 750MHz	Measured Head	Measured Body
Dielectric constant, $\epsilon_r$	42.7	56.6
Conductivity, $\sigma$ [S/m]	0.85	0.94

**Dipole Calibration uncertainty**

The calibration uncertainty for the dipole is made up of various parameters presented below.

<b>Mechanical</b>	1%
<b>Positioning Error</b>	1.22%
<b>Electrical</b>	1.7%
<b>Tissue</b>	2.2%
<b>Dipole Validation</b>	2.2%
<b>TOTAL</b>	<b>8.32% (16.64% K=2)</b>



**NCL Calibration Laboratories**

Division of APREL Laboratories.

**Electrical Calibration**

Test	Result Head	Result Body
S11 R/L	-27.621 dB	-21.672 dB
SWR	1.106 U	1.201 U
Impedance	52.505 Ω	55.933 Ω

The Following Graphs are the results as displayed on the Vector Network Analyzer.

**S11 Parameter Return Loss**

**HEAD**

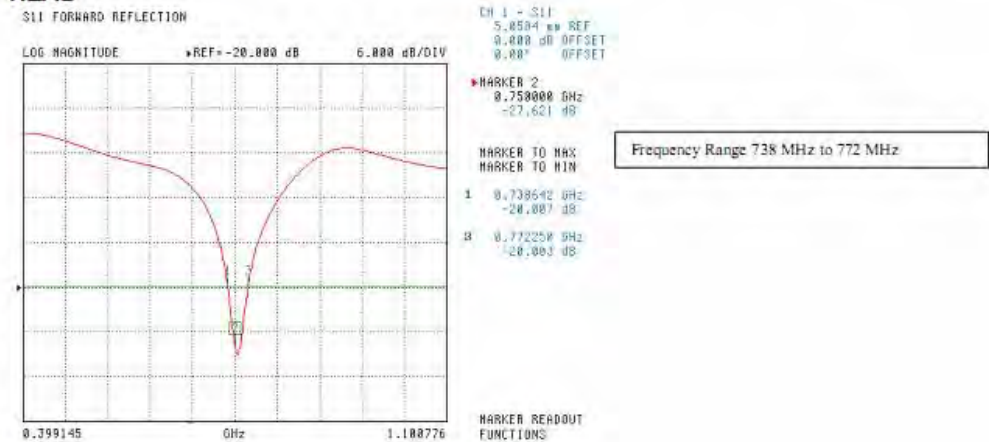

**BODY**

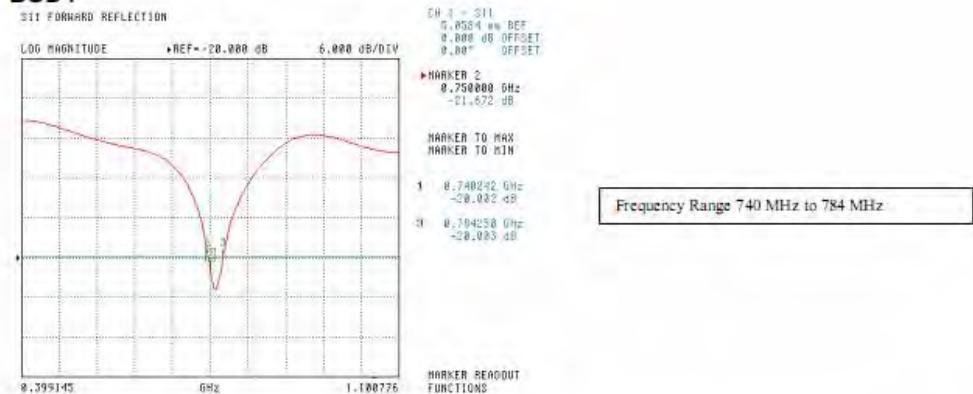

This page has been reviewed for content and attested to by signature within this document.

**NCL Calibration Laboratories**

Division of APREL Laboratories.

**SWR**

**Head**



**Body**



This page has been reviewed for content and attested to by signature within this document.

**NCL Calibration Laboratories**

Division of APREL Laboratories.

**Smith Chart Dipole Impedance**

**Head**

S11 FORWARD REFLECTION  
IMPEDANCE

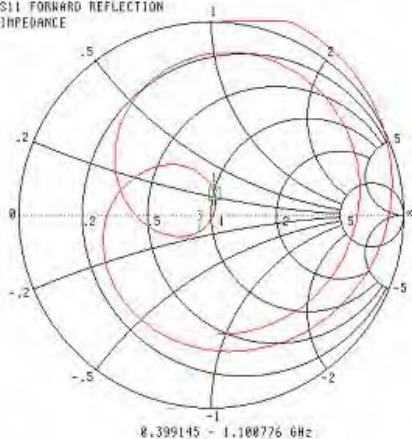

CH 1 - S11  
5.0504 mW REF  
0.000 dB OFFSET  
0.00° OFFSET

\*MARKER 2  
0.750000 GHz  
52.585 Ω  
2.731 jΩ

MARKER TO MAX

MARKER TO MIN

1 0.738542 GHz

50.918 Ω

11.112 jΩ

0 0.772250 GHz

43.762 Ω

-0.112 jΩ

MARKER READOUT  
FUNCTIONS

**Body**

S11 FORWARD REFLECTION  
IMPEDANCE

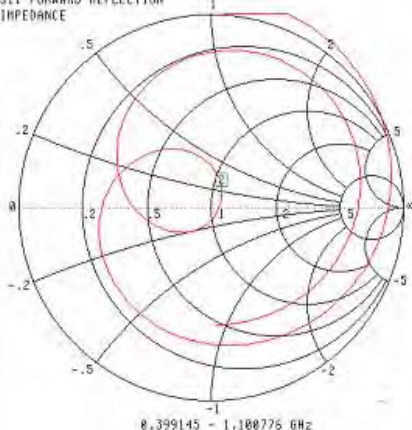

CH 1 - S11  
5.0504 mW REF  
0.000 dB OFFSET  
0.00° OFFSET

\*MARKER 2  
0.750000 GHz  
55.933 Ω  
6.574 jΩ

MARKER TO MAX

MARKER TO MIN

MARKER READOUT  
FUNCTIONS

This page has been reviewed for content and attested to by signature within this document.

**NCL Calibration Laboratories**

Division of APREL Laboratories.

---

**Test Equipment**

The test equipment used during Probe Calibration, manufacturer, model number and, current calibration status are listed and located on the main APREL server R:\NCL\Calibration Equipment\Instrument List May 2013.

This page has been reviewed for content and attested to by signature within this document.

9

**NCL CALIBRATION LABORATORIES**

Calibration File No: DC-1535  
Project Number: BACL-5745

**CERTIFICATE OF CALIBRATION**

It is certified that the equipment identified below has been calibrated in the  
**NCL CALIBRATION LABORATORIES** by qualified personnel following recognized  
procedures and using transfer standards traceable to NRC/NIST.

Validation Dipole

Manufacturer: APREL Laboratories  
Part number: ALS-D-5200-S-2  
Frequency: 5250 MHz  
Serial No: 23D-00805

Customer: Bay Area Compliance Laboratory

Calibrated: 8<sup>th</sup> of October, 2013  
Released on: 8<sup>th</sup> of October, 2013

This Calibration Certificate is Incomplete Unless Accompanied with the Calibration Results Summary

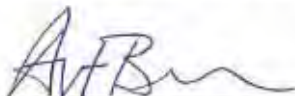
Released By:   
Art Brennan, Quality Manager

**NCL CALIBRATION LABORATORIES**

303 Terry Fox Drive, Suite 102  
Kanata, Ontario  
CANADA K2K 3J1

Division of APREL  
TEL: (613) 435-8300  
FAX: (613) 435-8306



**NCL Calibration Laboratories**

Division of APREL Laboratories

**Conditions**

Dipole 230-00805 was new and taken from stock prior to calibration.

**Ambient Temperature of the Laboratory:** 22 °C +/- 0.5°C

**Temperature of the Tissue:** 21 °C +/- 0.5°C

We the undersigned attest that to the best of our knowledge the calibration of this subject has been accurately conducted and that all information contained within the results pages have been reviewed for accuracy.



Art Brennan, Quality Manager



Dan Brooks, Test Engineer

This page has been reviewed for content and attested to by signature within this document.

2

**NCL Calibration Laboratories**

Division of APREL Laboratories.

**Calibration Results Summary**

The following results relate the Calibrated Dipole and should be used as a quick reference for the user.

**Mechanical Dimensions**

Length: 23.4 mm  
 Height: 21.9 mm

**Electrical Calibration**

Test	Result Head	Result Body
S11 R/L	-21.071 dB	-20.067 dB
SWR	1.196 U	1.221 U
Impedance	44.119 Ω	44.044 Ω

**System Validation Results**

Frequency 5250 MHz	1 Gram	10 Gram
Head	62.18	20.82
Body	64.00	20.00

Head

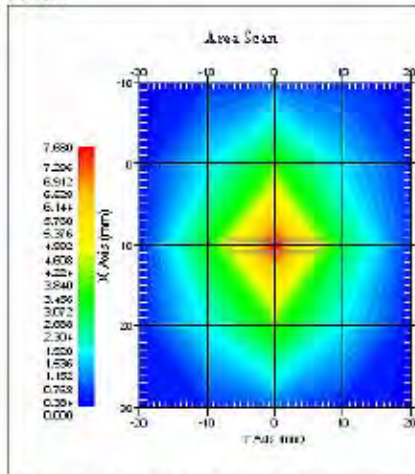

Body

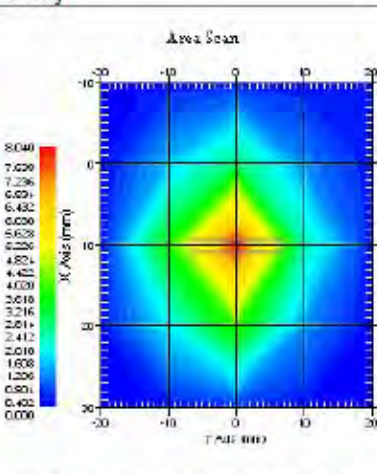

Note: APREL dipoles for SAR measurements above 5 GHz are calibrated referring the target 1 g and 10 g SAR numbers as a result of numerical simulation utilizing XFDTD method (Remcom Inc.) for the configuration of APREL dipoles and Uni- and Flat Phantoms.

This page has been reviewed for content and attested to by signature within this document.

**NCL Calibration Laboratories**

Division of APREL Laboratories.

**Introduction**

This Calibration Report has been produced in line with the SSI Dipole Calibration Procedure SSI-TP-018-ALSAS. The results contained within this report are for Validation Dipole 230-00805. The calibration routine consisted of a three-step process. Step 1 was a mechanical verification of the dipole to ensure that it meets the mechanical specifications. Step 2 was an Electrical Calibration for the Validation Dipole, where the SWR, Impedance, and the Return loss were assessed. Step 3 involved a System Validation using the ALSAS-10U, along with APREL E-020 130 MHz to 26 GHz E-Field Probe Serial Number 212.

**References**

- SSI-TP-018-ALSAS Dipole Calibration Procedure
- SSI-TP-016 Tissue Calibration Procedure
- IEEE 1528 "Recommended Practice for Determining the Peak Spatial-Average Specific Absorption Rate (SAR) in the Human Body Due to Wireless Communications Devices: Experimental Techniques"
- IEC-62209 "Human exposure to radio frequency fields from hand-held and body-mounted wireless communication devices – Human models, instrumentation, and procedures"
- Part 1: "Procedure to determine the Specific Absorption Rate (SAR) for hand-held devices used in close proximity of the ear (frequency range of 300 MHz to 3 GHz)"
- IEC-62209 "Human exposure to radio frequency fields from hand-held and body-mounted wireless communication devices – Human models, instrumentation, and procedures"
- Part 2: "Procedure to determine the Specific Absorption Rate (SAR) for hand-held devices used in close proximity of the ear (frequency range of 30 MHz to 6 GHz)"
- TP-D01-032-E020-V2 E-Field probe calibration procedure
- D22-012-Tissue dielectric tissue calibration procedure
- D28-002-Dipole procedure for validation of SAR system using a dipole
- IEEE 1309 Draft Standard for Calibration of Electromagnetic Field Sensors and Probes, Excluding Antennas, from 9kHz to 40GHz

**Conditions**

Dipole 230-00805 was a re-calibration.

Ambient Temperature of the Laboratory: 22 °C +/- 0.5°C  
Temperature of the Tissue: 20 °C +/- 0.5°C

This page has been reviewed for content and attested to by signature within this document.

4



**NCL Calibration Laboratories**

Division of APREL Laboratories.

**Dipole Calibration Results**

**Mechanical Verification**

APREL Length	APREL Height	Measured Length	Measured Height
23 mm	21 mm	23.4 mm	21.9 mm

**Tissue Validation**

Tissue 5250 MHz	Measured Head	Measured Body
Dielectric constant, $\epsilon_r$	34.65	47.6
Conductivity, $\sigma$ [S/m]	4.8	5.3

**Dipole Calibration uncertainty**

The calibration uncertainty for the dipole is made up of various parameters presented below.

Mechanical	1%
Positioning Error	1.22%
Electrical	1.7%
Tissue	2.2%
Dipole Validation	2.2%
<b>Combined Standard Uncertainty</b>	<b>3.88% (7.76% K=2)</b>

**Primary Measurement Standards**

Instrument	Serial Number	Cal due date
Tektronix USB Power Meter	11C940	May 14, 2015
Network Analyzer Anritsu 37347C	002106	Feb. 20, 2015

This page has been reviewed for content and attested to by signature within this document.

**NCL Calibration Laboratories**

Division of APREL Laboratories.

**Electrical Calibration**

Test	Result Head	Result Body
S11 R/L	-21.071 dB	-20.067 dB
SWR	1.196 U	1.221 U
Impedance	44.119 Ω	44.044 Ω

The Following graphs are the results as displayed on the Vector Network Analyzer.

**S11 Parameter Return Loss**

**Head**

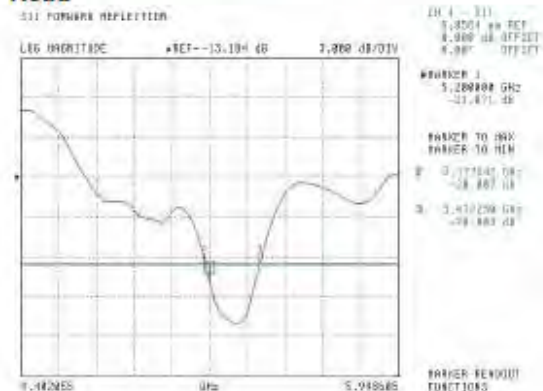

Frequency Range 5.177 GHz to 5.472 GHz

**Body**



Frequency Range 5.200 GHz to 5.417 GHz

This page has been reviewed for content and attested to by signature within this document.

**NCL Calibration Laboratories**  
Division of APREL Laboratories.

**SWR**

**Head**

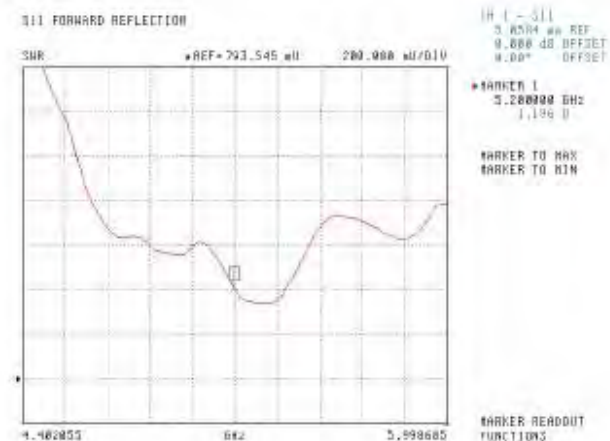

**Body**



This page has been reviewed for content and attested to by signature within this document.

7

**NCL Calibration Laboratories**

Division of APREL Laboratories.

**Smith Chart Dipole Impedance**

**Head**

S11 FORWARD REFLECTION  
IMPEDANCE

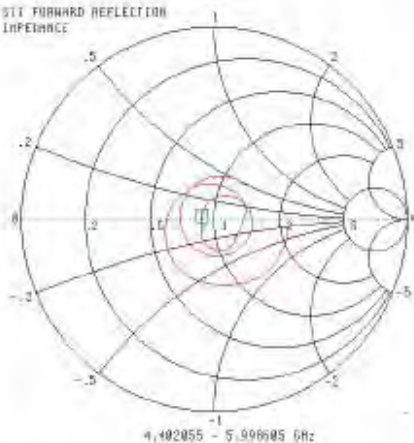

SWR 1 - S11  
5.8504 dB REF  
0.000 dB OFFSET  
0.000 dB OFFSET

\*MARKER 1  
5.20000 GHz  
44.114 dB  
-5.074 dB

MARKER TO MAX  
MARKER TO MIN

MARKER READOUT  
FUNCTIONS

**Body**

S11 FORWARD REFLECTION  
IMPEDANCE

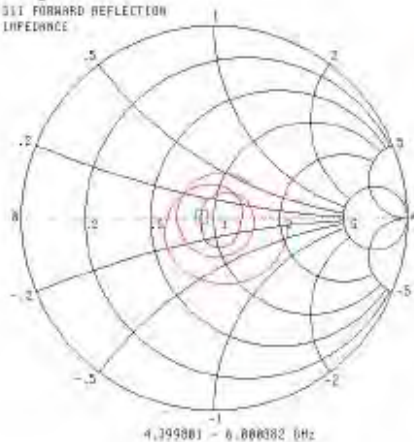

SWR 1 - S11  
5.8504 dB REF  
0.000 dB OFFSET  
0.000 dB OFFSET

\*MARKER 1  
5.20000 GHz  
45.444 dB  
-5.160 dB

MARKER TO MAX  
MARKER TO MIN

MARKER READOUT  
FUNCTIONS

This page has been reviewed for content and attested to by signature within this document.

**NCL Calibration Laboratories**

Division of APREL Laboratories.

---

**Test Equipment**

The test equipment used during Probe Calibration, manufacturer, model number and, current calibration status are listed and located on the main APREL server R:\NCL\Calibration Equipment\Instrument List May 2013.

This page has been reviewed for content and attested to by signature within this document.

9



**NCL CALIBRATION LABORATORIES**

Calibration File No: DC-1533  
Project Number: BACL-5745

**CERTIFICATE OF CALIBRATION**

It is certified that the equipment identified below has been calibrated in the  
**NCL CALIBRATION LABORATORIES** by qualified personnel following recognized  
procedures and using transfer standards traceable to NRC/NIST.

Validation Dipole  
5800MHz Head & Body

Manufacturer: APREL Laboratories  
Part number: ALS-D-BB-S-2  
Frequency: Broadband  
Serial No: 234-00703

Customer: BACL

Calibrated: 8<sup>th</sup> October 2013  
Released on: 8<sup>th</sup> October 2013

This Calibration Certificate is Incomplete Unless Accompanied with the Calibration Results Summary

Released By:



Art Brennan, Quality Manager

**NCL CALIBRATION LABORATORIES**

303 Terry Fox Drive, Suite 102  
Kanata, Ontario  
CANADA, K2K 3J1

Division of APREL  
TEL: (613) 435-8300  
FAX: (613) 435-8306

**NCL Calibration Laboratories**

Division of APREL Inc.

**Conditions**

Dipole 234-00703 was an original calibration. New taken from stock

Ambient Temperature of the Laboratory: 22 °C +/- 0.5°C  
Temperature of the Tissue: 21 °C +/- 0.5°C

We the undersigned attest that to the best of our knowledge the calibration of this subject has been accurately conducted and that all information contained within the results pages have been reviewed for accuracy.



Art Brennan, Quality Manager



Dan Brooks, Test Engineer

This page has been reviewed for content and attested to by signature within this document.

**NCL Calibration Laboratories**

Division of APREL Inc.

**Calibration Results Summary**

The following results relate the Calibrated Dipole and should be used as a quick reference for the user.

**Mechanical Dimensions**

Length: 22.1 mm  
 Height: 18.5 mm

**Electrical Calibration**

Test	Result Head	Result Body
S11 R/L	-29.875 dB	-28.296 dB
SWR	1.067 U	1.081 U
Impedance	52.630 Ω	52.731 Ω

**System Validation Results**

Frequency 5600 MHz	1 Gram	10 Gram
Head	67.19	21.34
Body	64.59	19.72

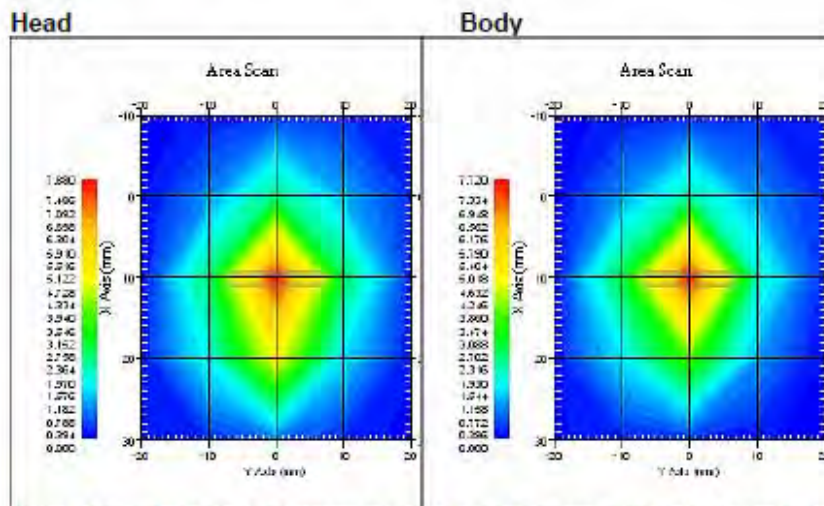

Note: APREL dipoles for SAR measurements above 5 GHz are calibrated referring the target 1 g and 10 g SAR numbers as a result of numerical simulation utilizing XFDTD method (Remcom Inc.) for the configuration of APREL dipoles and Uni- and Flat Phantoms.

This page has been reviewed for content and attested to by signature within this document.

**NCL Calibration Laboratories**

Division of APREL Inc.

**Introduction**

This Calibration Report has been produced in line with the SSI Dipole Calibration Procedure SSI-TP-018-ALSAS. The results contained within this report are for Validation Dipole 234-00703. The calibration routine consisted of a three-step process. Step 1 was a mechanical verification of the dipole to ensure that it meets the mechanical specifications. Step 2 was an Electrical Calibration for the Validation Dipole, where the SWR, Impedance, and the Return loss were assessed. Step 3 involved a System Validation using the ALSAS-10U, along with APREL E-030 130 MHz to 26 GHz E-Field Probe Serial Number 215.

**References**

- SSI-TP-018-ALSAS Dipole Calibration Procedure
- SSI-TP-016 Tissue Calibration Procedure
- IEEE 1528 "Recommended Practice for Determining the Peak Spatial-Average Specific Absorption Rate (SAR) in the Human Body Due to Wireless Communications Devices: Experimental Techniques"
- IEC-62209 "Human exposure to radio frequency fields from hand-held and body-mounted wireless communication devices – Human models, instrumentation, and procedures"
- Part 1: "Procedure to determine the Specific Absorption Rate (SAR) for hand-held devices used in close proximity of the ear (frequency range of 300 MHz to 3 GHz)"
- IEC-62209 "Human exposure to radio frequency fields from hand-held and body-mounted wireless communication devices – Human models, instrumentation, and procedures"
- Part 2: "Procedure to determine the Specific Absorption Rate (SAR) for hand-held devices used in close proximity of the ear (frequency range of 30 MHz to 6 GHz)"
- TP-D01-032-E020-V2 E-Field probe calibration procedure
- D22-012-Tissue dielectric tissue calibration procedure
- D28-002-Dipole procedure for validation of SAR system using a dipole
- IEEE 1309 Draft Standard for Calibration of Electromagnetic Field Sensors and Probes, Excluding Antennas, from 9kHz to 40GHz

**Conditions**

Dipole 234-00703 was an original calibration. New taken from stock.

**Ambient Temperature of the Laboratory:** 22 °C +/- 0.5°C  
**Temperature of the Tissue:** 20 °C +/- 0.5°C

This page has been reviewed for content and attested to by signature within this document.

4



**NCL Calibration Laboratories**

Division of APREL Inc.

**Dipole Calibration Results**

**Mechanical Verification**

APREL Length	APREL Height	Measured Length	Measured Height
22.0 mm	18.5 mm	22.1 mm	18.5 mm

**Tissue Validation**

Tissue 5800 MHz	Measured Head	Measured Body
Dielectric constant, $\epsilon_r$	33.2	45.21
Conductivity, $\sigma$ [S/m]	5.15	5.57

**Dipole Calibration uncertainty**

The calibration uncertainty for the dipole is made up of various parameters presented below.

Mechanical	1%
Positioning Error	1.22%
Electrical	1.7%
Tissue	2.2%
Dipole Validation	2.2%

**Combined Standard Uncertainty**      3.88% (7.76% K=2)

**Primary Measurement Standards**

Instrument	Serial Number	Cal due date
Tektronix USB Power Meter	11C940	May 14, 2015
Network Analyzer Anritsu 37347C	002106	Feb. 20, 2015

This page has been reviewed for content and attested to by signature within this document.

**NCL Calibration Laboratories**

Division of APREL Inc.

**Electrical Calibration**

Test	Result Head	Result Body
S11 R/L	-29.875 dB	-28.296 dB
SWR	1.067 U	1.081 U
Impedance	52.630 Ω	52.731 Ω

The Following Graphs are the results as displayed on the Vector Network Analyzer.

**S11 Parameter Return Loss**

**Head**

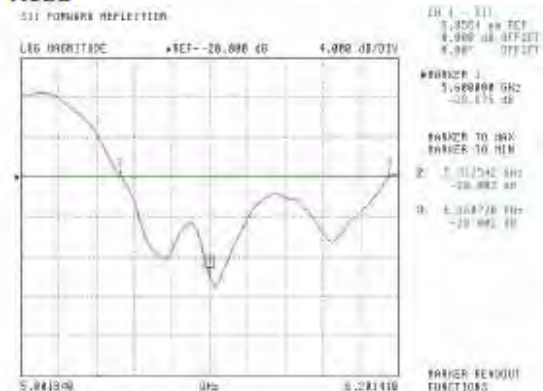

Frequency Range: 5.312 GHz to 6.160 GHz

**Body**

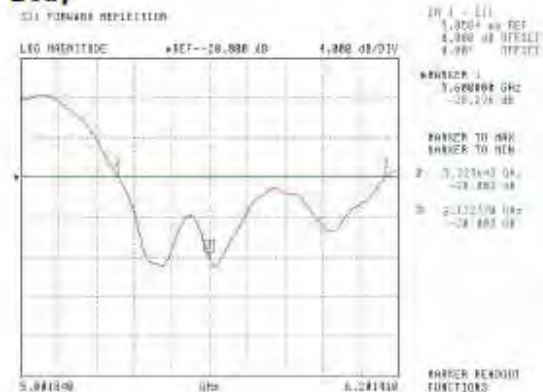

Frequency Range: 5.325 GHz to 6.172 GHz

This page has been reviewed for content and attested to by signature within this document.

**NCL Calibration Laboratories**

Division of APREL Inc.

**SWR**

**Head**

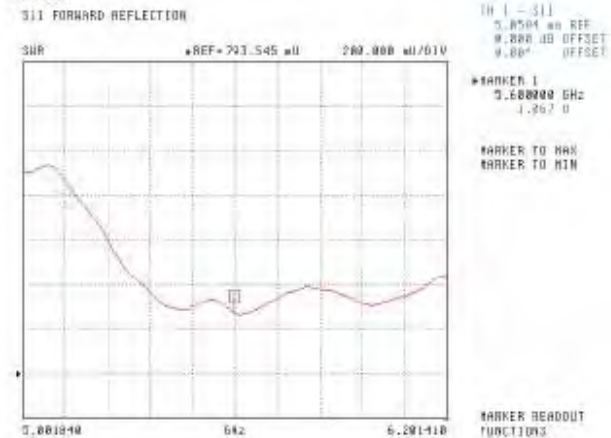

**Body**



This page has been reviewed for content and attested to by signature within this document.

7



**NCL Calibration Laboratories**  
Division of APREL Inc.

**Smith Chart Dipole Impedance**

**Head**

511 FORWARD REFLECTION  
IMPEDANCE

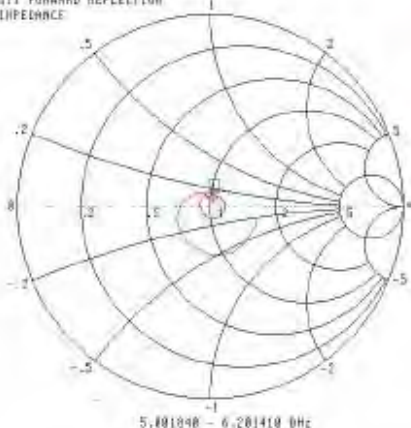

(R | - S11)  
3.8584 SWR REF  
0.888 dB OFFSET  
9.00° OFFSET  
\*MARKER 1  
5.60000 GHz  
57.314 Ω  
1.350 jΩ  
MARKER TO MAX  
MARKER TO MIN

MARKER READOUT  
FUNCTIONS

**Body**

511 FORWARD REFLECTION  
IMPEDANCE

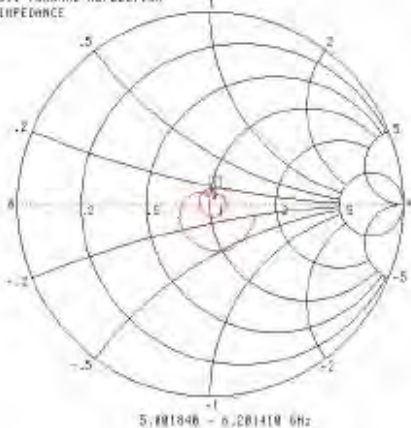

(R | - S11)  
3.8584 SWR REF  
0.888 dB OFFSET  
9.00° OFFSET  
\*MARKER 1  
5.60000 GHz  
57.314 Ω  
1.350 jΩ  
MARKER TO MAX  
MARKER TO MIN

MARKER READOUT  
FUNCTIONS

This page has been reviewed for content and attested to by signature within this document.

**NCL Calibration Laboratories**

Division of APREL Inc.

---

**Test Equipment**

The test equipment used during Probe Calibration, manufacturer, model number and, current calibration status are listed and located on the main APREL server R:\NCL\Calibration Equipment\Instrument List May 2013.

This page has been reviewed for content and attested to by signature within this document.

9

**NCL CALIBRATION LABORATORIES**

Calibration File No: DC-1536  
Project Number: BACL- 5745

**CERTIFICATE OF CALIBRATION**

It is certified that the equipment identified below has been calibrated in the **NCL CALIBRATION LABORATORIES** by qualified personnel following recognized procedures and using transfer standards traceable to NRC/NIST.

Validation Dipole

Manufacturer: APREL Laboratories  
Part number: ALS-D-5800-S-2  
Frequency: 5800 MHz  
Serial No: 240-00855

Customer: Bay Area Compliance Laboratory

Calibrated: 8<sup>th</sup> of October 2013  
Released on: 8<sup>th</sup> of October 2013

This Calibration Certificate is Incomplete Unless Accompanied with the Calibration Results Summary

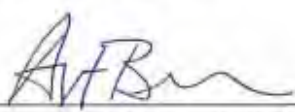
Released By:   
Art Brennan, Quality Manager

**NCL CALIBRATION LABORATORIES**

303 Terry Fox Drive, Suite 102  
Kanata, Ontario  
CANADA K2K 3J1

Division of APREL  
TEL: (613) 435-8300  
FAX: (613) 435-8306

**NCL Calibration Laboratories**

Division of APREL Laboratories.

**Conditions**

Dipole 240-00855 a re-calibration.

**Ambient Temperature of the Laboratory:** 22 °C +/- 0.5°C  
**Temperature of the Tissue:** 21 °C +/- 0.5°C

We the undersigned attest that to the best of our knowledge the calibration of this subject has been accurately conducted and that all information contained within the results pages have been reviewed for accuracy.



Art Brennan, Quality Manager



Dan Brooks, Test Engineer

This page has been reviewed for content and attested to by signature within this document.

**NCL Calibration Laboratories**

Division of APREL Laboratories.

**Calibration Results Summary**

The following results relate the Calibrated Dipole and should be used as a quick reference for the user.

**Mechanical Dimensions**

Length: 20.8 mm  
 Height: 21.0 mm

**Electrical Calibration**

Test	Result Head	Result Body
S11 R/L	-23.009 dB	-22.056 dB
SWR	1.152 U	1.172 U
Impedance	47.800 Ω	47.400 Ω

**System Validation Results**

Frequency	1 Gram	10 Gram
5800 MHz		
Head	61.81	18.9
Body	62.84	19.31

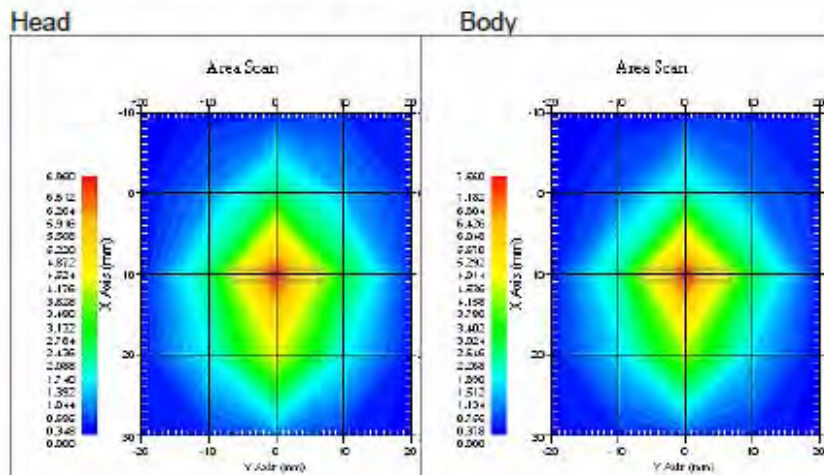

Note: APREL dipoles for SAR measurements above 5 GHz are calibrated referring the target 1 g and 10 g SAR numbers as a result of numerical simulation utilizing XFDTD method (Remcom Inc.) for the configuration of APREL dipoles and Uni- and Flat Phantoms.

This page has been reviewed for content and attested to by signature within this document.



**NCL Calibration Laboratories**

Division of APREL Laboratories.

**Introduction**

This Calibration Report has been produced in line with the SSI Dipole Calibration Procedure SSI-TP-018-ALSAS. The results contained within this report are for Validation Dipole 240-00855. The calibration routine consisted of a three-step process. Step 1 was a mechanical verification of the dipole to ensure that it meets the mechanical specifications. Step 2 was an Electrical Calibration for the Validation Dipole, where the SWR, Impedance, and the Return loss were assessed. Step 3 involved a System Validation using the ALSAS-10U, along with APREL E-020 130 MHz to 26 GHz E-Field Probe Serial Number 212.

**References**

- SSI-TP-018-ALSAS Dipole Calibration Procedure
- SSI-TP-016 Tissue Calibration Procedure
- IEEE 1528 "Recommended Practice for Determining the Peak Spatial-Average Specific Absorption Rate (SAR) in the Human Body Due to Wireless Communications Devices: Experimental Techniques"
- IEC-62209 "Human exposure to radio frequency fields from hand-held and body-mounted wireless communication devices – Human models, instrumentation, and procedures"
- Part 1: "Procedure to determine the Specific Absorption Rate (SAR) for hand-held devices used in close proximity of the ear (frequency range of 300 MHz to 3 GHz)"
- IEC-62209 "Human exposure to radio frequency fields from hand-held and body-mounted wireless communication devices – Human models, instrumentation, and procedures"
- Part 2: "Procedure to determine the Specific Absorption Rate (SAR) for hand-held devices used in close proximity of the ear (frequency range of 30 MHz to 6 GHz)"
- TP-D01-032-E020-V2 E-Field probe calibration procedure
- D22-012-Tissue dielectric tissue calibration procedure
- D28-002-Dipole procedure for validation of SAR system using a dipole
- IEEE 1309 Draft Standard for Calibration of Electromagnetic Field Sensors and Probes, Excluding Antennas, from 9kHz to 40GHz

**Conditions**

Dipole 240-00855 was a re-calibration.

Ambient Temperature of the Laboratory: 22 °C +/- 0.5°C  
Temperature of the Tissue: 20 °C +/- 0.5°C

This page has been reviewed for content and attested to by signature within this document.

4

**NCL Calibration Laboratories**

Division of APREL Laboratories.

**Dipole Calibration Results**

**Mechanical Verification**

APREL Length	APREL Height	Measured Length	Measured Height
21.0 mm	21.0 mm	20.8 mm	21.0 mm

**Tissue Validation**

Tissue 5800 MHz	Measured Head	Measured Body
Dielectric constant, $\epsilon_r$	32.72	44.28
Conductivity, $\sigma$ [S/m]	5.38	6.04

**Dipole Calibration uncertainty**

The calibration uncertainty for the dipole is made up of various parameters presented below.

Mechanical	1%
Positioning Error	1.22%
Electrical	1.7%
Tissue	2.2%
Dipole Validation	2.2%

**Combined Standard Uncertainty**      3.88% (7.76% K=2)

**Primary Measurement Standards**

Instrument	Serial Number	Cal due date
Tektronix USB Power Meter	11C940	May 14, 2015
Network Analyzer Anritsu 37347C	002106	Feb. 20, 2015

This page has been reviewed for content and attested to by signature within this document.



**NCL Calibration Laboratories**

Division of APREL Laboratories.

**Electrical Calibration**

Test	Result Head	Result Body
S11 R/L	-23.009 dB	-22.056 dB
SWR	1.152 U	1.172 U
Impedance	47.800 Ω	47.400 Ω

The Following Graphs are the results as displayed on the Vector Network Analyzer.

**S11 Parameter Return Loss**

**Head**

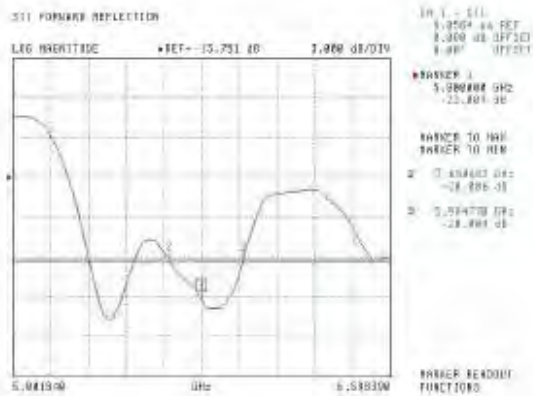

Frequency Range 5650 MHz to 5984 MHz

**Body**

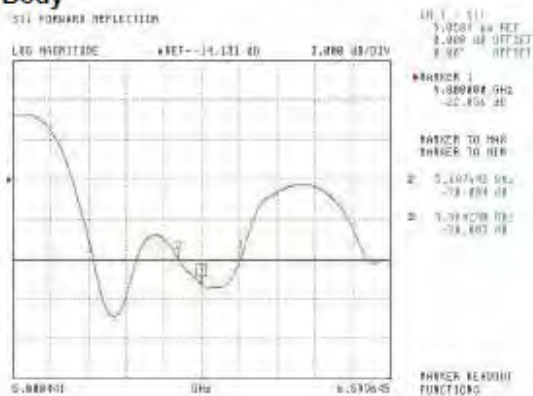

Frequency Range 5687 MHz to 5964 MHz

This page has been reviewed for content and attested to by signature within this document.

**NCL Calibration Laboratories**  
Division of APREL Laboratories.

**SWR**

**Head**



**Body**



This page has been reviewed for content and attested to by signature within this document.

7

**NCL Calibration Laboratories**

Division of APREL Laboratories.

**Smith Chart Dipole Impedance**

**Head**

011 FORWARD REFLECTION  
IMPEDANCE

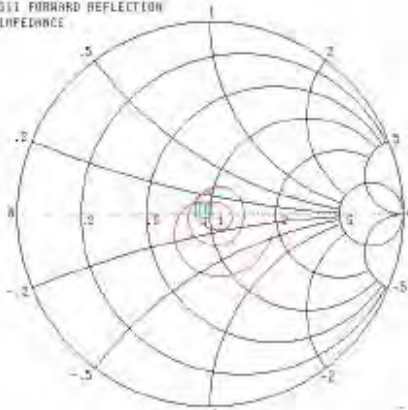

5.601040 - 6.598398 GHz

011 - 011  
5.6504 dB REF  
0.000 dB OFFSET  
0.00° OFFSET

MARKER 1  
5.60000 GHz  
-7.300 Ω  
-6.071 jΩ

MARKER TO MAX  
MARKER TO MIN

MARKER READOUT  
FUNCTIONS

**Body**

011 FORWARD REFLECTION  
IMPEDANCE

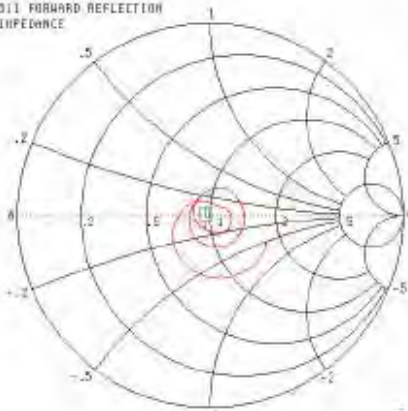

5.600441 - 6.598645 GHz

011 - 011  
5.6504 dB REF  
0.000 dB OFFSET  
0.00° OFFSET

MARKER 1  
5.60000 GHz  
-7.400 Ω  
-7.240 jΩ

MARKER TO MAX  
MARKER TO MIN

MARKER READOUT  
FUNCTIONS

This page has been reviewed for content and attested to by signature within this document.

**NCL Calibration Laboratories**

Division of APREL Laboratories.

---

**Test Equipment**

The test equipment used during Probe Calibration, manufacturer, model number and, current calibration status are listed and located on the main APREL server R:\NCL\Calibration Equipment\Instrument List May 2013.

This page has been reviewed for content and attested to by signature within this document.

9

---

## **APPENDIX D EUT TEST POSITION PHOTOS**

---

Please refer to the report :RSZ150615001-20B

---

## **APPENDIX E EUT PHOTOS**

---

Please refer to the report :RSZ150615001-20B

---

## APPENDIX F INFORMATIVE REFERENCES

---

- [1] Federal Communications Commission, \Report and order: Guidelines for evaluating the environmental effects of radiofrequency radiation", Tech. Rep. FCC 96-326, FCC, Washington, D.C. 20554, 1996.
- [2] David L. Means Kwok Chan, Robert F. Cleveland, \Evaluating compliance with FCC guidelines for human exposure to radiofrequency electromagnetic fields", Tech. Rep., Federal Communication Commission, Office of Engineering & Technology, Washington, DC, 1997.
- [3] Thomas Schmid, Oliver Egger, and Niels Kuster, \Automated E-field scanning system for dosimetricPage 101 of 101 assessments", IEEE Transactions on Microwave Theory and Techniques, vol. 44, pp. 105{113, Jan. 1996.
- [4] Niels Kuster, Ralph Kastle, and Thomas Schmid, \Dosimetric evaluation of mobile communications equipment with known precision", IEICE Transactions on Communications, vol. E80-B, no. 5, pp. 645{652, May 1997.
- [5] CENELEC, \Considerations for evaluating of human exposure to electromagnetic fields (EMFs) from mobile telecommunication equipment (MTE) in the frequency range 30MHz - 6GHz", Tech. Rep., CENELEC, European Committee for Electrotechnical Standardization, Brussels, 1997.
- [6] ANSI, ANSI/IEEE C95.1-1992: IEEE Standard for Safety Levels with Respect to Human Exposure to Radio Frequency Electromagnetic Fields, 3 kHz to 300 GHz, The Institute of Electrical and Electronics Engineers, Inc., New York, NY 10017, 1992.
- [7] Katja Pokovic, Thomas Schmid, and Niels Kuster, \Robust setup for precise calibration of E-field probes in tissue simulating liquids at mobile communications frequencies", in ICECOM \_ 97, Dubrovnik, October 15{17, 1997, pp. 120-24.
- [8] Katja Pokovic, Thomas Schmid, and Niels Kuster, \E-field probe with improved isotropy in brain simulating liquids", in Proceedings of the ELMAR, Zadar, Croatia, 23{25 June, 1996, pp. 172-175.
- [9] Volker Hombach, Klaus Meier, Michael Burkhardt, Eberhard Kuhn, and Niels Kuster, \The dependence of EM energy absorption upon human head modeling at 900 MHz", IEEE Transactions on Microwave Theory and Techniques, vol. 44, no. 10, pp. 1865-1873, Oct. 1996.
- [10] Klaus Meier, Ralf Kastle, Volker Hombach, Roger Tay, and Niels Kuster, \The dependence of EM energy absorption upon human head modeling at 1800 MHz", IEEE Transactions on Microwave Theory and Techniques, Oct. 1997, in press.
- [11] W. Gander, Computermathematik, Birkhaeuser, Basel, 1992.
- [12] W. H. Press, S. A. Teukolsky, W. T. Vetterling, and B. P. Flannery, Numerical Recipes in C, The Art of Scientific Computing, Second Edition, Cambridge University Press, 1992. Dosimetric Evaluation of Sample device, month 1998 9
- [13] NIS81 NAMAS, \The treatment of uncertainty in EMC measurement", Tech. Rep., NAMAS Executive, National Physical Laboratory, Teddington, Middlesex, England, 1994.
- [14] Barry N. Taylor and Christ E. Kuyatt, \Guidelines for evaluating and expressing the uncertainty of NIST measurement results", Tech. Rep., National Institute of Standards and Technology, 1994. Dosimetric Evaluation of Sample device, month 1998 10.

\*\*\*\*\* END OF REPORT \*\*\*\*\*