



FCC RF Test Report

APPLICANT : DT Research Inc.
EQUIPMENT : Mobile Tablet
BRAND NAME : DT Research Inc.
MODEL NAME : DT398H
FCC ID : YE3800C
STANDARD : 47 CFR Part 2, 27
CLASSIFICATION : PCS Licensed Transmitter (PCB)

The product was received on Sep. 16, 2014 and completely tested on Dec. 18, 2014. We, SPORTON INTERNATIONAL INC., would like to declare that the tested sample has been evaluated in accordance with the test procedures given in ANSI / TIA / EIA-603-C-2004 and the testing has shown the tested sample to be in compliance with the applicable technical standards.

The test results in this report apply exclusively to the tested model / sample. Without written approval of SPORTON INTERNATIONAL INC., the test report shall not be reproduced except in full.

Reviewed by: Joseph Lin / Supervisor

Approved by: Jones Tsai / Manager



Testing Laboratory
1190

SPORTON INTERNATIONAL INC.

No. 52, Hwa Ya 1st Rd., Hwa Ya Technology Park, Kwei-Shan Hsiang, Tao Yuan Hsien, Taiwan, R.O.C.

SPORTON INTERNATIONAL INC.
TEL : 886-3-327-3456
FAX : 886-3-328-4978
FCC ID : YE3800C

Page Number : 1 of 20
Report Issued Date : Jan. 06, 2015
Report Version : Rev. 01
Report Template No.: BU5-FGLTE Version 1.3



TABLE OF CONTENTS

REVISION HISTORY..... 3
SUMMARY OF TEST RESULT 4
1 GENERAL DESCRIPTION 5
1.1 Applicant..... 5
1.2 Manufacturer..... 5
1.3 Product Feature of Equipment Under Test..... 5
1.4 Product Specification subjective to this standard 5
1.5 Modification of EUT 5
1.6 Emission Designator..... 6
1.7 Testing Location 7
1.8 Applicable Standards..... 7
2 TEST CONFIGURATION OF EQUIPMENT UNDER TEST 8
2.1 Test Mode..... 8
2.2 Connection Diagram of Test System..... 9
2.3 Support Unit used in test configuration and system 9
2.4 Measurement Results Explanation Example..... 9
3 CONDUCTED TEST ITEMS 10
3.1 Measuring Instruments 10
3.2 Test Setup 10
3.3 Test Result of Conducted Test 10
3.4 Conducted Output Power and ERP/EIRP 11
3.5 Peak-to-Average Ratio 12
3.6 Occupied Bandwidth..... 13
3.7 Conducted Band Edge 14
3.8 Conducted Spurious Emission 15
3.9 Frequency Stability 16
4 RADIATED TEST ITEMS 17
4.1 Measuring Instruments 17
4.2 Test Setup 17
4.3 Test Result of Radiated Test 17
4.4 Radiated Spurious Emission 18
5 LIST OF MEASURING EQUIPMENT 19
6 UNCERTAINTY OF EVALUATION 20
APPENDIX A. TEST RESULTS OF CONDUCTED TEST
APPENDIX B. TEST RESULTS OF RADIATED TEST
APPENDIX C. TEST SETUP PHOTOGRAPHS



REVISION HISTORY

REPORT NO.	VERSION	DESCRIPTION	ISSUED DATE
FG491670B	Rev. 01	Initial issue of report	Jan. 06, 2015



SUMMARY OF TEST RESULT

Report Section	FCC Rule	Description	Limit	Result	Remark
3.4	§2.1046	Conducted Output Power	Reporting Only	PASS	-
3.5	N/A	Peak-to-Average Ratio	<13 dB	PASS	-
3.6	§2.1049 §27.53(h)(3)	Occupied Bandwidth	Reporting Only	PASS	-
3.7	§2.1051 §27.53(c)(2) §27.53(c)(4) §27.53(f) §27.53(g)	Conducted Band Edge Measurement (Band 4) (Band 13)	< 43+10log ₁₀ (P[Watts])	PASS	-
3.8	§2.1051 §27.53(c)(2) §27.53(f) §27.53(g)	Conducted Spurious Emission (Band 4) (Band 13)	< 43+10log ₁₀ (P[Watts])	PASS	-
3.9	§2.1055 §27.54	Frequency Stability Temperature & Voltage	< 2.5 ppm for Part 22 Within Authorized Band	PASS	
4.4	§27.50(b)(10)	Effective Radiated Power (Band 13)	ERP < 3 Watt	PASS	
	§27.50(d)(4)	Equivalent Isotropic Radiated Power (Band 4)	EIRP < 1 Watt		
4.5	§2.1053 §27.53(c)(2) §27.53(f) §27.53(h)	Radiated Spurious Emission (Band 4) (Band 13)	< 43+10log ₁₀ (P[Watts])	PASS	Under limit 9.81 dB at 1568.000 MHz



1 General Description

1.1 Applicant

DT Research Inc.
6F, NO. 1, NingPo E. St., Taipei, 100 Taiwan, R.O.C.

1.2 Manufacturer

DT Research Inc.
6F, NO. 1, NingPo E. St., Taipei, 100 Taiwan, R.O.C.

1.3 Product Feature of Equipment Under Test

Product Feature	
Equipment	Mobile Tablet
Brand Name	DT Research Inc.
Model Name	DT398H
FCC ID	YE3800C
EUT supports Radios application	CDMA/EV-DO/LTE WLAN 11a/b/g/n (HT20/HT40) WLAN 11ac (VHT20/VHT40/VHT80) Bluetooth v4.0 EDR/LE
EUT Stage	Production Unit

1.4 Product Specification subjective to this standard

Product Specification subjective to this standard	
Tx Frequency	LTE Band 4 : 1710.7 MHz ~ 1754.3 MHz LTE Band 13 : 779.5 MHz ~ 784.5 MHz
Rx Frequency	LTE Band 4 : 2110.7 MHz ~ 2154.3 MHz LTE Band 13 : 748.5 MHz ~ 753.5 MHz
Bandwidth	LTE Band 4 : 1.4MHz / 3MHz / 5MHz / 10MHz / 15MHz / 20MHz LTE Band 13 : 5MHz / 10MHz
Maximum Output Power to Antenna	LTE Band 4 : 22.67 dBm LTE Band 13 : 22.88 dBm
Antenna Gain	LTE Band 4 : 1.84 dBi LTE Band 13 : -0.43 dBi
Type of Modulation	QPSK / 16QAM

1.5 Modification of EUT

No modifications are made to the EUT during all test items.



1.6 Emission Designator

LTE Band 4	QPSK			16QAM		
BW(MHz)	Emission Designator (99%OBW)	Frequency Tolerance (ppm)	Maximum EIRP(W)	Emission Designator (99%OBW)	Frequency Tolerance (ppm)	Maximum EIRP(W)
1.4	1M10G7D	-	0.282	1M11W7D	-	0.225
3	2M73G7D	-	0.278	2M73W7D	-	0.226
5	4M50G7D	-	0.280	4M50W7D	-	0.224
10	9M06G7D	0.0107	0.281	9M06W7D	-	0.223
15	13M5G7D	-	0.282	13M5W7D	-	0.224
20	18M6G7D	-	0.282	18M6W7D	-	0.224
LTE Band 13	QPSK			16QAM		
BW(MHz)	Emission Designator (99%OBW)	Frequency Tolerance (ppm)	Maximum ERP(W)	Emission Designator (99%OBW)	-	Maximum ERP(W)
5	4M50G7D	-	0.175	4M50W7D	-	0.140
10	9M00G7D	0.0136	0.176	8M96W7D	-	0.136



1.7 Testing Location

Sporton Lab is accredited to ISO 17025 by Taiwan Accreditation Foundation (TAF code : 1190) and the FCC designation No. TW1022 under the FCC 2.948(e) by Mutual Recognition Agreement (MRA) in FCC Test.

Test Site	SPORTON INTERNATIONAL INC.	
Test Site Location	No. 52, Hwa Ya 1 st Rd., Hwa Ya Technology Park, Kwei-Shan Hsiang, Tao Yuan Hsien, Taiwan, R.O.C. TEL: +886-3-327-3456 FAX: +886-3-328-4978	
Test Site No.	Sporton Site No.	
	TH02-HY	03CH10-HY

1.8 Applicable Standards

According to the specifications of the manufacturer, the EUT must comply with the requirements of the following standards:

- ♦ 47 CFR Part 2, 27
- ♦ ANSI / TIA / EIA-603-C-2004
- ♦ FCC KDB 971168 D01 Power Meas. License Digital Systems v02r02
- ♦ FCC KDB 412172 D01 Determining ERP and EIRP v01

Remark:

1. All test items were verified and recorded according to the standards and without any deviation during the test.
2. This EUT has also been tested and complied with the requirements of FCC Part 15, Subpart B, recorded in a separate test report.



2 Test Configuration of Equipment Under Test

2.1 Test Mode

Antenna port conducted and radiated test items listed below are performed according to KDB 971168 D01 Power Meas. License Digital Systems v02r02 with maximum output power.

Radiated measurements are performed by rotating the EUT in three different orthogonal test planes to find the maximum emission.

Test Items	Band	Bandwidth (MHz)						Modulation		RB #			Test Channel		
		1.4	3	5	10	15	20	QPSK	16QAM	1	Half	Full	L	M	H
Max. Output Power	4	✓	✓	✓	✓	✓	✓	✓	✓	✓	✓	✓	✓	✓	✓
	13	-	-	✓	✓	-	-	✓	✓	✓	✓	✓	✓	✓	✓
Peak-to-Average Ratio	4						✓	✓	✓	✓		✓	✓	✓	✓
	13	-	-		✓	-	-	✓	✓	✓		✓	✓	✓	✓
26dB and 99% Bandwidth	4	✓	✓	✓	✓	✓	✓	✓	✓			✓	✓	✓	✓
	13	-	-	✓	✓	-	-	✓	✓			✓	✓	✓	✓
Conducted Band Edge	4	✓	✓	✓	✓	✓	✓	✓	✓	✓		✓	✓		✓
	13	-	-	✓	✓	-	-	✓	✓	✓		✓	✓		✓
Conducted Spurious Emission	4	✓	✓	✓	✓	✓	✓	✓	✓	✓			✓	✓	✓
	13	-	-	✓	✓	-	-	✓	✓	✓			✓	✓	✓
Frequency Stability	4	✓			✓			✓				✓		✓	
	13	-	-	✓	✓	-	-	✓				✓		✓	
E.R.P./ E.I.R.P.	4	✓					✓	✓	✓	✓			✓	✓	✓
	13	-	-	✓			✓	✓	✓	✓			✓	✓	✓
Radiated Spurious Emission	4	✓	✓	✓	✓	✓	✓	✓		✓			✓	✓	✓
	13	-	-	✓	✓	-	-	✓		✓			✓	✓	✓

Note

- The mark "✓" means that this configuration is chosen for testing
- The mark "-" means that this bandwidth is not supported.
- For E.R.P./E.I.R.P. measurement, the widest bandwidth of each band is chosen for testing due to highest conducted power. Besides, the lowest bandwidth of each band is also measured for reporting only.
- The device is investigated from 30MHz to 10 times of fundamental signal for radiated spurious emission test under different RB size/offset and modulations in exploratory test. Subsequently, only the worst case emissions are reported.

2.2 Connection Diagram of Test System

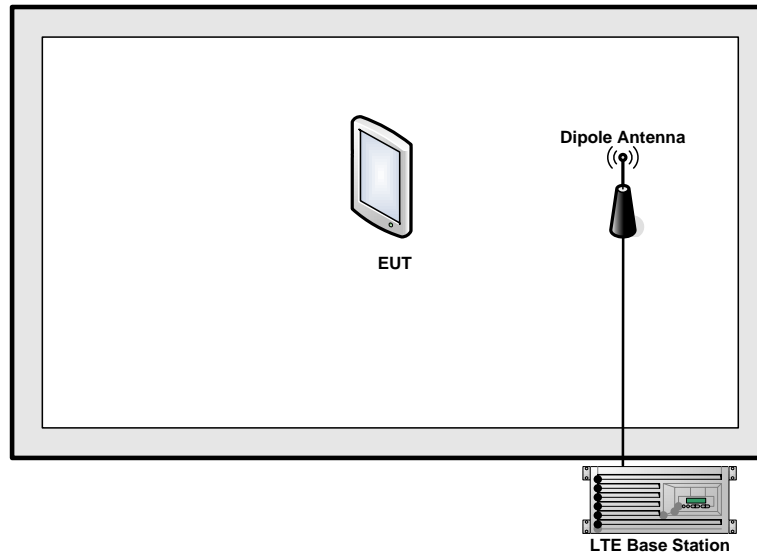

2.3 Support Unit used in test configuration and system

Item	Equipment	Trade Name	Model No.	FCC ID	Data Cable	Power Cord
1.	LTE Base Station	Anritsu	MT8820C	N/A	N/A	Unshielded, 1.8 m

2.4 Measurement Results Explanation Example

For all conducted test items:

The offset level is set in the spectrum analyzer to compensate the RF cable loss and attenuator factor between EUT conducted output port and spectrum analyzer. With the offset compensation, the spectrum analyzer reading level is exactly the EUT RF output level.

The spectrum analyzer offset is derived from RF cable loss and attenuator factor.

Offset = RF cable loss + attenuator factor.

Following shows an offset computation example with cable loss 4.2 dB and 10dB attenuator.

Example :

$$\begin{aligned} \text{Offset(dB)} &= \text{RF cable loss(dB)} + \text{attenuator factor(dB)}. \\ &= 4.2 + 10 = 14.2 \text{ (dB)} \end{aligned}$$

3 Conducted Test Items

3.1 Measuring Instruments

See list of measuring instruments of this test report.

3.2 Test Setup

3.2.1 Conducted Output Power



3.2.2 Peak-to-Average Ratio, Occupied Bandwidth ,Conducted Band-Edge and Conducted Spurious Emission

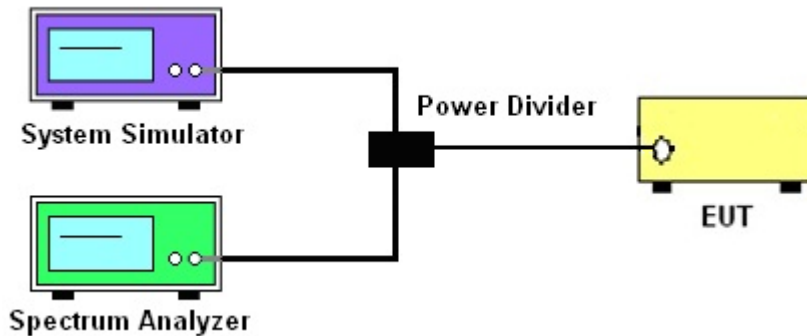

3.2.3 Frequency Stability

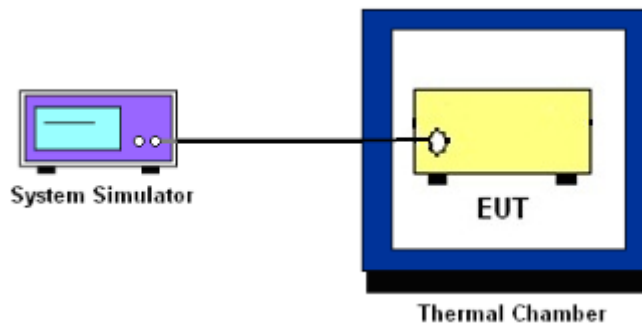

3.3 Test Result of Conducted Test

Please refer to Appendix A.



3.4 Conducted Output Power and ERP/EIRP

3.4.1 Description of the Conducted Output Power Measurement and ERP/EIRP Measurement

A system simulator was used to establish communication with the EUT. Its parameters were set to force the EUT transmitting at maximum output power. The measured power in the radio frequency on the transmitter output terminals shall be reported.

The ERP of mobile transmitters must not exceed 3 Watts for LTE Band 13

The EIRP of mobile transmitters must not exceed 1 Watts for LTE Band 4.

According to KDB 412172 D01 Power Approach,

$EIRP = P_T + G_T - L_C$, $ERP = EIRP - 2.15$, where

P_T = transmitter output power in dBm

G_T = gain of the transmitting antenna in dBi

L_C = signal attenuation in the connecting cable between the transmitter and antenna in dB

3.4.2 Test Procedures

1. The transmitter output port was connected to the system simulator.
2. Set EUT at maximum power through the system simulator.
3. Select lowest, middle, and highest channels for each band and different modulation.
4. Measure and record the power level from the system simulator.



3.5 Peak-to-Average Ratio

3.5.1 Description of the PAR Measurement

Power Complementary Cumulative Distribution Function (CCDF) curves provide a means for characterizing the power peaks of a digitally modulated signal on a statistical basis. A CCDF curve depicts the probability of the peak signal amplitude exceeding the average power level. Most contemporary measurement instrumentation include the capability to produce CCDF curves for an input signal provided that the instrument's resolution bandwidth can be set wide enough to accommodate the entire input signal bandwidth. In measuring transmissions in this band using an average power technique, the peak-to-average ratio (PAR) of the transmission may not exceed 13 dB.

3.5.2 Test Procedures

1. The testing follows FCC KDB 971168 v02r02 Section 5.7.1.
2. The EUT was connected to spectrum and system simulator via a power divider.
3. Set the CCDF (Complementary Cumulative Distribution Function) option in spectrum analyzer.
4. The highest RF powers were measured and recorded the maximum PAPR level associated with a probability of 0.1 %.
5. Record the deviation as Peak to Average Ratio.



3.6 Occupied Bandwidth

3.6.1 Description of Occupied Bandwidth Measurement

The occupied bandwidth is the width of a frequency band such that, below the lower and above the upper frequency limits, the mean powers emitted are each equal to a specified percentage 0.5% of the total mean transmitted power.

The 26 dB emission bandwidth is defined as the frequency range between two points, one above and one below the carrier frequency, at which the spectral density of the emission is attenuated 26 dB below the maximum in-band spectral density of the modulated signal. Spectral density (power per unit bandwidth) is to be measured with a detector of resolution bandwidth equal to approximately 1.0% of the emission bandwidth.

3.6.2 Test Procedures

1. The testing follows FCC KDB 971168 v02r02 Section 4.2.
2. The EUT was connected to spectrum analyzer and system simulator via a power divider.



3.7 Conducted Band Edge

3.7.1 Description of Conducted Band Edge Measurement

27.53 (c) and RSS – 130 for Band 13

For operations in the 776-788 MHz band, the FCC limit is $43 + 10\log_{10}(P[\text{Watts}])$ dB below the transmitter power $P(\text{Watts})$ in a 100 kHz bandwidth. However, in the 100 kHz bands immediately outside and adjacent to the frequency block, a resolution bandwidth of at least 30 kHz may be employed. In addition, the power of any unwanted emissions in any 6.25 kHz bandwidth for all frequencies between 763-775 MHz and 793-806 MHz shall be attenuated below the transmitter power, P (dBW), by at least $65 + 10 \log_{10} p(\text{watts})$, dB, for mobile and portable equipment.

27.53 (h) and RSS – 139 for Band 4

For operations in the 1710 – 1755 MHz band, the FCC limit is $43 + 10\log_{10}(P[\text{Watts}])$ dB below the transmitter power $P(\text{Watts})$ in a 1 MHz bandwidth. However, in the 1MHz bands immediately outside and adjacent to the licensee's frequency block, a resolution bandwidth of at least one percent of the emission bandwidth of the fundamental emission of the transmitter may be employed.

3.7.2 Test Procedures

1. The testing follows FCC KDB 971168 v02r02 Section 6.0.
2. The EUT was connected to spectrum analyzer and system simulator via a power divider.
3. The band edges of low and high channels for the highest RF powers were measured. Set RBW $\geq 1\%$ EBW in the 1MHz band immediately outside and adjacent to the band edge.
4. Set spectrum analyzer with RMS detector.
5. The RF fundamental frequency should be excluded against the limit line in the operating frequency band.
6. The limit line is derived from $43 + 10\log(P)\text{dB}$ below the transmitter power $P(\text{Watts})$
 $= P(\text{W}) - [43 + 10\log(P)] \text{ (dB)}$
 $= [30 + 10\log(P)] \text{ (dBm)} - [43 + 10\log(P)] \text{ (dB)}$
 $= -13\text{dBm}.$



3.8 Conducted Spurious Emission

3.8.1 Description of Conducted Spurious Emission Measurement

The power of any emission outside of the authorized operating frequency ranges must be lower than the transmitter power (P) by a factor of at least $43 + 10 \log (P)$ dB.

It is measured by means of a calibrated spectrum analyzer and scanned from 30 MHz up to a frequency including its 10th harmonic.

3.8.2 Test Procedures

1. The testing follows FCC KDB 971168 v02r02 Section 6.0.
2. The EUT was connected to spectrum analyzer and system simulator via a power divider.
3. The RF output of EUT was connected to the spectrum analyzer by RF cable and attenuator. The path loss was compensated to the results for each measurement.
4. The middle channel for the highest RF power within the transmitting frequency was measured.
5. The conducted spurious emission for the whole frequency range was taken.
6. Make the measurement with the spectrum analyzer's RBW = 1MHz, VBW = 3MHz, taking the record of maximum spurious emission.
7. The RF fundamental frequency should be excluded against the limit line in the operating frequency band.
8. The limit line is derived from $43 + 10\log(P)$ dB below the transmitter power P(Watts)
= P(W)- [43 + 10log(P)] (dB)
= [30 + 10log(P)] (dBm) - [43 + 10log(P)] (dB)
= -13dBm.



3.9 Frequency Stability

3.9.1 Description of Frequency Stability Measurement

The frequency stability shall be measured by variation of ambient temperature and variation of primary supply voltage to ensure that the fundamental emission stays within the authorized frequency block. The frequency stability of the transmitter shall be maintained within $\pm 0.00025\%$ ($\pm 2.5\text{ppm}$) of the center frequency.

3.9.2 Test Procedures for Temperature Variation

1. The EUT was set up in the thermal chamber and connected with the system simulator.
2. With power OFF, the temperature was decreased to -30°C and the EUT was stabilized before testing. Power was applied and the maximum change in frequency was recorded within one minute.
3. With power OFF, the temperature was raised in 10°C step up to 50°C . The EUT was stabilized at each step for at least half an hour. Power was applied and the maximum frequency change was recorded within one minute.

3.9.3 Test Procedures for Voltage Variation

1. The testing follows FCC KDB 971168 v02r02 Section 9.0.
2. The EUT was placed in a temperature chamber at $25\pm 5^{\circ}\text{C}$ and connected with the system simulator.
3. The power supply voltage to the EUT was varied from 85% to 115% of the nominal value measured at the input to the EUT.
4. The variation in frequency was measured for the worst case.

4 Radiated Test Items

4.1 Measuring Instruments

See list of measuring instruments of this test report.

4.2 Test Setup

4.2.1 For radiated test from 30MHz to 1GHz

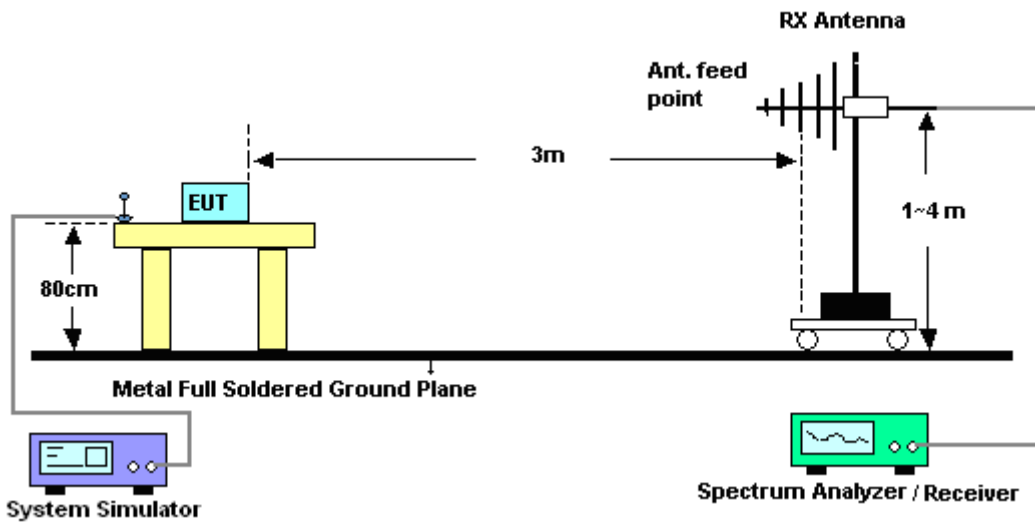

4.2.2 For radiated test above 1GHz

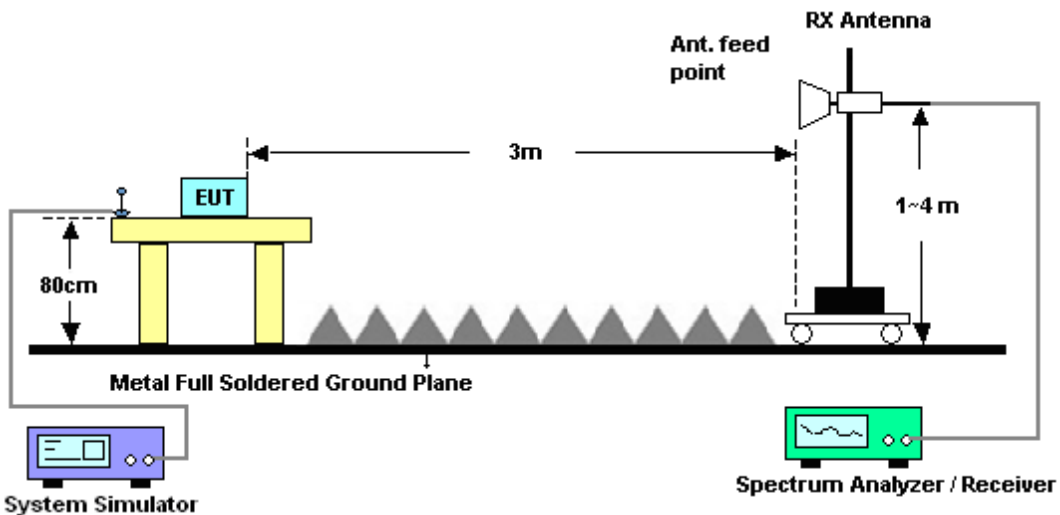

4.3 Test Result of Radiated Test

Please refer to Appendix B.



4.4 Radiated Spurious Emission

4.4.1 Description of Radiated Spurious Emission

The radiated spurious emission was measured by substitution method according to ANSI / TIA / EIA-603-C-2004. The power of any emission outside of the authorized operating frequency ranges must be attenuated below the transmitter power (P) by a factor of at least $43 + 10 \log (P)$ dB.

For LTE Band 13

For operations in the 746-758 MHz, 775-788 MHz, and 805-806 MHz bands, emissions in the band 1559-1610 MHz shall be limited to -70 dBW/MHz equivalent isotropically radiated power (EIRP) for wideband signals, and -80 dBW EIRP for discrete emissions of less than 700 Hz bandwidth.

The spectrum is scanned from 30 MHz up to a frequency including its 10th harmonic.

4.4.2 Test Procedures

1. The testing follows FCC KDB 971168 v02r02 Section 5.8 and ANSI / TIA-603-C-2004 Section 2.2.12.
2. The EUT was placed on a rotatable wooden table with 0.8 meter above ground.
3. The EUT was set 3 meters from the receiving antenna, which was mounted on the antenna tower.
4. The table was rotated 360 degrees to determine the position of the highest spurious emission.
5. The height of the receiving antenna is varied between one meter and four meters to search the maximum spurious emission for both horizontal and vertical polarizations.
6. Make the measurement with the spectrum analyzer's RBW = 1MHz, VBW = 3MHz, taking the record of maximum spurious emission.
7. A horn antenna was substituted in place of the EUT and was driven by a signal generator.
8. Tune the output power of signal generator to the same emission level with EUT maximum spurious emission.
9. Taking the record of output power at antenna port.
10. Repeat step 7 to step 8 for another polarization.
11. The RF fundamental frequency should be excluded against the limit line in the operating frequency band.

The limit line is derived from $43 + 10\log(P)$ dB below the transmitter power P(Watts)
 $= P(W) - [43 + 10\log(P)]$ (dB)
 $= [30 + 10\log(P)]$ (dBm) - $[43 + 10\log(P)]$ (dB)
 $= -13$ dBm.

12. $EIRP$ (dBm) = S.G. Power – Tx Cable Loss + Tx Antenna Gain
13. ERP (dBm) = $EIRP - 2.15$



5 List of Measuring Equipment

Instrument	Manufacturer	Model No.	Serial No.	Characteristics	Calibration Date	Test Date	Due Date	Remark
Spectrum Analyzer	Rohde & Schwarz	FSP40	100055	9kHz~40GHz	Jun. 09, 2014	Dec. 02, 2014~ Dec. 03, 2014	Jun. 08, 2015	Conducted (TH02-HY)
Thermal Chamber	Ten Billion	TTH-D3SP	TBN-930701	N/A	Jul. 17, 2014	Dec. 02, 2014~ Dec. 03, 2014	Jul. 16, 2015	Conducted (TH02-HY)
LTE Base Station	Anritsu	MT8820C	6201026480	30MHz~2.7GHz SISO	Jan. 07, 2014	Dec. 02, 2014~ Dec. 03, 2014	Jan. 06, 2015	Conducted (TH02-HY)
Notch Filter	Wainwright	WRCG1710/1755-1690/17	SN2	AWS Band	Oct. 01, 2014	Dec. 15, 2014~ Dec. 18, 2014	Sep. 30, 2015	Radiation (03CH10-HY)
Notch Filter	Wainwright	WRCG824/849-40/8SS	SN35	CDMA 850	Oct. 01, 2014	Dec. 15, 2014~ Dec. 18, 2014	Sep. 30, 2015	Radiation (03CH10-HY)
Notch Filter	Wainwright	WRCT1850/1910-40/8SS	SN21	1900	Oct. 01, 2014	Dec. 15, 2014~ Dec. 18, 2014	Sep. 30, 2015	Radiation (03CH10-HY)
Filter	Wainwright	WLKS1200-8SS	SN3	1.2G Low Pass	Oct. 01, 2014	Dec. 15, 2014~ Dec. 18, 2014	Sep. 30, 2015	Radiation (03CH10-HY)
Filter	Microwave	H3G018G1	SN477220	3.0G High Pass	Oct. 01, 2014	Dec. 15, 2014~ Dec. 18, 2014	Sep. 30, 2015	Radiation (03CH10-HY)
Amplifier	SONOMA	310N	187311	0.1MHz~1000MHz	Nov. 24, 2014	Dec. 15, 2014~ Dec. 18, 2014	Nov. 23, 2015	Radiation (03CH10-HY)
Bilog Antenna	TESEQ	CBL 6111D	35413	30MHz~1GHz	Oct. 24, 2014	Dec. 15, 2014~ Dec. 18, 2014	Oct. 23, 2015	Radiation (03CH10-HY)
Hygrometer	TECPEL	DTM-303B	TP140320	N/A	Nov. 17, 2014	Dec. 15, 2014~ Dec. 18, 2014	Nov. 16, 2015	Radiation (03CH10-HY)
Preamplifier	Keysight	83017A	MY53270078	1GHz~26.5GHz	Nov. 20, 2014	Dec. 15, 2014~ Dec. 18, 2014	Nov. 19, 2015	Radiation (03CH10-HY)
Spectrum Analyzer	Keysight	N9010A	MY54200485	N/A	Oct. 14, 2014	Dec. 15, 2014~ Dec. 18, 2014	Oct. 13, 2015	Radiation (03CH10-HY)
Double Ridged Guide Horn	SCHWARZBECK	BBHA 9120 D	9120D-1325	1GHz ~ 18GHz	Oct. 03, 2014	Dec. 15, 2014~ Dec. 18, 2014	Oct. 02, 2015	Radiation (03CH10-HY)
RF Cable	HUBER + SUHNER	SUCOFLEX 104	MY24956/4 MY24952/4M	30MHz~1GHz	Nov. 06, 2014	Dec. 15, 2014~ Dec. 18, 2014	Nov. 05, 2015	Radiation (03CH10-HY)
RF Cable	HUBER + SUHNER	SUCOFLEX 104	MY249564 MY249524MY	1GHz~25GHz	Nov. 06, 2014	Dec. 15, 2014~ Dec. 18, 2014	Nov. 05, 2015	Radiation (03CH10-HY)
Controller	EMEC	EM 1000	N/A	1m-4m	N/A	Dec. 15, 2014~ Dec. 18, 2014	N/A	Radiation (03CH10-HY)
Antenna Mast	EMEC	AM-BS-4500-B	N/A	N/A	N/A	Dec. 15, 2014~ Dec. 18, 2014	N/A	Radiation (03CH10-HY)
Turn Table	EMEC	TT 2200	N/A	0-360 degree	N/A	Dec. 15, 2014~ Dec. 18, 2014	N/A	Radiation (03CH10-HY)
Filter	Wainwright	WHKX1.5/15G-10SS	SN31	1.5G High Pass	Oct. 01, 2014	Dec. 15, 2014~ Dec. 18, 2014	Sep. 30, 2015	Radiation (03CH10-HY)
Signal Generator	Rohde & Schwarz	SMF100A	101107	100kHz~40GHz	May. 23, 2014	Dec. 15, 2014~ Dec. 18, 2014	May. 22, 2015	Radiation (03CH10-HY)



6 Uncertainty of Evaluation

Uncertainty of Radiated Emission Measurement (30 MHz ~ 1000 MHz)

Measuring Uncertainty for a Level of Confidence of 95% ($U = 2Uc(y)$)	4.90
---	------

Uncertainty of Radiated Emission Measurement (1 GHz ~ 40 GHz)

Measuring Uncertainty for a Level of Confidence of 95% ($U = 2Uc(y)$)	5.50
---	------



Appendix A. Test Results of Conducted Test

Conducted Output Power(Average power)

LTE Band 4 Maximum Average Power [dBm]						
BW [MHz]	RB Size	RB Offset	Mod	Lowest	Middle	Highest
1.4	1	0	QPSK	22.36	22.56	22.48
1.4	1	2		22.41	22.62	22.44
1.4	1	5		22.40	22.66	22.44
1.4	3	0		22.38	22.56	22.46
1.4	3	1		22.42	22.54	22.44
1.4	3	2		22.36	22.58	22.44
1.4	6	0		21.45	21.69	21.52
1.4	1	0	16-QAM	21.37	21.59	21.51
1.4	1	2		21.39	21.64	21.49
1.4	1	5		21.34	21.66	21.48
1.4	3	0		21.45	21.69	21.57
1.4	3	1		21.44	21.65	21.51
1.4	3	2		21.40	21.63	21.54
1.4	6	0		20.40	20.74	20.60
3	1	0	QPSK	22.37	22.54	22.39
3	1	7		22.39	22.60	22.46
3	1	14		22.36	22.59	22.41
3	8	0		21.38	21.69	21.41
3	8	4		21.43	21.66	21.39
3	8	7		21.36	21.66	21.51
3	15	0		21.32	21.59	21.30
3	1	0	16-QAM	21.34	21.59	21.41
3	1	7		21.35	21.62	21.51
3	1	14		21.35	21.70	21.43
3	8	0		20.36	20.58	20.43
3	8	4		20.30	20.58	20.39
3	8	7		20.33	20.60	20.48
3	15	0		20.30	20.58	20.39



LTE Band 4 Maximum Average Power [dBm]						
BW [MHz]	RB Size	RB Offset	Mod	Lowest	Middle	Highest
5	1	0	QPSK	22.35	22.51	22.51
5	1	12		22.33	22.60	22.34
5	1	24		22.39	22.63	22.41
5	12	0		21.41	21.61	21.34
5	12	6		21.35	21.58	21.33
5	12	11		21.40	21.61	21.37
5	25	0		21.22	21.44	21.29
5	1	0	16-QAM	21.40	21.61	21.55
5	1	12		21.39	21.64	21.45
5	1	24		21.39	21.66	21.44
5	12	0		20.41	20.63	20.45
5	12	6		20.38	20.64	20.45
5	12	11		20.41	20.67	20.43
5	25	0		20.23	20.47	20.30
10	1	0	QPSK	22.37	22.60	22.50
10	1	24		22.40	22.64	22.45
10	1	49		22.50	22.54	22.41
10	25	0		21.27	21.44	21.40
10	25	12		21.26	21.47	21.26
10	25	24		21.36	21.50	21.25
10	50	0		21.16	21.38	21.19
10	1	0	16-QAM	21.35	21.64	21.55
10	1	24		21.41	21.65	21.51
10	1	49		21.42	21.57	21.37
10	25	0		20.22	20.43	20.40
10	25	12		20.26	20.46	20.30
10	25	24		20.28	20.53	20.25
10	50	0		20.13	20.33	20.19



LTE Band 4 Maximum Average Power [dBm]						
BW [MHz]	RB Size	RB Offset	Mod	Lowest	Middle	Highest
15	1	0	QPSK	22.42	22.60	22.66
15	1	37		22.46	22.61	22.58
15	1	74		22.50	22.49	22.39
15	36	0		21.25	21.44	21.40
15	36	18		21.27	21.44	21.34
15	36	37		21.28	21.35	21.24
15	75	0		21.29	21.38	21.26
15	1	0	16-QAM	21.41	21.61	21.65
15	1	37		21.48	21.66	21.55
15	1	74		21.47	21.53	21.45
15	36	0		20.24	20.38	20.39
15	36	18		20.28	20.43	20.37
15	36	37		20.24	20.40	20.24
15	75	0		20.23	20.38	20.35
20	1	0	QPSK	22.58	22.67	22.60
20	1	49		22.39	22.59	22.53
20	1	99		22.57	22.50	22.36
20	50	0		21.24	21.35	21.29
20	50	24		21.21	21.33	21.24
20	50	49		21.19	21.30	21.12
20	100	0		21.21	21.44	21.30
20	1	0	16-QAM	21.43	21.54	21.66
20	1	49		21.44	21.66	21.49
20	1	99		21.59	21.55	21.41
20	50	0		20.22	20.30	20.34
20	50	24		20.14	20.33	20.26
20	50	49		20.13	20.27	20.18
20	100	0		20.23	20.36	20.32



LTE Band 13 Maximum Average Power [dBm]						
BW [MHz]	RB Size	RB Offset	Mod	Lowest	Middle	Highest
5	1	0	QPSK	22.40	22.62	22.68
5	1	12		22.50	22.68	22.63
5	1	24		22.87	22.75	22.43
5	12	0		21.56	21.77	21.84
5	12	6		21.60	21.83	21.79
5	12	11		21.79	21.81	21.69
5	25	0		21.56	21.76	21.68
5	1	0	16-QAM	21.48	21.68	21.76
5	1	12		21.60	21.77	21.68
5	1	24		21.88	21.85	21.50
5	12	0		20.59	20.84	20.90
5	12	6		20.67	20.88	20.88
5	12	11		20.85	20.87	20.79
5	25	0		20.56	20.73	20.70
10	1	0	QPSK		22.88	
10	1	24			22.41	
10	1	49			22.49	
10	25	0			21.75	
10	25	12			21.71	
10	25	24			21.74	
10	50	0			21.64	
10	1	0	16-QAM		21.50	
10	1	24			21.76	
10	1	49			21.58	
10	25	0			20.57	
10	25	12			20.77	
10	25	24			20.78	
10	50	0			20.68	



Peak-to-Average Ratio

Mode	LTE Band 4 / 20MHz				
Mod.	QPSK		16QAM		Limit: 13dB
RB Size	1RB	Full RB	1RB	Full RB	Result
Lowest CH	4.17	5.13	5.51	6.03	PASS
Middle CH	3.56	5.61	4.78	6.38	
Highest CH	4.58	5.74	5.83	6.54	

Mode	LTE Band 13 / 10MHz				
Mod.	QPSK		16QAM		Limit: 13dB
RB Size	1RB	Full RB	1RB	Full RB	Result
Lowest CH	-	-	-	-	PASS
Middle CH	4.81	5.26	5.99	5.99	
Highest CH	-	-	-	-	



LTE Band 4 / 20MHz / QPSK

Lowest Channel / 1RB

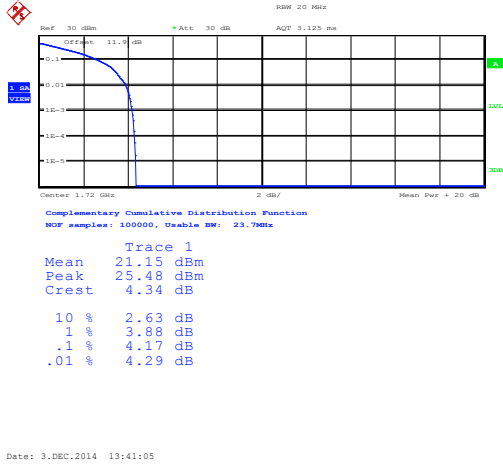

Lowest Channel / Full RB

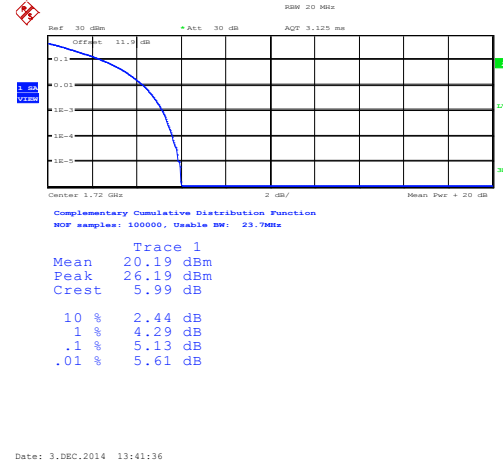

Middle Channel / 1RB

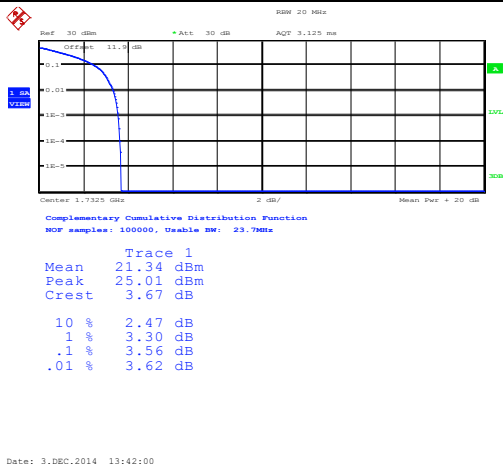

Middle Channel / Full RB

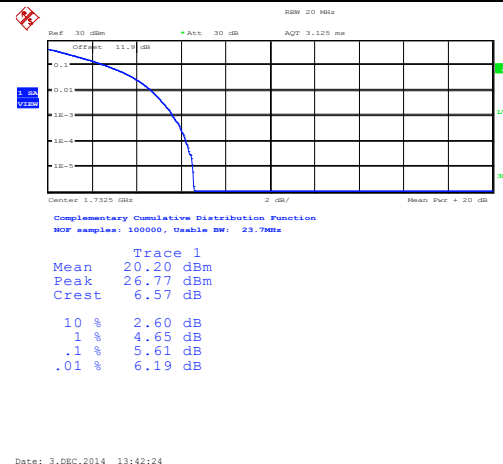

Highest Channel / 1RB

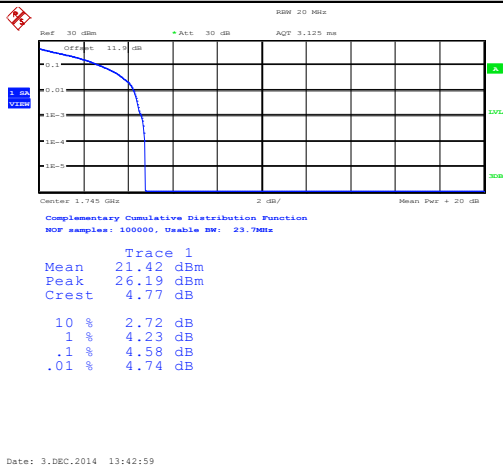

Highest Channel / Full RB

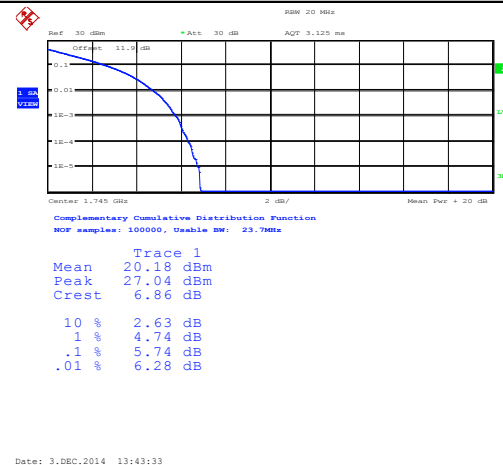



LTE Band 4 / 20MHz / 16QAM

Lowest Channel / 1RB

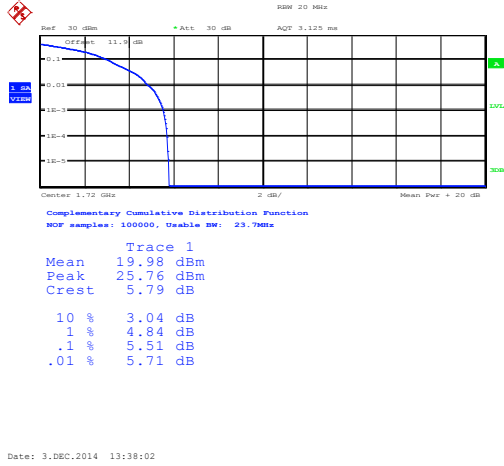

Lowest Channel / Full RB

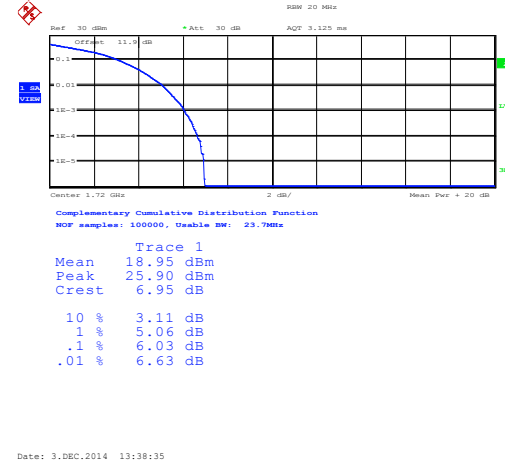

Middle Channel / 1RB

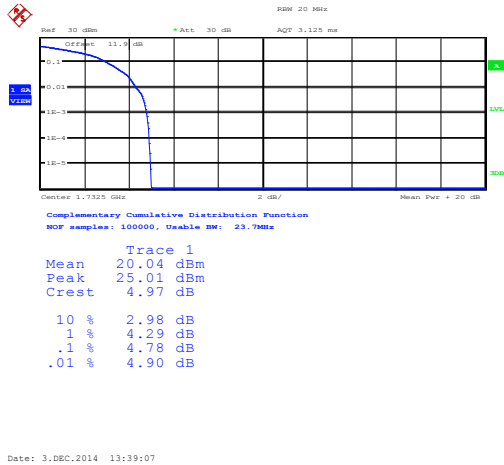

Middle Channel / Full RB

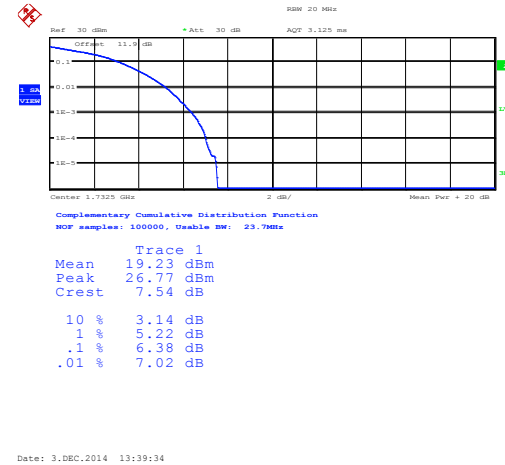

Highest Channel / 1RB

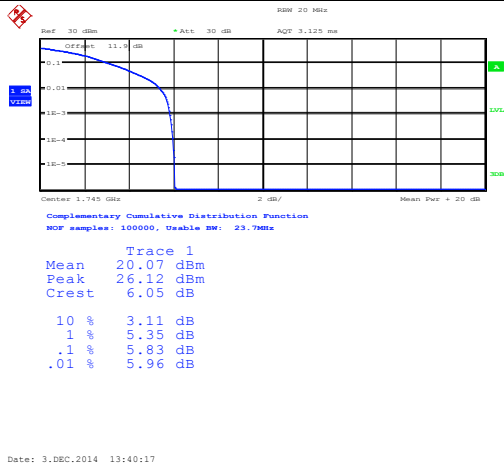

Highest Channel / Full RB

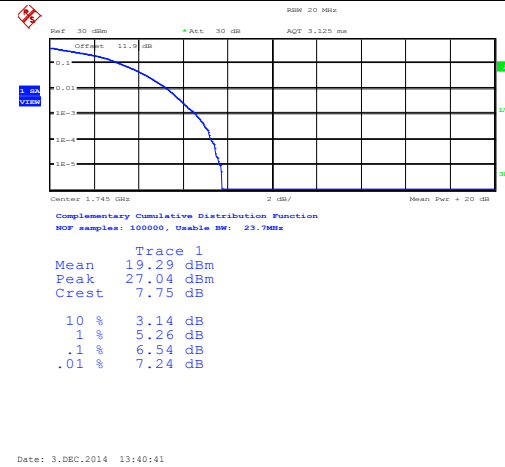



LTE Band 13 / 10MHz / QPSK

Middle Channel/ 1RB

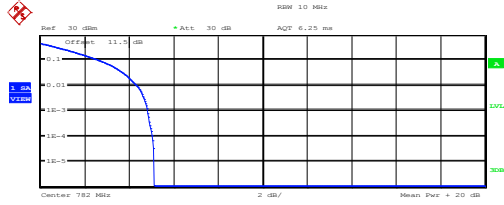

Complementary Cumulative Distribution Function

NOF samples: 100000, Usable BW: 11.2MHz

Trace 1 Mean 22.21 dBm Peak 27.33 dBm Crest 5.12 dB

10 % 2.63 dB 1 % 4.33 dB .1 % 4.81 dB .01 % 5.03 dB

Date: 2.DEC.2014 14:51:13

Middle Channel / Full RB

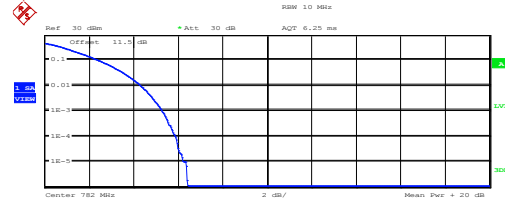

Complementary Cumulative Distribution Function

NOF samples: 100000, Usable BW: 11.2MHz

Trace 1 Mean 21.48 dBm Peak 27.89 dBm Crest 6.41 dB

10 % 2.40 dB 1 % 4.29 dB .1 % 5.26 dB .01 % 5.87 dB

Date: 2.DEC.2014 14:51:47

LTE Band 13 / 10MHz / 16QAM

Middle Channel/ 1RB

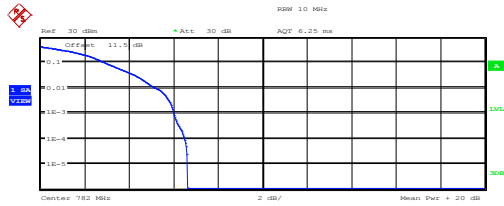

Complementary Cumulative Distribution Function

NOF samples: 100000, Usable BW: 11.2MHz

Trace 1 Mean 21.13 dBm Peak 27.75 dBm Crest 6.63 dB

10 % 2.88 dB 1 % 5.16 dB .1 % 5.99 dB .01 % 6.47 dB

Date: 2.DEC.2014 14:50:25

Middle Channel / Full RB

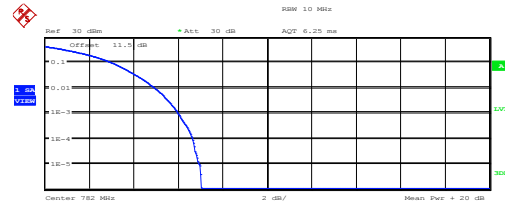

Complementary Cumulative Distribution Function

NOF samples: 100000, Usable BW: 11.2MHz

Trace 1 Mean 20.58 dBm Peak 27.61 dBm Crest 7.04 dB

10 % 3.01 dB 1 % 4.94 dB .1 % 5.99 dB .01 % 6.63 dB

Date: 2.DEC.2014 14:50:51



26dB Bandwidth

Mode	LTE Band 4 : 26dB BW(MHz)											
BW	1.4MHz		3MHz		5MHz		10MHz		15MHz		20MHz	
Mod.	QPSK	16QAM	QPSK	16QAM	QPSK	16QAM	QPSK	16QAM	QPSK	16QAM	QPSK	16QAM
Lowest CH	1.28	1.3	3.05	3.07	5.02	4.97	10.04	10.02	14.82	14.67	20.96	20.76
Middle CH	1.3	1.29	3.1	3.08	5.03	5	10.02	10.12	14.85	14.79	21.12	21
Highest CH	1.29	1.3	3.1	3.1	5	5.02	10.08	10.06	14.85	14.85	21.16	21.12

Mode	LTE Band 13 : 26dB BW(MHz)											
BW	1.4MHz		3MHz		5MHz		10MHz		15MHz		20MHz	
Mod.	QPSK	16QAM	QPSK	16QAM	QPSK	16QAM	QPSK	16QAM	QPSK	16QAM	QPSK	16QAM
Lowest CH	-	-	-	-	5	4.97	-	-	-	-	-	-
Middle CH	-	-	-	-	4.96	4.99	9.98	9.94	-	-	-	-
Highest CH	-	-	-	-	5.01	5.03	-	-	-	-	-	-



LTE Band 4

Lowest Channel / 1.4MHz / QPSK

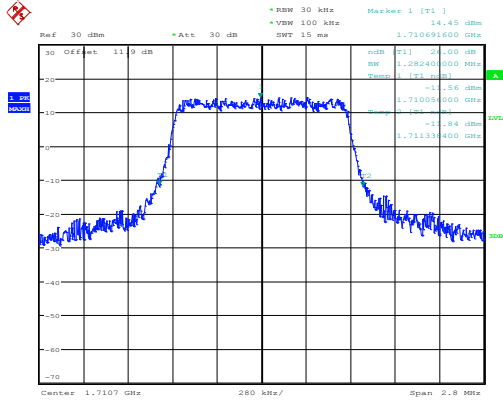

Date: 3.DEC.2014 13:16:40

Lowest Channel / 1.4MHz / 16QAM

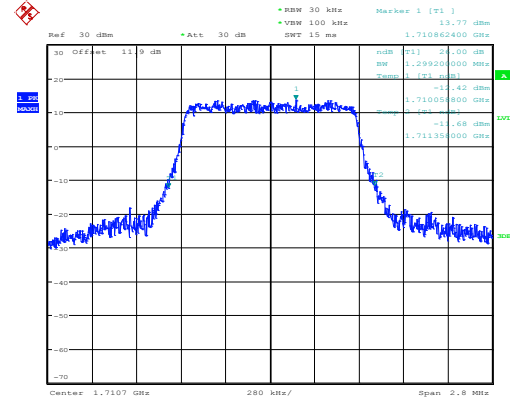

Date: 3.DEC.2014 13:16:53

Middle Channel / 1.4MHz / QPSK

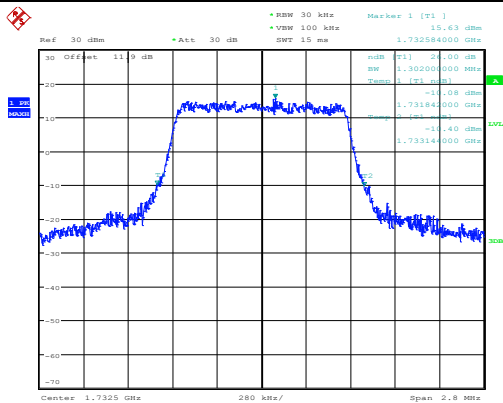

Date: 3.DEC.2014 13:24:26

Middle Channel / 1.4MHz / 16QAM

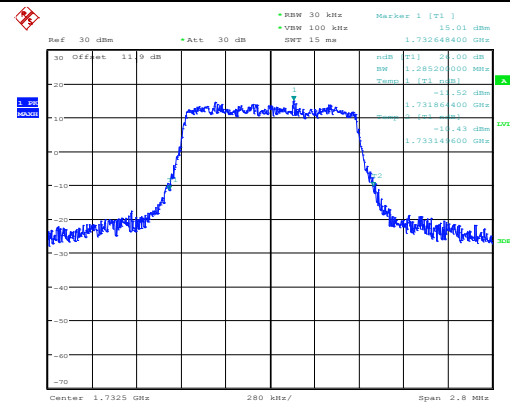

Date: 3.DEC.2014 13:24:39

Highest Channel / 1.4MHz / QPSK

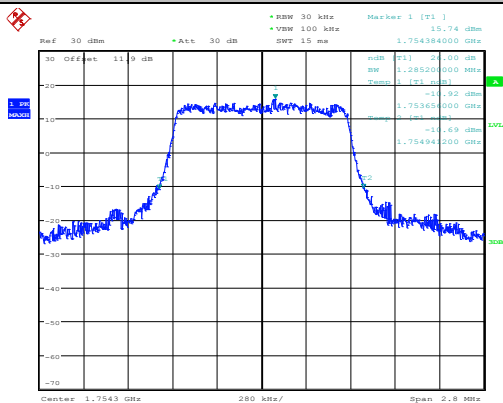

Date: 3.DEC.2014 13:29:13

Highest Channel / 1.4MHz / 16QAM

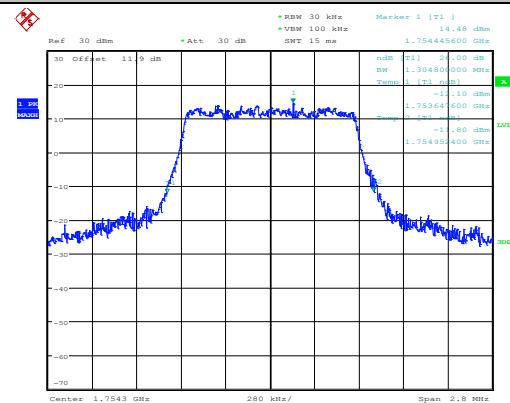

Date: 3.DEC.2014 13:29:26



LTE Band 4

Lowest Channel / 3MHz / QPSK

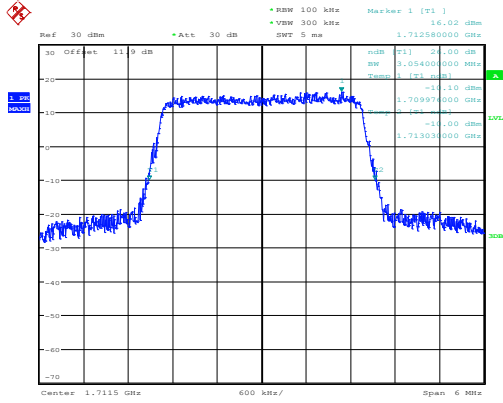

Date: 3.DEC.2014 10:27:35

Lowest Channel / 3MHz / 16QAM

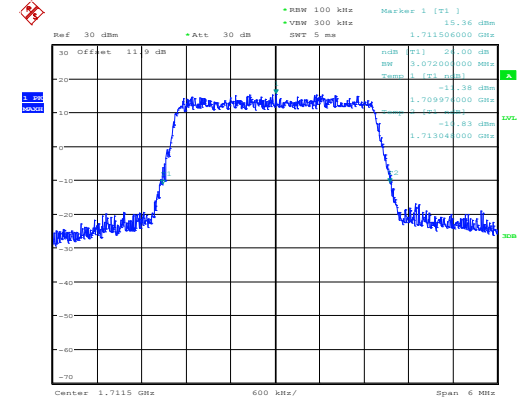

Date: 3.DEC.2014 10:27:47

Middle Channel / 3MHz / QPSK

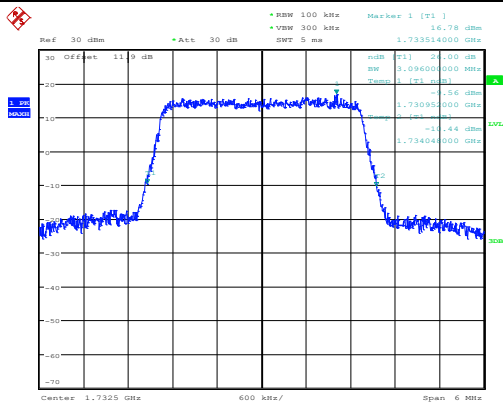

Date: 3.DEC.2014 10:35:21

Middle Channel / 3MHz / 16QAM

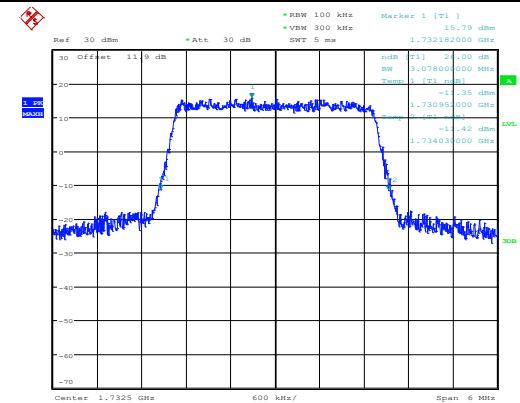

Date: 3.DEC.2014 10:35:34

Highest Channel / 3MHz / QPSK

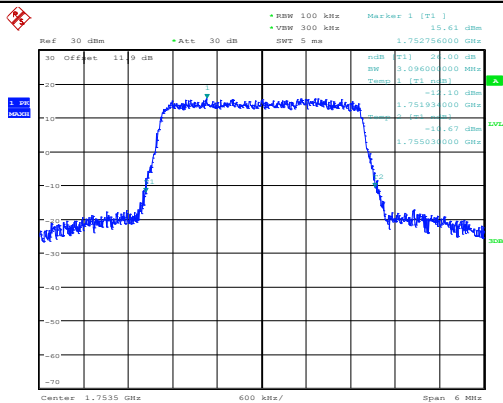

Date: 3.DEC.2014 10:38:29

Highest Channel / 3MHz / 16QAM

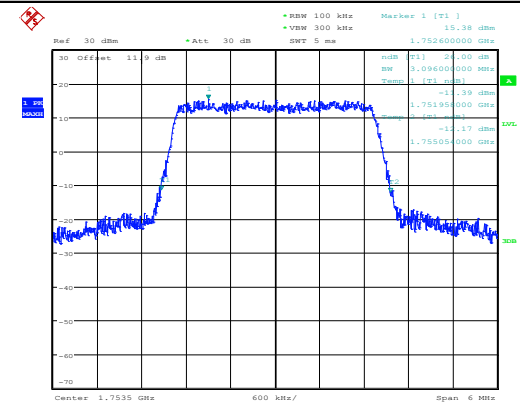

Date: 3.DEC.2014 10:38:41



LTE Band 4

Lowest Channel / 5MHz / QPSK

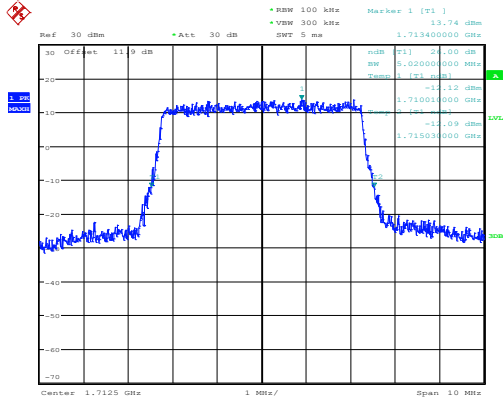

Date: 3.DEC.2014 10:46:20

Lowest Channel / 5MHz / 16QAM

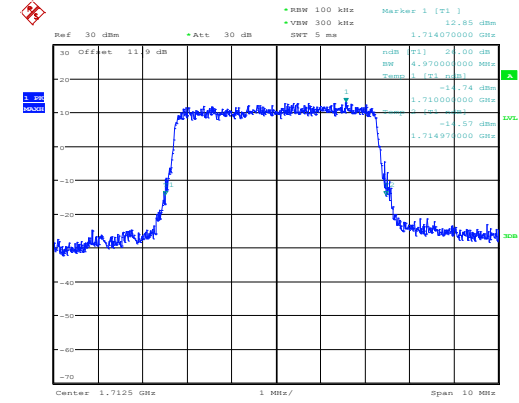

Date: 3.DEC.2014 10:46:33

Middle Channel / 5MHz / QPSK

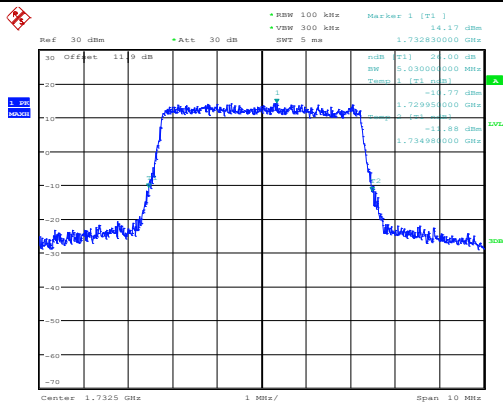

Date: 3.DEC.2014 10:54:06

Middle Channel / 5MHz / 16QAM

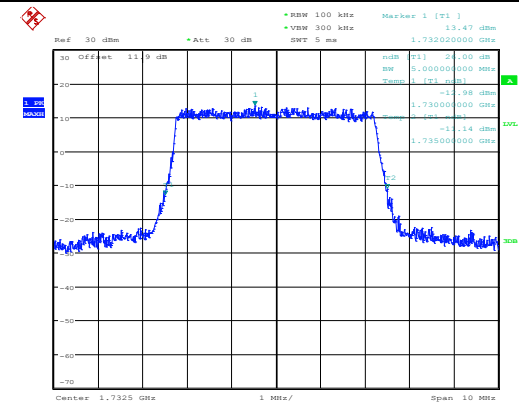

Date: 3.DEC.2014 10:54:19

Highest Channel / 5MHz / QPSK

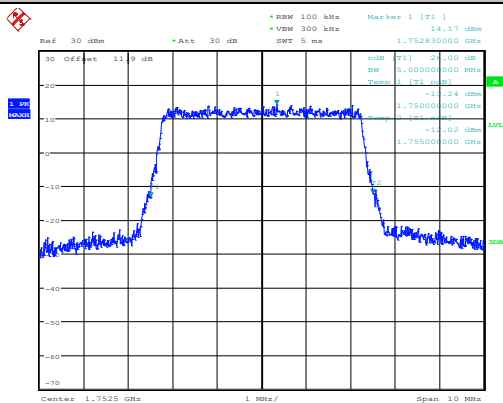

Date: 3.DEC.2014 10:57:14

Highest Channel / 5MHz / 16QAM

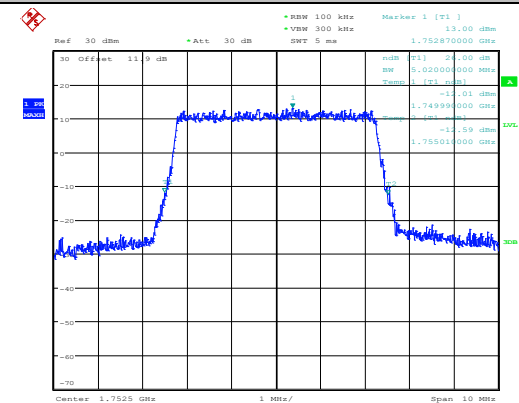

Date: 3.DEC.2014 10:57:26



LTE Band 4

Lowest Channel / 10MHz / QPSK

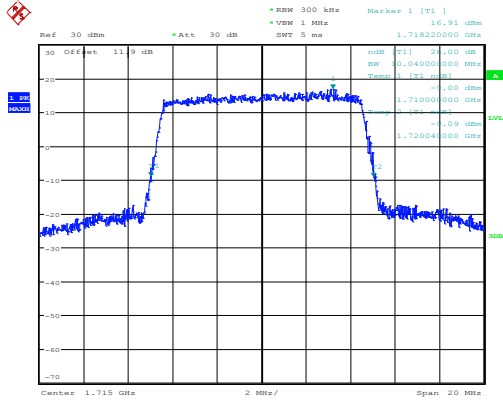

Date: 3.DEC.2014 11:05:05

Lowest Channel / 10MHz / 16QAM

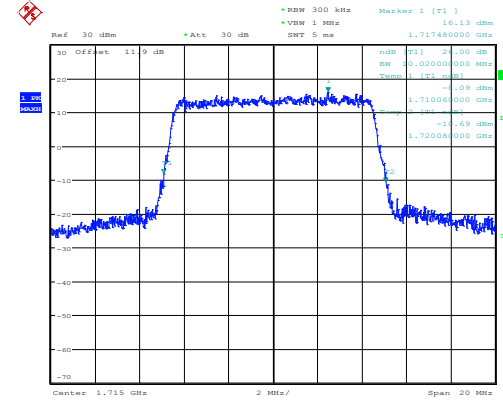

Date: 3.DEC.2014 11:05:17

Middle Channel / 10MHz / QPSK

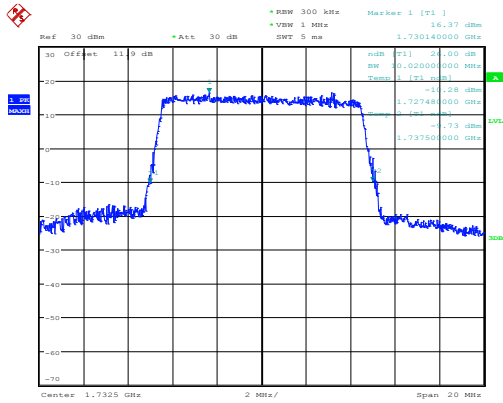

Date: 3.DEC.2014 11:12:51

Middle Channel / 10MHz / 16QAM

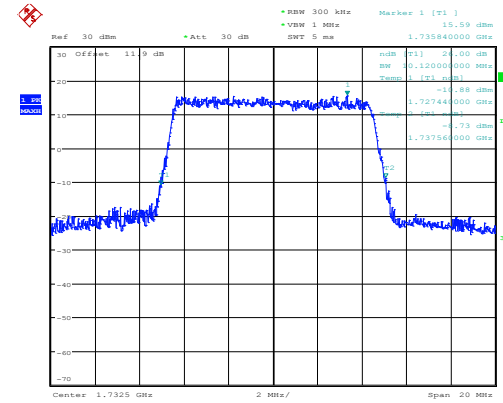

Date: 3.DEC.2014 11:13:04

Highest Channel / 10MHz / QPSK

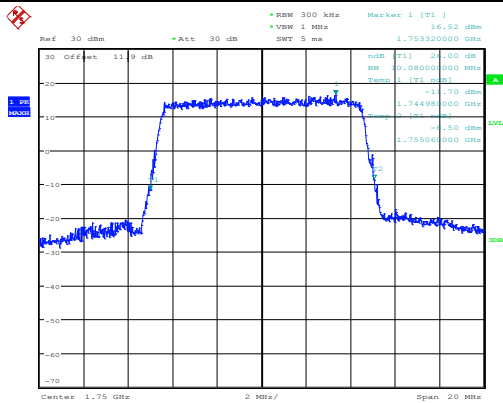

Date: 3.DEC.2014 11:15:59

Highest Channel / 10MHz / 16QAM

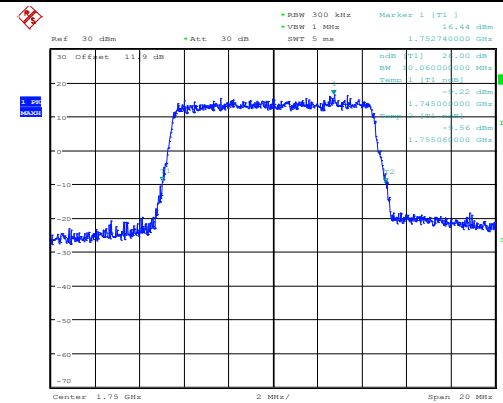

Date: 3.DEC.2014 11:16:11



LTE Band 4

Lowest Channel / 15MHz / QPSK

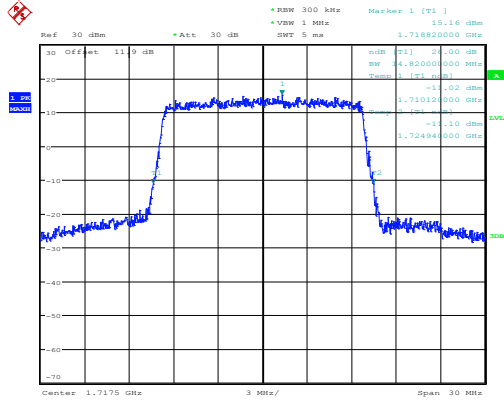

Lowest Channel / 15MHz / 16QAM

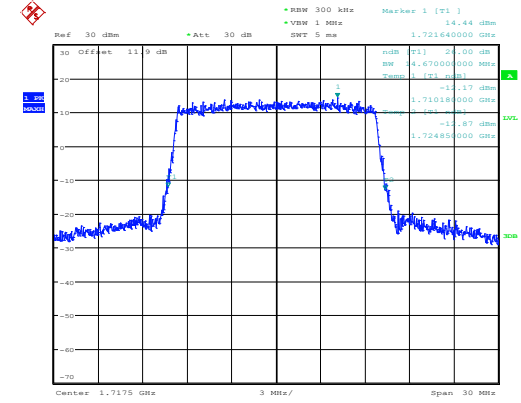

Middle Channel / 15MHz / QPSK

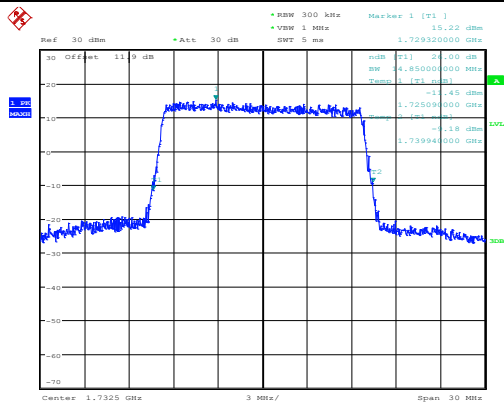

Middle Channel / 15MHz / 16QAM

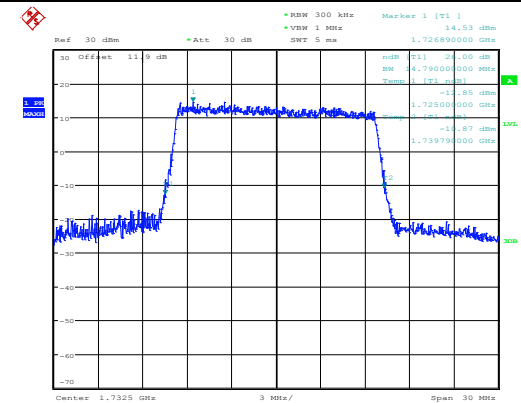

Highest Channel / 15MHz / QPSK

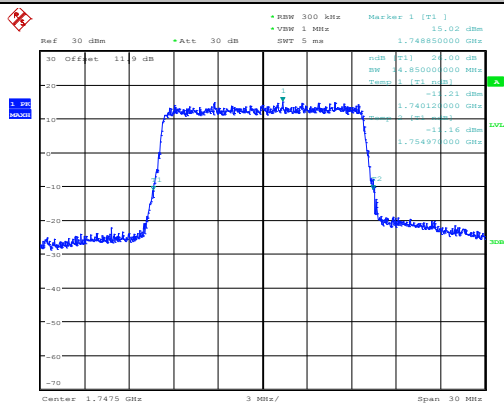

Highest Channel / 15MHz / 16QAM

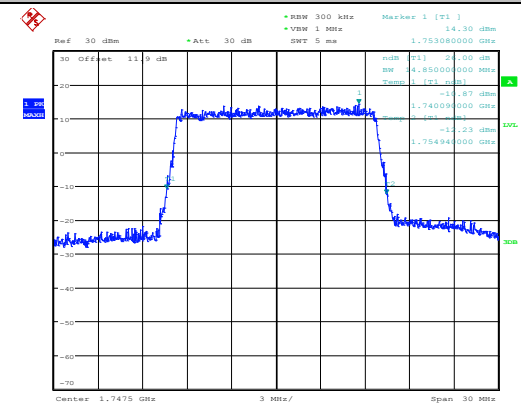



LTE Band 4

Lowest Channel / 20MHz / QPSK

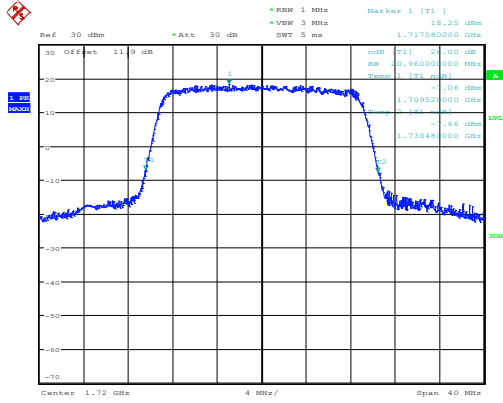

Date: 3.DEC.2014 11:42:35

Lowest Channel / 20MHz / 16QAM

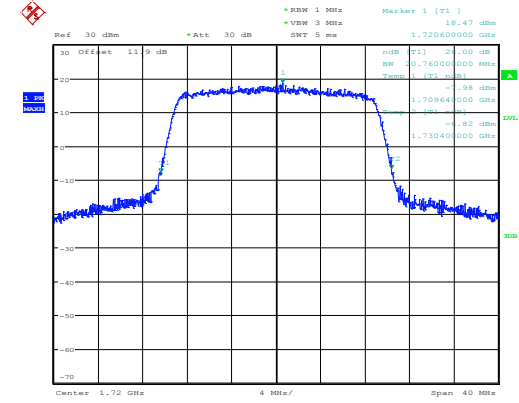

Date: 3.DEC.2014 11:42:47

Middle Channel / 20MHz / QPSK

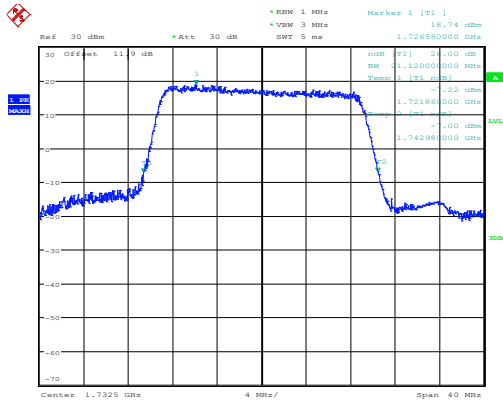

Date: 3.DEC.2014 11:50:28

Middle Channel / 20MHz / 16QAM

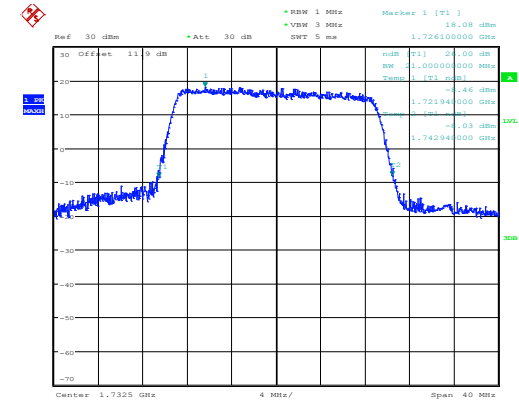

Date: 3.DEC.2014 11:50:41

Highest Channel / 20MHz / QPSK

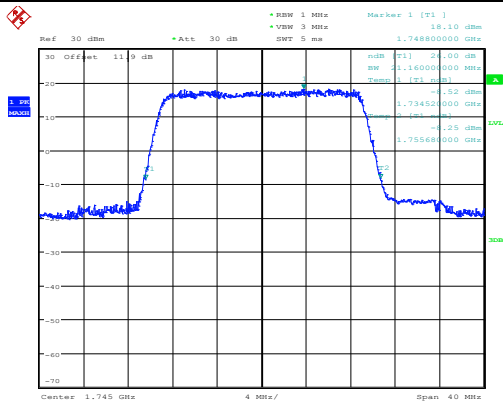

Date: 3.DEC.2014 11:53:35

Highest Channel / 20MHz / 16QAM

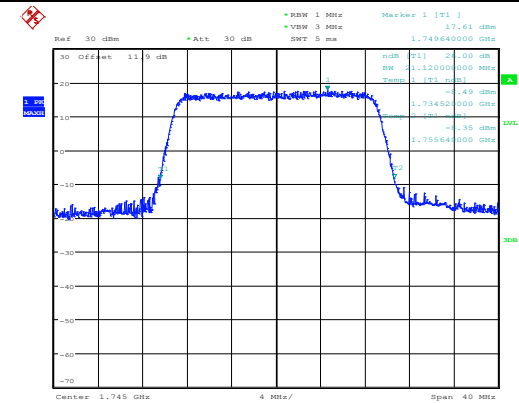

Date: 3.DEC.2014 11:53:48



LTE Band 13

Lowest Channel / 5MHz / QPSK

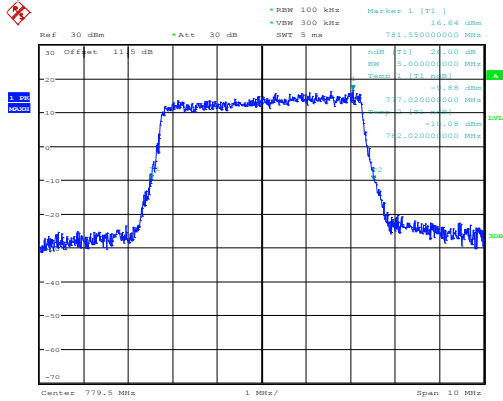

Date: 2.DEC.2014 14:37:37

Lowest Channel / 5MHz / 16QAM

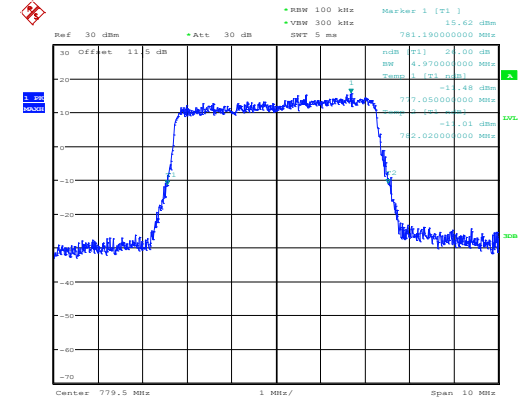

Date: 2.DEC.2014 14:37:24

Middle Channel / 5MHz / QPSK

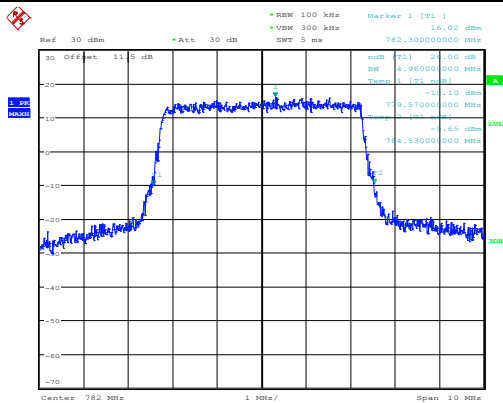

Date: 2.DEC.2014 14:42:32

Middle Channel / 5MHz / 16QAM

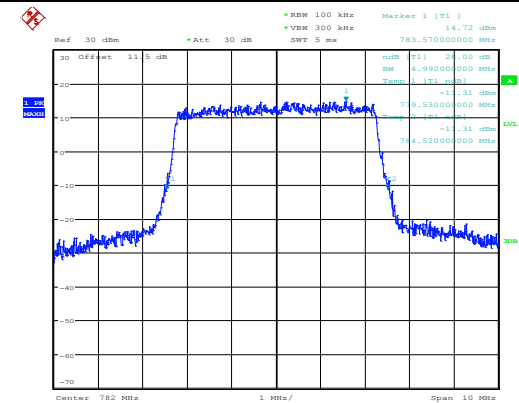

Date: 2.DEC.2014 14:42:45

Highest Channel / 5MHz / QPSK

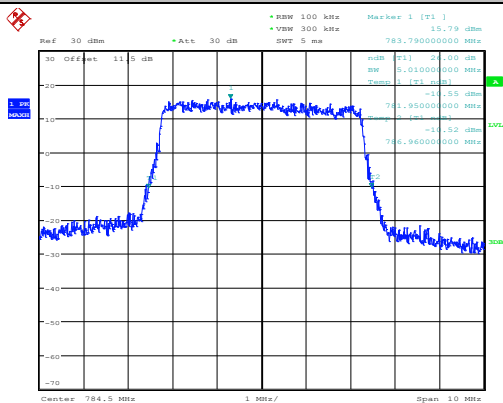

Date: 2.DEC.2014 14:43:53

Highest Channel / 5MHz / 16QAM

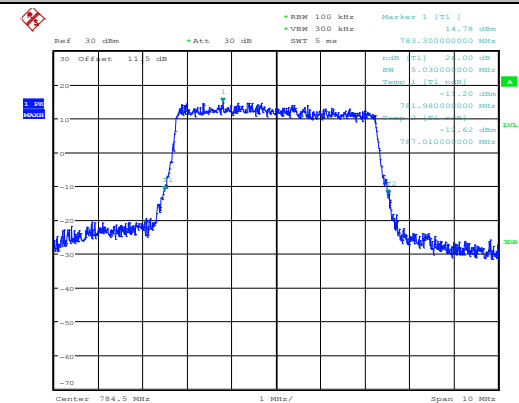

Date: 2.DEC.2014 14:43:41



LTE Band 13

Middle Channel / 10MHz / QPSK

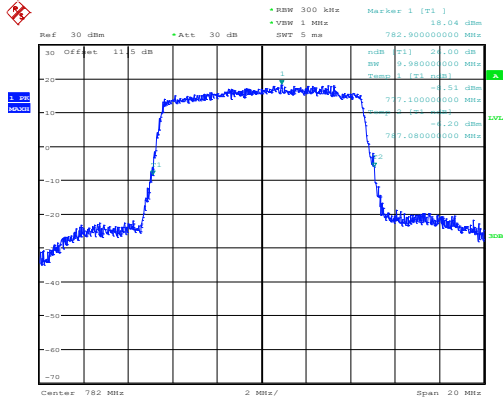

Date: 2.DEC.2014 14:47:06

Middle Channel / 10MHz / 16QAM

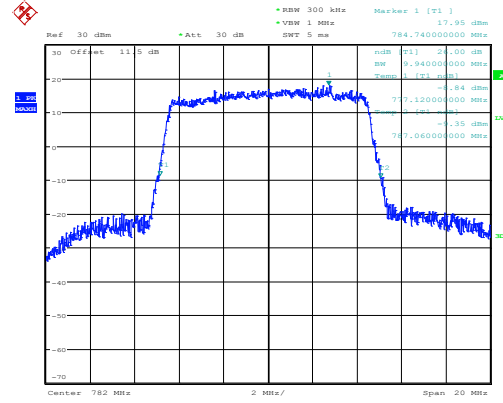

Date: 2.DEC.2014 14:46:53



Occupied Bandwidth

Mode	LTE Band 4 : 99%OBW(MHz)											
	1.4MHz		3MHz		5MHz		10MHz		15MHz		20MHz	
Mod.	QPSK	16QAM	QPSK	16QAM	QPSK	16QAM	QPSK	16QAM	QPSK	16QAM	QPSK	16QAM
Lowest CH	1.1	1.1	2.72	2.72	4.5	4.5	9.06	9.02	13.44	13.44	18.4	18.4
Middle CH	1.1	1.1	2.72	2.72	4.5	4.5	9.04	9.06	13.5	13.47	18.56	18.56
Highest CH	1.1	1.11	2.73	2.73	4.5	4.49	9.06	9.04	13.5	13.5	18.52	18.56

Mode	LTE Band 13 : 99%OBW(MHz)											
	1.4MHz		3MHz		5MHz		10MHz		15MHz		20MHz	
Mod.	QPSK	16QAM	QPSK	16QAM	QPSK	16QAM	QPSK	16QAM	QPSK	16QAM	QPSK	16QAM
Lowest CH	-	-	-	-	4.51	4.49	-	-	-	-	-	-
Middle CH	-	-	-	-	4.49	4.48	9	8.96	-	-	-	-
Highest CH	-	-	-	-	4.49	4.5	-	-	-	-	-	-



LTE Band 4

Lowest Channel / 1.4MHz / QPSK

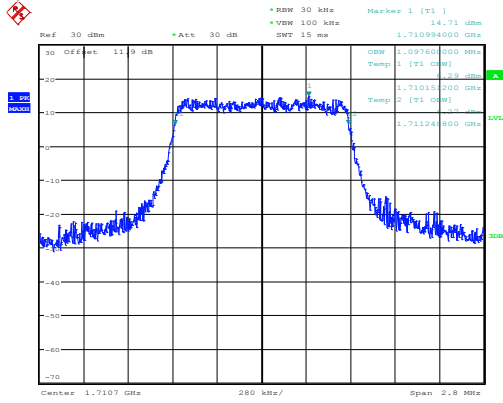

Lowest Channel / 1.4MHz / 16QAM

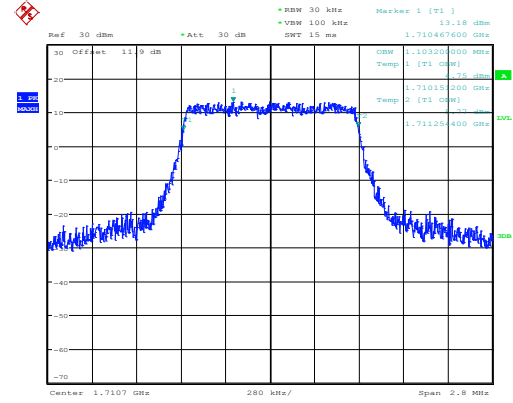

Middle Channel / 1.4MHz / QPSK

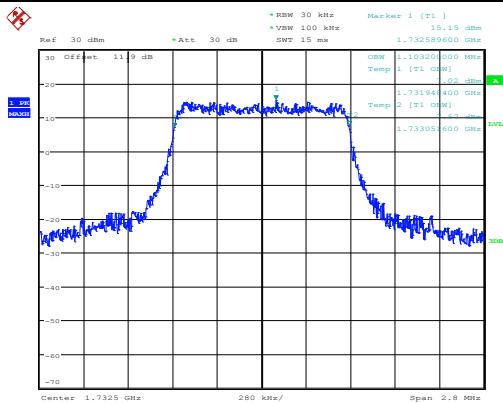

Middle Channel / 1.4MHz / 16QAM

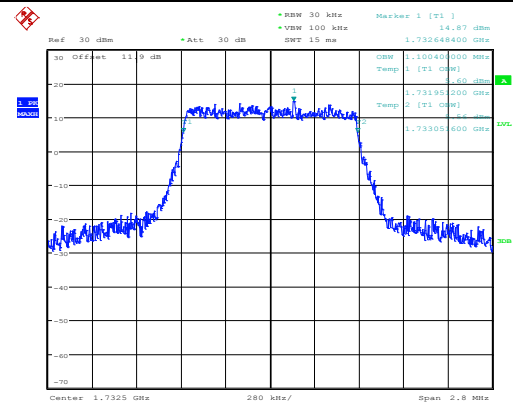

Highest Channel / 1.4MHz / QPSK

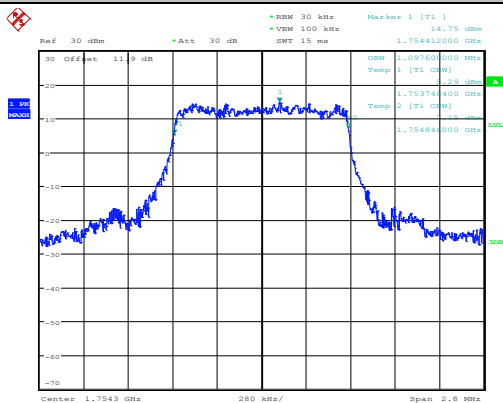

Highest Channel / 1.4MHz / 16QAM

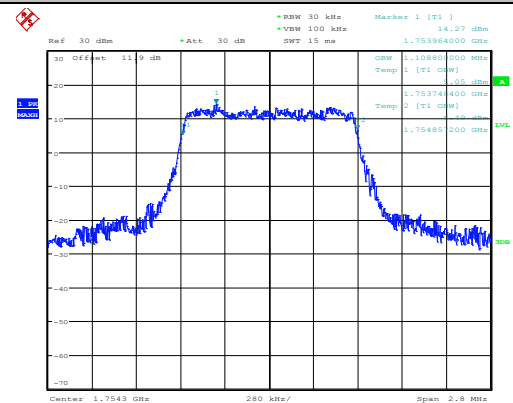



LTE Band 4

Lowest Channel / 3MHz / QPSK

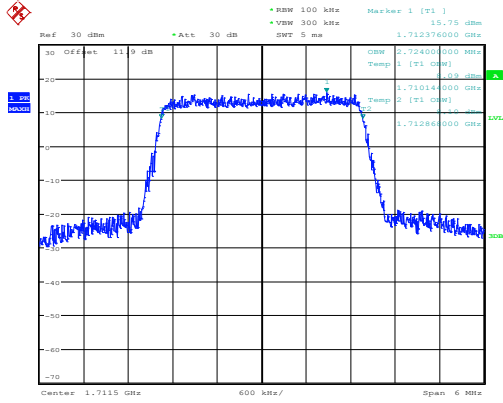

Lowest Channel / 3MHz / 16QAM

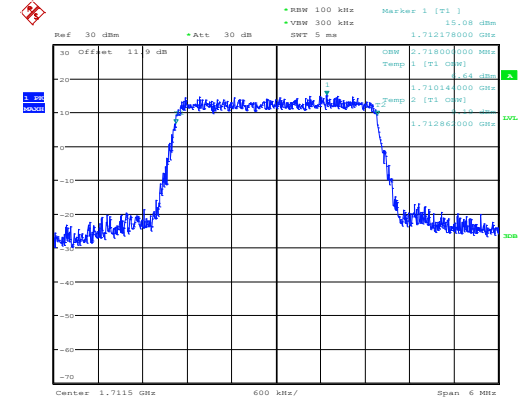

Middle Channel / 3MHz / QPSK

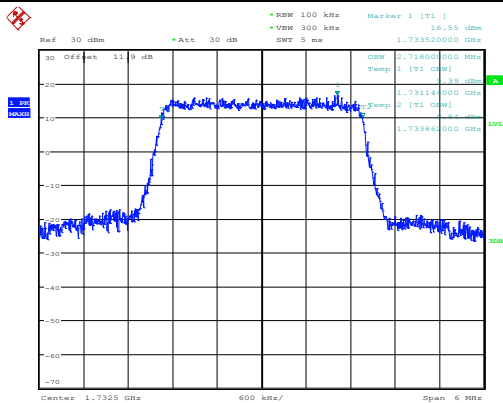

Middle Channel / 3MHz / 16QAM

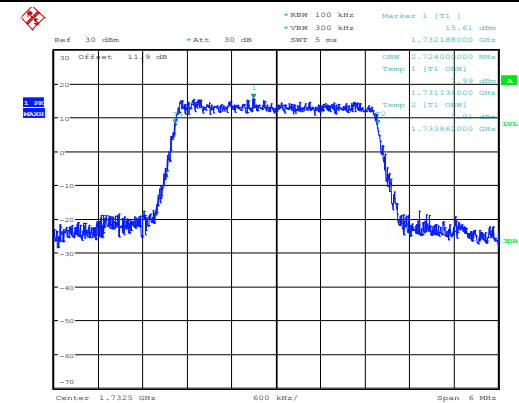

Highest Channel / 3MHz / QPSK

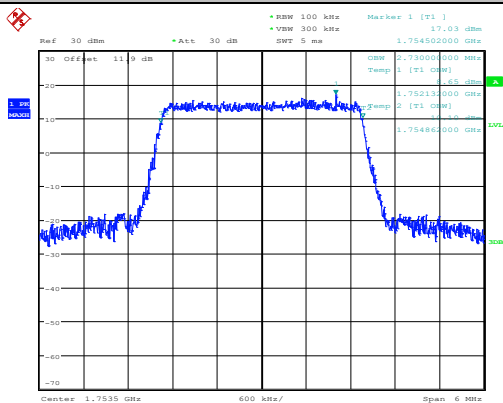

Highest Channel / 3MHz / 16QAM

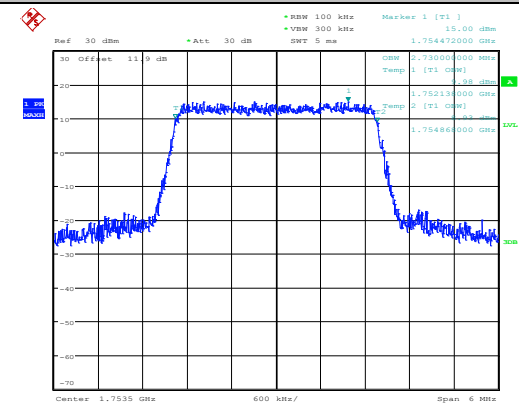



LTE Band 4

Lowest Channel / 5MHz / QPSK

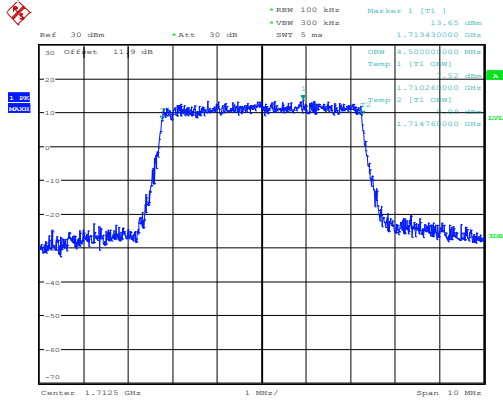

Date: 3.DEC.2014 10:45:56

Lowest Channel / 5MHz / 16QAM

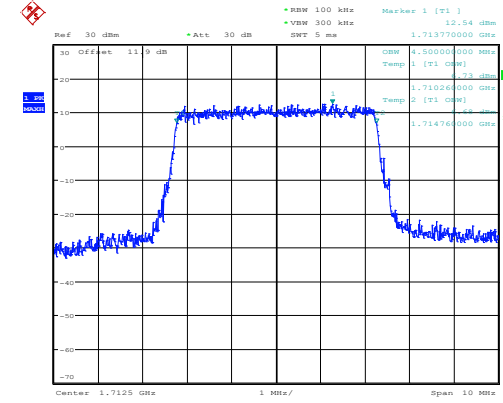

Date: 3.DEC.2014 10:46:07

Middle Channel / 5MHz / QPSK

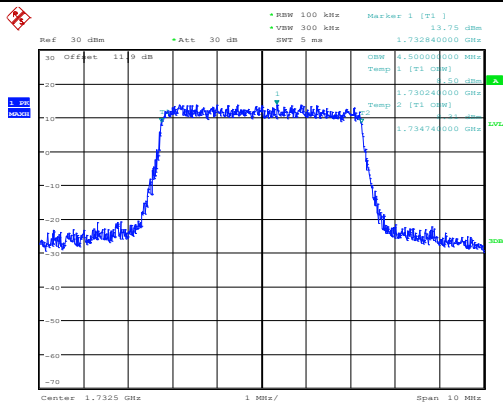

Date: 3.DEC.2014 10:53:43

Middle Channel / 5MHz / 16QAM

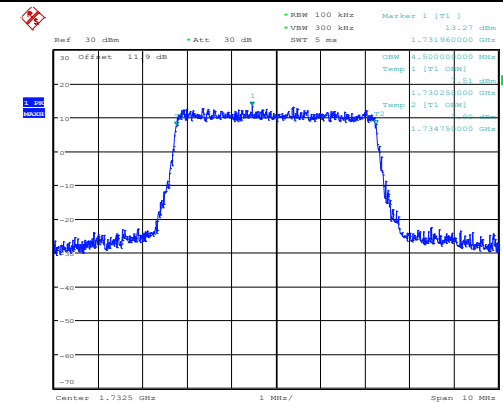

Date: 3.DEC.2014 10:53:54

Highest Channel / 5MHz / QPSK

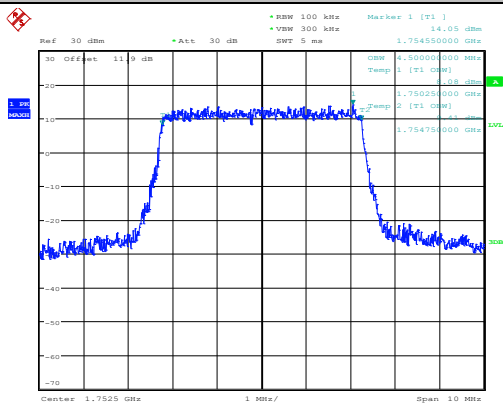

Date: 3.DEC.2014 10:56:50

Highest Channel / 5MHz / 16QAM

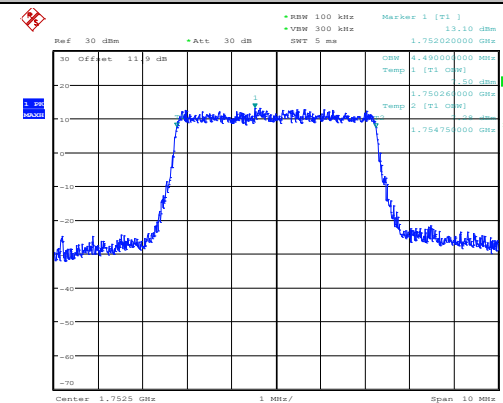

Date: 3.DEC.2014 10:57:01



LTE Band 4

Lowest Channel / 10MHz / QPSK

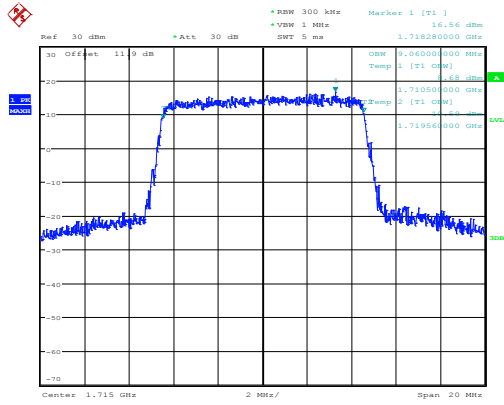

Lowest Channel / 10MHz / 16QAM

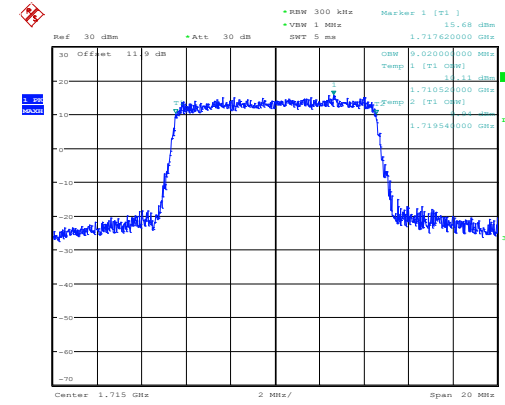

Middle Channel / 10MHz / QPSK

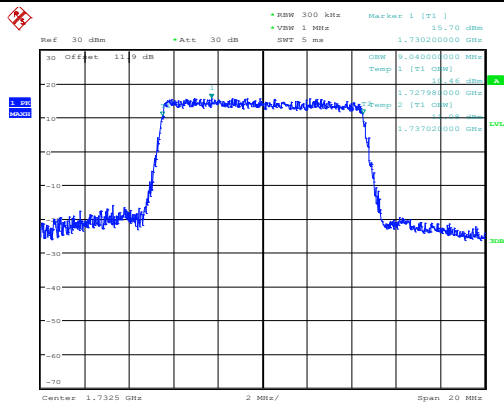

Middle Channel / 10MHz / 16QAM

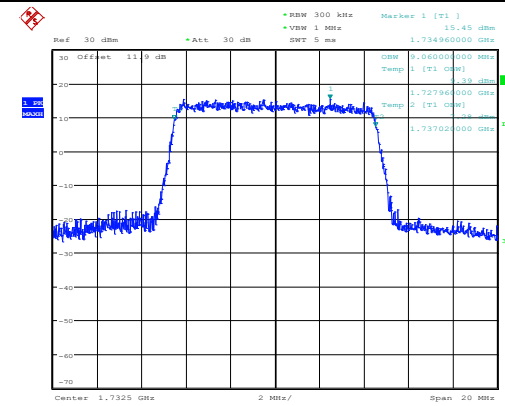

Highest Channel / 10MHz / QPSK

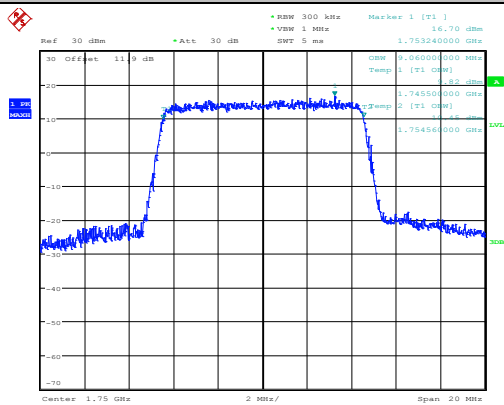

Highest Channel / 10MHz / 16QAM

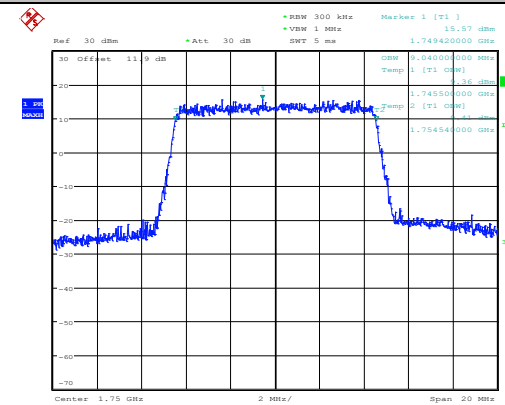



LTE Band 4

Lowest Channel / 15MHz / QPSK

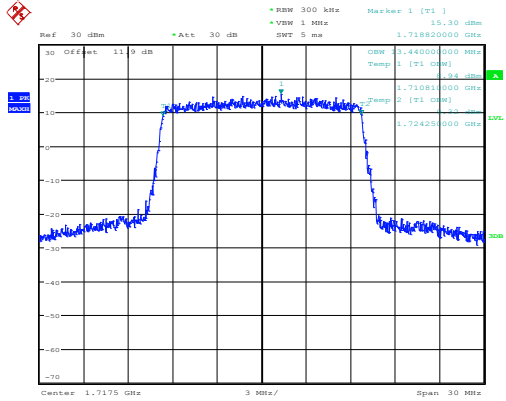

Date: 3.DEC.2014 11:23:26

Lowest Channel / 15MHz / 16QAM

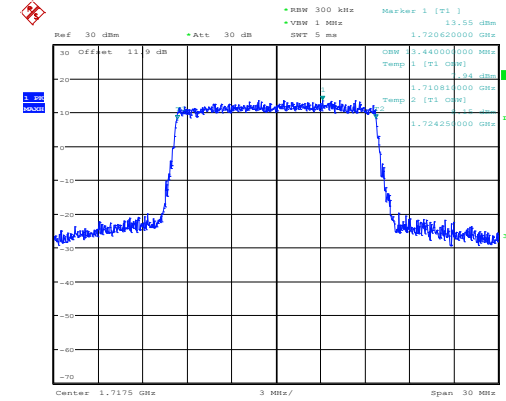

Date: 3.DEC.2014 11:23:37

Middle Channel / 15MHz / QPSK

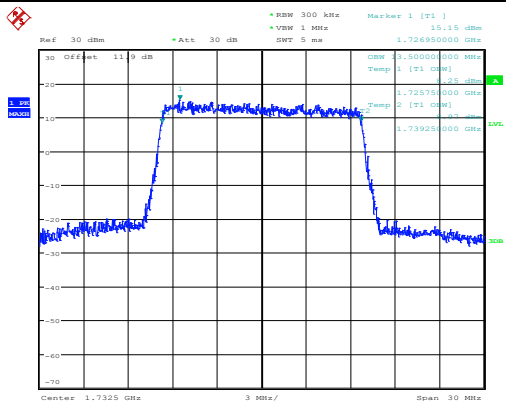

Date: 3.DEC.2014 11:31:13

Middle Channel / 15MHz / 16QAM

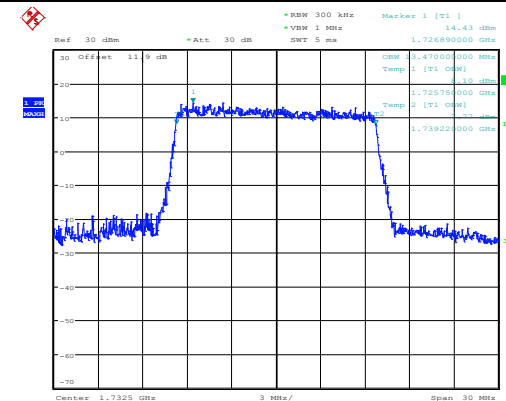

Date: 3.DEC.2014 11:31:24

Highest Channel / 15MHz / QPSK

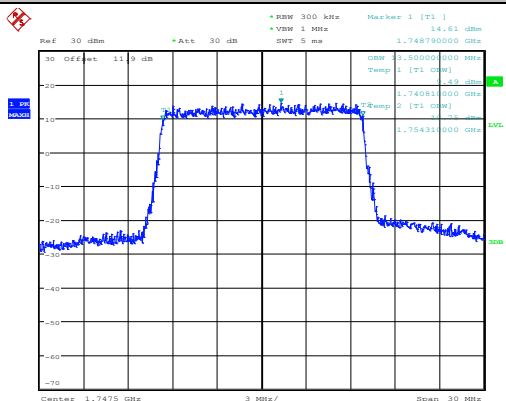

Date: 3.DEC.2014 11:34:20

Highest Channel / 15MHz / 16QAM

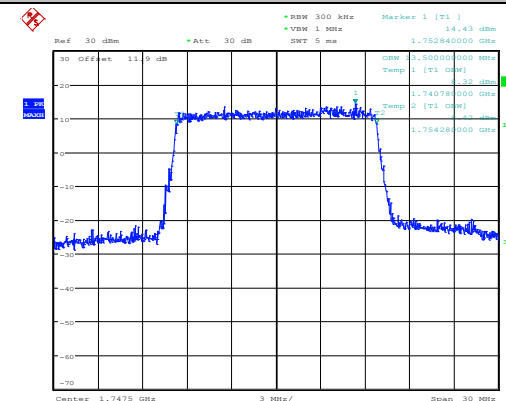

Date: 3.DEC.2014 11:34:31



LTE Band 4

Lowest Channel / 20MHz / QPSK

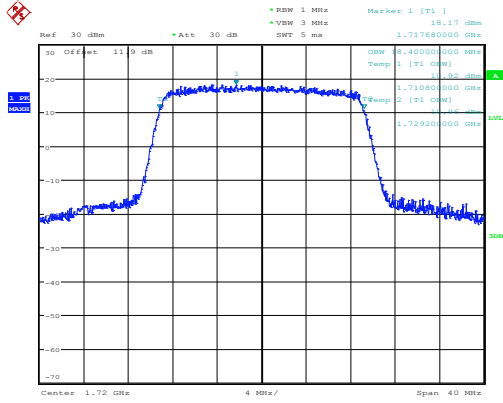

Date: 3.DEC.2014 11:42:11

Lowest Channel / 20MHz / 16QAM

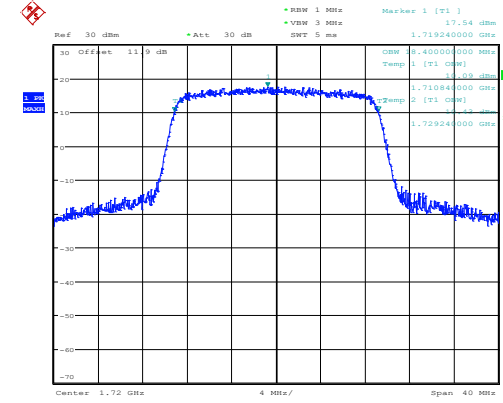

Date: 3.DEC.2014 11:42:22

Middle Channel / 20MHz / QPSK

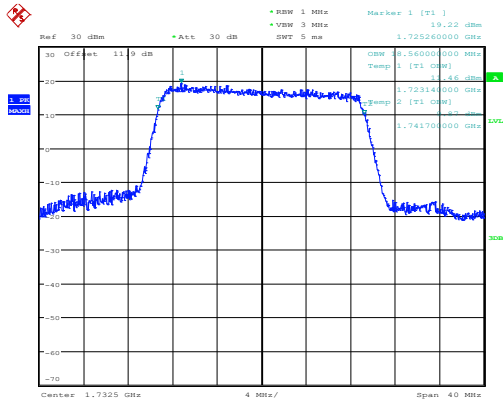

Date: 3.DEC.2014 11:50:04

Middle Channel / 20MHz / 16QAM

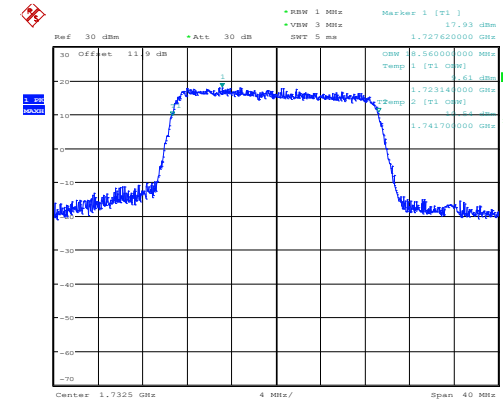

Date: 3.DEC.2014 11:50:15

Highest Channel / 20MHz / QPSK

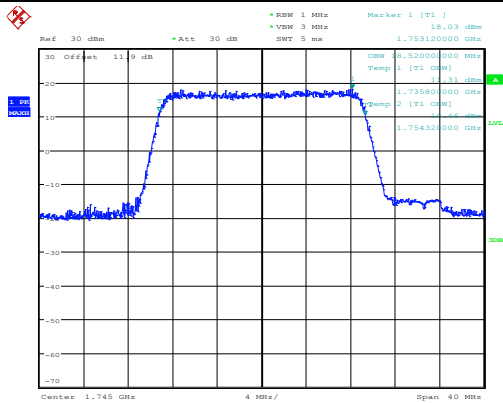

Date: 3.DEC.2014 11:53:11

Highest Channel / 20MHz / 16QAM

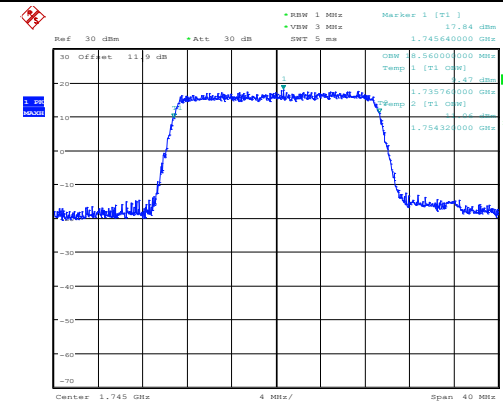

Date: 3.DEC.2014 11:53:22



LTE Band 13

Lowest Channel / 5MHz / QPSK

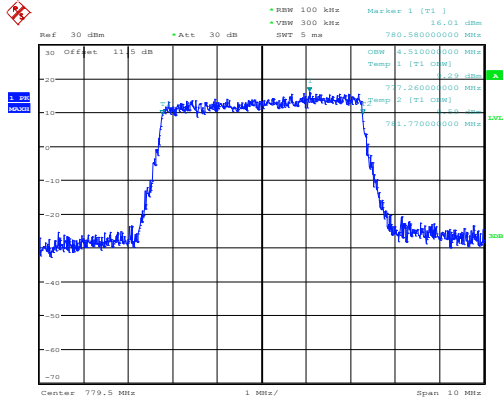

Date: 2.DEC.2014 14:37:00

Lowest Channel / 5MHz / 16QAM

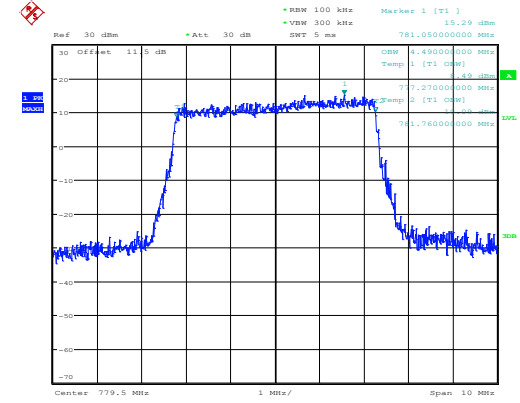

Date: 2.DEC.2014 14:37:11

Middle Channel / 5MHz / QPSK

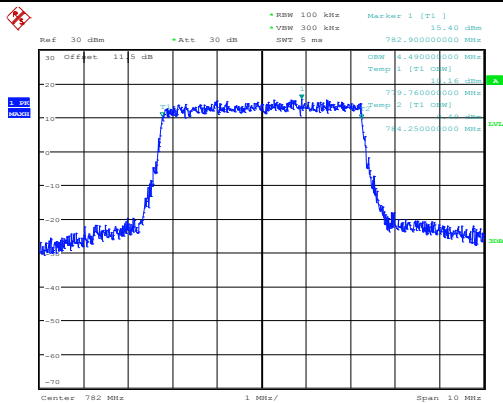

Date: 2.DEC.2014 14:43:06

Middle Channel / 5MHz / 16QAM

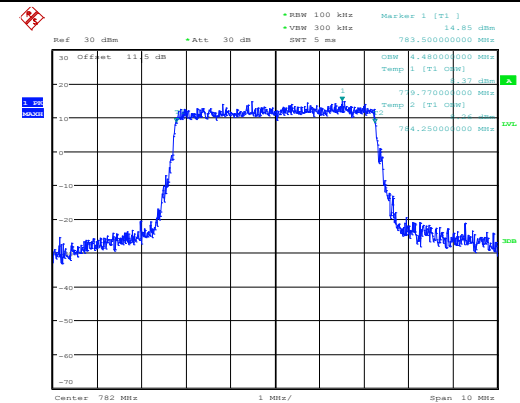

Date: 2.DEC.2014 14:42:55

Highest Channel / 5MHz / QPSK

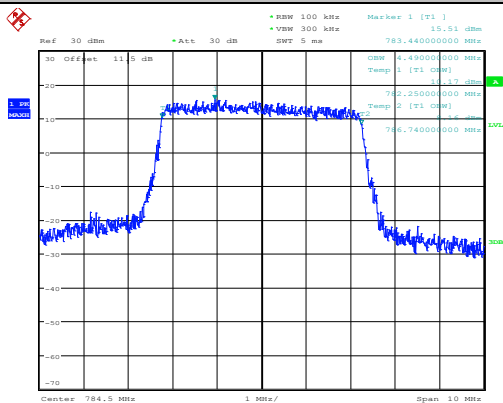

Date: 2.DEC.2014 14:43:17

Highest Channel / 5MHz / 16QAM

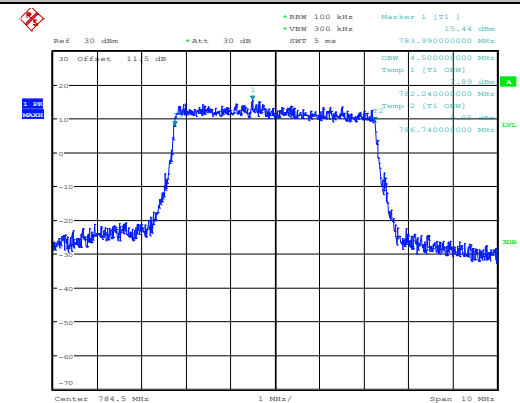

Date: 2.DEC.2014 14:43:28



LTE Band 13

Middle Channel / 10MHz / QPSK

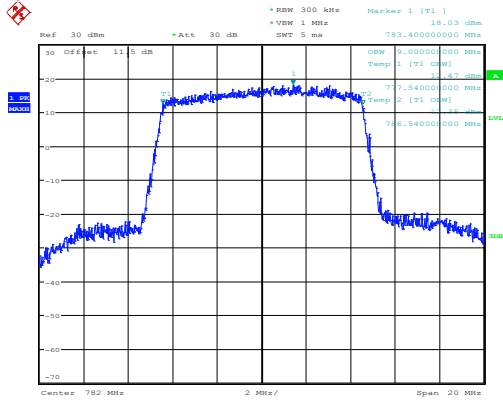

Date: 2.DEC.2014 14:46:30

Middle Channel / 10MHz / 16QAM

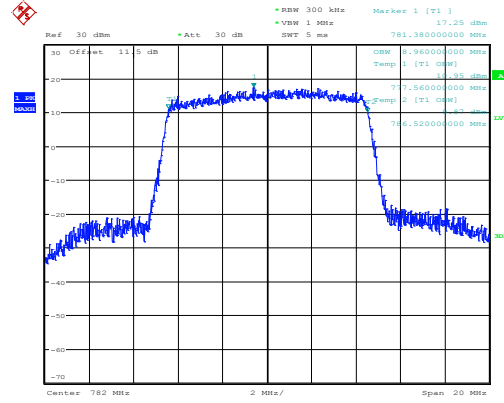

Date: 2.DEC.2014 14:46:40



Conducted Band Edge

LTE Band 4 / 1.4MHz / QPSK

Lowest Band Edge / 1RB

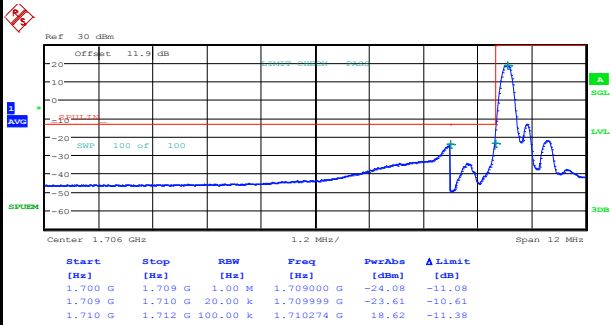

Date: 3.DEC.2014 13:18:03

Highest Band Edge / 1RB

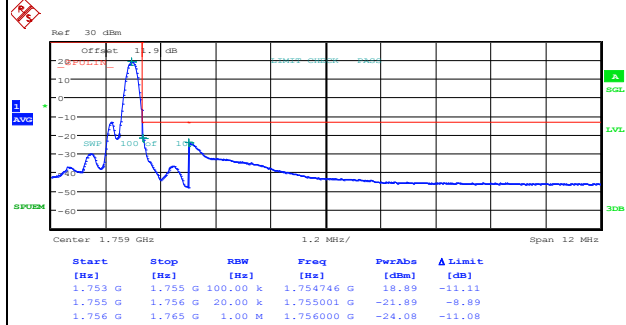

Date: 3.DEC.2014 13:30:36

Lowest Band Edge / Full RB

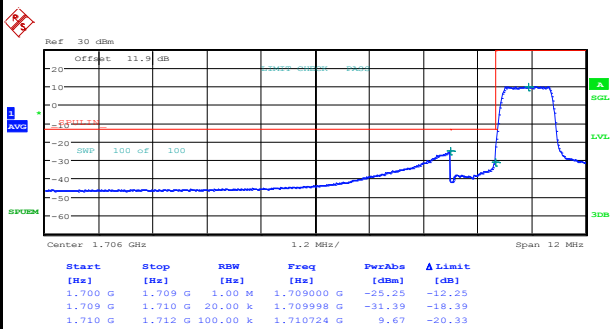

Date: 3.DEC.2014 13:20:22

Highest Band Edge / Full RB

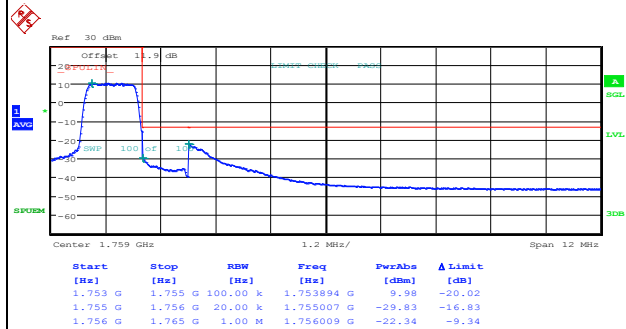

Date: 3.DEC.2014 13:32:55



LTE Band 4 / 1.4MHz / 16QAM

Lowest Band Edge / 1 RB

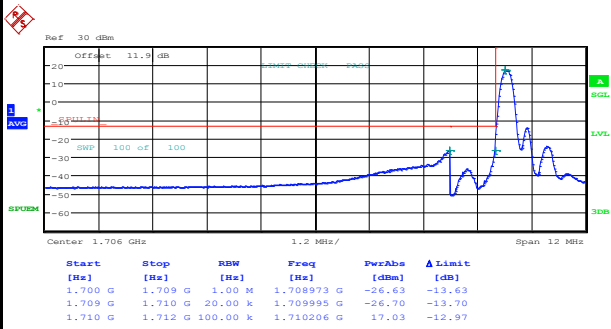

Date: 3.DEC.2014 13:19:13

Highest Band Edge / 1 RB

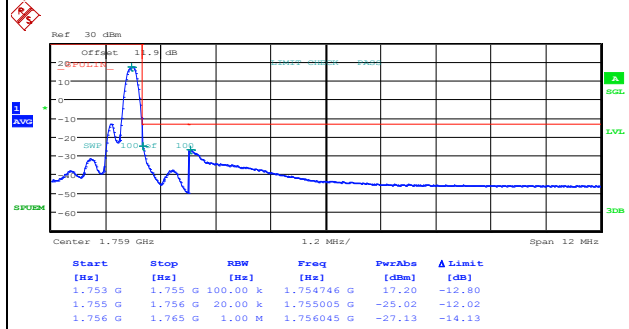

Date: 3.DEC.2014 13:31:46

Lowest Band Edge / Full RB

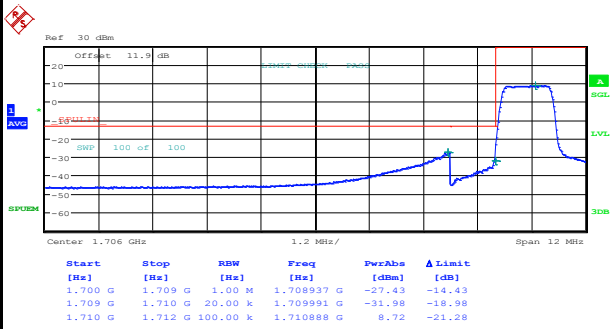

Date: 3.DEC.2014 13:21:32

Highest Band Edge / Full RB

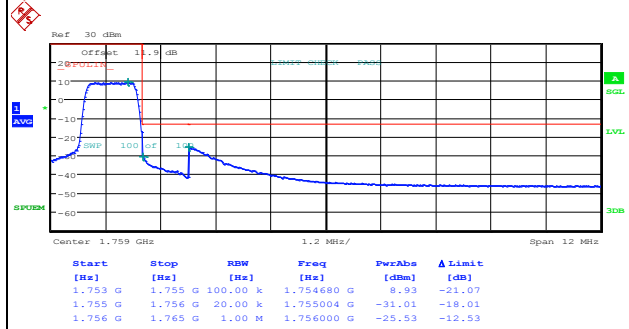

Date: 3.DEC.2014 13:34:05



LTE Band 4 / 3MHz / QPSK

Lowest Band Edge / 1RB

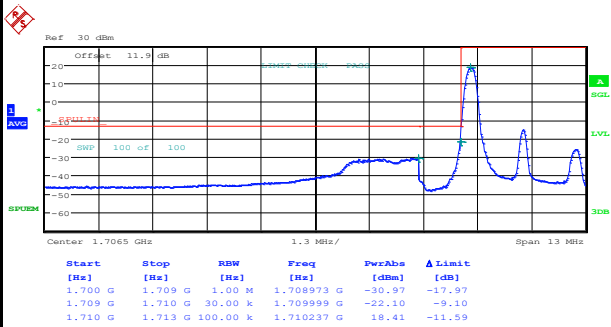

Date: 3.DEC.2014 10:28:57

Highest Band Edge / 1 RB

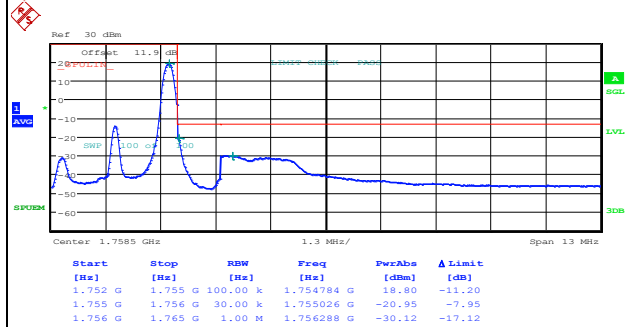

Date: 3.DEC.2014 10:39:51

Lowest Band Edge / Full RB

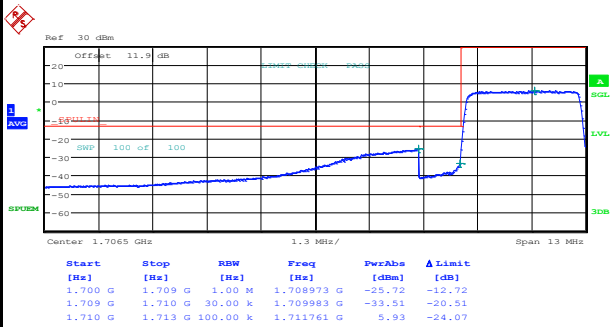

Date: 3.DEC.2014 10:31:17

Highest Band Edge / Full RB

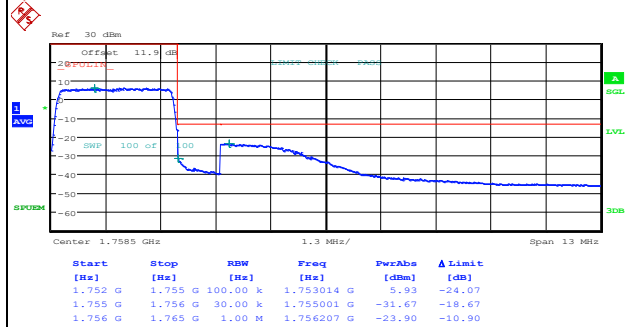

Date: 3.DEC.2014 10:42:11



LTE Band 4 / 3MHz / 16QAM

Lowest Band Edge / 1 RB

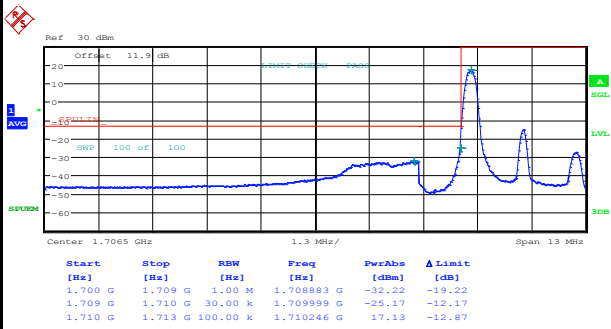

Date: 3.DEC.2014 10:30:07

Highest Band Edge / 1 RB

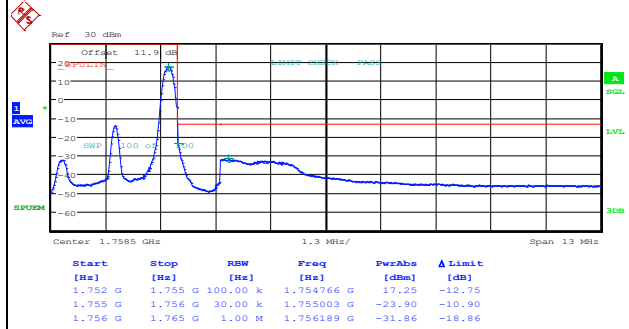

Date: 3.DEC.2014 10:41:01

Lowest Band Edge / Full RB

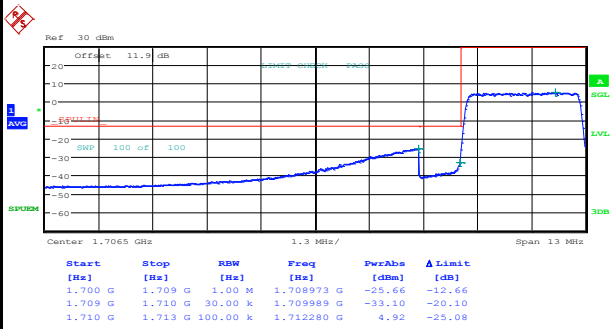

Date: 3.DEC.2014 10:32:27

Highest Band Edge / Full RB

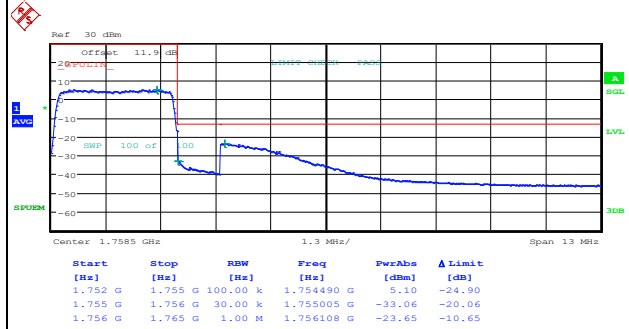

Date: 3.DEC.2014 10:43:21



LTE Band 4 / 5MHz / QPSK

Lowest Band Edge / 1 RB

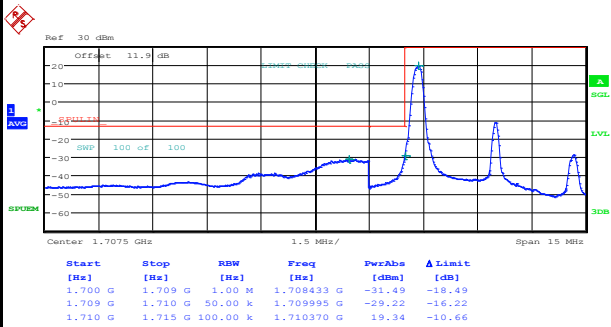

Date: 3.DEC.2014 14:26:32

Highest Band Edge / 1 RB

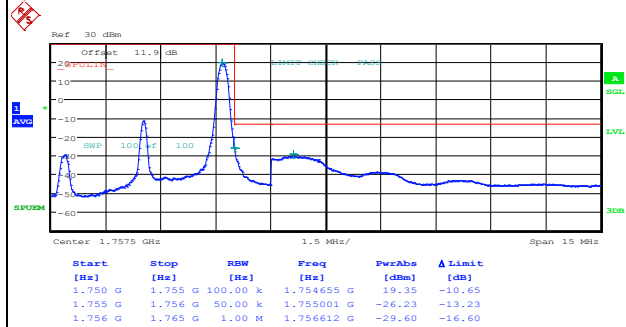

Date: 3.DEC.2014 14:31:11

Lowest Band Edge / Full RB

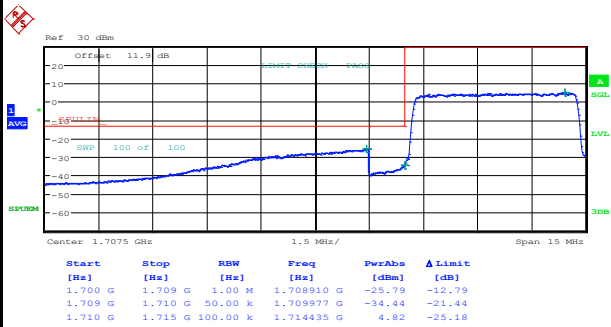

Date: 3.DEC.2014 14:28:51

Highest Band Edge / Full RB

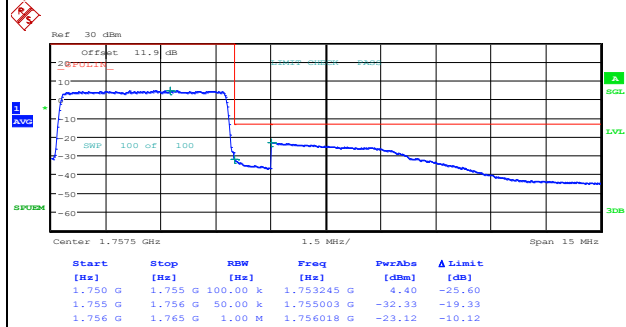

Date: 3.DEC.2014 14:33:30



LTE Band 4 / 5MHz / 16QAM

Lowest Band Edge / 1RB

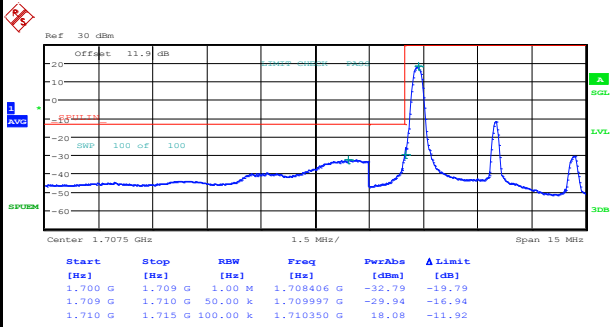

Date: 3.DEC.2014 14:27:42

Highest Band Edge / 1 RB

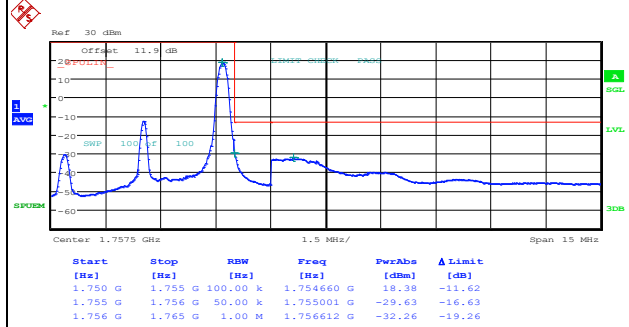

Date: 3.DEC.2014 14:32:21

Lowest Band Edge / Full RB

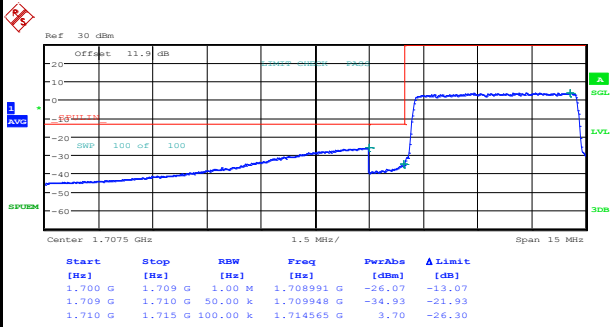

Date: 3.DEC.2014 14:30:01

Highest Band Edge / Full RB

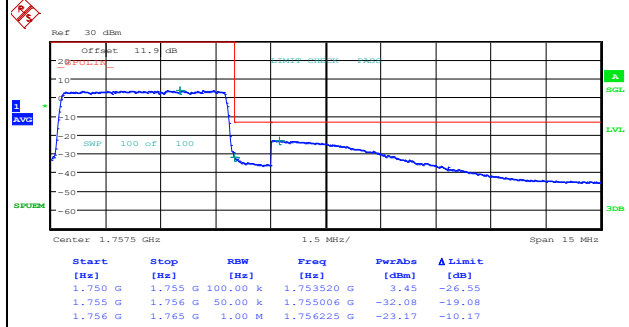

Date: 3.DEC.2014 14:34:40



LTE Band 4 / 10MHz / QPSK

Lowest Band Edge / 1 RB

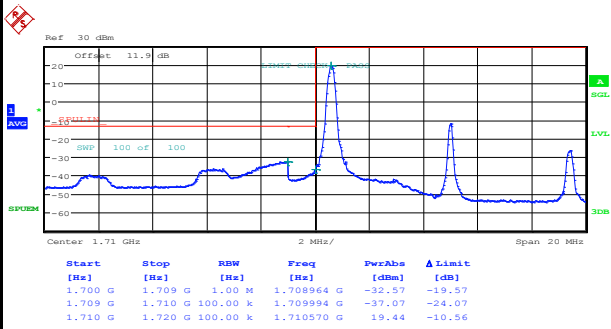

Date: 3.DEC.2014 14:35:54

Highest Band Edge / 1 RB

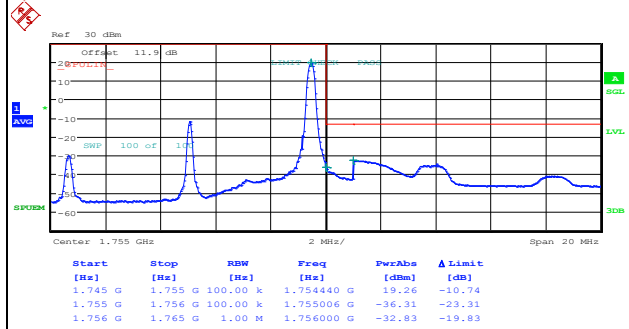

Date: 3.DEC.2014 14:40:32

Lowest Band Edge / Full RB

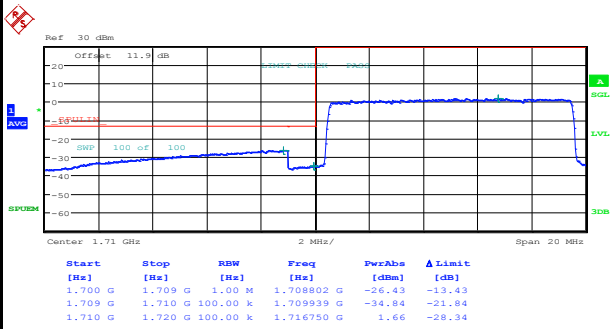

Date: 3.DEC.2014 14:38:13

Highest Band Edge / Full RB

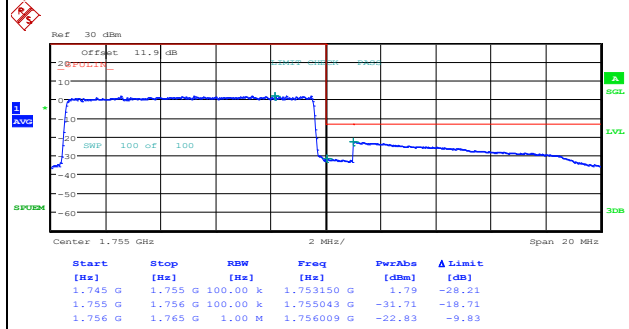

Date: 3.DEC.2014 14:42:52



LTE Band 4 / 10MHz / 16QAM

Lowest Band Edge / 1 RB

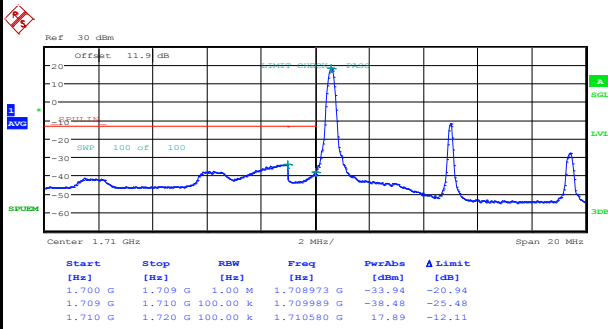

Date: 3.DEC.2014 14:37:03

Highest Band Edge / 1 RB

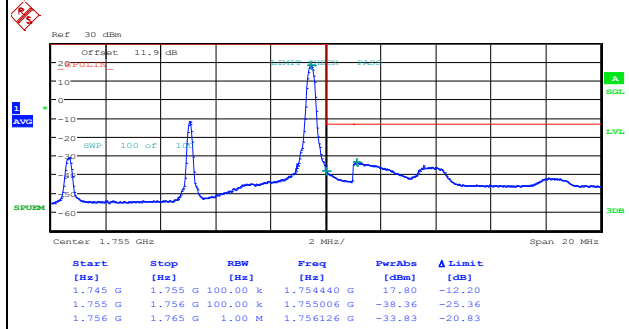

Date: 3.DEC.2014 14:41:42

Lowest Band Edge / Full RB

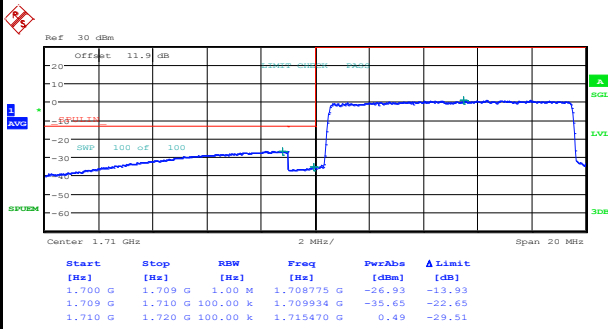

Date: 3.DEC.2014 14:39:22

Highest Band Edge / Full RB

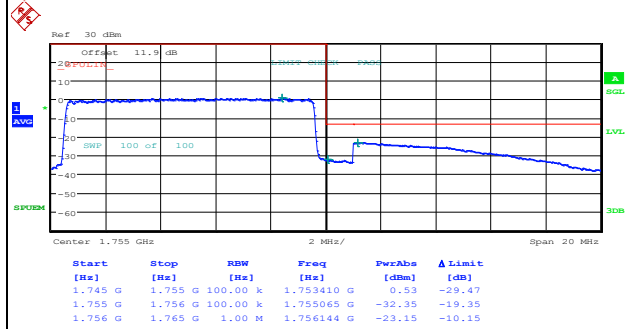

Date: 3.DEC.2014 14:44:01



LTE Band 4 / 15MHz / QPSK

Lowest Band Edge / 1 RB

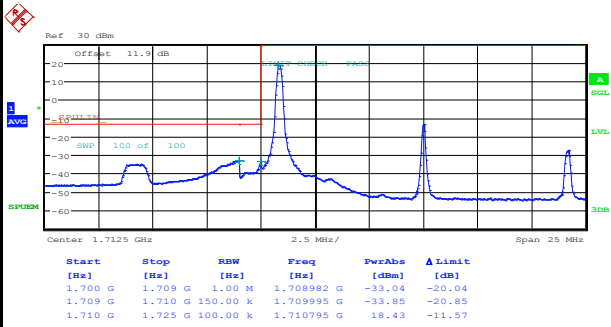

Date: 3.DEC.2014 11:25:12

Highest Band Edge / 1 RB

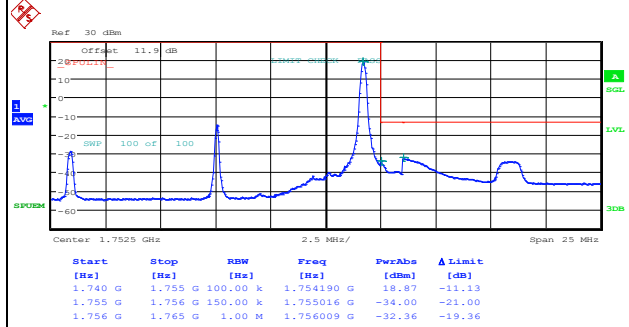

Date: 3.DEC.2014 11:36:06

Lowest Band Edge / Full RB

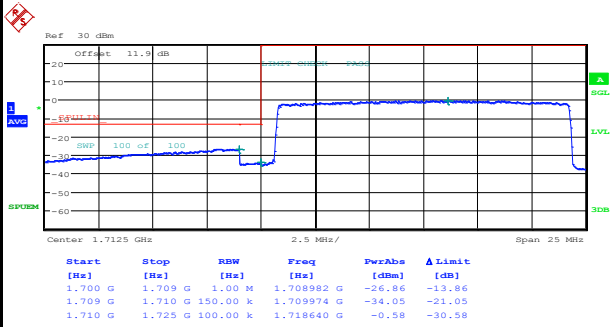

Date: 3.DEC.2014 11:27:32

Highest Band Edge / Full RB

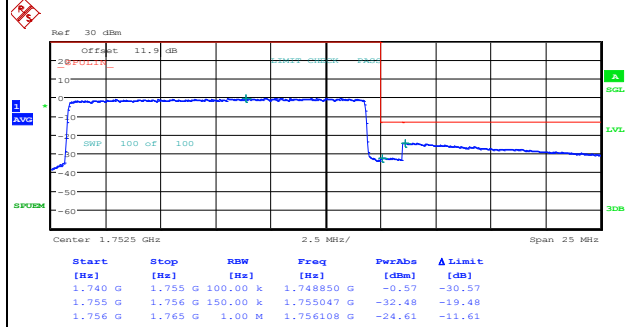

Date: 3.DEC.2014 11:38:26



LTE Band 4 / 15MHz / 16QAM

Lowest Band Edge / 1 RB

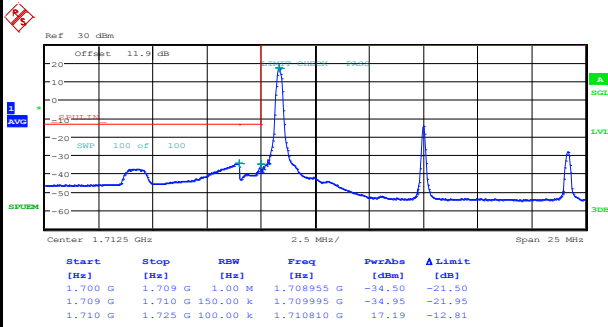

Date: 3.DEC.2014 11:26:22

Highest Band Edge / 1 RB

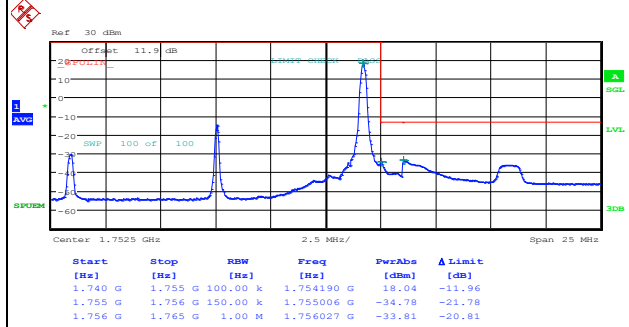

Date: 3.DEC.2014 11:37:16

Lowest Band Edge / Full RB

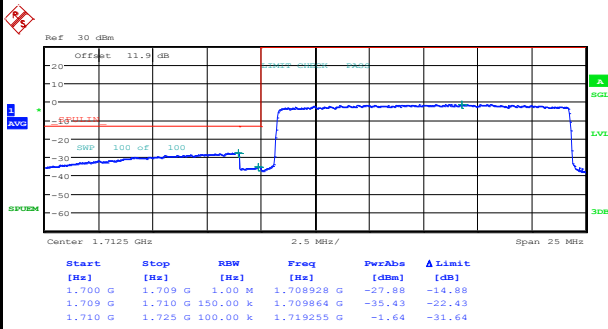

Date: 3.DEC.2014 11:28:42

Highest Band Edge / Full RB

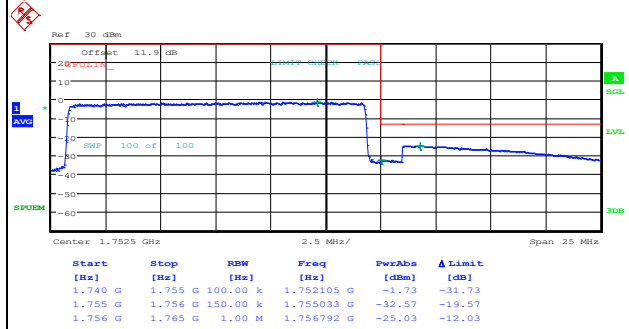

Date: 3.DEC.2014 11:39:36



LTE Band 4 / 20MHz / QPSK

Lowest Band Edge / 1 RB

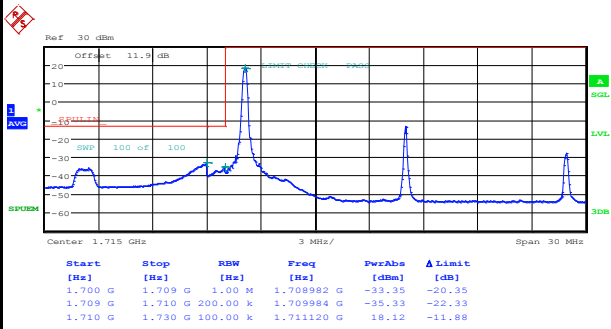

Date: 3.DEC.2014 11:43:57

Highest Band Edge / 1 RB

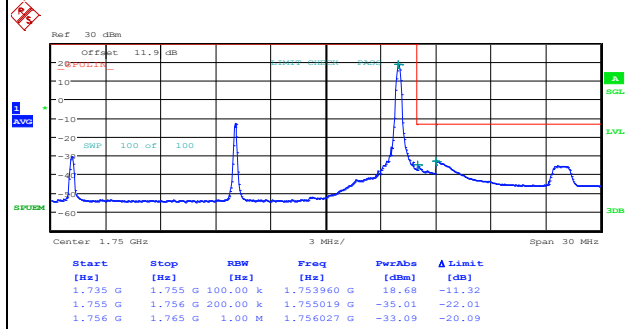

Date: 3.DEC.2014 13:10:12

Lowest Band Edge / Full RB

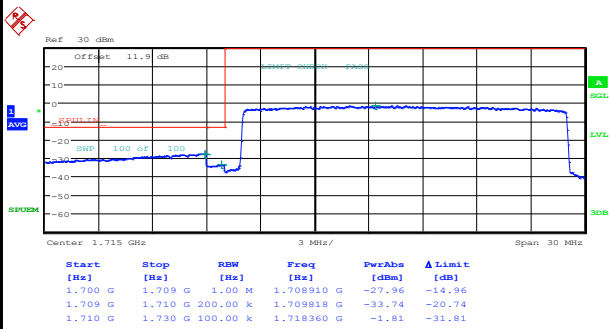

Date: 3.DEC.2014 11:46:17

Highest Band Edge / Full RB

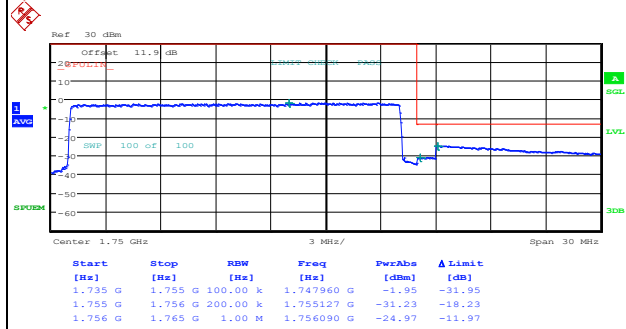

Date: 3.DEC.2014 13:12:32



LTE Band 4 / 20MHz / 16QAM

Lowest Band Edge / 1 RB

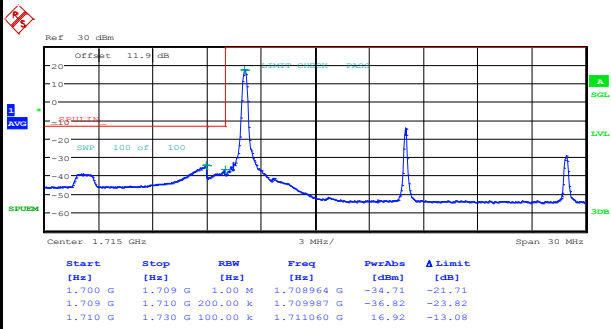

Date: 3.DEC.2014 11:45:07

Highest Band Edge / 1 RB

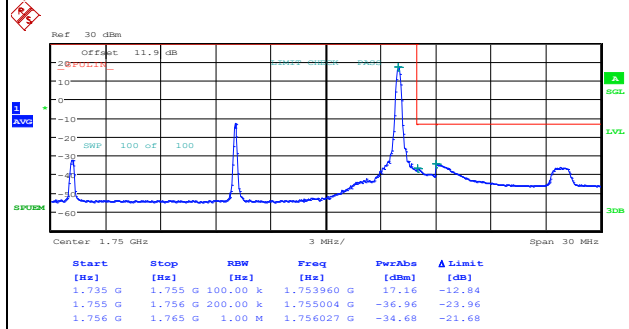

Date: 3.DEC.2014 13:11:22

Lowest Band Edge / Full RB

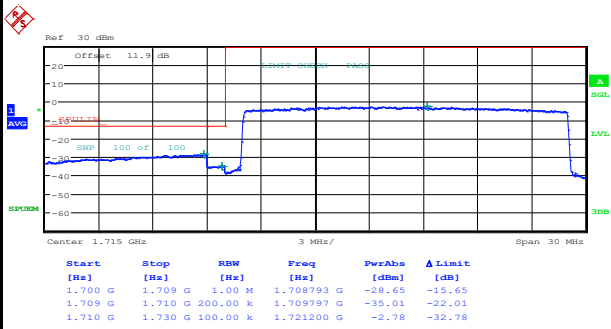

Date: 3.DEC.2014 11:47:33

Highest Band Edge / Full RB

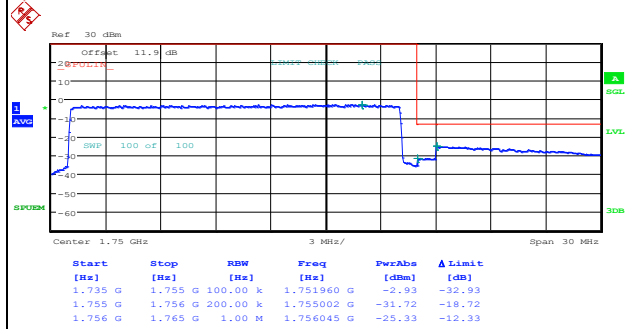

Date: 3.DEC.2014 13:13:42



LTE Band 13 / 5MHz / QPSK

Lowest Band Edge / 1 RB

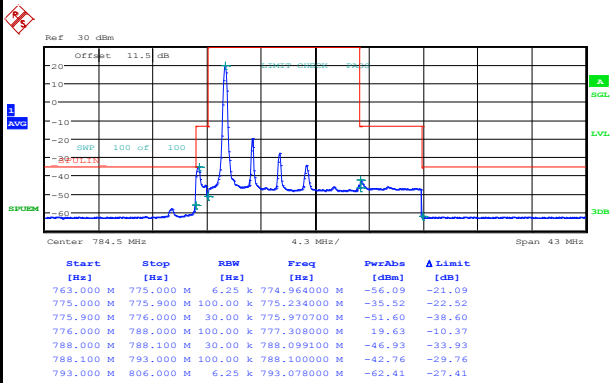

Date: 2.DEC.2014 14:54:59

Highest Band Edge / 1 RB

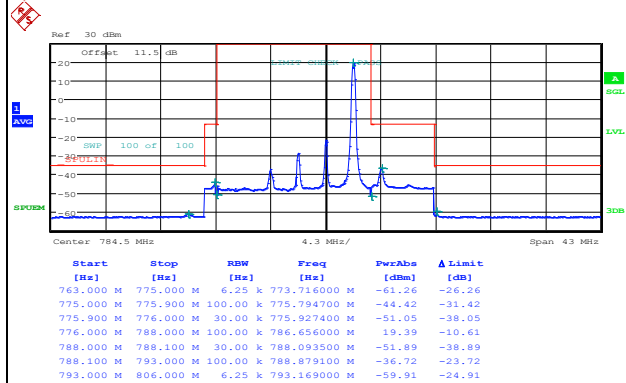

Date: 2.DEC.2014 15:09:31

Lowest Band Edge / Full RB

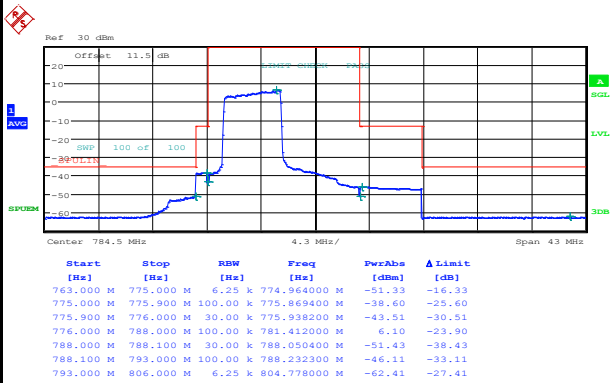

Date: 2.DEC.2014 15:00:44

Highest Band Edge / Full RB

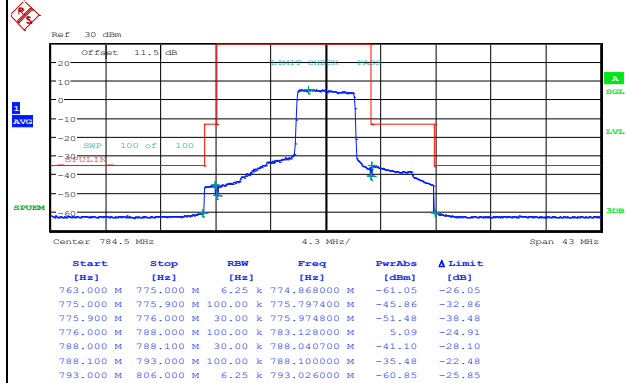

Date: 2.DEC.2014 15:02:48



LTE Band 13 / 5MHz / 16QAM

Lowest Band Edge / 1 RB

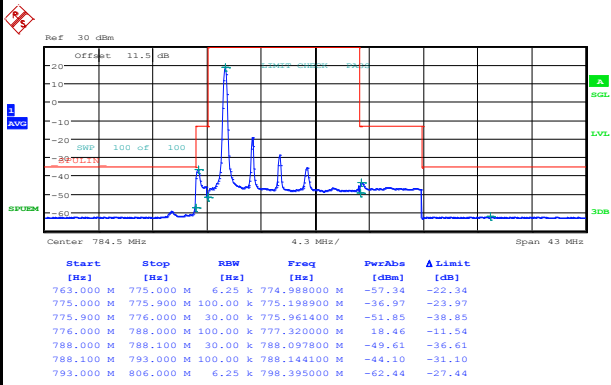

Date: 2.DEC.2014 14:56:57

Highest Band Edge / 1 RB

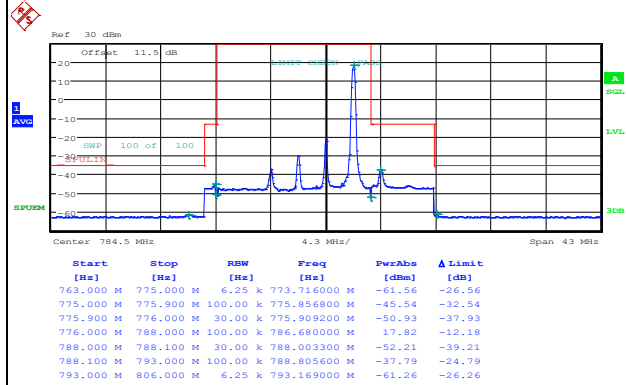

Date: 2.DEC.2014 15:07:15

Lowest Band Edge / Full RB

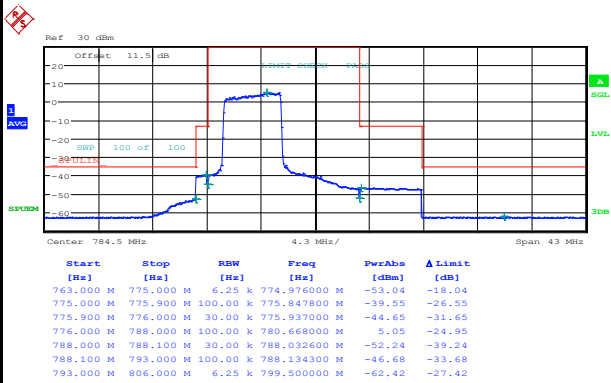

Date: 2.DEC.2014 14:58:52

Highest Band Edge / Full RB

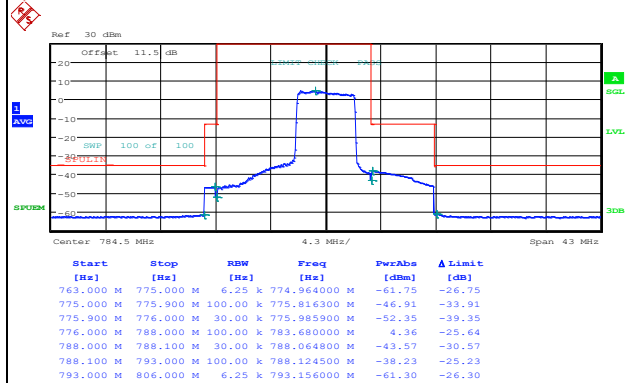

Date: 2.DEC.2014 15:05:03



LTE Band 13 / 10MHz / QPSK

Lowest Band Edge / 1 RB

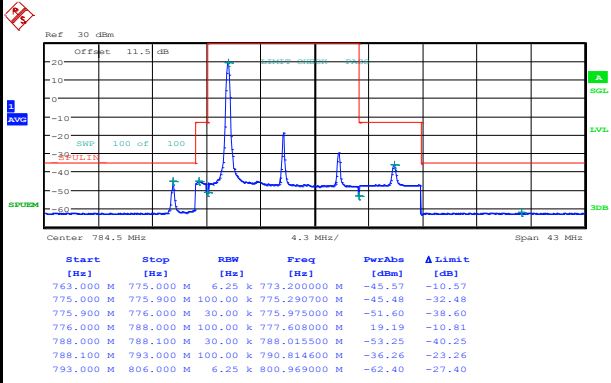

Date: 2.DEC.2014 15:11:42

Highest Band Edge / 1 RB

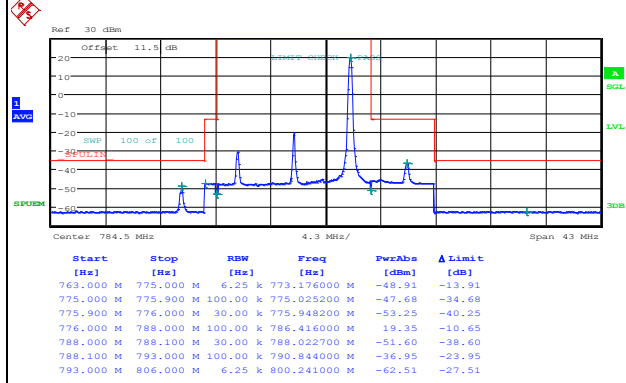

Date: 2.DEC.2014 15:18:56

Band Edge / Full RB

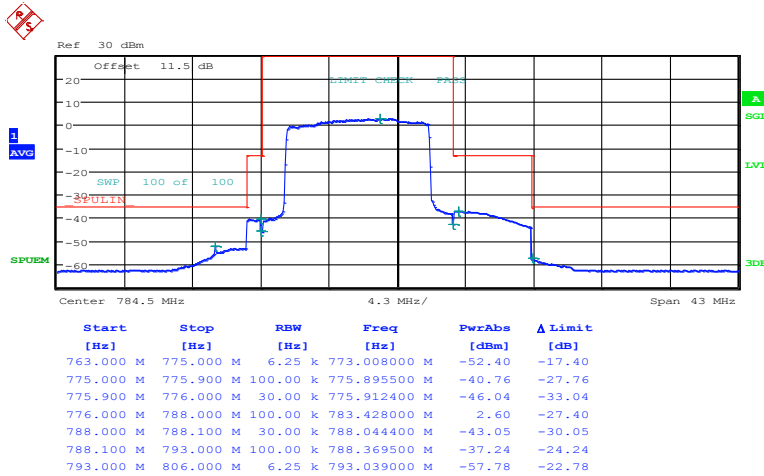

Date: 2.DEC.2014 15:25:00



LTE Band 13 / 10MHz / 16QAM

Lowest Band Edge / 1 RB

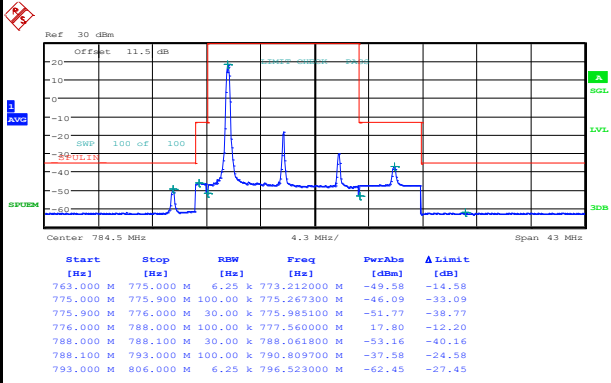

Date: 2.DEC.2014 15:14:18

Highest Band Edge / 1 RB

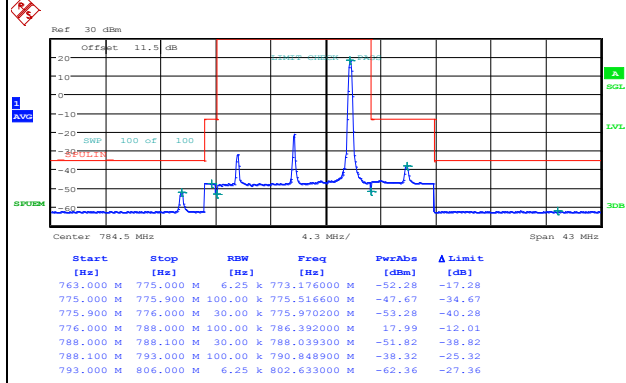

Date: 2.DEC.2014 15:16:52

Band Edge / Full RB

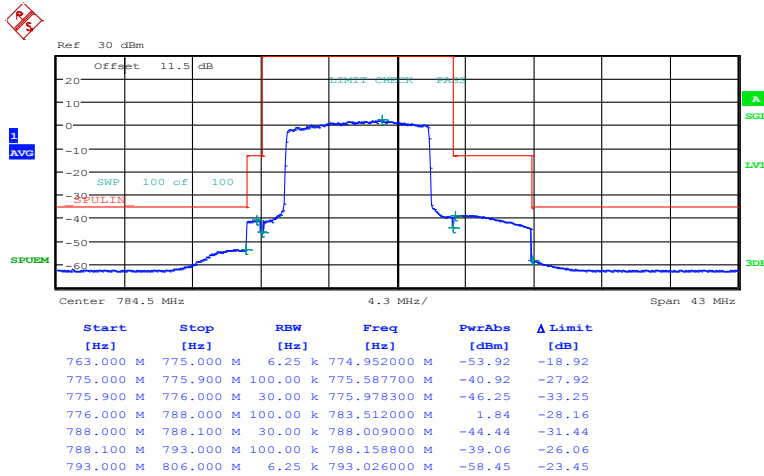

Date: 2.DEC.2014 15:27:36



Conducted Spurious Emission

LTE Band 4 / 1.4MHz

Lowest Channel / QPSK

Lowest Channel / 16QAM

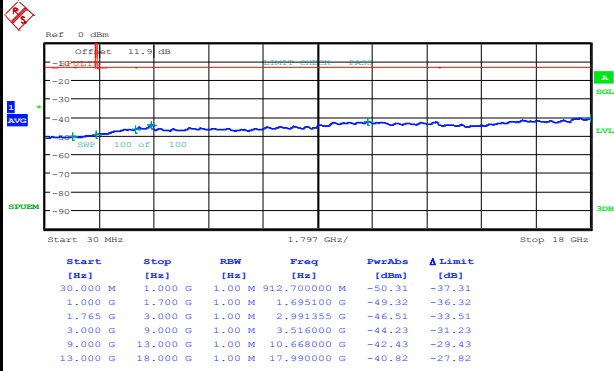

Date: 3.DEC.2014 13:22:41

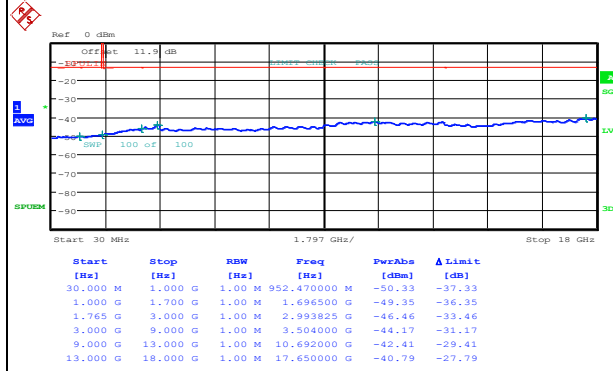

Date: 3.DEC.2014 13:23:52

Middle Channel / QPSK

Middle Channel / 16QAM

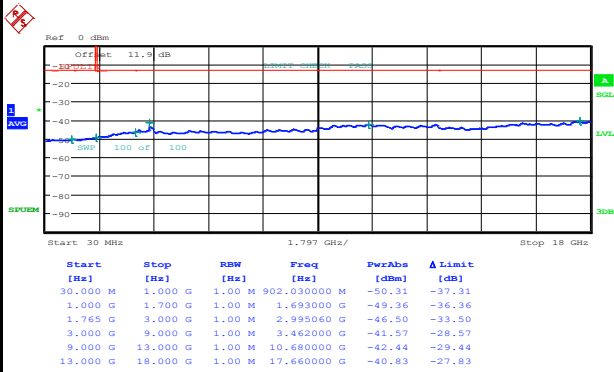

Date: 3.DEC.2014 13:25:48

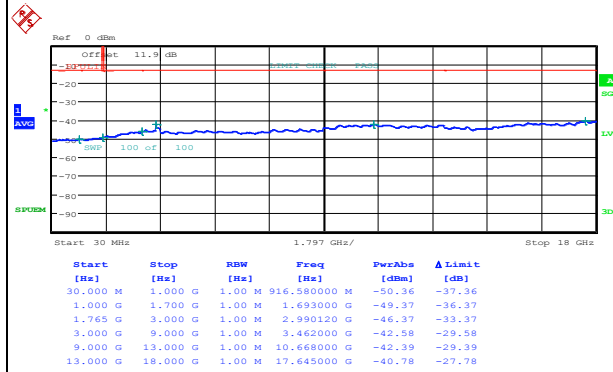

Date: 3.DEC.2014 13:26:58



LTE Band 4 / 1.4MHz

Highest Channel / QPSK

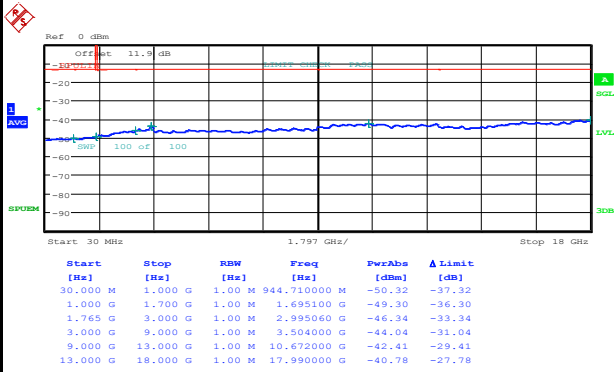

Date: 3.DEC.2014 13:35:15

Highest Channel / 16QAM

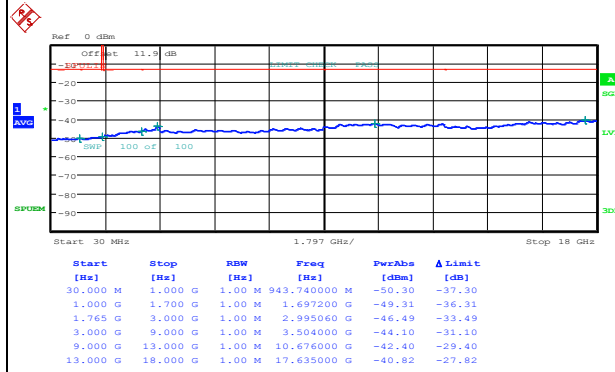

Date: 3.DEC.2014 13:36:25

LTE Band 4 / 3MHz

Lowest Channel / QPSK

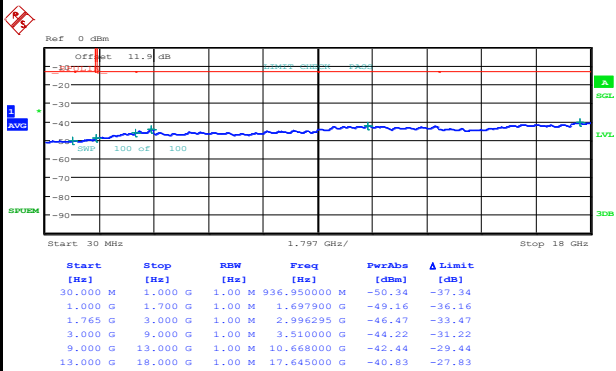

Date: 3.DEC.2014 10:33:37

Lowest Channel / 16QAM

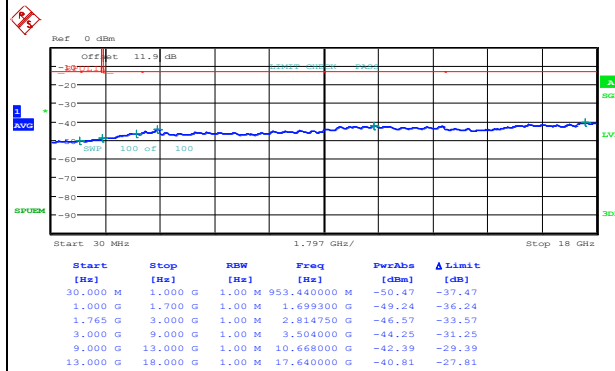

Date: 3.DEC.2014 10:34:47



LTE Band 4 / 3MHz

Middle Channel / QPSK

Middle Channel / 16QAM

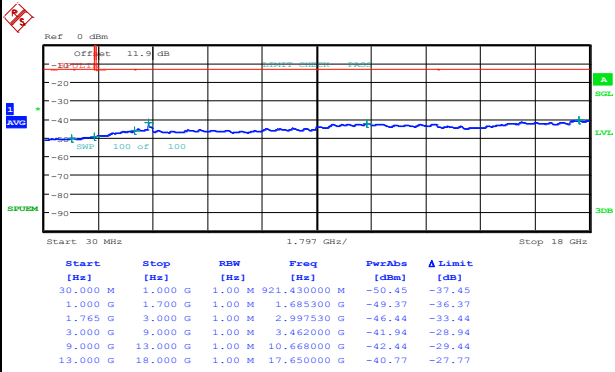

Date: 3.DEC.2014 10:36:44

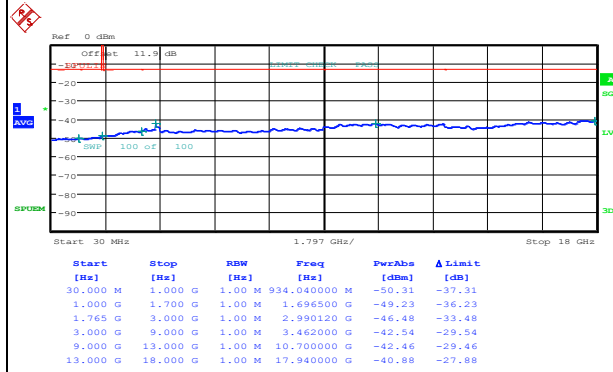

Date: 3.DEC.2014 10:37:54

Highest Channel / QPSK

Highest Channel / 16QAM

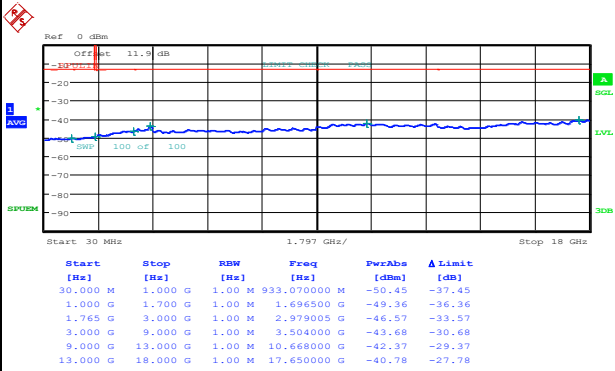

Date: 3.DEC.2014 10:44:31

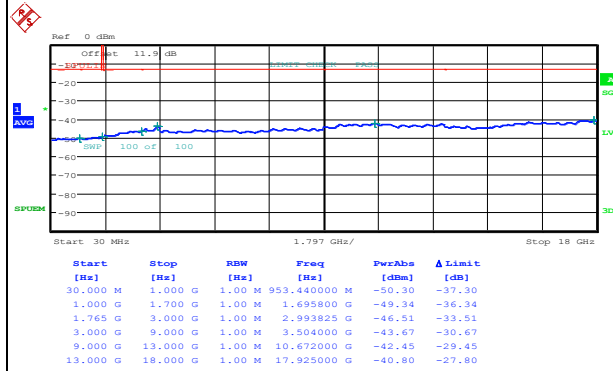

Date: 3.DEC.2014 10:45:41



LTE Band 4 / 5MHz

Lowest Channel / QPSK

Lowest Channel / 16QAM

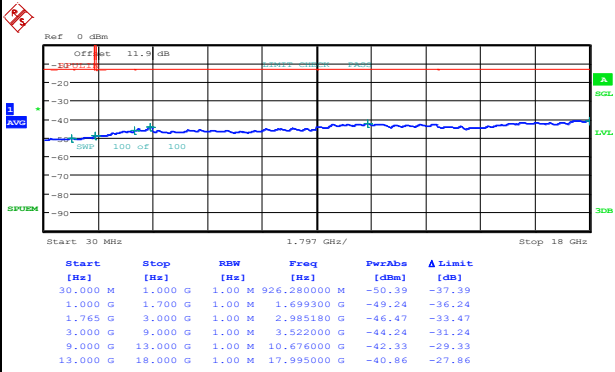

Date: 3.DEC.2014 10:52:22

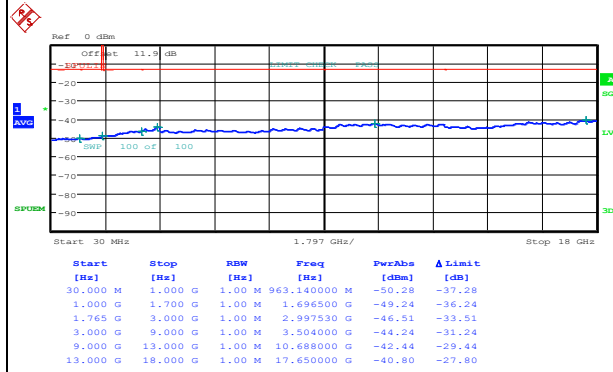

Date: 3.DEC.2014 10:53:32

Middle Channel / QPSK

Middle Channel / 16QAM

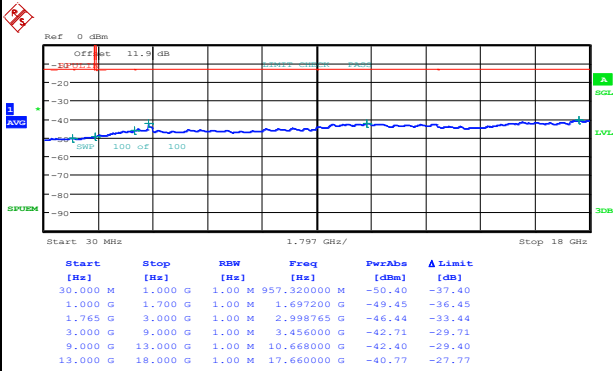

Date: 3.DEC.2014 10:55:29

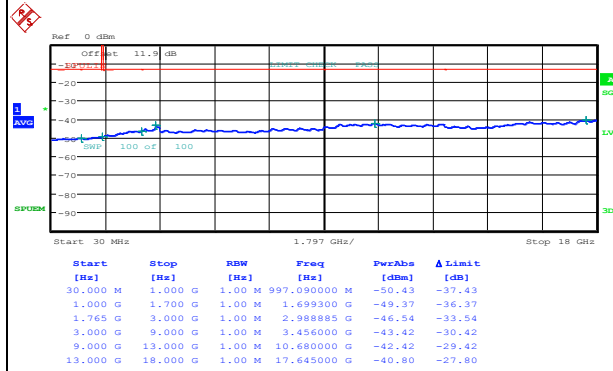

Date: 3.DEC.2014 10:56:39



LTE Band 4 / 5MHz

Highest Channel / QPSK

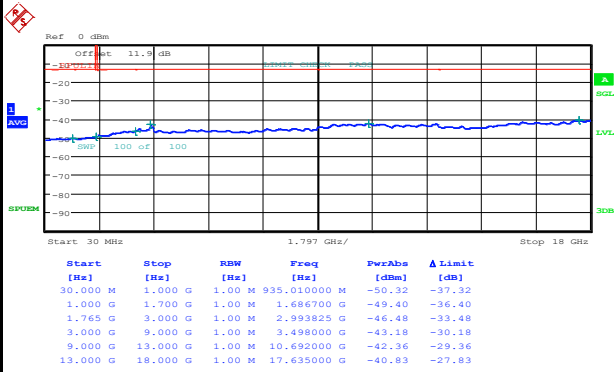

Date: 3.DEC.2014 11:03:16

Highest Channel / 16QAM

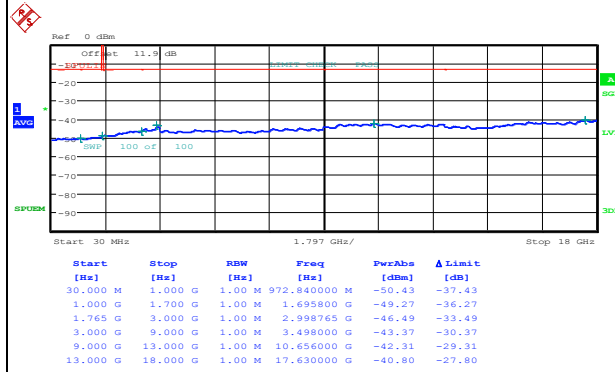

Date: 3.DEC.2014 11:04:26

LTE Band 4 / 10MHz

Lowest Channel / QPSK

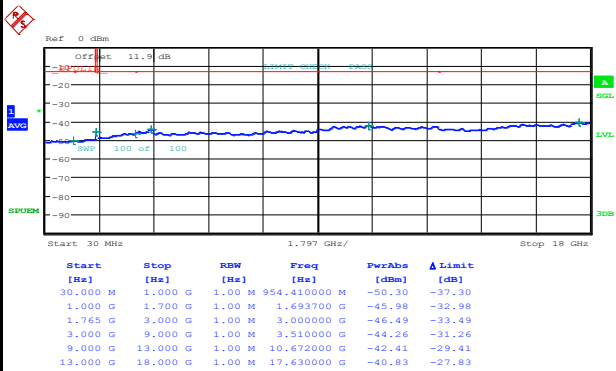

Date: 3.DEC.2014 11:11:07

Lowest Channel / 16QAM

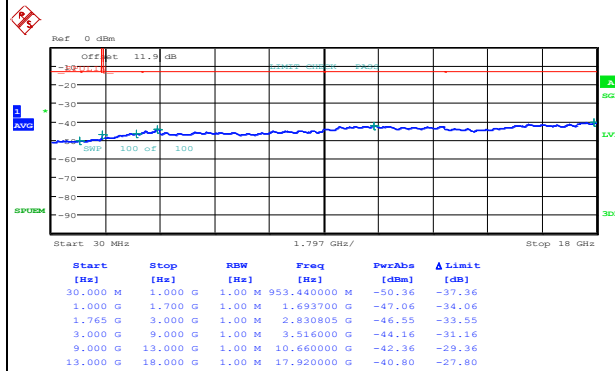

Date: 3.DEC.2014 11:12:17



LTE Band 4 / 10MHz

Middle Channel / QPSK

Middle Channel / 16QAM

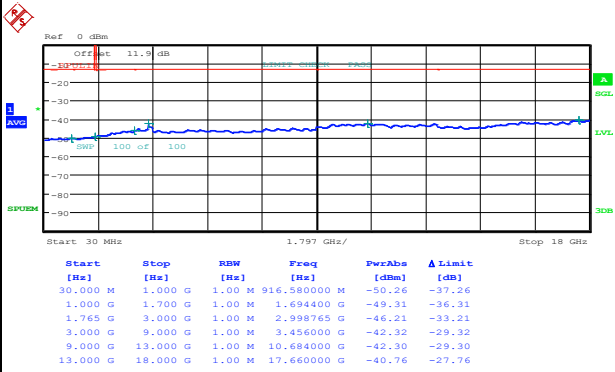

Date: 3.DEC.2014 11:14:14

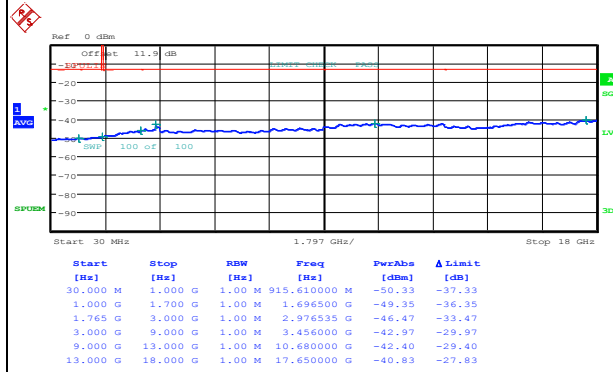

Date: 3.DEC.2014 11:15:24

Highest Channel / QPSK

Highest Channel / 16QAM

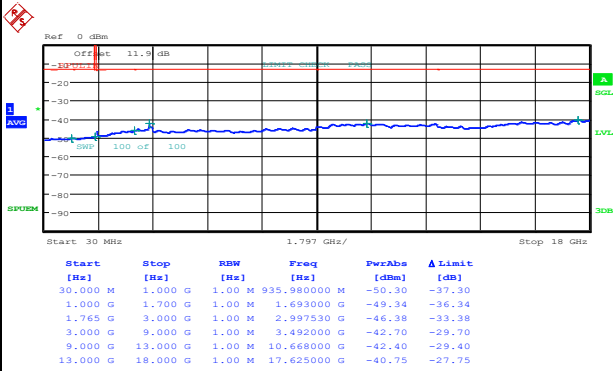

Date: 3.DEC.2014 11:22:01

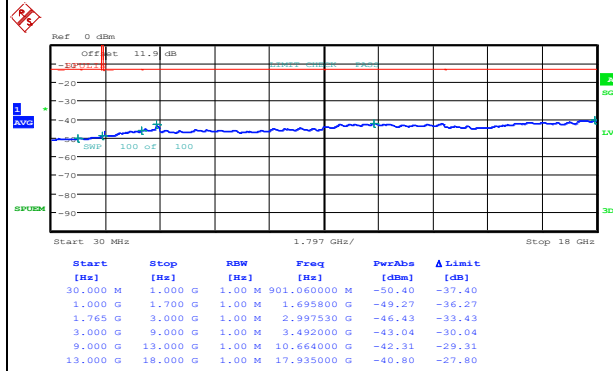

Date: 3.DEC.2014 11:23:11



LTE Band 4 / 15MHz

Lowest Channel / QPSK

Lowest Channel / 16QAM

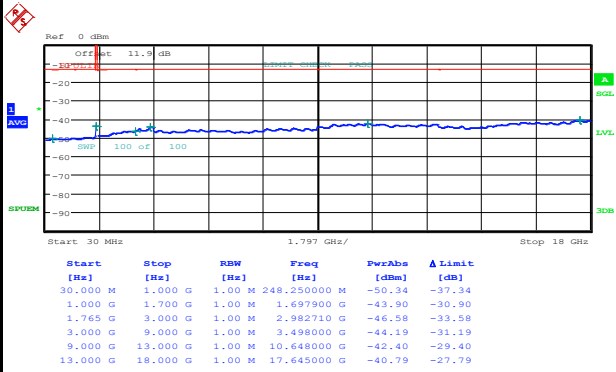

Date: 3.DEC.2014 11:29:52

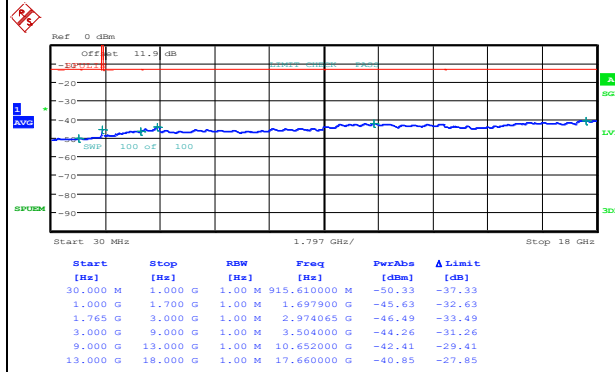

Date: 3.DEC.2014 11:31:02

Middle Channel / QPSK

Middle Channel / 16QAM

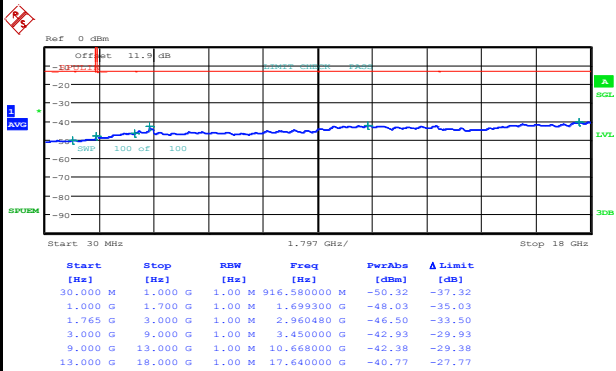

Date: 3.DEC.2014 11:32:59

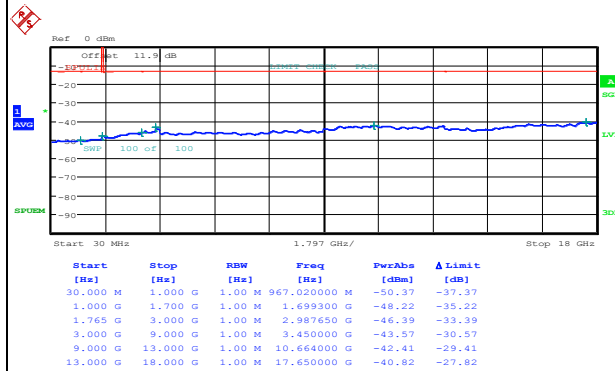

Date: 3.DEC.2014 11:34:09



LTE Band 4 / 15MHz

Highest Channel / QPSK

Highest Channel / 16QAM

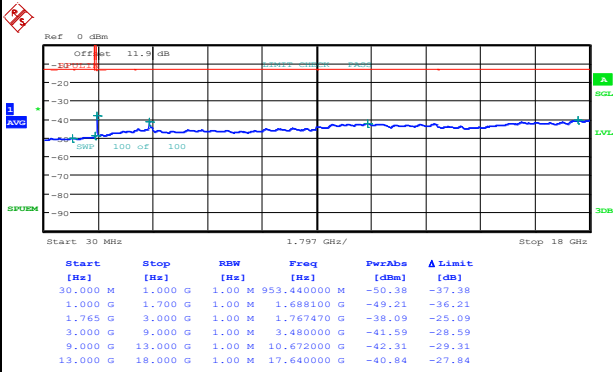

Date: 3.DEC.2014 11:40:46

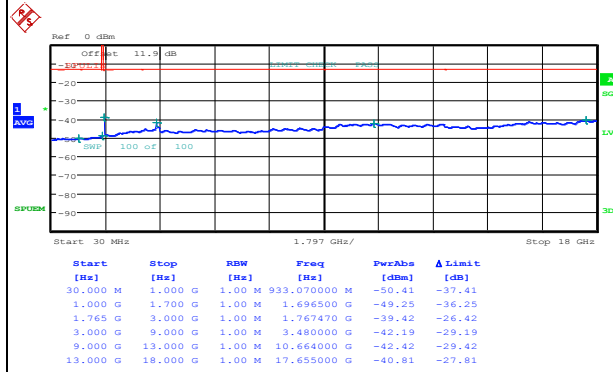

Date: 3.DEC.2014 11:41:56

LTE Band 4 / 20MHz

Lowest Channel / QPSK

Lowest Channel / 16QAM

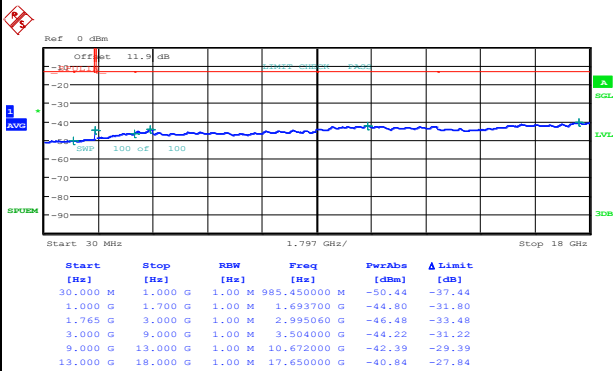

Date: 3.DEC.2014 11:48:43

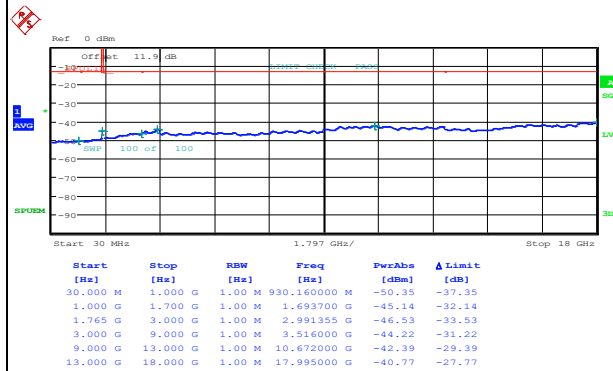

Date: 3.DEC.2014 11:49:53



LTE Band 4 / 20MHz

Middle Channel / QPSK

Middle Channel / 16QAM

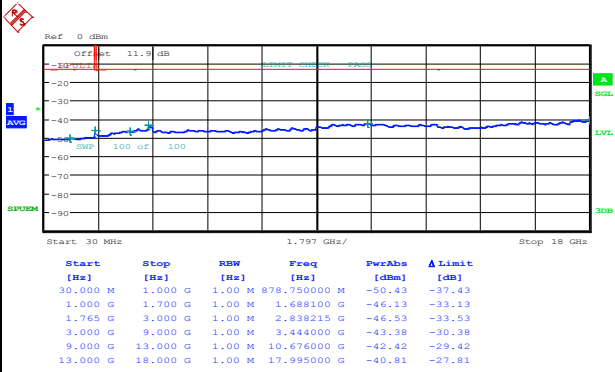

Date: 3.DEC.2014 11:51:50

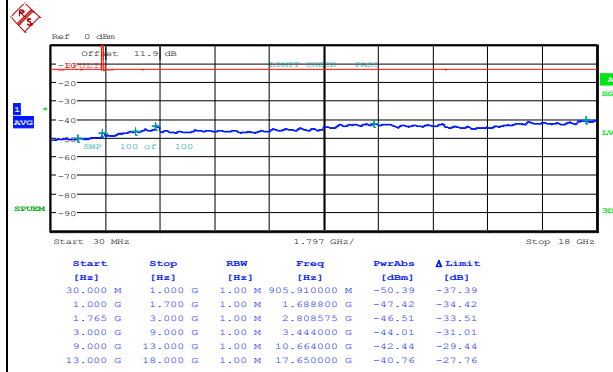

Date: 3.DEC.2014 11:53:00

Highest Channel / QPSK

Highest Channel / 16QAM

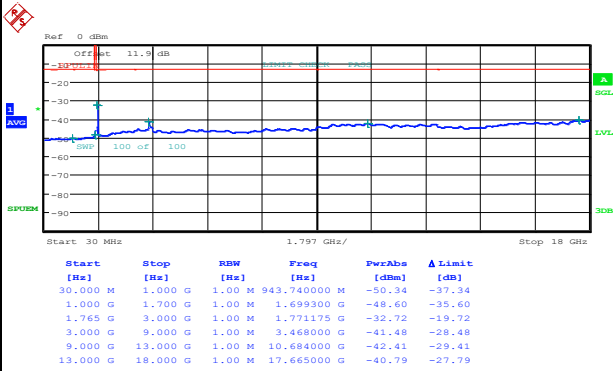

Date: 3.DEC.2014 13:14:52

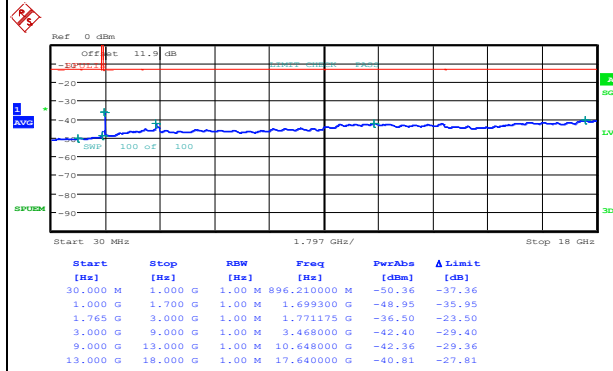

Date: 3.DEC.2014 13:16:01



LTE Band 13 / 5MHz

Lowest Channel / QPSK

Lowest Channel / 16QAM

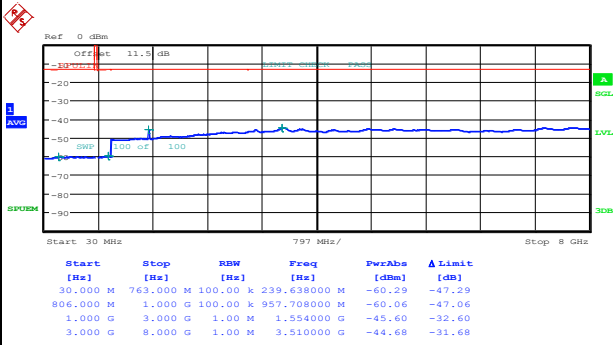

Date: 2.DEC.2014 14:38:47

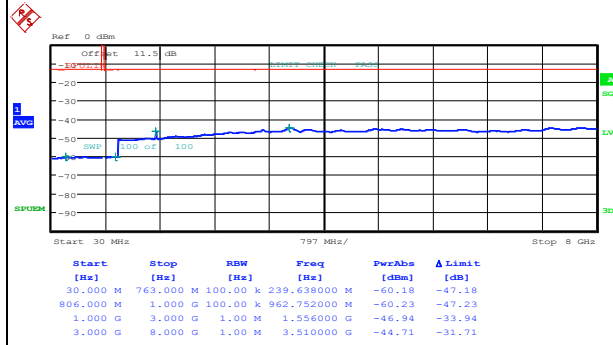

Date: 2.DEC.2014 14:39:58

Middle Channel / QPSK

Middle Channel / 16QAM

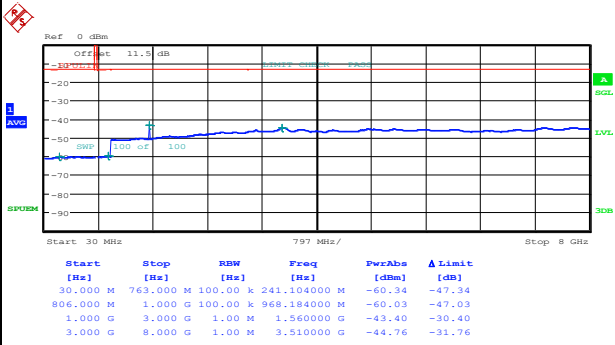

Date: 2.DEC.2014 14:42:19

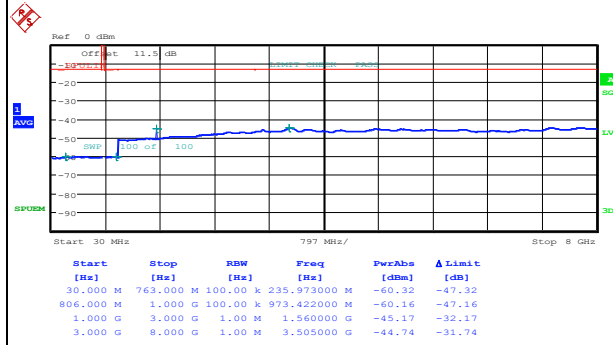

Date: 2.DEC.2014 14:41:08



LTE Band 13 / 5MHz

Highest Channel / QPSK

Highest Channel / 16QAM

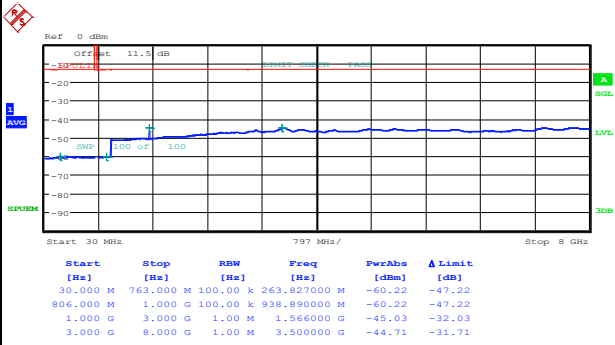

Date: 2.DEC.2014 14:45:04

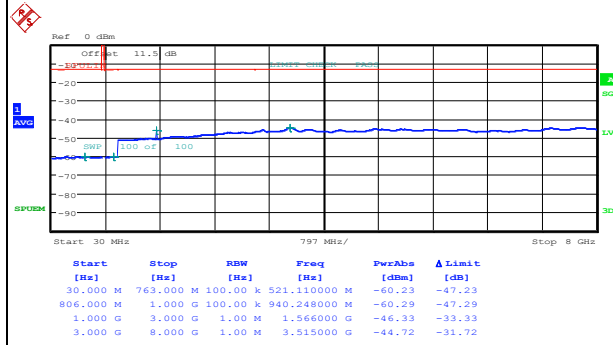

Date: 2.DEC.2014 14:46:14

LTE Band 13 / 10MHz

Middle Channel / QPSK

Middle Channel / 16QAM

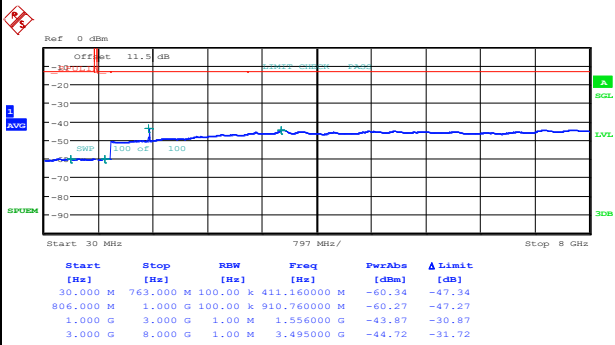

Date: 2.DEC.2014 14:49:27

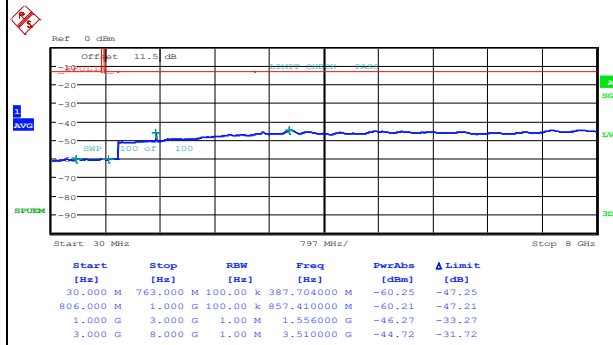

Date: 2.DEC.2014 14:48:16



Frequency Stability

Test Conditions		LTE Band 4 (QPSK) / Middle Channel	Limit
Temperature (°C)	Voltage (Volt)	BW 10MHz	Note 2.
		Deviation (ppm)	Result
50	Normal Voltage	0.0034	PASS
40	Normal Voltage	0.0104	
30	Normal Voltage	0.0107	
20(Ref.)	Normal Voltage	0.0000	
10	Normal Voltage	0.0010	
0	Normal Voltage	0.0007	
-10	Normal Voltage	0.0020	
-20	Normal Voltage	0.0021	
-30	Normal Voltage	0.0025	
20	Maximum Voltage	0.0083	
20	Normal Voltage	0.0000	
20	Battery End Point	0.0103	

Note:

1. Normal Voltage = 120 V. ; Battery End Point (BEP) = 100 V. ; Maximum Voltage =132 V
2. Note: The frequency fundamental emissions stay within the authorized frequency block based on the frequency deviation measured is small.



Test Conditions		LTE Band 13 (QPSK) / Middle Channel	Limit
Temperature (°C)	Voltage (Volt)	BW 10MHz	Note 2.
		Deviation (ppm)	Result
50	Normal Voltage	0.0027	PASS
40	Normal Voltage	0.0019	
30	Normal Voltage	0.0023	
20(Ref.)	Normal Voltage	0.0000	
10	Normal Voltage	0.0012	
0	Normal Voltage	0.0020	
-10	Normal Voltage	0.0129	
-20	Normal Voltage	0.0014	
-30	Normal Voltage	0.0136	
20	Maximum Voltage	0.0133	
20	Normal Voltage	0.0000	
20	Battery End Point	0.0022	

Note:

1. Normal Voltage = 120 V. ; Battery End Point (BEP) = 100 V. ; Maximum Voltage =132 V
2. Note: The frequency fundamental emissions stay within the authorized frequency block based on the frequency deviation measured is small.



Appendix B. Test Results of Radiated Test

ERP/EIRP

LTE Band 4 / 1.4MHz					
Channel	Modulation	Size	Offset	EIRP(dBm)	EIRP(W)
Lowest	QPSK	1	0	24.26	0.267
Middle		1	0	24.50	0.282
Highest		1	0	24.32	0.270
Lowest	16QAM	1	0	23.29	0.213
Middle		1	0	23.53	0.225
Highest		1	0	23.41	0.219
Limit	EIRP < 1W			Result	PASS

LTE Band 4 / 3MHz					
Channel	Modulation	Size	Offset	EIRP(dBm)	EIRP(W)
Lowest	QPSK	1	0	24.23	0.265
Middle		1	0	24.44	0.278
Highest		1	0	24.30	0.269
Lowest	16QAM	1	0	23.19	0.208
Middle		1	0	23.54	0.226
Highest		1	0	23.35	0.216
Limit	EIRP < 1W			Result	PASS

LTE Band 4 / 5MHz					
Channel	Modulation	Size	Offset	EIRP(dBm)	EIRP(W)
Lowest	QPSK	1	0	24.23	0.265
Middle		1	0	24.47	0.280
Highest		1	0	24.35	0.272
Lowest	16QAM	1	0	23.24	0.211
Middle		1	0	23.50	0.224
Highest		1	0	23.39	0.218
Limit	EIRP < 1W			Result	PASS



LTE Band 4 / 10MHz					
Channel	Modulation	Size	Offset	EIRP(dBm)	EIRP(W)
Lowest	QPSK	1	0	24.34	0.272
Middle		1	0	24.48	0.281
Highest		1	0	24.34	0.272
Lowest	16QAM	1	0	23.26	0.212
Middle		1	0	23.49	0.223
Highest		1	0	23.39	0.218
Limit	EIRP < 1W			Result	PASS

LTE Band 4 / 15MHz					
Channel	Modulation	Size	Offset	EIRP(dBm)	EIRP(W)
Lowest	QPSK	1	0	24.34	0.272
Middle		1	0	24.45	0.279
Highest		1	0	24.50	0.282
Lowest	16QAM	1	0	23.32	0.215
Middle		1	0	23.50	0.224
Highest		1	0	23.49	0.223
Limit	EIRP < 1W			Result	PASS

LTE Band 4 / 20MHz					
Channel	Modulation	Size	Offset	EIRP(dBm)	EIRP(W)
Lowest	QPSK	1	0	24.42	0.277
Middle		1	0	24.51	0.282
Highest		1	0	24.44	0.278
Lowest	16QAM	1	0	23.43	0.220
Middle		1	0	23.50	0.224
Highest		1	0	23.50	0.224
Limit	EIRP < 1W			Result	PASS



LTE Band 13 / 5MHz					
Channel	Modulation	Size	Offset	ERP(dBm)	ERP(W)
Lowest	QPSK	1	0	22.44	0.175
Middle		1	0	22.32	0.171
Highest		1	0	22.25	0.168
Lowest	16QAM	1	0	21.45	0.140
Middle		1	0	21.42	0.139
Highest		1	0	21.33	0.136
Limit	ERP < 3W			Result	PASS

LTE Band 13 / 10MHz					
Channel	Modulation	Size	Offset	ERP(dBm)	ERP(W)
Lowest	QPSK	1	0	-	-
Middle		1	0	22.45	0.176
Highest		1	0	-	-
Lowest	16QAM	1	0	-	-
Middle		1	0	21.33	0.136
Highest		1	0	-	-
Limit	ERP < 3W			Result	PASS



Radiated Spurious Emission

LTE Band 4 / 1.4MHz / QPSK / RB Size 1 Offset 0									
Channel	Frequency (MHz)	EIRP (dBm)	Limit (dBm)	Over Limit (dB)	SPA Reading (dBm)	S.G. Power (dBm)	TX Cable loss (dB)	TX Antenna Gain (dBi)	Polarization (H/V)
Lowest	3420	-36.55	-13	-23.55	-53.22	-42.62	1.58	7.65	H
	5128	-36.42	-13	-23.42	-59.21	-43.71	2.41	9.70	H
	6843	-33.21	-13	-20.21	-60.1	-41.18	2.64	10.61	H
	3420	-37.51	-13	-24.51	-53.52	-43.58	1.58	7.65	V
	5128	-37.37	-13	-24.37	-59.31	-44.66	2.41	9.70	V
	6843	-42.70	-13	-29.70	-69.26	-50.67	2.64	10.61	V
Middle	3462	-39.31	-13	-26.31	-56.39	-45.55	1.59	7.83	H
	5198	-47.38	-13	-34.38	-70	-54.63	2.45	9.70	H
	6927	-41.37	-13	-28.37	-68.58	-49.47	2.61	10.71	H
	3462	-40.54	-13	-27.54	-57.55	-46.78	1.59	7.83	V
	5198	-44.00	-13	-31.00	-66.23	-51.25	2.45	9.70	V
	6927	-48.43	-13	-35.43	-75.46	-56.53	2.61	10.71	V
Highest	3511	-34.10	-13	-21.10	-51.48	-40.51	1.61	8.01	H
	5261	-35.73	-13	-22.73	-58.5	-42.94	2.49	9.70	H
	7018	-31.75	-13	-18.75	-59.26	-40	2.58	10.84	H
	3511	-35.88	-13	-22.88	-53.55	-42.29	1.61	8.01	V
	5261	-32.67	-13	-19.67	-55.56	-39.88	2.49	9.70	V
	7018	-40.90	-13	-27.90	-68.48	-49.15	2.58	10.84	V

Remark: Spurious emissions within 30-1000MHz were found more than 20dB below limit line.



LTE Band 4 / 3MHz / QPSK / RB Size 1 Offset 0									
Channel	Frequency (MHz)	EIRP (dBm)	Limit (dBm)	Over Limit (dB)	SPA Reading (dBm)	S.G. Power (dBm)	TX Cable loss (dB)	TX Antenna Gain (dBi)	Polarization (H/V)
Lowest	3420	-37.45	-13	-24.45	-53.42	-43.52	1.58	7.65	H
	5130	-41.34	-13	-28.34	-63.48	-48.63	2.41	9.70	H
	6840	-36.54	-13	-23.54	-62.89	-44.51	2.64	10.61	H
	3420	-41.45	-13	-28.45	-57.07	-47.52	1.58	7.65	V
	5128	-44.90	-13	-31.90	-66.19	-52.19	2.41	9.70	V
	6840	-44.06	-13	-31.06	-70.12	-52.03	2.64	10.61	V
Middle	3462	-40.78	-13	-27.78	-57.1	-47.02	1.59	7.83	H
	5193	-44.04	-13	-31.04	-66.25	-51.29	2.45	9.70	H
	6924	-43.00	-13	-30.00	-69.54	-51.09	2.62	10.71	H
	3462	-43.28	-13	-30.28	-59.59	-49.52	1.59	7.83	V
	5191	-42.97	-13	-29.97	-64.33	-50.22	2.45	9.70	V
	6924	-48.27	-13	-35.27	-74.64	-56.36	2.62	10.71	V
Highest	3504	-34.12	-13	-21.12	-51.27	-40.52	1.61	8.00	H
	5254	-38.30	-13	-25.30	-60.47	-45.52	2.48	9.70	H
	7011	-35.39	-13	-22.39	-62.47	-43.63	2.59	10.82	H
	3504	-35.68	-13	-22.68	-52.57	-42.08	1.61	8.00	V
	5254	-35.99	-13	-22.99	-58	-43.21	2.48	9.70	V
	7011	-43.72	-13	-30.72	-70.67	-51.96	2.59	10.82	V

Remark: Spurious emissions within 30-1000MHz were found more than 20dB below limit line.



LTE Band 4 / 5MHz / QPSK / RB Size 1 Offset 0									
Channel	Frequency (MHz)	EIRP (dBm)	Limit (dBm)	Over Limit (dB)	SPA Reading (dBm)	S.G. Power (dBm)	TX Cable loss (dB)	TX Antenna Gain (dBi)	Polarization (H/V)
Lowest	3420	-39.10	-13	-26.10	-54.83	-45.17	1.58	7.65	H
	5128	-41.92	-13	-28.92	-64.07	-49.21	2.41	9.70	H
	6843	-34.55	-13	-21.55	-61.68	-42.52	2.64	10.61	H
	3420	-39.45	-13	-26.45	-54.92	-45.52	1.58	7.65	V
	5128	-39.96	-13	-26.96	-61.39	-47.25	2.41	9.70	V
	6843	-43.66	-13	-30.66	-70.12	-51.63	2.64	10.61	V
Middle	3462	-40.97	-13	-27.97	-57.48	-47.21	1.59	7.83	H
	5191	-43.99	-13	-30.99	-66.07	-51.24	2.45	9.70	H
	6920	-43.14	-13	-30.14	-69.48	-51.23	2.62	10.70	H
	3462	-43.88	-13	-30.88	-60.02	-50.12	1.59	7.83	V
	5191	-43.11	-13	-30.11	-65.1	-50.36	2.45	9.70	V
	6920	-48.32	-13	-35.32	-74.6	-56.41	2.62	10.70	V
Highest	3504	-32.82	-13	-19.82	-49.65	-39.22	1.61	8.00	H
	5254	-36.30	-13	-23.30	-58.54	-43.52	2.48	9.70	H
	7004	-35.77	-13	-22.77	-62.49	-43.99	2.59	10.81	H
	3504	-36.85	-13	-23.85	-54.01	-43.25	1.61	8.00	V
	5254	-37.79	-13	-24.79	-59.96	-45.01	2.48	9.70	V
	7004	-42.05	-13	-29.05	-68.91	-50.27	2.59	10.81	V

Remark: Spurious emissions within 30-1000MHz were found more than 20dB below limit line.



LTE Band 4 / 10MHz / QPSK / RB Size 1 Offset 0									
Channel	Frequency (MHz)	EIRP (dBm)	Limit (dBm)	Over Limit (dB)	SPA Reading (dBm)	S.G. Power (dBm)	TX Cable loss (dB)	TX Antenna Gain (dBi)	Polarization (H/V)
Lowest	3420	-36.98	-13	-23.98	-52.74	-43.05	1.58	7.65	H
	5135	-41.72	-13	-28.72	-63.8	-49.01	2.41	9.70	H
	6843	-36.55	-13	-23.55	-62.9	-44.52	2.64	10.61	H
	3420	-38.21	-13	-25.21	-53.5	-44.28	1.58	7.65	V
	5135	-37.92	-13	-24.92	-59.22	-45.21	2.41	9.70	V
	6843	-43.46	-13	-30.46	-69.75	-51.43	2.64	10.61	V
Middle	3455	-43.42	-13	-30.42	-59.85	-49.63	1.59	7.80	H
	5183	-42.26	-13	-29.26	-64.29	-49.52	2.44	9.70	H
	6913	-46.44	-13	-33.44	-72.87	-54.52	2.62	10.70	H
	3455	-42.31	-13	-29.31	-58.23	-48.52	1.59	7.80	V
	5183	-40.95	-13	-27.95	-62.46	-48.21	2.44	9.70	V
	6910	-43.41	-13	-30.41	-69.39	-51.48	2.62	10.69	V
Highest	3490	-33.17	-13	-20.17	-49.72	-39.52	1.60	7.96	H
	5235	-39.29	-13	-26.29	-61.28	-46.52	2.47	9.70	H
	6980	-35.27	-13	-22.27	-62.19	-43.45	2.60	10.78	H
	3490	-36.17	-13	-23.17	-53	-42.52	1.60	7.96	V
	5233	-38.45	-13	-25.45	-60.36	-45.68	2.47	9.70	V
	6983	-42.06	-13	-29.06	-69.04	-50.24	2.60	10.78	V

Remark: Spurious emissions within 30-1000MHz were found more than 20dB below limit line.



LTE Band 4 / 15MHz / QPSK / RB Size 1 Offset 0									
Channel	Frequency (MHz)	EIRP (dBm)	Limit (dBm)	Over Limit (dB)	SPA Reading (dBm)	S.G. Power (dBm)	TX Cable loss (dB)	TX Antenna Gain (dBi)	Polarization (H/V)
Lowest	3420	-37.50	-13	-24.50	-53.96	-43.57	1.58	7.65	H
	5135	-35.47	-13	-22.47	-58.14	-42.76	2.41	9.70	H
	6843	-34.78	-13	-21.78	-61.64	-42.75	2.64	10.61	H
	3420	-37.98	-13	-24.98	-54.2	-44.05	1.58	7.65	V
	5135	-38.00	-13	-25.00	-60.02	-45.29	2.41	9.70	V
	6843	-43.06	-13	-30.06	-69.6	-51.03	2.64	10.61	V
Middle	3455	-43.65	-13	-30.65	-60.47	-49.86	1.59	7.80	H
	5177	-37.85	-13	-24.85	-60.62	-45.11	2.44	9.70	H
	6906	-37.46	-13	-24.46	-64.53	-45.53	2.62	10.69	H
	3455	-44.73	-13	-31.73	-61.32	-50.94	1.59	7.80	V
	5177	-38.89	-13	-25.89	-61.02	-46.15	2.44	9.70	V
	6906	-44.86	-13	-31.86	-71.74	-52.93	2.62	10.69	V
Highest	3483	-34.93	-13	-21.93	-52.12	-41.26	1.60	7.93	H
	5226	-38.11	-13	-25.11	-60.68	-45.34	2.47	9.70	H
	6962	-33.51	-13	-20.51	-60.85	-41.66	2.60	10.75	H
	3483	-36.69	-13	-23.69	-53.91	-43.02	1.60	7.93	V
	5226	-37.77	-13	-24.77	-60.4	-45	2.47	9.70	V
	6962	-41.60	-13	-28.60	-68.58	-49.75	2.60	10.75	V

Remark: Spurious emissions within 30-1000MHz were found more than 20dB below limit line.



LTE Band 4 / 20MHz / QPSK / RB Size 1 Offset 0									
Channel	Frequency (MHz)	EIRP (dBm)	Limit (dBm)	Over Limit (dB)	SPA Reading (dBm)	S.G. Power (dBm)	TX Cable loss (dB)	TX Antenna Gain (dBi)	Polarization (H/V)
Lowest	3420	-36.02	-13	-23.02	-52.62	-42.09	1.58	7.65	H
	5135	-33.03	-13	-20.03	-55.8	-40.32	2.41	9.70	H
	6843	-34.98	-13	-21.98	-61.88	-42.95	2.64	10.61	H
	3420	-38.82	-13	-25.82	-54.94	-44.89	1.58	7.65	V
	5135	-37.57	-13	-24.57	-59.13	-44.86	2.41	9.70	V
	6843	-42.64	-13	-29.64	-69.13	-50.61	2.64	10.61	V
Middle	3448	-42.56	-13	-29.56	-59.39	-48.74	1.59	7.77	H
	5170	-37.42	-13	-24.42	-60.05	-44.69	2.43	9.70	H
	6892	-36.70	-13	-23.70	-63.73	-44.75	2.63	10.67	H
	3448	-43.59	-13	-30.59	-60.2	-49.77	1.59	7.77	V
	5170	-39.12	-13	-26.12	-61.29	-46.39	2.43	9.70	V
	6892	-43.69	-13	-30.69	-70.5	-51.74	2.63	10.67	V
Highest	3469	-37.85	-13	-24.85	-54.81	-44.12	1.59	7.86	H
	5205	-37.99	-13	-24.99	-60.65	-45.23	2.46	9.70	H
	6948	-35.92	-13	-22.92	-63.22	-44.05	2.61	10.74	H
	3469	-39.03	-13	-26.03	-55.95	-45.3	1.59	7.86	V
	5205	-39.78	-13	-26.78	-61.93	-47.02	2.46	9.70	V
	6948	-44.15	-13	-31.15	-71.24	-52.28	2.61	10.74	V

Remark: Spurious emissions within 30-1000MHz were found more than 20dB below limit line.



LTE Band 13 / 5MHz / QPSK / RB Size 1 Offset 0									
Channel	Frequency (MHz)	ERP (dBm)	Limit (dBm)	Over Limit (dB)	SPA Reading (dBm)	S.G. Power (dBm)	TX Cable loss (dB)	TX Antenna Gain (dBi)	Polarization (H/V)
Lowest	1552	-53.14	-13	-40.14	-62.50	-55.21	0.94	5.15	H
	2336	-54.22	-13	-41.22	-66.71	-55.74	1.24	4.91	H
	3112	-57.62	-13	-44.62	-74.63	-60.28	1.48	6.29	H
	3888	-53.07	-13	-40.07	-73.26	-57.66	1.73	8.47	H
	1552	-53.91	-13	-40.91	-61.62	-55.98	0.94	5.15	V
	2336	-54.22	-13	-41.22	-68.53	-55.74	1.24	4.91	V
	3112	-57.03	-13	-44.03	-72.78	-59.69	1.48	6.29	V
	3888	-55.42	-13	-42.42	-73.98	-60.01	1.73	8.47	V
Middle	1559	-57.81	-42.15	-15.66	-67.09	-59.86	0.94	5.13	H
	2338.5	-51.69	-13	-38.69	-64.34	-53.21	1.24	4.91	H
	3118	-56.95	-13	-43.95	-73.46	-59.63	1.48	6.32	H
	3896	-53.25	-13	-40.25	-73.10	-57.85	1.73	8.48	H
	1559	-59.23	-42.15	-17.08	-66.39	-61.28	0.94	5.13	V
	2338.5	-48.72	-13	-35.72	-63.39	-50.24	1.24	4.91	V
	3118	-57.01	-13	-44.01	-72.79	-59.69	1.48	6.32	V
	3896	-55.01	-13	-42.01	-73.74	-59.61	1.73	8.48	V
Highest	1568	-51.96	-42.15	-9.81	-52.15	-53.98	0.94	5.11	H
	2344	-51.85	-13	-38.85	-52.44	-53.39	1.24	4.93	H
	3128	-59.32	-13	-46.32	-60.18	-62.05	1.49	6.36	H
	3910	-55.51	-13	-42.51	-56.09	-60.12	1.73	8.49	H
	1568	-55.87	-42.15	-13.72	-56.13	-57.89	0.94	5.11	V
	2344	-48.75	-13	-35.75	-36.52	-50.29	1.24	4.93	V
	3128	-59.48	-13	-46.48	-47.03	-62.21	1.49	6.36	V
	3910	-56.83	-13	-43.83	-44.33	-61.44	1.73	8.49	V

Remark: Spurious emissions within 30-1000MHz were found more than 20dB below limit line.

LTE Band 13 / 10MHz / QPSK / RB Size 1 Offset 0									
Channel	Frequency (MHz)	ERP (dBm)	Limit (dBm)	Over Limit (dB)	SPA Reading (dBm)	S.G. Power (dBm)	TX Cable loss (dB)	TX Antenna Gain (dBi)	Polarization (H/V)
Middle	1552	-52.22	-13	-39.22	-62.12	-54.29	0.94	5.15	H
	2336	-55.51	-13	-42.51	-68.35	-57.03	1.24	4.91	H
	3112	-56.66	-13	-43.66	-73.24	-59.32	1.48	6.29	H
	3888	-53.09	-13	-40.09	-73.18	-57.68	1.73	8.47	H
	1552	-54.94	-13	-41.94	-62.05	-57.01	0.94	5.15	V
	2336	-54.02	-13	-41.02	-68.23	-55.54	1.24	4.91	V
	3112	-57.67	-13	-44.67	-73.72	-60.33	1.48	6.29	V
	3888	-54.73	-13	-41.73	-73.45	-59.32	1.73	8.47	V

Remark: Spurious emissions within 30-1000MHz were found more than 20dB below limit line.