

# FCC SAR TEST REPORT

**Application No.:** KSEM2008001026CR  
**Applicant:** DT Research, Inc.  
**Address of Applicant:** 3RD FL NO 36 WUQUAN 7TH RD WUGU DISTRICT, NEW TAIPEI, Taiwan  
**Manufacturer:** DT Research, Inc.  
**Address of Manufacturer:** 2000 Concourse Drive, San Jose, CA 95131, USA  
**Factory:** DT Research, Inc.  
**Address of Factory:** 6F.,No.36 Wuquan 7 th Rd., Wugu Dist.New Taipei City 248 Taiwan  
**Product Name:** Rugged Tablet  
**Model No.(EUT):** DT300Q11  
**Series Model:** DT300Qxx (x=blank, A~Z or 0~9).  
**Trade mark:** DT Research, Inc.  
**FCC ID:** YE3600-SC600TA  
**Standard(s) :** FCC 47CFR §2.1093  
**Date of Receipt:** 2020-08-10  
**Date of Test:** 2020-09-09 to 2020-09-11  
**Date of Issue:** 2020-09-17

<b>Test Result:</b>	<b>Pass*</b>
---------------------	--------------

\* In the configuration tested, the EUT complied with the standards specified above.

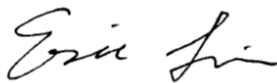

Eric Lin

Laboratory Manager

The manufacturer should ensure that all products in series production are in conformity with the product sample detailed in this report.

If the product in this report is used in any configuration other than that detailed in the report, the manufacturer must ensure the new system complies with all relevant standards. Any mention of SGS International Electrical Approvals or testing done by SGS International Electrical Approvals in connection with, distribution or use of the product described in this report must be approved by SGS International Electrical Approvals in writing.



Unless otherwise agreed in writing, this document is issued by the Company subject to its General Conditions of Service printed overleaf, available on request or accessible at <http://www.sgs.com/en/Terms-and-Conditions.aspx> and, for electronic format documents, subject to Terms and Conditions for Electronic Documents at <http://www.sgs.com/en/Terms-and-Conditions/Terms-e-Documents.aspx>. Attention is drawn to the limitation of liability, indemnification and jurisdiction issues defined therein. Any holder of this document is advised that information contained hereon reflects the Company's findings at the time of its intervention only and within the limits of Client's instructions, if any. The Company's sole responsibility is to its Client and this document does not exonerate parties to a transaction from exercising all their rights and obligations under the transaction documents. This document cannot be reproduced except in full, without prior written approval of the Company. Any unauthorized alteration, forgery or falsification of the content or appearance of this document is unlawful and offenders may be prosecuted to the fullest extent of the law. Unless otherwise stated the results shown in this test report refer only to the sample(s) tested and such sample(s) are retained for 30 days only.  
**Attention: To check the authenticity of testing/inspection report & certificate, please contact us at telephone: (86-755) 8307 1443, or email: CN.Doccheck@sgs.com**

No.10, Weiye Road, Innovation Park, Kunshan, Jiangsu, China 215300  
 中国·江苏·昆山市留学院创业园伟业路10号 邮编 215300

t(86-512)57355888 f(86-512)57370818 www.sgs.com.cn  
 t(86-512)57355888 f(86-512)57370818 sgs.china@sgs.com

## REVISION HISTORY

Revision Record			
Version	Description	Date	Remark
00	Original	2020-09-17	Original

<b>Authorized for issue by:</b>				
		<b>Richard.Kong/ Project Engineer</b>		
		<b>Eric.Lin/Reviewer</b>		

## TEST SUMMARY

Frequency Band	Test Position	Maximum Reported SAR(W/kg)	SAR limit (W/kg)
Bluetooth	Body	0.02	1.6
WI-FI (2.4GHz)	Body	0.04	1.6
WI-FI (5GHz)	Body	0.32	1.6

## CONTENTS

<b>1</b>	<b>GENERAL INFORMATION .....</b>	<b>6</b>
1.1	GENERAL DESCRIPTION OF EUT .....	6
1.1.1	<i>DUT Antenna Locations(Back View)</i> .....	7
1.2	DESCRIPTION OF SUPPORT EQUIPMENT .....	8
1.3	TEST SPECIFICATION.....	9
1.4	RF EXPOSURE LIMITS .....	10
1.5	TEST LOCATION .....	11
1.6	TEST FACILITY .....	11
<b>2</b>	<b>LABORATORY ENVIRONMENT .....</b>	<b>12</b>
<b>3</b>	<b>SAR MEASUREMENTS SYSTEM CONFIGURATION.....</b>	<b>13</b>
3.1	THE SAR MEASUREMENT SYSTEM .....	13
3.2	ISOTROPIC E-FIELD PROBE EX3DV4 .....	14
3.3	DATA ACQUISITION ELECTRONICS (DAE) .....	15
3.4	SAM TWIN PHANTOM.....	15
3.5	ELI PHANTOM .....	16
3.6	LAPTOP HOLDER FOR ELI PHANTOM.....	17
3.7	MEASUREMENT PROCEDURE.....	18
3.7.1	<i>Scanning procedure</i> .....	18
3.7.2	<i>Data Storage</i> .....	20
3.7.3	<i>Data Evaluation by SEMCAD</i> .....	20
<b>4</b>	<b>SAR MEASUREMENT VARIABILITY AND UNCERTAINTY .....</b>	<b>22</b>
4.1	SAR MEASUREMENT VARIABILITY .....	22
4.2	SAR MEASUREMENT UNCERTAINTY .....	23
<b>5</b>	<b>DESCRIPTION OF TEST POSITION .....</b>	<b>24</b>
5.1	THE BODY TEST POSITION.....	24
<b>6</b>	<b>SAR SYSTEM VERIFICATION PROCEDURE .....</b>	<b>25</b>
6.1	TISSUE SIMULATE LIQUID.....	25
6.1.1	<i>Recipes for Tissue Simulate Liquid</i> .....	25
6.1.2	<i>Test Liquids Confirmation</i> .....	26
6.1.3	<i>Measurement for Tissue Simulate Liquid</i> .....	27
6.2	SAR SYSTEM CHECK .....	28
6.2.1	<i>Justification for Extended SAR Dipole Calibrations</i> .....	29
6.2.2	<i>Summary System Check Result(s)</i> .....	30
6.2.3	<i>Detailed System Check Results</i> .....	30
<b>7</b>	<b>TEST CONFIGURATION.....</b>	<b>31</b>
7.1	OPERATION CONFIGURATIONS .....	31
7.1.1	<i>Wi-Fi Test Configuration</i> .....	31
7.1.2	<i>Bluetooth Test Configuration</i> .....	36
<b>8</b>	<b>TEST RESULT .....</b>	<b>37</b>
8.1	MEASUREMENT OF RF CONDUCTED POWER .....	37
8.1.1	<i>Conducted Power Of Wi-Fi and BT</i> .....	38
8.2	STAND-ALONE SAR TEST EVALUATION .....	40
8.3	BODY TEST EXCLUSION THRESHOLDS.....	41
8.4	MEASUREMENT OF SAR DATA .....	42
8.4.1	<i>SAR Result Of 2.4GHz Wi-Fi</i> .....	42
8.4.2	<i>SAR Result Of Bluetooth</i> .....	43

8.4.3	SAR Result Of 5GHz Wi-Fi .....	44
8.4.4	Repeat SAR Measurement .....	45
8.5	MULTIPLE TRANSMITTER EVALUATION.....	46
8.5.1	Simultaneous SAR SAR test evaluation.....	46
<b>9</b>	<b>EQUIPMENT LIST .....</b>	<b>47</b>
<b>10</b>	<b>CALIBRATION CERTIFICATE.....</b>	<b>48</b>
<b>11</b>	<b>PHOTOGRAPHS .....</b>	<b>48</b>
	<b>APPENDIX A: DETAILED SYSTEM CHECK RESULTS .....</b>	<b>49</b>
	<b>APPENDIX B: DETAILED TEST RESULTS .....</b>	<b>54</b>
	<b>APPENDIX C: CALIBRATION CERTIFICATE .....</b>	<b>60</b>
	<b>APPENDIX D: PHOTOGRAPHS.....</b>	<b>60</b>

# 1 General Information

## 1.1 General Description of EUT

Device Type :	portable device		
Exposure Category:	uncontrolled environment / general population		
Product Phase:	production unit		
SN:	11QW12021J203		
Hardware Version:	QY301 V1.1.P		
Software Version:	1.0.1.0		
Antenna Type:	PIFA Antenna		
Device Operating Configurations :			
Modulation Mode:	<b>WI-FI:</b> CCK, DSSS, OFDM; <b>BT:</b> GFSK, π/4DQPSK,8DPSK		
Device Class:	B		
Frequency Bands:	Band	Tx (MHz)	Rx (MHz)
	WI-FI2.4G	2412~2462	2412~2462
	Bluetooth	2402~2480	2402~2480
	Wi-Fi(U-NII-1)	5150~5250	5150~5250
	Wi-Fi(U-NII-2A)	5250~5350	5250~5350
	Wi-Fi(U-NII-2C)	5470~5700	5470~5700
Battery Information:	Model: ACC-006-311K		
	Rated capacity: 7.6V, 6000mAh, 45.6Wh		
	Manufacturer: Guangdong Pow-Tech New Power Co.,Ltd.		

Note:

The antenna gain value is provided by the customer. The test lab will not be responsible for wrong test result due to incorrect information about antenna gain values.

### 1.1.1 DUT Antenna Locations(Back View)

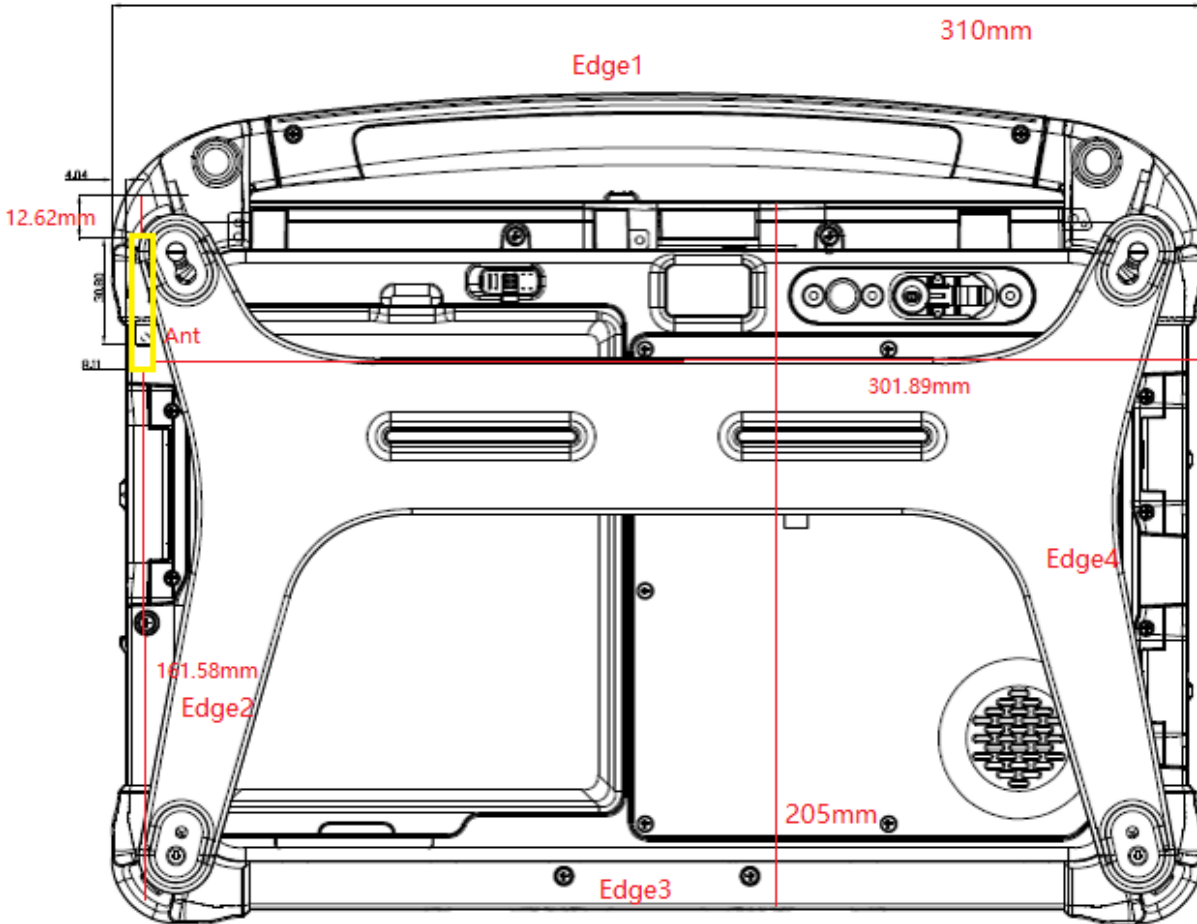

The test device is a Rugged Tablet. The display diagonal dimension is 253mm and the overall diagonal dimension of this device is 324mm.

According to the distance between Wi-Fi/BT antennas and the sides of the EUT we can draw the conclusion that:

EUT Sides for SAR Testing					
Mode	Bottom Face	Edge 1	Edge 2	Edge 3	Edge 4
Distance(mm)	0	12.62	0	161.58	301.89
2.4G Wi-Fi	Yes	Yes	Yes	No	No
5G Wi-Fi	Yes	Yes	Yes	No	No
Bluetooth	Yes	Yes	Yes	No	No

Table 1: EUT Sides for SAR Testing

Note:

- 1) Details please see Section 8.2 and 8.3

## 1.2 Description of Support Equipment

Description	Rugged Tablet
Manufacturer	DT Research, Inc.
Model No.(EUT)	DT300Q11
Serial No.	DT300Qxx (x=blank, A~Z or 0~9).
Model Discrepancy	Market segmentation

Model No.: DT300Q11, DT300Qxx (x=blank, A~Z or 0~9).

Only the model DT300Q11 was tested, since the circuit design, PCB layout, electrical components used, internal wiring and functions were identical for the above models, with only different on the Model no.

Description	LTE Module
Manufacturer	Quectel Wireless Solutions Co. Ltd
Model No.(EUT)	SC600Y-NA, SC600T-NA



### 1.3 Test Specification

Identity	Document Title
FCC 47CFR §2.1093	Radio frequency Radiation Exposure Evaluation: Portable Devices
ANSI/IEEE Std C95.1 – 1992	Safety Levels with Respect to Human Exposure to Radio Frequency Electromagnetic Fields, 3 kHz – 300 GHz.
IEEE 1528-2013	Recommended Practice for Determining the Peak Spatial-Average Specific Absorption Rate (SAR) in the Human Head from Wireless Communications Devices: Measurement Techniques
KDB 248227 D01 802.11 Wi-Fi SAR v02r02	SAR GUIDANCE FOR IEEE 802.11 (Wi-Fi) TRANSMITTERS
KDB 616217 D04 SAR for laptop and tablets v01r02	SAR EVALUATION CONSIDERATIONS FOR LAPTOP, NOTEBOOK, NETBOOK AND TABLET COMPUTERS
KDB447498 D01 General RF Exposure Guidance v06	Mobile and Portable Devices RF Exposure Procedures and Equipment Authorization Policies
KDB 865664 D01 SAR Measurement 100 MHz to 6 GHz v01r04	SAR Measurement Requirements for 100 MHz to 6 GHz
KDB 865664 D02 RF Exposure Reporting v01r02	RF Exposure Compliance Reporting and Documentation Considerations

## 1.4 RF exposure limits

Human Exposure	Uncontrolled Environment General Population	Controlled Environment Occupational
<b>Spatial Peak SAR*</b> (Brain*Trunk)	<b>1.60 W/kg</b>	8.00 W/kg
<b>Spatial Average SAR**</b> (Whole Body)	0.08 W/kg	0.40 W/kg
<b>Spatial Peak SAR***</b> (Hands/Feet/Ankle/Wrist)	4.00 W/kg	20.00 W/kg

### Notes:

\* The Spatial Peak value of the SAR averaged over any 1 gram of tissue (defined as a tissue volume in the shape of a cube) and over the appropriate averaging time

\*\* The Spatial Average value of the SAR averaged over the whole body.

\*\*\* The Spatial Peak value of the SAR averaged over any 10 grams of tissue (defined as a tissue volume in the shape of a cube) and over the appropriate averaging time.

**Uncontrolled Environments** are defined as locations where there is the exposure of individuals who have no knowledge or control of their exposure.

**Controlled Environments** are defined as locations where there is exposure that may be incurred by persons who are aware of the potential for exposure, (i.e. as a result of employment or occupation.)

## 1.5 Test Location

Company: Compliance Certification Services Inc. Kun shan Laboratory  
Address: No.10 Weiye Rd., Innovation park, Eco&Tec, Development Zone, Kunshan City, Jiangsu, China  
Post code: 215300  
Telephone: 86-512-57355888  
Fax: 86-512-57370818  
E-mail: [sgs.china@sgs.com](mailto:sgs.china@sgs.com)

## 1.6 Test Facility

The test facility is recognized, certified, or accredited by the following organizations:

- **CNAS (No. CNAS L4354)**

CNAS has accredited Compliance Certification Services (Kunshan) Inc. to ISO/IEC 17025:2017 General Requirements for the Competence of Testing and Calibration Laboratories (CNAS-CL01 Accreditation Criteria for the Competence of Testing and Calibration Laboratories) for the competence in the field of testing.

- **A2LA (Certificate No. 2541.01)**

Compliance Certification Services (Kunshan) Inc. is accredited by the American Association for Laboratory Accreditation (A2LA). Certificate No. 2541.01.

- **FCC –Designation Number: CN1172**

Compliance Certification Services Inc. has been recognized as an accredited testing laboratory.

Designation Number: CN1172.

- **ISED (CAB identifier: CN0072)**

Compliance Certification Services (Kunshan) Inc. has been recognized by Innovation, Science and Economic Development Canada (ISED) as an accredited testing laboratory

CAB Identifier: CN0072.

- **VCCI (Member No.: 1938)**

The 3m and 10m Semi-anechoic chamber and Shielded Room of Compliance Certification Services (Kunshan) Inc. has been registered in accordance with the Regulations for Voluntary Control Measures with Registration No.: R-1600, C-1707, T-1499, G-10216 respectively.

## 2 Laboratory Environment

Temperature	Min. = 18°C, Max. = 25 °C
Relative humidity	Min. = 30%, Max. = 70%
Ground system resistance	< 0.5 Ω
Ambient noise is checked and found very low and in compliance with requirement of standards. Reflection of surrounding objects is minimized and in compliance with requirement of standards.	

Table 2: The Ambient Conditions

### 3 SAR Measurements System Configuration

#### 3.1 The SAR Measurement System

This SAR Measurement System uses a Computer-controlled 3-D stepper motor system (SPEAG DASY5 professional system). A E-field probe is used to determine the internal electric fields. The SAR can be obtained from the equation  $SAR = \sigma (|E|^2) / \rho$  where  $\sigma$  and  $\rho$  are the conductivity and mass density of the tissue-Simulate.

The DASY5 system for performing compliance tests consists of the following items:

A standard high precision 6-axis robot (Stabile RX family) with controller, teach pendant and software .An arm extension for accommodation the data acquisition electronics (DAE).

A dosimetric probe, i.e., an isotropic E-field probe optimized and calibrated for usage in tissue simulating liquid. The probe is equipped with an optical surface detector system.

A data acquisition electronics (DAE) which performs the signal amplification, signal multiplexing, AD-conversion, offset measurements, mechanical surface detection, collision detection, etc. The unit is battery powered with standard or rechargeable batteries. The signal is optically transmitted to the EOC.

The Electro-optical converter (EOC) performs the conversion between optical and electrical of the signals for the digital communication to DAE and for the analog signal from the optical surface detection. The EOC is connected to the measurement server.

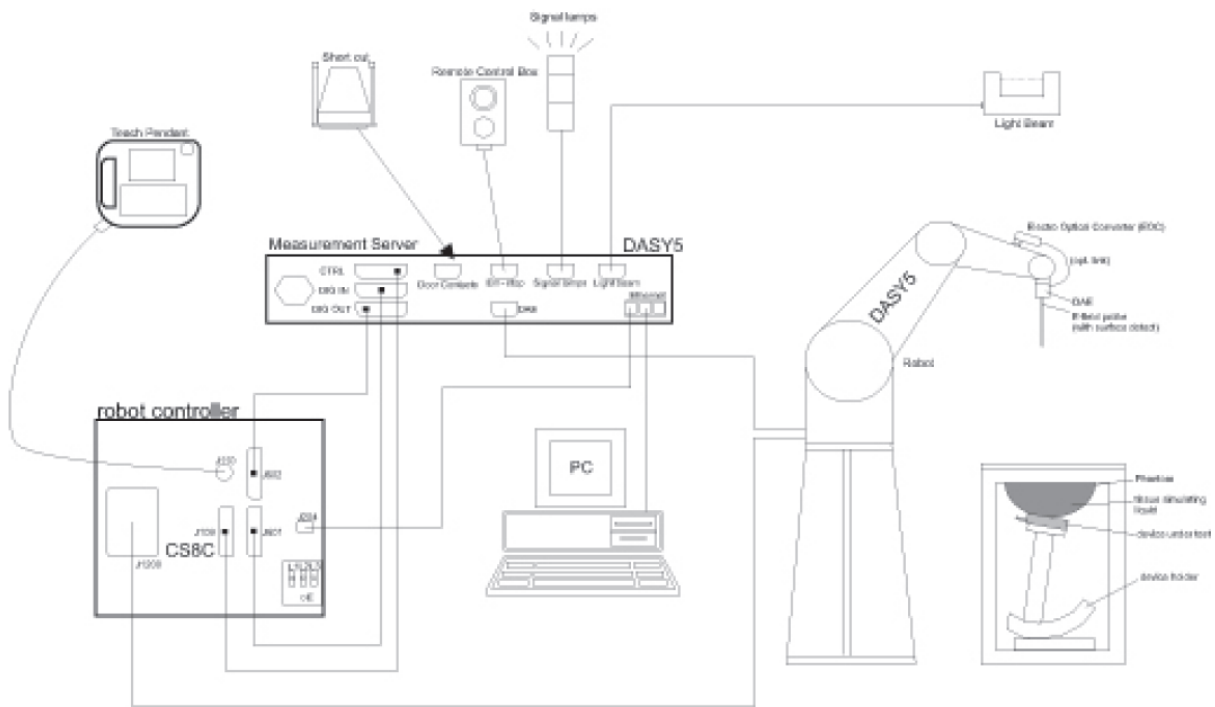

F-1. SAR Measurement System Configuration

- The function of the measurement server is to perform the time critical tasks such as signal filtering, control of the robot operation and fast movement interrupts.

- A probe alignment unit which improves the (absolute) accuracy of the probe positioning.
- A computer operating Windows 7.
- DASY5 software.
- Remote control with teach pendant and additional circuitry for robot safety such as warning lamps, etc.
- The SAM twin phantom enabling testing left-hand, right-hand and Body Worn usage.
- The device holder for handheld mobile phones.
- Tissue simulating liquid mixed according to the given recipes.
- Validation dipole kits allowing to validate the proper functioning of the system.

### 3.2 Isotropic E-field Probe EX3DV4

	<p>Symmetrical design with triangular core Built-in shielding against static charges PEEK enclosure material (resistant to organic solvents, e.g., DGBE)</p>
<p><b>Calibration</b></p>	<p>ISO/IEC 17025 <a href="#">calibration service</a> available.</p>
<p><b>Frequency</b></p>	<p>10 MHz to &gt; 6 GHz Linearity: <math>\pm 0.2</math> dB (30 MHz to 6 GHz)</p>
<p><b>Directivity</b></p>	<p><math>\pm 0.3</math> dB in TSL (rotation around probe axis) <math>\pm 0.5</math> dB in TSL (rotation normal to probe axis)</p>
<p><b>Dynamic Range</b></p>	<p>10 <math>\mu</math>W/g to &gt; 100 mW/g Linearity: <math>\pm 0.2</math> dB (noise: typically &lt; 1 <math>\mu</math>W/g)</p>
<p><b>Dimensions</b></p>	<p>Overall length: 337 mm (Tip: 20 mm) Tip diameter: 2.5 mm (Body: 12 mm) Typical distance from probe tip to dipole centers: 1 mm</p>
<p><b>Application</b></p>	<p>High precision dosimetric measurements in any exposure scenario (e.g., very strong gradient fields); the only probe that enables compliance testing for frequencies up to 6 GHz with precision of better 30%.</p>
<p><b>Compatibility</b></p>	<p>DASY3, DASY4, DASY52 SAR and higher, EASY4/MRI</p>

### 3.3 Data Acquisition Electronics (DAE)

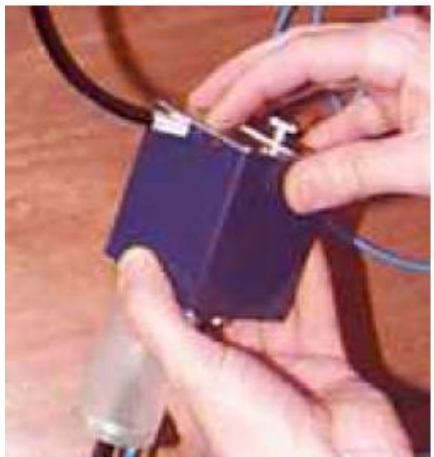
<b>Model</b>	DAE4	
<b>Construction</b>	Signal amplifier, multiplexer, A/D converter and control logic. Serial optical link for communication with DASY4/5 embedded system (fully remote controlled). Two step probe touch detector for mechanical surface detection and emergency robot stop.	
<b>Measurement Range</b>	-100 to +300 mV (16 bit resolution and two range settings: 4mV,400mV)	
<b>Input Offset Voltage</b>	< 5µV (with auto zero)	
<b>Input Bias Current</b>	< 50 f A	
<b>Dimensions</b>	60 x 60 x 68 mm	

### 3.4 SAM Twin Phantom

<b>Material</b>	Vinylester, glass fiber reinforced (VE-GF)	
<b>Liquid Compatibility</b>	Compatible with all SPEAG tissue simulating liquids (incl. DGBE type)	
<b>Shell Thickness</b>	2 ± 0.2 mm (6 ± 0.2 mm at ear point)	
<b>Dimensions (incl. Wooden Support)</b>	Length: 1000 mm Width: 500 mm Height: adjustable feet	
<b>Filling Volume</b>	approx. 25 liters	
<b>Wooden Support</b>	SPEAG standard phantom table	

The shell corresponds to the specifications of the Specific Anthropomorphic Mannequin (SAM) phantom defined in IEEE 1528 and IEC 62209-1. It enables the dosimetric evaluation of left and right hand phone usage as well as body mounted usage at the flat phantom region. A cover prevents evaporation of the liquid. Reference markings on the phantom allow the complete setup of all predefined phantom positions and measurement grids by teaching three points with the robot.

Twin SAM V5.0 has the same shell geometry and is manufactured from the same material as Twin SAM V4.0, but has reinforced top structure.



### 3.5 ELI Phantom

<b>Material</b>	Vinylester, glass fiber reinforced (VE-GF)	
<b>Liquid Compatibility</b>	Compatible with all SPEAG tissue simulating liquids (incl. DGBE type)	
<b>Shell Thickness</b>	2.0 ± 0.2 mm (bottom plate)	
<b>Dimensions</b>	Major axis: 600 mm Minor axis: 400 mm	
<b>Filling Volume</b>	approx. 30 liters	
<b>Wooden Support</b>	SPEAG standard phantom table	

Phantom for compliance testing of handheld and body-mounted wireless devices in the frequency range of 30 MHz to 6 GHz. ELI is fully compatible with the IEC 62209-2 standard and all known tissue simulating liquids. ELI has been optimized regarding its performance and can be integrated into our standard phantom tables. A cover prevents evaporation of the liquid. Reference markings on the phantom allow installation of the complete setup, including all predefined phantom positions and measurement grids, by teaching three points. The phantom is compatible with all SPEAG dosimetric probes and dipoles.

ELI V5.0 has the same shell geometry and is manufactured from the same material as ELI4, but has reinforced top structure.



### 3.6 Laptop Holder for Eli Phantom

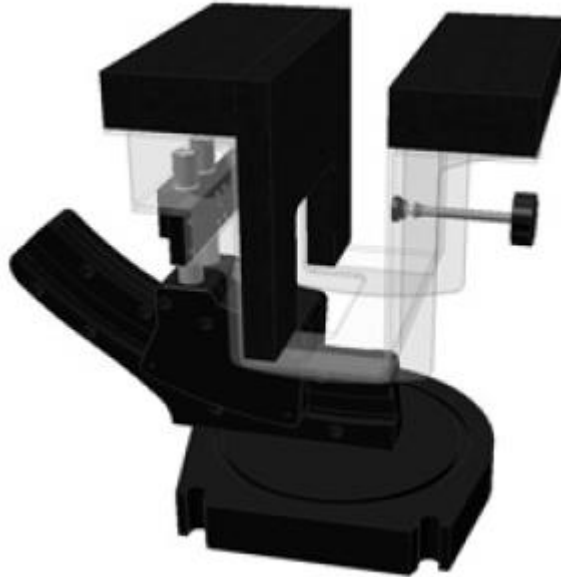

F-2. Laptop Holder for Eli Phantom

- In October 2007, SPEAG released a simple but effective extension for our Mounting Device that facilitates the testing of larger devices according to IEC 62209-2 (e.g., laptops, cameras, etc).
- The extension is lightweight and made of POM, PET-G acrylic glass and foam. It fits easily on the upper part of the Mounting Device in place of the phone positioner. The extension is fully compatible with the Twin-SAM and ELI phantoms, basic principal can be applied to any other large radiating devices.

## 3.7 Measurement procedure

### 3.7.1 Scanning procedure

#### Step 1: Power reference measurement

The “reference” and “drift” measurements are located at the beginning and end of the batch process. They measure the field drift at one single point in the liquid over the complete procedure.

#### Step 2: Area scan

The area scan is used as a fast scan in two dimensions to find the area of high field values, before doing a finer measurement around the hot spot. The sophisticated interpolation routines implemented in DASY 5 software can find the maximum locations even in relatively coarse grids. The scan area is defined by an editable grid. This grid is anchored at the grid reference point of the selected section in the phantom. When the area scan's property sheet is brought-up, grid was at to 15mm\*15mm or 12mm\*12mm or 10mm\*10mm, and can be edited by a user.

#### Step 3: Zoom scan

Around this point, a volume of 30mm\*30mm\*30mm (fine resolution volume scan, zoom scan) was assessed by measuring 5x5x7 points ( $\leq 2$ GHz) and 7x7x7 points ( $\geq 2$ GHz). On this basis of this data set, the spatial peak SAR value was evaluated with the following procedure:

The data at the surface was extrapolated, since the centre of the dipoles is 2.0mm away from the tip of the probe and the distance between the surface and the lowest measuring point is 1.2mm. (This can be variable. Refer to the probe specification). The extrapolation was based on a least square algorithm. A polynomial of the fourth order was calculated through the points in z-axes. This polynomial was then used to evaluate the points between the surface and the probe tip. The maximum interpolated value was searched with a straight-forward algorithm. Around this maximum the SAR values averaged over the spatial volumes (1g or 10g) were computed using the 3D-Spline interpolation algorithm. The volume was integrated with the trapezoidal algorithm. One thousand points were interpolated to calculate the average. All neighbouring volumes were evaluated until no neighboring volume with a higher average value was found.

The area and zoom scan resolutions specified in the table below must be applied to the SAR measurements. Probe boundary effect error compensation is required for measurements with the probe tip closer than half a probe tip diameter to the phantom surface. Both the probe tip diameter and sensor offset distance must satisfy measurement protocols; to ensure probe boundary effect errors are minimized and the higher fields closest to the phantom surface can be correctly measured and extrapolated to the phantom surface for computing 1-g SAR. Tolerances of the post-processing algorithms must be verified by the test laboratory for the scan resolutions used in the SAR measurements, according to the reference distribution functions specified in IEEE Std. 1528-2003.

		$\leq 3$ GHz	$> 3$ GHz	
Maximum distance from closest measurement point (geometric center of probe sensors) to phantom surface		$5 \pm 1$ mm	$\frac{1}{2} \cdot \delta \cdot \ln(2) \pm 0.5$ mm	
Maximum probe angle from probe axis to phantom surface normal at the measurement location		$30^\circ \pm 1^\circ$	$20^\circ \pm 1^\circ$	
Maximum area scan spatial resolution: $\Delta x_{Area}$ , $\Delta y_{Area}$		$\leq 2$ GHz: $\leq 15$ mm 2 – 3 GHz: $\leq 12$ mm	3 – 4 GHz: $\leq 12$ mm 4 – 6 GHz: $\leq 10$ mm	
		When the x or y dimension of the test device, in the measurement plane orientation, is smaller than the above, the measurement resolution must be $\leq$ the corresponding x or y dimension of the test device with at least one measurement point on the test device.		
Maximum zoom scan spatial resolution: $\Delta x_{Zoom}$ , $\Delta y_{Zoom}$		$\leq 2$ GHz: $\leq 8$ mm 2 – 3 GHz: $\leq 5$ mm*	3 – 4 GHz: $\leq 5$ mm* 4 – 6 GHz: $\leq 4$ mm*	
Maximum zoom scan spatial resolution, normal to phantom surface	uniform grid: $\Delta z_{Zoom}(n)$	$\leq 5$ mm	3 – 4 GHz: $\leq 4$ mm 4 – 5 GHz: $\leq 3$ mm 5 – 6 GHz: $\leq 2$ mm	
	graded grid	$\Delta z_{Zoom}(1)$ : between 1 <sup>st</sup> two points closest to phantom surface	$\leq 4$ mm	3 – 4 GHz: $\leq 3$ mm 4 – 5 GHz: $\leq 2.5$ mm 5 – 6 GHz: $\leq 2$ mm
		$\Delta z_{Zoom}(n>1)$ : between subsequent points	$\leq 1.5 \cdot \Delta z_{Zoom}(n-1)$	
Minimum zoom scan volume	x, y, z	$\geq 30$ mm	3 – 4 GHz: $\geq 28$ mm 4 – 5 GHz: $\geq 25$ mm 5 – 6 GHz: $\geq 22$ mm	
<p>Note: <math>\delta</math> is the penetration depth of a plane-wave at normal incidence to the tissue medium; see draft standard IEEE P1528-2011 for details.</p> <p>* When zoom scan is required and the <i>reported</i> SAR from the <i>area scan based 1-g SAR estimation</i> procedures of KDB 447498 is <math>\leq 1.4</math> W/kg, <math>\leq 8</math> mm, <math>\leq 7</math> mm and <math>\leq 5</math> mm zoom scan resolution may be applied, respectively, for 2 GHz to 3 GHz, 3 GHz to 4 GHz and 4 GHz to 6 GHz.</p>				

#### Step 4: Power reference measurement (drift)

The Power Drift Measurement job measures the field at the same location as the most recent power reference measurement job within the same procedure, and with the same settings. The indicated drift is mainly the variation of the DUT's output power and should vary max.  $\pm 5\%$

### 3.7.2 Data Storage

The DASY software stores the acquired data from the data acquisition electronics as raw data (in microvolt readings from the probe sensors), together with all necessary software parameters for the data evaluation (probe calibration data, liquid parameters and device frequency and modulation data) in measurement files with the extension “.DAE3”. The software evaluates the desired unit and format for output each time the data is visualized or exported. This allows verification of the complete software setup even after the measurement and allows correction of incorrect parameter settings. For example, if a measurement has been performed with a wrong crest factor parameter in the device setup, the parameter can be corrected afterwards and the data can be re-evaluated. The measured data can be visualized or exported in different units or formats, depending on the selected probe type ([V/m], [A/m], [°C], [m W/g], [m W/cm<sup>2</sup>], [dBrel], etc.). Some of these units are not available in certain situations or show meaningless results, e.g., a SAR output in a lossless media will always be zero. Raw data can also be exported to perform the evaluation with other software packages.

### 3.7.3 Data Evaluation by SEMCAD

The SEMCAD software automatically executes the following procedures to calculate the field units from the microvolt readings at the probe connector. The parameters used in the evaluation are stored in the configuration modules of the software:

Probe parameters:	- Sensitivity	Normi, ai0, ai1, ai2
- Conversion factor	ConvFi	
- Diode compression point	Dcpi	
Device parameters:	- Frequency	f
- Crest factor	cf	
Media parameters:	- Conductivity	ε
- Density	ρ	

These parameters must be set correctly in the software. They can be found in the component documents or they can be imported into the software from the configuration files issued for the DASY components. In the direct measuring mode of the multimeter option, the parameters of the actual system setup are used. In the scan visualization and export modes, the parameters stored in the corresponding document files are used.

The first step of the evaluation is a linearization of the filtered input signal to account for the compression characteristics of the detector diode. The compensation depends on the input signal, the diode type and the DC-transmission factor from the diode to the evaluation electronics.

If the exciting field is pulsed, the crest factor of the signal must be known to correctly compensate for peak power. The formula for each channel can be given as:

$$V_i = U_i + U_i^2 \cdot cf / dcpi$$

With  $V_i$  = compensated signal of channel  $i$  ( $i = x, y, z$ )

$U_i$  = input signal of channel  $i$  ( $i = x, y, z$ )

cf = crest factor of exciting field (DASY parameter)

dcpi = diode compression point (DASY parameter)

From the compensated input signals the primary field data for each channel can be evaluated:

E-field probes:

$$E_i = (V_i / Norm_i \cdot ConvF)^{1/2}$$

H-field probes:

$$H_i = (V_i)^{1/2} \cdot (a_{i0} + a_{i1}f + a_{i2}f^2) / f$$

With  $V_i$  = compensated signal of channel  $i$  ( $i = x, y, z$ )

Norm $i$  = sensor sensitivity of channel  $i$  ( $i = x, y, z$ )

[mV/(V/m)<sup>2</sup>] for E-field Probes

ConvF = sensitivity enhancement in solution

$a_{ij}$  = sensor sensitivity factors for H-field probes

$f$  = carrier frequency [GHz]

$E_i$  = electric field strength of channel  $i$  in V/m

$H_i$  = magnetic field strength of channel  $i$  in A/m

The RSS value of the field components gives the total field strength (Hermitian magnitude):

$$E_{tot} = (E_x^2 + E_y^2 + E_z^2)^{1/2}$$

The primary field data are used to calculate the derived field units.

$$SAR = (E_{tot}^2 \cdot \sigma) / (\epsilon \cdot 1000)$$

With SAR = local specific absorption rate in mW/g

$E_{tot}$  = total field strength in V/m

$\sigma$  = conductivity in [mho/m] or [Siemens/m]

$\epsilon$  = equivalent tissue density in g/cm<sup>3</sup>

Note that the density is normally set to 1 (or 1.06), to account for actual brain density rather than the density of the simulation liquid. The power flow density is calculated assuming the excitation field to be a free space field.

$$P_{pwe} = E_{tot}^2 / 3770 \quad \text{or} \quad P_{pwe} = H_{tot}^2 \cdot 37.7$$

with  $P_{pwe}$  = equivalent power density of a plane wave in mW/cm<sup>2</sup>

$E_{tot}$  = total electric field strength in V/m

$H_{tot}$  = total magnetic field strength in A/m

## 4 SAR measurement variability and uncertainty

### 4.1 SAR measurement variability

Per KDB865664 D01 SAR measurement 100 MHz to 6 GHz v01r04, SAR measurement variability must be assessed for each frequency band, which is determined by the SAR probe calibration point and tissue-equivalent medium used for the device measurements. The additional measurements are repeated after the completion of all measurements requiring the same head or body tissue-equivalent medium in a frequency band. The test device should be returned to ambient conditions (normal room temperature) with the battery fully charged before it is re-mounted on the device holder for the repeated measurement(s) to minimize any unexpected variations in the repeated results.

1) Repeated measurement is not required when the original highest measured SAR is  $< 0.80$  W/kg; steps 2) through 4) do not apply.

2) When the original highest measured SAR is  $\geq 0.80$  W/kg, repeat that measurement once.

3) Perform a second repeated measurement only if the ratio of largest to smallest SAR for the original and first repeated measurements is  $> 1.20$  or when the original or repeated measurement is  $\geq 1.45$  W/kg ( $\sim 10\%$  from the 1-g SAR limit).

4) Perform a third repeated measurement only if the original, first or second repeated measurement is  $\geq 1.5$  W/kg and the ratio of largest to smallest SAR for the original, first and second repeated measurements is  $> 1.20$ .

The same procedures should be adapted for measurements according to extremity and occupational exposure limits by applying a factor of 2.5 for extremity exposure and a factor of 5 for occupational exposure to the corresponding SAR thresholds.

## 4.2 SAR measurement uncertainty

Per KDB865664 D01 SAR Measurement 100 MHz to 6 GHz, when the highest measured 1-g SAR within a frequency band is  $< 1.5$  W/kg, the extensive SAR measurement uncertainty analysis described in IEEE Std 1528-2013 is not required in SAR reports submitted for equipment approval. The equivalent ratio (1.5/1.6) is applied to extremity and occupational exposure conditions.



## 5 Description of Test Position

### 5.1 The Body Test Position

This EUT was tested in three different positions. They are Bottom Face, Edge 1, Edge 2 of tablet. In these positions, the surface of EUT is touching phantom with 0 mm. The SAR Exclusion Threshold in KDB 447498 D01 can be applied to determine SAR test exclusion for adjacent edge configurations. The closest distance from the antenna to an adjacent device surface is used to determine if SAR testing is required for the adjacent surfaces, with the adjacent surface positioned against the phantom and the surface containing the antenna positioned perpendicular to the phantom.

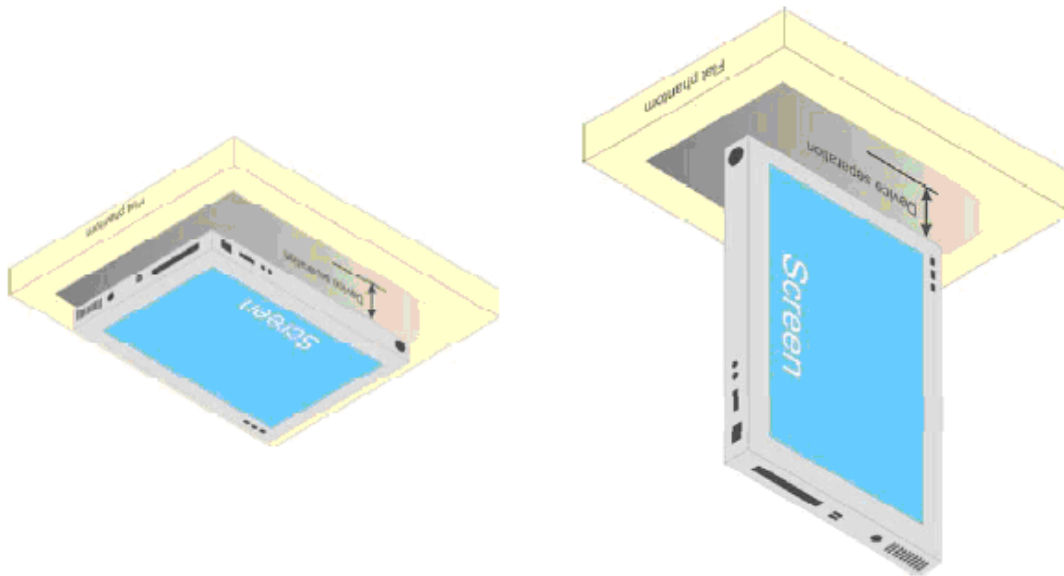

Fig Illustration for Lap-touching Position



## 6 SAR System Verification Procedure

### 6.1 Tissue Simulate Liquid

#### 6.1.1 Recipes for Tissue Simulate Liquid

The following tables give the recipes for tissue simulating liquids to be used in different frequency bands:

Ingredients (% by weight)	Frequency (MHz)									
	450		835		915		1900		2450	
Tissue Type	Head	Body	Head	Body	Head	Body	Head	Body	Head	Body
Water	38.56	51.16	41.45	52.4	41.05	56.0	54.9	40.4	62.7	73.2
Salt (NaCl)	3.95	1.49	1.45	1.4	1.35	0.76	0.18	0.5	0.5	0.04
Sugar	56.32	46.78	56.0	45.0	56.5	41.76	0.0	58.0	0.0	0.0
HEC	0.98	0.52	1.0	1.0	1.0	1.21	0.0	1.0	0.0	0.0
Bactericide	0.19	0.05	0.1	0.1	0.1	0.27	0.0	0.1	0.0	0.0
Triton X-100	0.0	0.0	0.0	0.0	0.0	0.0	0.0	0.0	36.8	0.0
DGBE	0.0	0.0	0.0	0.0	0.0	0.0	44.92	0.0	0.0	26.7
Dielectric Constant	43.42	58.0	42.54	56.1	42.0	56.8	39.9	54.0	39.8	52.5
Conductivity (S/m)	0.85	0.83	0.91	0.95	1.0	1.07	1.42	1.45	1.88	1.78
<p>HSL5GHz is composed of the following ingredients:            Water: 50-65%            Mineral oil: 10-30%            Emulsifiers: 8-25%            Sodium salt: 0-1.5%</p>										
<p>MSL5GHz is composed of the following ingredients:            Water: 64-78%            Mineral oil: 11-18%            Emulsifiers: 9-15%            Sodium salt: 2-3%</p>										

Table 3: Recipe of Tissue Simulate Liquid

## 6.1.2 Test Liquids Confirmation

### Simulated tissue liquid parameter confirmation

The dielectric parameters were checked prior to assessment using the SPEAG DAK3.5 dielectric probe kit. The dielectric parameters measured are reported in each correspondent section.

### **IEEE SCC-34/SC-2 P1528 recommended tissue dielectric parameters**

The head tissue dielectric parameters recommended by the IEEE SCC-34/SC-2 in P1528 have been incorporated in the following table. These head parameters are derived from planar layer models simulating the highest expected SAR for the dielectric properties and tissue thickness variations in a human head. Other head and body tissue parameters that have not been specified in P1528 are derived from the tissue dielectric parameters computed from the 4-Cole-Cole equations and extrapolated according to the head parameters specified in P1528

Target Frequency (MHz)	Head		Body	
	$\epsilon_r$	$\sigma$ (S/m)	$\epsilon_r$	$\sigma$ (S/m)
150	52.3	0.76	61.9	0.80
300	45.3	0.87	58.2	0.92
450	43.5	0.87	56.7	0.94
835	41.5	0.90	55.2	0.97
900	41.5	0.97	55.0	1.05
915	41.5	0.98	55.0	1.06
1450	40.5	1.20	54.0	1.30
1610	40.3	1.29	53.8	1.40
1800-2000	40.0	1.40	53.3	1.52
2450	39.2	1.80	52.7	1.95
3000	38.5	2.40	52.0	2.73
5800	35.3	5.27	48.2	6.00

( $\epsilon_r$  = relative permittivity,  $\sigma$  = conductivity and  $\rho = 1000 \text{ kg/m}^3$ )

### 6.1.3 Measurement for Tissue Simulate Liquid

The dielectric properties for this Tissue Simulate Liquids were measured by using the Agilent Model 85070E Dielectric Probe in conjunction with Agilent E5071C Network Analyzer (300 KHz-8500 MHz). The Conductivity ( $\sigma$ ) and Permittivity ( $\rho$ ) are listed in bellow table. For the SAR measurement given in this report. The temperature variation of the Tissue Simulate Liquids was  $22\pm 2^{\circ}\text{C}$ .

Tissue Type	Measured Frequency (MHz)	Target Tissue ( $\pm 5\%$ )		Measured Tissue		Liquid Temp. ( $^{\circ}\text{C}$ )	Measured Date
		$\epsilon_r$	$\sigma(\text{S/m})$	$\epsilon_r$	$\sigma(\text{S/m})$		
2450 Head	2450	39.20 (37.24~41.16)	1.80 (1.71~1.89)	38.839	1.81	22	2020/9/11
5250Head	5250	35.9 (34.11~37.70)	4.71 (4.47~4.95)	36.011	4.767	22.2	2020/9/9
5600 Head	5600	35.5 (33.73~37.28)	5.07 (4.82~5.32)	35.059	5.157	22.2	2020/9/10
5750 Head	5750	35.4 (33.63~37.17)	5.22 (4.96~5.48)	34.695	5.329	22.2	2020/9/11

Table 4: Measurement result of Tissue electric parameters

## 6.2 SAR System Check

The microwave circuit arrangement for system check is sketched in bellow figure. The daily system accuracy verification occurs within the flat section of the SAM phantom. A SAR measurement was performed to see if the measured SAR was within +/- 10% from the target SAR values. The tests were conducted on the same days as the measurement of the EUT. The obtained results from the system accuracy verification are displayed in the following table. During the tests, the ambient temperature of the laboratory was in the range  $22\pm 2^{\circ}\text{C}$ , the relative humidity was in the range 60% and the liquid depth above the ear reference points was above 15 cm in all the cases. It is seen that the system is operating within its specification, as the results are within acceptable tolerance of the reference values.

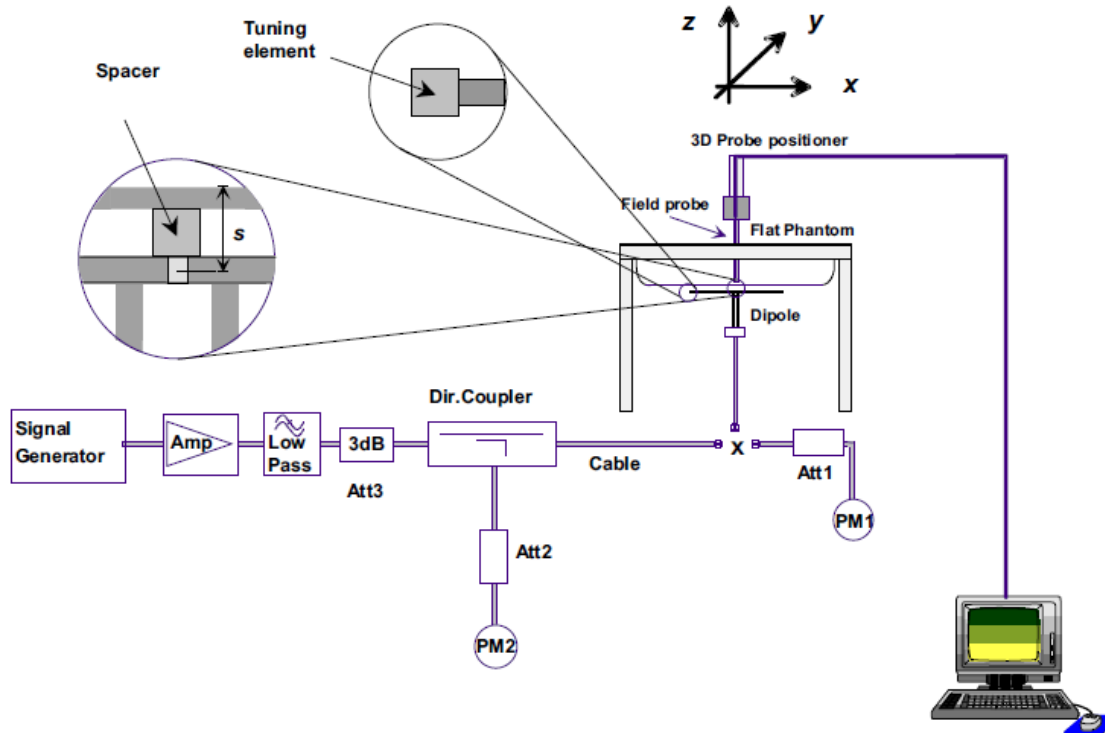

F-3. the microwave circuit arrangement used for SAR system verification

### 6.2.1 Justification for Extended SAR Dipole Calibrations

1) Referring to KDB865664 D01 requirements for dipole calibration, instead of the typical annual calibration recommended by measurement standards, longer calibration intervals of up to three years may be considered when it is demonstrated that the SAR target, impedance and return loss of a dipole have remain stable according to the following requirements. Each measured dipole is expected to evaluate with the following criteria at least on annual interval in Appendix C.

- a) There is no physical damage on the dipole;
- b) System check with specific dipole is within 10% of calibrated value;
- c) Return-loss is within 10% of calibrated measurement;
- d) Impedance is within  $5\Omega$  from the previous measurement.

2) Network analyzer probe calibration against air, distilled water and a shorting block performed before measuring liquid parameters.

**6.2.2 Summary System Check Result(s)**

Validation Kit		Measured SAR 250mW	Measured SAR 250mW	Measured SAR (normalized to 1w)	Measured SAR (normalized to 1w)	Target SAR (normalized to 1w) (±10%)	Target SAR (normalized to 1w) (±10%)	Liquid Temp. (°C)	Measured Date
		1g (W/kg)	10g (W/kg)	1g (W/kg)	10g (W/kg)	1-g(W/kg)	10-g(W/kg)		
D2450 V2	Head	13.2	6.16	52.8	24.64	53 (47.70~58.30)	24.6 (22.14~27.60)	22	2020/9/11
Validation Kit		Measured SAR 100mW	Measured SAR 100mW	Measured SAR (normalized to 1w)	Measured SAR (normalized to 1w)	Target SAR (normalized to 1w) (±10%)	Target SAR (normalized to 1w) (±10%)	Liquid Temp. (°C)	Measured Date
		1g (W/kg)	10g (W/kg)	1g (W/kg)	10g (W/kg)	1-g(W/kg)	10-g(W/kg)		
D5GHz V2	Head 5.25GHz	8.16	2.22	81.6	22.2	77.7 (69.93~85.47)	22.4 (20.16~24.64)	22.2	2020/9/9
	Head 5.6GHz	8.14	2.27	81.4	22.7	81.2 (73.08~89.32)	23.5 (21.15~25.85)	22.2	2020/9/10
	Head 5.75GHz	8.09	2.28	80.9	22.8	78.9 (71.01~86.79)	22.7 (20.43~24.97)	22.2	2020/9/11

Table 5: SAR System Check Result

**6.2.3 Detailed System Check Results**

Please see the Appendix A

## 7 Test Configuration

### 7.1 Operation Configurations

#### 7.1.1 Wi-Fi Test Configuration

A Wi-Fi device must be configured to transmit continuously at the required data rate, channel bandwidth and signal modulation, using the highest transmission duty factor supported by the test mode tools for SAR measurement.

##### 7.1.1.1 Duty cycle

1) 2.4GHz Wi-Fi 802.11b:

WI-FI1 802.11b 1M: Duty cycle=  $(40.71-32.47) / (40.91-32.47) = 97.63\%$

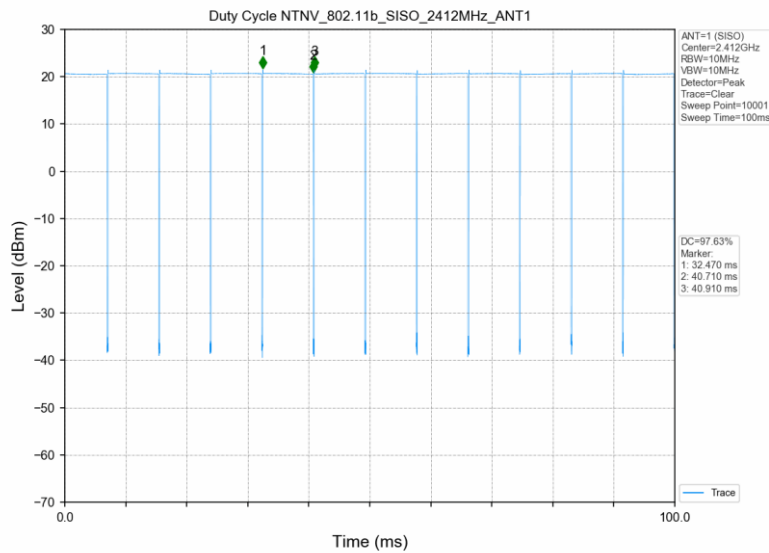

##### 7.1.1.2 Duty cycle

2) 2.4GHz Wi-Fi 802.11n-HT40:

WI-FI1 802.11n-HT40 MCS0: Duty cycle=  $(5.917-5.43) / (5.937-5.43) = 96.06\%$

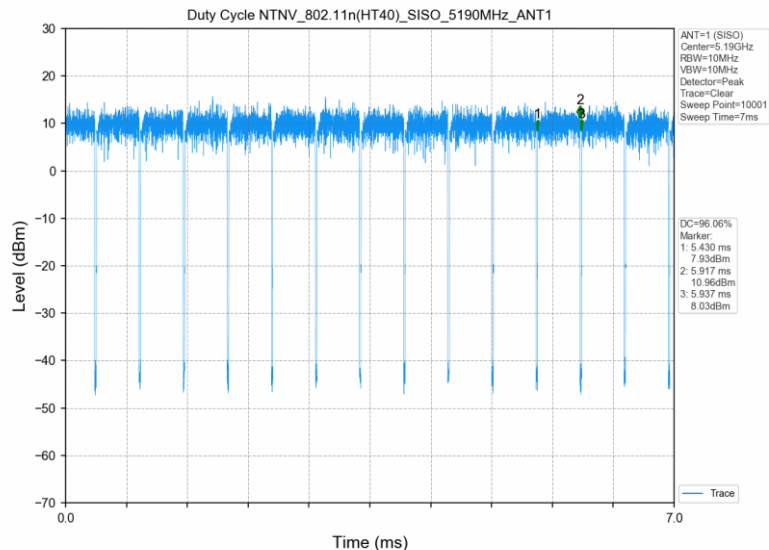

### 7.1.1.3 Initial Test Position SAR Test Reduction Procedure

DSSS and OFDM configurations are considered separately according to the required SAR procedures. SAR is measured in the initial test position using the 802.11 transmission mode configuration required by the DSSS procedure or initial test configuration and subsequent test configuration(s) according to the OFDM procedures. The initial test position procedure is described in the following:

- 1) .When the reported SAR of the initial test position is  $\leq 0.4$  W/kg, further SAR measurement is not required for the other (remaining) test positions in that exposure configuration and 802.11 transmission mode combinations within the frequency band or aggregated band. SAR is also not required for that exposure configuration in the subsequent test configuration(s).
- 2) .When the reported SAR of the initial test position is  $> 0.4$  W/kg, SAR is repeated for the 802.11 transmission mode configuration tested in the initial test position using subsequent highest extrapolated or estimated 1-g SAR conditions determined by area scans or next closest/smallest test separation distance and maximum RF coupling test positions based on manufacturer justification, on the highest maximum output power channel, until the reported SAR is  $\leq 0.8$  W/kg or all required test positions (left, right, touch, tilt or subsequent surfaces and edges) are tested.
- 3) .For all positions/configurations tested using the initial test position and subsequent test positions, when the reported SAR is  $> 0.8$  W/kg, SAR is measured for these test positions/configurations on the subsequent next highest measured output power channel(s) until the reported SAR is  $\leq 1.2$  W/kg or all required channels are tested. a) Additional power measurements may be required for this step, which should be limited to those necessary for identifying the subsequent highest output power channels.

### 7.1.1.4 Initial Test Configuration Procedures

An initial test configuration is determined for OFDM transmission modes according to the channel bandwidth, modulation and data rate combination(s) with the highest maximum output power specified for production units in each standalone and aggregated frequency band. SAR is measured using the highest measured maximum output power channel. For configurations with the same specified or measured maximum output power, additional transmission mode and test channel selection procedures are required. SAR test reduction for subsequent highest output test channels is determined according to *reported* SAR of the initial test configuration.

For next to the ear, hotspot mode and UMC mini-tablet exposure configurations where multiple test positions are required, the initial test position procedure is applied to minimize the number of test positions required for SAR measurement using the initial test configuration transmission mode. For fixed exposure conditions that do not have multiple SAR test positions, SAR is measured in the transmission mode determined by the initial test configuration.

When the *reported* SAR of the initial test configuration is  $> 0.8$  W/kg, SAR measurement is required for subsequent next highest measured output power channel(s) in the initial test configuration until *reported* SAR is  $\leq 1.2$  W/kg or all required channels are tested.

### 7.1.1.5 Subsequent Test Configuration Procedures

SAR measurement requirements for the remaining 802.11 transmission mode configurations that have not been tested in the initial test configuration are determined separately for each standalone and aggregated frequency band, in each exposure condition, according to the maximum output power specified for production units. The initial test position procedure is applied to next to the ear, UMPC mini-tablet and hotspot mode configurations. When the same maximum output power is specified for multiple transmission modes, additional power measurements may be required to determine if SAR measurements are required for subsequent highest output power channels in a subsequent test configuration. The subsequent test configuration and SAR measurement procedures are described in the following.

- 1) .When SAR test exclusion provisions of KDB Publication 447498 are applicable and SAR measurement is not required for the initial test configuration, SAR is also not required for the next highest maximum output power transmission mode subsequent test configuration(s) in that frequency band or aggregated band and exposure configuration.
- 2) .When the highest *reported* SAR for the initial test configuration (when applicable, include subsequent



highest output channels), according to the initial test position or fixed exposure position requirements, is adjusted by the ratio of the subsequent test configuration to initial test configuration specified maximum output power and the adjusted SAR is  $\leq 1.2$  W/kg, SAR is not required for that subsequent test configuration.

- 3) . The number of channels in the initial test configuration and subsequent test configuration can be different due to differences in channel bandwidth. When SAR measurement is required for a subsequent test configuration and the channel bandwidth is smaller than that in the initial test configuration, all channels in the subsequent test configuration that overlap with the larger bandwidth channel tested in the initial test configuration should be used to determine the highest maximum output power channel. This step requires additional power measurement to identify the highest maximum output power channel in the subsequent test configuration to determine SAR test reduction.
  - a) SAR should first be measured for the channel with highest measured output power in the subsequent test configuration.
  - b) SAR for subsequent highest measured maximum output power channels in the subsequent test configuration is required only when the *reported* SAR of the preceding higher maximum output power channel(s) in the subsequent test configuration is  $> 1.2$  W/kg or until all required channels are tested. i) For channels with the same measured maximum output power, SAR should be measured using the channel closest to the center frequency of the larger channel bandwidth channel in the initial test configuration.
- 4) . SAR measurements for the remaining highest specified maximum output power OFDM transmission mode configurations that have not been tested in the initial test configuration (highest maximum output) or subsequent test configuration(s) (subsequent next highest maximum output power) is determined by recursively applying the subsequent test configuration procedures in this section to the remaining configurations according to the following:
  - a) replace "subsequent test configuration" with "next subsequent test configuration" (i.e., subsequent next highest specified maximum output power configuration)
  - b) replace "initial test configuration" with "all tested higher output power configurations"

#### 7.1.1.6 2.4 GHz Wi-Fi SAR Procedures

Separate SAR procedures are applied to DSSS and OFDM configurations in the 2.4 GHz band to simplify DSSS test requirements. For 802.11b DSSS SAR measurements, DSSS SAR procedure applies to fixed exposure test position and initial test position procedure applies to multiple exposure test positions. When SAR measurement is required for an OFDM configuration, the initial test configuration, subsequent test configuration and initial test position procedures are applied. The SAR test exclusion requirements for 802.11g/n OFDM configurations are described in following.

- **802.11b DSSS SAR Test Requirements**

SAR is measured for 2.4 GHz 802.11b DSSS using either a fixed test position or, when applicable, the initial test position procedure. SAR test reduction is determined according to the following:

- 1) . When the reported SAR of the highest measured maximum output power channel for the exposure configuration is  $\leq 0.8$  W/kg, no further SAR testing is required for 802.11b DSSS in that exposure configuration.
- 2) . When the reported SAR is  $> 0.8$  W/kg, SAR is required for that exposure configuration using the next highest measured output power channel. When any reported SAR is  $> 1.2$  W/kg, SAR is required for the third channel; i.e., all channels require testing.

- **2.4 GHz 802.11g/n OFDM SAR Test Exclusion Requirements**

When SAR measurement is required for 2.4 GHz 802.11g/n OFDM configurations, the measurement and test reduction procedures for OFDM are applied (section 5.3, including sub-sections). SAR is not required for the following 2.4 GHz OFDM conditions.

- 1) . When KDB Publication 447498 SAR test exclusion applies to the OFDM configuration.
- 2) . When the highest reported SAR for DSSS is adjusted by the ratio of OFDM to DSSS specified maximum output power and the adjusted SAR is  $\leq 1.2$  W/kg.

#### 7.1.1.7 5 GHz Wi-Fi SAR Procedures

- **U-NII-1 and U-NII-2A Bands**

For devices that operate in only one of the U-NII-1 and U-NII-2A bands, the normally required SAR procedures for OFDM configurations are applied. For devices that operate in both U-NII bands using the same transmitter and

antenna(s), SAR test reduction is determined according to the following:

- 1) When the same maximum output power is specified for both bands, begin SAR measurement in U-NII-2A band by applying the OFDM SAR requirements. If the highest reported SAR for a test configuration is  $\leq 1.2$  W/kg, SAR is not required for U-NII-1 band for that configuration (802.11 mode and exposure condition); otherwise, both bands are tested independently for SAR.
- 2) When different maximum output power is specified for the bands, begin SAR measurement in the band with higher specified maximum output power. The highest reported SAR for the tested configuration is adjusted by the ratio of lower to higher specified maximum output power for the two bands. When the adjusted SAR is  $\leq 1.2$  W/kg, SAR is not required for the band with lower maximum output power in that test configuration; otherwise, both bands are tested independently for SAR.
- 3) The two U-NII bands may be aggregated to support a 160 MHz channel on channel number 50. Without additional testing, the maximum output power for this is limited to the lower of the maximum output power certified for the two bands. When SAR measurement is required for at least one of the bands and the highest reported SAR adjusted by the ratio of specified maximum output power of aggregated to standalone band is  $> 1.2$  W/kg, SAR is required for the 160 MHz channel. This procedure does not apply to an aggregated band with maximum output higher than the standalone band(s); the aggregated band must be tested independently for SAR. SAR is not required when the 160 MHz channel is operating at a reduced maximum power and also qualifies for SAR test exclusion.

#### • U-NII-2C and U-NII-3 Bands

The frequency range covered by these bands is 380 MHz (5.47 – 5.85 GHz), which requires a minimum of at least two SAR probe calibration frequency points to support SAR measurements. when Terminal Doppler Weather Radar (TDWR) restriction applies, all channels that operate at 5.60 – 5.65 GHz must be included to apply the SAR test reduction and measurement procedures.

When the same transmitter and antenna(s) are used for U-NII-2C band and U-NII-3 band or 5.8 GHz band of §15.247, the bands may be aggregated to enable additional channels with 20, 40 or 80 MHz bandwidth to span across the band gap, as illustrated in Appendix B. The maximum output power for the additional band gap channels is limited to the lower of those certified for the bands. Unless band gap channels are permanently disabled, they must be considered for SAR testing. The frequency range covered by these bands is 380 MHz (5.47 – 5.85 GHz), which requires a minimum of at least two SAR probe calibration frequency points to support SAR measurements. To maintain SAR measurement accuracy and to facilitate test reduction, the channels in U-NII-2C band above 5.65 GHz may be grouped with the 5.8 GHz channels in U-NII-3 or §15.247 band to enable two SAR probe calibration frequency points to cover the bands, including the band gap channels. When band gap channels are supported and the bands are not aggregated for SAR testing, band gap channels must be considered independently in each band according to the normally required OFDM SAR measurement and probe calibration frequency points requirements.

#### • OFDM Transmission Mode SAR Test Configuration and Channel Selection Requirements

The initial test configuration for 5 GHz OFDM transmission modes is determined by the 802.11 configuration with the highest maximum output power specified for production units, including tune-up tolerance, in each standalone and aggregated frequency band. SAR for the initial test configuration is measured using the highest maximum output power channel determined by the default power measurement procedures. When multiple configurations in a frequency band have the same specified maximum output power, the initial test configuration is determined according to the following steps applied sequentially.

- 1) The largest channel bandwidth configuration is selected among the multiple configurations with the same specified maximum output power.
- 2) If multiple configurations have the same specified maximum output power and largest channel bandwidth, the lowest order modulation among the largest channel bandwidth configurations is selected.
- 3) If multiple configurations have the same specified maximum output power, largest channel bandwidth and lowest order modulation, the lowest data rate configuration among these configurations is selected.
- 4) When multiple transmission modes (802.11a/g/n/ac) have the same specified maximum output power, largest channel bandwidth, lowest order modulation and lowest data rate, the lowest order 802.11 mode is selected; i.e., 802.11a is chosen over 802.11n then 802.11ac or 802.11g is chosen over 802.11n. After an initial test configuration is determined, if multiple test channels have the same measured maximum output power, the channel chosen for SAR measurement is determined according to the following. These channel

selection procedures apply to both the initial test configuration and subsequent test configuration(s), with respect to the default power measurement procedures or additional power measurements required for further SAR test reduction. The same procedures also apply to subsequent highest output power channel(s) selection.

- a) The channel closest to mid-band frequency is selected for SAR measurement.
- b) For channels with equal separation from mid-band frequency; for example, high and low channels or two mid-band channels, the higher frequency (number) channel is selected for SAR measurement.

- **SAR Test Requirements for OFDM configurations**

When SAR measurement is required for 802.11 a/n/ac OFDM configurations, each standalone and frequency aggregated band is considered separately for SAR test reduction. When the same transmitter and antenna(s) are used for U-NII-1 and U-NII-2A bands, additional SAR test reduction applies. When band gap channels between U-NII-2C band and 5.8 GHz U-NII-3 or §15.247 band are supported, the highest maximum output power transmission mode configuration and maximum output power channel across the bands must be used to determine SAR test reduction, according to the initial test configuration and subsequent test configuration requirements. In applying the initial test configuration and subsequent test configuration procedures, the 802.11 transmission configuration with the highest specified maximum output power and the channel within a test configuration with the highest measured maximum output power should be clearly distinguished to apply the procedures.

## 7.1.2 BluetoothTest Configuration

For the Bluetooth SAR tests, a communication link is set up with the test mode software for BT mode test. Bluetooth USES frequency hopping technology to divide the transmitted data into packets and transmit the packets respectively through 79 designated Bluetooth channels, 1MHz Bandwidth, frequency hops at 1600 hops/second per the Bluetooth standard. The Radio Frequency Channel Number (RFCN) is allocated to 0, 39 and 78 respectively in the case of 2402~2480 MHz during the test at each test frequency channel, the EUT is operated at the RF continuous emission mode.

### 7.1.2.1 Duty cycle

Bluetooth duty cycle:  $2.88605/3.766026=76.63\%$

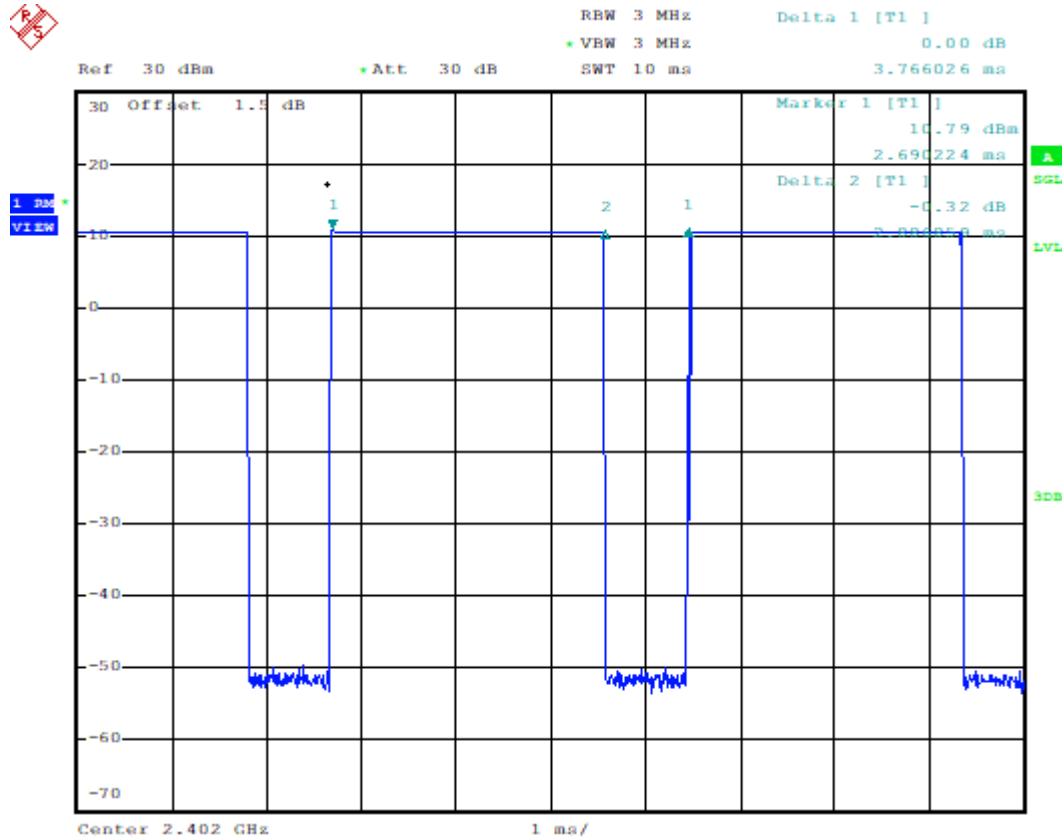

## 8 Test Result

### 8.1 Measurement of RF Conducted Power

Mode	Channel	Frequency (MHz)	Data Rate (Mbps)	Average Power (dBm)	Tune up	Power setting
802.11b	1	2412	1	<b>17.18</b>	17.5	17
	6	<b>2437</b>		16.65	17.5	17
	11	2462		17.12	17.5	17
802.11g	1	2412	6	15.24	16	16
	6	2437		14.54	16	16
	11	2462		15.03	16	16
802.11n HT20	1	2412	6.5	13.93	14.5	14
	6	2437		13.57	14.5	14
	11	2462		13.65	14.5	14
802.11n HT40	3	2422	13.5	12.86	14.5	13
	6	2437		12.78	14.5	13
	9	2452		12.19	14.5	13

5GHz	mode	Channel	Frequency (MHz)	Data Rate (Mbps)	Average Power (dBm)	Tune up	Power setting
802.11a	U-NII-1	36	5180	6	13.74	14	15
		44	5220		13.71	14	15
		48	5240		13.68	14	15
	U-NII-2A	52	5260		13.73	14	15
		60	<b>5300</b>		13.66	14	15
		64	5320		13.52	14	15
	U-NII-2C	100	5500		12.85	13.5	14
		116	5580		12.56	13.5	14
		140	5700		12.48	13.5	14
	U-NII-3	149	5745		12.55	13	14
		157	5785		12.45	13	14
		165	5825		12.33	13	14

5GHz	mode	Channel	Frequency (MHz)	Data Rate (Mbps)	Average Power (dBm)	Tune up	Power setting
802.11n- HT20	U-NII-1	36	5180	MCS0	13.82	14	15
		44	5220		13.48	14	15
		48	<b>5240</b>		13.52	14	15
	U-NII-2A	52	5260		13.55	14	15
		60	5300		13.44	14	15
		64	5320		13.38	14	15
	U-NII-2C	100	5500		12.67	13	14
		116	5580		12.42	13	14
		140	5700		12.28	13	14
	U-NII-3	149	5745		12.38	12.5	14
		157	5785		12.3	12.5	14
		165	5825		12.25	12.5	14

			(MHz)	(Mbps)	Power (dBm)		
802.11n-HT40	U-NII-1	38	5190	MCS0	13.68	14	15
		46	5230		13.62	14	15
	U-NII-2A	54	5270		13.68	14	15
		62	5310		<b>13.72</b>	14	15
	U-NII-2C	102	5510		<b>13.11</b>	13.5	14
		110	5550		12.96	13.5	14
		134	5670		12.55	13.5	14
	U-NII-3	151	5755		<b>12.65</b>	13	14
		159	5795		12.51	13	14
	5GHz	mode	Channel		Frequency (MHz)	Data Rate (Mbps)	Average Power (dBm)
802.11ac 20M	U-NII-1	36	5180	MCS0	13.66	14	15
		44	5220		13.71	14	15
		48	5240		13.62	14	15
	U-NII-2A	52	5260		13.59	14	15
		60	<b>5300</b>		13.56	14	15
		64	5320		13.57	14	15
	U-NII-2C	100	5500		12.72	13	14
		116	5580		12.52	13	14
		140	5700		12.31	13	14
	U-NII-3	149	5745		12.44	12.5	14
		157	5785		12.21	12.5	14
		165	5825		12.2	12.5	14
5GHz	mode	Channel	Frequency (MHz)	Data Rate (Mbps)	Average Power (dBm)	Tune up	Power setting
802.11ac 40M	U-NII-1	38	5190	MCS0	13.84	14	15
		46	5230		13.87	14	15
	U-NII-2A	54	5270		13.85	14	15
		62	5310		13.88	14	15
	U-NII-2C	102	5510		13.01	13.5	14
		110	5550		12.88	13.5	14
		134	5670		12.63	13.5	14
	U-NII-3	151	5755		12.66	13	14
		159	5795		12.56	13	14
	5GHz	mode	Channel		Frequency (MHz)	Data Rate (Mbps)	Average Power (dBm)
802.11ac 80M	U-NII-1	42	5210	MCS0	12.8	13	14
	U-NII-2A	58	5290		12.82	13	14
	U-NII-2C	106	5530		12.05	13	13
	U-NII-2C	122	5610		11.91	12	13
	U-NII-3	155	5775		11.71	12	13

### 8.1.1 Conducted Power Of Wi-Fi and BT

Table 6: Conducted Power Of Wi-Fi

Note:



- a) Power must be measured at each transmit antenna port according to the DSSS and OFDM transmission configurations in each standalone and aggregated frequency band.
- b) Power measurement is required for the transmission mode configuration with the highest maximum output power specified for production units.
- 1) When the same highest maximum output power specification applies to multiple transmission modes, the largest channel bandwidth configuration with the lowest order modulation and lowest data rate is measured.
  - 2) When the same highest maximum output power is specified for multiple largest channel bandwidth configurations with the same lowest order modulation or lowest order modulation and lowest data rate, power measurement is required for all equivalent 802.11 configurations with the same maximum output power.
- c) For each transmission mode configuration, power must be measured for the highest and lowest channels; and at the mid-band channel(s) when there are at least 3 channels. For configurations with multiple mid-band channels, due to an even number of channels, both channels should be measured.

BT		Average Conducted Power(dBm)	Tune up (dBm)	Power setting
Modulation	Channel			
GFSK	0	9.8	11	9
	39	<b>10.44</b>	11	9
	78	9.28	11	9
π/4DQPSK	0	8.1	10	9
	39	8.78	10	9
	78	7.6	10	9
8DPSK	0	8.1	10	9
	39	8.76	10	9
	78	7.58	10	9
BLE		Average Conducted Power(dBm)	Tune up (dBm)	Power setting
Modulation	Channel			
GFSK	0	-0.26	1	Default
	19	0.21	1	Default
	39	-1.26	1	Default

Table 7: Conducted Power Of BT



## 8.2 Stand-alone SAR test evaluation

Unless specifically required by the published RF exposure KDB procedures, standalone 1-g head or body and 10-g extremity SAR evaluation for general population exposure conditions, by measurement or numerical simulation, is not required when the corresponding SAR Test Exclusion Threshold condition is satisfied. These test exclusion conditions are based on source-based time-averaged maximum conducted output power of the RF channel requiring evaluation, adjusted for tune-up tolerance, and the minimum test separation distance required for the exposure conditions.

Freq. Band	Frequency (GHz)	Position	Average Power		Test Separation (mm)	Calculate Value	Exclusion Threshold	Exclusion (Y/N)
			dBm	mW				
Wi-Fi	2.45	Body	17.5	56.2	0	17.6	3	N
Wi-Fi	5.35	Body	14	25.1	0	11.6	3	N
Wi-Fi	5.70	Body	13.5	22.4	0	10.7	3	N
Wi-Fi	5.85	Body	13	20.0	0	9.7	3	N
Bluetooth	2.48	Body	11	12.6	0	4.0	3	N

The 1-g and 10-g SAR test exclusion thresholds for 100 MHz to 6 GHz at test separation distances  $\leq 50$  mm are determined by:

$[(\text{max. power of channel, including tune-up tolerance, mW}) / (\text{min. test separation distance, mm})] \cdot [\sqrt{f(\text{GHz})}] \leq 3.0$  for 1-g SAR and  $\leq 7.5$  for 10-g extremity SAR, where

- $f(\text{GHz})$  is the RF channel transmit frequency in GHz
- Power and distance are rounded to the nearest mW and mm before calculation
- The result is rounded to one decimal place for comparison

The test exclusions are applicable only when the minimum test separation distance is  $\leq 50$  mm and for transmission frequencies between 100 MHz and 6 GHz. When the minimum test separation distance is  $< 5$  mm, a distance of 5 mm is applied to determine SAR test exclusion.

### 8.3 Body Test Exclusion Thresholds

The following SAR test exclusion Thresholds based on KDB 447498 D01 General RF Exposure Guidance v06) 4.3.1)

Exposure Position	Wireless Interface	BT	2.4GHz WLAN	5GHz WLAN U-NII-2A	5GHz WLAN U-NII-2C	5GHz WLAN U-NII-3
	Calculated Frequency (MHz)	2480MHz	2462MHz	5350MHz	5700MHz	5825MHz
	Maximum power (dBm)	11	17.5	14	13.5	13
	Maximum rated power(mW)	13.0	56.0	25.0	22.0	20.0
Bottom Face	Separation distance(mm)	0.0	0.0	0.0	0.0	0.0
	exclusion threshold	4.1	17.6	12.1	10.6	9.7
	Testing required?	<b>Yes</b>	<b>Yes</b>	<b>Yes</b>	<b>Yes</b>	<b>Yes</b>
Edge 1	Separation distance(mm)	12.6	12.6	12.6	12.6	12.6
	exclusion threshold	1.6	7.0	4.8	4.2	3.8
	Testing required?	<b>No</b>	<b>Yes</b>	<b>Yes</b>	<b>Yes</b>	<b>Yes</b>
Edge 2	Separation distance(mm)	0.0	0.0	0.0	0.0	0.0
	exclusion threshold	4.1	17.6	12.1	10.6	9.7
	Testing required?	<b>Yes</b>	<b>Yes</b>	<b>Yes</b>	<b>Yes</b>	<b>Yes</b>
Edge 3	Separation distance(mm)	161.6	161.6	161.6	161.6	161.6
	exclusion threshold	1211.0	1211.0	1178.0	1178.0	1178.0
	Testing required?	<b>No</b>	<b>No</b>	<b>No</b>	<b>No</b>	<b>No</b>
Edge 4	Separation distance(mm)	301.9	301.9	301.9	301.9	301.9
	exclusion threshold	2614.0	2614.0	2581.0	2581.0	2581.0
	Testing required?	<b>No</b>	<b>No</b>	<b>No</b>	<b>No</b>	<b>No</b>

**Note:**

- Maximum power is the source-based time-average power and represents the maximum RF output power among production units
- Per KDB 447498 D01, for larger devices, the test separation distance of adjacent edge configuration is determined by the closest separation between the antenna and the user.
- Per KDB 447498 D01, standalone SAR test exclusion threshold is applied; If the distance of the antenna to the user is < 5mm, 5mm is used to determine SAR exclusion threshold
- Per KDB 447498 D01, the 1-g and 10-g SAR test exclusion thresholds for 100 MHz to 6 GHz at test separation distances ≤ 50 mm are determined by:

$$[(\text{max. power of channel, including tune-up tolerance, mW}) / (\text{min. test separation distance, mm})] \cdot [\sqrt{f(\text{GHz})}] \leq 3.0$$

for

1-g SAR and ≤ 7.5 for 10-g extremity SAR

f(GHz) is the RF channel transmit frequency in GHz

Power and distance are rounded to the nearest mW and mm before calculation

The result is rounded to one decimal place for comparison

For < 50 mm distance, we just calculate mW of the exclusion threshold value (3.0) to do compare.

This formula is  $[3.0] / [\sqrt{f(\text{GHz})}] \cdot [(\text{min. test separation distance, mm})] = \text{exclusion threshold of mW}$ .

- Per KDB 447498 D01, at 100 MHz to 6 GHz and for test separation distances > 50 mm, the SAR test exclusion threshold is determined according to the following

a) [Threshold at 50 mm in step 1) + (test separation distance - 50 mm) · ( f(MHz)/150)] mW, at 100 MHz to 1500 MHz

b) [Threshold at 50 mm in step 1) + (test separation distance - 50 mm) · 10] mW at > 1500 MHz and ≤ 6 GHz

- When the minimum test separation distance is < 5 mm, a distance of 5 mm according to 5) in section 4.1 is applied to determine SAR test exclusion.

## 8.4 Measurement of SAR Data

### 8.4.1 SAR Result Of 2.4GHz Wi-Fi

Test position	Test mode	Test Ch./Freq.	Duty Cycle	Duty Cycle Scaled factor	SAR (W/kg) 1-g	SAR (W/kg) 10-g	Power drift (dB)	Conducted power (dBm)	Tune up Limit (dBm)	Scaled factor	Scaled SAR 1-g (W/kg)	Liquid Temp.
Body Test data (Separate 0mm)												
Bottom Face	802.11b	1/2412	97.63%	1.024	0.002	0.001	0.01	17.18	17.50	1.076	0.002	22.0
Edge 1	802.11b	1/2412	97.63%	1.024	0.001	0.000	0.12	17.18	17.50	1.076	0.001	22.0
Edge 2	802.11b	1/2412	97.63%	1.024	0.040	0.012	0.09	17.18	17.50	1.076	0.044	22.0

Table 8: SAR Result Of 2.4GHz Wi-Fi

Note:

- 1) The maximum Scaled SAR value is marked in bold. Graph results refer to Appendix B
- 2) If the reported (scaled) SAR measured at the middle channel or highest output power channel for each test configuration is  $\leq 0.8$  W/kg then testing at the other channels is not required for such test configuration(s). Per Kdb248227 D01, When the reported SAR is  $> 0.8$  W/kg, SAR is required for that exposure configuration using the next highest measured output power channel.
- 3) Each channel was tested at the lowest data rate.
- 4) Per KDB248227 D01, for Body SAR test of Wi-Fi2.4G, SAR is measured for 2.4 GHz 802.11b DSSS using the initial test position procedure. The highest reported SAR for DSSS is adjusted by the ratio of OFDM 802.11g/n to DSSS specified maximum output power and the adjusted SAR is  $< 1.2$  W/kg, so SAR for 802.11g/n is not required.

**8.4.2 SAR Result Of Bluetooth**

Test position	Test mode	Test Ch./Freq.	Duty Cycle %	Duty Cycle Scaled factor	SAR (W/kg) 1-g	SAR (W/kg) 10-g	Power drift (dB)	Conducted power (dBm)	Tune up Limit (dBm)	Scaled factor	Scaled SAR 1-g (W/kg)	Liquid Temp.
Body Test data (Separate 0mm)												
Bottom Face	GFSK	39/2441	76.63%	1.305	0.000	0.000	-0.05	10.44	11.00	1.138	0.000	22.0
Edge 1	GFSK	39/2441	76.63%	1.305	0.000	0.000	0.00	10.44	11.00	1.138	0.000	22.0
Edge 2	GFSK	39/2441	76.63%	1.305	0.011	0.0024	0.19	10.44	11.00	1.138	0.016	22.0

Table 9: SAR Result Of Bluetooth

Note:

- 1) The maximum Scaled SAR value is marked in bold. Graph results refer to Appendix B
- 2) If the reported (scaled) SAR measured at the middle channel or highest output power channel for each test configuration is  $\leq 0.8$  W/kg then testing at the other channels is not required for such test configuration(s). Per Kdb248227 D01, When the reported SAR is  $> 0.8$  W/kg, SAR is required for that exposure configuration using the next highest measured output power channel.

### 8.4.3 SAR Result Of 5GHz Wi-Fi

Test position	Test mode	Test Ch./Freq.	Duty Cycle %	Duty Cycle Scaled factor	SAR (W/kg) 1-g	SAR (W/kg) 10-g	Power drift (dB)	Conducted power (dBm)	Tune up Limit (dBm)	Scaled factor	Scaled SAR (W/kg) 1-g	Liquid Temp.	SAR limit (W/kg)
Body Test data with U-NII-2A (Separate 0mm)													
Bottom Face	802.11nHT40 MCS0	62/5310	96.06	1.041	0.016	0.007	-0.04	13.72	14.0	1.067	0.018	22.2	1.6
Edge 1	802.11nHT40 MCS0	62/5310	96.06	1.041	0.009	0.004	0.03	13.72	14.0	1.067	0.010	22.2	1.6
Edge 2	802.11nHT40 MCS0	62/5310	96.06	1.041	0.288	0.071	0.08	13.72	14.0	1.067	0.320	22.2	1.6
Body Test data with U-NII-2C (Separate 0mm)													
Bottom Face	802.11nHT40 MCS0	102/5510	96.06	1.041	0.013	0.006	0.06	13.11	13.5	1.094	0.015	22.2	1.6
Edge 1	802.11nHT40 MCS0	102/5510	96.06	1.041	0.007	0.003	0.01	13.11	13.5	1.094	0.008	22.2	1.6
Edge 2	802.11nHT40 MCS0	102/5510	96.06	1.041	0.265	0.068	-0.04	13.11	13.5	1.094	0.302	22.2	1.6
Body Test data with U-NII-3 (Separate 0mm)													
Bottom Face	802.11nHT40 MCS0	151/5755	96.06	1.041	0.01	0.004	-0.02	12.65	13	1.084	0.011	22.2	1.6
Edge 1	802.11nHT40 MCS0	151/5755	96.06	1.041	0.006	0.002	0	12.65	13	1.084	0.007	22.2	1.6
Edge 2	802.11nHT40 MCS0	151/5755	96.06	1.041	0.183	0.047	0.02	12.65	13	1.084	0.206	22.2	1.6

Table 10: SAR Result Of 5GHz Wi-Fi

Note:

- 1) The maximum Scaled SAR value is marked in bold. Graph results refer to Appendix B
- 2) If the reported (scaled) SAR measured at the middle channel or highest output power channel for each test configuration is  $\leq 0.8$  W/kg then testing at the other channels is not required for such test configuration(s). Per Kdb248227 D01, When the reported SAR is  $> 0.8$  W/kg, SAR is required for that exposure configuration using the next highest measured output power channel.
- 3) Each channel was tested at the lowest data rate.
- 4) When the same maximum output power is specified for both bands, begin SAR measurement in U-NII-2A band by applying the OFDM SAR requirements. As the highest reported SAR for a test configuration is  $\leq 1.2$  W/kg, SAR is not required for U-NII-1 band for that configuration.
- 5) When the highest reported SAR for the initial test configuration is adjusted by the ratio of the subsequent test configuration to initial test configuration specified maximum output power and the adjusted SAR is  $\leq 1.2$  W/kg, SAR test for the other 802.11 modes are not required.

#### 8.4.4 Repeat SAR Measurement

Band	Mode	Test Position	Test Ch./Freq.	Original Measured SAR1g (mW/g)	1st Repeated SAR1g (mW/g)	Ratio
Wi-Fi5GHz	802.11 nHT40 MCS0	Edge 2	62/5310	0.288	NA	NA

Note:

- 1) Per KDB 865664 D01v01, for each frequency band, repeated SAR measurement is required only when the measured SAR is  $\geq 0.8W/Kg$
- 2) Per KDB 865664 D01v01, if the ratio of largest to smallest SAR for the original and first repeated measurement is  $\leq 1.2$  and the measured SAR  $< 1.45W/Kg$ , only one repeated measurement is required
- 3) The ratio is the difference in percentage between original and repeated measured SAR.

## 8.5 Multiple Transmitter Evaluation

### 8.5.1 Simultaneous SAR SAR test evaluation

#### Simultaneous Transmission

NO.	Simultaneous Transmission Configuration	Body
1	Wi-Fi 2.4GHz + Wi-Fi 5GHz	No
2	BT+ Wi-Fi	No

Note:

- 1) Wi-Fi and Bluetooth share the same Tx antenna and can't transmit simultaneously.



## 9 Equipment list

Test Platform	SPEAG DASY5 Professional					
Location	SGS-CCS Standards Technical Services Co., Ltd. Kunshan Branch					
Description	SAR Test System (Frequency range 300MHz-6GHz)					
Software Reference	DASY52 52.8.8(1222); SEMCAD X 14.6.10(7331)					
<b>Hardware Reference</b>						
Equipment	Manufacturer	Model	Serial Number	Calibration Date	Due date of calibration	
<input checked="" type="checkbox"/> P C	HP	Core(rm)3.16G	CZCO48171H	N/A	N/A	
<input checked="" type="checkbox"/> Signal Generator	Agilent	E8257C	MY43321570	2019/10/24	2020/10/23	
<input checked="" type="checkbox"/> S-Parameter Network Analyzer	Agilent	E5071B	MY42301382	2020/02/24	2021/02/23	
<input checked="" type="checkbox"/> DAK-3.5 probe	SPEAG	DAK-3.5	1102	N/A	N/A	
<input checked="" type="checkbox"/> Power meter	Anritsu	ML2495A	1445010	2020/04/21	2021/04/20	
<input checked="" type="checkbox"/> Power sensor	Anritsu	MA2411B	1339220	2020/04/21	2021/04/20	
<input checked="" type="checkbox"/> DAE	SPEAG	DAE4	1245	2020/05/27	2021/05/26	
<input checked="" type="checkbox"/> E-field PROBE	SPEAG	EX3DV4	3798	2020/05/29	2021/05/28	
<input checked="" type="checkbox"/> Dipole	SPEAG	D2450V2	817	2019/06/10	2022/06/09	
<input checked="" type="checkbox"/> Dipole	SPEAG	D5GHzV2	1095	2019/06/14	2022/06/13	
<input checked="" type="checkbox"/> Electro Thermometer	DTM	DTM3000	3030	2019/12/20	2020/12/19	
<input checked="" type="checkbox"/> Amplifier	Mini-circuits	ZVE-8G	110405	N/A	N/A	
<input checked="" type="checkbox"/> Amplifier	Mini-circuits	ZHL-42	QA1331003	N/A	N/A	
<input checked="" type="checkbox"/> 3db ATTENUATOR	MINI	MCL BW-S3W5	0533	N/A	N/A	
<input checked="" type="checkbox"/> DUMMY PROBE	SPEAG	DP_2	SPDP2001AA	N/A	N/A	
<input checked="" type="checkbox"/> Dual Directional Coupler	Woken	20W couple	DOM2BHW1A1	N/A	N/A	
<input checked="" type="checkbox"/> SAM PHANTOM (ELI4 v4.0)	SPEAG	QDOVA001BB	1102	N/A	N/A	
<input checked="" type="checkbox"/> Twin SAM Phantom	SPEAG	QD000P40CD	1609	N/A	N/A	
<input checked="" type="checkbox"/> ROBOT	SPEAG	TX60	F10/5E6AA1/A101	N/A	N/A	
<input checked="" type="checkbox"/> ROBOT KRC	SPEAG	CS8C	F10/5E6AA1/C101	N/A	N/A	
<input checked="" type="checkbox"/> LIQUID CALIBRATION KIT	ANTENNESSA	41/05 OCP9	00425167	N/A	N/A	

Note: All the equipments are within the valid period when the tests are performed.

All measurement facilities used to collect the measurement data are located at

No.10, Weiye Rd., Innovation Park, Eco & Tec. Development Part, Kunshan City, Jiangsu Province, China.



## **10 Calibration certificate**

Please see the Appendix C

## **11 Photographs**

Please see the Appendix D



## **Appendix A: Detailed System Check Results**

The plots are showing as followings.

Date: 2020/09/11

Test Laboratory: Compliance Certification Services Inc.

**SystemPerformanceCheck-Head 2450MHz**

**DUT: Dipole 2450 MHz; Type: D24500V2; Serial: 817**

Communication System: UID 0, CW; Frequency: 2450 MHz; Duty Cycle: 1:1  
 Medium parameters used:  $f = 2450$  MHz;  $\sigma = 1.81$  S/m;  $\epsilon_r = 38.839$ ;  $\rho = 1000$  kg/m<sup>3</sup>  
 Phantom section: Flat Section  
 Measurement Standard: DASYS (IEEE/IEC/ANSI C63.19-2007)

**DASY5 Configuration:**

- Probe: EX3DV4 - SN3798; ConvF(7.27, 7.27, 7.27); Calibrated: 2020/05/29;
- Sensor-Surface: 1.4mm (Mechanical Surface Detection)
- Electronics: DAE4 Sn1245; Calibrated: 2020/05/27
- Phantom: ELI v4.0; Type: QDOVA001BB; Serial: TP:1102
- Measurement SW: DASY52, Version 52.8 (8); SEMCAD X Version 14.6.10 (7331)

**Body/d=10mm, Pin=250 mW, dist=2.0mm (EX-Probe)/Area Scan (8x9x1):**

Measurement grid: dx=12mm, dy=12mm  
 Maximum value of SAR (measured) = 11.9 W/kg

**Body/d=10mm, Pin=250 mW, dist=2.0mm (EX-Probe)/Zoom Scan (7x7x7)  
(7x7x7)/Cube 0:**

Measurement grid: dx=5mm, dy=5mm, dz=5mm  
 Reference Value = 85.17 V/m; Power Drift = -0.16 dB  
 Peak SAR (extrapolated) = 18.8 W/kg  
**SAR(1 g) = 13.2 W/kg; SAR(10 g) = 6.16 W/kg**  
 Maximum value of SAR (measured) = 14.3 W/kg

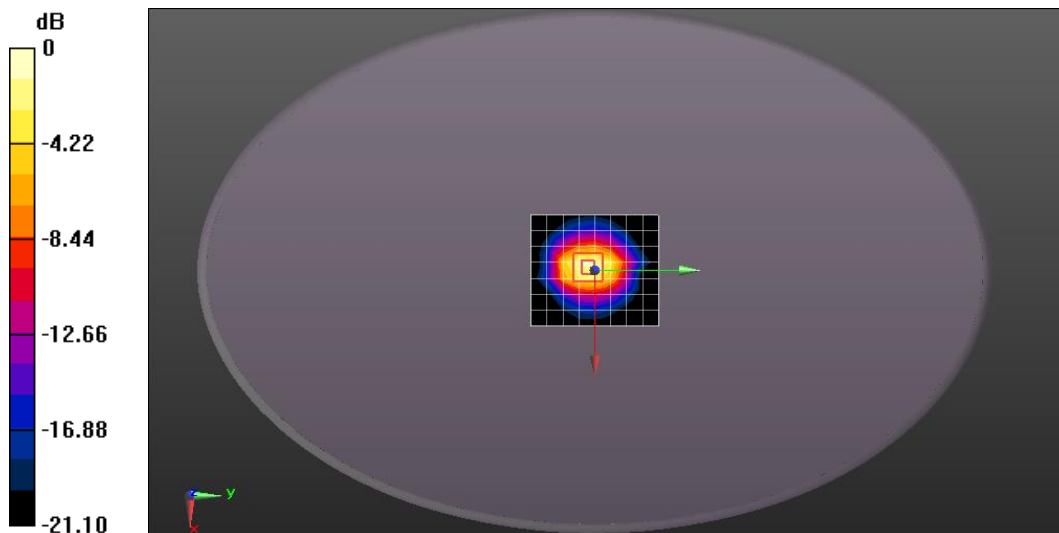

0 dB = 14.3 W/kg = 11.55 dBW/kg

Test Laboratory: Compliance Certification Services Inc.

**SystemPerformanceCheck-Head 5250MHz**

**DUT: Dipole D5GHzV2; Type: D5GHzV2; Serial: 1095**

Communication System: UID 0, CW (0); Frequency: 5250 MHz; Duty Cycle: 1:1  
 Medium parameters used:  $f = 5250 \text{ MHz}$ ;  $\sigma = 4.767 \text{ S/m}$ ;  $\epsilon_r = 36.011$ ;  $\rho = 1000 \text{ kg/m}^3$   
 Phantom section: Flat Section  
 Measurement Standard: DASYS (IEEE/IEC/ANSI C63.19-2007)

**DASY5 Configuration:**

- Probe: EX3DV4 - SN3798; ConvF(4.7, 4.7, 4.7); Calibrated: 2020/05/29;
- Sensor-Surface: 1.4mm (Mechanical Surface Detection)
- Electronics: DAE4 Sn1245; Calibrated: 2020/05/27
- Phantom: ELI v4.0; Type: QDOVA001BB; Serial: TP:1102
- Measurement SW: DASYS2, Version 52.8 (8); SEMCAD X Version 14.6.10 (7331)

**Body/d=10mm, Pin=100mW, f=5250 MHz/Area Scan (9x10x1):** Measurement grid:  
 $dx=10\text{mm}$ ,  $dy=10\text{mm}$   
 Maximum value of SAR (measured) = 16.6 W/kg

**Body/d=10mm, Pin=100mW, f=5250 MHz/Zoom Scan (4x4x1.4mm, graded),  
 dist=1.4mm (8x8x7)/Cube 0:** Measurement grid:  $dx=4\text{mm}$ ,  $dy=4\text{mm}$ ,  $dz=1.4\text{mm}$   
 Reference Value = 72.65 V/m; Power Drift = 0.08 dB  
 Peak SAR (extrapolated) = 34.8 W/kg  
**SAR(1 g) = 8.16 W/kg; SAR(10 g) = 2.22 W/kg**  
 Maximum value of SAR (measured) = 19.9 W/kg

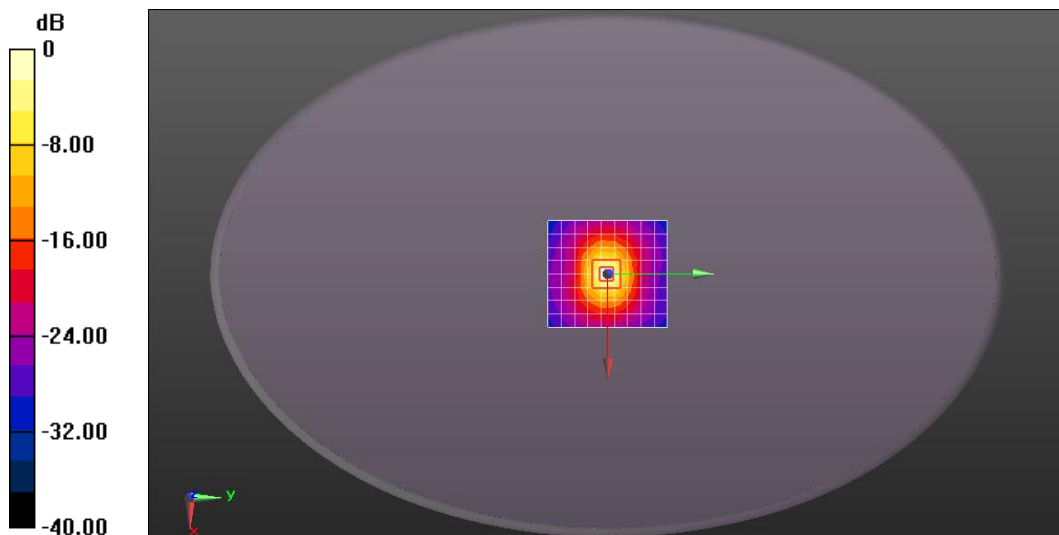

0 dB = 19.9 W/kg = 12.99 dBW/kg

Test Laboratory: Compliance Certification Services Inc.

**SystemPerformanceCheck-Head 5600MHz**

**DUT: Dipole D5GHzV2; Type: D5GHzV2; Serial: 1095**

Communication System: UID 0, CW (0); Frequency: 5600 MHz; Duty Cycle: 1:1  
 Medium parameters used:  $f = 5600$  MHz;  $\sigma = 5.157$  S/m;  $\epsilon_r = 35.059$ ;  $\rho = 1000$  kg/m<sup>3</sup>  
 Phantom section: Flat Section  
 Measurement Standard: DASYS (IEEE/IEC/ANSI C63.19-2007)

**DASY5 Configuration:**

- Probe: EX3DV4 - SN3798; ConvF(4.47, 4.47, 4.47); Calibrated: 2020/05/29;
- Sensor-Surface: 1.4mm (Mechanical Surface Detection)
- Electronics: DAE4 Sn1245; Calibrated: 2020/05/27
- Phantom: ELI v4.0; Type: QDOVA001BB; Serial: TP:1102
- Measurement SW: DASYS2, Version 52.8 (8); SEMCAD X Version 14.6.10 (7331)

**Body/d=10mm, Pin=100mW, f=5600 MHz/Area Scan (9x10x1):** Measurement grid:  
 dx=10mm, dy=10mm  
 Maximum value of SAR (measured) = 18.4 W/kg

**Body/d=10mm, Pin=100mW, f=5600 MHz/Zoom Scan (4x4x1.4mm, graded),  
 dist=1.4mm (8x8x7)/Cube 0:** Measurement grid: dx=4mm, dy=4mm, dz=1.4mm  
 Reference Value = 73.81 V/m; Power Drift = 0.03 dB  
 Peak SAR (extrapolated) = 40.5 W/kg  
**SAR(1 g) = 8.14 W/kg; SAR(10 g) = 2.27 W/kg**  
 Maximum value of SAR (measured) = 22.0 W/kg

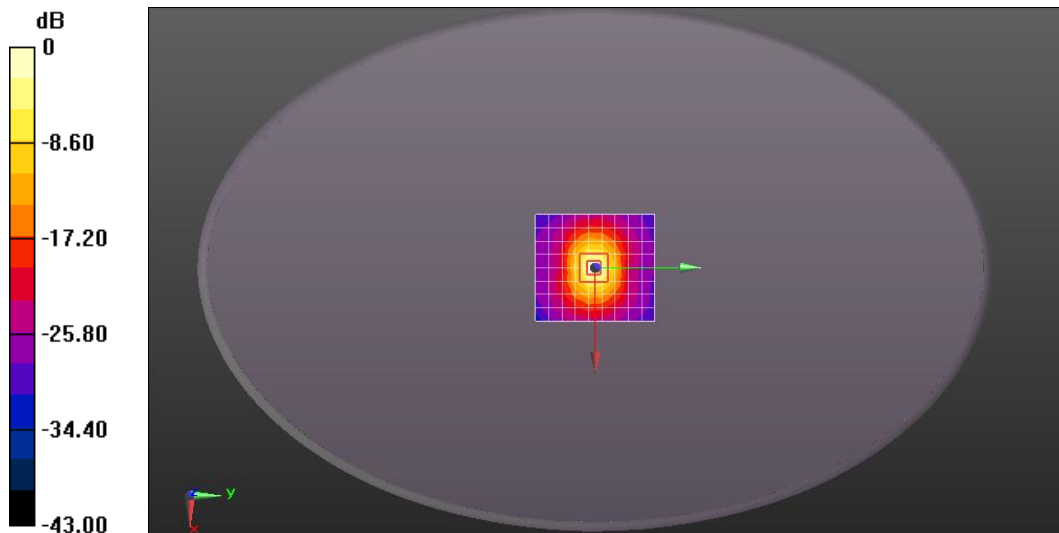

0 dB = 22.0 W/kg = 13.42 dBW/kg

Test Laboratory: Compliance Certification Services Inc.

**SystemPerformanceCheck-Head 5750MHz**

**DUT: Dipole D5GHzV2; Type: D5GHzV2; Serial: 1095**

Communication System: UID 0, CW (0); Frequency: 5750 MHz; Duty Cycle: 1:1  
 Medium parameters used:  $f = 5750 \text{ MHz}$ ;  $\sigma = 5.329 \text{ S/m}$ ;  $\epsilon_r = 34.695$ ;  $\rho = 1000 \text{ kg/m}^3$   
 Phantom section: Flat Section  
 Measurement Standard: DASYS (IEEE/IEC/ANSI C63.19-2007)

**DASY5 Configuration:**

- Probe: EX3DV4 - SN3798; ConvF(4.58, 4.58, 4.58); Calibrated: 2020/05/29;
- Sensor-Surface: 1.4mm (Mechanical Surface Detection)
- Electronics: DAE4 Sn1245; Calibrated: 2020/05/27
- Phantom: ELI v4.0; Type: QDOVA001BB; Serial: TP:1102
- Measurement SW: DASYS2, Version 52.8 (8); SEMCAD X Version 14.6.10 (7331)

**Body/d=10mm, Pin=100mW, f=5750 MHz/Area Scan (9x10x1):** Measurement grid:  
 $dx=10\text{mm}$ ,  $dy=10\text{mm}$   
 Maximum value of SAR (measured) = 17.0 W/kg

**Body/d=10mm, Pin=100mW, f=5750 MHz/Zoom Scan (4x4x1.4mm, graded),  
 dist=1.4mm (8x8x7)/Cube 0:** Measurement grid:  $dx=4\text{mm}$ ,  $dy=4\text{mm}$ ,  $dz=1.4\text{mm}$   
 Reference Value = 70.54 V/m; Power Drift = -0.03 dB  
 Peak SAR (extrapolated) = 39.7 W/kg  
**SAR(1 g) = 8.09 W/kg; SAR(10 g) = 2.28 W/kg**  
 Maximum value of SAR (measured) = 20.7 W/kg

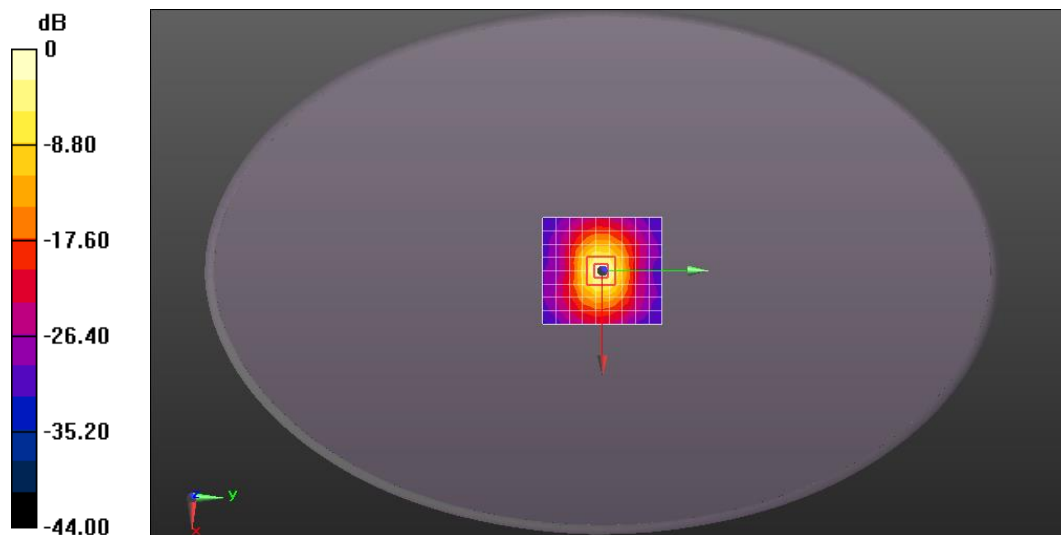

0 dB = 20.7 W/kg = 13.16 dBW/kg





## **Appendix B: Detailed Test Results**

**The plots of worse case are showing as followings.**

Date: 2020/09/11

Test Laboratory: Compliance Certification Services Inc.

**WLAN2.4G 802.11b 1Mbps Edge 2 Ch1 0mm**

**DUT: Mobile Tablet; Type: DT300Q11; Serial: NA**

Communication System: UID 0, WiFi (0); Frequency: 2412 MHz; Duty Cycle: 1:1  
 Medium parameters used:  $f = 2412$  MHz;  $\sigma = 1.786$  S/m;  $\epsilon_r = 38.868$ ;  $\rho = 1000$  kg/m<sup>3</sup>  
 Phantom section: Flat Section  
 Measurement Standard: DASYS (IEEE/IEC/ANSI C63.19-2007)

**DASY5 Configuration:**

- Probe: EX3DV4 - SN3798; ConvF(7.27, 7.27, 7.27); Calibrated: 2020/05/29;
- Sensor-Surface: 1.4mm (Mechanical Surface Detection)
- Electronics: DAE4 Sn1245; Calibrated: 2020/05/27
- Phantom: ELI v4.0; Type: QDOVA001BB; Serial: TP:1102
- Measurement SW: DASYS2, Version 52.8 (8); SEMCAD X Version 14.6.10 (7331)

**Configuration/Body/Area Scan (5x8x1):** Measurement grid: dx=12mm, dy=12mm  
 Maximum value of SAR (measured) = 0.0575 W/kg

**Configuration/Body/Zoom Scan (7x7x7)/Cube 0:** Measurement grid: dx=5mm, dy=5mm, dz=5mm

Reference Value = 0 V/m; Power Drift = 0.09 dB

Peak SAR (extrapolated) = 0.116 W/kg

**SAR(1 g) = 0.040 W/kg; SAR(10 g) = 0.012 W/kg**

Maximum value of SAR (measured) = 0.0853 W/kg

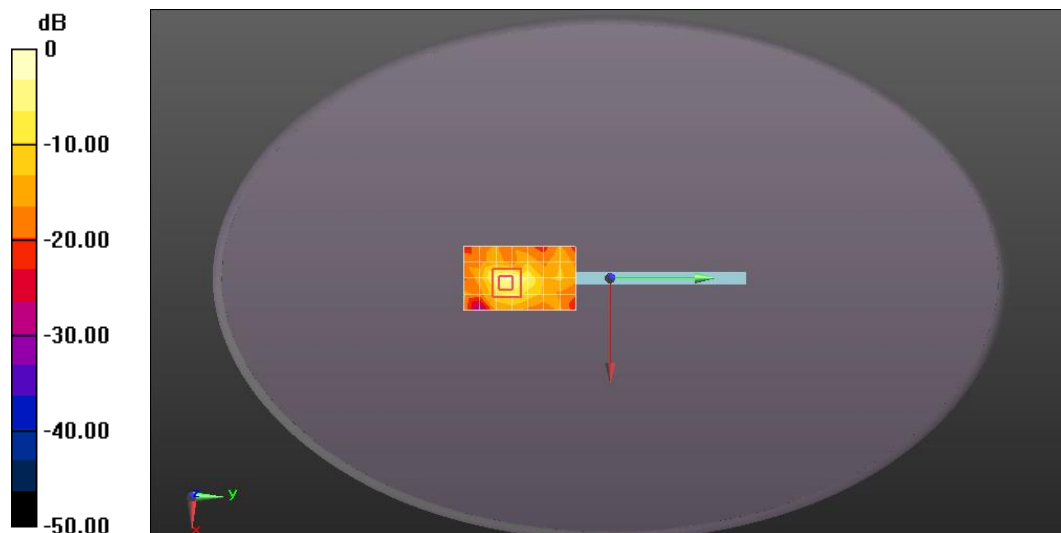

0 dB = 0.0853 W/kg = -10.69 dBW/kg

Test Laboratory: Compliance Certification Services Inc.

**Bluetooth GFSK 1Mbps Edge 2 Ch39 0mm**

**DUT: Mobile Tablet; Type: DT300Q11; Serial: NA**

Communication System: UID 0, Bluetooth (0); Frequency: 2441 MHz; Duty Cycle: 1:1  
 Medium parameters used:  $f = 2441 \text{ MHz}$ ;  $\sigma = 1.806 \text{ S/m}$ ;  $\epsilon_r = 38.875$ ;  $\rho = 1000 \text{ kg/m}^3$   
 Phantom section: Flat Section  
 Measurement Standard: DASYS (IEEE/IEC/ANSI C63.19-2007)

**DASY5 Configuration:**

- Probe: EX3DV4 - SN3798; ConvF(7.27, 7.27, 7.27); Calibrated: 2020/05/29;
- Sensor-Surface: 1.4mm (Mechanical Surface Detection)
- Electronics: DAE4 Sn1245; Calibrated: 2020/05/27
- Phantom: ELI v4.0; Type: QDOVA001BB; Serial: TP:1102
- Measurement SW: DASYS2, Version 52.8 (8); SEMCAD X Version 14.6.10 (7331)

**Configuration/Body/Area Scan (5x8x1):** Measurement grid:  $dx=12\text{mm}$ ,  $dy=12\text{mm}$   
 Maximum value of SAR (measured) = 0.0179 W/kg

**Configuration/Body/Zoom Scan (7x7x7)/Cube 0:** Measurement grid:  $dx=5\text{mm}$ ,  $dy=5\text{mm}$ ,  $dz=5\text{mm}$   
 Reference Value = 0 V/m; Power Drift = 0.19 dB  
 Peak SAR (extrapolated) = 0.0370 W/kg  
**SAR(1 g) = 0.011 W/kg; SAR(10 g) = 0.0024 W/kg**  
 Maximum value of SAR (measured) = 0.0288 W/kg

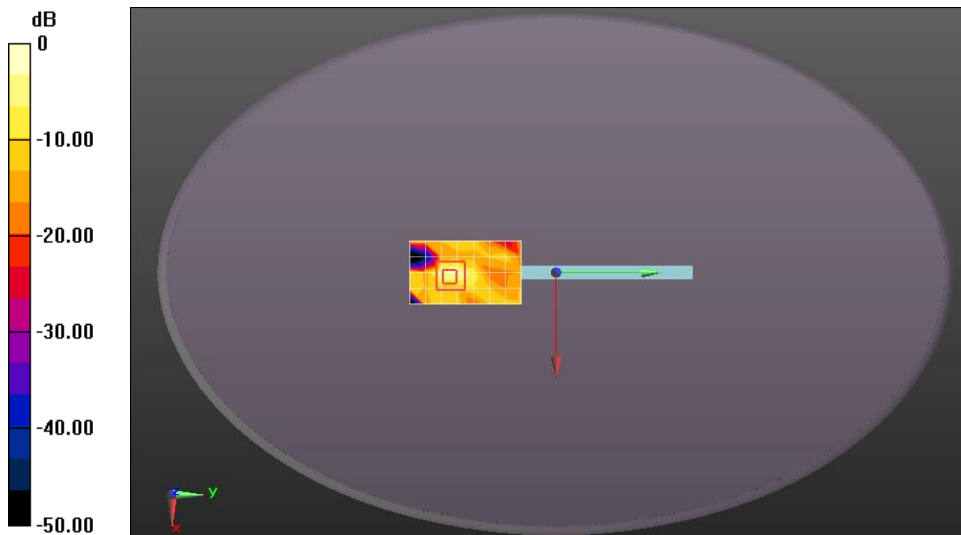

0 dB = 0.0288 W/kg = -15.41 dBW/kg

Test Laboratory: Compliance Certification Services Inc.

**WLAN5G 802.11nHT-40 MCS0 Edge 2 Ch62 0mm**

**DUT: Mobile Tablet; Type: DT300Q11; Serial: NA**

Communication System: UID 0, WiFi (0); Frequency: 5310 MHz; Duty Cycle: 1:1  
 Medium parameters used:  $f = 5310 \text{ MHz}$ ;  $\sigma = 4.816 \text{ S/m}$ ;  $\epsilon_r = 35.763$ ;  $\rho = 1000 \text{ kg/m}^3$   
 Phantom section: Flat Section  
 Measurement Standard: DASYS (IEEE/IEC/ANSI C63.19-2007)

**DASY5 Configuration:**

- Probe: EX3DV4 - SN3798; ConvF(4.7, 4.7, 4.7); Calibrated: 2020/05/29;
- Sensor-Surface: 1.4mm (Mechanical Surface Detection)
- Electronics: DAE4 Sn1245; Calibrated: 2020/05/27
- Phantom: ELI v4.0; Type: QDOVA001BB; Serial: TP:1102
- Measurement SW: DASYS2, Version 52.8 (8); SEMCAD X Version 14.6.10 (7331)

**Configuration/Body/Area Scan (6x8x1):** Measurement grid: dx=10mm, dy=10mm  
 Maximum value of SAR (measured) = 0.716 W/kg

**Configuration/Body/Zoom Scan (7x7x7)/Cube 0:** Measurement grid: dx=4mm, dy=4mm, dz=1.4mm

Reference Value = 1.038 V/m; Power Drift = 0.08 dB

Peak SAR (extrapolated) = 1.54 W/kg

**SAR(1 g) = 0.288 W/kg; SAR(10 g) = 0.071 W/kg**

Maximum value of SAR (measured) = 0.832 W/kg

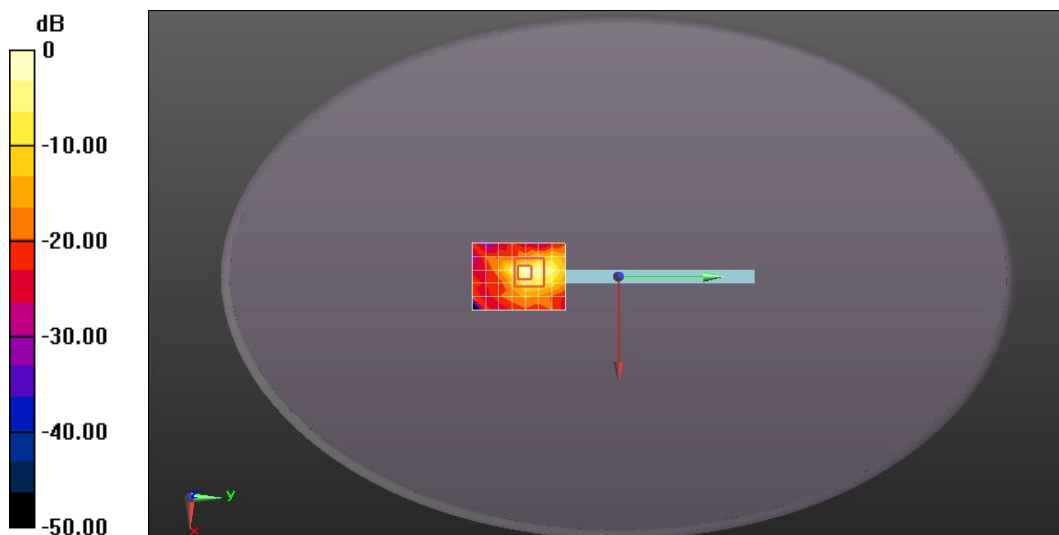

0 dB = 0.832 W/kg = -0.80 dBW/kg

Test Laboratory: Compliance Certification Services Inc.

**WLAN5G 802.11nHT-40 MCS0 Edge 2 Ch102 0mm**

**DUT: Mobile Tablet; Type: DT300Q11; Serial: NA**

Communication System: UID 0, WiFi (0); Frequency: 5510 MHz; Duty Cycle: 1:1  
 Medium parameters used:  $f = 5510 \text{ MHz}$ ;  $\sigma = 5.069 \text{ S/m}$ ;  $\epsilon_r = 35.339$ ;  $\rho = 1000 \text{ kg/m}^3$   
 Phantom section: Flat Section  
 Measurement Standard: DASYS (IEEE/IEC/ANSI C63.19-2007)

**DASY5 Configuration:**

- Probe: EX3DV4 - SN3798; ConvF(4.56, 4.56, 4.56); Calibrated: 2020/05/29;
- Sensor-Surface: 1.4mm (Mechanical Surface Detection)
- Electronics: DAE4 Sn1245; Calibrated: 2020/05/27
- Phantom: ELI v4.0; Type: QDOVA001BB; Serial: TP:1102
- Measurement SW: DASYS2, Version 52.8 (8); SEMCAD X Version 14.6.10 (7331)

**Configuration/Body/Area Scan (6x8x1):** Measurement grid:  $dx=10\text{mm}$ ,  $dy=10\text{mm}$   
 Maximum value of SAR (measured) = 0.776 W/kg

**Configuration/Body/Zoom Scan (7x7x7)/Cube 0:** Measurement grid:  $dx=4\text{mm}$ ,  
 $dy=4\text{mm}$ ,  $dz=1.4\text{mm}$   
 Reference Value = 1.466 V/m; Power Drift = -0.04 dB  
 Peak SAR (extrapolated) = 1.50 W/kg  
**SAR(1 g) = 0.265 W/kg; SAR(10 g) = 0.068 W/kg**  
 Maximum value of SAR (measured) = 0.839 W/kg

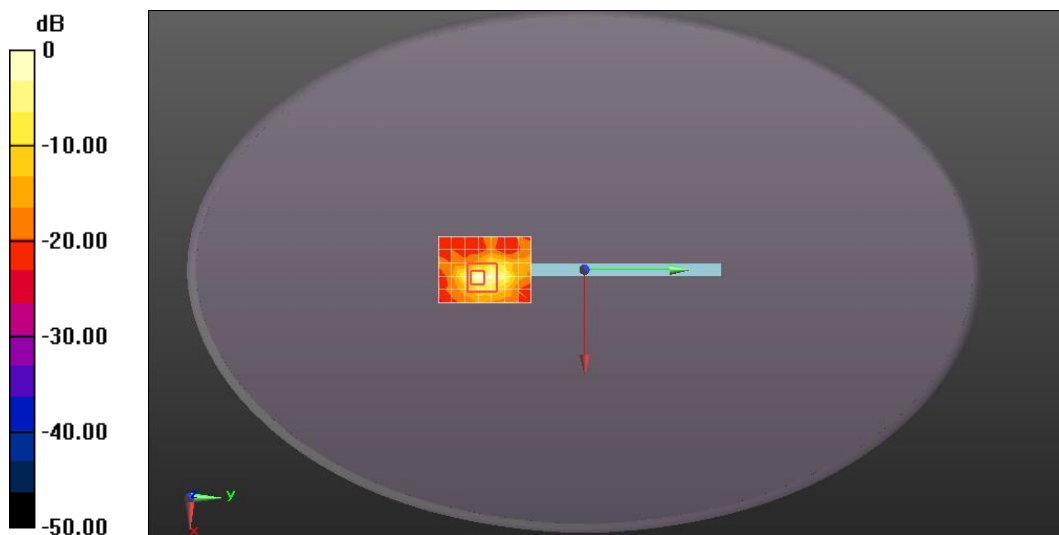

0 dB = 0.839 W/kg = -0.76 dBW/kg

Test Laboratory: Compliance Certification Services Inc.

**WLAN5G 802.11nHT-40 MCS0 Edge 2 Ch151 0mm**

**DUT: Mobile Tablet; Type: DT300Q11; Serial: NA**

Communication System: UID 0, WiFi (0); Frequency: 5755 MHz; Duty Cycle: 1:1  
 Medium parameters used:  $f = 5755 \text{ MHz}$ ;  $\sigma = 5.352 \text{ S/m}$ ;  $\epsilon_r = 34.626$ ;  $\rho = 1000 \text{ kg/m}^3$   
 Phantom section: Flat Section  
 Measurement Standard: DASYS (IEEE/IEC/ANSI C63.19-2007)

**DASY5 Configuration:**

- Probe: EX3DV4 - SN3798; ConvF(4.58, 4.58, 4.58); Calibrated: 2020/05/29;
- Sensor-Surface: 1.4mm (Mechanical Surface Detection)
- Electronics: DAE4 Sn1245; Calibrated: 2020/05/27
- Phantom: ELI v4.0; Type: QDOVA001BB; Serial: TP:1102
- Measurement SW: DASYS2, Version 52.8 (8); SEMCAD X Version 14.6.10 (7331)

**Configuration/Body/Area Scan (6x8x1):** Measurement grid: dx=10mm, dy=10mm  
 Maximum value of SAR (measured) = 0.548 W/kg

**Configuration/Body/Zoom Scan (7x7x7)/Cube 0:** Measurement grid: dx=4mm, dy=4mm, dz=1.4mm  
 Reference Value = 0.5510 V/m; Power Drift = 0.02 dB  
 Peak SAR (extrapolated) = 1.27 W/kg  
**SAR(1 g) = 0.183 W/kg; SAR(10 g) = 0.047 W/kg**  
 Maximum value of SAR (measured) = 0.621 W/kg

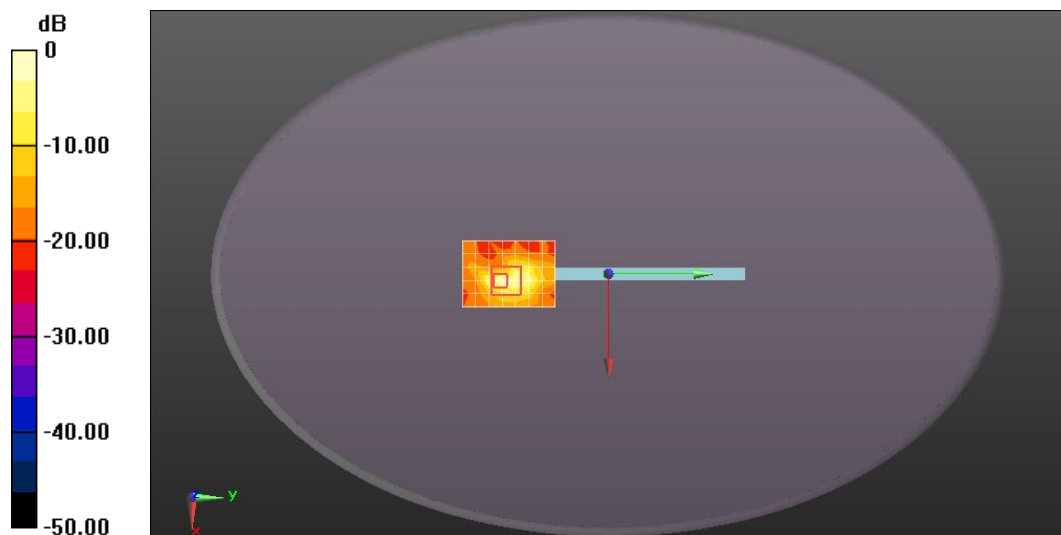

0 dB = 0.621 W/kg = -2.07 dBW/kg



**Compliance Certification Services  
(Kunshan) Inc.**

Report No.: KSEM200800102601

Page: 60 of 60

## Appendix C: Calibration certificate

## Appendix D: Photographs

**---END---**

---