

TEST REPORT

Application No.: SZCR2403000955AT
Applicant: DT Research, Inc.
Address of Applicant: 3RD FL NO 36 WUQUAN 7TH RD WUGU DISTRICT, NEW TAIPEI, Taiwan
Manufacturer: DT Research, Inc.
Address of Manufacturer: 2000 Concourse Drive, San Jose, CA 95131, USA
Factory: DT Research, Inc. Taiwan Branch
Address of Factory: 6F., No.36 Wuquan 7th Rd., Wugu Dist. New Taipei City 248 Taiwan
Equipment Under Test (EUT):

EUT Name: Battery Powered Computer
Model No.: 584TM, 584TXXXX ("X" = blank, A-Z or 0-9) ♣
♣ Please refer to section 2 of this report which indicates which model was actually tested and which were electrically identical.

Trade Mark:



FCC ID: YE3600-AX210NG
Standard(s) : 47 CFR Part 15, Subpart E 15.407
Date of Receipt: 2024-03-21
Date of Test: 2024-04-01 to 2024-04-12
Date of Issue: 2024-04-15

Test Result:	Pass*
---------------------	--------------

* In the configuration tested, the EUT complied with the standards specified above.

Keny Xu
EMC Laboratory Manager

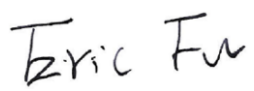

Revision Record				
Version	Chapter	Date	Modifier	Remark
01		2024-04-15		Original

Authorized for issue by:			
		 <hr/> Edison Li/Project Engineer	
		 <hr/> Eric Fu/Reviewer	



Unless otherwise agreed in writing, this document is issued by the Company subject to its General Conditions of Service printed overleaf, available on request or accessible at <https://www.sgs.com/en/Terms-and-Conditions>. Attention is drawn to the limitation of liability, indemnification and jurisdiction issues defined therein. Any holder of this document is advised that information contained hereon reflects the Company's findings at the time of its intervention only and within the limits of Client's instructions, if any. The Company's sole responsibility is to its Client and this document does not exonerate parties to a transaction from exercising all their rights and obligations under the transaction documents. This document cannot be reproduced except in full, without prior written approval of the Company. Any unauthorized alteration, forgery or falsification of the content or appearance of this document is unlawful and offenders may be prosecuted to the fullest extent of the law. Unless otherwise stated the results shown in this test report refer only to the sample(s) tested and such sample(s) are retained for 30 days only.

Attention: To check the authenticity of testing /inspection report & certificate, please contact us at telephone: (86-755) 8307 1443, or email: CN.Doccheck@sgs.com

2 Test Summary

Radio Spectrum Technical Requirement				
Item	Standard	Method	Requirement	Result
Antenna Requirement	47 CFR Part 15, Subpart E 15.407	N/A	47 CFR Part 15, Subpart C 15.203	Pass
Transmission in the Absence of Data		N/A	47 CFR Part 15, Subpart E 15.407 (c)	Pass

Radio Spectrum Matter Part				
Item	Standard	Method	Requirement	Result
Conducted Emissions at AC Power Line (150kHz-30MHz)	47 CFR Part 15, Subpart E 15.407	ANSI C63.10 (2013) Section 6.2	47 CFR Part 15, Subpart C 15.207 & Subpart E 15.407 b(9)	Pass
Radiated Emissions which fall in the restricted bands		KDB 789033 D02 II G	47 CFR Part 15, Subpart C 15.209 & Subpart E 15.407(b)	Pass
Radiated Emissions (Below 1GHz)		KDB 789033 D02 II G	47 CFR Part 15, Subpart C 15.209 & Subpart E 15.407(b)	Pass
Radiated Emissions (Above 1GHz)		KDB 789033 D02 II G	47 CFR Part 15, Subpart C 15.209 & Subpart E 15.407(b)	Pass
Contention Based Protocol		KDB 987594 D02 v02r01	47 CFR Part 15, Subpart E 15.407 (d)	Pass*
Non-occupancy period		KDB 905462 D02 Section 7.8.3	KDB 905462 D02 Section 5.1	Pass
Channel Move Time		KDB 905462 D02 Section 7.8.3	KDB 905462 D02 Section 5.1	Pass
Channel Closing Transmission Time		KDB 905462 D02 Section 7.8.3	KDB 905462 D02 Section 5.1	Pass

Remark:

Model No.: 584TM, 584TXXXX (“X” = blank, A-Z or 0-9)

Only the model 584TM was tested, since according to the declaration from the applicant, the electrical circuit design, PCB layout, components used and internal wiring and functions were identical for the above models, with only difference on model No..

This report is prepared for an FCC class II permissive change to install the granted module(FCC ID:YE3600-AX210NG, Granted on 05/06/2022) into a host product and also change the antenna gains.

Therefore in this report Conducted Emissions at AC Power Line (150kHz-30MHz), Radiated Emissions which fall in the restricted bands, Radiated Spurious Emissions, DFS and Contention Based Protocol were fully retested on model 584TM and shown the data in this report.

*: the Contention Based Protocol test is only apply for 6G WiFi function.



3 Contents

	Page
1 Cover Page	1
2 Test Summary	3
3 Contents	4
4 General Information	6
4.1 Details of E.U.T.	6
4.2 Description of Support Units	7
4.3 Measurement Uncertainty	7
4.4 Test Location	8
4.5 Test Facility	8
4.6 Deviation from Standards	8
4.7 Abnormalities from Standard Conditions	8
5 Equipment List	9
6 Radio Spectrum Technical Requirement	12
6.1 Antenna Requirement	12
6.1.1 Test Requirement:	12
6.1.2 Conclusion	12
6.2 Transmission in the Absence of Data	12
6.2.1 Test Requirement:	12
6.2.2 Conclusion	12
7 Radio Spectrum Matter Test Results	13
7.1 Conducted Emissions at AC Power Line (150kHz-30MHz)	13
7.1.1 E.U.T. Operation	13
7.1.2 Test Mode Description	13
7.1.3 Test Setup Diagram	15
7.1.4 Measurement Procedure and Data	15
7.2 Contention Based Protocol	18
7.2.1 E.U.T. Operation	18
7.2.2 Test Mode Description	18
7.2.3 Test Setup Diagram	19
7.2.4 Measurement Procedure and Data	19
7.2.5 Measurement Procedure and Data	20
7.3 Radiated Emissions which fall in the restricted bands	21
7.3.1 E.U.T. Operation	21
7.3.2 Test Mode Description	21
7.3.3 Test Setup Diagram	23
7.3.4 Measurement Procedure and Data	24
7.4 Radiated Emissions (Below 1GHz)	149
7.4.1 E.U.T. Operation	149
7.4.2 Test Mode Description	149



Unless otherwise agreed in writing, this document is issued by the Company subject to its General Conditions of Service printed overleaf, available on request or accessible at <https://www.sgs.com/en/Terms-and-Conditions>. Attention is drawn to the limitation of liability, indemnification and jurisdiction issues defined therein. Any holder of this document is advised that information contained hereon reflects the Company's findings at the time of its intervention only and within the limits of Client's instructions, if any. The Company's sole responsibility is to its Client and this document does not exonerate parties to a transaction from exercising all their rights and obligations under the transaction documents. This document cannot be reproduced except in full, without prior written approval of the Company. Any unauthorized alteration, forgery or falsification of the content or appearance of this document is unlawful and offenders may be prosecuted to the fullest extent of the law. Unless otherwise stated the results shown in this test report refer only to the sample(s) tested and such sample(s) are retained for 30 days only.

Attention: To check the authenticity of testing /inspection report & certificate, please contact us at telephone: (86-755) 8307 1443, or email: CN.Doccheck@sgs.com

7.4.3	Test Setup Diagram	151
7.4.4	Measurement Procedure and Data.....	152
7.5	Radiated Emissions (Above 1GHz).....	155
7.5.1	E.U.T. Operation	155
7.5.2	Test Mode Description	155
7.5.3	Test Setup Diagram	157
7.5.4	Measurement Procedure and Data.....	158
7.6	Non-occupancy period	333
7.6.1	E.U.T. Operation	333
7.6.2	Test Mode Description	333
7.6.3	Test Setup Diagram	334
7.6.4	Measurement Procedure and Data	335
7.7	Channel Move Time	336
7.7.1	E.U.T. Operation	336
7.7.2	Test Mode Description	336
7.7.3	Test Setup Diagram	337
7.7.4	Measurement Procedure and Data	338
7.8	Channel Closing Transmission Time	339
7.8.1	E.U.T. Operation	339
7.8.2	Test Mode Description	339
7.8.3	Test Setup Diagram	340
7.8.4	Measurement Procedure and Data	341
8	Test Setup Photo	342
9	EUT Constructional Details (EUT Photos)	342
10	Appendix	343



Unless otherwise agreed in writing, this document is issued by the Company subject to its General Conditions of Service printed overleaf, available on request or accessible at <https://www.sgs.com/en/Terms-and-Conditions>. Attention is drawn to the limitation of liability, indemnification and jurisdiction issues defined therein. Any holder of this document is advised that information contained hereon reflects the Company's findings at the time of its intervention only and within the limits of Client's instructions, if any. The Company's sole responsibility is to its Client and this document does not exonerate parties to a transaction from exercising all their rights and obligations under the transaction documents. This document cannot be reproduced except in full, without prior written approval of the Company. Any unauthorized alteration, forgery or falsification of the content or appearance of this document is unlawful and offenders may be prosecuted to the fullest extent of the law. Unless otherwise stated the results shown in this test report refer only to the sample(s) tested and such sample(s) are retained for 30 days only.

Attention: To check the authenticity of testing /inspection report & certificate, please contact us at telephone: (86-755) 8307 1443, or email: CN.Doccheck@sgs.com

4 General Information

4.1 Details of E.U.T.

Power supply:	Medical AC Adapter Model: EM11011M-190 Input: AC 100-240V, 2.0-1.0A, 50-60Hz Output: DC 19.0V, 6.31A, 120.0W Li-ion Rechargeable Battery Pack Model: ACC-006-591A(3INR19/66-3) Rated Capacity: 8250mAh Voltage: 10.9VDC Watt-Hour:90Wh			
Cable(s):	DC cable:120cm with a ferrite core			
Operation Frequency:	Band	Mode	Frequency Range(MHz)	Number of channels
	UNII Band I	802.11a/n/ac/ax(HT20)	5180-5240	4
		802.11n/ac/ax(HT40)	5190-5230	2
		802.11ac/ax(HT80)	5210	1
	UNII Band II-A	802.11a/n/ac/ax(HT20)	5260-5320	4
		802.11n/ac/ax(HT40)	5270-5310	2
		802.11ac/ax(HT80)	5290	1
	UNII Band II-C	802.11ac/ax(HT160)	5250	1
		802.11a/n/ac/ax(HT20)	5500-5720	12
		802.11n/ac/ax(HT40)	5510-5710	6
	UNII Band III	802.11ac/ax(HT80)	5530-5690	3
		802.11ac/ax(HT160)	5570	1
		802.11a/n/ac/ax(HT20)	5745-5825	5
	UNII Band 5	802.11n/ac/ax(HT40)	5755-5795	2
		802.11ac/ax(HT80)	5775	1
		802.11a/n/ac/ax(HT20)	5955-6415	24
	UNII Band 6	802.11n/ac/ax(HT40)	5965-6405	12
		802.11ac/ax(HT80)	5985-6385	6
		802.11ac/ax(HT160)	6025-6345	3
		802.11a/n/ac/ax(HT20)	6435-6515	5
	UNII Band 7	802.11n/ac/ax(HT40)	6445-6485	2
802.11ac/ax(HT80)		6465-6545	2	
802.11ac/ax(HT160)		6505	1	
802.11a/n/ac/ax(HT20)		6535-6855	17	
UNII Band 8	802.11n/ac/ax(HT40)	6525-6845	9	
	802.11ac/ax(HT80)	6625-6785	3	
	802.11ac/ax(HT160)	6665	1	
	UNII Band 8	802.11a/n/ac/ax(HT20)	6875-7115	13



Unless otherwise agreed in writing, this document is issued by the Company subject to its General Conditions of Service printed overleaf, available on request or accessible at <https://www.sgs.com/en/Terms-and-Conditions>. Attention is drawn to the limitation of liability, indemnification and jurisdiction issues defined therein. Any holder of this document is advised that information contained hereon reflects the Company's findings at the time of its intervention only and within the limits of Client's instructions, if any. The Company's sole responsibility is to its Client and this document does not exonerate parties to a transaction from exercising all their rights and obligations under the transaction documents. This document cannot be reproduced except in full, without prior written approval of the Company. Any unauthorized alteration, forgery or falsification of the content or appearance of this document is unlawful and offenders may be prosecuted to the fullest extent of the law. Unless otherwise stated the results shown in this test report refer only to the sample(s) tested and such sample(s) are retained for 30 days only.

Attention: To check the authenticity of testing /inspection report & certificate, please contact us at telephone: (86-755) 8307 1443, or email: CN.Doccheck@sgs.com

		802.11n/ac/ax(HT40)	6885-7085	6
		802.11ac/ax(HT80)	6865-7025	3
		802.11ac/ax(HT160)	6985	1
Modulation Type:	802.11a: OFDM(QPSK, BPSK, 16QAM, 64QAM) 802.11n: OFDM(QPSK, BPSK, 16QAM, 64QAM) 802.11ac: OFDM(QPSK, BPSK, 16QAM, 64QAM, 256QAM) 802.11ax: OFDMA(QPSK, BPSK, 16QAM, 64QAM, 256QAM, 1024QAM)			
DFS Function:	Slave without radar detection			
TPC Function:	Not support			
Antenna Type:	PIFA Antenna			
Antenna Gain:	Antenna1: 3.0dBi, Antenna2: 2.9dBi @5180MHz~5825MHz Antenna1: 2.3dBi, Antenna2: 3.1dBi @5955MHz~7115MHz Note: MIMO for 802.11n/ac/ax			

Remark: The information in this section is provided by the applicant or manufacturer, SGS is not liable to the accuracy, suitability, reliability or/and integrity of the information.

4.2 Description of Support Units

Description	Manufacturer	Model No.	Serial No.
--	--	--	--

The EUT has been tested as an independent unit.

4.3 Measurement Uncertainty

Test Item	Measurement Uncertainty
Conducted Emissions at AC Power Line (150kHz-30MHz)	± 3.1dB
Radiated Emissions which fall in the restricted bands	± 6.0dB (below 1GHz); ± 4.6dB (above 1GHz);
Radiated Emissions (Below 1GHz)	± 6.0dB for 3m; ± 5.0dB for 10m
Radiated Emissions (Above 1GHz)	± 4.6dB (1-18GHz); ± 4.8dB (18-40GHz)

Remark:

The U_{lab} (lab Uncertainty) is less than $U_{CISPR/ETSI}$ (CISPR/ETSI Uncertainty), so the test results

- compliance is deemed to occur if no measured disturbance level exceeds the disturbance limit;
- non-compliance is deemed to occur if any measured disturbance level exceeds the disturbance limit.



Unless otherwise agreed in writing, this document is issued by the Company subject to its General Conditions of Service printed overleaf, available on request or accessible at <https://www.sgs.com/en/Terms-and-Conditions>. Attention is drawn to the limitation of liability, indemnification and jurisdiction issues defined therein. Any holder of this document is advised that information contained hereon reflects the Company's findings at the time of its intervention only and within the limits of Client's instructions, if any. The Company's sole responsibility is to its Client and this document does not exonerate parties to a transaction from exercising all their rights and obligations under the transaction documents. This document cannot be reproduced except in full, without prior written approval of the Company. Any unauthorized alteration, forgery or falsification of the content or appearance of this document is unlawful and offenders may be prosecuted to the fullest extent of the law. Unless otherwise stated the results shown in this test report refer only to the sample(s) tested and such sample(s) are retained for 30 days only.

Attention: To check the authenticity of testing /inspection report & certificate, please contact us at telephone: (86-755) 8307 1443, or email: CN.Doccheck@sgs.com

4.4 Test Location

All tests were performed at:

SGS-CSTC Standards Technical Services Co., Ltd., Shenzhen Branch

No. 1 Workshop, M-10, Middle Section, Science & Technology Park, Nanshan District, Shenzhen, Guangdong, China. 518057.

Tel: +86 755 2601 2053 Fax: +86 755 2671 0594

No tests were sub-contracted.

4.5 Test Facility

The test facility is recognized, certified, or accredited by the following organizations:

• **A2LA (Certificate No. 3816.01)**

SGS-CSTC Standards Technical Services Co., Ltd., Shenzhen EMC Laboratory is accredited by the American Association for Laboratory Accreditation(A2LA). Certificate No. 3816.01.

• **VCCI (Member No. 1937)**

The 3m Fully-anechoic chamber for above 1GHz, 10m Semi-anechoic chamber for below 1GHz, Shielded Room for Mains Port Conducted Interference Measurement and Telecommunication Port Conducted Interference Measurement of SGS-CSTC Standards Technical Services Co., Ltd. Shenzhen EMC laboratory have been registered in accordance with the Regulations for Voluntary Control Measures with Registration No.: G-20026, R-14188, C-12383 and T-11153 respectively.

• **FCC –Designation Number: CN1336**

SGS-CSTC Standards Technical Services Co., Ltd., Shenzhen EMC Laboratory has been recognized as an accredited testing laboratory.

Designation Number: CN1336. Test Firm Registration Number: 787754.

• **Innovation, Science and Economic Development Canada**

SGS-CSTC Standards Technical Services Co., Ltd., Shenzhen EMC Laboratory has been recognized by ISED as an accredited testing laboratory.

CAB identifier: CN0006.

IC#: 4620C.

4.6 Deviation from Standards

None

4.7 Abnormalities from Standard Conditions

None



5 Equipment List

Conducted Emissions at AC Power Line (150kHz-30MHz)					
Equipment	Manufacturer	Model No.	Inventory No.	Cal Date	Cal Due Date
Shielding Room	ZhongYu Electron	GB-88	SEM001-06	2022-05-14	2025-05-13
EMI Test Receiver	Rohde&Schwarz	ESCI	SEM004-02	2024-03-14	2025-03-13
Matching Pad	N/A	N/A	SEM021-23	2024-03-20	2025-03-19
Matching Pad	N/A	N/A	SEM021-24	2024-03-20	2025-03-19
Measurement Software	AUDIX	e3 V8.2014-6-27a	N/A	N/A	N/A
Coaxial Cable	SGS	N/A	SEM024-01	2023-07-07	2024-07-06
LISN	Rohde&Schwarz	ENV216	SEM007-01	2023-09-19	2024-09-18
LISN	ETS-LINDGREN	3816/2	SEM007-02	2024-03-14	2025-03-13

Radiated Emissions which fall in the restricted bands					
Equipment	Manufacturer	Model No.	Inventory No.	Cal Date	Cal Due Date
3m Fully-Anechoic Chamber	AUDIX	N/A	SEM001-02	2023-04-01	2026-03-31
Signal Analyzer	Rohde & Schwarz	FSV40	SEM008-04	2024-03-15	2025-03-14
Horn Antenna	Rohde&Schwarz	HF907	SEM003-07	2023-07-23	2025-07-22
Microwave system amplifier	Agilent	83017A	SEM005-25	2023-09-19	2024-09-18
Measurement Software	AUDIX	e3 V8.2014-6-27	N/A	N/A	N/A
Coaxial Cable	SGS	N/A	SEM026-01	2023-07-07	2024-07-06

Radiated Emissions (Below 1GHz)					
Equipment	Manufacturer	Model No.	Inventory No.	Cal Date	Cal Due Date
Loop Antenna	ETS-Lindgren	6502	SEM003-08	2023-11-20	2025-11-19
3m Semi-Anechoic Chamber	ETS-LINDGREN	N/A	SEM001-01	2023-06-19	2026-06-18
MXE EMI Receiver	Agilent Technologies	N9038A	SEM004-15	2023-10-19	2024-10-18
BiConiLog Antenna	ETS-LINDGREN	3142C	SEM003-01	2023-09-16	2025-09-15
Pre-Amplifier	Agilent Technologies	8447D	SEM005-01	2024-03-14	2025-03-13
Measurement Software	AUDIX	e3 V8.2014-6-27	N/A	N/A	N/A
Coaxial Cable	SGS	N/A	SEM025-01	2023-07-07	2024-07-06



Unless otherwise agreed in writing, this document is issued by the Company subject to its General Conditions of Service printed overleaf, available on request or accessible at <https://www.sgs.com/en/Terms-and-Conditions>. Attention is drawn to the limitation of liability, indemnification and jurisdiction issues defined therein. Any holder of this document is advised that information contained hereon reflects the Company's findings at the time of its intervention only and within the limits of Client's instructions, if any. The Company's sole responsibility is to its Client and this document does not exonerate parties to a transaction from exercising all their rights and obligations under the transaction documents. This document cannot be reproduced except in full, without prior written approval of the Company. Any unauthorized alteration, forgery or falsification of the content or appearance of this document is unlawful and offenders may be prosecuted to the fullest extent of the law. Unless otherwise stated the results shown in this test report refer only to the sample(s) tested and such sample(s) are retained for 30 days only.

Attention: To check the authenticity of testing /inspection report & certificate, please contact us at telephone: (86-755) 8307 1443, or email: CN.Doccheck@sgs.com

SGS-CSTC Standards Technical Services Co., Ltd. Shenzhen Branch

SZEMC-TRF-01 Rev. A/1

Report No.: SZCR240300095506

Page: 10 of 356

Radiated Emissions (Above 1GHz)					
Equipment	Manufacturer	Model No.	Inventory No.	Cal Date	Cal Due Date
3m Fully-Anechoic Chamber	AUDIX	N/A	SEM001-02	2023-04-01	2026-03-31
Signal Analyzer	Rohde & Schwarz	FSV40	SEM008-04	2024-03-15	2025-03-14
Horn Antenna	Rohde&Schwarz	HF907	SEM003-07	2023-07-23	2025-07-22
Microwave system amplifier	Agilent	83017A	SEM005-25	2023-09-19	2024-09-18
Measurement Software	AUDIX	e3 V8.2014-6-27	N/A	N/A	N/A
Coaxial Cable	SGS	N/A	SEM026-01	2023-07-07	2024-07-06
Broad-Band Horn Antenna	Schwarzbeck	BBHA 9170	SEM003-15	2022-08-10	2024-08-09
Pre-Amplifier	Compliance Directions Systems Inc.	PAP-2640-50	SEM005-08	2024-03-15	2025-03-14

Contention Based Protocol					
Equipment	Manufacturer	Model No.	Inventory No.	Cal Date	Cal Due Date
DC Power Supply	Chroma	62012P-80-60	SEM011-11	2023-10-19	2024-10-18
MXA Signal Analyzer	KEYSIGHT	N9020A	SEM004-19	2024/3/14	2025/3/13
Signal Generator	KEYSIGHT	N5173B	SEM006-05	2023-09-27	2024-09-26
Measurement Software	TST PASS	TST PASS V2.0	N/A	N/A	N/A
Coaxial Cable	SGS	N/A	SEM031-01	2024-03-31	2025-03-30
Attenuator	Huber+Suhner	6620_SMA-50-1	SEM021-09	2024-03-31	2025-03-30

DFS					
Equipment	Manufacturer	Model No.	Inventory No.	Cal Date	Cal Due Date
Manual Step Attenuator	KEYSIGHT	8494B	SEM021-05	2024-03-27	2025-03-26
Manual Step Attenuator	KEYSIGHT	8496B	SEM021-06	2024-03-27	2025-03-26
Measurement Software	KEYSIGHT	Signal Studio for DFS Radar Profiles V2.2.0.0	N/A	N/A	N/A
Measurement Software	Agilent	ISMonitor10	N/A	N/A	N/A
MXG Vector Signal Generator	Agilent	N5182A	SEM006-21	2024-03-27	2025-03-26
MXA Signal Analyzer	KEYSIGHT	N9020A	SEM004-22	2024-03-14	2025-03-13



Unless otherwise agreed in writing, this document is issued by the Company subject to its General Conditions of Service printed overleaf, available on request or accessible at <https://www.sgs.com/en/Terms-and-Conditions>. Attention is drawn to the limitation of liability, indemnification and jurisdiction issues defined therein. Any holder of this document is advised that information contained hereon reflects the Company's findings at the time of its intervention only and within the limits of Client's instructions, if any. The Company's sole responsibility is to its Client and this document does not exonerate parties to a transaction from exercising all their rights and obligations under the transaction documents. This document cannot be reproduced except in full, without prior written approval of the Company. Any unauthorized alteration, forgery or falsification of the content or appearance of this document is unlawful and offenders may be prosecuted to the fullest extent of the law. Unless otherwise stated the results shown in this test report refer only to the sample(s) tested and such sample(s) are retained for 30 days only.

Attention: To check the authenticity of testing /inspection report & certificate, please contact us at telephone: (86-755) 8307 1443, or email: CN.Doccheck@sgs.com
 No.1 Workshop, M-10, Middle Section, Science & Technology Park, Nanshan District, Shenzhen, Guangdong, China 518057 t (86-755) 26012053 f (86-755) 26710594 www.sgs.com.cn
 中国·广东·深圳市南山区科技园中区M-10栋1号厂房 邮编: 518057 t (86-755) 26012053 f (86-755) 26710594 sgs.china@sgs.com

SGS-CSTC Standards Technical Services Co., Ltd. Shenzhen Branch

SZEMC-TRF-01 Rev. A/1

Report No.: SZCR240300095506

Page: 11 of 356

General used equipment					
Equipment	Manufacturer	Model No.	Inventory No.	Cal Date	Cal Due Date
Humidity/ Temperature Indicator	deli	8838	SEM002-32	2023-07-28	2024-07-27
Humidity/ Temperature Indicator	deli	8838	SEM002-33	2023-07-28	2024-07-27
Barometer	Changchun Meteorological Industry Factory	DYM3	SEM002-01	2024-03-18	2025-03-17



Unless otherwise agreed in writing, this document is issued by the Company subject to its General Conditions of Service printed overleaf, available on request or accessible at <https://www.sgs.com/en/Terms-and-Conditions>. Attention is drawn to the limitation of liability, indemnification and jurisdiction issues defined therein. Any holder of this document is advised that information contained hereon reflects the Company's findings at the time of its intervention only and within the limits of Client's instructions, if any. The Company's sole responsibility is to its Client and this document does not exonerate parties to a transaction from exercising all their rights and obligations under the transaction documents. This document cannot be reproduced except in full, without prior written approval of the Company. Any unauthorized alteration, forgery or falsification of the content or appearance of this document is unlawful and offenders may be prosecuted to the fullest extent of the law. Unless otherwise stated the results shown in this test report refer only to the sample(s) tested and such sample(s) are retained for 30 days only.

Attention: To check the authenticity of testing /inspection report & certificate, please contact us at telephone: (86-755) 8307 1443, or email: CN.Doccheck@sgs.com

6 Radio Spectrum Technical Requirement

6.1 Antenna Requirement

6.1.1 Test Requirement:

47 CFR Part 15, Subpart C 15.203

6.1.2 Conclusion

Standard Requirement:

An intentional radiator shall be designed to ensure that no antenna other than that furnished by the responsible party shall be used with the device. The use of a antenna that uses a unique coupling to the intentional radiator, the manufacturer may design the unit permanently attached antenna or of an so that a broken antenna can be replaced by the user, but the use of a standard antenna jack or electrical connector is prohibited.

EUT Antenna:

The antenna connector is a IPEX type that comply with Part15.203, the best case gain of the antenna1 is Antenna1: 3.0dBi, Antenna2: 2.9dBi @5180MHz~5825MHz; Antenna1: 2.3dBi, Antenna2: 3.1dBi @5955MHz~7115MHz.

Antenna location: Refer to internal photo.

6.2 Transmission in the Absence of Data

6.2.1 Test Requirement:

47 CFR Part 15, Subpart E 15.407 (c)

6.2.2 Conclusion

Standard Requirement:

The device shall automatically discontinue transmission in case of either absence of information to transmit or operational failure. These provisions are not intended to preclude the transmission of control or signalling information or the use of repetitive codes used by certain digital technologies to complete frame or burst intervals.

Applicants shall include in their application for equipment authorization a description of how this requirement is met.

EUT Details:

WIFI chip support automatically discontinue transmission in case of either absence of information to transmit or operational failure, if the chip detect absence of information to transmit or operational failure, it will be automatically shut off.



7 Radio Spectrum Matter Test Results

7.1 Conducted Emissions at AC Power Line (150kHz-30MHz)

Test Requirement 47 CFR Part 15, Subpart C 15.207 & Subpart E 15.407 b(9)

Test Method: ANSI C63.10 (2013) Section 6.2

Limit:

Frequency of emission(MHz)	Conducted limit(dB μ V)	
	Quasi-peak	Average
0.15-0.5	66 to 56*	56 to 46*
0.5-5	56	46
5-30	60	50

*Decreases with the logarithm of the frequency.

7.1.1 E.U.T. Operation

Operating Environment:

Temperature: 23.5 °C Humidity: 47.5 % RH Atmospheric Pressure: 1020 mbar

7.1.2 Test Mode Description

Pre-scan / Final test	Mode Code	Description
Pre-scan	21	TX mode (U-NII-1)_Keep the EUT in continuously transmitting mode with all modulation types. All data rates for each modulation type have been tested and found the data rate @ 6Mbps is the worst case of IEEE 802.11a; data rate @ HT0/HT8 is the worst case of IEEE 802.11n(HT20); data rate @ HT0/HT8 is the worst case of IEEE 802.11n(HT40); data rate @ VHT0 is the worst case of IEEE 802.11ac(HT80); data rate @ VHT0 is the worst case of IEEE 802.11ac(HT160); data rate @ HE0 is the worst case of IEEE 802.11ax(HT20); data rate @ HE0 is the worst case of IEEE 802.11ax(HT40); data rate @ HE0 is the worst case of IEEE 802.11ax(HT80); data rate @ HE0 is the worst case of IEEE 802.11ax(HT160). Only the data of worst case is recorded in the report.
Pre-scan	22	TX mode (U-NII-2A)_Keep the EUT in continuously transmitting mode with all modulation types. All data rates for each modulation type have been tested and found the data rate @ 6Mbps is the worst case of IEEE 802.11a; data rate @ HT0/HT8 is the worst case of IEEE 802.11n(HT20); data rate @ HT0/HT8 is the worst case of IEEE 802.11n(HT40); data rate @ VHT0 is the worst case of IEEE 802.11ac(HT80); data rate @ HE0 is the worst case of IEEE 802.11ax(HT20); data rate @ HE0 is the worst case of IEEE 802.11ax(HT40); data rate @ HE0 is the worst case of IEEE 802.11ax(HT80). Only the data of worst case is recorded in the report.
Pre-scan	23	TX mode (U-NII-2C)_Keep the EUT in continuously transmitting mode with all modulation types.All data rates for each modulation type have been tested and found the data rate @ 6Mbps is the worst case of IEEE 802.11a; data rate @ HT0/HT8 is the worst case of IEEE 802.11n(HT20); data rate @ HT0/HT8 is the worst case of IEEE 802.11n(HT40); data rate @ VHT0 is the worst case of IEEE 802.11ac(HT80); data rate @ VHT0 is the worst case of IEEE 802.11ac(HT160); data rate @ HE0 is the worst case of IEEE 802.11ax(HT20); data rate @ HE0 is the worst case of IEEE 802.11ax(HT40); data rate @ HE0 is the worst case of IEEE 802.11ax(HT80); data rate @ HE0 is the worst case of IEEE 802.11ax(HT160). Only the data of worst case is recorded in the report.



Unless otherwise agreed in writing, this document is issued by the Company subject to its General Conditions of Service printed overleaf, available on request or accessible at <https://www.sgs.com/en/Terms-and-Conditions>. Attention is drawn to the limitation of liability, indemnification and jurisdiction issues defined therein. Any holder of this document is advised that information contained hereon reflects the Company's findings at the time of its intervention only and within the limits of Client's instructions, if any. The Company's sole responsibility is to its Client and this document does not exonerate parties to a transaction from exercising all their rights and obligations under the transaction documents. This document cannot be reproduced except in full, without prior written approval of the Company. Any unauthorized alteration, forgery or falsification of the content or appearance of this document is unlawful and offenders may be prosecuted to the fullest extent of the law. Unless otherwise stated the results shown in this test report refer only to the sample(s) tested and such sample(s) are retained for 30 days only.

Attention: To check the authenticity of testing /inspection report & certificate, please contact us at telephone: (86-755) 8307 1443, or email: CN.Doccheck@sgs.com

		802.11ax(HT40); data rate @ HE0 is the worst case of IEEE 802.11ax(HT80); data rate @ HE0 is the worst case of IEEE 802.11ax(HT160). Only the data of worst case is recorded in the report.
Pre-scan	24	TX mode (U-NII-3)_Keep the EUT in continuously transmitting mode with all modulation types.All data rates for each modulation type have been tested and found the data rate @ 6Mbps is the worst case of IEEE 802.11a; data rate @ HT0/HT8 is the worst case of IEEE 802.11n(HT20); data rate @ HT0/HT8 is the worst case of IEEE 802.11n(HT40); data rate @ VHT0 is the worst case of IEEE 802.11ac(HT80); data rate @ HE0 is the worst case of IEEE 802.11ax(HT20); data rate @ HE0 is the worst case of IEEE 802.11ax(HT40); data rate @ HE0 is the worst case of IEEE 802.11ax(HT80). Only the data of worst case is recorded in the report.
Pre-scan	25	TX mode (U-NII-5)_Keep the EUT in continuously transmitting mode with all modulation types. All data rates for each modulation type have been tested and found the data rate @ 6Mbps is the worst case of IEEE 802.11a; data rate @ HT0/HT8 is the worst case of IEEE 802.11n(HT20); data rate @ HT0/HT8 is the worst case of IEEE 802.11n(HT40); data rate @ VHT0 is the worst case of IEEE 802.11ac(HT80); data rate @ VHT0 is the worst case of IEEE 802.11ac(HT160); data rate @ HE0 is the worst case of IEEE 802.11ax(HT20); data rate @ HE0 is the worst case of IEEE 802.11ax(HT40); data rate @ HE0 is the worst case of IEEE 802.11ax(HT80); data rate @ HE0 is the worst case of IEEE 802.11ax(HT160). Only the data of worst case is recorded in the report.
Pre-scan	26	TX mode (U-NII-6)_Keep the EUT in continuously transmitting mode with all modulation types. All data rates for each modulation type have been tested and found the data rate @ 6Mbps is the worst case of IEEE 802.11a; data rate @ HT0/HT8 is the worst case of IEEE 802.11n(HT20); data rate @ HT0/HT8 is the worst case of IEEE 802.11n(HT40); data rate @ VHT0 is the worst case of IEEE 802.11ac(HT80); data rate @ VHT0 is the worst case of IEEE 802.11ac(HT160); data rate @ HE0 is the worst case of IEEE 802.11ax(HT20); data rate @ HE0 is the worst case of IEEE 802.11ax(HT40); data rate @ HE0 is the worst case of IEEE 802.11ax(HT80); data rate @ HE0 is the worst case of IEEE 802.11ax(HT160). Only the data of worst case is recorded in the report.
Pre-scan	27	TX mode (U-NII-7)_Keep the EUT in continuously transmitting mode with all modulation types. All data rates for each modulation type have been tested and found the data rate @ 6Mbps is the worst case of IEEE 802.11a; data rate @ HT0/HT8 is the worst case of IEEE 802.11n(HT20); data rate @ HT0/HT8 is the worst case of IEEE 802.11n(HT40); data rate @ VHT0 is the worst case of IEEE 802.11ac(HT80); data rate @ VHT0 is the worst case of IEEE 802.11ac(HT160); data rate @ HE0 is the worst case of IEEE 802.11ax(HT20); data rate @ HE0 is the worst case of IEEE 802.11ax(HT40); data rate @ HE0 is the worst case of IEEE 802.11ax(HT80); data rate @ HE0 is the worst case of IEEE 802.11ax(HT160). Only the data of worst case is recorded in the report.
Final test	28	TX mode (U-NII-8)_Keep the EUT in continuously transmitting mode with all modulation types. All data rates for each modulation type have been tested and found the data rate @ 6Mbps is the worst case of IEEE 802.11a; data rate @ HT0/HT8 is the worst case of IEEE 802.11n(HT20); data rate @ HT0/HT8 is the worst case of IEEE 802.11n(HT40); data rate @ VHT0 is the worst case of IEEE 802.11ac(HT80); data rate @ VHT0 is the worst case of IEEE 802.11ac(HT160); data rate @ HE0 is the worst case of IEEE 802.11ax(HT20); data rate @ HE0 is the worst case of IEEE 802.11ax(HT40); data rate @ HE0 is the worst case of IEEE 802.11ax(HT80); data rate @ HE0 is the worst case of IEEE 802.11ax(HT160). Only the data of worst case is recorded in the report.



Unless otherwise agreed in writing, this document is issued by the Company subject to its General Conditions of Service printed overleaf, available on request or accessible at <https://www.sgs.com/en/Terms-and-Conditions>. Attention is drawn to the limitation of liability, indemnification and jurisdiction issues defined therein. Any holder of this document is advised that information contained hereon reflects the Company's findings at the time of its intervention only and within the limits of Client's instructions, if any. The Company's sole responsibility is to its Client and this document does not exonerate parties to a transaction from exercising all their rights and obligations under the transaction documents. This document cannot be reproduced except in full, without prior written approval of the Company. Any unauthorized alteration, forgery or falsification of the content or appearance of this document is unlawful and offenders may be prosecuted to the fullest extent of the law. Unless otherwise stated the results shown in this test report refer only to the sample(s) tested and such sample(s) are retained for 30 days only.

Attention: To check the authenticity of testing /inspection report & certificate, please contact us at telephone: (86-755) 8307 1443, or email: CN.Doccheck@sgs.com

SGS-CSTC Standards Technical Services Co., Ltd. Shenzhen Branch
 No.1 Workshop, M-10, Middle Section, Science & Technology Park, Nanshan District, Shenzhen, Guangdong, China 518057 t (86-755) 26012053 f (86-755) 26710594 www.sgs.com.cn
 中国·广东·深圳市南山区科技园中区M-10栋1号厂房 邮编: 518057 t (86-755) 26012053 f (86-755) 26710594 sgs.china@sgs.com

7.1.3 Test Setup Diagram

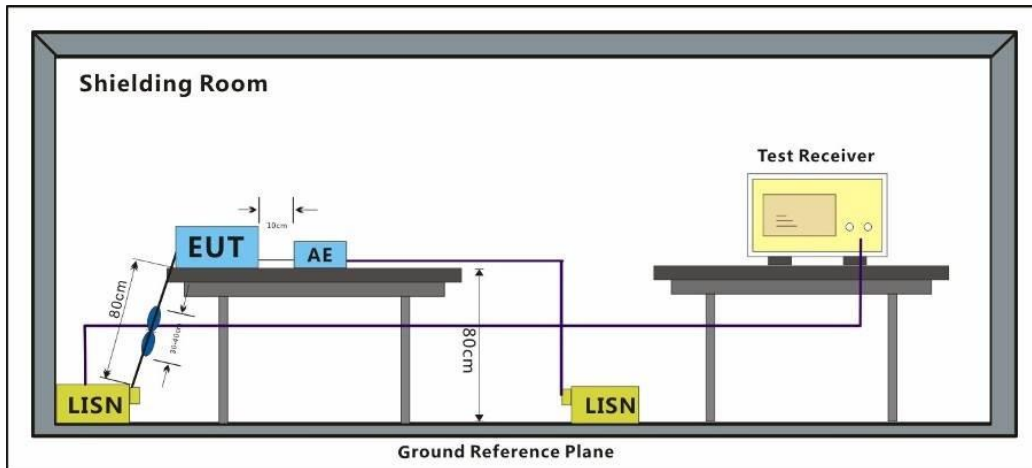

7.1.4 Measurement Procedure and Data

- 1) The mains terminal disturbance voltage test was conducted in a shielded room.
- 2) The EUT was connected to AC power source through a LISN 1 (Line Impedance Stabilization Network) which provides a 50ohm/50μH + 5ohm linear impedance. The power cables of all other units of the EUT were connected to a second LISN 2, which was bonded to the ground reference plane in the same way as the LISN 1 for the unit being measured. A multiple socket outlet strip was used to connect multiple power cables to a single LISN provided the rating of the LISN was not exceeded.
- 3) The tabletop EUT was placed upon a non-metallic table 0.8m above the ground reference plane. And for floor-standing arrangement, the EUT was placed on the horizontal ground reference plane,
- 4) The test was performed with a vertical ground reference plane. The rear of the EUT shall be 0.4 m from the vertical ground reference plane. The vertical ground reference plane was bonded to the horizontal ground reference plane. The LISN 1 was placed 0.8 m from the boundary of the unit under test and bonded to a ground reference plane for LISNs mounted on top of the ground reference plane. This distance was between the closest points of the LISN 1 and the EUT. All other units of the EUT and associated equipment was at least 0.8 m from the LISN 2.
- 5) In order to find the maximum emission, the relative positions of equipment and all of the interface cables must be changed according to ANSI C63.10 on conducted measurement.

Remark: Level=Read Level+ Cable Loss+ LISN Factor



Unless otherwise agreed in writing, this document is issued by the Company subject to its General Conditions of Service printed overleaf, available on request or accessible at <https://www.sgs.com/en/Terms-and-Conditions>. Attention is drawn to the limitation of liability, indemnification and jurisdiction issues defined therein. Any holder of this document is advised that information contained hereon reflects the Company's findings at the time of its intervention only and within the limits of Client's instructions, if any. The Company's sole responsibility is to its Client and this document does not exonerate parties to a transaction from exercising all their rights and obligations under the transaction documents. This document cannot be reproduced except in full, without prior written approval of the Company. Any unauthorized alteration, forgery or falsification of the content or appearance of this document is unlawful and offenders may be prosecuted to the fullest extent of the law. Unless otherwise stated the results shown in this test report refer only to the sample(s) tested and such sample(s) are retained for 30 days only.

Test Mode: 28; Line: Live line

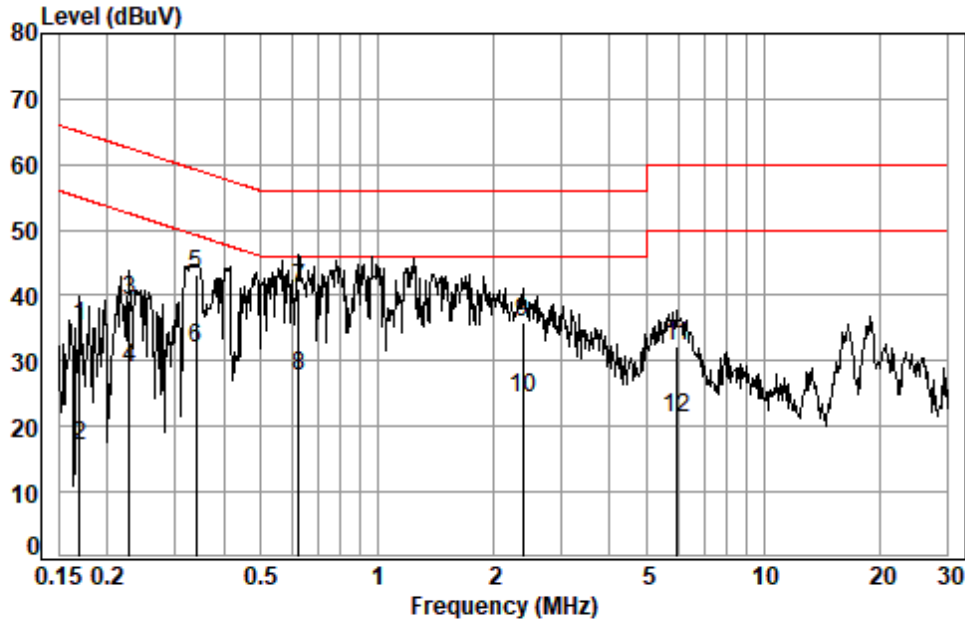

Site : Shielding Room
 Condition: Line
 Job No. : 00955AT/00956AT
 Test mode: 28

	Freq	Cable Loss	LISN Factor	Read Level	Limit Line	Over Limit	Remark
	MHz	dB	dB	dBuV	dBuV	dB	
1	0.1694	0.02	9.90	25.24	35.16	64.99	QP
2	0.1694	0.02	9.90	7.15	17.07	54.99	Average
3	0.2280	0.03	9.95	29.37	39.35	62.52	QP
4	0.2280	0.03	9.95	19.00	28.98	52.52	Average
5	0.3392	0.03	10.03	33.26	43.32	59.22	QP
6 *	0.3392	0.03	10.03	21.85	31.91	49.22	Average
7 *	0.6271	0.04	9.98	31.04	41.06	56.00	QP
8	0.6271	0.04	9.98	17.61	27.63	46.00	Average
9	2.3836	0.07	10.02	25.88	35.97	56.00	QP
10	2.3836	0.07	10.02	14.21	24.30	46.00	Average
11	5.9608	0.11	10.07	22.15	32.33	60.00	QP
12	5.9608	0.11	10.07	11.18	21.36	50.00	Average



Unless otherwise agreed in writing, this document is issued by the Company subject to its General Conditions of Service printed overleaf, available on request or accessible at <https://www.sgs.com/en/Terms-and-Conditions>. Attention is drawn to the limitation of liability, indemnification and jurisdiction issues defined therein. Any holder of this document is advised that information contained hereon reflects the Company's findings at the time of its intervention only and within the limits of Client's instructions, if any. The Company's sole responsibility is to its Client and this document does not exonerate parties to a transaction from exercising all their rights and obligations under the transaction documents. This document cannot be reproduced except in full, without prior written approval of the Company. Any unauthorized alteration, forgery or falsification of the content or appearance of this document is unlawful and offenders may be prosecuted to the fullest extent of the law. Unless otherwise stated the results shown in this test report refer only to the sample(s) tested and such sample(s) are retained for 30 days only.

Test Mode: 28; Line: Neutral Line

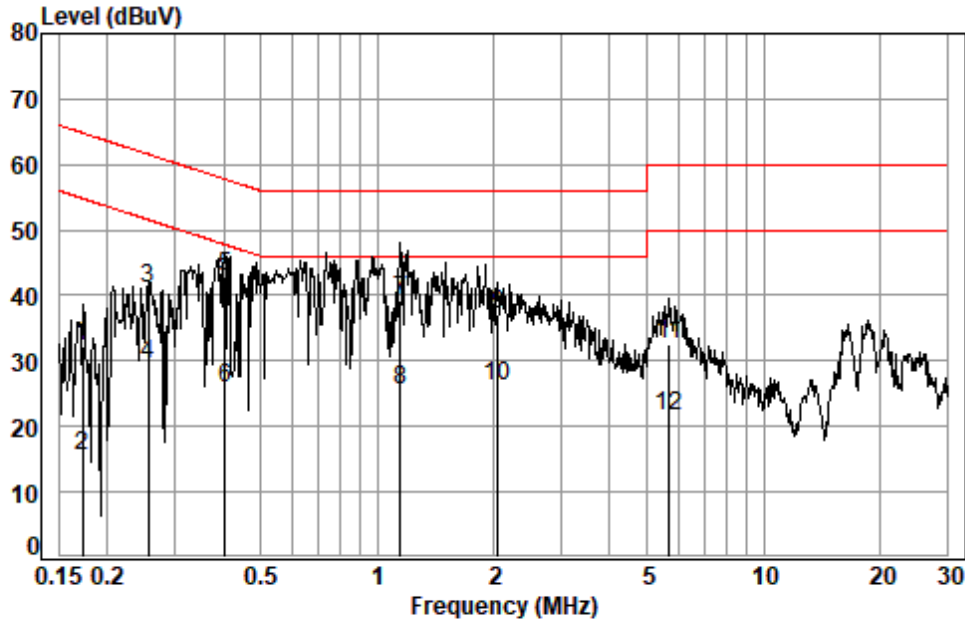

Site : Shielding Room
 Condition: Neutral
 Job No. : 00955AT/00956AT
 Test mode: 28

	Freq	Cable Loss	LISN Factor	Read Level	Limit Level	Limit Line	Over Limit	Remark
	MHz	dB	dB	dBuV	dBuV	dBuV	dB	
1	0.1731	0.02	9.90	22.33	32.25	64.81	-32.56	QP
2	0.1731	0.02	9.90	5.50	15.42	54.81	-39.39	Average
3	0.2562	0.03	9.91	31.22	41.16	61.56	-20.40	QP
4	0.2562	0.03	9.91	19.55	29.49	51.56	-22.07	Average
5 *	0.4040	0.03	9.92	33.05	43.00	57.77	-14.77	QP
6	0.4040	0.03	9.92	15.80	25.75	47.77	-22.02	Average
7	1.1473	0.06	9.98	29.15	39.19	56.00	-16.81	QP
8	1.1473	0.06	9.98	15.61	25.65	46.00	-20.35	Average
9	2.0549	0.07	9.96	27.04	37.07	56.00	-18.93	QP
10 *	2.0549	0.07	9.96	16.18	26.21	46.00	-19.79	Average
11	5.7135	0.10	10.04	22.37	32.51	60.00	-27.49	QP
12	5.7135	0.10	10.04	11.52	21.66	50.00	-28.34	Average



Unless otherwise agreed in writing, this document is issued by the Company subject to its General Conditions of Service printed overleaf, available on request or accessible at <https://www.sgs.com/en/Terms-and-Conditions>. Attention is drawn to the limitation of liability, indemnification and jurisdiction issues defined therein. Any holder of this document is advised that information contained hereon reflects the Company's findings at the time of its intervention only and within the limits of Client's instructions, if any. The Company's sole responsibility is to its Client and this document does not exonerate parties to a transaction from exercising all their rights and obligations under the transaction documents. This document cannot be reproduced except in full, without prior written approval of the Company. Any unauthorized alteration, forgery or falsification of the content or appearance of this document is unlawful and offenders may be prosecuted to the fullest extent of the law. Unless otherwise stated the results shown in this test report refer only to the sample(s) tested and such sample(s) are retained for 30 days only.

7.2 Contention Based Protocol

Test Requirement 47 CFR Part 15, Subpart E 15.407 (d)
 Test Method: KDB 987594 D02 v02r01
 Limit: Detect co-channel energy with 90% or greater certainty.

7.2.1 E.U.T. Operation

Operating Environment:
 Temperature: 22.7 °C Humidity: 54.4 % RH Atmospheric Pressure: 1020 mbar

7.2.2 Test Mode Description

Pre-scan / Final test	Mode Code	Description
Final test	25	TX mode (U-NII-5)_Keep the EUT in continuously transmitting mode with all modulation types. All data rates for each modulation type have been tested and found the data rate @ 6Mbps is the worst case of IEEE 802.11a; data rate @ HT0/HT8 is the worst case of IEEE 802.11n(HT20); data rate @ HT0/HT8 is the worst case of IEEE 802.11n(HT40); data rate @ VHT0 is the worst case of IEEE 802.11ac(HT80); data rate @ VHT0 is the worst case of IEEE 802.11ac(HT160); data rate @ HE0 is the worst case of IEEE 802.11ax(HT20); data rate @ HE0 is the worst case of IEEE 802.11ax(HT40); data rate @ HE0 is the worst case of IEEE 802.11ax(HT80); data rate @ HE0 is the worst case of IEEE 802.11ax(HT160). Only the data of worst case is recorded in the report.
Pre-scan	26	TX mode (U-NII-6)_Keep the EUT in continuously transmitting mode with all modulation types. All data rates for each modulation type have been tested and found the data rate @ 6Mbps is the worst case of IEEE 802.11a; data rate @ HT0/HT8 is the worst case of IEEE 802.11n(HT20); data rate @ HT0/HT8 is the worst case of IEEE 802.11n(HT40); data rate @ VHT0 is the worst case of IEEE 802.11ac(HT80); data rate @ VHT0 is the worst case of IEEE 802.11ac(HT160); data rate @ HE0 is the worst case of IEEE 802.11ax(HT20); data rate @ HE0 is the worst case of IEEE 802.11ax(HT40); data rate @ HE0 is the worst case of IEEE 802.11ax(HT80); data rate @ HE0 is the worst case of IEEE 802.11ax(HT160). Only the data of worst case is recorded in the report.
Pre-scan	27	TX mode (U-NII-7)_Keep the EUT in continuously transmitting mode with all modulation types. All data rates for each modulation type have been tested and found the data rate @ 6Mbps is the worst case of IEEE 802.11a; data rate @ HT0/HT8 is the worst case of IEEE 802.11n(HT20); data rate @ HT0/HT8 is the worst case of IEEE 802.11n(HT40); data rate @ VHT0 is the worst case of IEEE 802.11ac(HT80); data rate @ VHT0 is the worst case of IEEE 802.11ac(HT160); data rate @ HE0 is the worst case of IEEE 802.11ax(HT20); data rate @ HE0 is the worst case of IEEE 802.11ax(HT40); data rate @ HE0 is the worst case of IEEE 802.11ax(HT80); data rate @ HE0 is the worst case of IEEE 802.11ax(HT160). Only the data of worst case is recorded in the report.
Pre-scan	28	TX mode (U-NII-8)_Keep the EUT in continuously transmitting mode with all modulation types. All data rates for each modulation type have been tested and found the data rate @ 6Mbps is the worst case of IEEE 802.11a; data rate @ HT0/HT8 is the worst case of IEEE 802.11n(HT20); data rate @ HT0/HT8 is the worst case of IEEE 802.11n(HT40); data rate @ VHT0 is the worst case of IEEE 802.11ac(HT80); data rate @ VHT0 is the worst case of IEEE 802.11ac(HT160); data



Unless otherwise agreed in writing, this document is issued by the Company subject to its General Conditions of Service printed overleaf, available on request or accessible at <https://www.sgs.com/en/Terms-and-Conditions>. Attention is drawn to the limitation of liability, indemnification and jurisdiction issues defined therein. Any holder of this document is advised that information contained hereon reflects the Company's findings at the time of its intervention only and within the limits of Client's instructions, if any. The Company's sole responsibility is to its Client and this document does not exonerate parties to a transaction from exercising all their rights and obligations under the transaction documents. This document cannot be reproduced except in full, without prior written approval of the Company. Any unauthorized alteration, forgery or falsification of the content or appearance of this document is unlawful and offenders may be prosecuted to the fullest extent of the law. Unless otherwise stated the results shown in this test report refer only to the sample(s) tested and such sample(s) are retained for 30 days only.
 Attention: To check the authenticity of testing /inspection report & certificate, please contact us at telephone: (86-755) 8307 1443, or email: CN.Doccheck@sgs.com
 No.1 Workshop, M-10, Middle Section, Science & Technology Park, Nanshan District, Shenzhen, Guangdong, China 518057 t (86-755) 26012053 f (86-755) 26710594 www.sgs.com.cn
 中国·广东·深圳市南山区科技园中区M-10栋1号厂房 邮编: 518057 t (86-755) 26012053 f (86-755) 26710594 sgs.china@sgs.com

		rate @ HE0 is the worst case of IEEE 802.11ax(HT20); data rate @ HE0 is the worst case of IEEE 802.11ax(HT40); data rate @ HE0 is the worst case of IEEE 802.11ax(HT80); data rate @ HE0 is the worst case of IEEE 802.11ax(HT160). Only the data of worst case is recorded in the report.
--	--	--

7.2.3 Test Setup Diagram

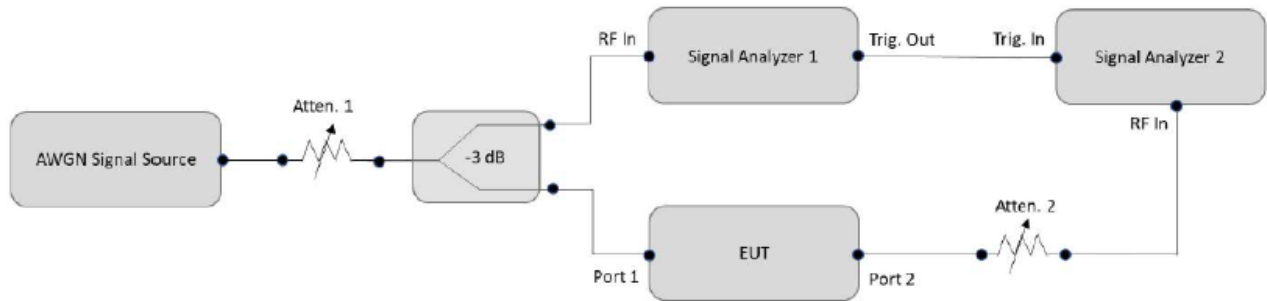

7.2.4 Measurement Procedure and Data

1. Configure the EUT to transmit with a constant duty cycle.
2. Set the operating parameters of the EUT including power level, operating frequency, modulation and bandwidth.
3. Set the signal analyzer center frequency to the nominal EUT channel center frequency. The span range of the signal analyzer shall be between two times and five times the OBW of the EUT. Connect the output port of the EUT to the signal analyzer 2, as shown in Figure 2. Ensure that the attenuator 2 provides enough attenuation to not overload the signal analyzer 2 receiver.
4. Monitoring the signal analyzer 2, verify the EUT is operating and transmitting with the parameters set at step two.
5. Using an AWGN signal source, generate (but do not transmit, i.e., RF OFF) a 10 MHz-wide AWGN signal. Use Table 1 to determine the center frequency of the 10 MHz AWGN signal relative to the EUT's channel bandwidth and center frequency.
6. Set the AWGN signal power to an extremely low level (more than 20 dB below the -62 dBm threshold). Connect the AWGN signal source, via a 3-dB splitter, to the signal analyzer 1.
7. Transmit the AWGN signal (RF ON) and verify its characteristics on the signal analyzer 1.
8. Monitor the signal analyzer 2 to verify if the AWGN signal has been detected and the EUT has ceased transmission. If the EUT continues to transmit, then incrementally increase the AWGN signal power level until the EUT stops transmitting.
9. (Including all losses in the RF paths) Determine and record the AWGN signal power level (at the EUT's antenna port) at which the EUT ceased transmission. Repeat the procedure at least 10 times to verify the EUT can detect an AWGN signal with 90% (or better) level of certainty.
10. Refer to Table 1 to determine number of times the detection threshold testing needs to be repeated. If testing is required more than once, then go back to step 5, choose a different center frequency for the AWGN signal and repeat the process.

Detection Level=Injected AWGN Power(dBm)-Antenna Gain(dBi)+Path Loss(dB)



Unless otherwise agreed in writing, this document is issued by the Company subject to its General Conditions of Service printed overleaf, available on request or accessible at <https://www.sgs.com/en/Terms-and-Conditions>. Attention is drawn to the limitation of liability, indemnification and jurisdiction issues defined therein. Any holder of this document is advised that information contained hereon reflects the Company's findings at the time of its intervention only and within the limits of Client's instructions, if any. The Company's sole responsibility is to its Client and this document does not exonerate parties to a transaction from exercising all their rights and obligations under the transaction documents. This document cannot be reproduced except in full, without prior written approval of the Company. Any unauthorized alteration, forgery or falsification of the content or appearance of this document is unlawful and offenders may be prosecuted to the fullest extent of the law. Unless otherwise stated the results shown in this test report refer only to the sample(s) tested and such sample(s) are retained for 30 days only.

7.2.5 Measurement Procedure and Data

Please Refer to Appendix for Details



Unless otherwise agreed in writing, this document is issued by the Company subject to its General Conditions of Service printed overleaf, available on request or accessible at <https://www.sgs.com/en/Terms-and-Conditions>. Attention is drawn to the limitation of liability, indemnification and jurisdiction issues defined therein. Any holder of this document is advised that information contained hereon reflects the Company's findings at the time of its intervention only and within the limits of Client's instructions, if any. The Company's sole responsibility is to its Client and this document does not exonerate parties to a transaction from exercising all their rights and obligations under the transaction documents. This document cannot be reproduced except in full, without prior written approval of the Company. Any unauthorized alteration, forgery or falsification of the content or appearance of this document is unlawful and offenders may be prosecuted to the fullest extent of the law. Unless otherwise stated the results shown in this test report refer only to the sample(s) tested and such sample(s) are retained for 30 days only.

Attention: To check the authenticity of testing /inspection report & certificate, please contact us at telephone: (86-755) 8307 1443, or email: CN.Doccheck@sgs.com

7.3 Radiated Emissions which fall in the restricted bands

Test Requirement 47 CFR Part 15, Subpart C 15.209 & Subpart E 15.407(b)
 Test Method: KDB 789033 D02 II G
 Measurement Distance: 3m
 Limit:

Frequency(MHz)	Field strength(microvolts/meter)	Measurement distance(meters)
0.009-0.490	2400/F(kHz)	300
0.490-1.705	24000/F(kHz)	30
1.705-30.0	30	30
30-88	100	3
88-216	150	3
216-960	200	3
Above 960	500	3

*(1) For transmitters operating in the 5.15-5.25 GHz band: All emissions outside of the 5.15-5.35 GHz band shall not exceed an e.i.r.p. of -27 dBm/MHz.

(2) For transmitters operating in the 5.25-5.35 GHz band: All emissions outside of the 5.15-5.35 GHz band shall not exceed an e.i.r.p. of -27 dBm/MHz.

(3) For transmitters operating in the 5.47-5.725 GHz band: All emissions outside of the 5.47-5.725 GHz band shall not exceed an e.i.r.p. of -27 dBm/MHz.

(4) For transmitters operating in the 5.725-5.85 GHz band:

(i) All emissions shall be limited to a level of -27 dBm/MHz at 75 MHz or more above or below the band edge increasing linearly to 10 dBm/MHz at 25 MHz above or below the band edge, and from 25 MHz above or below the band edge increasing linearly to a level of 15.6 dBm/MHz at 5 MHz above or below the band edge, and from 5 MHz above or below the band edge increasing linearly to a level of 27 dBm/MHz at the band edge.

Remark: The emission limits shown in the above table are based on measurements employing a CISPR quasi-peak detector except for the frequency bands 9-90kHz, 110-490kHz and above 1000 MHz. Radiated emission limits in these three bands are based on measurements employing an average detector, the peak field strength of any emission shall not exceed the maximum permitted average limits specified above by more than 20 dB under any condition of modulation.

7.3.1 E.U.T. Operation

Operating Environment:

Temperature: 21.9 °C Humidity: 55.4 % RH Atmospheric Pressure: 1020 mbar

7.3.2 Test Mode Description

Pre-scan / Final test	Mode Code	Description
Final test	21	TX mode (U-NII-1)_Keep the EUT in continuously transmitting mode with all modulation types. All data rates for each modulation type have been tested and



Unless otherwise agreed in writing, this document is issued by the Company subject to its General Conditions of Service printed overleaf, available on request or accessible at <https://www.sgs.com/en/Terms-and-Conditions>. Attention is drawn to the limitation of liability, indemnification and jurisdiction issues defined therein. Any holder of this document is advised that information contained hereon reflects the Company's findings at the time of its intervention only and within the limits of Client's instructions, if any. The Company's sole responsibility is to its Client and this document does not exonerate parties to a transaction from exercising all their rights and obligations under the transaction documents. This document cannot be reproduced except in full, without prior written approval of the Company. Any unauthorized alteration, forgery or falsification of the content or appearance of this document is unlawful and offenders may be prosecuted to the fullest extent of the law. Unless otherwise stated the results shown in this test report refer only to the sample(s) tested and such sample(s) are retained for 30 days only.

		found the data rate @ 6Mbps is the worst case of IEEE 802.11a; data rate @ HT0/HT8 is the worst case of IEEE 802.11n(HT20); data rate @ HT0/HT8 is the worst case of IEEE 802.11n(HT40); data rate @ VHT0 is the worst case of IEEE 802.11ac(HT80); data rate @ VHT0 is the worst case of IEEE 802.11ac(HT160); data rate @ HE0 is the worst case of IEEE 802.11ax(HT20); data rate @ HE0 is the worst case of IEEE 802.11ax(HT40); data rate @ HE0 is the worst case of IEEE 802.11ax(HT80); data rate @ HE0 is the worst case of IEEE 802.11ax(HT160). Only the data of worst case is recorded in the report.
Final test	22	TX mode (U-NII-2A)_Keep the EUT in continuously transmitting mode with all modulation types. All data rates for each modulation type have been tested and found the data rate @ 6Mbps is the worst case of IEEE 802.11a; data rate @ HT0/HT8 is the worst case of IEEE 802.11n(HT20); data rate @ HT0/HT8 is the worst case of IEEE 802.11n(HT40); data rate @ VHT0 is the worst case of IEEE 802.11ac(HT80); data rate @ HE0 is the worst case of IEEE 802.11ax(HT20); data rate @ HE0 is the worst case of IEEE 802.11ax(HT40); data rate @ HE0 is the worst case of IEEE 802.11ax(HT80). Only the data of worst case is recorded in the report.
Final test	23	TX mode (U-NII-2C)_Keep the EUT in continuously transmitting mode with all modulation types.All data rates for each modulation type have been tested and found the data rate @ 6Mbps is the worst case of IEEE 802.11a; data rate @ HT0/HT8 is the worst case of IEEE 802.11n(HT20); data rate @ HT0/HT8 is the worst case of IEEE 802.11n(HT40); data rate @ VHT0 is the worst case of IEEE 802.11ac(HT80); data rate @ VHT0 is the worst case of IEEE 802.11ac(HT160); data rate @ HE0 is the worst case of IEEE 802.11ax(HT20); data rate @ HE0 is the worst case of IEEE 802.11ax(HT40); data rate @ HE0 is the worst case of IEEE 802.11ax(HT80); data rate @ HE0 is the worst case of IEEE 802.11ax(HT160). Only the data of worst case is recorded in the report.
Final test	24	TX mode (U-NII-3)_Keep the EUT in continuously transmitting mode with all modulation types.All data rates for each modulation type have been tested and found the data rate @ 6Mbps is the worst case of IEEE 802.11a; data rate @ HT0/HT8 is the worst case of IEEE 802.11n(HT20); data rate @ HT0/HT8 is the worst case of IEEE 802.11n(HT40); data rate @ VHT0 is the worst case of IEEE 802.11ac(HT80); data rate @ HE0 is the worst case of IEEE 802.11ax(HT20); data rate @ HE0 is the worst case of IEEE 802.11ax(HT40); data rate @ HE0 is the worst case of IEEE 802.11ax(HT80). Only the data of worst case is recorded in the report.
Final test	25	TX mode (U-NII-5)_Keep the EUT in continuously transmitting mode with all modulation types. All data rates for each modulation type have been tested and found the data rate @ 6Mbps is the worst case of IEEE 802.11a; data rate @ HT0/HT8 is the worst case of IEEE 802.11n(HT20); data rate @ HT0/HT8 is the worst case of IEEE 802.11n(HT40); data rate @ VHT0 is the worst case of IEEE 802.11ac(HT80); data rate @ VHT0 is the worst case of IEEE 802.11ac(HT160); data rate @ HE0 is the worst case of IEEE 802.11ax(HT20); data rate @ HE0 is the worst case of IEEE 802.11ax(HT40); data rate @ HE0 is the worst case of IEEE 802.11ax(HT80); data rate @ HE0 is the worst case of IEEE 802.11ax(HT160). Only the data of worst case is recorded in the report.
Pre-scan	26	TX mode (U-NII-6)_Keep the EUT in continuously transmitting mode with all modulation types. All data rates for each modulation type have been tested and found the data rate @ 6Mbps is the worst case of IEEE 802.11a; data rate @ HT0/HT8 is the worst case of IEEE 802.11n(HT20); data rate @ HT0/HT8 is the worst case of IEEE 802.11n(HT40); data rate @ VHT0 is the worst case of IEEE 802.11ac(HT80); data rate @ VHT0 is the worst case of IEEE 802.11ac(HT160); data rate @ HE0 is the worst case of IEEE 802.11ax(HT20); data rate @ HE0 is the worst



Unless otherwise agreed in writing, this document is issued by the Company subject to its General Conditions of Service printed overleaf, available on request or accessible at <https://www.sgs.com/en/Terms-and-Conditions>. Attention is drawn to the limitation of liability, indemnification and jurisdiction issues defined therein. Any holder of this document is advised that information contained hereon reflects the Company's findings at the time of its intervention only and within the limits of Client's instructions, if any. The Company's sole responsibility is to its Client and this document does not exonerate parties to a transaction from exercising all their rights and obligations under the transaction documents. This document cannot be reproduced except in full, without prior written approval of the Company. Any unauthorized alteration, forgery or falsification of the content or appearance of this document is unlawful and offenders may be prosecuted to the fullest extent of the law. Unless otherwise stated the results shown in this test report refer only to the sample(s) tested and such sample(s) are retained for 30 days only.

		case of IEEE 802.11ax(HT40); data rate @ HE0 is the worst case of IEEE 802.11ax(HT80); data rate @ HE0 is the worst case of IEEE 802.11ax(HT160). Only the data of worst case is recorded in the report.
Pre-scan	27	TX mode (U-NII-7)_Keep the EUT in continuously transmitting mode with all modulation types. All data rates for each modulation type have been tested and found the data rate @ 6Mbps is the worst case of IEEE 802.11a; data rate @ HT0/HT8 is the worst case of IEEE 802.11n(HT20); data rate @ HT0/HT8 is the worst case of IEEE 802.11n(HT40); data rate @ VHT0 is the worst case of IEEE 802.11ac(HT80); data rate @ VHT0 is the worst case of IEEE 802.11ac(HT160); data rate @ HE0 is the worst case of IEEE 802.11ax(HT20); data rate @ HE0 is the worst case of IEEE 802.11ax(HT40); data rate @ HE0 is the worst case of IEEE 802.11ax(HT80); data rate @ HE0 is the worst case of IEEE 802.11ax(HT160). Only the data of worst case is recorded in the report.
Final test	28	TX mode (U-NII-8)_Keep the EUT in continuously transmitting mode with all modulation types. All data rates for each modulation type have been tested and found the data rate @ 6Mbps is the worst case of IEEE 802.11a; data rate @ HT0/HT8 is the worst case of IEEE 802.11n(HT20); data rate @ HT0/HT8 is the worst case of IEEE 802.11n(HT40); data rate @ VHT0 is the worst case of IEEE 802.11ac(HT80); data rate @ VHT0 is the worst case of IEEE 802.11ac(HT160); data rate @ HE0 is the worst case of IEEE 802.11ax(HT20); data rate @ HE0 is the worst case of IEEE 802.11ax(HT40); data rate @ HE0 is the worst case of IEEE 802.11ax(HT80); data rate @ HE0 is the worst case of IEEE 802.11ax(HT160). Only the data of worst case is recorded in the report.

7.3.3 Test Setup Diagram

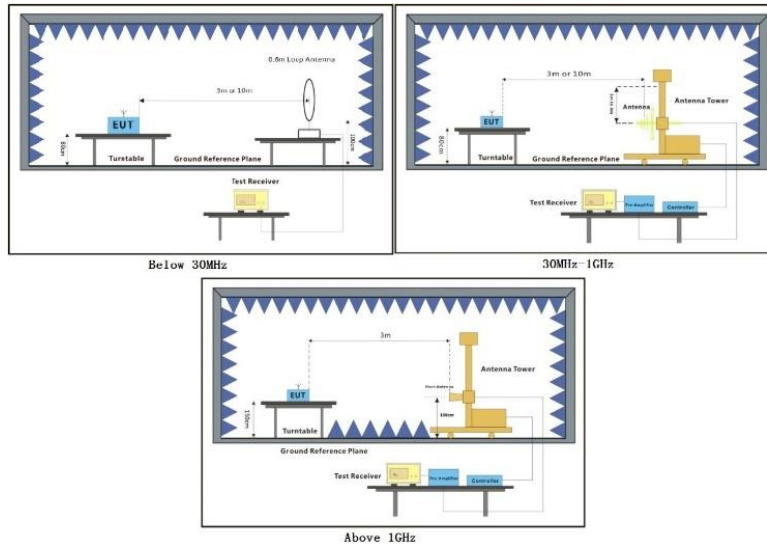

Unless otherwise agreed in writing, this document is issued by the Company subject to its General Conditions of Service printed overleaf, available on request or accessible at <https://www.sgs.com/en/Terms-and-Conditions>. Attention is drawn to the limitation of liability, indemnification and jurisdiction issues defined therein. Any holder of this document is advised that information contained hereon reflects the Company's findings at the time of its intervention only and within the limits of Client's instructions, if any. The Company's sole responsibility is to its Client and this document does not exonerate parties to a transaction from exercising all their rights and obligations under the transaction documents. This document cannot be reproduced except in full, without prior written approval of the Company. Any unauthorized alteration, forgery or falsification of the content or appearance of this document is unlawful and offenders may be prosecuted to the fullest extent of the law. Unless otherwise stated the results shown in this test report refer only to the sample(s) tested and such sample(s) are retained for 30 days only.

7.3.4 Measurement Procedure and Data

- a. For below 1GHz, the EUT was placed on the top of a rotating table 0.8 meters above the ground at a 3 or 10 meter semi-anechoic chamber. The table was rotated 360 degrees to determine the position of the highest radiation.
- b. For above 1GHz, the EUT was placed on the top of a rotating table 1.5 meters above the ground at a 3 meter fully-anechoic chamber. The table was rotated 360 degrees to determine the position of the highest radiation.
- c. The EUT was set 3 or 10 meters away from the interference-receiving antenna, which was mounted on the top of a variable-height antenna tower.
- d. The antenna height is varied from one meter to four meters above the ground to determine the maximum value of the field strength. Both horizontal and vertical polarizations of the antenna are set to make the measurement.
- e. For each suspected emission, the EUT was arranged to its worst case and then the antenna was tuned to heights from 1 meter to 4 meters (for the test frequency of below 30MHz, the antenna was tuned to heights 1 meter) and the rotatable table was turned from 0 degrees to 360 degrees to find the maximum reading.
- f. The test-receiver system was set to Peak Detect Function and Specified Bandwidth with Maximum Hold Mode.
- g. If the emission level of the EUT in peak mode was 10dB lower than the limit specified, then testing could be stopped and the peak values of the EUT would be reported. Otherwise the emissions that did not have 10dB margin would be re-tested one by one using peak, quasi-peak or average method as specified and then reported in a data sheet.
- h. Test the EUT in the lowest channel, the middle channel, the Highest channel.
- i. The radiation measurements are performed in X, Y, Z axis positioning for Transmitting mode, and found the X axis positioning which it is the worst case.
- j. Repeat above procedures until all frequencies measured was complete.

Remark 1: $Level = Read\ Level + Cable\ Loss + Antenna\ Factor - Preamp\ Factor$

Remark 2: For devices with multiple operating modes, measurements on the middle channel is used to determine the worst-case mode(s). Only the worst case mode with the widest bandwidth which can be covered the same channel (center frequency) on modes with narrower bandwidth that have the same or lower output power for each modulation family (e.g., OFDM and direct sequence spread spectrum) is recorded in the test report.

Remark 3: All modes and channels have been tested, only record the worst test result.



Unless otherwise agreed in writing, this document is issued by the Company subject to its General Conditions of Service printed overleaf, available on request or accessible at <https://www.sgs.com/en/Terms-and-Conditions>. Attention is drawn to the limitation of liability, indemnification and jurisdiction issues defined therein. Any holder of this document is advised that information contained hereon reflects the Company's findings at the time of its intervention only and within the limits of Client's instructions, if any. The Company's sole responsibility is to its Client and this document does not exonerate parties to a transaction from exercising all their rights and obligations under the transaction documents. This document cannot be reproduced except in full, without prior written approval of the Company. Any unauthorized alteration, forgery or falsification of the content or appearance of this document is unlawful and offenders may be prosecuted to the fullest extent of the law. Unless otherwise stated the results shown in this test report refer only to the sample(s) tested and such sample(s) are retained for 30 days only.

Attention: To check the authenticity of testing /inspection report & certificate, please contact us at telephone: (86-755) 8307 1443, or email: CN.Doccheck@sgs.com

Test Mode: 21; Polarity: Horizontal; Modulation:802.11a; Bandwidth:20MHz; Channel:Low

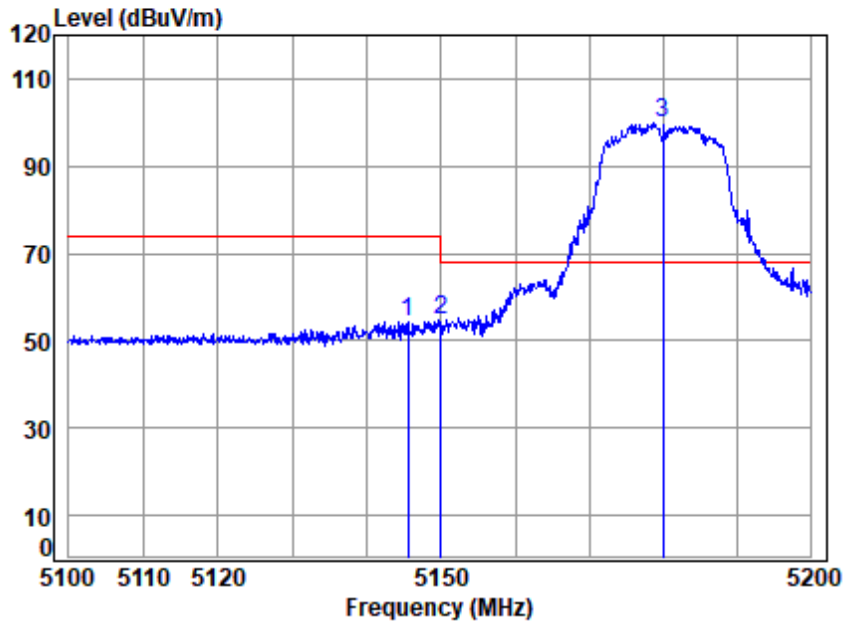

Site : chamber
 Condition: 3m HORIZONTAL
 Job No : 00955AT/00956AT
 Mode : 5180 Band edge
 : 5G WIFI 11A

	Cable	Ant	Preamp	Read	Limit	Over		
Freq	Loss	Factor	Factor	Level	Level	Line	Limit	Remark
MHz	dB	dB/m	dB	dBuV	dBuV/m	dBuV/m	dB	
1	5145.559	7.55	33.91	35.31	48.35	54.50	74.00	-19.50 peak
2	5149.980	7.55	33.90	35.31	48.39	54.53	74.00	-19.47 peak
3 p	5180.000	7.57	33.96	35.29	93.66	99.90	68.20	31.70 peak



Unless otherwise agreed in writing, this document is issued by the Company subject to its General Conditions of Service printed overleaf, available on request or accessible at <https://www.sgs.com/en/Terms-and-Conditions>. Attention is drawn to the limitation of liability, indemnification and jurisdiction issues defined therein. Any holder of this document is advised that information contained hereon reflects the Company's findings at the time of its intervention only and within the limits of Client's instructions, if any. The Company's sole responsibility is to its Client and this document does not exonerate parties to a transaction from exercising all their rights and obligations under the transaction documents. This document cannot be reproduced except in full, without prior written approval of the Company. Any unauthorized alteration, forgery or falsification of the content or appearance of this document is unlawful and offenders may be prosecuted to the fullest extent of the law. Unless otherwise stated the results shown in this test report refer only to the sample(s) tested and such sample(s) are retained for 30 days only.

Test Mode: 21; Polarity: Horizontal; Modulation:802.11a; Bandwidth:20MHz; Channel:Low

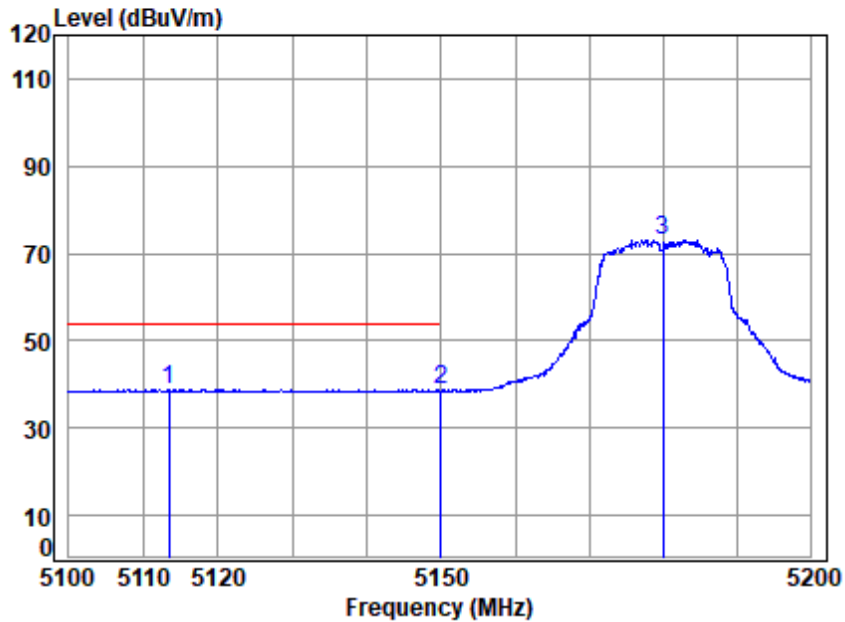

Site : chamber
 Condition: 3m HORIZONTAL
 Job No : 00955AT/00956AT
 Mode : 5180 Band edge
 : 5G WIFI 11A

	Cable	Ant	Preamp	Read	Limit	Over		
Freq	Loss	Factor	Factor	Level	Level	Line	Limit	Remark
MHz	dB	dB/m	dB	dBuV	dBuV/m	dBuV/m	dB	
1 q 5113.387	7.52	33.97	35.33	32.63	38.79	54.00	-15.21	Average
2 5149.980	7.55	33.90	35.31	32.53	38.67	54.00	-15.33	Average
3 5180.000	7.57	33.96	35.29	66.88	73.12	-----	-----	Average



Unless otherwise agreed in writing, this document is issued by the Company subject to its General Conditions of Service printed overleaf, available on request or accessible at <https://www.sgs.com/en/Terms-and-Conditions>. Attention is drawn to the limitation of liability, indemnification and jurisdiction issues defined therein. Any holder of this document is advised that information contained hereon reflects the Company's findings at the time of its intervention only and within the limits of Client's instructions, if any. The Company's sole responsibility is to its Client and this document does not exonerate parties to a transaction from exercising all their rights and obligations under the transaction documents. This document cannot be reproduced except in full, without prior written approval of the Company. Any unauthorized alteration, forgery or falsification of the content or appearance of this document is unlawful and offenders may be prosecuted to the fullest extent of the law. Unless otherwise stated the results shown in this test report refer only to the sample(s) tested and such sample(s) are retained for 30 days only.

Test Mode: 21; Polarity: Vertical; Modulation:802.11a; Bandwidth:20MHz; Channel:Low

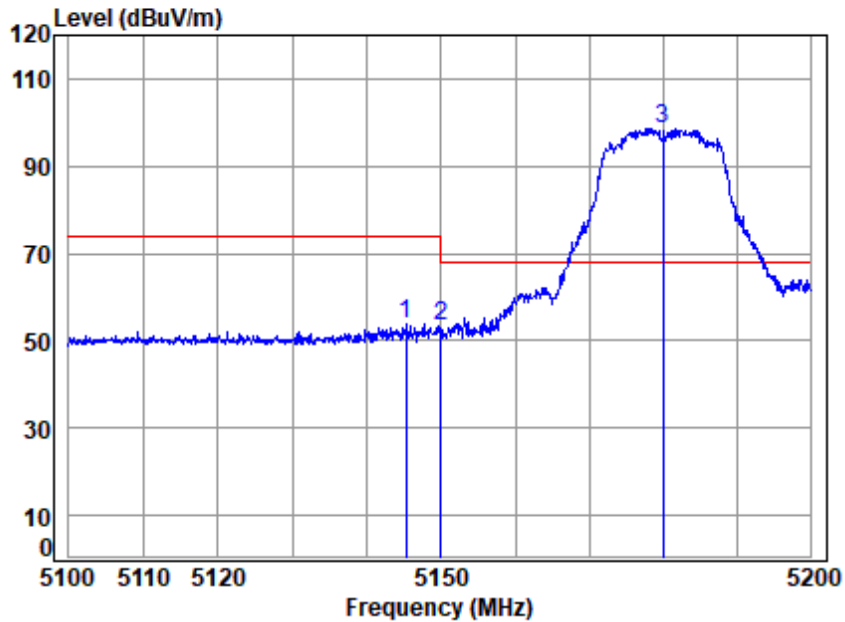

Site : chamber
 Condition: 3m VERTICAL
 Job No : 00955AT/00956AT
 Mode : 5180 Band edge
 : 5G WIFI 11A

	Cable	Ant	Preamp	Read	Limit	Over	
Freq	Loss	Factor	Factor	Level	Level	Line	Limit Remark
MHz	dB	dB/m	dB	dBuV	dBuV/m	dBuV/m	dB
1	5145.259	7.55	33.91	35.31	47.85	54.00	74.00 -20.00 Peak
2	5149.980	7.55	33.90	35.31	47.11	53.25	74.00 -20.75 Peak
3 p	5180.000	7.57	33.96	35.29	92.42	98.66	68.20 30.46 Peak



Unless otherwise agreed in writing, this document is issued by the Company subject to its General Conditions of Service printed overleaf, available on request or accessible at <https://www.sgs.com/en/Terms-and-Conditions>. Attention is drawn to the limitation of liability, indemnification and jurisdiction issues defined therein. Any holder of this document is advised that information contained hereon reflects the Company's findings at the time of its intervention only and within the limits of Client's instructions, if any. The Company's sole responsibility is to its Client and this document does not exonerate parties to a transaction from exercising all their rights and obligations under the transaction documents. This document cannot be reproduced except in full, without prior written approval of the Company. Any unauthorized alteration, forgery or falsification of the content or appearance of this document is unlawful and offenders may be prosecuted to the fullest extent of the law. Unless otherwise stated the results shown in this test report refer only to the sample(s) tested and such sample(s) are retained for 30 days only.

Test Mode: 21; Polarity: Vertical; Modulation:802.11a; Bandwidth:20MHz; Channel:Low

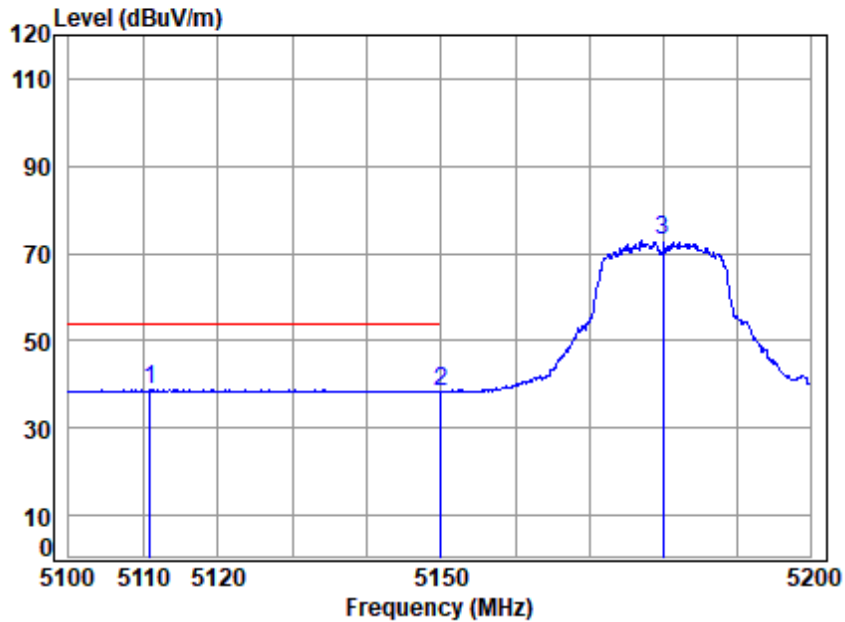

Site : chamber
 Condition: 3m VERTICAL
 Job No : 00955AT/00956AT
 Mode : 5180 Band edge
 : 5G WIFI 11A

	Cable	Ant	Preamp	Read	Limit	Over		
Freq	Loss	Factor	Factor	Level	Level	Line	Limit	Remark
MHz	dB	dB/m	dB	dBuV	dBuV/m	dBuV/m	dB	
1 q 5110.905	7.52	33.98	35.33	32.59	38.76	54.00	-15.24	Average
2 5149.980	7.55	33.90	35.31	32.39	38.53	54.00	-15.47	Average
3 5180.000	7.57	33.96	35.29	66.54	72.78	-----	-----	Average



Unless otherwise agreed in writing, this document is issued by the Company subject to its General Conditions of Service printed overleaf, available on request or accessible at <https://www.sgs.com/en/Terms-and-Conditions>. Attention is drawn to the limitation of liability, indemnification and jurisdiction issues defined therein. Any holder of this document is advised that information contained hereon reflects the Company's findings at the time of its intervention only and within the limits of Client's instructions, if any. The Company's sole responsibility is to its Client and this document does not exonerate parties to a transaction from exercising all their rights and obligations under the transaction documents. This document cannot be reproduced except in full, without prior written approval of the Company. Any unauthorized alteration, forgery or falsification of the content or appearance of this document is unlawful and offenders may be prosecuted to the fullest extent of the law. Unless otherwise stated the results shown in this test report refer only to the sample(s) tested and such sample(s) are retained for 30 days only.

Test Mode: 21; Polarity: Horizontal; Modulation:802.11a; Bandwidth:20MHz; Channel:High

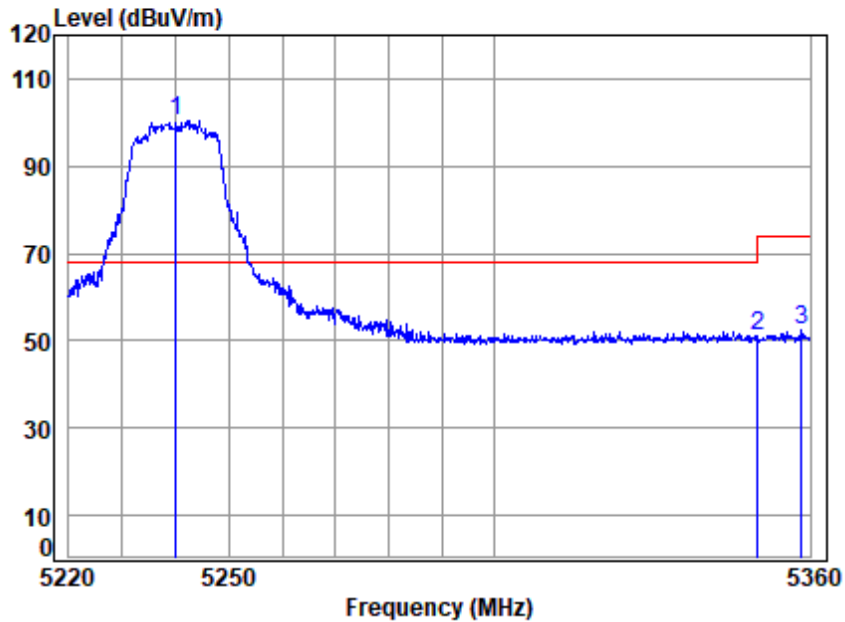

Site : chamber
 Condition: 3m HORIZONTAL
 Job No : 00955AT/00956AT
 Mode : 5240 Band edge
 : 5G WIFI 11A

	Cable	Ant	Preamp	Read	Limit	Over		
Freq	Loss	Factor	Factor	Level	Level	Line	Limit	Remark
MHz	dB	dB/m	dB	dBuV	dBuV/m	dBuV/m	dB	
1 p 5240.000	7.62	34.08	35.26	94.14	100.58	68.20	32.38	peak
2 5350.020	7.70	34.40	35.21	44.24	51.13	74.00	-22.87	peak
3 5358.440	7.71	34.43	35.20	45.65	52.59	74.00	-21.41	peak



Unless otherwise agreed in writing, this document is issued by the Company subject to its General Conditions of Service printed overleaf, available on request or accessible at <https://www.sgs.com/en/Terms-and-Conditions>. Attention is drawn to the limitation of liability, indemnification and jurisdiction issues defined therein. Any holder of this document is advised that information contained hereon reflects the Company's findings at the time of its intervention only and within the limits of Client's instructions, if any. The Company's sole responsibility is to its Client and this document does not exonerate parties to a transaction from exercising all their rights and obligations under the transaction documents. This document cannot be reproduced except in full, without prior written approval of the Company. Any unauthorized alteration, forgery or falsification of the content or appearance of this document is unlawful and offenders may be prosecuted to the fullest extent of the law. Unless otherwise stated the results shown in this test report refer only to the sample(s) tested and such sample(s) are retained for 30 days only.
 Attention: To check the authenticity of testing /inspection report & certificate, please contact us at telephone: (86-755) 8307 1443, or email: CN.Doccheck@sgs.com
 No.1 Workshop, M-10, Middle Section, Science & Technology Park, Nanshan District, Shenzhen, Guangdong, China 518057 t (86-755) 26012053 f (86-755) 26710594 www.sgs.com.cn
 中国·广东·深圳市南山区科技园中区M-10栋1号厂房 邮编: 518057 t (86-755) 26012053 f (86-755) 26710594 sgs.china@sgs.com

Test Mode: 21; Polarity: Horizontal; Modulation:802.11a; Bandwidth:20MHz; Channel:High

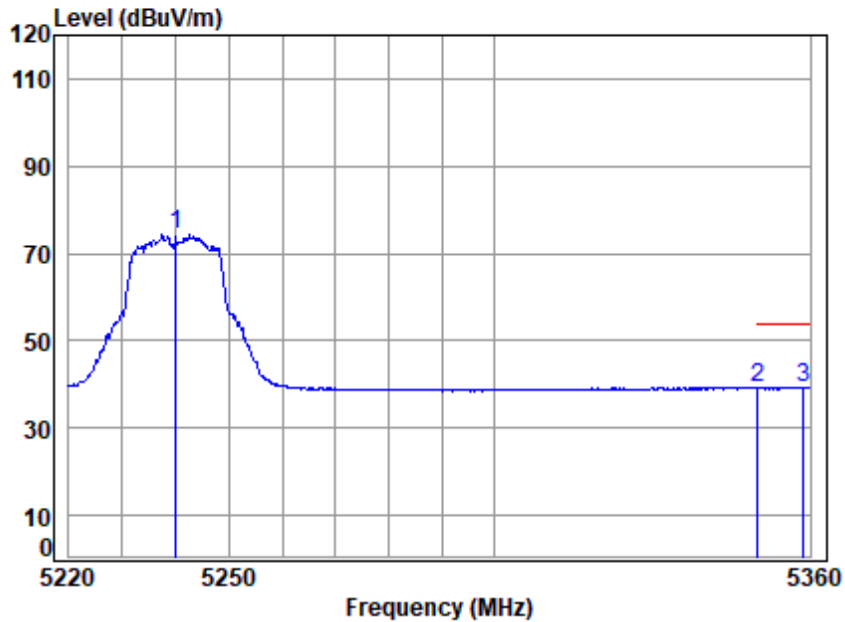

Site : chamber
 Condition: 3m HORIZONTAL
 Job No : 00955AT/00956AT
 Mode : 5240 Band edge
 : 5G WIFI 11A

	Freq	Cable Loss	Ant Factor	Preamp Factor	Read Level	Limit Level	Limit Line	Over Limit	Remark
	MHz	dB	dB/m	dB	dBuV	dBuV/m	dBuV/m	dB	
1	5240.000	7.62	34.08	35.26	67.74	74.18	-----	-----	Average
2	5350.020	7.70	34.40	35.21	32.27	39.16	54.00	-14.84	Average
3 q	5358.724	7.71	34.43	35.20	32.50	39.44	54.00	-14.56	Average



Unless otherwise agreed in writing, this document is issued by the Company subject to its General Conditions of Service printed overleaf, available on request or accessible at <https://www.sgs.com/en/Terms-and-Conditions>. Attention is drawn to the limitation of liability, indemnification and jurisdiction issues defined therein. Any holder of this document is advised that information contained hereon reflects the Company's findings at the time of its intervention only and within the limits of Client's instructions, if any. The Company's sole responsibility is to its Client and this document does not exonerate parties to a transaction from exercising all their rights and obligations under the transaction documents. This document cannot be reproduced except in full, without prior written approval of the Company. Any unauthorized alteration, forgery or falsification of the content or appearance of this document is unlawful and offenders may be prosecuted to the fullest extent of the law. Unless otherwise stated the results shown in this test report refer only to the sample(s) tested and such sample(s) are retained for 30 days only.
 Attention: To check the authenticity of testing /inspection report & certificate, please contact us at telephone: (86-755) 8307 1443, or email: CN.Doccheck@sgs.com
 No.1 Workshop, M-10, Middle Section, Science & Technology Park, Nanshan District, Shenzhen, Guangdong, China 518057 t (86-755) 26012053 f (86-755) 26710594 www.sgs.com.cn
 中国·广东·深圳市南山区科技园中区M-10栋1号厂房 邮编: 518057 t (86-755) 26012053 f (86-755) 26710594 sgs.china@sgs.com

Test Mode: 21; Polarity: Vertical; Modulation:802.11a; Bandwidth:20MHz; Channel:High

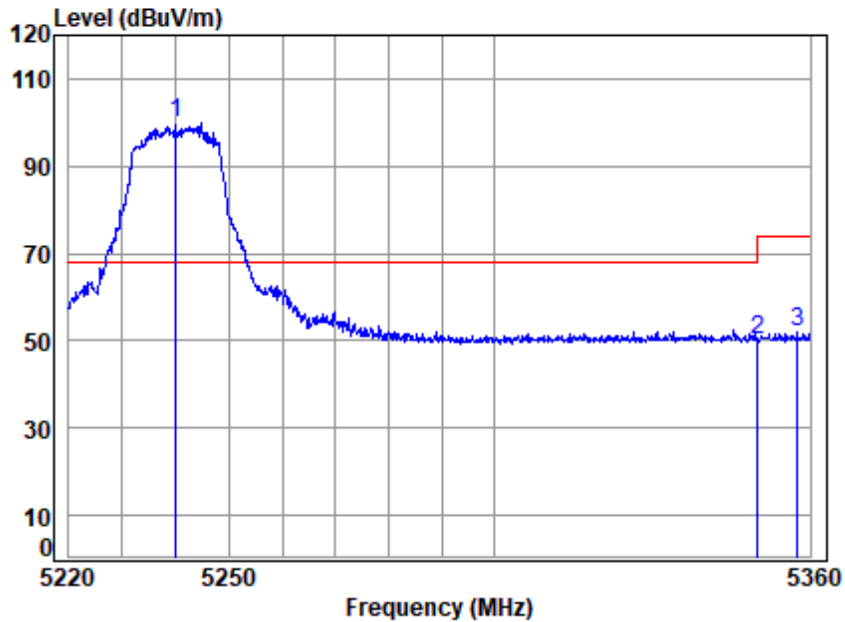

Site : chamber
 Condition: 3m VERTICAL
 Job No : 00955AT/00956AT
 Mode : 5240 Band edge
 : 5G WIFI 11A

	Freq	Cable Loss	Ant Factor	Preamp Factor	Read Level	Limit Level	Over Limit	Remark
	MHz	dB	dB/m	dB	dBuV	dBuV/m	dBuV/m	dB
1 p	5240.000	7.62	34.08	35.26	93.41	68.20	31.65	Peak
2	5350.020	7.70	34.40	35.21	43.34	74.00	-23.77	Peak
3	5357.589	7.71	34.43	35.20	45.00	74.00	-22.06	Peak



Unless otherwise agreed in writing, this document is issued by the Company subject to its General Conditions of Service printed overleaf, available on request or accessible at <https://www.sgs.com/en/Terms-and-Conditions>. Attention is drawn to the limitation of liability, indemnification and jurisdiction issues defined therein. Any holder of this document is advised that information contained hereon reflects the Company's findings at the time of its intervention only and within the limits of Client's instructions, if any. The Company's sole responsibility is to its Client and this document does not exonerate parties to a transaction from exercising all their rights and obligations under the transaction documents. This document cannot be reproduced except in full, without prior written approval of the Company. Any unauthorized alteration, forgery or falsification of the content or appearance of this document is unlawful and offenders may be prosecuted to the fullest extent of the law. Unless otherwise stated the results shown in this test report refer only to the sample(s) tested and such sample(s) are retained for 30 days only.
 Attention: To check the authenticity of testing /inspection report & certificate, please contact us at telephone: (86-755) 8307 1443, or email: CN.Doccheck@sgs.com
 No.1 Workshop, M-10, Middle Section, Science & Technology Park, Nanshan District, Shenzhen, Guangdong, China 518057 t (86-755) 26012053 f (86-755) 26710594 www.sgs.com.cn
 中国·广东·深圳市南山区科技园中区M-10栋1号厂房 邮编: 518057 t (86-755) 26012053 f (86-755) 26710594 sgs.china@sgs.com

Test Mode: 21; Polarity: Vertical; Modulation:802.11a; Bandwidth:20MHz; Channel:High

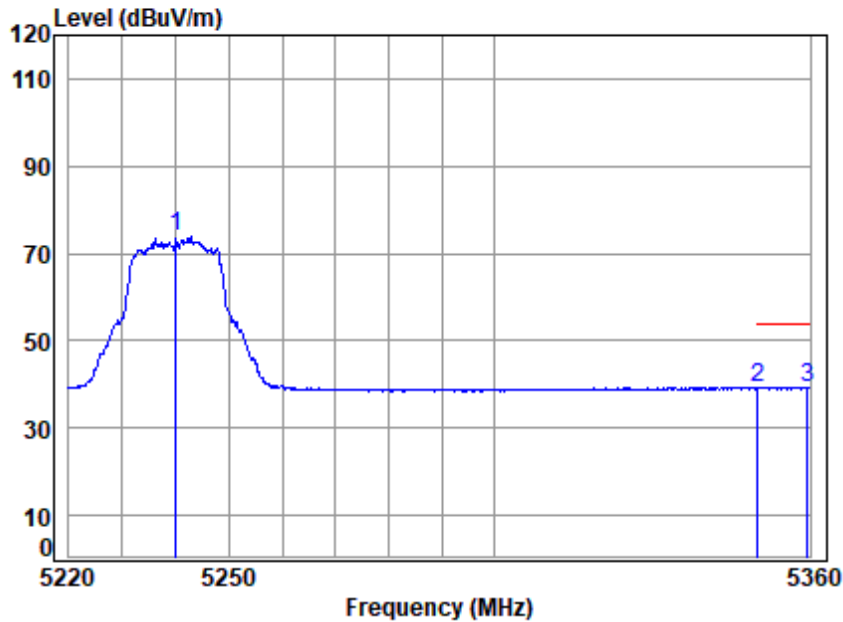

Site : chamber
 Condition: 3m VERTICAL
 Job No : 00955AT/00956AT
 Mode : 5240 Band edge
 : 5G WIFI 11A

	Freq	Cable Loss	Ant Factor	Preamp Factor	Read Level	Limit Level	Over Line	Over Limit	Remark
	MHz	dB	dB/m	dB	dBuV	dBuV/m	dBuV/m	dB	
1	5240.000	7.62	34.08	35.26	67.60	74.04	-----	-----	Average
2	5350.020	7.70	34.40	35.21	32.36	39.25	54.00	-14.75	Average
3 q	5359.433	7.71	34.44	35.20	32.39	39.34	54.00	-14.66	Average



Test Mode: 21; Polarity: Horizontal; Modulation:802.11ac; Bandwidth:20MHz; Channel:Low

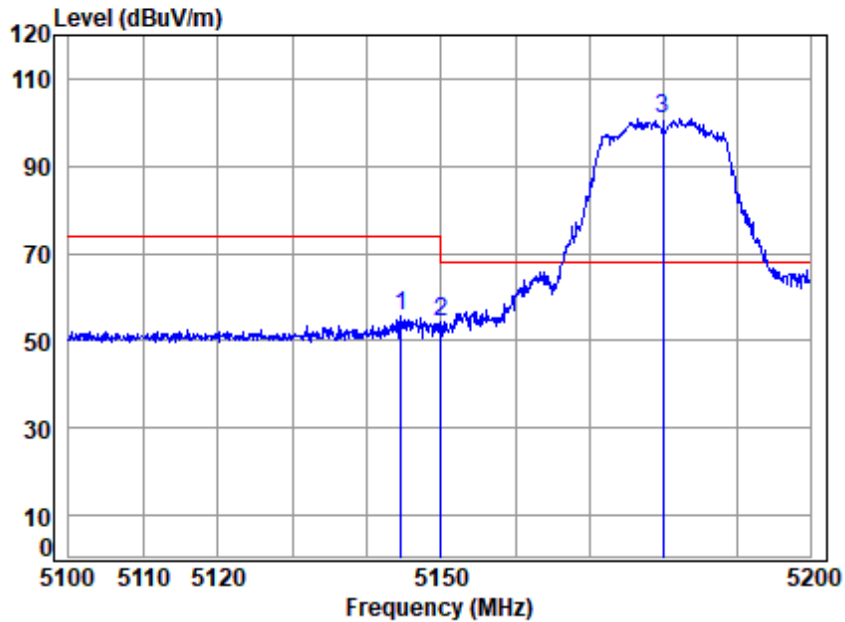

Site : chamber
 Condition: 3m HORIZONTAL
 Job No : 00955AT/00956AT
 Mode : 5180 Band edge
 : 5G WIFI 11AC20

	Cable	Ant	Preamp	Read	Limit	Over		
Freq	Loss	Factor	Factor	Level	Level	Line	Limit	Remark
MHz	dB	dB/m	dB	dBuV	dBuV/m	dBuV/m	dB	
1	5144.560	7.55	33.91	35.31	49.46	55.61	74.00	-18.39 peak
2	5149.980	7.55	33.90	35.31	48.15	54.29	74.00	-19.71 peak
3 p	5180.000	7.57	33.96	35.29	94.48	100.72	68.20	32.52 peak



Unless otherwise agreed in writing, this document is issued by the Company subject to its General Conditions of Service printed overleaf, available on request or accessible at <https://www.sgs.com/en/Terms-and-Conditions>. Attention is drawn to the limitation of liability, indemnification and jurisdiction issues defined therein. Any holder of this document is advised that information contained hereon reflects the Company's findings at the time of its intervention only and within the limits of Client's instructions, if any. The Company's sole responsibility is to its Client and this document does not exonerate parties to a transaction from exercising all their rights and obligations under the transaction documents. This document cannot be reproduced except in full, without prior written approval of the Company. Any unauthorized alteration, forgery or falsification of the content or appearance of this document is unlawful and offenders may be prosecuted to the fullest extent of the law. Unless otherwise stated the results shown in this test report refer only to the sample(s) tested and such sample(s) are retained for 30 days only.

Test Mode: 21; Polarity: Horizontal; Modulation:802.11ac; Bandwidth:20MHz; Channel:Low

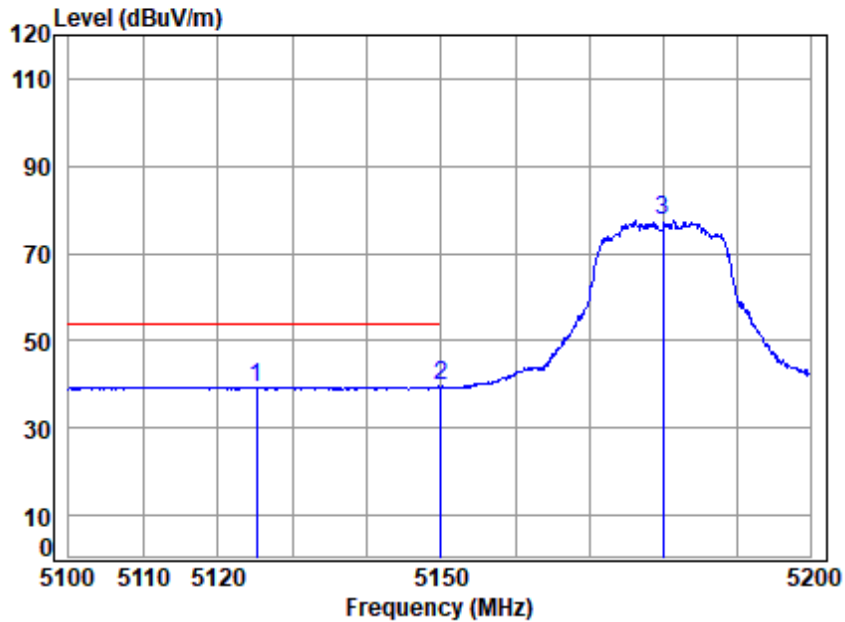

Site : chamber
 Condition: 3m HORIZONTAL
 Job No : 00955AT/00956AT
 Mode : 5180 Band edge
 : 5G WIFI 11AC20

	Cable	Ant	Preamp	Read	Limit	Over		
Freq	Loss	Factor	Factor	Level	Level	Line	Limit	Remark
MHz	dB	dB/m	dB	dBuV	dBuV/m	dBuV/m	dB	
1	5125.216	7.53	33.95	35.32	33.26	39.42	54.00	-14.58 Average
2	5149.980	7.55	33.90	35.31	33.35	39.49	54.00	-14.51 Average
3	5180.000	7.57	33.96	35.29	71.24	77.48	-----	----- Average



Unless otherwise agreed in writing, this document is issued by the Company subject to its General Conditions of Service printed overleaf, available on request or accessible at <https://www.sgs.com/en/Terms-and-Conditions>. Attention is drawn to the limitation of liability, indemnification and jurisdiction issues defined therein. Any holder of this document is advised that information contained hereon reflects the Company's findings at the time of its intervention only and within the limits of Client's instructions, if any. The Company's sole responsibility is to its Client and this document does not exonerate parties to a transaction from exercising all their rights and obligations under the transaction documents. This document cannot be reproduced except in full, without prior written approval of the Company. Any unauthorized alteration, forgery or falsification of the content or appearance of this document is unlawful and offenders may be prosecuted to the fullest extent of the law. Unless otherwise stated the results shown in this test report refer only to the sample(s) tested and such sample(s) are retained for 30 days only.

Test Mode: 21; Polarity: Vertical; Modulation:802.11ac; Bandwidth:20MHz; Channel:Low

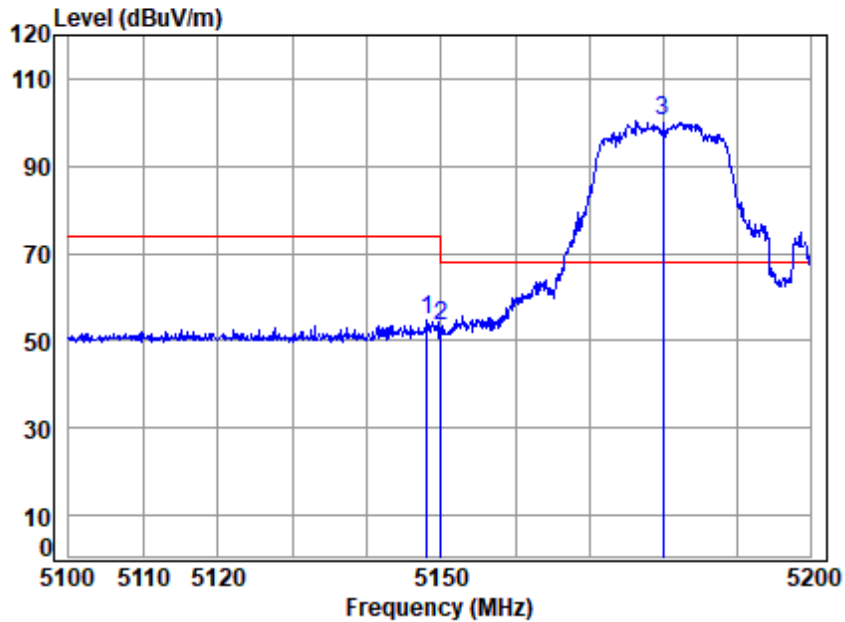

Site : chamber
 Condition: 3m VERTICAL
 Job No : 00955AT/00956AT
 Mode : 5180 Band edge
 : 5G WIFI 11AC20

	Freq	Cable Loss	Ant Factor	Preamp Factor	Read Level	Level	Limit Line	Over Limit	Remark
	MHz	dB	dB/m	dB	dBuV	dBuV/m	dBuV/m	dB	
1	5148.058	7.55	33.90	35.31	48.64	54.78	74.00	-19.22	Peak
2	5149.980	7.55	33.90	35.31	47.15	53.29	74.00	-20.71	Peak
3 p	5180.000	7.57	33.96	35.29	93.96	100.20	68.20	32.00	Peak



Unless otherwise agreed in writing, this document is issued by the Company subject to its General Conditions of Service printed overleaf, available on request or accessible at <https://www.sgs.com/en/Terms-and-Conditions>. Attention is drawn to the limitation of liability, indemnification and jurisdiction issues defined therein. Any holder of this document is advised that information contained hereon reflects the Company's findings at the time of its intervention only and within the limits of Client's instructions, if any. The Company's sole responsibility is to its Client and this document does not exonerate parties to a transaction from exercising all their rights and obligations under the transaction documents. This document cannot be reproduced except in full, without prior written approval of the Company. Any unauthorized alteration, forgery or falsification of the content or appearance of this document is unlawful and offenders may be prosecuted to the fullest extent of the law. Unless otherwise stated the results shown in this test report refer only to the sample(s) tested and such sample(s) are retained for 30 days only.

Test Mode: 21; Polarity: Vertical; Modulation:802.11ac; Bandwidth:20MHz; Channel:Low

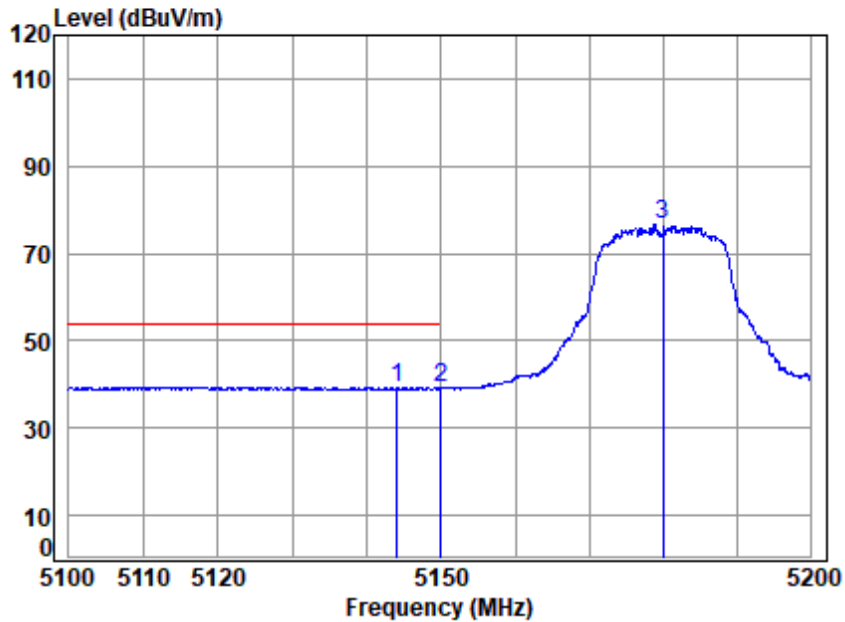

Site : chamber
 Condition: 3m VERTICAL
 Job No : 00955AT/00956AT
 Mode : 5180 Band edge
 : 5G WIFI 11AC20

	Cable	Ant	Preamp	Read	Limit	Over		
Freq	Loss	Factor	Factor	Level	Level	Line	Limit	Remark
MHz	dB	dB/m	dB	dBuV	dBuV/m	dBuV/m	dB	
1 q 5144.061	7.55	33.91	35.31	33.20	39.35	54.00	-14.65	Average
2 5149.980	7.55	33.90	35.31	33.07	39.21	54.00	-14.79	Average
3 5180.000	7.57	33.96	35.29	70.31	76.55	-----	-----	Average



Unless otherwise agreed in writing, this document is issued by the Company subject to its General Conditions of Service printed overleaf, available on request or accessible at <https://www.sgs.com/en/Terms-and-Conditions>. Attention is drawn to the limitation of liability, indemnification and jurisdiction issues defined therein. Any holder of this document is advised that information contained hereon reflects the Company's findings at the time of its intervention only and within the limits of Client's instructions, if any. The Company's sole responsibility is to its Client and this document does not exonerate parties to a transaction from exercising all their rights and obligations under the transaction documents. This document cannot be reproduced except in full, without prior written approval of the Company. Any unauthorized alteration, forgery or falsification of the content or appearance of this document is unlawful and offenders may be prosecuted to the fullest extent of the law. Unless otherwise stated the results shown in this test report refer only to the sample(s) tested and such sample(s) are retained for 30 days only.
 Attention: To check the authenticity of testing /inspection report & certificate, please contact us at telephone: (86-755) 8307 1443, or email: CN.Doccheck@sgs.com
 No.1 Workshop, M-10, Middle Section, Science & Technology Park, Nanshan District, Shenzhen, Guangdong, China 518057 t (86-755) 26012053 f (86-755) 26710594 www.sgsgroup.com.cn
 中国·广东·深圳市南山区科技园中区M-10栋1号厂房 邮编: 518057 t (86-755) 26012053 f (86-755) 26710594 sgs.china@sgs.com

Test Mode: 21; Polarity: Horizontal; Modulation:802.11ac; Bandwidth:20MHz; Channel:High

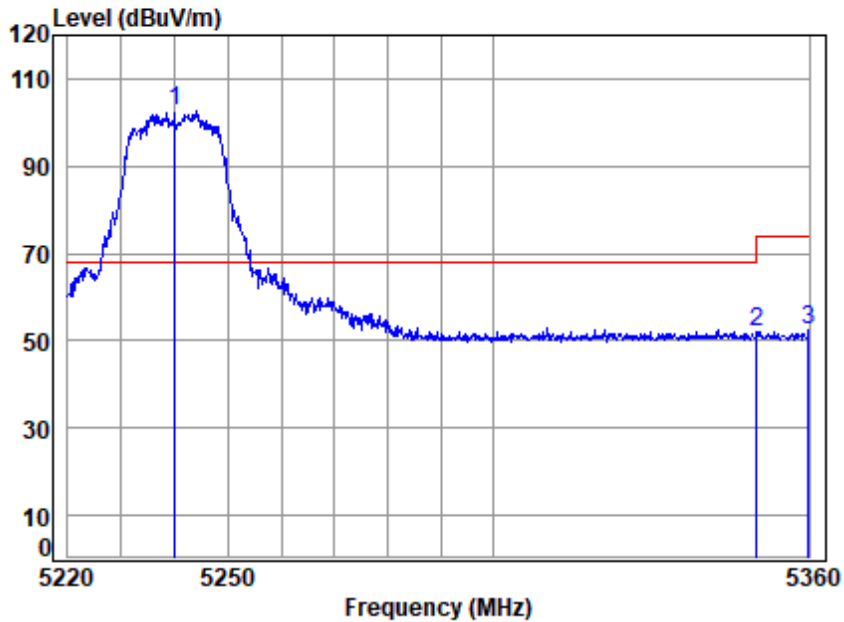

Site : chamber
 Condition: 3m HORIZONTAL
 Job No : 00955AT/00956AT
 Mode : 5240 Band edge
 : 5G WIFI 11AC20

	Cable	Ant	Preamp	Read	Limit	Over		
Freq	Loss	Factor	Factor	Level	Level	Line	Limit	Remark
MHz	dB	dB/m	dB	dBuV	dBuV/m	dBuV/m	dB	
1 p 5240.000	7.62	34.08	35.26	96.42	102.86	68.20	34.66	peak
2 5350.020	7.70	34.40	35.21	45.12	52.01	74.00	-21.99	peak
3 5359.858	7.71	34.44	35.20	45.30	52.25	74.00	-21.75	peak



Unless otherwise agreed in writing, this document is issued by the Company subject to its General Conditions of Service printed overleaf, available on request or accessible at <https://www.sgs.com/en/Terms-and-Conditions>. Attention is drawn to the limitation of liability, indemnification and jurisdiction issues defined therein. Any holder of this document is advised that information contained hereon reflects the Company's findings at the time of its intervention only and within the limits of Client's instructions, if any. The Company's sole responsibility is to its Client and this document does not exonerate parties to a transaction from exercising all their rights and obligations under the transaction documents. This document cannot be reproduced except in full, without prior written approval of the Company. Any unauthorized alteration, forgery or falsification of the content or appearance of this document is unlawful and offenders may be prosecuted to the fullest extent of the law. Unless otherwise stated the results shown in this test report refer only to the sample(s) tested and such sample(s) are retained for 30 days only.
 Attention: To check the authenticity of testing /inspection report & certificate, please contact us at telephone: (86-755) 8307 1443, or email: CN.Doccheck@sgs.com
 No.1 Workshop, M-10, Middle Section, Science & Technology Park, Nanshan District, Shenzhen, Guangdong, China 518057 t (86-755) 26012053 f (86-755) 26710594 www.sgs.com.cn
 中国·广东·深圳市南山区科技园中区M-10栋1号厂房 邮编: 518057 t (86-755) 26012053 f (86-755) 26710594 sgs.china@sgs.com

Test Mode: 21; Polarity: Horizontal; Modulation:802.11ac; Bandwidth:20MHz; Channel:High

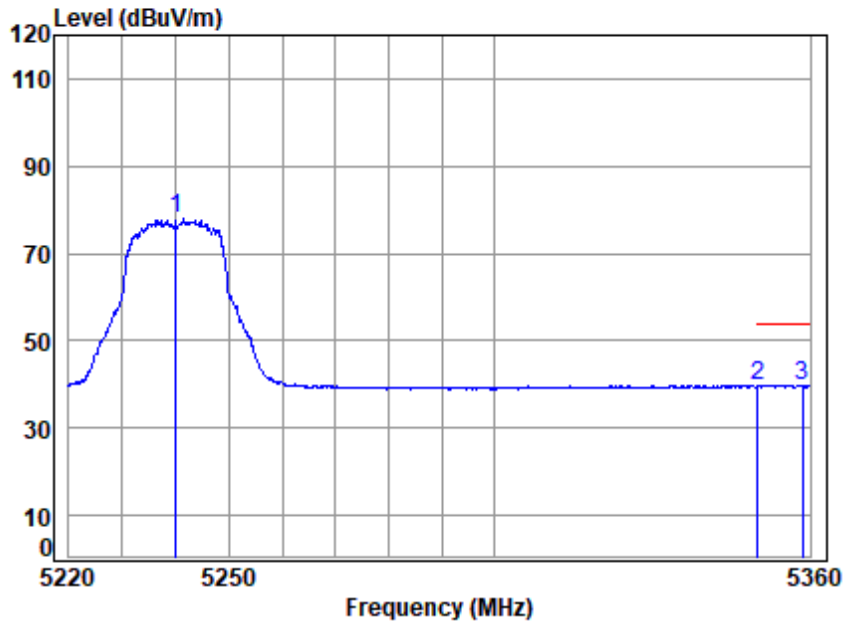

Site : chamber
 Condition: 3m HORIZONTAL
 Job No : 00955AT/00956AT
 Mode : 5240 Band edge
 : 5G WIFI 11AC20

	Freq	Cable Loss	Ant Factor	Preamp Factor	Read Level	Limit Level	Limit Line	Over Limit	Remark
	MHz	dB	dB/m	dB	dBuV	dBuV/m	dBuV/m	dB	
1	5240.000	7.62	34.08	35.26	71.73	78.17	-----	-----	Average
2	5350.020	7.70	34.40	35.21	32.67	39.56	54.00	-14.44	Average
3 q	5358.582	7.71	34.43	35.20	32.90	39.84	54.00	-14.16	Average



Unless otherwise agreed in writing, this document is issued by the Company subject to its General Conditions of Service printed overleaf, available on request or accessible at <https://www.sgs.com/en/Terms-and-Conditions>. Attention is drawn to the limitation of liability, indemnification and jurisdiction issues defined therein. Any holder of this document is advised that information contained hereon reflects the Company's findings at the time of its intervention only and within the limits of Client's instructions, if any. The Company's sole responsibility is to its Client and this document does not exonerate parties to a transaction from exercising all their rights and obligations under the transaction documents. This document cannot be reproduced except in full, without prior written approval of the Company. Any unauthorized alteration, forgery or falsification of the content or appearance of this document is unlawful and offenders may be prosecuted to the fullest extent of the law. Unless otherwise stated the results shown in this test report refer only to the sample(s) tested and such sample(s) are retained for 30 days only.

Test Mode: 21; Polarity: Vertical; Modulation:802.11ac; Bandwidth:20MHz; Channel:High

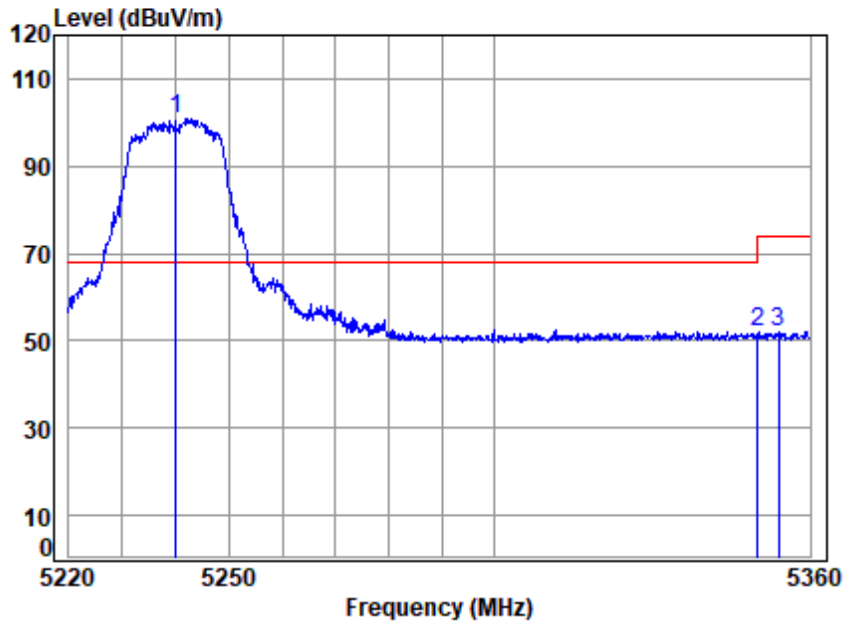

Site : chamber
 Condition: 3m VERTICAL
 Job No : 00955AT/00956AT
 Mode : 5240 Band edge
 : 5G WIFI 11AC20

	Cable	Ant	Preamp	Read	Limit	Over	
Freq	Loss	Factor	Factor	Level	Level	Line	Limit Remark
MHz	dB	dB/m	dB	dBuV	dBuV/m	dBuV/m	dB
1 p 5240.000	7.62	34.08	35.26	94.37	100.81	68.20	32.61 Peak
2 5350.020	7.70	34.40	35.21	44.99	51.88	74.00	-22.12 Peak
3 5353.903	7.71	34.42	35.21	45.11	52.03	74.00	-21.97 Peak



Unless otherwise agreed in writing, this document is issued by the Company subject to its General Conditions of Service printed overleaf, available on request or accessible at <https://www.sgs.com/en/Terms-and-Conditions>. Attention is drawn to the limitation of liability, indemnification and jurisdiction issues defined therein. Any holder of this document is advised that information contained hereon reflects the Company's findings at the time of its intervention only and within the limits of Client's instructions, if any. The Company's sole responsibility is to its Client and this document does not exonerate parties to a transaction from exercising all their rights and obligations under the transaction documents. This document cannot be reproduced except in full, without prior written approval of the Company. Any unauthorized alteration, forgery or falsification of the content or appearance of this document is unlawful and offenders may be prosecuted to the fullest extent of the law. Unless otherwise stated the results shown in this test report refer only to the sample(s) tested and such sample(s) are retained for 30 days only.
 Attention: To check the authenticity of testing /inspection report & certificate, please contact us at telephone: (86-755) 8307 1443, or email: CN.Doccheck@sgs.com
 No.1 Workshop, M-10, Middle Section, Science & Technology Park, Nanshan District, Shenzhen, Guangdong, China 518057 t (86-755) 26012053 f (86-755) 26710594 www.sgs.com.cn
 中国·广东·深圳市南山区科技园中区M-10栋1号厂房 邮编: 518057 t (86-755) 26012053 f (86-755) 26710594 sgs.china@sgs.com

Test Mode: 21; Polarity: Vertical; Modulation:802.11ac; Bandwidth:20MHz; Channel:High

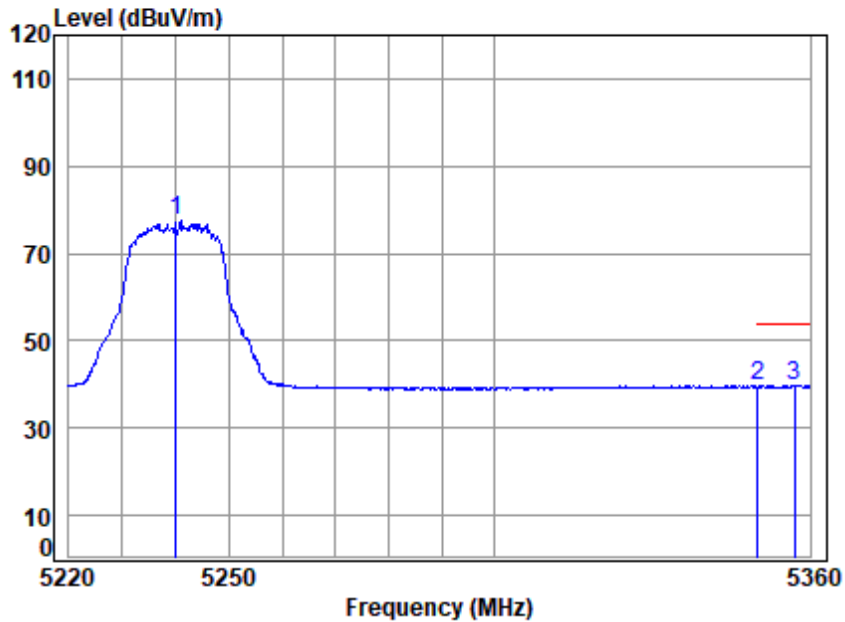

Site : chamber
 Condition: 3m VERTICAL
 Job No : 00955AT/00956AT
 Mode : 5240 Band edge
 : 5G WIFI 11AC20

	Freq	Cable Loss	Ant Factor	Preamp Factor	Read Level	Limit Level	Over Line	Over Limit	Remark
	MHz	dB	dB/m	dB	dBuV	dBuV/m	dBuV/m	dB	
1	5240.000	7.62	34.08	35.26	70.95	77.39	-----	-----	Average
2	5350.020	7.70	34.40	35.21	32.65	39.54	54.00	-14.46	Average
3 q	5357.022	7.71	34.43	35.20	32.76	39.70	54.00	-14.30	Average



Unless otherwise agreed in writing, this document is issued by the Company subject to its General Conditions of Service printed overleaf, available on request or accessible at <https://www.sgs.com/en/Terms-and-Conditions>. Attention is drawn to the limitation of liability, indemnification and jurisdiction issues defined therein. Any holder of this document is advised that information contained hereon reflects the Company's findings at the time of its intervention only and within the limits of Client's instructions, if any. The Company's sole responsibility is to its Client and this document does not exonerate parties to a transaction from exercising all their rights and obligations under the transaction documents. This document cannot be reproduced except in full, without prior written approval of the Company. Any unauthorized alteration, forgery or falsification of the content or appearance of this document is unlawful and offenders may be prosecuted to the fullest extent of the law. Unless otherwise stated the results shown in this test report refer only to the sample(s) tested and such sample(s) are retained for 30 days only.

Test Mode: 21; Polarity: Horizontal; Modulation:802.11ac; Bandwidth:40MHz; Channel:Low

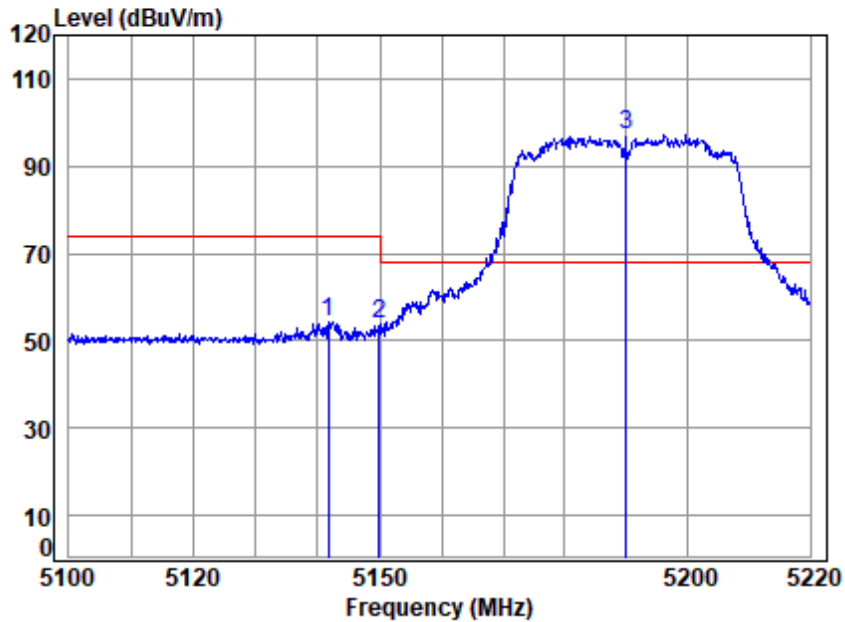

Site : chamber
 Condition: 3m HORIZONTAL
 Job No : 00955AT/00956AT
 Mode : 5190 Band edge
 : 5G WIFI 11AC40

	Cable	Ant	Preamp	Read	Limit	Over		
Freq	Loss	Factor	Factor	Level	Level	Line	Limit	Remark
MHz	dB	dB/m	dB	dBuV	dBuV/m	dBuV/m	dB	
1	7.54	33.92	35.31	48.28	54.43	74.00	-19.57	peak
2	7.55	33.90	35.31	47.71	53.85	74.00	-20.15	peak
3 p	7.58	33.98	35.29	90.87	97.14	68.20	28.94	peak



Unless otherwise agreed in writing, this document is issued by the Company subject to its General Conditions of Service printed overleaf, available on request or accessible at <https://www.sgs.com/en/Terms-and-Conditions>. Attention is drawn to the limitation of liability, indemnification and jurisdiction issues defined therein. Any holder of this document is advised that information contained hereon reflects the Company's findings at the time of its intervention only and within the limits of Client's instructions, if any. The Company's sole responsibility is to its Client and this document does not exonerate parties to a transaction from exercising all their rights and obligations under the transaction documents. This document cannot be reproduced except in full, without prior written approval of the Company. Any unauthorized alteration, forgery or falsification of the content or appearance of this document is unlawful and offenders may be prosecuted to the fullest extent of the law. Unless otherwise stated the results shown in this test report refer only to the sample(s) tested and such sample(s) are retained for 30 days only.

Test Mode: 21; Polarity: Horizontal; Modulation:802.11ac; Bandwidth:40MHz; Channel:Low

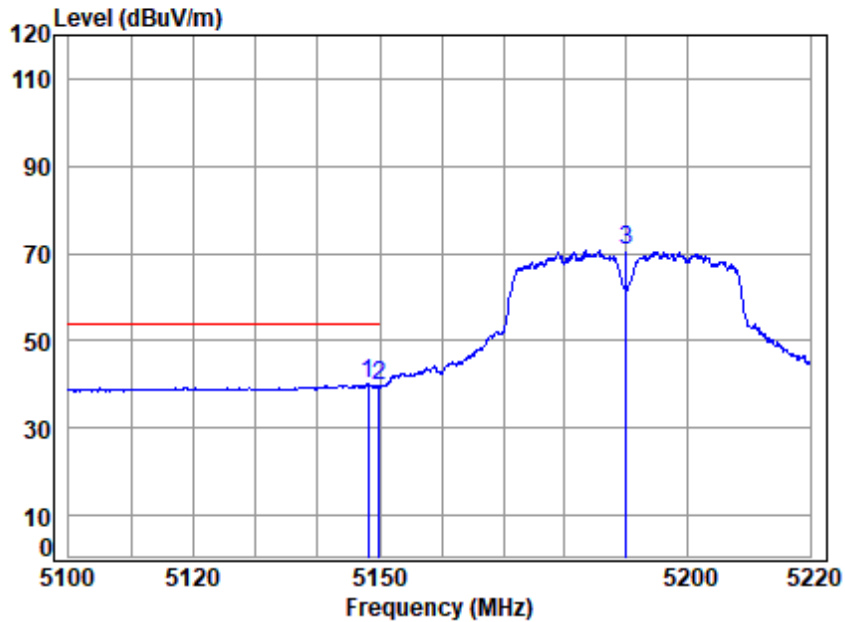

Site : chamber
 Condition: 3m HORIZONTAL
 Job No : 00955AT/00956AT
 Mode : 5190 Band edge
 : 5G WIFI 11AC40

		Cable	Ant	Preamp	Read	Limit	Over	
Freq	Loss	Factor	Factor	Factor	Level	Level	Line	Limit Remark
MHz	dB	dB/m	dB	dBuV	dBuV/m	dBuV/m	dB	
1 q 5148.144	7.55	33.90	35.31	33.84	39.98	54.00	-14.02	Average
2 5149.980	7.55	33.90	35.31	33.62	39.76	54.00	-14.24	Average
3 5190.000	7.58	33.98	35.29	64.47	70.74	-----	-----	Average



Unless otherwise agreed in writing, this document is issued by the Company subject to its General Conditions of Service printed overleaf, available on request or accessible at <https://www.sgs.com/en/Terms-and-Conditions>. Attention is drawn to the limitation of liability, indemnification and jurisdiction issues defined therein. Any holder of this document is advised that information contained hereon reflects the Company's findings at the time of its intervention only and within the limits of Client's instructions, if any. The Company's sole responsibility is to its Client and this document does not exonerate parties to a transaction from exercising all their rights and obligations under the transaction documents. This document cannot be reproduced except in full, without prior written approval of the Company. Any unauthorized alteration, forgery or falsification of the content or appearance of this document is unlawful and offenders may be prosecuted to the fullest extent of the law. Unless otherwise stated the results shown in this test report refer only to the sample(s) tested and such sample(s) are retained for 30 days only.

Attention: To check the authenticity of testing /inspection report & certificate, please contact us at telephone: (86-755) 8307 1443, or email: CN.Doccheck@sgs.com
 No.1 Workshop, M-10, Middle Section, Science & Technology Park, Nanshan District, Shenzhen, Guangdong, China 518057 t (86-755) 26012053 f (86-755) 26710594 www.sgsgroup.com.cn
 中国·广东·深圳市南山区科技园中区M-10栋1号厂房 邮编: 518057 t (86-755) 26012053 f (86-755) 26710594 sgs.china@sgs.com

Test Mode: 21; Polarity: Vertical; Modulation:802.11ac; Bandwidth:40MHz; Channel:Low

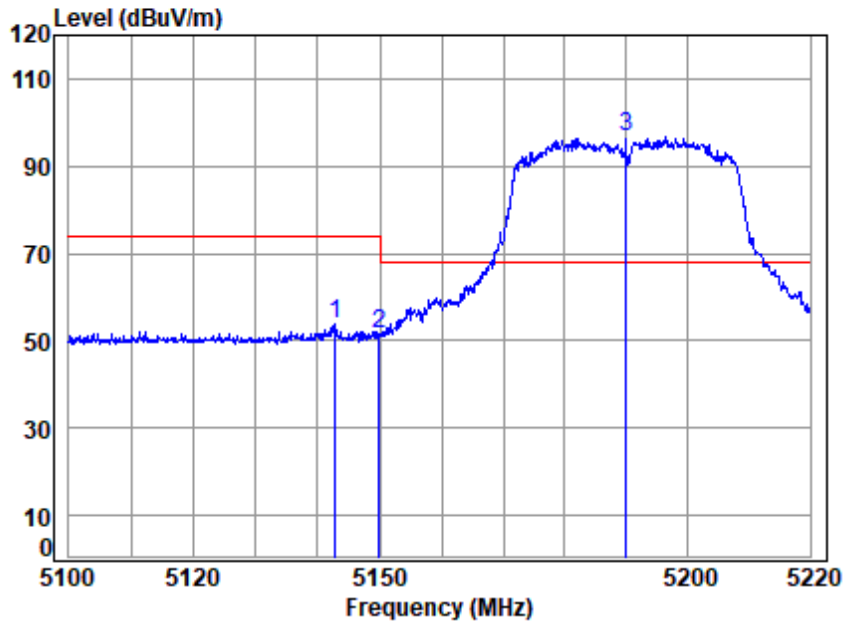

Site : chamber
 Condition: 3m VERTICAL
 Job No : 00955AT/00956AT
 Mode : 5190 Band edge
 : 5G WIFI 11AC40

	Cable	Ant	Preamp	Read	Limit	Over		
Freq	Loss	Factor	Factor	Level	Level	Line	Limit	Remark
MHz	dB	dB/m	dB	dBuV	dBuV/m	dBuV/m	dB	
1	7.54	33.91	35.31	47.48	53.62	74.00	-20.38	Peak
2	7.55	33.90	35.31	45.63	51.77	74.00	-22.23	Peak
3 p	7.58	33.98	35.29	90.54	96.81	68.20	28.61	Peak



Test Mode: 21; Polarity: Vertical; Modulation:802.11ac; Bandwidth:40MHz; Channel:Low

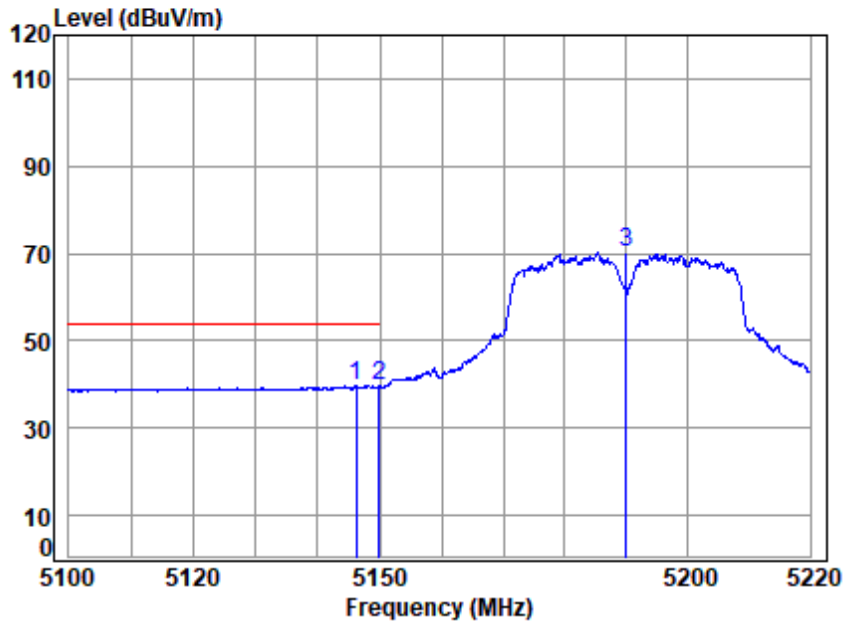

Site : chamber
 Condition: 3m VERTICAL
 Job No : 00955AT/00956AT
 Mode : 5190 Band edge
 : 5G WIFI 11AC40

		Cable	Ant	Preamp	Read	Limit	Over	
Freq	Loss	Factor	Factor	Factor	Level	Line	Limit	Remark
MHz	dB	dB/m	dB	dB	dBuV	dBuV/m	dB	
1 q 5146.229	7.55	33.91	35.31	33.55	39.70	54.00	-14.30	Average
2 5149.980	7.55	33.90	35.31	33.41	39.55	54.00	-14.45	Average
3 5190.000	7.58	33.98	35.29	64.05	70.32	-----	-----	Average



Unless otherwise agreed in writing, this document is issued by the Company subject to its General Conditions of Service printed overleaf, available on request or accessible at <https://www.sgs.com/en/Terms-and-Conditions>. Attention is drawn to the limitation of liability, indemnification and jurisdiction issues defined therein. Any holder of this document is advised that information contained hereon reflects the Company's findings at the time of its intervention only and within the limits of Client's instructions, if any. The Company's sole responsibility is to its Client and this document does not exonerate parties to a transaction from exercising all their rights and obligations under the transaction documents. This document cannot be reproduced except in full, without prior written approval of the Company. Any unauthorized alteration, forgery or falsification of the content or appearance of this document is unlawful and offenders may be prosecuted to the fullest extent of the law. Unless otherwise stated the results shown in this test report refer only to the sample(s) tested and such sample(s) are retained for 30 days only.

Attention: To check the authenticity of testing /inspection report & certificate, please contact us at telephone: (86-755) 8307 1443, or email: CN.Doccheck@sgs.com

Test Mode: 21; Polarity: Horizontal; Modulation:802.11ac; Bandwidth:40MHz; Channel:High

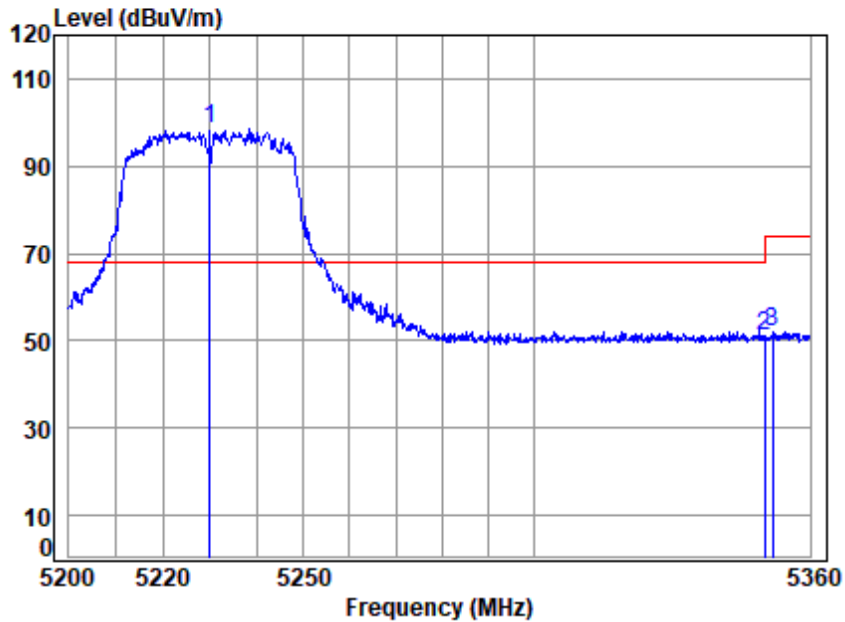

Site : chamber
 Condition: 3m HORIZONTAL
 Job No : 00955AT/00956AT
 Mode : 5230 Band edge
 : 5G WIFI 11AC40

	Cable	Ant	Preamp	Read	Limit	Over	
Freq	Loss	Factor	Factor	Level	Level	Line	Limit Remark
MHz	dB	dB/m	dB	dBuV	dBuV/m	dBuV/m	dB
1 p 5230.000	7.61	34.06	35.27	92.21	98.61	68.20	30.41 peak
2 5350.020	7.70	34.40	35.21	44.25	51.14	74.00	-22.86 peak
3 5351.722	7.71	34.41	35.21	45.03	51.94	74.00	-22.06 peak



Test Mode: 21; Polarity: Horizontal; Modulation:802.11ac; Bandwidth:40MHz; Channel:High

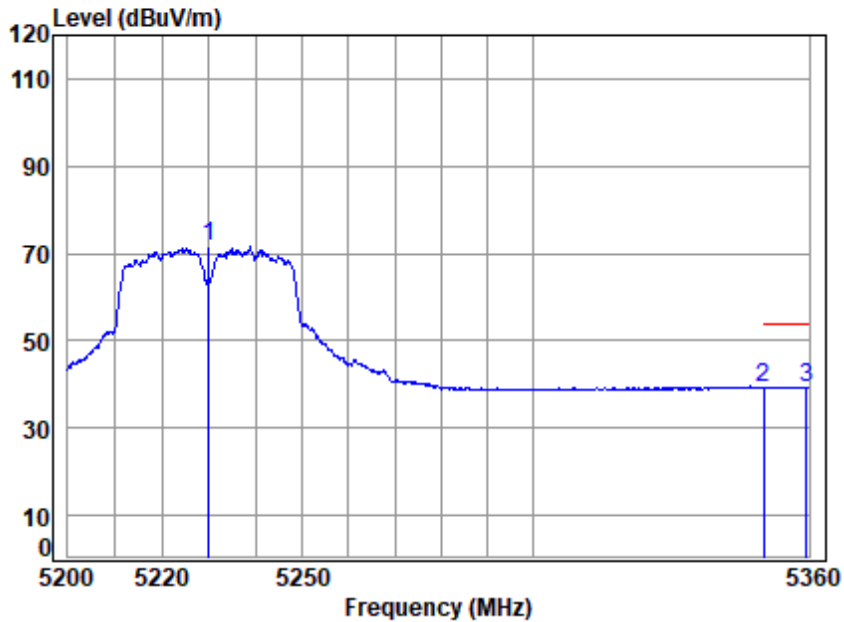

Site : chamber
 Condition: 3m HORIZONTAL
 Job No : 00955AT/00956AT
 Mode : 5230 Band edge
 : 5G WIFI 11AC40

	Cable	Ant	Preamp	Read	Limit	Over		
Freq	Loss	Factor	Factor	Level	Level	Line	Limit	
MHz	dB	dB/m	dB	dBuV	dBuV/m	dBuV/m	dB	
1	7.61	34.06	35.27	65.05	71.45	-----	-----	Average
2	7.70	34.40	35.21	32.33	39.22	54.00	-14.78	Average
3 q	7.71	34.44	35.20	32.45	39.40	54.00	-14.60	Average



Unless otherwise agreed in writing, this document is issued by the Company subject to its General Conditions of Service printed overleaf, available on request or accessible at <https://www.sgs.com/en/Terms-and-Conditions>. Attention is drawn to the limitation of liability, indemnification and jurisdiction issues defined therein. Any holder of this document is advised that information contained hereon reflects the Company's findings at the time of its intervention only and within the limits of Client's instructions, if any. The Company's sole responsibility is to its Client and this document does not exonerate parties to a transaction from exercising all their rights and obligations under the transaction documents. This document cannot be reproduced except in full, without prior written approval of the Company. Any unauthorized alteration, forgery or falsification of the content or appearance of this document is unlawful and offenders may be prosecuted to the fullest extent of the law. Unless otherwise stated the results shown in this test report refer only to the sample(s) tested and such sample(s) are retained for 30 days only.

Test Mode: 21; Polarity: Vertical; Modulation:802.11ac; Bandwidth:40MHz; Channel:High

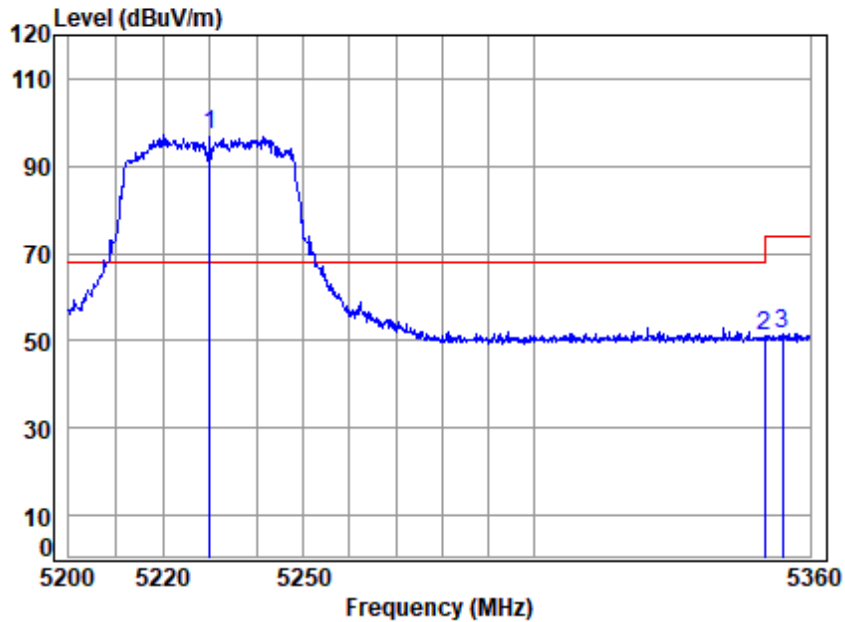

Site : chamber
 Condition: 3m VERTICAL
 Job No : 00955AT/00956AT
 Mode : 5230 Band edge
 : 5G WIFI 11AC40

	Cable	Ant	Preamp	Read	Limit	Over		
Freq	Loss	Factor	Factor	Level	Level	Line	Limit	Remark
MHz	dB	dB/m	dB	dBuV	dBuV/m	dBuV/m	dB	
1 p 5230.000	7.61	34.06	35.27	90.64	97.04	68.20	28.84	Peak
2 5350.020	7.70	34.40	35.21	44.09	50.98	74.00	-23.02	Peak
3 5353.993	7.71	34.42	35.21	44.73	51.65	74.00	-22.35	Peak



Unless otherwise agreed in writing, this document is issued by the Company subject to its General Conditions of Service printed overleaf, available on request or accessible at <https://www.sgs.com/en/Terms-and-Conditions>. Attention is drawn to the limitation of liability, indemnification and jurisdiction issues defined therein. Any holder of this document is advised that information contained hereon reflects the Company's findings at the time of its intervention only and within the limits of Client's instructions, if any. The Company's sole responsibility is to its Client and this document does not exonerate parties to a transaction from exercising all their rights and obligations under the transaction documents. This document cannot be reproduced except in full, without prior written approval of the Company. Any unauthorized alteration, forgery or falsification of the content or appearance of this document is unlawful and offenders may be prosecuted to the fullest extent of the law. Unless otherwise stated the results shown in this test report refer only to the sample(s) tested and such sample(s) are retained for 30 days only.
 Attention: To check the authenticity of testing /inspection report & certificate, please contact us at telephone: (86-755) 8307 1443, or email: CN.Doccheck@sgs.com
 No.1 Workshop, M-10, Middle Section, Science & Technology Park, Nanshan District, Shenzhen, Guangdong, China 518057 t (86-755) 26012053 f (86-755) 26710594 www.sgs.com.cn
 中国·广东·深圳市南山区科技园中区M-10栋1号厂房 邮编: 518057 t (86-755) 26012053 f (86-755) 26710594 sgs.china@sgs.com

Test Mode: 21; Polarity: Vertical; Modulation:802.11ac; Bandwidth:40MHz; Channel:High

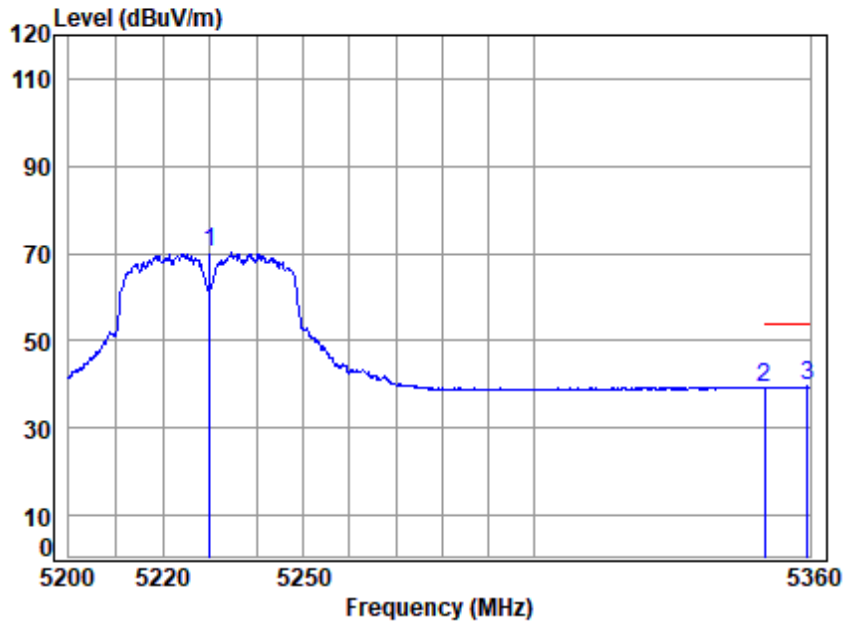

Site : chamber
 Condition: 3m VERTICAL
 Job No : 00955AT/00956AT
 Mode : 5230 Band edge
 : 5G WIFI 11AC40

	Freq	Cable Loss	Ant Factor	Preamp Factor	Read Level	Limit Level	Over Line	Over Limit	Remark
	MHz	dB	dB/m	dB	dBuV	dBuV/m	dBuV/m	dB	
1	5230.000	7.61	34.06	35.27	63.73	70.13	-----	-----	Average
2	5350.020	7.70	34.40	35.21	32.32	39.21	54.00	-14.79	Average
3 q	5359.513	7.71	34.44	35.20	32.54	39.49	54.00	-14.51	Average



Unless otherwise agreed in writing, this document is issued by the Company subject to its General Conditions of Service printed overleaf, available on request or accessible at <https://www.sgs.com/en/Terms-and-Conditions>. Attention is drawn to the limitation of liability, indemnification and jurisdiction issues defined therein. Any holder of this document is advised that information contained hereon reflects the Company's findings at the time of its intervention only and within the limits of Client's instructions, if any. The Company's sole responsibility is to its Client and this document does not exonerate parties to a transaction from exercising all their rights and obligations under the transaction documents. This document cannot be reproduced except in full, without prior written approval of the Company. Any unauthorized alteration, forgery or falsification of the content or appearance of this document is unlawful and offenders may be prosecuted to the fullest extent of the law. Unless otherwise stated the results shown in this test report refer only to the sample(s) tested and such sample(s) are retained for 30 days only.

Test Mode: 21; Polarity: Horizontal; Modulation:802.11ac; Bandwidth:80MHz; Channel:middle

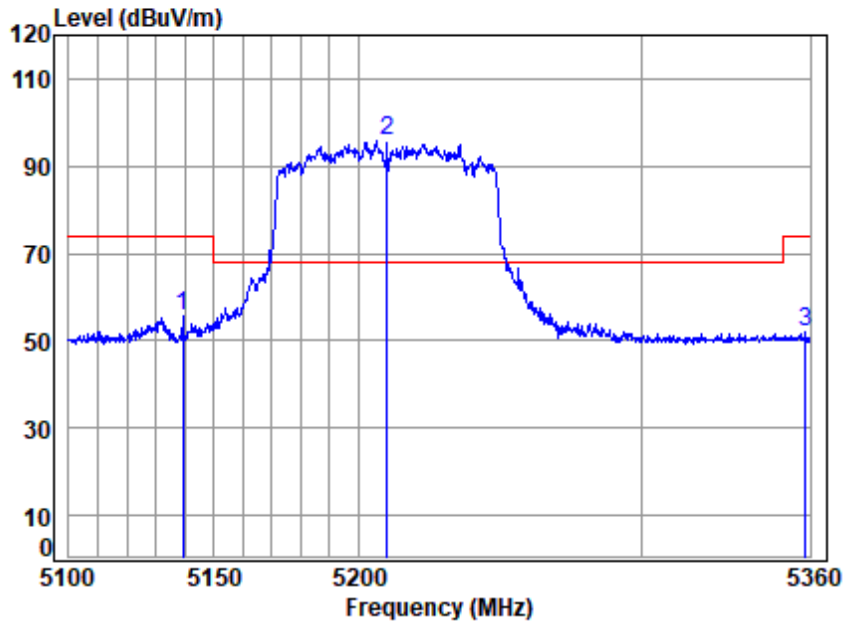

Site : chamber
 Condition: 3m HORIZONTAL
 Job No : 00955AT/00956AT
 Mode : 5210 Band edge
 : 5G WIFI 11AC80

	Cable	Ant	Preamp	Read	Limit	Over		
Freq	Loss	Factor	Factor	Level	Level	Line	Limit	Remark
MHz	dB	dB/m	dB	dBuV	dBuV/m	dBuV/m	dB	
1	7.54	33.92	35.32	49.31	55.45	74.00	-18.55	peak
2 p	7.60	34.02	35.28	89.35	95.69	68.20	27.49	peak
3	7.71	34.43	35.20	45.18	52.12	74.00	-21.88	peak



Unless otherwise agreed in writing, this document is issued by the Company subject to its General Conditions of Service printed overleaf, available on request or accessible at <https://www.sgs.com/en/Terms-and-Conditions>. Attention is drawn to the limitation of liability, indemnification and jurisdiction issues defined therein. Any holder of this document is advised that information contained hereon reflects the Company's findings at the time of its intervention only and within the limits of Client's instructions, if any. The Company's sole responsibility is to its Client and this document does not exonerate parties to a transaction from exercising all their rights and obligations under the transaction documents. This document cannot be reproduced except in full, without prior written approval of the Company. Any unauthorized alteration, forgery or falsification of the content or appearance of this document is unlawful and offenders may be prosecuted to the fullest extent of the law. Unless otherwise stated the results shown in this test report refer only to the sample(s) tested and such sample(s) are retained for 30 days only.

Test Mode: 21; Polarity: Horizontal; Modulation:802.11ac; Bandwidth:80MHz; Channel:middle

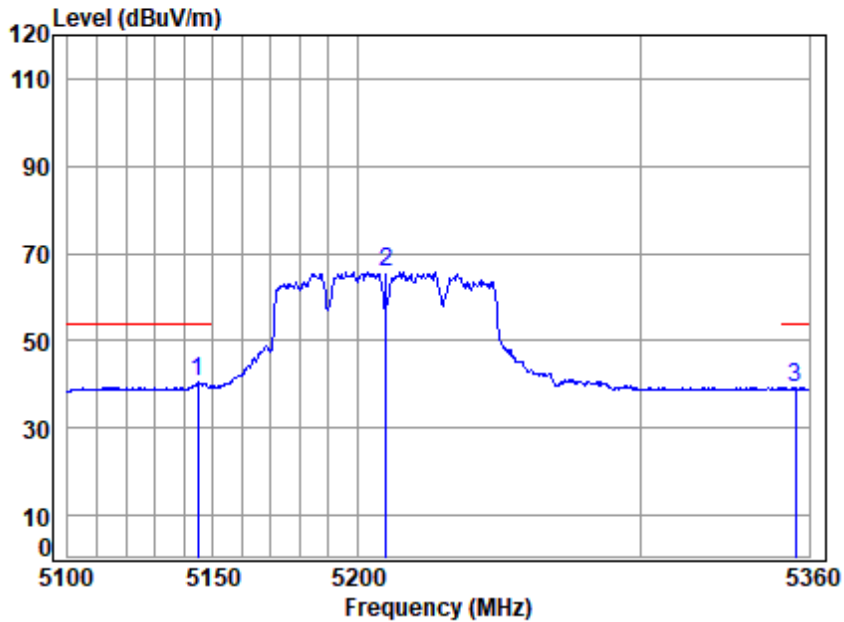

Site : chamber
 Condition: 3m HORIZONTAL
 Job No : 00955AT/00956AT
 Mode : 5210 Band edge
 : 5G WIFI 11AC80

	Cable	Ant	Preamp	Read	Limit	Over		
Freq	Loss	Factor	Factor	Level	Level	Line	Limit	Remark
MHz	dB	dB/m	dB	dBuV	dBuV/m	dBuV/m	dB	
1 q 5144.572	7.55	33.91	35.31	34.41	40.56	54.00	-13.44	Average
2 5210.000	7.60	34.02	35.28	59.31	65.65	-----	-----	Average
3 5355.205	7.71	34.42	35.21	32.40	39.32	54.00	-14.68	Average



Unless otherwise agreed in writing, this document is issued by the Company subject to its General Conditions of Service printed overleaf, available on request or accessible at <https://www.sgs.com/en/Terms-and-Conditions>. Attention is drawn to the limitation of liability, indemnification and jurisdiction issues defined therein. Any holder of this document is advised that information contained hereon reflects the Company's findings at the time of its intervention only and within the limits of Client's instructions, if any. The Company's sole responsibility is to its Client and this document does not exonerate parties to a transaction from exercising all their rights and obligations under the transaction documents. This document cannot be reproduced except in full, without prior written approval of the Company. Any unauthorized alteration, forgery or falsification of the content or appearance of this document is unlawful and offenders may be prosecuted to the fullest extent of the law. Unless otherwise stated the results shown in this test report refer only to the sample(s) tested and such sample(s) are retained for 30 days only.

Test Mode: 21; Polarity: Vertical; Modulation:802.11ac; Bandwidth:80MHz; Channel:middle

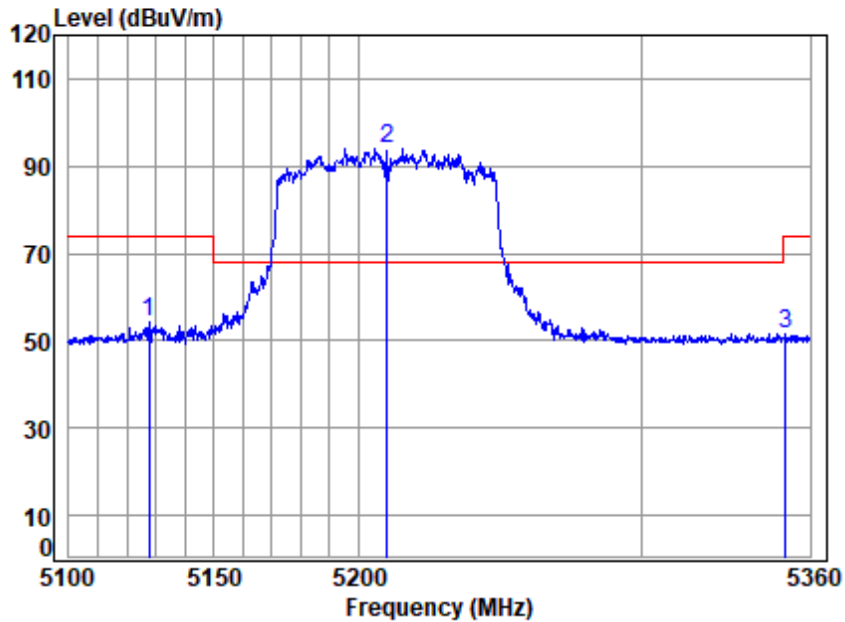

Site : chamber
 Condition: 3m VERTICAL
 Job No : 00955AT/00956AT
 Mode : 5210 Band edge
 : 5G WIFI 11AC80

	Cable	Ant	Preamp	Read	Limit	Over	
Freq	Loss	Factor	Factor	Level	Level	Line	Limit Remark
MHz	dB	dB/m	dB	dBuV	dBuV/m	dBuV/m	dB
1	5127.461	7.53	33.95	35.32	47.98	54.14	74.00 -19.86 Peak
2 p	5210.000	7.60	34.02	35.28	87.74	94.08	68.20 25.88 Peak
3	5351.212	7.71	34.40	35.21	44.53	51.43	74.00 -22.57 Peak



Unless otherwise agreed in writing, this document is issued by the Company subject to its General Conditions of Service printed overleaf, available on request or accessible at <https://www.sgs.com/en/Terms-and-Conditions>. Attention is drawn to the limitation of liability, indemnification and jurisdiction issues defined therein. Any holder of this document is advised that information contained hereon reflects the Company's findings at the time of its intervention only and within the limits of Client's instructions, if any. The Company's sole responsibility is to its Client and this document does not exonerate parties to a transaction from exercising all their rights and obligations under the transaction documents. This document cannot be reproduced except in full, without prior written approval of the Company. Any unauthorized alteration, forgery or falsification of the content or appearance of this document is unlawful and offenders may be prosecuted to the fullest extent of the law. Unless otherwise stated the results shown in this test report refer only to the sample(s) tested and such sample(s) are retained for 30 days only.

Test Mode: 21; Polarity: Vertical; Modulation:802.11ac; Bandwidth:80MHz; Channel:middle

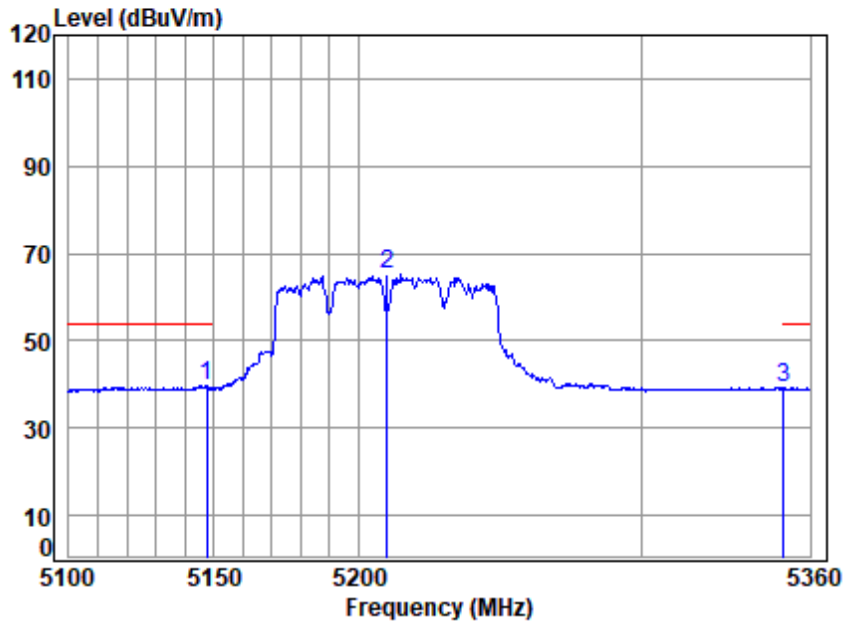

Site : chamber
 Condition: 3m VERTICAL
 Job No : 00955AT/00956AT
 Mode : 5210 Band edge
 : 5G WIFI 11AC80

		Cable	Ant	Preamp	Read	Limit	Over	
Freq	Loss	Factor	Factor	Factor	Level	Level	Line	Limit
MHz	dB	dB/m	dB	dB	dBuV	dBuV/m	dBuV/m	dB
1 q 5147.386	7.55	33.91	35.31	33.61	39.76	54.00	-14.24	Average
2 5210.000	7.60	34.02	35.28	58.83	65.17	-----	-----	Average
3 5350.414	7.70	34.40	35.21	32.32	39.21	54.00	-14.79	Average



Unless otherwise agreed in writing, this document is issued by the Company subject to its General Conditions of Service printed overleaf, available on request or accessible at <https://www.sgs.com/en/Terms-and-Conditions>. Attention is drawn to the limitation of liability, indemnification and jurisdiction issues defined therein. Any holder of this document is advised that information contained hereon reflects the Company's findings at the time of its intervention only and within the limits of Client's instructions, if any. The Company's sole responsibility is to its Client and this document does not exonerate parties to a transaction from exercising all their rights and obligations under the transaction documents. This document cannot be reproduced except in full, without prior written approval of the Company. Any unauthorized alteration, forgery or falsification of the content or appearance of this document is unlawful and offenders may be prosecuted to the fullest extent of the law. Unless otherwise stated the results shown in this test report refer only to the sample(s) tested and such sample(s) are retained for 30 days only.

Test Mode: 22; Polarity: Horizontal; Modulation:802.11a; Bandwidth:20MHz; Channel:Low

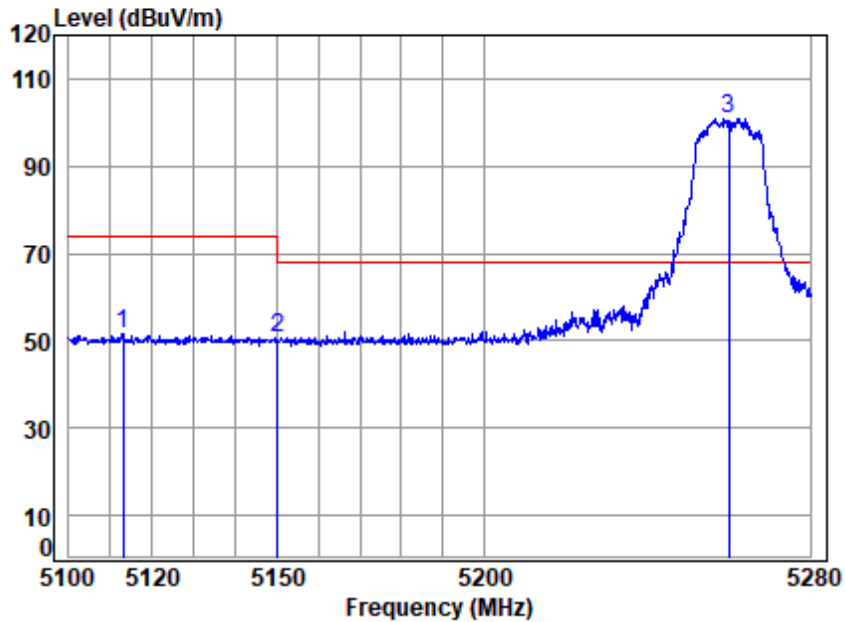

Site : chamber
 Condition: 3m HORIZONTAL
 Job No : 00955AT/00956AT
 Mode : 5260 Band edge
 : 5G WIFI 11A

	Cable	Ant	Preamp	Read	Limit	Over		
Freq	Loss	Factor	Factor	Level	Level	Line	Limit	Remark
MHz	dB	dB/m	dB	dBuV	dBuV/m	dBuV/m	dB	
1	7.52	33.97	35.33	45.56	51.72	74.00	-22.28	peak
2	7.55	33.90	35.31	44.36	50.50	74.00	-23.50	peak
3 p	7.64	34.12	35.25	94.54	101.05	68.20	32.85	peak



Unless otherwise agreed in writing, this document is issued by the Company subject to its General Conditions of Service printed overleaf, available on request or accessible at <https://www.sgs.com/en/Terms-and-Conditions>. Attention is drawn to the limitation of liability, indemnification and jurisdiction issues defined therein. Any holder of this document is advised that information contained hereon reflects the Company's findings at the time of its intervention only and within the limits of Client's instructions, if any. The Company's sole responsibility is to its Client and this document does not exonerate parties to a transaction from exercising all their rights and obligations under the transaction documents. This document cannot be reproduced except in full, without prior written approval of the Company. Any unauthorized alteration, forgery or falsification of the content or appearance of this document is unlawful and offenders may be prosecuted to the fullest extent of the law. Unless otherwise stated the results shown in this test report refer only to the sample(s) tested and such sample(s) are retained for 30 days only.

Attention: To check the authenticity of testing /inspection report & certificate, please contact us at telephone: (86-755) 8307 1443, or email: CN.Doccheck@sgs.com
 No.1 Workshop, M-10, Middle Section, Science & Technology Park, Nanshan District, Shenzhen, Guangdong, China 518057 t (86-755) 26012053 f (86-755) 26710594 www.sgs.com.cn
 中国·广东·深圳市南山区科技园中区M-10栋1号厂房 邮编: 518057 t (86-755) 26012053 f (86-755) 26710594 sgs.china@sgs.com

Test Mode: 22; Polarity: Horizontal; Modulation:802.11a; Bandwidth:20MHz; Channel:Low

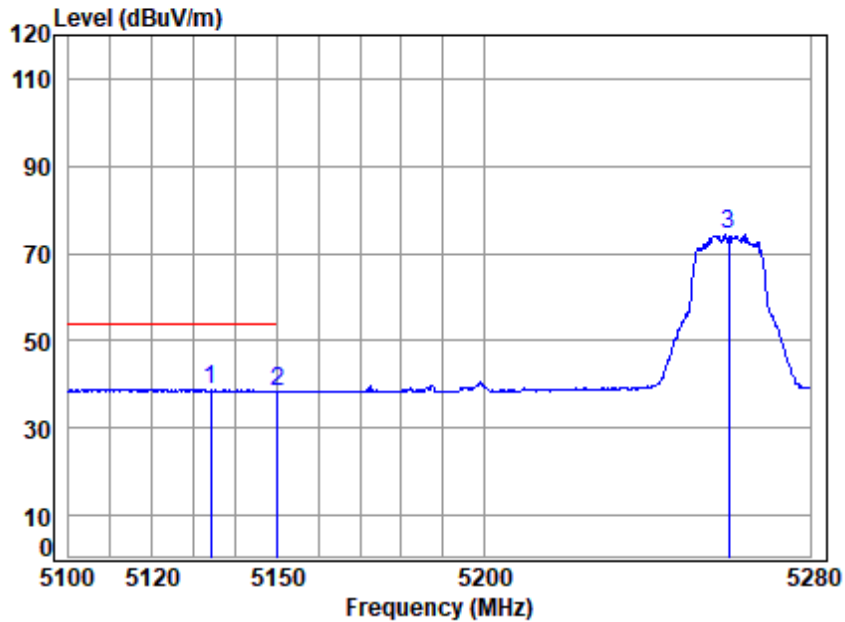

Site : chamber
 Condition: 3m HORIZONTAL
 Job No : 00955AT/00956AT
 Mode : 5260 Band edge
 : 5G WIFI 11A

	Cable	Ant	Preamp	Read	Limit	Over		
Freq	Loss	Factor	Factor	Level	Level	Line	Limit	Remark
MHz	dB	dB/m	dB	dBuV	dBuV/m	dBuV/m	dB	
1 q 5134.078	7.54	33.93	35.32	32.64	38.79	54.00	-15.21	Average
2 5149.980	7.55	33.90	35.31	32.30	38.44	54.00	-15.56	Average
3 5260.000	7.64	34.12	35.25	67.86	74.37	-----	-----	Average



Unless otherwise agreed in writing, this document is issued by the Company subject to its General Conditions of Service printed overleaf, available on request or accessible at <https://www.sgs.com/en/Terms-and-Conditions>. Attention is drawn to the limitation of liability, indemnification and jurisdiction issues defined therein. Any holder of this document is advised that information contained hereon reflects the Company's findings at the time of its intervention only and within the limits of Client's instructions, if any. The Company's sole responsibility is to its Client and this document does not exonerate parties to a transaction from exercising all their rights and obligations under the transaction documents. This document cannot be reproduced except in full, without prior written approval of the Company. Any unauthorized alteration, forgery or falsification of the content or appearance of this document is unlawful and offenders may be prosecuted to the fullest extent of the law. Unless otherwise stated the results shown in this test report refer only to the sample(s) tested and such sample(s) are retained for 30 days only.

Test Mode: 22; Polarity: Vertical; Modulation:802.11a; Bandwidth:20MHz; Channel:Low

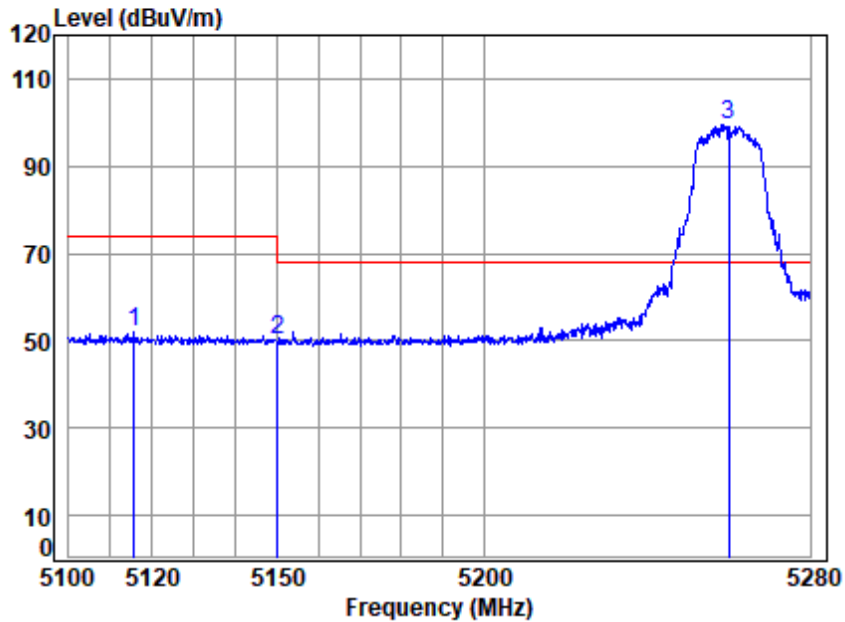

Site : chamber
 Condition: 3m VERTICAL
 Job No : 00955AT/00956AT
 Mode : 5260 Band edge
 : 5G WIFI 11A

	Cable	Ant	Preamp	Read	Limit	Over	
Freq	Loss	Factor	Factor	Level	Level	Line	Limit Remark
MHz	dB	dB/m	dB	dBuV	dBuV/m	dBuV/m	dB
1	7.52	33.97	35.33	46.02	52.18	74.00	-21.82 Peak
2	7.55	33.90	35.31	43.99	50.13	74.00	-23.87 Peak
3 p	7.64	34.12	35.25	92.96	99.47	68.20	31.27 Peak



Unless otherwise agreed in writing, this document is issued by the Company subject to its General Conditions of Service printed overleaf, available on request or accessible at <https://www.sgs.com/en/Terms-and-Conditions>. Attention is drawn to the limitation of liability, indemnification and jurisdiction issues defined therein. Any holder of this document is advised that information contained hereon reflects the Company's findings at the time of its intervention only and within the limits of Client's instructions, if any. The Company's sole responsibility is to its Client and this document does not exonerate parties to a transaction from exercising all their rights and obligations under the transaction documents. This document cannot be reproduced except in full, without prior written approval of the Company. Any unauthorized alteration, forgery or falsification of the content or appearance of this document is unlawful and offenders may be prosecuted to the fullest extent of the law. Unless otherwise stated the results shown in this test report refer only to the sample(s) tested and such sample(s) are retained for 30 days only.

Test Mode: 22; Polarity: Vertical; Modulation:802.11a; Bandwidth:20MHz; Channel:Low

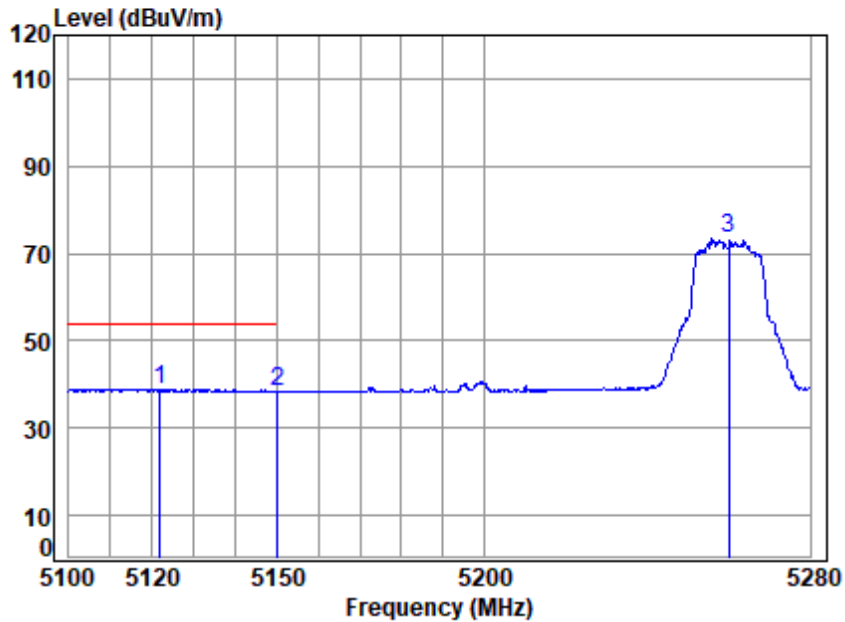

Site : chamber
 Condition: 3m VERTICAL
 Job No : 00955AT/00956AT
 Mode : 5260 Band edge
 : 5G WIFI 11A

	Cable	Ant	Preamp	Read	Limit	Over		
Freq	Loss	Factor	Factor	Level	Level	Line	Limit	Remark
MHz	dB	dB/m	dB	dBuV	dBuV/m	dBuV/m	dB	
1 q 5121.805	7.53	33.96	35.33	32.65	38.81	54.00	-15.19	Average
2 5149.980	7.55	33.90	35.31	32.34	38.48	54.00	-15.52	Average
3 5260.000	7.64	34.12	35.25	66.91	73.42	-----	-----	Average



Unless otherwise agreed in writing, this document is issued by the Company subject to its General Conditions of Service printed overleaf, available on request or accessible at <https://www.sgs.com/en/Terms-and-Conditions>. Attention is drawn to the limitation of liability, indemnification and jurisdiction issues defined therein. Any holder of this document is advised that information contained hereon reflects the Company's findings at the time of its intervention only and within the limits of Client's instructions, if any. The Company's sole responsibility is to its Client and this document does not exonerate parties to a transaction from exercising all their rights and obligations under the transaction documents. This document cannot be reproduced except in full, without prior written approval of the Company. Any unauthorized alteration, forgery or falsification of the content or appearance of this document is unlawful and offenders may be prosecuted to the fullest extent of the law. Unless otherwise stated the results shown in this test report refer only to the sample(s) tested and such sample(s) are retained for 30 days only.

Test Mode: 22; Polarity: Horizontal; Modulation:802.11 a; Bandwidth:20MHz; Channel:High

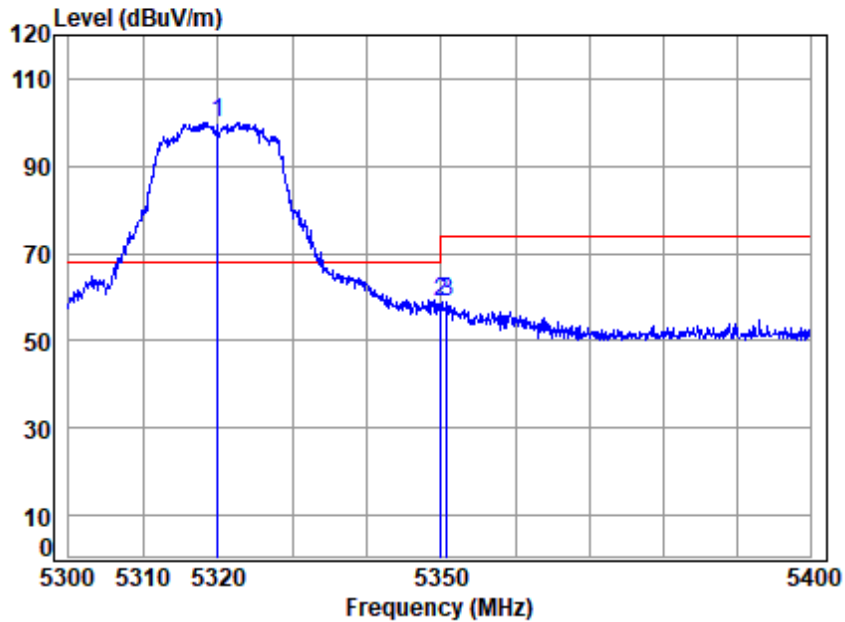

Site : chamber
 Condition: 3m HORIZONTAL
 Job No : 00955AT/00956AT
 Mode : 5320 Band edge
 : 5G WIFI 11A

	Cable	Ant	Preamp	Read	Limit	Over	
Freq	Loss	Factor	Factor	Level	Level	Line	Limit Remark
MHz	dB	dB/m	dB	dBuV	dBuV/m	dBuV/m	dB
1 p 5320.000	7.68	34.28	35.22	93.29	100.03	68.20	31.83 peak
2 5350.020	7.70	34.40	35.21	51.81	58.70	74.00	-15.30 peak
3 5350.767	7.71	34.40	35.21	51.77	58.67	74.00	-15.33 peak



Unless otherwise agreed in writing, this document is issued by the Company subject to its General Conditions of Service printed overleaf, available on request or accessible at <https://www.sgs.com/en/Terms-and-Conditions>. Attention is drawn to the limitation of liability, indemnification and jurisdiction issues defined therein. Any holder of this document is advised that information contained hereon reflects the Company's findings at the time of its intervention only and within the limits of Client's instructions, if any. The Company's sole responsibility is to its Client and this document does not exonerate parties to a transaction from exercising all their rights and obligations under the transaction documents. This document cannot be reproduced except in full, without prior written approval of the Company. Any unauthorized alteration, forgery or falsification of the content or appearance of this document is unlawful and offenders may be prosecuted to the fullest extent of the law. Unless otherwise stated the results shown in this test report refer only to the sample(s) tested and such sample(s) are retained for 30 days only.

Test Mode: 22; Polarity: Horizontal; Modulation:802.11a; Bandwidth:20MHz; Channel:High

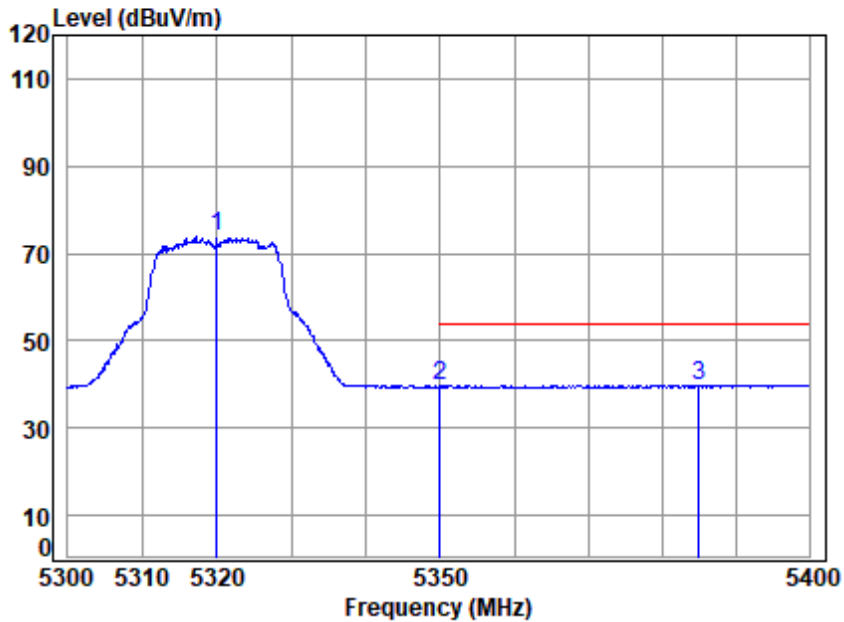

Site : chamber
 Condition: 3m HORIZONTAL
 Job No : 00955AT/00956AT
 Mode : 5320 Band edge
 : 5G WIFI 11A

	Freq	Cable Loss	Ant Factor	Preamp Factor	Read Level	Level	Limit Line	Over Limit	Remark
	MHz	dB	dB/m	dB	dBuV	dBuV/m	dBuV/m	dB	
1	5320.000	7.68	34.28	35.22	67.28	74.02	-----	-----	Average
2	5350.020	7.70	34.40	35.21	32.63	39.52	54.00	-14.48	Average
3 q	5385.082	7.73	34.54	35.19	32.76	39.84	54.00	-14.16	Average



Unless otherwise agreed in writing, this document is issued by the Company subject to its General Conditions of Service printed overleaf, available on request or accessible at <https://www.sgs.com/en/Terms-and-Conditions>. Attention is drawn to the limitation of liability, indemnification and jurisdiction issues defined therein. Any holder of this document is advised that information contained hereon reflects the Company's findings at the time of its intervention only and within the limits of Client's instructions, if any. The Company's sole responsibility is to its Client and this document does not exonerate parties to a transaction from exercising all their rights and obligations under the transaction documents. This document cannot be reproduced except in full, without prior written approval of the Company. Any unauthorized alteration, forgery or falsification of the content or appearance of this document is unlawful and offenders may be prosecuted to the fullest extent of the law. Unless otherwise stated the results shown in this test report refer only to the sample(s) tested and such sample(s) are retained for 30 days only.

Test Mode: 22; Polarity: Vertical; Modulation:802.11a; Bandwidth:20MHz; Channel:High

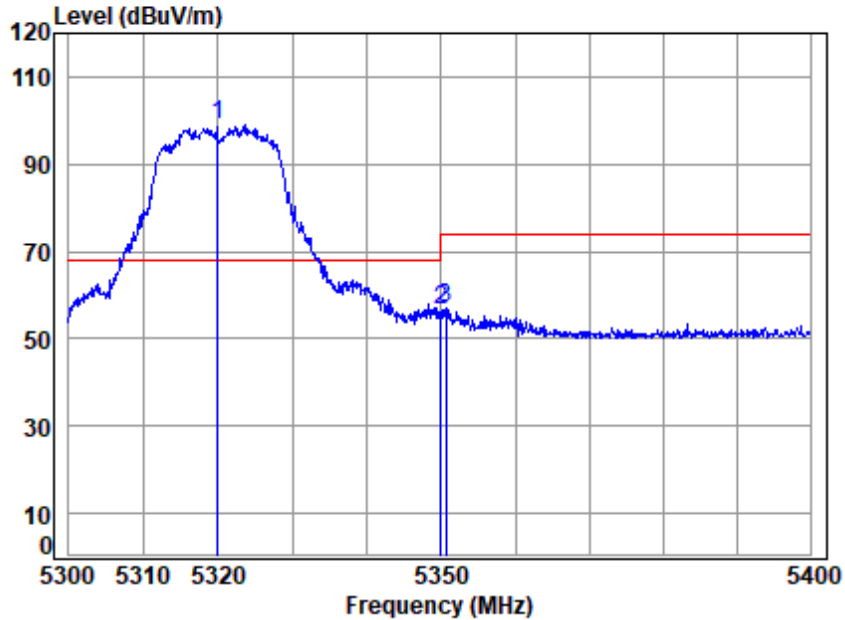

Site : chamber
 Condition: 3m VERTICAL
 Job No : 00955AT/00956AT
 Mode : 5320 Band edge
 : 5G WIFI 11A

	Cable	Ant	Preamp	Read	Limit	Over	
Freq	Loss	Factor	Factor	Level	Level	Line	Limit Remark
MHz	dB	dB/m	dB	dBuV	dBuV/m	dBuV/m	dB
1 p 5320.000	7.68	34.28	35.22	92.33	99.07	68.20	30.87 Peak
2 5350.020	7.70	34.40	35.21	49.74	56.63	74.00	-17.37 Peak
3 5350.667	7.71	34.40	35.21	49.94	56.84	74.00	-17.16 Peak



Test Mode: 22; Polarity: Vertical; Modulation:802.11a; Bandwidth:20MHz; Channel:High

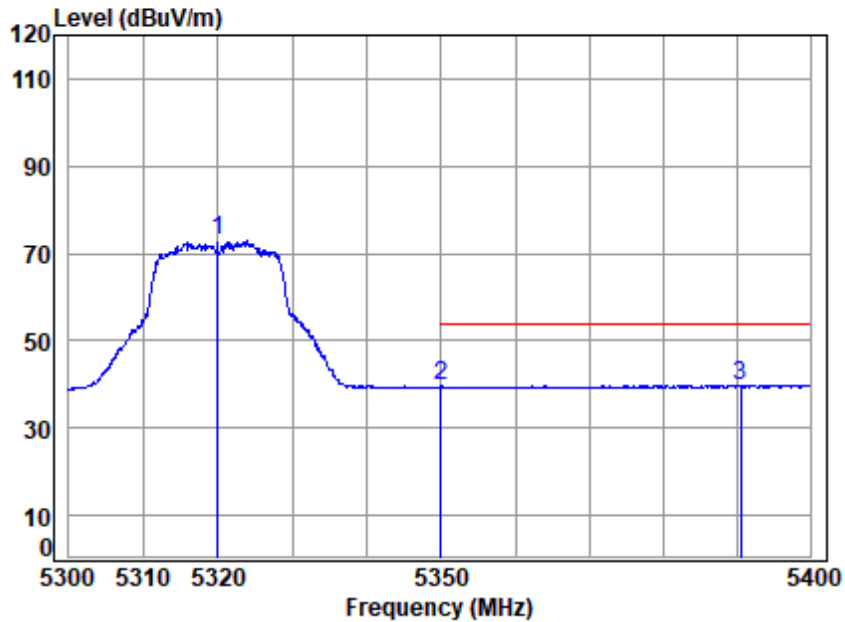

Site : chamber
 Condition: 3m VERTICAL
 Job No : 00955AT/00956AT
 Mode : 5320 Band edge
 : 5G WIFI 11A

	Freq	Cable Loss	Ant Factor	Preamp Factor	Read Level	Level	Limit Line	Over Limit	Remark
	MHz	dB	dB/m	dB	dBuV	dBuV/m	dBuV/m	dB	
1	5320.000	7.68	34.28	35.22	66.12	72.86	-----	-----	Average
2	5350.020	7.70	34.40	35.21	32.73	39.62	54.00	-14.38	Average
3 q	5390.621	7.74	34.56	35.19	32.63	39.74	54.00	-14.26	Average



Unless otherwise agreed in writing, this document is issued by the Company subject to its General Conditions of Service printed overleaf, available on request or accessible at <https://www.sgs.com/en/Terms-and-Conditions>. Attention is drawn to the limitation of liability, indemnification and jurisdiction issues defined therein. Any holder of this document is advised that information contained hereon reflects the Company's findings at the time of its intervention only and within the limits of Client's instructions, if any. The Company's sole responsibility is to its Client and this document does not exonerate parties to a transaction from exercising all their rights and obligations under the transaction documents. This document cannot be reproduced except in full, without prior written approval of the Company. Any unauthorized alteration, forgery or falsification of the content or appearance of this document is unlawful and offenders may be prosecuted to the fullest extent of the law. Unless otherwise stated the results shown in this test report refer only to the sample(s) tested and such sample(s) are retained for 30 days only.

Test Mode: 22; Polarity: Horizontal; Modulation:802.11ac; Bandwidth:20MHz; Channel:Low

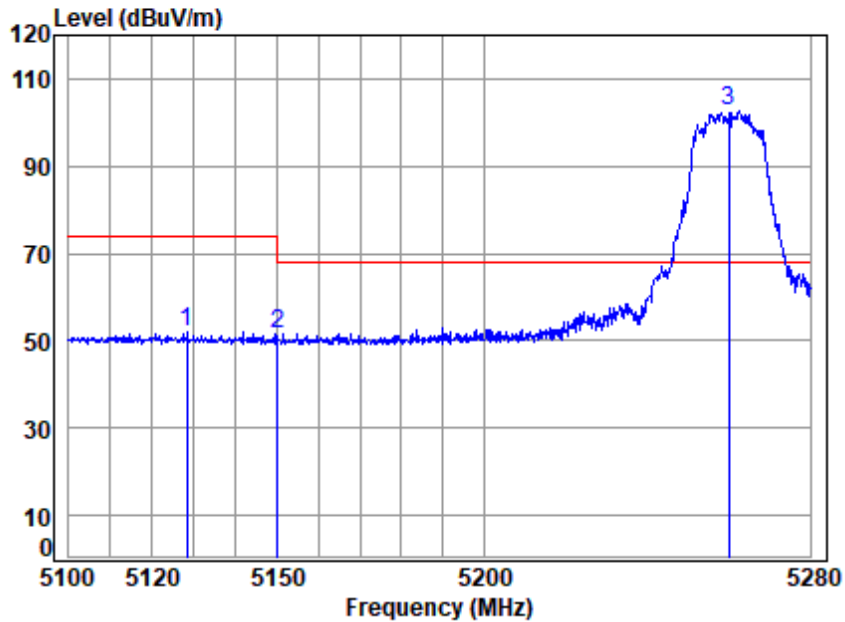

Site : chamber
 Condition: 3m HORIZONTAL
 Job No : 00955AT/00956AT
 Mode : 5260 Band edge
 : 5G WIFI 11AC20

	Cable	Ant	Preamp	Read	Limit	Over		
Freq	Loss	Factor	Factor	Level	Level	Line	Limit	Remark
MHz	dB	dB/m	dB	dBuV	dBuV/m	dBuV/m	dB	
1	5128.382	7.53	33.94	35.32	45.79	51.94	74.00	-22.06 peak
2	5149.980	7.55	33.90	35.31	45.50	51.64	74.00	-22.36 peak
3 p	5260.000	7.64	34.12	35.25	96.00	102.51	68.20	34.31 peak



Test Mode: 22; Polarity: Horizontal; Modulation:802.11ac; Bandwidth:20MHz; Channel:Low

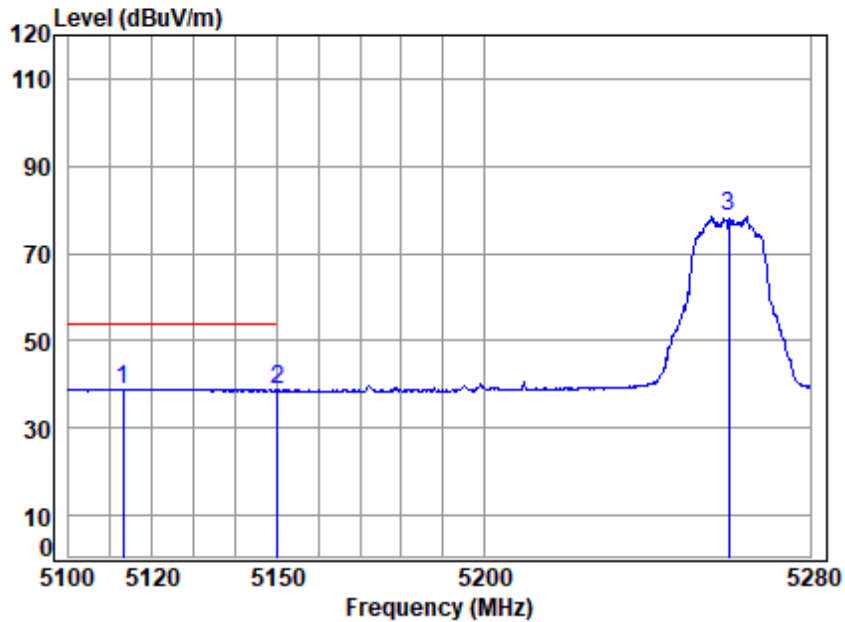

Site : chamber
 Condition: 3m HORIZONTAL
 Job No : 00955AT/00956AT
 Mode : 5260 Band edge
 : 5G WIFI 11AC20

	Cable	Ant	Preamp	Read	Limit	Over		
Freq	Loss	Factor	Factor	Level	Level	Line	Limit	Remark
MHz	dB	dB/m	dB	dBuV	dBuV/m	dBuV/m	dB	
1 q 5113.107	7.52	33.97	35.33	32.84	39.00	54.00	-15.00	Average
2 5149.980	7.55	33.90	35.31	32.63	38.77	54.00	-15.23	Average
3 5260.000	7.64	34.12	35.25	72.01	78.52	-----	-----	Average



Unless otherwise agreed in writing, this document is issued by the Company subject to its General Conditions of Service printed overleaf, available on request or accessible at <https://www.sgs.com/en/Terms-and-Conditions>. Attention is drawn to the limitation of liability, indemnification and jurisdiction issues defined therein. Any holder of this document is advised that information contained hereon reflects the Company's findings at the time of its intervention only and within the limits of Client's instructions, if any. The Company's sole responsibility is to its Client and this document does not exonerate parties to a transaction from exercising all their rights and obligations under the transaction documents. This document cannot be reproduced except in full, without prior written approval of the Company. Any unauthorized alteration, forgery or falsification of the content or appearance of this document is unlawful and offenders may be prosecuted to the fullest extent of the law. Unless otherwise stated the results shown in this test report refer only to the sample(s) tested and such sample(s) are retained for 30 days only.

Test Mode: 22; Polarity: Vertical; Modulation:802.11ac; Bandwidth:20MHz; Channel:Low

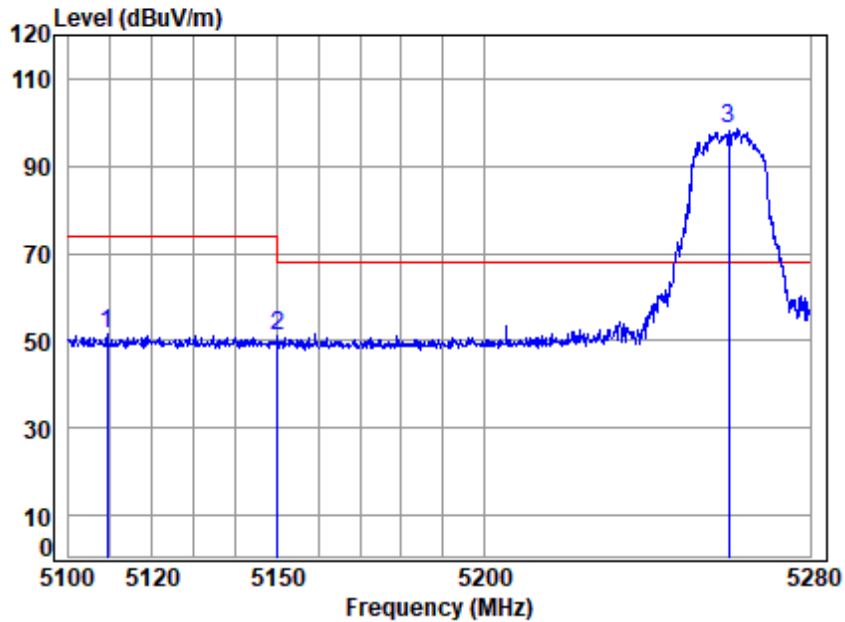

Site : chamber
 Condition: 3m VERTICAL
 Job No : 00955AT/00956AT
 Mode : 5260 Band edge
 : 5G WIFI 11AC20

	Cable	Ant	Preamp	Read	Limit	Over	
Freq	Loss	Factor	Factor	Level	Level	Line	Limit Remark
MHz	dB	dB/m	dB	dBuV	dBuV/m	dBuV/m	dB
1	7.52	33.98	35.33	45.29	51.46	74.00	-22.54 Peak
2	7.55	33.90	35.31	44.75	50.89	74.00	-23.11 Peak
3 p	7.64	34.12	35.25	91.95	98.46	68.20	30.26 Peak



Unless otherwise agreed in writing, this document is issued by the Company subject to its General Conditions of Service printed overleaf, available on request or accessible at <https://www.sgs.com/en/Terms-and-Conditions>. Attention is drawn to the limitation of liability, indemnification and jurisdiction issues defined therein. Any holder of this document is advised that information contained hereon reflects the Company's findings at the time of its intervention only and within the limits of Client's instructions, if any. The Company's sole responsibility is to its Client and this document does not exonerate parties to a transaction from exercising all their rights and obligations under the transaction documents. This document cannot be reproduced except in full, without prior written approval of the Company. Any unauthorized alteration, forgery or falsification of the content or appearance of this document is unlawful and offenders may be prosecuted to the fullest extent of the law. Unless otherwise stated the results shown in this test report refer only to the sample(s) tested and such sample(s) are retained for 30 days only.

Test Mode: 22; Polarity: Vertical; Modulation:802.11ac; Bandwidth:20MHz; Channel:Low

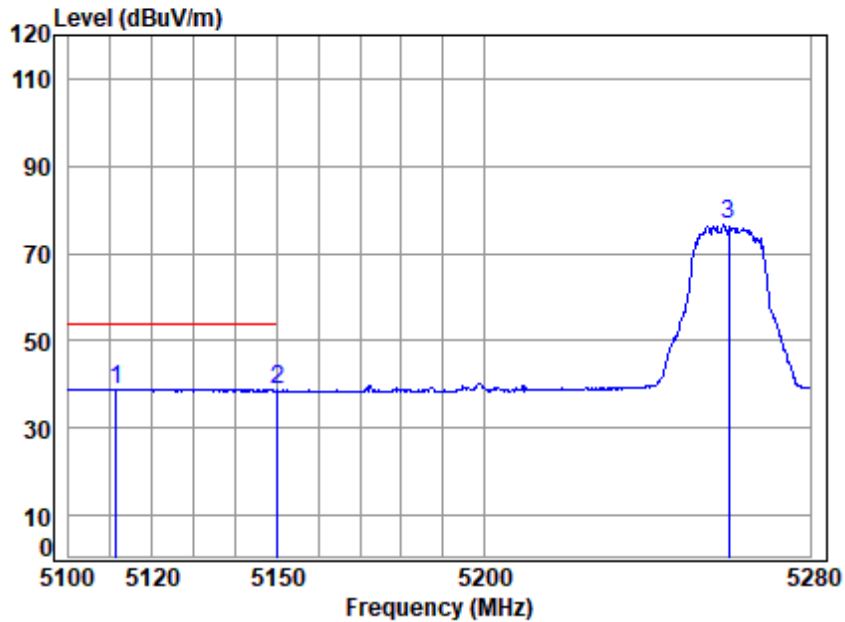

Site : chamber
 Condition: 3m VERTICAL
 Job No : 00955AT/00956AT
 Mode : 5260 Band edge
 : 5G WIFI 11AC20

	Freq	Cable Loss	Ant Factor	Preamp Factor	Read Level	Limit Level	Over Line	Over Limit	Remark
	MHz	dB	dB/m	dB	dBuV	dBuV/m	dBuV/m	dB	
1 q	5111.334	7.52	33.98	35.33	32.76	38.93	54.00	-15.07	Average
2	5149.980	7.55	33.90	35.31	32.52	38.66	54.00	-15.34	Average
3	5260.000	7.64	34.12	35.25	70.21	76.72	-----	-----	Average



Unless otherwise agreed in writing, this document is issued by the Company subject to its General Conditions of Service printed overleaf, available on request or accessible at <https://www.sgs.com/en/Terms-and-Conditions>. Attention is drawn to the limitation of liability, indemnification and jurisdiction issues defined therein. Any holder of this document is advised that information contained hereon reflects the Company's findings at the time of its intervention only and within the limits of Client's instructions, if any. The Company's sole responsibility is to its Client and this document does not exonerate parties to a transaction from exercising all their rights and obligations under the transaction documents. This document cannot be reproduced except in full, without prior written approval of the Company. Any unauthorized alteration, forgery or falsification of the content or appearance of this document is unlawful and offenders may be prosecuted to the fullest extent of the law. Unless otherwise stated the results shown in this test report refer only to the sample(s) tested and such sample(s) are retained for 30 days only.

Test Mode: 22; Polarity: Horizontal; Modulation:802.11ac; Bandwidth:20MHz; Channel:High

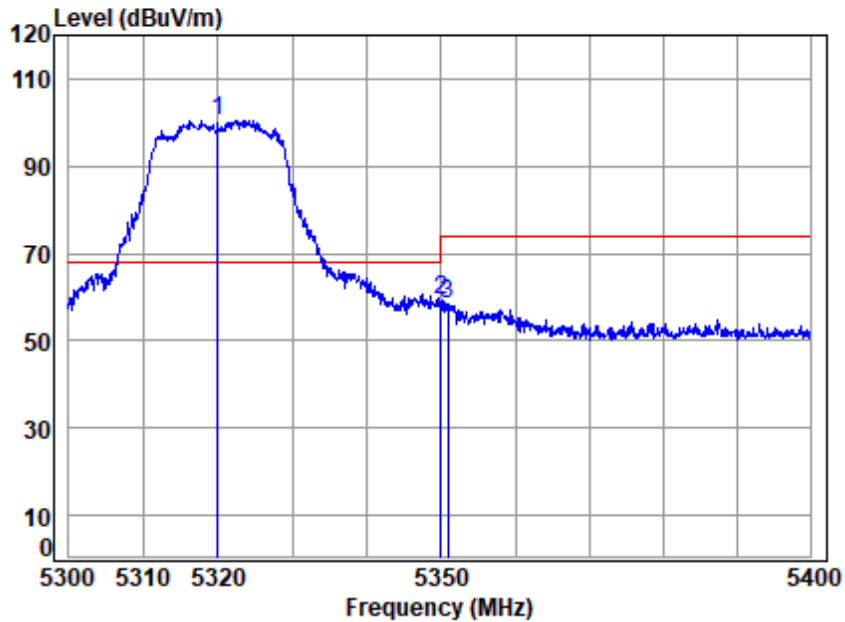

Site : chamber
 Condition: 3m HORIZONTAL
 Job No : 00955AT/00956AT
 Mode : 5320 Band edge
 : 5G WIFI 11AC20

	Cable	Ant	Preamp	Read	Limit	Over	
Freq	Loss	Factor	Factor	Level	Level	Line	Limit Remark
MHz	dB	dB/m	dB	dBuV	dBuV/m	dBuV/m	dB
1 p 5320.000	7.68	34.28	35.22	93.86	100.60	68.20	32.40 peak
2 5350.020	7.70	34.40	35.21	52.41	59.30	74.00	-14.70 peak
3 5350.866	7.71	34.40	35.21	51.59	58.49	74.00	-15.51 peak



Test Mode: 22; Polarity: Horizontal; Modulation:802.11ac; Bandwidth:20MHz; Channel:High

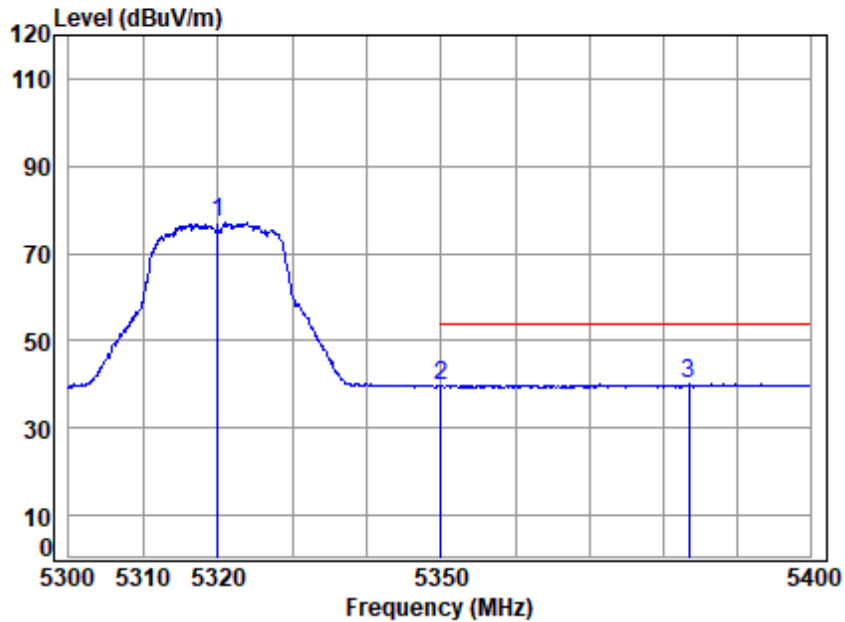

Site : chamber
 Condition: 3m HORIZONTAL
 Job No : 00955AT/00956AT
 Mode : 5320 Band edge
 : 5G WIFI 11AC20

	Cable	Ant	Preamp	Read	Limit	Over		
Freq	Loss	Factor	Factor	Level	Level	Line	Limit	Remark
MHz	dB	dB/m	dB	dBuV	dBuV/m	dBuV/m	dB	
1	7.68	34.28	35.22	70.52	77.26	-----	-----	Average
2	7.70	34.40	35.21	32.78	39.67	54.00	-14.33	Average
3 q	7.73	34.53	35.19	33.03	40.10	54.00	-13.90	Average



Test Mode: 22; Polarity: Vertical; Modulation:802.11ac; Bandwidth:20MHz; Channel:High

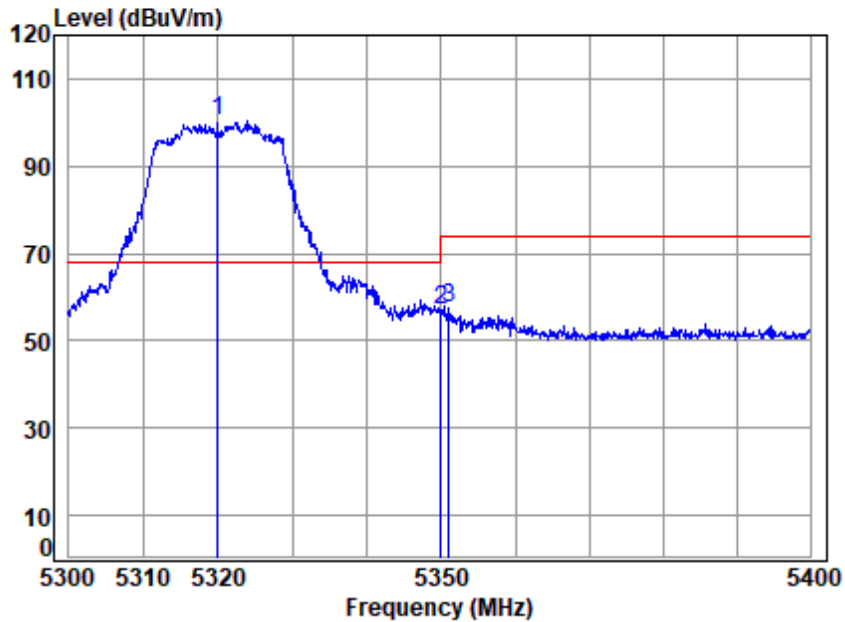

Site : chamber
 Condition: 3m VERTICAL
 Job No : 00955AT/00956AT
 Mode : 5320 Band edge
 : 5G WIFI 11AC20

	Cable	Ant	Preamp	Read	Limit	Over		
Freq	Loss	Factor	Factor	Level	Level	Line	Limit	Remark
MHz	dB	dB/m	dB	dBuV	dBuV/m	dBuV/m	dB	
1 p 5320.000	7.68	34.28	35.22	93.57	100.31	68.20	32.11	Peak
2 5350.020	7.70	34.40	35.21	50.14	57.03	74.00	-16.97	Peak
3 5351.066	7.71	34.40	35.21	50.76	57.66	74.00	-16.34	Peak



Unless otherwise agreed in writing, this document is issued by the Company subject to its General Conditions of Service printed overleaf, available on request or accessible at <https://www.sgs.com/en/Terms-and-Conditions>. Attention is drawn to the limitation of liability, indemnification and jurisdiction issues defined therein. Any holder of this document is advised that information contained hereon reflects the Company's findings at the time of its intervention only and within the limits of Client's instructions, if any. The Company's sole responsibility is to its Client and this document does not exonerate parties to a transaction from exercising all their rights and obligations under the transaction documents. This document cannot be reproduced except in full, without prior written approval of the Company. Any unauthorized alteration, forgery or falsification of the content or appearance of this document is unlawful and offenders may be prosecuted to the fullest extent of the law. Unless otherwise stated the results shown in this test report refer only to the sample(s) tested and such sample(s) are retained for 30 days only.

Test Mode: 22; Polarity: Vertical; Modulation:802.11ac; Bandwidth:20MHz; Channel:High

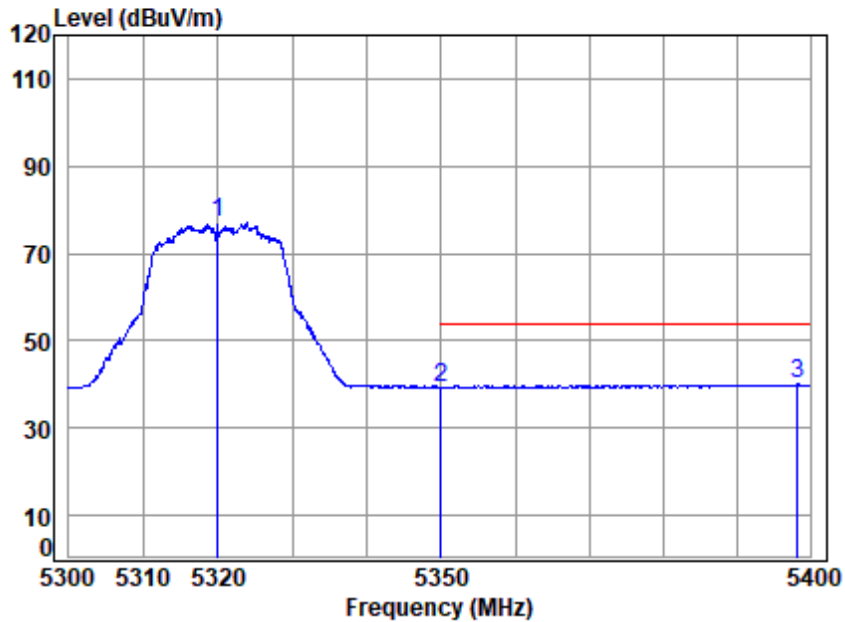

Site : chamber
 Condition: 3m VERTICAL
 Job No : 00955AT/00956AT
 Mode : 5320 Band edge
 : 5G WIFI 11AC20

	Freq	Cable Loss	Ant Factor	Preamp Factor	Read Level	Level	Limit Line	Over Limit	Remark
	MHz	dB	dB/m	dB	dBuV	dBuV/m	dBuV/m	dB	
1	5320.000	7.68	34.28	35.22	70.35	77.09	-----	-----	Average
2	5350.020	7.70	34.40	35.21	32.56	39.45	54.00	-14.55	Average
3 q	5398.284	7.74	34.59	35.18	32.79	39.94	54.00	-14.06	Average



Unless otherwise agreed in writing, this document is issued by the Company subject to its General Conditions of Service printed overleaf, available on request or accessible at <https://www.sgs.com/en/Terms-and-Conditions>. Attention is drawn to the limitation of liability, indemnification and jurisdiction issues defined therein. Any holder of this document is advised that information contained hereon reflects the Company's findings at the time of its intervention only and within the limits of Client's instructions, if any. The Company's sole responsibility is to its Client and this document does not exonerate parties to a transaction from exercising all their rights and obligations under the transaction documents. This document cannot be reproduced except in full, without prior written approval of the Company. Any unauthorized alteration, forgery or falsification of the content or appearance of this document is unlawful and offenders may be prosecuted to the fullest extent of the law. Unless otherwise stated the results shown in this test report refer only to the sample(s) tested and such sample(s) are retained for 30 days only.

Test Mode: 22; Polarity: Horizontal; Modulation:802.11ac; Bandwidth:40MHz; Channel:Low

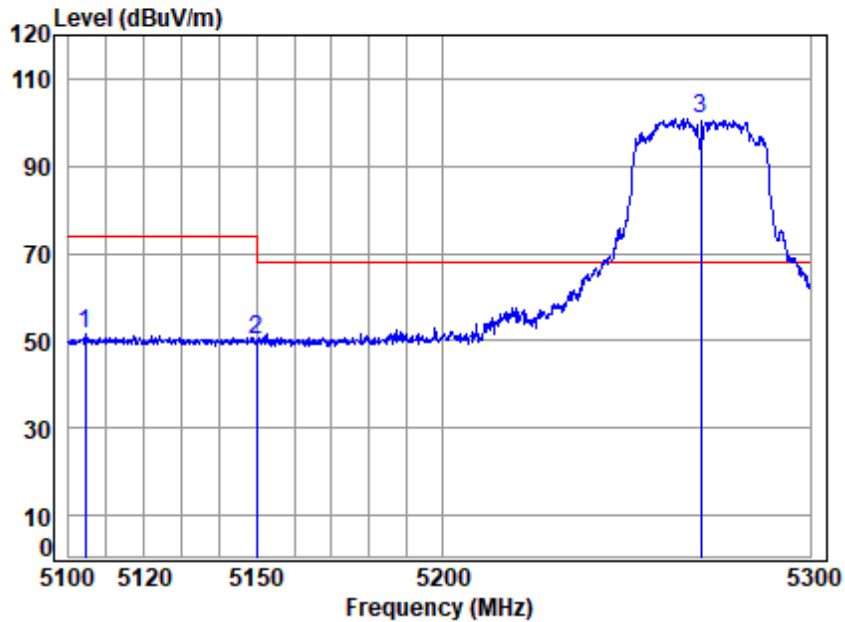

Site : chamber
 Condition: 3m HORIZONTAL
 Job No : 00955AT/00956AT
 Mode : 5270 Band edge
 : 5G WIFI 11AC40

	Cable	Ant	Preamp	Read	Limit	Over	
Freq	Loss	Factor	Factor	Level	Level	Line	Limit Remark
MHz	dB	dB/m	dB	dBuV	dBuV/m	dBuV/m	dB
1	5104.318	7.51	33.99	35.33	45.19	51.36	74.00 -22.64 peak
2	5149.980	7.55	33.90	35.31	44.18	50.32	74.00 -23.68 peak
3 p	5270.000	7.64	34.14	35.25	94.42	100.95	68.20 32.75 peak



Unless otherwise agreed in writing, this document is issued by the Company subject to its General Conditions of Service printed overleaf, available on request or accessible at <https://www.sgs.com/en/Terms-and-Conditions>. Attention is drawn to the limitation of liability, indemnification and jurisdiction issues defined therein. Any holder of this document is advised that information contained hereon reflects the Company's findings at the time of its intervention only and within the limits of Client's instructions, if any. The Company's sole responsibility is to its Client and this document does not exonerate parties to a transaction from exercising all their rights and obligations under the transaction documents. This document cannot be reproduced except in full, without prior written approval of the Company. Any unauthorized alteration, forgery or falsification of the content or appearance of this document is unlawful and offenders may be prosecuted to the fullest extent of the law. Unless otherwise stated the results shown in this test report refer only to the sample(s) tested and such sample(s) are retained for 30 days only.

Attention: To check the authenticity of testing /inspection report & certificate, please contact us at telephone: (86-755) 8307 1443, or email: CN.Doccheck@sgs.com
 No.1 Workshop, M-10, Middle Section, Science & Technology Park, Nanshan District, Shenzhen, Guangdong, China 518057 t (86-755) 26012053 f (86-755) 26710594 www.sgs.com.cn
 中国·广东·深圳市南山区科技园中区M-10栋1号厂房 邮编: 518057 t (86-755) 26012053 f (86-755) 26710594 sgs.china@sgs.com

Test Mode: 22; Polarity: Horizontal; Modulation:802.11ac; Bandwidth:40MHz; Channel:Low

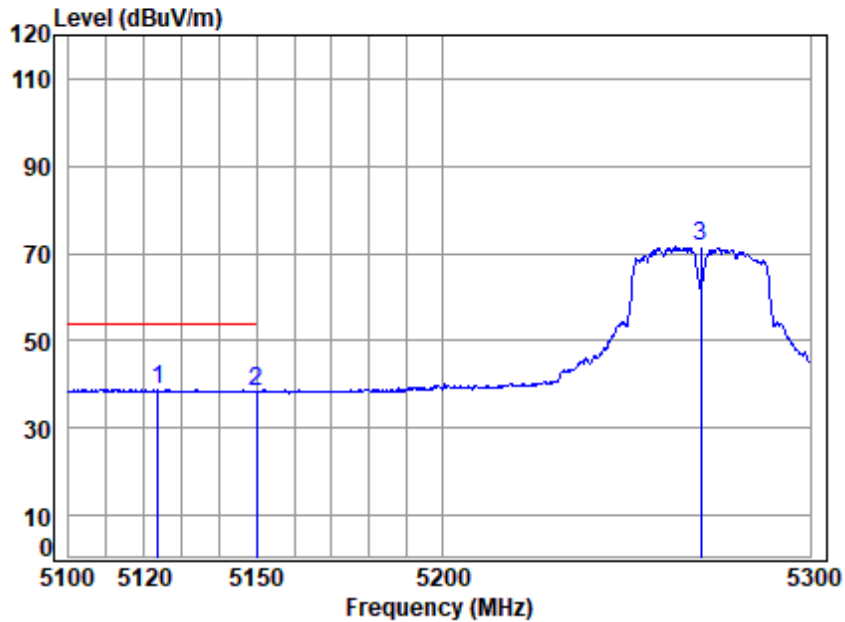

Site : chamber
 Condition: 3m HORIZONTAL
 Job No : 00955AT/00956AT
 Mode : 5270 Band edge
 : 5G WIFI 11AC40

	Cable	Ant	Preamp	Read	Limit	Over		
Freq	Loss	Factor	Factor	Level	Level	Line	Limit	Remark
MHz	dB	dB/m	dB	dBuV	dBuV/m	dBuV/m	dB	
1 q 5123.596	7.53	33.95	35.32	32.65	38.81	54.00	-15.19	Average
2 5149.980	7.55	33.90	35.31	32.23	38.37	54.00	-15.63	Average
3 5270.000	7.64	34.14	35.25	65.09	71.62	-----	-----	Average



Test Mode: 22; Polarity: Vertical; Modulation:802.11ac; Bandwidth:40MHz; Channel:Low

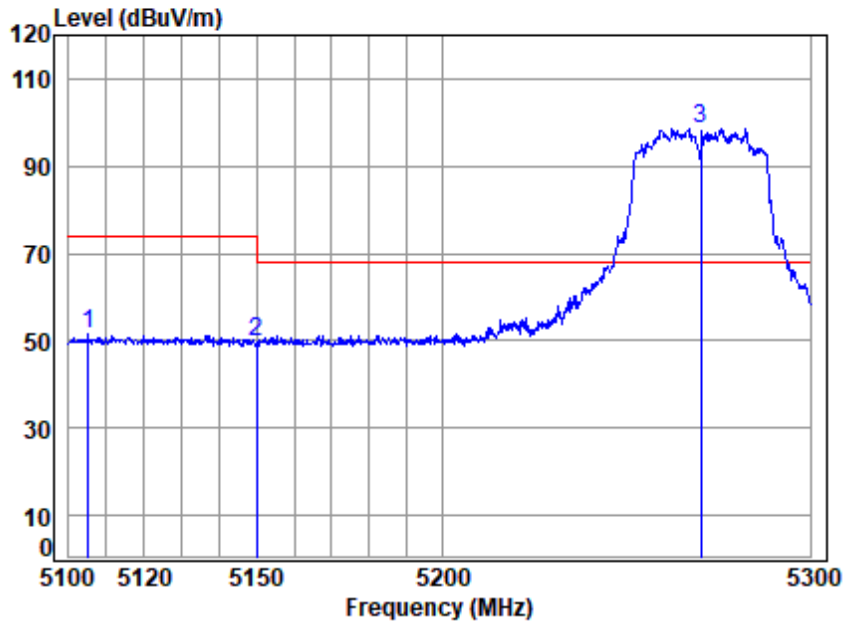

Site : chamber
 Condition: 3m VERTICAL
 Job No : 00955AT/00956AT
 Mode : 5270 Band edge
 : 5G WIFI 11AC40

	Cable	Ant	Preamp	Read	Limit	Over		
Freq	Loss	Factor	Factor	Level	Level	Line	Limit	Remark
MHz	dB	dB/m	dB	dBuV	dBuV/m	dBuV/m	dB	
1	5105.103	7.51	33.99	35.33	45.19	51.36	74.00	-22.64 Peak
2	5149.980	7.55	33.90	35.31	43.45	49.59	74.00	-24.41 Peak
3 p	5270.000	7.64	34.14	35.25	92.09	98.62	68.20	30.42 Peak



Unless otherwise agreed in writing, this document is issued by the Company subject to its General Conditions of Service printed overleaf, available on request or accessible at <https://www.sgs.com/en/Terms-and-Conditions>. Attention is drawn to the limitation of liability, indemnification and jurisdiction issues defined therein. Any holder of this document is advised that information contained hereon reflects the Company's findings at the time of its intervention only and within the limits of Client's instructions, if any. The Company's sole responsibility is to its Client and this document does not exonerate parties to a transaction from exercising all their rights and obligations under the transaction documents. This document cannot be reproduced except in full, without prior written approval of the Company. Any unauthorized alteration, forgery or falsification of the content or appearance of this document is unlawful and offenders may be prosecuted to the fullest extent of the law. Unless otherwise stated the results shown in this test report refer only to the sample(s) tested and such sample(s) are retained for 30 days only.

Attention: To check the authenticity of testing /inspection report & certificate, please contact us at telephone: (86-755) 8307 1443, or email: CN.Doccheck@sgs.com
 No.1 Workshop, M-10, Middle Section, Science & Technology Park, Nanshan District, Shenzhen, Guangdong, China 518057 t (86-755) 26012053 f (86-755) 26710594 www.sgs.com.cn
 中国·广东·深圳市南山区科技园中区M-10栋1号厂房 邮编: 518057 t (86-755) 26012053 f (86-755) 26710594 sgs.china@sgs.com

Test Mode: 22; Polarity: Vertical; Modulation:802.11ac; Bandwidth:40MHz; Channel:Low

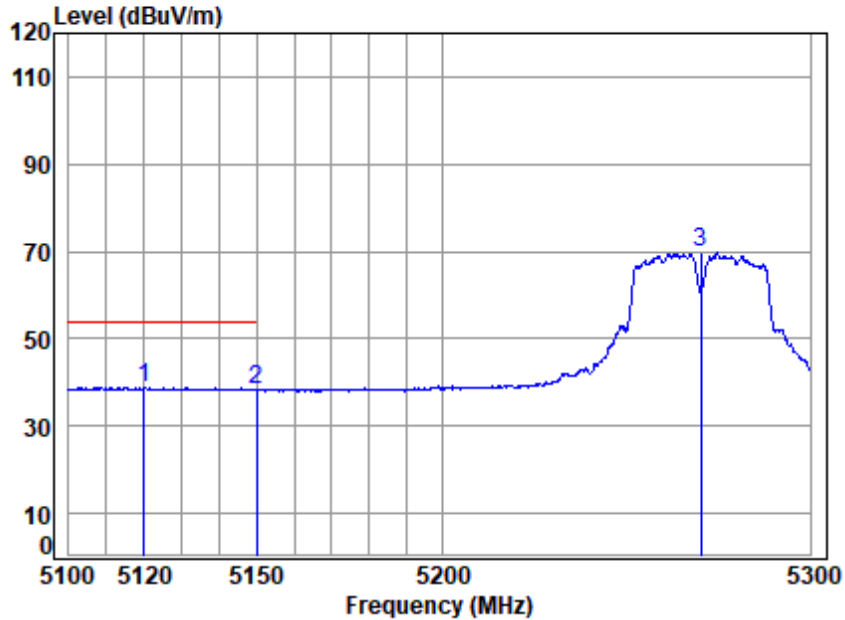

Site : chamber
 Condition: 3m VERTICAL
 Job No : 00955AT/00956AT
 Mode : 5270 Band edge
 : 5G WIFI 11AC40

	Cable	Ant	Preamp	Read	Limit	Over		
Freq	Loss	Factor	Factor	Level	Level	Line	Limit	Remark
MHz	dB	dB/m	dB	dBuV	dBuV/m	dBuV/m	dB	
1 q 5120.049	7.53	33.96	35.33	32.64	38.80	54.00	-15.20	Average
2 5149.980	7.55	33.90	35.31	32.13	38.27	54.00	-15.73	Average
3 5270.000	7.64	34.14	35.25	63.22	69.75	-----	-----	Average



Test Mode: 22; Polarity: Horizontal; Modulation:802.11ac; Bandwidth:40MHz; Channel:High

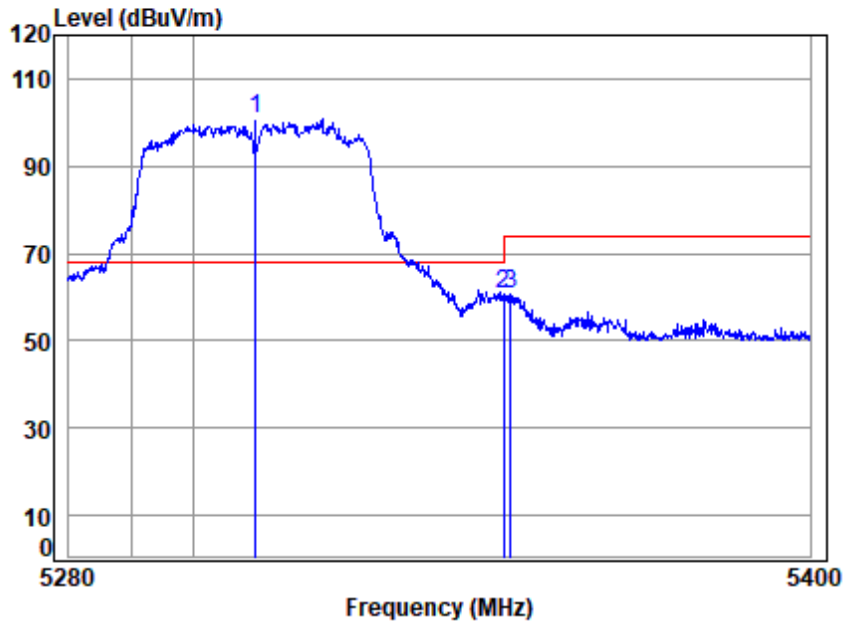

Site : chamber
 Condition: 3m HORIZONTAL
 Job No : 00955AT/00956AT
 Mode : 5310 Band edge
 : 5G WIFI 11AC40

	Cable	Ant	Preamp	Read	Limit	Over		
Freq	Loss	Factor	Factor	Level	Level	Line	Limit	Remark
MHz	dB	dB/m	dB	dBuV	dBuV/m	dBuV/m	dB	
1 p 5310.000	7.67	34.24	35.23	94.05	100.73	68.20	32.53	peak
2 5350.020	7.70	34.40	35.21	53.92	60.81	74.00	-13.19	peak
3 5351.195	7.71	34.40	35.21	53.58	60.48	74.00	-13.52	peak



Test Mode: 22; Polarity: Horizontal; Modulation:802.11ac; Bandwidth:40MHz; Channel:High

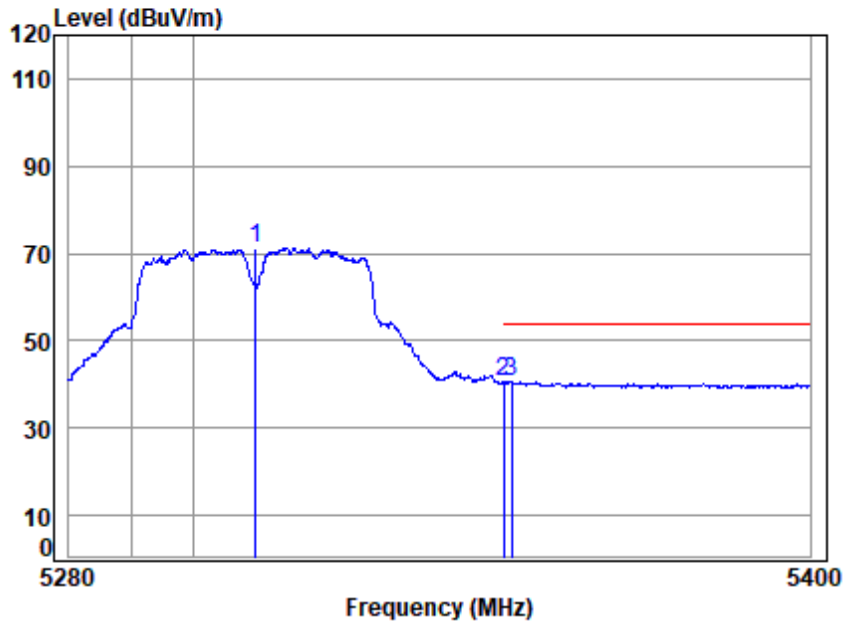

Site : chamber
 Condition: 3m HORIZONTAL
 Job No : 00955AT/00956AT
 Mode : 5310 Band edge
 : 5G WIFI 11AC40

	Freq	Cable Loss	Ant Factor	Preamp Factor	Read Level	Limit Level	Over Limit	Remark
	MHz	dB	dB/m	dB	dBuV	dBuV/m	dBuV/m	dB
1	5310.000	7.67	34.24	35.23	64.67	71.35	-----	----- Average
2	5350.020	7.70	34.40	35.21	33.58	40.47	54.00	-13.53 Average
3 q	5351.315	7.71	34.41	35.21	33.81	40.72	54.00	-13.28 Average



Unless otherwise agreed in writing, this document is issued by the Company subject to its General Conditions of Service printed overleaf, available on request or accessible at <https://www.sgs.com/en/Terms-and-Conditions>. Attention is drawn to the limitation of liability, indemnification and jurisdiction issues defined therein. Any holder of this document is advised that information contained hereon reflects the Company's findings at the time of its intervention only and within the limits of Client's instructions, if any. The Company's sole responsibility is to its Client and this document does not exonerate parties to a transaction from exercising all their rights and obligations under the transaction documents. This document cannot be reproduced except in full, without prior written approval of the Company. Any unauthorized alteration, forgery or falsification of the content or appearance of this document is unlawful and offenders may be prosecuted to the fullest extent of the law. Unless otherwise stated the results shown in this test report refer only to the sample(s) tested and such sample(s) are retained for 30 days only.

Test Mode: 22; Polarity: Vertical; Modulation:802.11ac; Bandwidth:40MHz; Channel:High

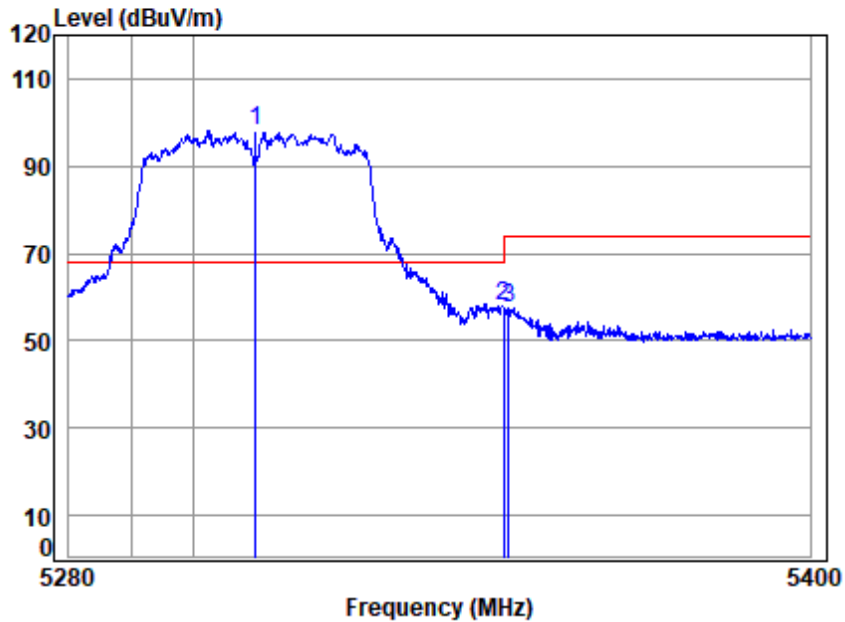

Site : chamber
 Condition: 3m VERTICAL
 Job No : 00955AT/00956AT
 Mode : 5310 Band edge
 : 5G WIFI 11AC40

	Cable	Ant	Preamp	Read	Limit	Over	
Freq	Loss	Factor	Factor	Level	Level	Line	Limit Remark
MHz	dB	dB/m	dB	dBuV	dBuV/m	dBuV/m	dB
1 p 5310.000	7.67	34.24	35.23	91.26	97.94	68.20	29.74 Peak
2 5350.020	7.70	34.40	35.21	51.02	57.91	74.00	-16.09 Peak
3 5350.834	7.71	34.40	35.21	50.80	57.70	74.00	-16.30 Peak



Test Mode: 22; Polarity: Vertical; Modulation:802.11ac; Bandwidth:40MHz; Channel:High

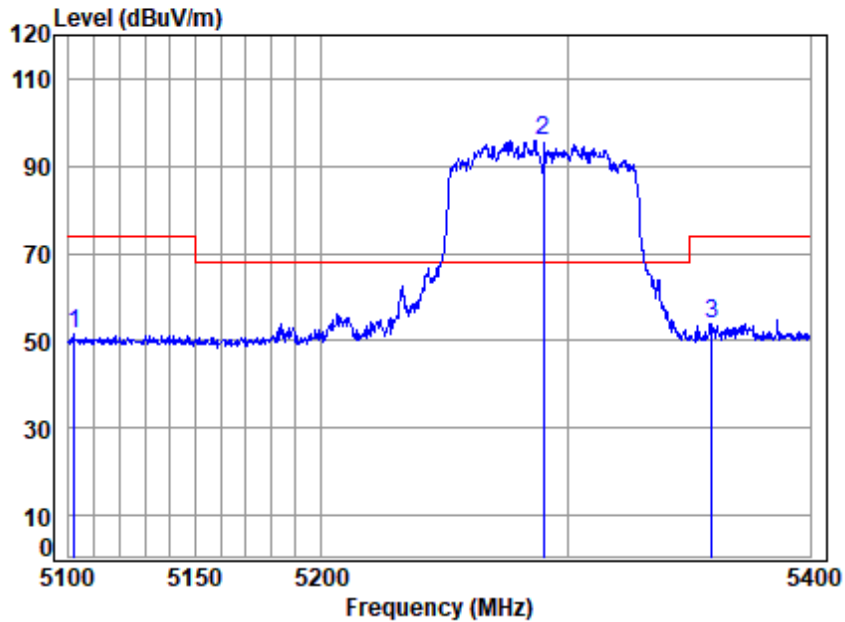

Site : chamber
 Condition: 3m HORIZONTAL
 Job No : 00955AT/00956AT
 Mode : 5290 Band edge
 : 5G WIFI 11AC80

	Cable	Ant	Preamp	Read	Limit	Over		
Freq	Loss	Factor	Factor	Level	Level	Line	Limit	Remark
MHz	dB	dB/m	dB	dBuV	dBuV/m	dBuV/m	dB	
1	7.51	34.00	35.34	45.28	51.45	74.00	-22.55	peak
2 p	7.66	34.18	35.24	89.42	96.02	68.20	27.82	peak
3	7.71	34.44	35.20	47.11	54.06	74.00	-19.94	peak



Unless otherwise agreed in writing, this document is issued by the Company subject to its General Conditions of Service printed overleaf, available on request or accessible at <https://www.sgs.com/en/Terms-and-Conditions>. Attention is drawn to the limitation of liability, indemnification and jurisdiction issues defined therein. Any holder of this document is advised that information contained hereon reflects the Company's findings at the time of its intervention only and within the limits of Client's instructions, if any. The Company's sole responsibility is to its Client and this document does not exonerate parties to a transaction from exercising all their rights and obligations under the transaction documents. This document cannot be reproduced except in full, without prior written approval of the Company. Any unauthorized alteration, forgery or falsification of the content or appearance of this document is unlawful and offenders may be prosecuted to the fullest extent of the law. Unless otherwise stated the results shown in this test report refer only to the sample(s) tested and such sample(s) are retained for 30 days only.

Test Mode: 22; Polarity: Horizontal; Modulation:802.11ac; Bandwidth:80MHz; Channel:middle

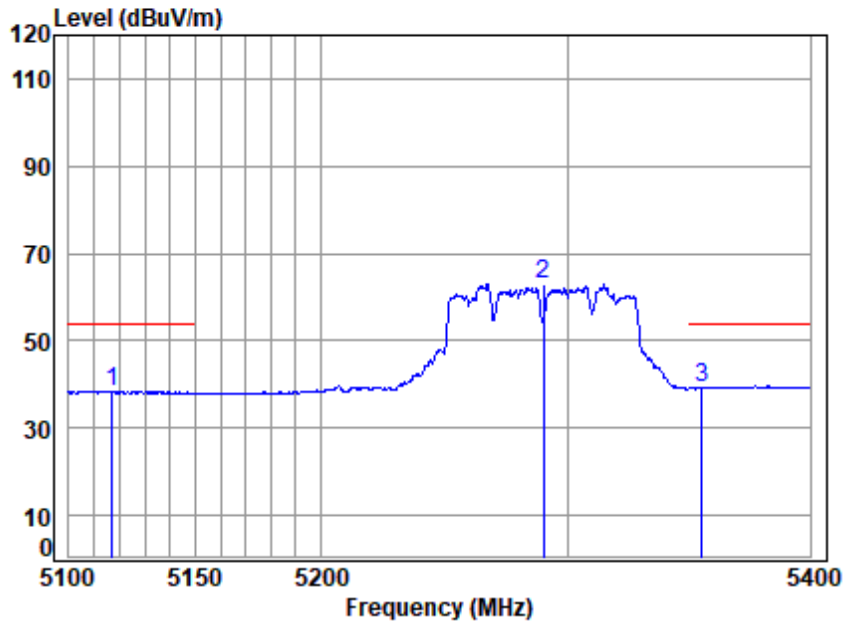

Site : chamber
 Condition: 3m HORIZONTAL
 Job No : 00955AT/00956AT
 Mode : 5290 Band edge
 : 5G WIFI 11AC80

	Freq	Cable Loss	Ant Factor	Preamp Factor	Read Level	Limit Level	Over Limit	Remark
	MHz	dB	dB/m	dB	dBuV	dBuV/m	dBuV/m	dB
1	5116.936	7.52	33.97	35.33	32.19	38.35	54.00	-15.65 Average
2	5290.000	7.66	34.18	35.24	56.35	62.95	-----	----- Average
3 q	5355.124	7.71	34.42	35.21	32.52	39.44	54.00	-14.56 Average



Unless otherwise agreed in writing, this document is issued by the Company subject to its General Conditions of Service printed overleaf, available on request or accessible at <https://www.sgs.com/en/Terms-and-Conditions>. Attention is drawn to the limitation of liability, indemnification and jurisdiction issues defined therein. Any holder of this document is advised that information contained hereon reflects the Company's findings at the time of its intervention only and within the limits of Client's instructions, if any. The Company's sole responsibility is to its Client and this document does not exonerate parties to a transaction from exercising all their rights and obligations under the transaction documents. This document cannot be reproduced except in full, without prior written approval of the Company. Any unauthorized alteration, forgery or falsification of the content or appearance of this document is unlawful and offenders may be prosecuted to the fullest extent of the law. Unless otherwise stated the results shown in this test report refer only to the sample(s) tested and such sample(s) are retained for 30 days only.

Test Mode: 22; Polarity: Horizontal; Modulation:802.11ac; Bandwidth:80MHz; Channel:middle

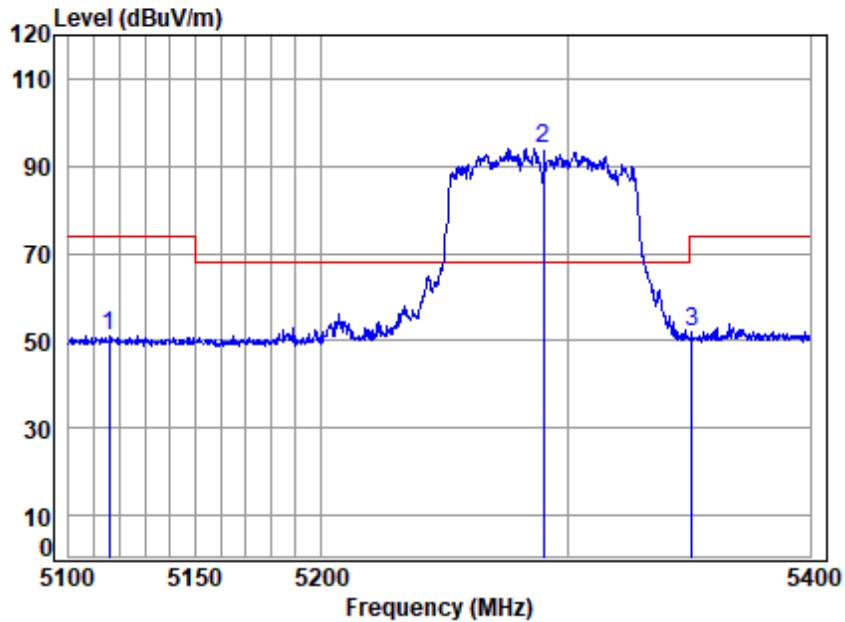

Site : chamber
 Condition: 3m VERTICAL
 Job No : 00955AT/00956AT
 Mode : 5290 Band edge
 : 5G WIFI 11AC80

	Cable	Ant	Preamp	Read	Limit	Over	
Freq	Loss	Factor	Factor	Level	Level	Line	Limit Remark
MHz	dB	dB/m	dB	dBuV	dBuV/m	dBuV/m	dB
1	5116.058	7.52	33.97	35.33	45.12	51.28	74.00 -22.72 Peak
2 p	5290.000	7.66	34.18	35.24	87.48	94.08	68.20 25.88 Peak
3	5351.146	7.71	34.40	35.21	45.21	52.11	74.00 -21.89 Peak



Unless otherwise agreed in writing, this document is issued by the Company subject to its General Conditions of Service printed overleaf, available on request or accessible at <https://www.sgs.com/en/Terms-and-Conditions>. Attention is drawn to the limitation of liability, indemnification and jurisdiction issues defined therein. Any holder of this document is advised that information contained hereon reflects the Company's findings at the time of its intervention only and within the limits of Client's instructions, if any. The Company's sole responsibility is to its Client and this document does not exonerate parties to a transaction from exercising all their rights and obligations under the transaction documents. This document cannot be reproduced except in full, without prior written approval of the Company. Any unauthorized alteration, forgery or falsification of the content or appearance of this document is unlawful and offenders may be prosecuted to the fullest extent of the law. Unless otherwise stated the results shown in this test report refer only to the sample(s) tested and such sample(s) are retained for 30 days only.

Test Mode: 22; Polarity: Vertical; Modulation:802.11ac; Bandwidth:80MHz; Channel:middle

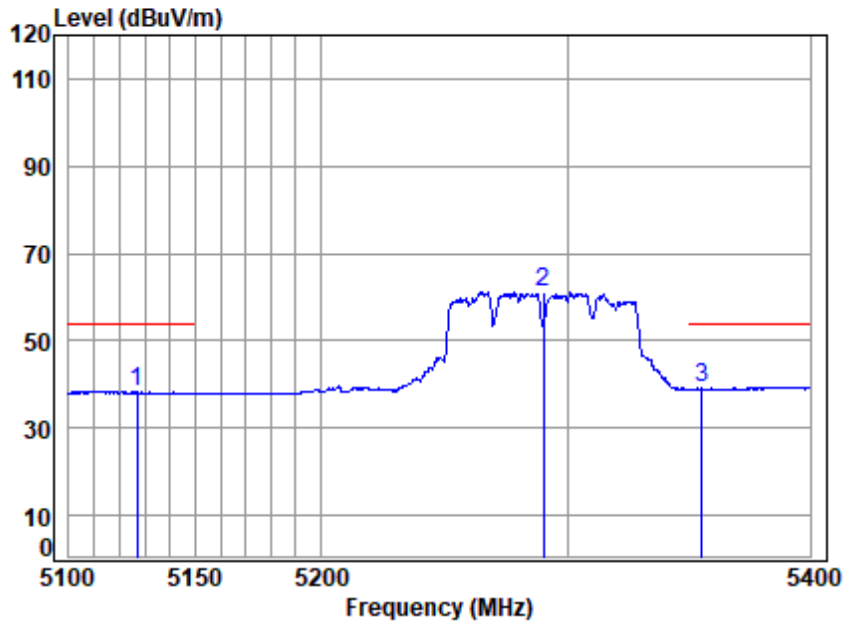

Site : chamber
 Condition: 3m VERTICAL
 Job No : 00955AT/00956AT
 Mode : 5290 Band edge
 : 5G WIFI 11AC80

	Freq	Cable Loss	Ant Factor	Preamp Factor	Read Level	Limit Level	Over Limit	Remark
	MHz	dB	dB/m	dB	dBuV	dBuV/m	dBuV/m	dB
1	5126.889	7.53	33.95	35.32	32.15	38.31	54.00	-15.69 Average
2	5290.000	7.66	34.18	35.24	54.48	61.08	-----	----- Average
3 q	5355.124	7.71	34.42	35.21	32.12	39.04	54.00	-14.96 Average



Unless otherwise agreed in writing, this document is issued by the Company subject to its General Conditions of Service printed overleaf, available on request or accessible at <https://www.sgs.com/en/Terms-and-Conditions>. Attention is drawn to the limitation of liability, indemnification and jurisdiction issues defined therein. Any holder of this document is advised that information contained hereon reflects the Company's findings at the time of its intervention only and within the limits of Client's instructions, if any. The Company's sole responsibility is to its Client and this document does not exonerate parties to a transaction from exercising all their rights and obligations under the transaction documents. This document cannot be reproduced except in full, without prior written approval of the Company. Any unauthorized alteration, forgery or falsification of the content or appearance of this document is unlawful and offenders may be prosecuted to the fullest extent of the law. Unless otherwise stated the results shown in this test report refer only to the sample(s) tested and such sample(s) are retained for 30 days only.

Test Mode: 22; Polarity: Vertical; Modulation:802.11ac; Bandwidth:80MHz; Channel:middle

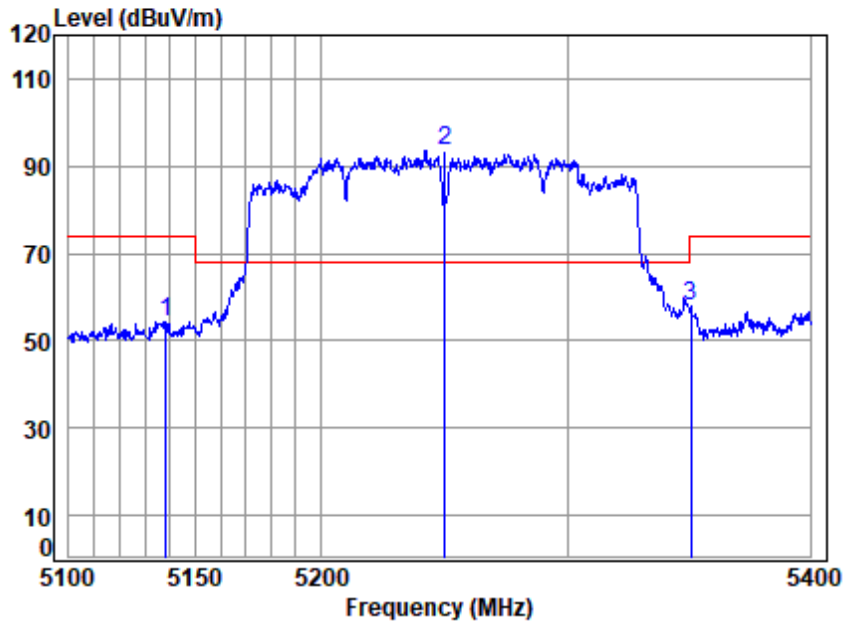

Site : chamber
 Condition: 3m HORIZONTAL
 Job No : 00955AT/00956AT
 Mode : 5250 Band edge
 : 5G WIFI 11AC160

	Cable	Ant	Preamp	Read	Limit	Over		
Freq	Loss	Factor	Factor	Level	Level	Line	Limit	Remark
MHz	dB	dB/m	dB	dBuV	dBuV/m	dBuV/m	dB	
1	7.54	33.92	35.32	48.20	54.34	74.00	-19.66	peak
2 p	7.63	34.10	35.26	87.19	93.66	68.20	25.46	peak
3	7.71	34.40	35.21	51.22	58.12	74.00	-15.88	peak



Unless otherwise agreed in writing, this document is issued by the Company subject to its General Conditions of Service printed overleaf, available on request or accessible at <https://www.sgs.com/en/Terms-and-Conditions>. Attention is drawn to the limitation of liability, indemnification and jurisdiction issues defined therein. Any holder of this document is advised that information contained hereon reflects the Company's findings at the time of its intervention only and within the limits of Client's instructions, if any. The Company's sole responsibility is to its Client and this document does not exonerate parties to a transaction from exercising all their rights and obligations under the transaction documents. This document cannot be reproduced except in full, without prior written approval of the Company. Any unauthorized alteration, forgery or falsification of the content or appearance of this document is unlawful and offenders may be prosecuted to the fullest extent of the law. Unless otherwise stated the results shown in this test report refer only to the sample(s) tested and such sample(s) are retained for 30 days only.

Attention: To check the authenticity of testing /inspection report & certificate, please contact us at telephone: (86-755) 8307 1443, or email: CN.Doccheck@sgs.com
 No.1 Workshop, M-10, Middle Section, Science & Technology Park, Nanshan District, Shenzhen, Guangdong, China 518057 t (86-755) 26012053 f (86-755) 26710594 www.sgs.com.cn
 中国·广东·深圳市南山区科技园中区M-10栋1号厂房 邮编: 518057 t (86-755) 26012053 f (86-755) 26710594 sgs.china@sgs.com

Test Mode: 22; Polarity: Horizontal; Modulation:802.11ac; Bandwidth:160MHz; Channel:middle

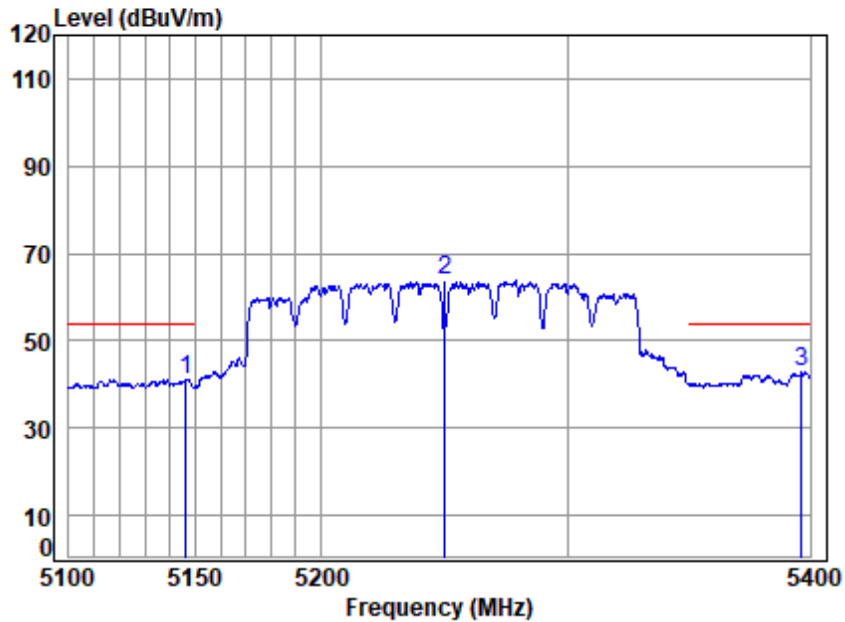

Site : chamber
 Condition: 3m HORIZONTAL
 Job No : 00955AT/00956AT
 Mode : 5250 Band edge
 : 5G WIFI 11AC160

	Freq	Cable Loss	Ant Factor	Preamp Factor	Read Level	Limit Level	Over Limit	Remark
	MHz	dB	dB/m	dB	dBuV	dBuV/m	dBuV/m	dB
1	5146.267	7.55	33.91	35.31	35.10	54.00	-12.75	Average
2	5250.000	7.63	34.10	35.26	57.33	-----	-----	Average
3 q	5396.297	7.74	34.59	35.19	35.60	54.00	-11.26	Average



Unless otherwise agreed in writing, this document is issued by the Company subject to its General Conditions of Service printed overleaf, available on request or accessible at <https://www.sgs.com/en/Terms-and-Conditions>. Attention is drawn to the limitation of liability, indemnification and jurisdiction issues defined therein. Any holder of this document is advised that information contained hereon reflects the Company's findings at the time of its intervention only and within the limits of Client's instructions, if any. The Company's sole responsibility is to its Client and this document does not exonerate parties to a transaction from exercising all their rights and obligations under the transaction documents. This document cannot be reproduced except in full, without prior written approval of the Company. Any unauthorized alteration, forgery or falsification of the content or appearance of this document is unlawful and offenders may be prosecuted to the fullest extent of the law. Unless otherwise stated the results shown in this test report refer only to the sample(s) tested and such sample(s) are retained for 30 days only.

Test Mode: 22; Polarity: Horizontal; Modulation:802.11ac; Bandwidth:160MHz; Channel:middle

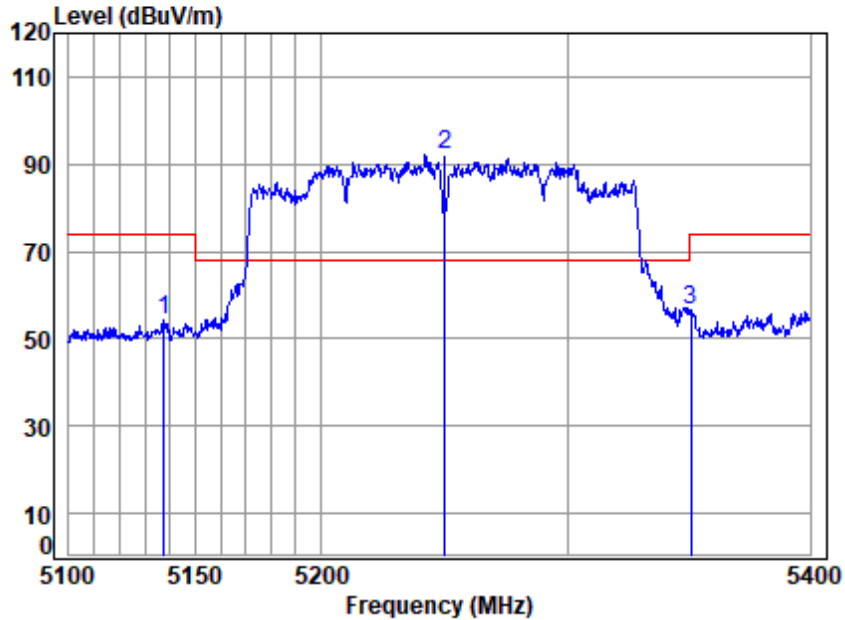

Site : chamber
 Condition: 3m VERTICAL
 Job No : 00955AT/00956AT
 Mode : 5250 Band edge
 : 5G WIFI 11AC160

	Cable	Ant	Preamp	Read	Limit	Over	
Freq	Loss	Factor	Factor	Level	Level	Line	Limit Remark
MHz	dB	dB/m	dB	dBuV	dBuV/m	dBuV/m	dB
1	7.54	33.92	35.32	48.06	54.20	74.00	-19.80 Peak
2 p	7.63	34.10	35.26	85.48	91.95	68.20	23.75 Peak
3	7.71	34.40	35.21	49.85	56.75	74.00	-17.25 Peak



Unless otherwise agreed in writing, this document is issued by the Company subject to its General Conditions of Service printed overleaf, available on request or accessible at <https://www.sgs.com/en/Terms-and-Conditions>. Attention is drawn to the limitation of liability, indemnification and jurisdiction issues defined therein. Any holder of this document is advised that information contained hereon reflects the Company's findings at the time of its intervention only and within the limits of Client's instructions, if any. The Company's sole responsibility is to its Client and this document does not exonerate parties to a transaction from exercising all their rights and obligations under the transaction documents. This document cannot be reproduced except in full, without prior written approval of the Company. Any unauthorized alteration, forgery or falsification of the content or appearance of this document is unlawful and offenders may be prosecuted to the fullest extent of the law. Unless otherwise stated the results shown in this test report refer only to the sample(s) tested and such sample(s) are retained for 30 days only.

Test Mode: 22; Polarity: Vertical; Modulation:802.11ac; Bandwidth:160MHz; Channel:middle

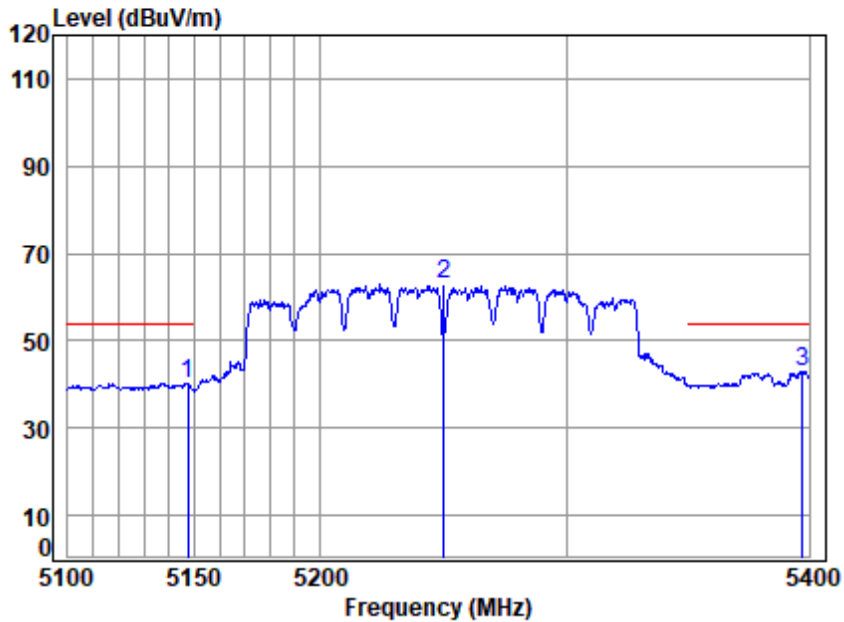

Site : chamber
 Condition: 3m VERTICAL
 Job No : 00955AT/00956AT
 Mode : 5250 Band edge
 : 5G WIFI 11AC160

	Freq	Cable Loss	Ant Factor	Preamp Factor	Read Level	Limit Level	Over Limit	Remark
	MHz	dB	dB/m	dB	dBuV	dBuV/m	dBuV/m	dB
1	5147.443	7.55	33.91	35.31	34.22	40.37	54.00	-13.63 Average
2	5250.000	7.63	34.10	35.26	56.32	62.79	-----	----- Average
3 q	5397.223	7.74	34.59	35.18	35.88	43.03	54.00	-10.97 Average



Unless otherwise agreed in writing, this document is issued by the Company subject to its General Conditions of Service printed overleaf, available on request or accessible at <https://www.sgs.com/en/Terms-and-Conditions>. Attention is drawn to the limitation of liability, indemnification and jurisdiction issues defined therein. Any holder of this document is advised that information contained hereon reflects the Company's findings at the time of its intervention only and within the limits of Client's instructions, if any. The Company's sole responsibility is to its Client and this document does not exonerate parties to a transaction from exercising all their rights and obligations under the transaction documents. This document cannot be reproduced except in full, without prior written approval of the Company. Any unauthorized alteration, forgery or falsification of the content or appearance of this document is unlawful and offenders may be prosecuted to the fullest extent of the law. Unless otherwise stated the results shown in this test report refer only to the sample(s) tested and such sample(s) are retained for 30 days only.

Test Mode: 22; Polarity: Vertical; Modulation:802.11ac; Bandwidth:160MHz; Channel:middle

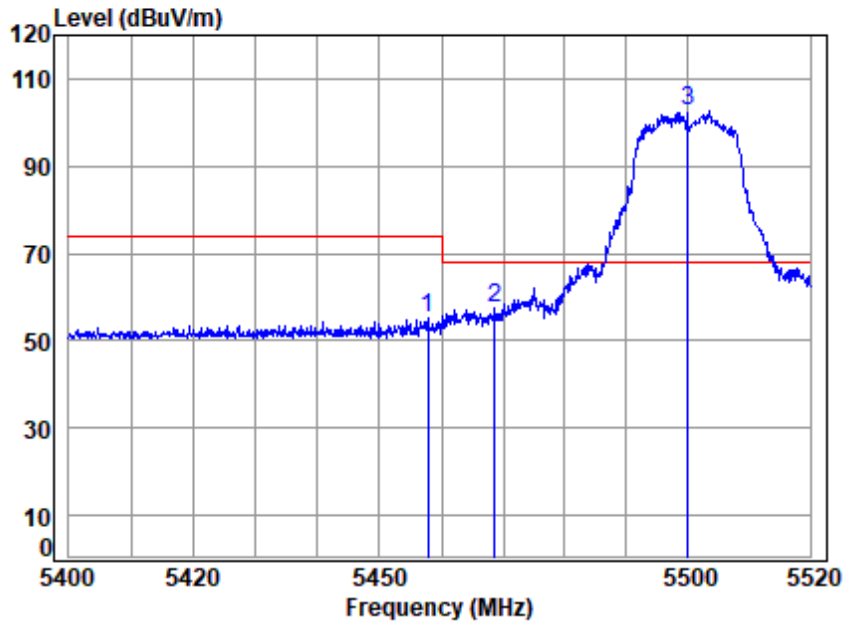

Site : chamber
 Condition: 3m HORIZONTAL
 Job No : 00955AT/00956AT
 Mode : 5500 Band edge
 : 5G WIFI 11A

	Cable	Ant	Preamp	Read	Limit	Over		
Freq	Loss	Factor	Factor	Level	Level	Line	Limit	Remark
MHz	dB	dB/m	dB	dBuV	dBuV/m	dBuV/m	dB	
1	5457.750	7.79	34.67	35.15	48.10	55.41	74.00	-18.59 peak
2	5468.557	7.79	34.63	35.15	50.32	57.59	68.20	-10.61 peak
3 p	5500.000	7.82	34.50	35.13	95.25	102.44	68.20	34.24 peak



Unless otherwise agreed in writing, this document is issued by the Company subject to its General Conditions of Service printed overleaf, available on request or accessible at <https://www.sgs.com/en/Terms-and-Conditions>. Attention is drawn to the limitation of liability, indemnification and jurisdiction issues defined therein. Any holder of this document is advised that information contained hereon reflects the Company's findings at the time of its intervention only and within the limits of Client's instructions, if any. The Company's sole responsibility is to its Client and this document does not exonerate parties to a transaction from exercising all their rights and obligations under the transaction documents. This document cannot be reproduced except in full, without prior written approval of the Company. Any unauthorized alteration, forgery or falsification of the content or appearance of this document is unlawful and offenders may be prosecuted to the fullest extent of the law. Unless otherwise stated the results shown in this test report refer only to the sample(s) tested and such sample(s) are retained for 30 days only.

Attention: To check the authenticity of testing /inspection report & certificate, please contact us at telephone: (86-755) 8307 1443, or email: CN.Doccheck@sgs.com
 No.1 Workshop, M-10, Middle Section, Science & Technology Park, Nanshan District, Shenzhen, Guangdong, China 518057 t (86-755) 26012053 f (86-755) 26710594 www.sgs.com.cn
 中国·广东·深圳市南山区科技园中区M-10栋1号厂房 邮编: 518057 t (86-755) 26012053 f (86-755) 26710594 sgs.china@sgs.com

Test Mode: 23; Polarity: Horizontal; Modulation:802.11a; Bandwidth:20MHz; Channel:Low

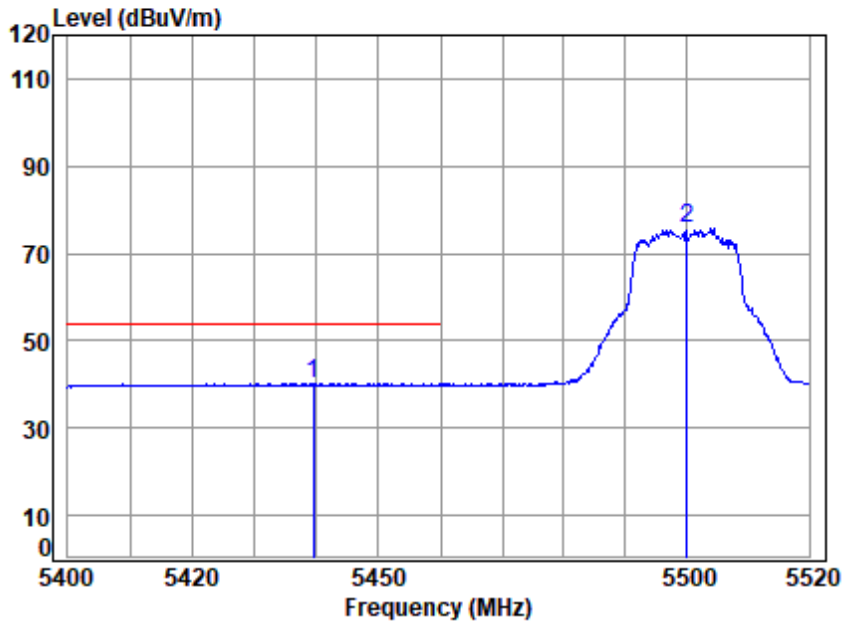

Site : chamber
 Condition: 3m HORIZONTAL
 Job No : 00955AT/00956AT
 Mode : 5500 Band edge
 : 5G WIFI 11A

	Cable	Ant	Preamp	Read	Limit	Over		
Freq	Loss	Factor	Factor	Level	Level	Line	Limit	Remark
MHz	dB	dB/m	dB	dBuV	dBuV/m	dBuV/m	dB	
1 q 5439.548	7.77	34.68	35.16	32.91	40.20	54.00	-13.80	Average
2 5500.000	7.82	34.50	35.13	68.37	75.56	-----	-----	Average



Unless otherwise agreed in writing, this document is issued by the Company subject to its General Conditions of Service printed overleaf, available on request or accessible at <https://www.sgs.com/en/Terms-and-Conditions>. Attention is drawn to the limitation of liability, indemnification and jurisdiction issues defined therein. Any holder of this document is advised that information contained hereon reflects the Company's findings at the time of its intervention only and within the limits of Client's instructions, if any. The Company's sole responsibility is to its Client and this document does not exonerate parties to a transaction from exercising all their rights and obligations under the transaction documents. This document cannot be reproduced except in full, without prior written approval of the Company. Any unauthorized alteration, forgery or falsification of the content or appearance of this document is unlawful and offenders may be prosecuted to the fullest extent of the law. Unless otherwise stated the results shown in this test report refer only to the sample(s) tested and such sample(s) are retained for 30 days only.
 Attention: To check the authenticity of testing /inspection report & certificate, please contact us at telephone: (86-755) 8307 1443, or email: CN.Doccheck@sgs.com
 No.1 Workshop, M-10, Middle Section, Science & Technology Park, Nanshan District, Shenzhen, Guangdong, China 518057 t (86-755) 26012053 f (86-755) 26710594 www.sgsgroup.com.cn
 中国·广东·深圳市南山区科技园中区M-10栋1号厂房 邮编: 518057 t (86-755) 26012053 f (86-755) 26710594 sgs.china@sgs.com

Test Mode: 23; Polarity: Horizontal; Modulation:802.11a; Bandwidth:20MHz; Channel:Low

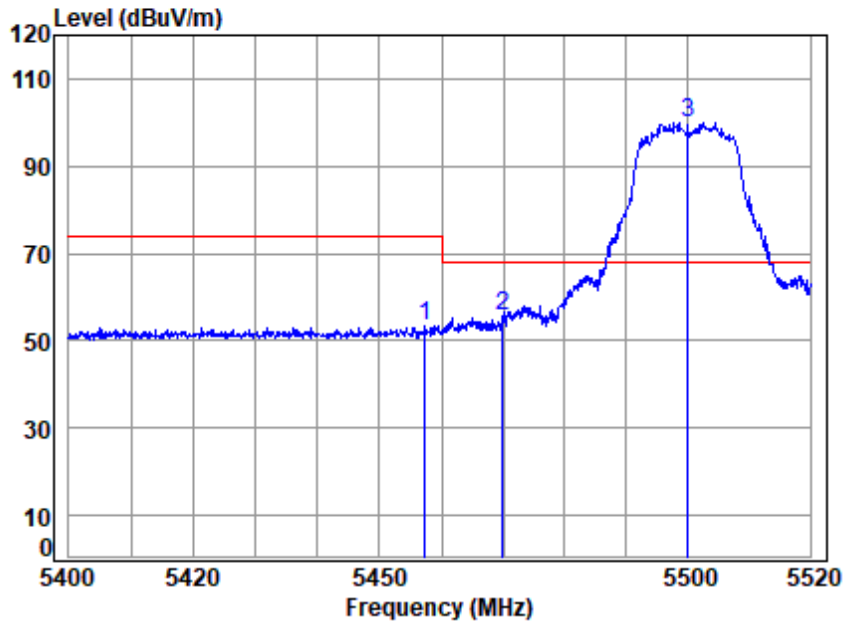

Site : chamber
 Condition: 3m VERTICAL
 Job No : 00955AT/00956AT
 Mode : 5500 Band edge
 : 5G WIFI 11A

	Cable	Ant	Preamp	Read	Limit	Over		
Freq	Loss	Factor	Factor	Level	Level	Line	Limit	Remark
MHz	dB	dB/m	dB	dBuV	dBuV/m	dBuV/m	dB	
1	5457.391	7.79	34.67	35.15	46.26	53.57	74.00	-20.43 Peak
2	5469.880	7.79	34.62	35.15	48.29	55.55	68.20	-12.65 peak
3 p	5500.000	7.82	34.50	35.13	92.76	99.95	68.20	31.75 Peak



Unless otherwise agreed in writing, this document is issued by the Company subject to its General Conditions of Service printed overleaf, available on request or accessible at <https://www.sgs.com/en/Terms-and-Conditions>. Attention is drawn to the limitation of liability, indemnification and jurisdiction issues defined therein. Any holder of this document is advised that information contained hereon reflects the Company's findings at the time of its intervention only and within the limits of Client's instructions, if any. The Company's sole responsibility is to its Client and this document does not exonerate parties to a transaction from exercising all their rights and obligations under the transaction documents. This document cannot be reproduced except in full, without prior written approval of the Company. Any unauthorized alteration, forgery or falsification of the content or appearance of this document is unlawful and offenders may be prosecuted to the fullest extent of the law. Unless otherwise stated the results shown in this test report refer only to the sample(s) tested and such sample(s) are retained for 30 days only.

Test Mode: 23; Polarity: Vertical; Modulation:802.11a; Bandwidth:20MHz; Channel:Low

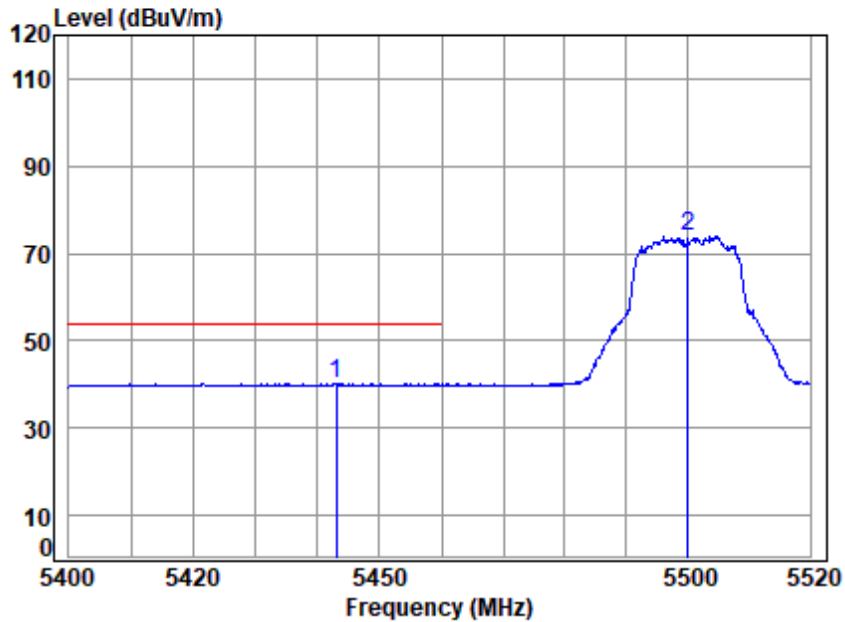

Site : chamber
 Condition: 3m VERTICAL
 Job No : 00955AT/00956AT
 Mode : 5500 Band edge
 : 5G WIFI 11A

	Cable	Ant	Preamp	Read	Limit	Over		
Freq	Loss	Factor	Factor	Level	Level	Line	Limit	Remark
MHz	dB	dB/m	dB	dBuV	dBuV/m	dBuV/m	dB	
1 q 5443.016	7.77	34.69	35.16	32.87	40.17	54.00	-13.83	Average
2 5500.000	7.82	34.50	35.13	66.78	73.97	-----	-----	Average



Unless otherwise agreed in writing, this document is issued by the Company subject to its General Conditions of Service printed overleaf, available on request or accessible at <https://www.sgs.com/en/Terms-and-Conditions>. Attention is drawn to the limitation of liability, indemnification and jurisdiction issues defined therein. Any holder of this document is advised that information contained hereon reflects the Company's findings at the time of its intervention only and within the limits of Client's instructions, if any. The Company's sole responsibility is to its Client and this document does not exonerate parties to a transaction from exercising all their rights and obligations under the transaction documents. This document cannot be reproduced except in full, without prior written approval of the Company. Any unauthorized alteration, forgery or falsification of the content or appearance of this document is unlawful and offenders may be prosecuted to the fullest extent of the law. Unless otherwise stated the results shown in this test report refer only to the sample(s) tested and such sample(s) are retained for 30 days only.
 Attention: To check the authenticity of testing /inspection report & certificate, please contact us at telephone: (86-755) 8307 1443, or email: CN.Doccheck@sgs.com
 No.1 Workshop, M-10, Middle Section, Science & Technology Park, Nanshan District, Shenzhen, Guangdong, China 518057 t (86-755) 26012053 f (86-755) 26710594 www.sgs.com.cn
 中国·广东·深圳市南山区科技园中区M-10栋1号厂房 邮编: 518057 t (86-755) 26012053 f (86-755) 26710594 sgs.china@sgs.com

Test Mode: 23; Polarity: Vertical; Modulation:802.11a; Bandwidth:20MHz; Channel:Low

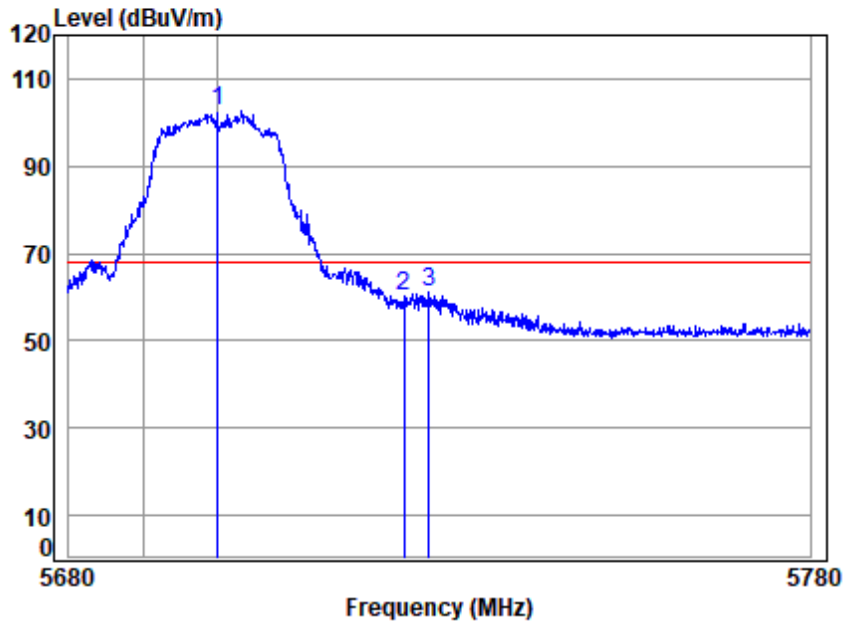

Site : chamber
 Condition: 3m HORIZONTAL
 Job No : 00955AT/00956AT
 Mode : 5700 Band edge
 : 5G WIFI 11A

	Cable	Ant	Preamp	Read	Limit	Over		
Freq	Loss	Factor	Factor	Level	Level	Line	Limit	Remark
MHz	dB	dB/m	dB	dBuV	dBuV/m	dBuV/m	dB	
1 p 5700.000	7.96	34.30	35.04	95.30	102.52	68.20	34.32	peak
2 5725.000	7.98	34.25	35.03	52.84	60.04	68.20	-8.16	peak
3 5728.382	7.98	34.24	35.02	53.76	60.96	68.20	-7.24	peak



Unless otherwise agreed in writing, this document is issued by the Company subject to its General Conditions of Service printed overleaf, available on request or accessible at <https://www.sgs.com/en/Terms-and-Conditions>. Attention is drawn to the limitation of liability, indemnification and jurisdiction issues defined therein. Any holder of this document is advised that information contained hereon reflects the Company's findings at the time of its intervention only and within the limits of Client's instructions, if any. The Company's sole responsibility is to its Client and this document does not exonerate parties to a transaction from exercising all their rights and obligations under the transaction documents. This document cannot be reproduced except in full, without prior written approval of the Company. Any unauthorized alteration, forgery or falsification of the content or appearance of this document is unlawful and offenders may be prosecuted to the fullest extent of the law. Unless otherwise stated the results shown in this test report refer only to the sample(s) tested and such sample(s) are retained for 30 days only.

Test Mode: 23; Polarity: Horizontal; Modulation:802.11a; Bandwidth:20MHz; Channel:High

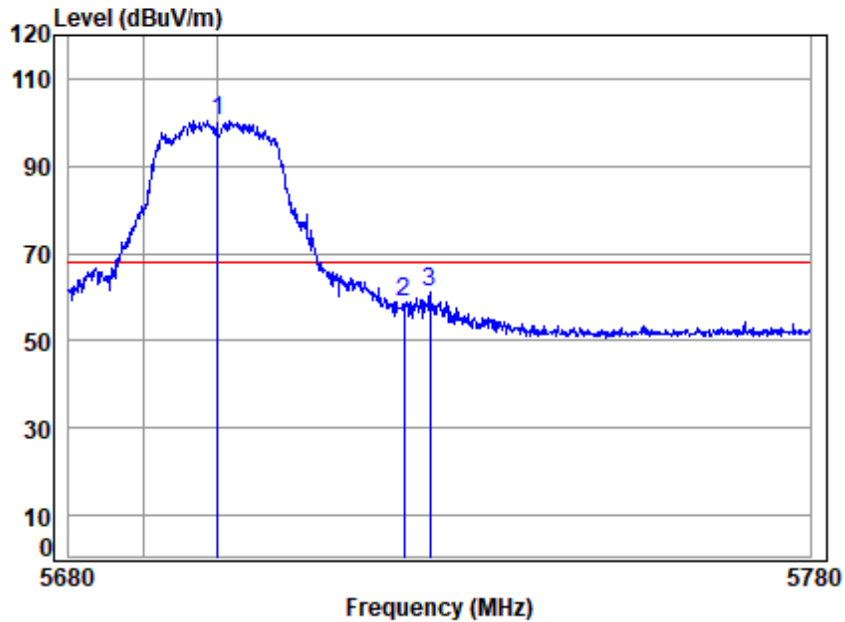

Site : chamber
 Condition: 3m VERTICAL
 Job No : 00955AT/00956AT
 Mode : 5700 Band edge
 : 5G WIFI 11A

	Cable	Ant	Preamp	Read	Limit	Over	
Freq	Loss	Factor	Factor	Level	Level	Line	Limit Remark
MHz	dB	dB/m	dB	dBuV	dBuV/m	dBuV/m	dB
1 p 5700.000	7.96	34.30	35.04	93.10	100.32	68.20	32.12 Peak
2 5725.000	7.98	34.25	35.03	51.71	58.91	68.20	-9.29 Peak
3 5728.482	7.98	34.24	35.02	53.88	61.08	68.20	-7.12 Peak



Unless otherwise agreed in writing, this document is issued by the Company subject to its General Conditions of Service printed overleaf, available on request or accessible at <https://www.sgs.com/en/Terms-and-Conditions>. Attention is drawn to the limitation of liability, indemnification and jurisdiction issues defined therein. Any holder of this document is advised that information contained hereon reflects the Company's findings at the time of its intervention only and within the limits of Client's instructions, if any. The Company's sole responsibility is to its Client and this document does not exonerate parties to a transaction from exercising all their rights and obligations under the transaction documents. This document cannot be reproduced except in full, without prior written approval of the Company. Any unauthorized alteration, forgery or falsification of the content or appearance of this document is unlawful and offenders may be prosecuted to the fullest extent of the law. Unless otherwise stated the results shown in this test report refer only to the sample(s) tested and such sample(s) are retained for 30 days only.

Test Mode: 23; Polarity: Vertical; Modulation:802.11a; Bandwidth:20MHz; Channel:High

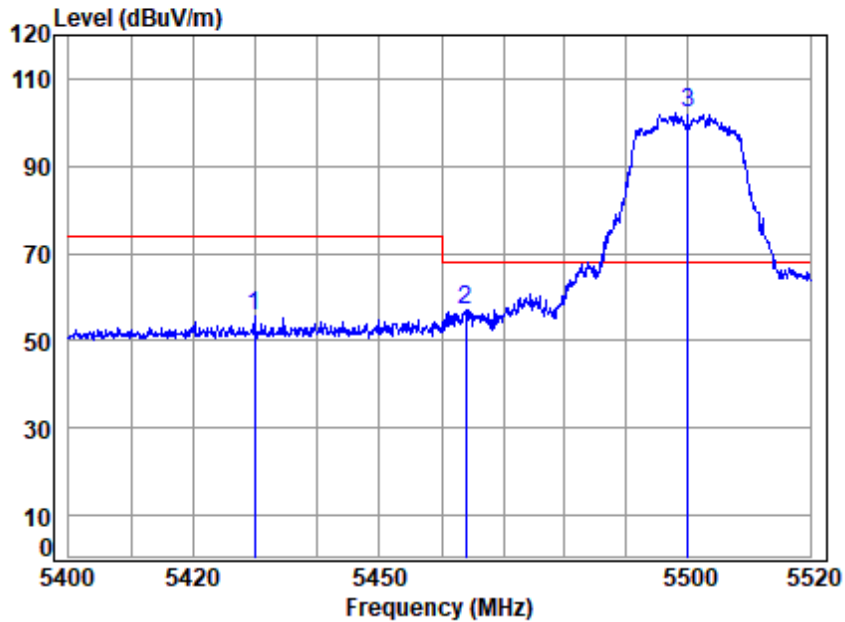

Site : chamber
 Condition: 3m HORIZONTAL
 Job No : 00955AT/00956AT
 Mode : 5500 Band edge
 : 5G WIFI 11AC20

	Cable	Ant	Preamp	Read	Limit	Over		
Freq	Loss	Factor	Factor	Level	Level	Line	Limit	Remark
MHz	dB	dB/m	dB	dBuV	dBuV/m	dBuV/m	dB	
1	7.76	34.66	35.17	48.38	55.63	74.00	-18.37	peak
2	7.79	34.64	35.15	49.81	57.09	68.20	-11.11	peak
3 p	7.82	34.50	35.13	94.92	102.11	68.20	33.91	peak



Test Mode: 23; Polarity: Horizontal; Modulation:802.11ac; Bandwidth:20MHz; Channel:Low

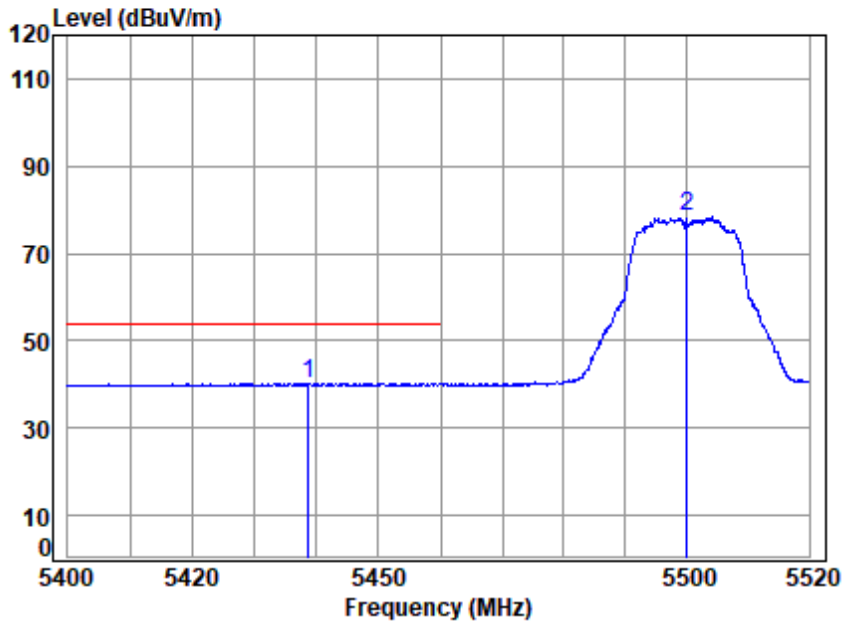

Site : chamber
 Condition: 3m HORIZONTAL
 Job No : 00955AT/00956AT
 Mode : 5500 Band edge
 : 5G WIFI 11AC20

	Cable	Ant	Preamp	Read	Limit	Over		
Freq	Loss	Factor	Factor	Level	Level	Line	Limit	Remark
MHz	dB	dB/m	dB	dBuV	dBuV/m	dBuV/m	dB	
1 q 5438.711	7.77	34.68	35.16	32.94	40.23	54.00	-13.77	Average
2 5500.000	7.82	34.50	35.13	71.12	78.31	-----	-----	Average



Unless otherwise agreed in writing, this document is issued by the Company subject to its General Conditions of Service printed overleaf, available on request or accessible at <https://www.sgs.com/en/Terms-and-Conditions>. Attention is drawn to the limitation of liability, indemnification and jurisdiction issues defined therein. Any holder of this document is advised that information contained hereon reflects the Company's findings at the time of its intervention only and within the limits of Client's instructions, if any. The Company's sole responsibility is to its Client and this document does not exonerate parties to a transaction from exercising all their rights and obligations under the transaction documents. This document cannot be reproduced except in full, without prior written approval of the Company. Any unauthorized alteration, forgery or falsification of the content or appearance of this document is unlawful and offenders may be prosecuted to the fullest extent of the law. Unless otherwise stated the results shown in this test report refer only to the sample(s) tested and such sample(s) are retained for 30 days only.
 Attention: To check the authenticity of testing /inspection report & certificate, please contact us at telephone: (86-755) 8307 1443, or email: CN.Doccheck@sgs.com
 No.1 Workshop, M-10, Middle Section, Science & Technology Park, Nanshan District, Shenzhen, Guangdong, China 518057 t (86-755) 26012053 f (86-755) 26710594 www.sgs.com.cn
 中国·广东·深圳市南山区科技园中区M-10栋1号厂房 邮编: 518057 t (86-755) 26012053 f (86-755) 26710594 sgs.china@sgs.com

Test Mode: 23; Polarity: Horizontal; Modulation:802.11ac; Bandwidth:20MHz; Channel:Low

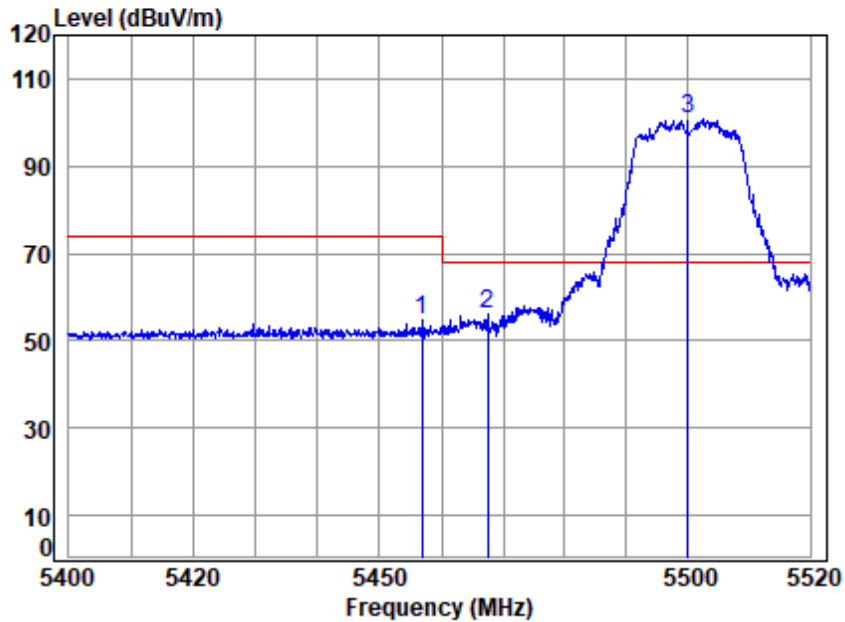

Site : chamber
 Condition: 3m VERTICAL
 Job No : 00955AT/00956AT
 Mode : 5500 Band edge
 : 5G WIFI 11AC20

	Cable	Ant	Preamp	Read	Limit	Over		
Freq	Loss	Factor	Factor	Level	Level	Line	Limit	Remark
MHz	dB	dB/m	dB	dBuV	dBuV/m	dBuV/m	dB	
1	5456.791	7.78	34.67	35.16	47.49	54.78	74.00	-19.22 Peak
2	5467.476	7.79	34.63	35.15	48.76	56.03	68.20	-12.17 peak
3 p	5500.000	7.82	34.50	35.13	93.66	100.85	68.20	32.65 Peak



Unless otherwise agreed in writing, this document is issued by the Company subject to its General Conditions of Service printed overleaf, available on request or accessible at <https://www.sgs.com/en/Terms-and-Conditions>. Attention is drawn to the limitation of liability, indemnification and jurisdiction issues defined therein. Any holder of this document is advised that information contained hereon reflects the Company's findings at the time of its intervention only and within the limits of Client's instructions, if any. The Company's sole responsibility is to its Client and this document does not exonerate parties to a transaction from exercising all their rights and obligations under the transaction documents. This document cannot be reproduced except in full, without prior written approval of the Company. Any unauthorized alteration, forgery or falsification of the content or appearance of this document is unlawful and offenders may be prosecuted to the fullest extent of the law. Unless otherwise stated the results shown in this test report refer only to the sample(s) tested and such sample(s) are retained for 30 days only.

Test Mode: 23; Polarity: Vertical; Modulation:802.11ac; Bandwidth:20MHz; Channel:Low

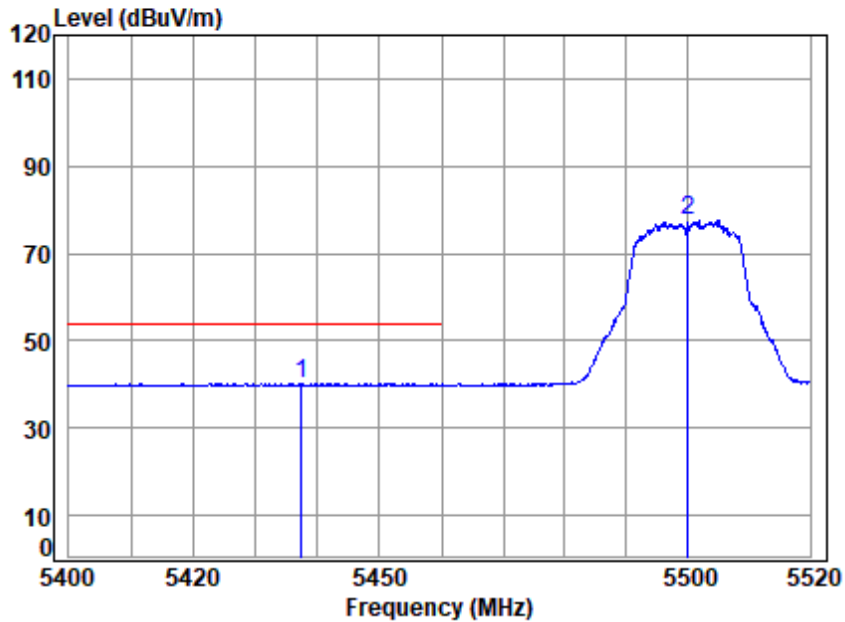

Site : chamber
 Condition: 3m VERTICAL
 Job No : 00955AT/00956AT
 Mode : 5500 Band edge
 : 5G WIFI 11AC20

	Cable	Ant	Preamp	Read	Limit	Over		
Freq	Loss	Factor	Factor	Level	Level	Line	Limit	Remark
MHz	dB	dB/m	dB	dBuV	dBuV/m	dBuV/m	dB	
1 q 5437.396	7.77	34.67	35.16	32.85	40.13	54.00	-13.87	Average
2 5500.000	7.82	34.50	35.13	70.16	77.35	-----	-----	Average



Unless otherwise agreed in writing, this document is issued by the Company subject to its General Conditions of Service printed overleaf, available on request or accessible at <https://www.sgs.com/en/Terms-and-Conditions>. Attention is drawn to the limitation of liability, indemnification and jurisdiction issues defined therein. Any holder of this document is advised that information contained hereon reflects the Company's findings at the time of its intervention only and within the limits of Client's instructions, if any. The Company's sole responsibility is to its Client and this document does not exonerate parties to a transaction from exercising all their rights and obligations under the transaction documents. This document cannot be reproduced except in full, without prior written approval of the Company. Any unauthorized alteration, forgery or falsification of the content or appearance of this document is unlawful and offenders may be prosecuted to the fullest extent of the law. Unless otherwise stated the results shown in this test report refer only to the sample(s) tested and such sample(s) are retained for 30 days only.

Test Mode: 23; Polarity: Vertical; Modulation:802.11ac; Bandwidth:20MHz; Channel:Low

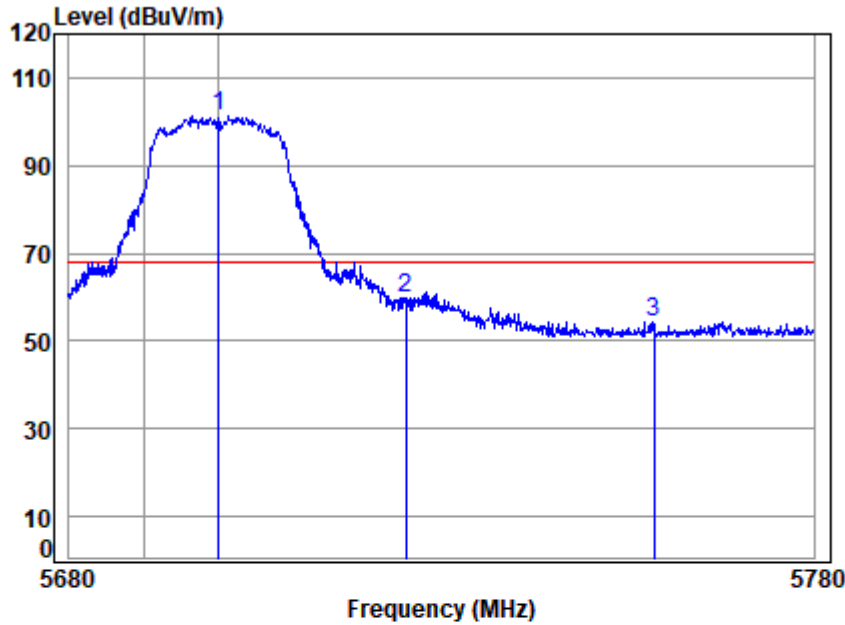

Site : chamber
 Condition: 3m HORIZONTAL
 Job No : 00955AT/00956AT
 Mode : 5700 Band edge
 : 5G WIFI 11AC20

	Cable	Ant	Preamp	Read	Limit	Over		
Freq	Loss	Factor	Factor	Level	Level	Line	Limit	Remark
MHz	dB	dB/m	dB	dBuV	dBuV/m	dBuV/m	dB	
1 p 5700.000	7.96	34.30	35.04	94.07	101.29	68.20	33.09	peak
2 5725.000	7.98	34.25	35.03	52.74	59.94	68.20	-8.26	peak
3 5758.353	8.00	34.22	35.01	47.19	54.40	68.20	-13.80	peak



Unless otherwise agreed in writing, this document is issued by the Company subject to its General Conditions of Service printed overleaf, available on request or accessible at <https://www.sgs.com/en/Terms-and-Conditions>. Attention is drawn to the limitation of liability, indemnification and jurisdiction issues defined therein. Any holder of this document is advised that information contained hereon reflects the Company's findings at the time of its intervention only and within the limits of Client's instructions, if any. The Company's sole responsibility is to its Client and this document does not exonerate parties to a transaction from exercising all their rights and obligations under the transaction documents. This document cannot be reproduced except in full, without prior written approval of the Company. Any unauthorized alteration, forgery or falsification of the content or appearance of this document is unlawful and offenders may be prosecuted to the fullest extent of the law. Unless otherwise stated the results shown in this test report refer only to the sample(s) tested and such sample(s) are retained for 30 days only.

Test Mode: 23; Polarity: Horizontal; Modulation:802.11ac; Bandwidth:20MHz; Channel:High

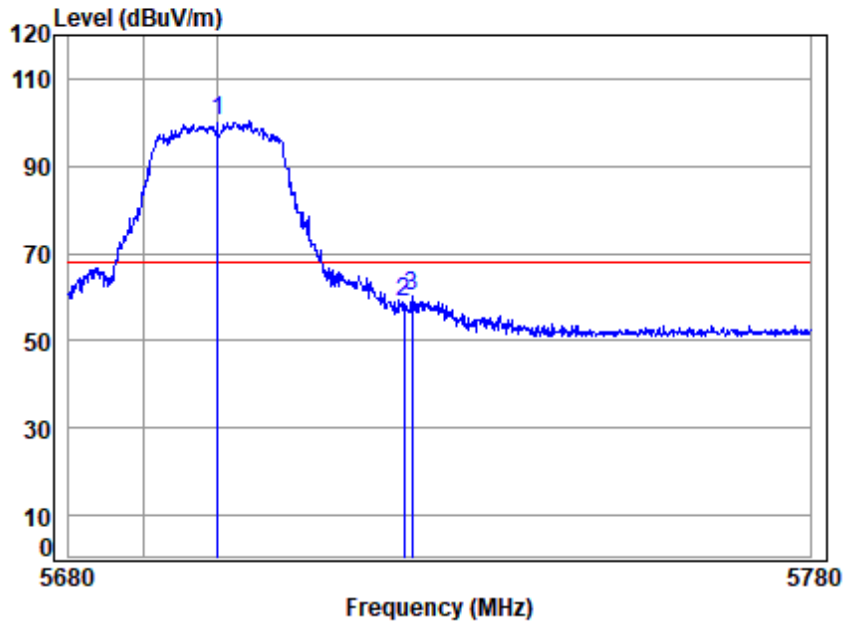

Site : chamber
 Condition: 3m VERTICAL
 Job No : 00955AT/00956AT
 Mode : 5700 Band edge
 : 5G WIFI 11AC20

	Cable	Ant	Preamp	Read	Limit	Over	
Freq	Loss	Factor	Factor	Level	Level	Line	Limit Remark
MHz	dB	dB/m	dB	dBuV	dBuV/m	dBuV/m	dB
1 p 5700.000	7.96	34.30	35.04	93.17	100.39	68.20	32.19 Peak
2 5725.000	7.98	34.25	35.03	51.78	58.98	68.20	-9.22 Peak
3 5726.083	7.98	34.25	35.03	53.09	60.29	68.20	-7.91 Peak



Unless otherwise agreed in writing, this document is issued by the Company subject to its General Conditions of Service printed overleaf, available on request or accessible at <https://www.sgs.com/en/Terms-and-Conditions>. Attention is drawn to the limitation of liability, indemnification and jurisdiction issues defined therein. Any holder of this document is advised that information contained hereon reflects the Company's findings at the time of its intervention only and within the limits of Client's instructions, if any. The Company's sole responsibility is to its Client and this document does not exonerate parties to a transaction from exercising all their rights and obligations under the transaction documents. This document cannot be reproduced except in full, without prior written approval of the Company. Any unauthorized alteration, forgery or falsification of the content or appearance of this document is unlawful and offenders may be prosecuted to the fullest extent of the law. Unless otherwise stated the results shown in this test report refer only to the sample(s) tested and such sample(s) are retained for 30 days only.

Test Mode: 23; Polarity: Vertical; Modulation:802.11ac; Bandwidth:20MHz; Channel:High

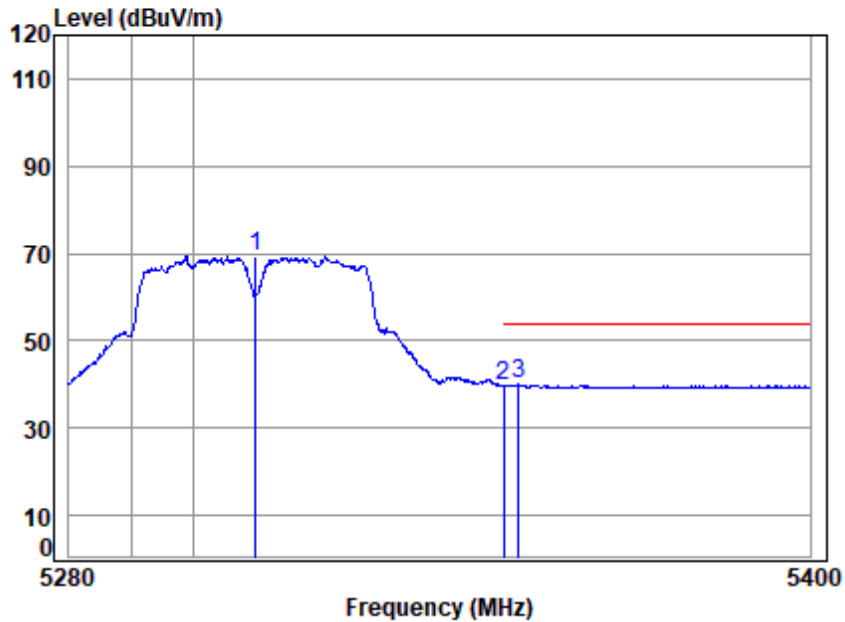

Site : chamber
 Condition: 3m VERTICAL
 Job No : 00955AT/00956AT
 Mode : 5310 Band edge
 : 5G WIFI 11AC40

	Freq	Cable Loss	Ant Factor	Preamp Factor	Read Level	Limit Level	Limit Line	Over Limit	Remark
	MHz	dB	dB/m	dB	dBuV	dBuV/m	dBuV/m	dB	
1	5310.000	7.67	34.24	35.23	62.64	69.32	-----	-----	Average
2	5350.020	7.70	34.40	35.21	32.84	39.73	54.00	-14.27	Average
3 q	5352.518	7.71	34.41	35.21	33.10	40.01	54.00	-13.99	Average



Unless otherwise agreed in writing, this document is issued by the Company subject to its General Conditions of Service printed overleaf, available on request or accessible at <https://www.sgs.com/en/Terms-and-Conditions>. Attention is drawn to the limitation of liability, indemnification and jurisdiction issues defined therein. Any holder of this document is advised that information contained hereon reflects the Company's findings at the time of its intervention only and within the limits of Client's instructions, if any. The Company's sole responsibility is to its Client and this document does not exonerate parties to a transaction from exercising all their rights and obligations under the transaction documents. This document cannot be reproduced except in full, without prior written approval of the Company. Any unauthorized alteration, forgery or falsification of the content or appearance of this document is unlawful and offenders may be prosecuted to the fullest extent of the law. Unless otherwise stated the results shown in this test report refer only to the sample(s) tested and such sample(s) are retained for 30 days only.

Test Mode: 23; Polarity: Horizontal; Modulation:802.11ac; Bandwidth:40MHz; Channel:Low

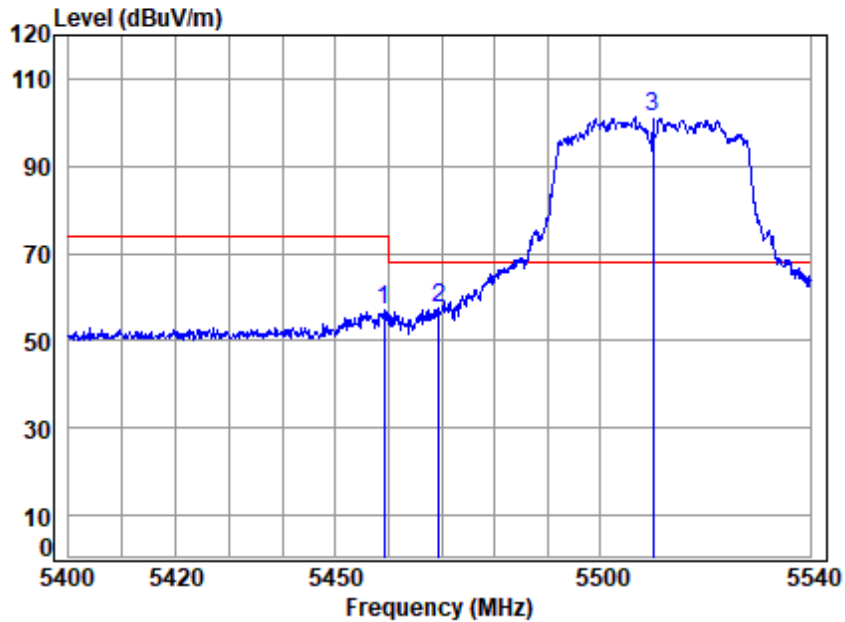

Site : chamber
 Condition: 3m HORIZONTAL
 Job No : 00955AT/00956AT
 Mode : 5510 Band edge
 : 5G WIFI 11AC40

	Cable	Ant	Preamp	Read	Limit	Over		
Freq	Loss	Factor	Factor	Level	Level	Line	Limit	Remark
MHz	dB	dB/m	dB	dBuV	dBuV/m	dBuV/m	dB	
1	7.79	34.66	35.15	49.89	57.19	74.00	-16.81	peak
2	7.79	34.62	35.15	50.37	57.63	68.20	-10.57	peak
3 p	7.82	34.54	35.13	93.86	101.09	68.20	32.89	peak



Unless otherwise agreed in writing, this document is issued by the Company subject to its General Conditions of Service printed overleaf, available on request or accessible at <https://www.sgs.com/en/Terms-and-Conditions>. Attention is drawn to the limitation of liability, indemnification and jurisdiction issues defined therein. Any holder of this document is advised that information contained hereon reflects the Company's findings at the time of its intervention only and within the limits of Client's instructions, if any. The Company's sole responsibility is to its Client and this document does not exonerate parties to a transaction from exercising all their rights and obligations under the transaction documents. This document cannot be reproduced except in full, without prior written approval of the Company. Any unauthorized alteration, forgery or falsification of the content or appearance of this document is unlawful and offenders may be prosecuted to the fullest extent of the law. Unless otherwise stated the results shown in this test report refer only to the sample(s) tested and such sample(s) are retained for 30 days only.

Test Mode: 23; Polarity: Horizontal; Modulation:802.11ac; Bandwidth:40MHz; Channel:Low

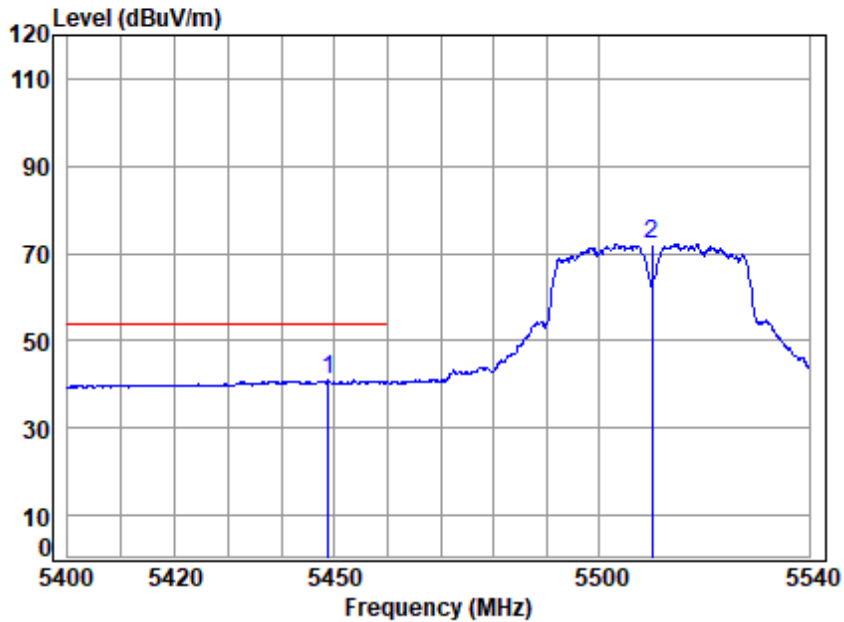

Site : chamber
 Condition: 3m HORIZONTAL
 Job No : 00955AT/00956AT
 Mode : 5510 Band edge
 : 5G WIFI 11AC40

	Cable	Ant	Preamp	Read	Limit	Over		
Freq	Loss	Factor	Factor	Level	Level	Line	Limit	Remark
MHz	dB	dB/m	dB	dBuV	dBuV/m	dBuV/m	dB	
1 q 5448.732	7.78	34.70	35.16	33.60	40.92	54.00	-13.08	Average
2 5510.000	7.82	34.54	35.13	64.95	72.18	-----	-----	Average



Unless otherwise agreed in writing, this document is issued by the Company subject to its General Conditions of Service printed overleaf, available on request or accessible at <https://www.sgs.com/en/Terms-and-Conditions>. Attention is drawn to the limitation of liability, indemnification and jurisdiction issues defined therein. Any holder of this document is advised that information contained hereon reflects the Company's findings at the time of its intervention only and within the limits of Client's instructions, if any. The Company's sole responsibility is to its Client and this document does not exonerate parties to a transaction from exercising all their rights and obligations under the transaction documents. This document cannot be reproduced except in full, without prior written approval of the Company. Any unauthorized alteration, forgery or falsification of the content or appearance of this document is unlawful and offenders may be prosecuted to the fullest extent of the law. Unless otherwise stated the results shown in this test report refer only to the sample(s) tested and such sample(s) are retained for 30 days only.

Test Mode: 23; Polarity: Vertical; Modulation:802.11ac; Bandwidth:40MHz; Channel:Low

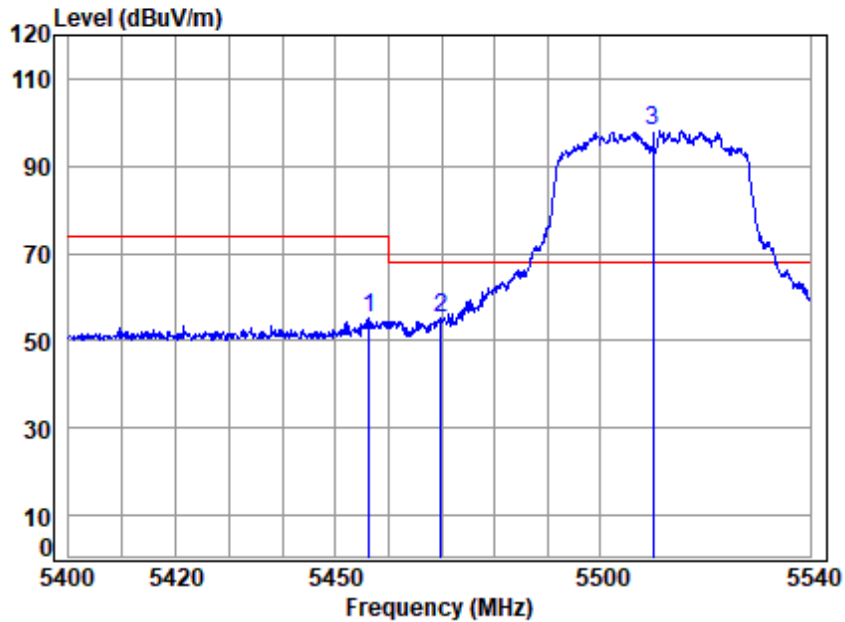

Site : chamber
 Condition: 3m VERTICAL
 Job No : 00955AT/00956AT
 Mode : 5510 Band edge
 : 5G WIFI 11AC40

	Cable	Ant	Preamp	Read	Limit	Over		
Freq	Loss	Factor	Factor	Level	Level	Line	Limit	Remark
MHz	dB	dB/m	dB	dBuV	dBuV/m	dBuV/m	dB	
1	5456.269	7.78	34.67	35.16	47.92	55.21	74.00	-18.79 Peak
2	5469.832	7.79	34.62	35.15	47.97	55.23	68.20	-12.97 peak
3 p	5510.000	7.82	34.54	35.13	90.75	97.98	68.20	29.78 Peak



Unless otherwise agreed in writing, this document is issued by the Company subject to its General Conditions of Service printed overleaf, available on request or accessible at <https://www.sgs.com/en/Terms-and-Conditions>. Attention is drawn to the limitation of liability, indemnification and jurisdiction issues defined therein. Any holder of this document is advised that information contained hereon reflects the Company's findings at the time of its intervention only and within the limits of Client's instructions, if any. The Company's sole responsibility is to its Client and this document does not exonerate parties to a transaction from exercising all their rights and obligations under the transaction documents. This document cannot be reproduced except in full, without prior written approval of the Company. Any unauthorized alteration, forgery or falsification of the content or appearance of this document is unlawful and offenders may be prosecuted to the fullest extent of the law. Unless otherwise stated the results shown in this test report refer only to the sample(s) tested and such sample(s) are retained for 30 days only.

Test Mode: 23; Polarity: Vertical; Modulation:802.11ac; Bandwidth:40MHz; Channel:Low

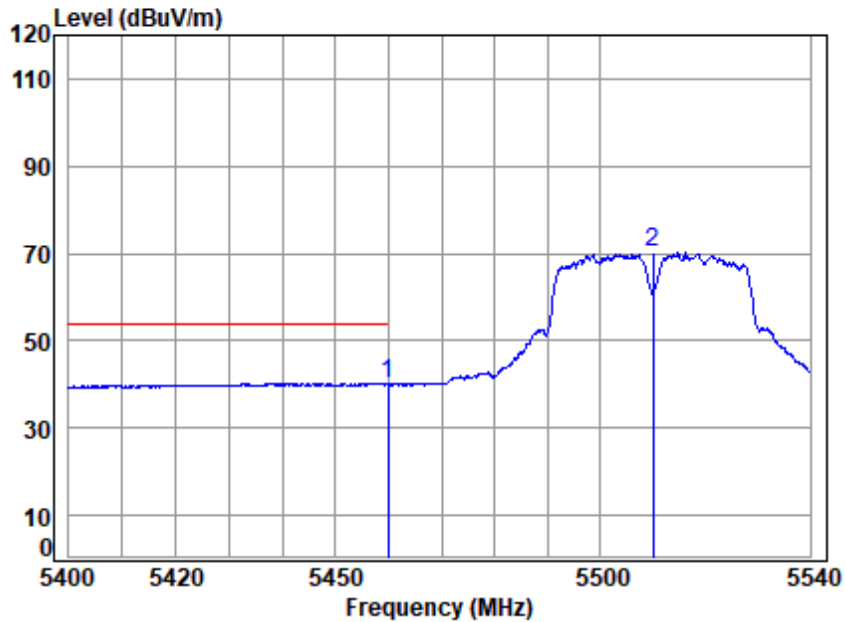

Site : chamber
 Condition: 3m VERTICAL
 Job No : 00955AT/00956AT
 Mode : 5510 Band edge
 : 5G WIFI 11AC40

	Cable	Ant	Preamp	Read	Limit	Over		
Freq	Loss	Factor	Factor	Level	Level	Line	Limit	Remark
MHz	dB	dB/m	dB	dBuV	dBuV/m	dBuV/m	dB	
1 q 5459.901	7.79	34.66	35.15	32.95	40.25	54.00	-13.75	Average
2 5510.000	7.82	34.54	35.13	62.86	70.09	-----	-----	Average



Unless otherwise agreed in writing, this document is issued by the Company subject to its General Conditions of Service printed overleaf, available on request or accessible at <https://www.sgs.com/en/Terms-and-Conditions>. Attention is drawn to the limitation of liability, indemnification and jurisdiction issues defined therein. Any holder of this document is advised that information contained hereon reflects the Company's findings at the time of its intervention only and within the limits of Client's instructions, if any. The Company's sole responsibility is to its Client and this document does not exonerate parties to a transaction from exercising all their rights and obligations under the transaction documents. This document cannot be reproduced except in full, without prior written approval of the Company. Any unauthorized alteration, forgery or falsification of the content or appearance of this document is unlawful and offenders may be prosecuted to the fullest extent of the law. Unless otherwise stated the results shown in this test report refer only to the sample(s) tested and such sample(s) are retained for 30 days only.

Attention: To check the authenticity of testing /inspection report & certificate, please contact us at telephone: (86-755) 8307 1443, or email: CN.Doccheck@sgs.com
 No.1 Workshop, M-10, Middle Section, Science & Technology Park, Nanshan District, Shenzhen, Guangdong, China 518057 t (86-755) 26012053 f (86-755) 26710594 www.sgs.com.cn
 中国·广东·深圳市南山区科技园中区M-10栋1号厂房 邮编: 518057 t (86-755) 26012053 f (86-755) 26710594 sgs.china@sgs.com

Test Mode: 23; Polarity: Horizontal; Modulation:802.11ac; Bandwidth:40MHz; Channel:High

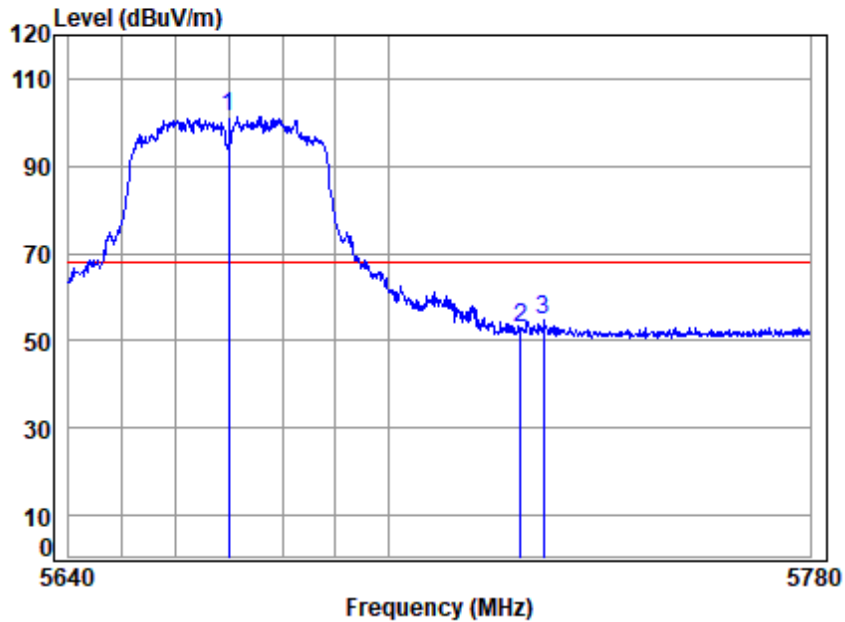

Site : chamber
 Condition: 3m HORIZONTAL
 Job No : 00955AT/00956AT
 Mode : 5670 Band edge
 : 5G WIFI 11AC40

	Cable	Ant	Preamp	Read	Limit	Over		
Freq	Loss	Factor	Factor	Level	Level	Line	Limit	Remark
MHz	dB	dB/m	dB	dBuV	dBuV/m	dBuV/m	dB	
1 p 5670.000	7.94	34.36	35.05	94.10	101.35	68.20	33.15	peak
2 5725.000	7.98	34.25	35.03	45.84	53.04	68.20	-15.16	peak
3 5729.345	7.98	34.24	35.02	47.37	54.57	68.20	-13.63	peak



Unless otherwise agreed in writing, this document is issued by the Company subject to its General Conditions of Service printed overleaf, available on request or accessible at <https://www.sgs.com/en/Terms-and-Conditions>. Attention is drawn to the limitation of liability, indemnification and jurisdiction issues defined therein. Any holder of this document is advised that information contained hereon reflects the Company's findings at the time of its intervention only and within the limits of Client's instructions, if any. The Company's sole responsibility is to its Client and this document does not exonerate parties to a transaction from exercising all their rights and obligations under the transaction documents. This document cannot be reproduced except in full, without prior written approval of the Company. Any unauthorized alteration, forgery or falsification of the content or appearance of this document is unlawful and offenders may be prosecuted to the fullest extent of the law. Unless otherwise stated the results shown in this test report refer only to the sample(s) tested and such sample(s) are retained for 30 days only.

Test Mode: 23; Polarity: Vertical; Modulation:802.11ac; Bandwidth:40MHz; Channel:High

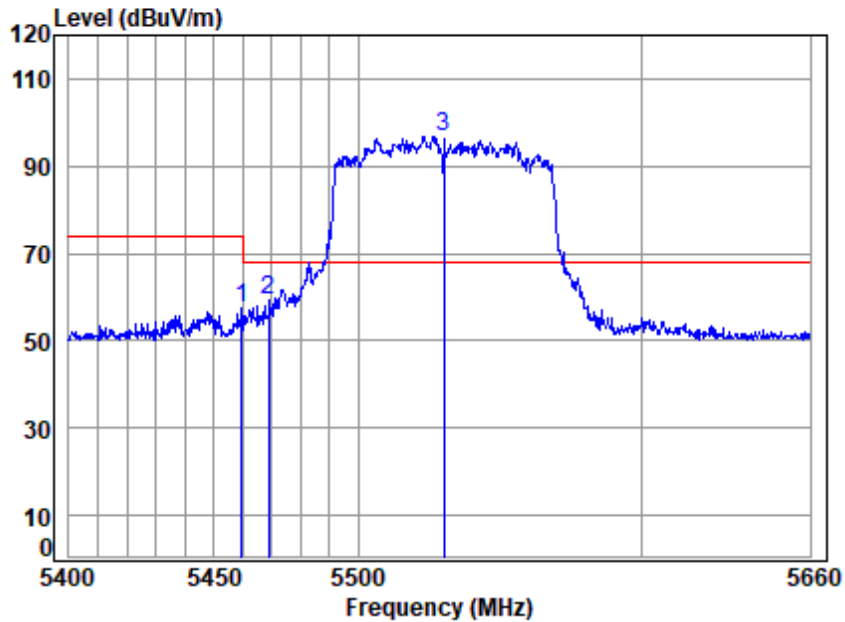

Site : chamber
 Condition: 3m HORIZONTAL
 Job No : 00955AT/00956AT
 Mode : 5530 Band edge
 : 5G WIFI 11AC80

	Cable	Ant	Preamp	Read	Limit	Over		
Freq	Loss	Factor	Factor	Level	Level	Line	Limit	Remark
MHz	dB	dB/m	dB	dBuV	dBuV/m	dBuV/m	dB	
1	5459.492	7.79	34.66	35.15	50.32	57.62	74.00	-16.38 peak
2	5469.000	7.79	34.62	35.15	51.88	59.14	68.20	-9.06 peak
3 p	5530.000	7.84	34.62	35.12	89.49	96.83	68.20	28.63 peak



Unless otherwise agreed in writing, this document is issued by the Company subject to its General Conditions of Service printed overleaf, available on request or accessible at <https://www.sgs.com/en/Terms-and-Conditions>. Attention is drawn to the limitation of liability, indemnification and jurisdiction issues defined therein. Any holder of this document is advised that information contained hereon reflects the Company's findings at the time of its intervention only and within the limits of Client's instructions, if any. The Company's sole responsibility is to its Client and this document does not exonerate parties to a transaction from exercising all their rights and obligations under the transaction documents. This document cannot be reproduced except in full, without prior written approval of the Company. Any unauthorized alteration, forgery or falsification of the content or appearance of this document is unlawful and offenders may be prosecuted to the fullest extent of the law. Unless otherwise stated the results shown in this test report refer only to the sample(s) tested and such sample(s) are retained for 30 days only.

Test Mode: 23; Polarity: Horizontal; Modulation:802.11ac; Bandwidth:80MHz; Channel:Low

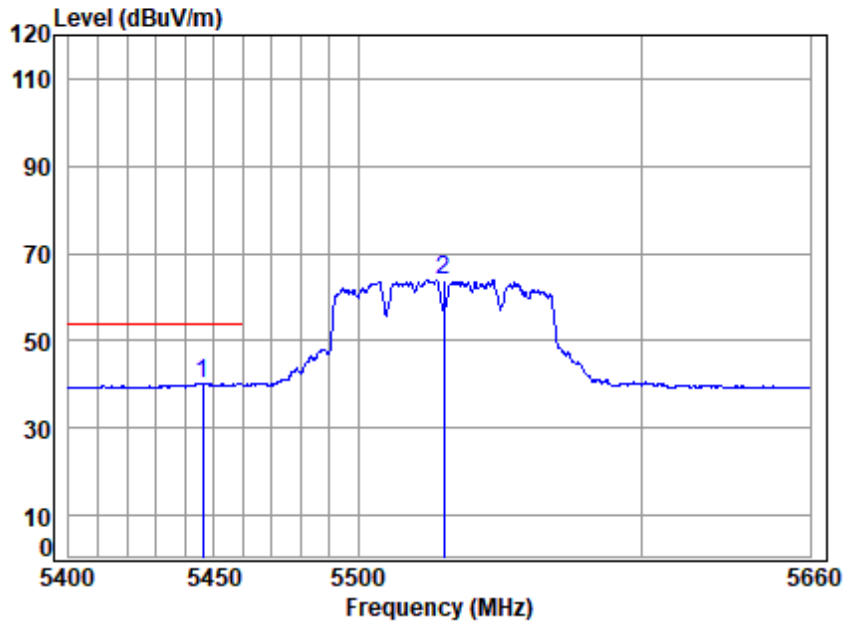

Site : chamber
 Condition: 3m HORIZONTAL
 Job No : 00955AT/00956AT
 Mode : 5530 Band edge
 : 5G WIFI 11AC80

	Cable	Ant	Preamp	Read	Limit	Over		
Freq	Loss	Factor	Factor	Level	Level	Line	Limit	Remark
MHz	dB	dB/m	dB	dBuV	dBuV/m	dBuV/m	dB	
1 q 5446.158	7.78	34.69	35.16	32.98	40.29	54.00	-13.71	Average
2 5530.000	7.84	34.62	35.12	56.74	64.08	-----	-----	Average



Unless otherwise agreed in writing, this document is issued by the Company subject to its General Conditions of Service printed overleaf, available on request or accessible at <https://www.sgs.com/en/Terms-and-Conditions>. Attention is drawn to the limitation of liability, indemnification and jurisdiction issues defined therein. Any holder of this document is advised that information contained hereon reflects the Company's findings at the time of its intervention only and within the limits of Client's instructions, if any. The Company's sole responsibility is to its Client and this document does not exonerate parties to a transaction from exercising all their rights and obligations under the transaction documents. This document cannot be reproduced except in full, without prior written approval of the Company. Any unauthorized alteration, forgery or falsification of the content or appearance of this document is unlawful and offenders may be prosecuted to the fullest extent of the law. Unless otherwise stated the results shown in this test report refer only to the sample(s) tested and such sample(s) are retained for 30 days only.

Attention: To check the authenticity of testing /inspection report & certificate, please contact us at telephone: (86-755) 8307 1443, or email: CN.Doccheck@sgs.com
 No.1 Workshop, M-10, Middle Section, Science & Technology Park, Nanshan District, Shenzhen, Guangdong, China 518057 t (86-755) 26012053 f (86-755) 26710594 www.sgs.com.cn
 中国·广东·深圳市南山区科技园中区M-10栋1号厂房 邮编: 518057 t (86-755) 26012053 f (86-755) 26710594 sgs.china@sgs.com

Test Mode: 23; Polarity: Horizontal; Modulation:802.11ac; Bandwidth:80MHz; Channel:Low

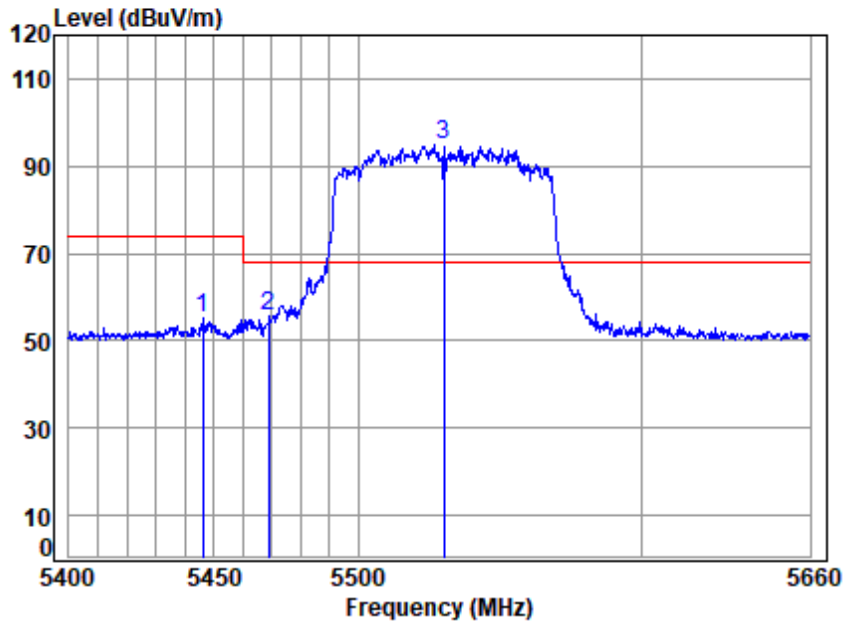

Site : chamber
 Condition: 3m VERTICAL
 Job No : 00955AT/00956AT
 Mode : 5530 Band edge
 : 5G WIFI 11AC80

	Cable	Ant	Preamp	Read	Limit	Over		
Freq	Loss	Factor	Factor	Level	Level	Line	Limit	Remark
MHz	dB	dB/m	dB	dBuV	dBuV/m	dBuV/m	dB	
1	5446.158	7.78	34.69	35.16	47.98	55.29	74.00	-18.71 Peak
2	5469.000	7.79	34.62	35.15	48.33	55.59	68.20	-12.61 peak
3 p	5530.000	7.84	34.62	35.12	87.68	95.02	68.20	26.82 Peak



Unless otherwise agreed in writing, this document is issued by the Company subject to its General Conditions of Service printed overleaf, available on request or accessible at <https://www.sgs.com/en/Terms-and-Conditions>. Attention is drawn to the limitation of liability, indemnification and jurisdiction issues defined therein. Any holder of this document is advised that information contained hereon reflects the Company's findings at the time of its intervention only and within the limits of Client's instructions, if any. The Company's sole responsibility is to its Client and this document does not exonerate parties to a transaction from exercising all their rights and obligations under the transaction documents. This document cannot be reproduced except in full, without prior written approval of the Company. Any unauthorized alteration, forgery or falsification of the content or appearance of this document is unlawful and offenders may be prosecuted to the fullest extent of the law. Unless otherwise stated the results shown in this test report refer only to the sample(s) tested and such sample(s) are retained for 30 days only.

Attention: To check the authenticity of testing /inspection report & certificate, please contact us at telephone: (86-755) 8307 1443, or email: CN.Doccheck@sgs.com
 No.1 Workshop, M-10, Middle Section, Science & Technology Park, Nanshan District, Shenzhen, Guangdong, China 518057 t (86-755) 26012053 f (86-755) 26710594 www.sgs.com.cn
 中国·广东·深圳市南山区科技园中区M-10栋1号厂房 邮编: 518057 t (86-755) 26012053 f (86-755) 26710594 sgs.china@sgs.com

Test Mode: 23; Polarity: Vertical; Modulation:802.11ac; Bandwidth:80MHz; Channel:Low

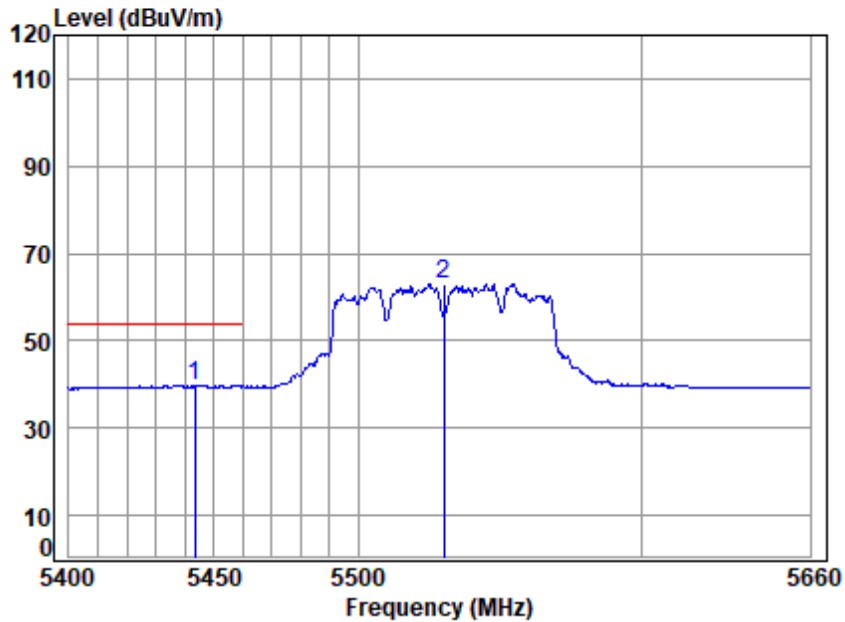

Site : chamber
 Condition: 3m VERTICAL
 Job No : 00955AT/00956AT
 Mode : 5530 Band edge
 : 5G WIFI 11AC80

	Cable	Ant	Preamp	Read	Limit	Over		
Freq	Loss	Factor	Factor	Level	Level	Line	Limit	Remark
MHz	dB	dB/m	dB	dBuV	dBuV/m	dBuV/m	dB	
1 q 5443.342	7.77	34.69	35.16	32.44	39.74	54.00	-14.26	Average
2 5530.000	7.84	34.62	35.12	55.69	63.03	-----	-----	Average



Unless otherwise agreed in writing, this document is issued by the Company subject to its General Conditions of Service printed overleaf, available on request or accessible at <https://www.sgs.com/en/Terms-and-Conditions>. Attention is drawn to the limitation of liability, indemnification and jurisdiction issues defined therein. Any holder of this document is advised that information contained hereon reflects the Company's findings at the time of its intervention only and within the limits of Client's instructions, if any. The Company's sole responsibility is to its Client and this document does not exonerate parties to a transaction from exercising all their rights and obligations under the transaction documents. This document cannot be reproduced except in full, without prior written approval of the Company. Any unauthorized alteration, forgery or falsification of the content or appearance of this document is unlawful and offenders may be prosecuted to the fullest extent of the law. Unless otherwise stated the results shown in this test report refer only to the sample(s) tested and such sample(s) are retained for 30 days only.

Attention: To check the authenticity of testing /inspection report & certificate, please contact us at telephone: (86-755) 8307 1443, or email: CN.Doccheck@sgs.com
 No.1 Workshop, M-10, Middle Section, Science & Technology Park, Nanshan District, Shenzhen, Guangdong, China 518057 t (86-755) 26012053 f (86-755) 26710594 www.sgs.com.cn
 中国·广东·深圳市南山区科技园中区M-10栋1号厂房 邮编: 518057 t (86-755) 26012053 f (86-755) 26710594 sgs.china@sgs.com

Test Mode: 23; Polarity: Vertical; Modulation:802.11ac; Bandwidth:80MHz; Channel:Low

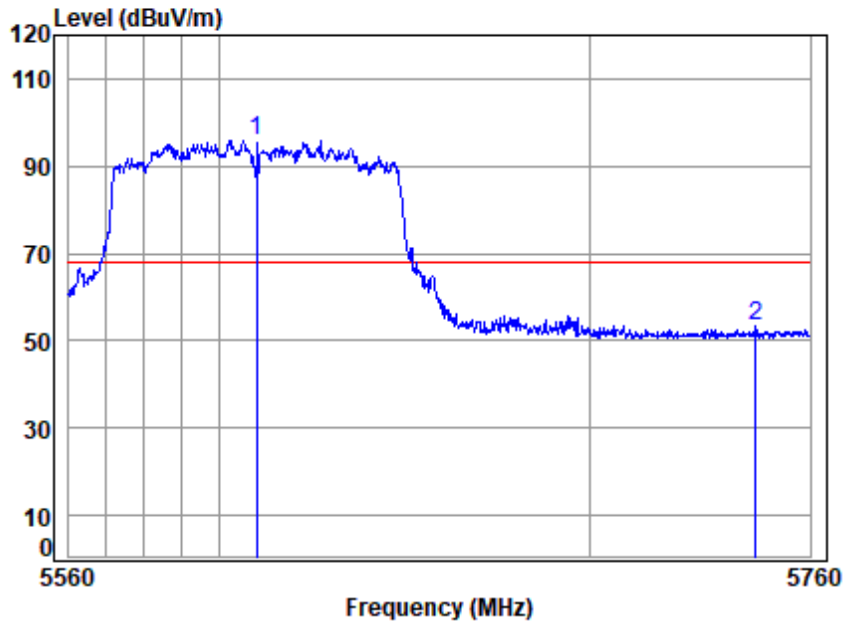

Site : chamber
 Condition: 3m HORIZONTAL
 Job No : 00955AT/00956AT
 Mode : 5610 Band edge
 : 5G WIFI 11AC80

	Cable	Ant	Preamp	Read	Limit	Over	
Freq	Loss	Factor	Factor	Level	Level	Line	Limit Remark
MHz	dB	dB/m	dB	dBuV	dBuV/m	dBuV/m	dB
1 p 5610.000	7.90	34.64	35.08	88.51	95.97	68.20	27.77 peak
2 5745.160	7.99	34.21	35.02	46.12	53.30	68.20	-14.90 peak



Unless otherwise agreed in writing, this document is issued by the Company subject to its General Conditions of Service printed overleaf, available on request or accessible at <https://www.sgs.com/en/Terms-and-Conditions>. Attention is drawn to the limitation of liability, indemnification and jurisdiction issues defined therein. Any holder of this document is advised that information contained hereon reflects the Company's findings at the time of its intervention only and within the limits of Client's instructions, if any. The Company's sole responsibility is to its Client and this document does not exonerate parties to a transaction from exercising all their rights and obligations under the transaction documents. This document cannot be reproduced except in full, without prior written approval of the Company. Any unauthorized alteration, forgery or falsification of the content or appearance of this document is unlawful and offenders may be prosecuted to the fullest extent of the law. Unless otherwise stated the results shown in this test report refer only to the sample(s) tested and such sample(s) are retained for 30 days only.
 Attention: To check the authenticity of testing /inspection report & certificate, please contact us at telephone: (86-755) 8307 1443, or email: CN.Doccheck@sgs.com
 No.1 Workshop, M-10, Middle Section, Science & Technology Park, Nanshan District, Shenzhen, Guangdong, China 518057 t (86-755) 26012053 f (86-755) 26710594 www.sgs.com.cn
 中国·广东·深圳市南山区科技园中区M-10栋1号厂房 邮编: 518057 t (86-755) 26012053 f (86-755) 26710594 sgs.china@sgs.com

Test Mode: 23; Polarity: Horizontal; Modulation:802.11ac; Bandwidth:80MHz; Channel:High

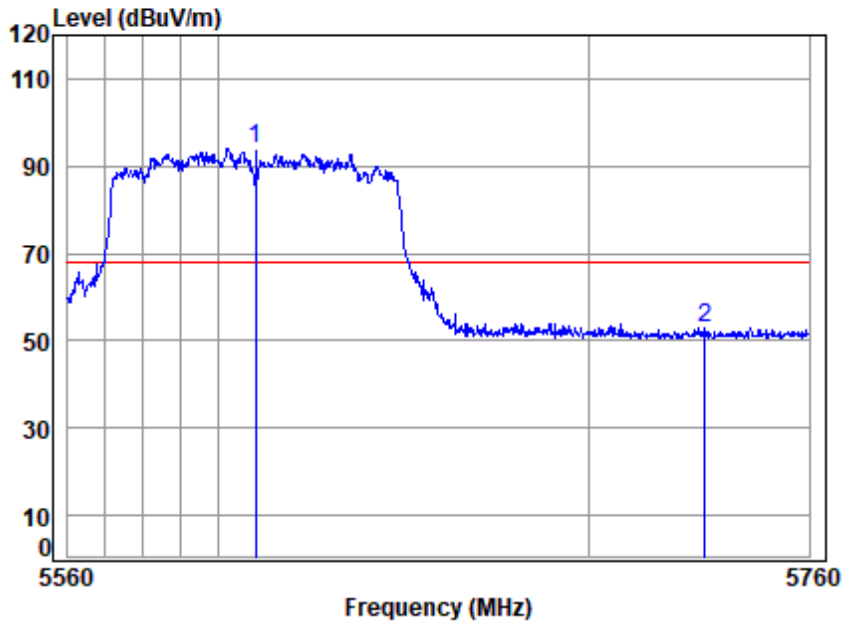

Site : chamber
 Condition: 3m VERTICAL
 Job No : 00955AT/00956AT
 Mode : 5610 Band edge
 : 5G WIFI 11AC80

	Cable	Ant	Preamp	Read	Limit	Over	
Freq	Loss	Factor	Factor	Level	Level	Line	Limit Remark
MHz	dB	dB/m	dB	dBuV	dBuV/m	dBuV/m	dB
1 p 5610.000	7.90	34.64	35.08	86.67	94.13	68.20	25.93 Peak
2 5731.573	7.98	34.24	35.02	45.81	53.01	68.20	-15.19 Peak



Unless otherwise agreed in writing, this document is issued by the Company subject to its General Conditions of Service printed overleaf, available on request or accessible at <https://www.sgs.com/en/Terms-and-Conditions>. Attention is drawn to the limitation of liability, indemnification and jurisdiction issues defined therein. Any holder of this document is advised that information contained hereon reflects the Company's findings at the time of its intervention only and within the limits of Client's instructions, if any. The Company's sole responsibility is to its Client and this document does not exonerate parties to a transaction from exercising all their rights and obligations under the transaction documents. This document cannot be reproduced except in full, without prior written approval of the Company. Any unauthorized alteration, forgery or falsification of the content or appearance of this document is unlawful and offenders may be prosecuted to the fullest extent of the law. Unless otherwise stated the results shown in this test report refer only to the sample(s) tested and such sample(s) are retained for 30 days only.
 Attention: To check the authenticity of testing /inspection report & certificate, please contact us at telephone: (86-755) 8307 1443, or email: CN.Doccheck@sgs.com

SGS-CSTC Standards Technical Services Co., Ltd. Shenzhen Branch
 No.1 Workshop, M-10, Middle Section, Science & Technology Park, Nanshan District, Shenzhen, Guangdong, China 518057 t (86-755) 26012053 f (86-755) 26710594 www.sgs.com.cn
 中国·广东·深圳市南山区科技园中区M-10栋1号厂房 邮编: 518057 t (86-755) 26012053 f (86-755) 26710594 sgs.china@sgs.com

Test Mode: 23; Polarity: Vertical; Modulation:802.11ac; Bandwidth:80MHz; Channel:High

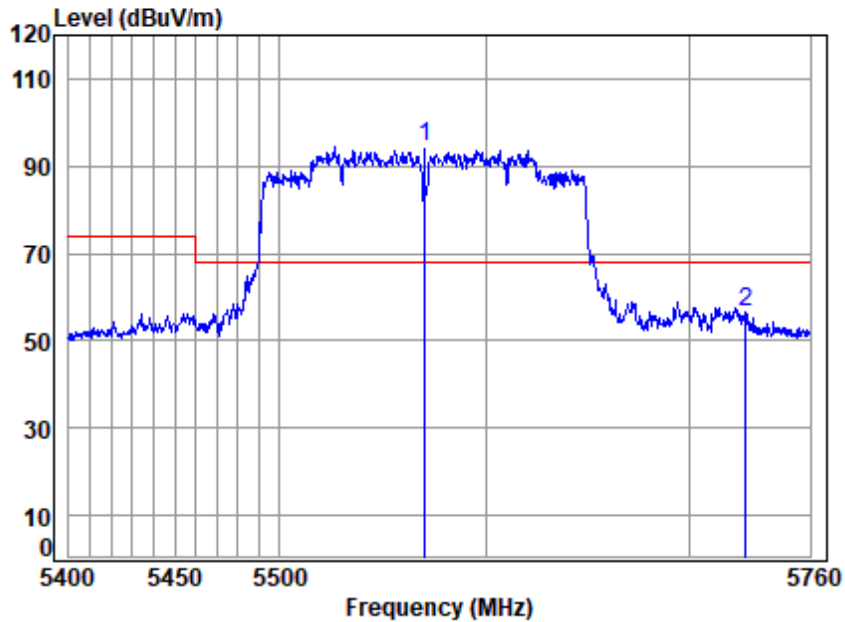

Site : chamber
 Condition: 3m HORIZONTAL
 Job No : 00955AT/00956AT
 Mode : 5570 Band edge
 : 5G WIFI 11AC160

	Cable	Ant	Preamp	Read	Limit	Over	
Freq	Loss	Factor	Factor	Level	Level	Line	Limit Remark
MHz	dB	dB/m	dB	dBuV	dBuV/m	dBuV/m	dB
1 p 5570.000	7.87	34.70	35.10	86.77	94.24	68.20	26.04 peak
2 5727.749	7.98	34.24	35.02	49.45	56.65	68.20	-11.55 peak



Unless otherwise agreed in writing, this document is issued by the Company subject to its General Conditions of Service printed overleaf, available on request or accessible at <https://www.sgs.com/en/Terms-and-Conditions>. Attention is drawn to the limitation of liability, indemnification and jurisdiction issues defined therein. Any holder of this document is advised that information contained hereon reflects the Company's findings at the time of its intervention only and within the limits of Client's instructions, if any. The Company's sole responsibility is to its Client and this document does not exonerate parties to a transaction from exercising all their rights and obligations under the transaction documents. This document cannot be reproduced except in full, without prior written approval of the Company. Any unauthorized alteration, forgery or falsification of the content or appearance of this document is unlawful and offenders may be prosecuted to the fullest extent of the law. Unless otherwise stated the results shown in this test report refer only to the sample(s) tested and such sample(s) are retained for 30 days only.

Attention: To check the authenticity of testing /inspection report & certificate, please contact us at telephone: (86-755) 8307 1443, or email: CN.Doccheck@sgs.com
 No.1 Workshop, M-10, Middle Section, Science & Technology Park, Nanshan District, Shenzhen, Guangdong, China 518057 t (86-755) 26012053 f (86-755) 26710594 www.sgs.com.cn
 中国·广东·深圳市南山区科技园中区M-10栋1号厂房 邮编: 518057 t (86-755) 26012053 f (86-755) 26710594 sgs.china@sgs.com

Test Mode: 23; Polarity: Horizontal; Modulation:802.11ac; Bandwidth:160MHz; Channel:High

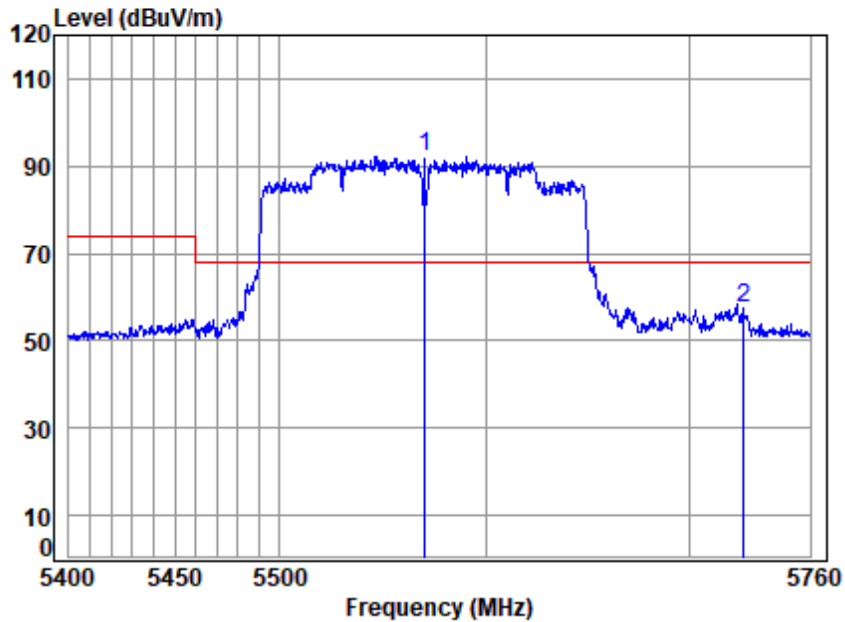

Site : chamber
 Condition: 3m VERTICAL
 Job No : 00955AT/00956AT
 Mode : 5570 Band edge
 : 5G WIFI 11AC160

	Cable	Ant	Preamp	Read	Limit	Over	
Freq	Loss	Factor	Factor	Level	Level	Line	Limit Remark
MHz	dB	dB/m	dB	dBuV	dBuV/m	dBuV/m	dB
1 p 5570.000	7.87	34.70	35.10	84.88	92.35	68.20	24.15 Peak
2 5726.640	7.98	34.25	35.03	50.13	57.33	68.20	-10.87 Peak



Unless otherwise agreed in writing, this document is issued by the Company subject to its General Conditions of Service printed overleaf, available on request or accessible at <https://www.sgs.com/en/Terms-and-Conditions>. Attention is drawn to the limitation of liability, indemnification and jurisdiction issues defined therein. Any holder of this document is advised that information contained hereon reflects the Company's findings at the time of its intervention only and within the limits of Client's instructions, if any. The Company's sole responsibility is to its Client and this document does not exonerate parties to a transaction from exercising all their rights and obligations under the transaction documents. This document cannot be reproduced except in full, without prior written approval of the Company. Any unauthorized alteration, forgery or falsification of the content or appearance of this document is unlawful and offenders may be prosecuted to the fullest extent of the law. Unless otherwise stated the results shown in this test report refer only to the sample(s) tested and such sample(s) are retained for 30 days only.

Test Mode: 23; Polarity: Vertical; Modulation:802.11ac; Bandwidth:160MHz; Channel:High

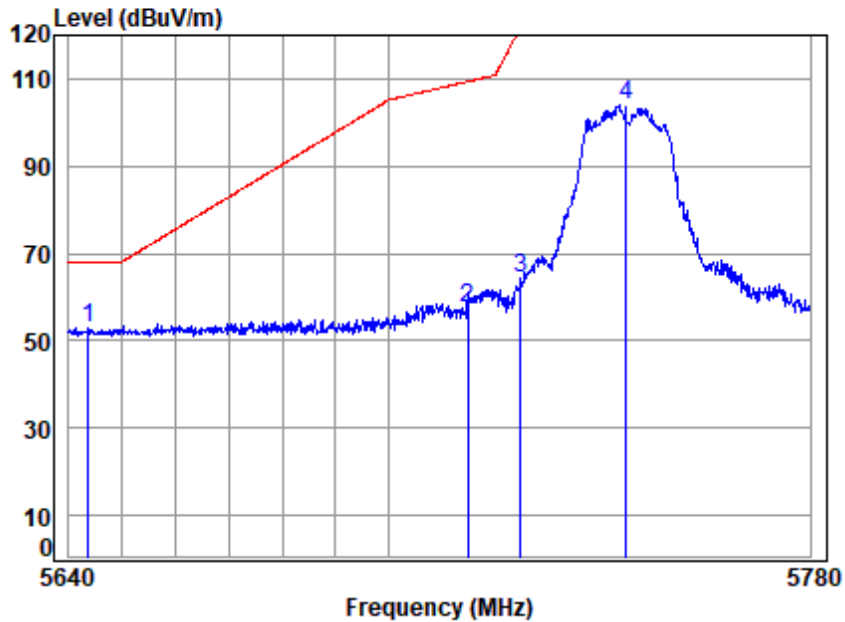

Site : chamber
 Condition: 3m HORIZONTAL
 Job No : 00955AT/00956AT
 Mode : 5745 Band edge
 : 5G WIFI 11A

	Cable	Ant	Preamp	Read	Limit	Over		
Freq	Loss	Factor	Factor	Level	Level	Line	Limit	Remark
MHz	dB	dB/m	dB	dBuV	dBuV/m	dBuV/m	dB	
1 p 5643.735	7.92	34.44	35.06	45.59	52.89	68.20	-15.31	peak
2 5715.000	7.97	34.27	35.03	50.39	57.60	109.40	-51.80	peak
3 5725.000	7.98	34.25	35.03	57.22	64.42	122.20	-57.78	peak
4 5745.000	7.99	34.21	35.02	96.76	103.94	-----	-----	peak



Test Mode: 24; Polarity: Horizontal; Modulation:802.11a; Bandwidth:20MHz; Channel:Low

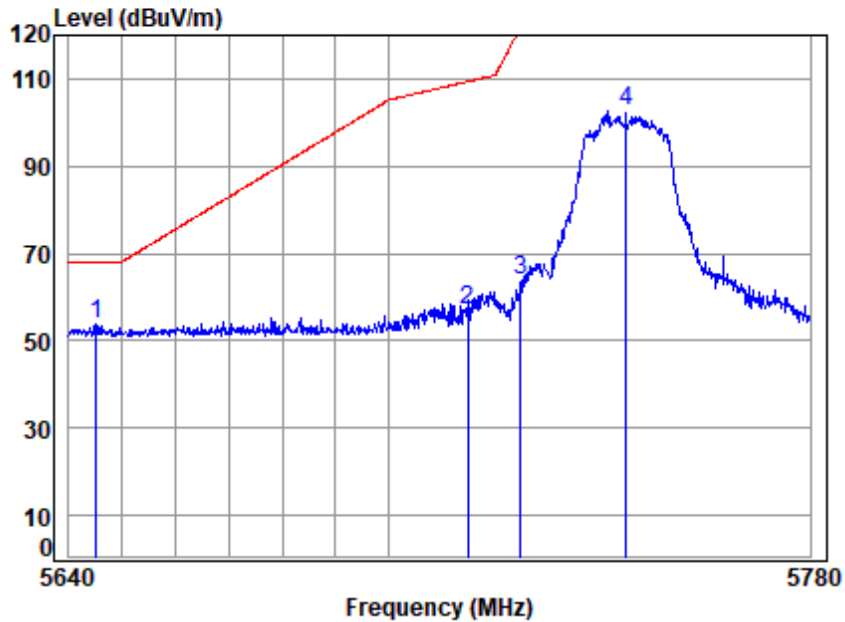

Site : chamber
 Condition: 3m VERTICAL
 Job No : 00955AT/00956AT
 Mode : 5745 Band edge
 : 5G WIFI 11A

	Cable	Ant	Preamp	Read	Limit	Over		
Freq	Loss	Factor	Factor	Level	Level	Line	Limit	Remark
MHz	dB	dB/m	dB	dBuV	dBuV/m	dBuV/m	dB	
1 p 5645.119	7.92	34.43	35.06	46.37	53.66	68.20	-14.54	peak
2 5715.000	7.97	34.27	35.03	49.78	56.99	109.40	-52.41	peak
3 5725.000	7.98	34.25	35.03	56.66	63.86	122.20	-58.34	peak
4 5745.000	7.99	34.21	35.02	95.28	102.46	-----	-----	peak



Unless otherwise agreed in writing, this document is issued by the Company subject to its General Conditions of Service printed overleaf, available on request or accessible at <https://www.sgs.com/en/Terms-and-Conditions>. Attention is drawn to the limitation of liability, indemnification and jurisdiction issues defined therein. Any holder of this document is advised that information contained hereon reflects the Company's findings at the time of its intervention only and within the limits of Client's instructions, if any. The Company's sole responsibility is to its Client and this document does not exonerate parties to a transaction from exercising all their rights and obligations under the transaction documents. This document cannot be reproduced except in full, without prior written approval of the Company. Any unauthorized alteration, forgery or falsification of the content or appearance of this document is unlawful and offenders may be prosecuted to the fullest extent of the law. Unless otherwise stated the results shown in this test report refer only to the sample(s) tested and such sample(s) are retained for 30 days only.

Test Mode: 24; Polarity: Vertical; Modulation:802.11a; Bandwidth:20MHz; Channel:Low

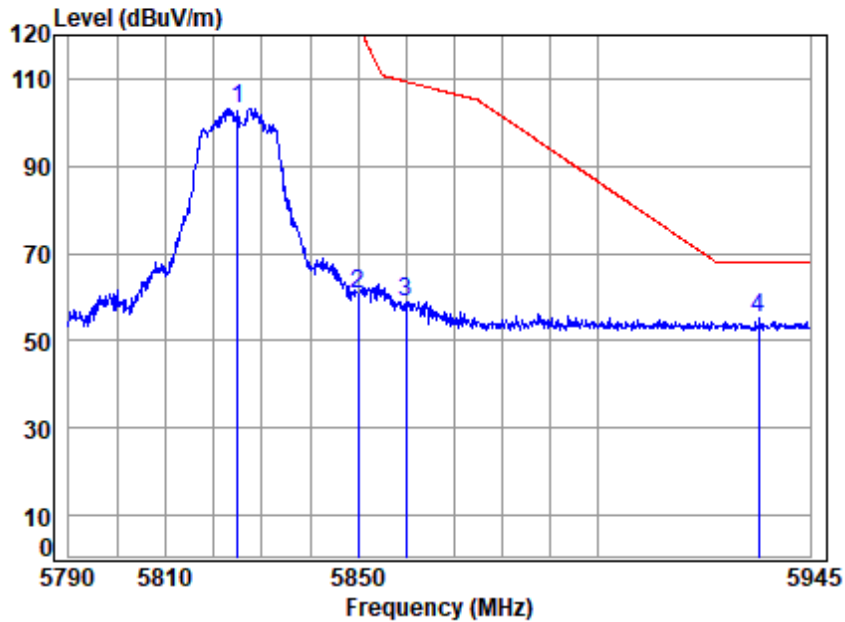

Site : chamber
 Condition: 3m HORIZONTAL
 Job No : 00955AT/00956AT
 Mode : 5825 Band edge
 : 5G WIFI 11A

	Freq	Cable Loss	Ant Factor	Preamp Factor	Read Level	Limit Level	Limit Line	Over Limit	Remark
	MHz	dB	dB/m	dB	dBuV	dBuV/m	dBuV/m	dB	
1	5825.000	8.05	34.35	34.98	95.92	103.34	-----	-----	peak
2	5850.000	8.07	34.40	34.97	53.39	60.89	122.20	-61.31	peak
3	5860.000	8.07	34.44	34.96	51.33	58.88	109.40	-50.52	peak
4 p	5934.173	8.13	34.67	34.93	47.22	55.09	68.20	-13.11	peak



Unless otherwise agreed in writing, this document is issued by the Company subject to its General Conditions of Service printed overleaf, available on request or accessible at <https://www.sgs.com/en/Terms-and-Conditions>. Attention is drawn to the limitation of liability, indemnification and jurisdiction issues defined therein. Any holder of this document is advised that information contained hereon reflects the Company's findings at the time of its intervention only and within the limits of Client's instructions, if any. The Company's sole responsibility is to its Client and this document does not exonerate parties to a transaction from exercising all their rights and obligations under the transaction documents. This document cannot be reproduced except in full, without prior written approval of the Company. Any unauthorized alteration, forgery or falsification of the content or appearance of this document is unlawful and offenders may be prosecuted to the fullest extent of the law. Unless otherwise stated the results shown in this test report refer only to the sample(s) tested and such sample(s) are retained for 30 days only.

Test Mode: 24; Polarity: Horizontal; Modulation:802.11a; Bandwidth:20MHz; Channel:High

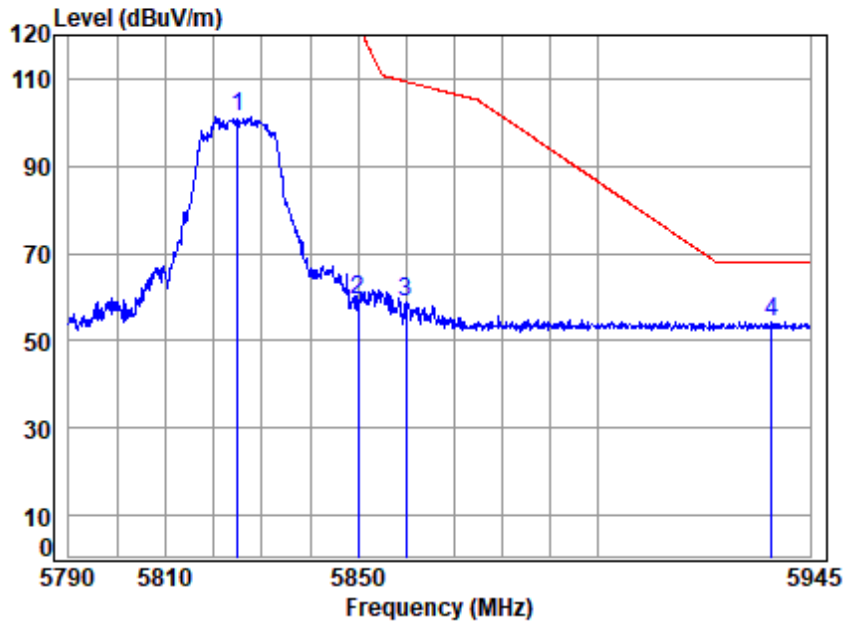

Site : chamber
 Condition: 3m VERTICAL
 Job No : 00955AT/00956AT
 Mode : 5825 Band edge
 : 5G WIFI 11A

	Freq	Cable Loss	Ant Factor	Preamp Factor	Read Level	Limit Level	Limit Line	Over Limit	Remark
	MHz	dB	dB/m	dB	dBuV	dBuV/m	dBuV/m	dB	
1	5825.000	8.05	34.35	34.98	93.82	101.24	-----	-----	peak
2	5850.000	8.07	34.40	34.97	51.66	59.16	122.20	-63.04	peak
3	5860.000	8.07	34.44	34.96	51.29	58.84	109.40	-50.56	peak
4 p	5936.839	8.13	34.67	34.93	46.56	54.43	68.20	-13.77	peak



Unless otherwise agreed in writing, this document is issued by the Company subject to its General Conditions of Service printed overleaf, available on request or accessible at <https://www.sgs.com/en/Terms-and-Conditions>. Attention is drawn to the limitation of liability, indemnification and jurisdiction issues defined therein. Any holder of this document is advised that information contained hereon reflects the Company's findings at the time of its intervention only and within the limits of Client's instructions, if any. The Company's sole responsibility is to its Client and this document does not exonerate parties to a transaction from exercising all their rights and obligations under the transaction documents. This document cannot be reproduced except in full, without prior written approval of the Company. Any unauthorized alteration, forgery or falsification of the content or appearance of this document is unlawful and offenders may be prosecuted to the fullest extent of the law. Unless otherwise stated the results shown in this test report refer only to the sample(s) tested and such sample(s) are retained for 30 days only.

Test Mode: 24; Polarity: Vertical; Modulation:802.11a; Bandwidth:20MHz; Channel:High

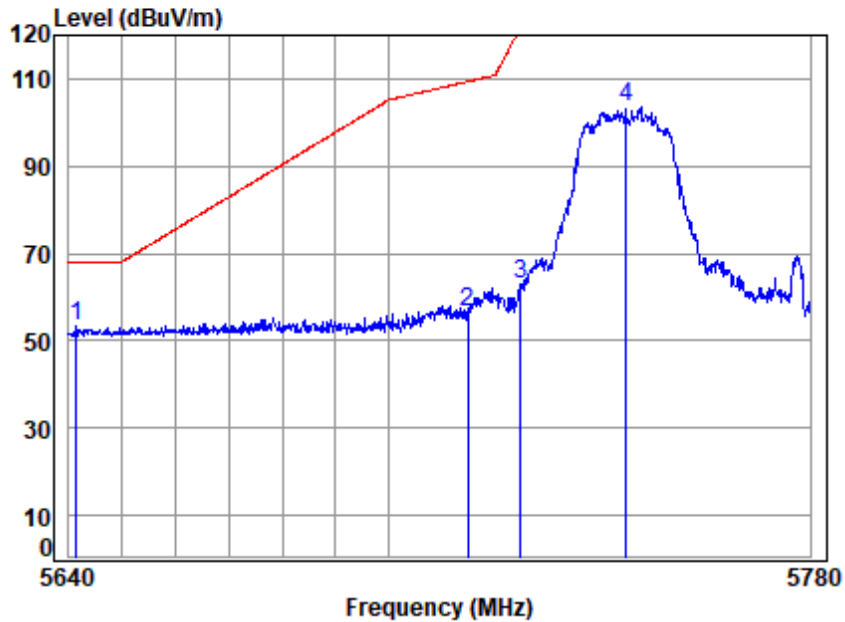

Site : chamber
 Condition: 3m HORIZONTAL
 Job No : 00955AT/00956AT
 Mode : 5745 Band edge
 : 5G WIFI 11AC20

	Cable	Ant	Preamp	Read	Limit	Over		
Freq	Loss	Factor	Factor	Level	Level	Line	Limit	Remark
MHz	dB	dB/m	dB	dBuV	dBuV/m	dBuV/m	dB	
1 p 5641.383	7.92	34.45	35.07	45.92	53.22	68.20	-14.98	peak
2 5715.000	7.97	34.27	35.03	49.39	56.60	109.40	-52.80	peak
3 5725.000	7.98	34.25	35.03	55.91	63.11	122.20	-59.09	peak
4 5745.000	7.99	34.21	35.02	96.51	103.69	-----	-----	peak



Unless otherwise agreed in writing, this document is issued by the Company subject to its General Conditions of Service printed overleaf, available on request or accessible at <https://www.sgs.com/en/Terms-and-Conditions>. Attention is drawn to the limitation of liability, indemnification and jurisdiction issues defined therein. Any holder of this document is advised that information contained hereon reflects the Company's findings at the time of its intervention only and within the limits of Client's instructions, if any. The Company's sole responsibility is to its Client and this document does not exonerate parties to a transaction from exercising all their rights and obligations under the transaction documents. This document cannot be reproduced except in full, without prior written approval of the Company. Any unauthorized alteration, forgery or falsification of the content or appearance of this document is unlawful and offenders may be prosecuted to the fullest extent of the law. Unless otherwise stated the results shown in this test report refer only to the sample(s) tested and such sample(s) are retained for 30 days only.

Test Mode: 24; Polarity: Horizontal; Modulation:802.11ac; Bandwidth:20MHz; Channel:Low

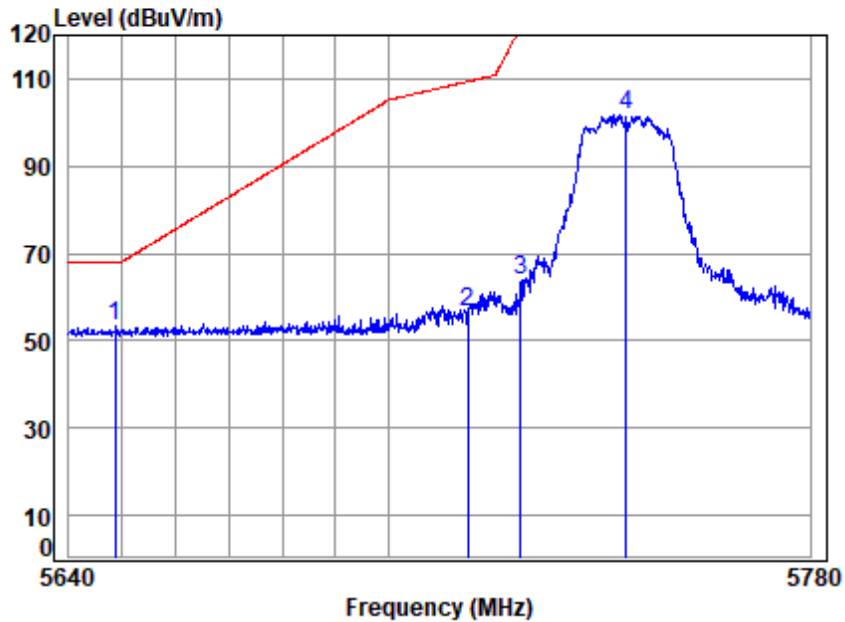

Site : chamber
 Condition: 3m VERTICAL
 Job No : 00955AT/00956AT
 Mode : 5745 Band edge
 : 5G WIFI 11AC20

	Cable	Ant	Preamp	Read	Limit	Over		
Freq	Loss	Factor	Factor	Level	Level	Line	Limit	Remark
MHz	dB	dB/m	dB	dBuV	dBuV/m	dBuV/m	dB	
1 p 5648.719	7.93	34.41	35.06	46.21	53.49	68.20	-14.71	peak
2 5715.000	7.97	34.27	35.03	49.45	56.66	109.40	-52.74	peak
3 5725.000	7.98	34.25	35.03	56.79	63.99	122.20	-58.21	peak
4 5745.000	7.99	34.21	35.02	94.79	101.97	-----	-----	peak



Test Mode: 24; Polarity: Vertical; Modulation:802.11ac; Bandwidth:20MHz; Channel:Low

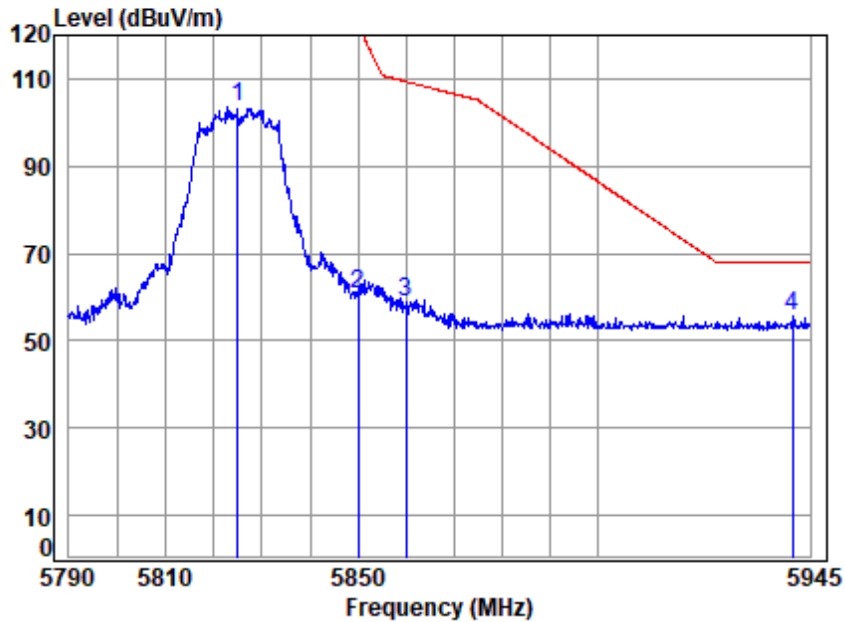

Site : chamber
 Condition: 3m HORIZONTAL
 Job No : 00955AT/00956AT
 Mode : 5825 Band edge
 : 5G WIFI 11AC20

	Freq	Cable Loss	Ant Factor	Preamp Factor	Read Level	Limit Level	Limit Line	Over Limit	Remark
	MHz	dB	dB/m	dB	dBuV	dBuV/m	dBuV/m	dB	
1	5825.000	8.05	34.35	34.98	96.10	103.52	-----	-----	peak
2	5850.000	8.07	34.40	34.97	53.06	60.56	122.20	-61.64	peak
3	5860.000	8.07	34.44	34.96	51.28	58.83	109.40	-50.57	peak
4 p	5941.389	8.13	34.68	34.93	47.70	55.58	68.20	-12.62	peak



Unless otherwise agreed in writing, this document is issued by the Company subject to its General Conditions of Service printed overleaf, available on request or accessible at <https://www.sgs.com/en/Terms-and-Conditions>. Attention is drawn to the limitation of liability, indemnification and jurisdiction issues defined therein. Any holder of this document is advised that information contained hereon reflects the Company's findings at the time of its intervention only and within the limits of Client's instructions, if any. The Company's sole responsibility is to its Client and this document does not exonerate parties to a transaction from exercising all their rights and obligations under the transaction documents. This document cannot be reproduced except in full, without prior written approval of the Company. Any unauthorized alteration, forgery or falsification of the content or appearance of this document is unlawful and offenders may be prosecuted to the fullest extent of the law. Unless otherwise stated the results shown in this test report refer only to the sample(s) tested and such sample(s) are retained for 30 days only.

Attention: To check the authenticity of testing /inspection report & certificate, please contact us at telephone: (86-755) 8307 1443, or email: CN.Doccheck@sgs.com
 No.1 Workshop, M-10, Middle Section, Science & Technology Park, Nanshan District, Shenzhen, Guangdong, China 518057 t (86-755) 26012053 f (86-755) 26710594 www.sgsgroup.com.cn
 中国·广东·深圳市南山区科技园中区M-10栋1号厂房 邮编: 518057 t (86-755) 26012053 f (86-755) 26710594 sgs.china@sgs.com

Test Mode: 24; Polarity: Horizontal; Modulation:802.11ac; Bandwidth:20MHz; Channel:High

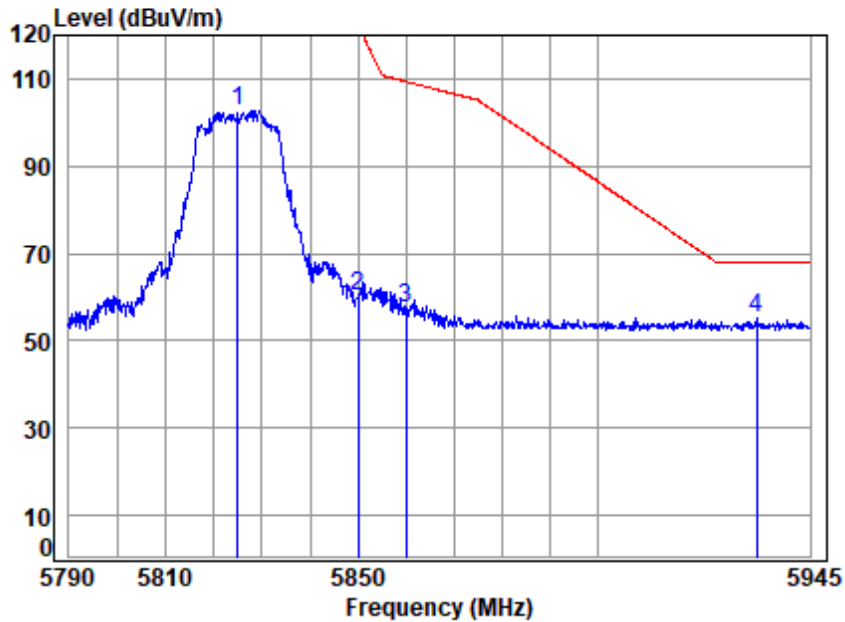

Site : chamber
 Condition: 3m VERTICAL
 Job No : 00955AT/00956AT
 Mode : 5825 Band edge
 : 5G WIFI 11AC20

	Freq	Cable Loss	Ant Factor	Preamp Factor	Read Level	Limit Level	Limit Line	Over Limit	Remark
	MHz	dB	dB/m	dB	dBuV	dBuV/m	dBuV/m	dB	
1	5825.000	8.05	34.35	34.98	95.37	102.79	-----	-----	peak
2	5850.000	8.07	34.40	34.97	52.70	60.20	122.20	-62.00	peak
3	5860.000	8.07	34.44	34.96	50.16	57.71	109.40	-51.69	peak
4 p	5933.703	8.12	34.67	34.93	47.33	55.19	68.20	-13.01	peak



Unless otherwise agreed in writing, this document is issued by the Company subject to its General Conditions of Service printed overleaf, available on request or accessible at <https://www.sgs.com/en/Terms-and-Conditions>. Attention is drawn to the limitation of liability, indemnification and jurisdiction issues defined therein. Any holder of this document is advised that information contained hereon reflects the Company's findings at the time of its intervention only and within the limits of Client's instructions, if any. The Company's sole responsibility is to its Client and this document does not exonerate parties to a transaction from exercising all their rights and obligations under the transaction documents. This document cannot be reproduced except in full, without prior written approval of the Company. Any unauthorized alteration, forgery or falsification of the content or appearance of this document is unlawful and offenders may be prosecuted to the fullest extent of the law. Unless otherwise stated the results shown in this test report refer only to the sample(s) tested and such sample(s) are retained for 30 days only.

Test Mode: 24; Polarity: Vertical; Modulation:802.11ac; Bandwidth:20MHz; Channel:High

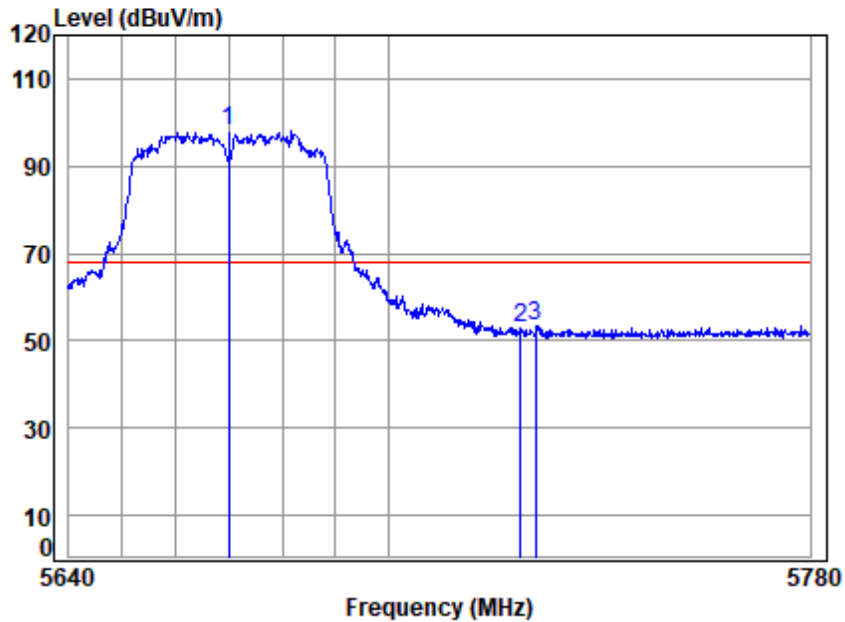

Site : chamber
 Condition: 3m VERTICAL
 Job No : 00955AT/00956AT
 Mode : 5670 Band edge
 : 5G WIFI 11AC40

	Cable	Ant	Preamp	Read	Limit	Over	
Freq	Loss	Factor	Factor	Level	Level	Line	Limit Remark
MHz	dB	dB/m	dB	dBuV	dBuV/m	dBuV/m	dB
1 p 5670.000	7.94	34.36	35.05	90.77	98.02	68.20	29.82 Peak
2 5725.000	7.98	34.25	35.03	45.93	53.13	68.20	-15.07 Peak
3 5727.799	7.98	34.24	35.02	46.07	53.27	68.20	-14.93 Peak



Test Mode: 24; Polarity: Horizontal; Modulation:802.11ac; Bandwidth:40MHz; Channel:Low

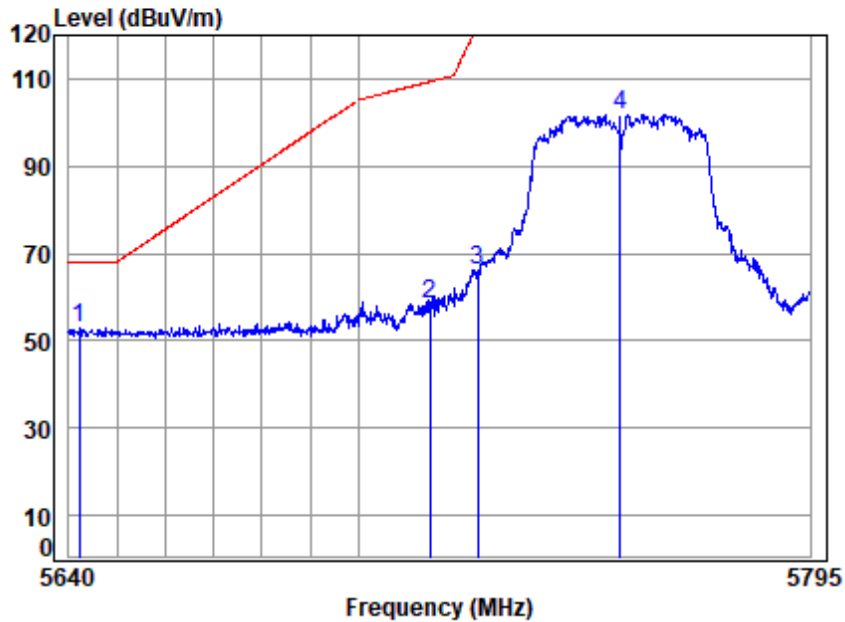

Site : chamber
 Condition: 3m HORIZONTAL
 Job No : 00955AT/00956AT
 Mode : 5755 Band edge
 : 5G WIFI 11AC40

	Cable	Ant	Preamp	Read	Limit	Over		
Freq	Loss	Factor	Factor	Level	Level	Line	Limit	Remark
MHz	dB	dB/m	dB	dBuV	dBuV/m	dBuV/m	dB	
1 p 5642.141	7.92	34.45	35.07	45.51	52.81	68.20	-15.39	peak
2 5715.000	7.97	34.27	35.03	51.13	58.34	109.40	-51.06	peak
3 5725.000	7.98	34.25	35.03	59.13	66.33	122.20	-55.87	peak
4 5755.000	8.00	34.21	35.01	94.71	101.91	-----	-----	peak



Unless otherwise agreed in writing, this document is issued by the Company subject to its General Conditions of Service printed overleaf, available on request or accessible at <https://www.sgs.com/en/Terms-and-Conditions>. Attention is drawn to the limitation of liability, indemnification and jurisdiction issues defined therein. Any holder of this document is advised that information contained hereon reflects the Company's findings at the time of its intervention only and within the limits of Client's instructions, if any. The Company's sole responsibility is to its Client and this document does not exonerate parties to a transaction from exercising all their rights and obligations under the transaction documents. This document cannot be reproduced except in full, without prior written approval of the Company. Any unauthorized alteration, forgery or falsification of the content or appearance of this document is unlawful and offenders may be prosecuted to the fullest extent of the law. Unless otherwise stated the results shown in this test report refer only to the sample(s) tested and such sample(s) are retained for 30 days only.

Test Mode: 24; Polarity: Vertical; Modulation:802.11ac; Bandwidth:40MHz; Channel:Low

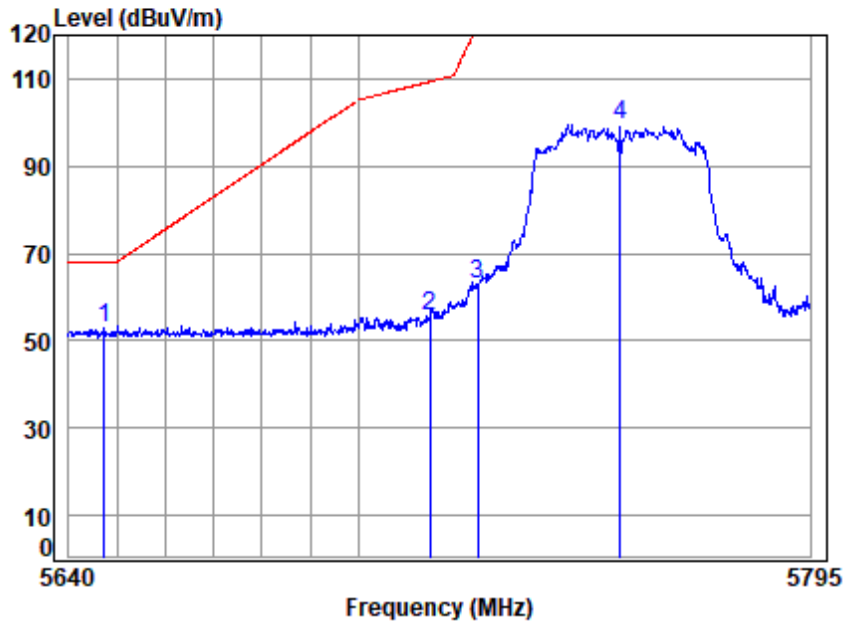

Site : chamber
 Condition: 3m VERTICAL
 Job No : 00955AT/00956AT
 Mode : 5755 Band edge
 : 5G WIFI 11AC40

	Cable	Ant	Preamp	Read	Limit	Over		
Freq	Loss	Factor	Factor	Level	Level	Line	Limit	Remark
MHz	dB	dB/m	dB	dBuV	dBuV/m	dBuV/m	dB	
1 p 5647.344	7.92	34.42	35.06	45.77	53.05	68.20	-15.15	peak
2 5715.000	7.97	34.27	35.03	48.54	55.75	109.40	-53.65	peak
3 5725.000	7.98	34.25	35.03	55.54	62.74	122.20	-59.46	peak
4 5755.000	8.00	34.21	35.01	92.25	99.45	-----	-----	peak



Unless otherwise agreed in writing, this document is issued by the Company subject to its General Conditions of Service printed overleaf, available on request or accessible at <https://www.sgs.com/en/Terms-and-Conditions>. Attention is drawn to the limitation of liability, indemnification and jurisdiction issues defined therein. Any holder of this document is advised that information contained hereon reflects the Company's findings at the time of its intervention only and within the limits of Client's instructions, if any. The Company's sole responsibility is to its Client and this document does not exonerate parties to a transaction from exercising all their rights and obligations under the transaction documents. This document cannot be reproduced except in full, without prior written approval of the Company. Any unauthorized alteration, forgery or falsification of the content or appearance of this document is unlawful and offenders may be prosecuted to the fullest extent of the law. Unless otherwise stated the results shown in this test report refer only to the sample(s) tested and such sample(s) are retained for 30 days only.

Test Mode: 24; Polarity: Horizontal; Modulation:802.11ac; Bandwidth:40MHz; Channel:High

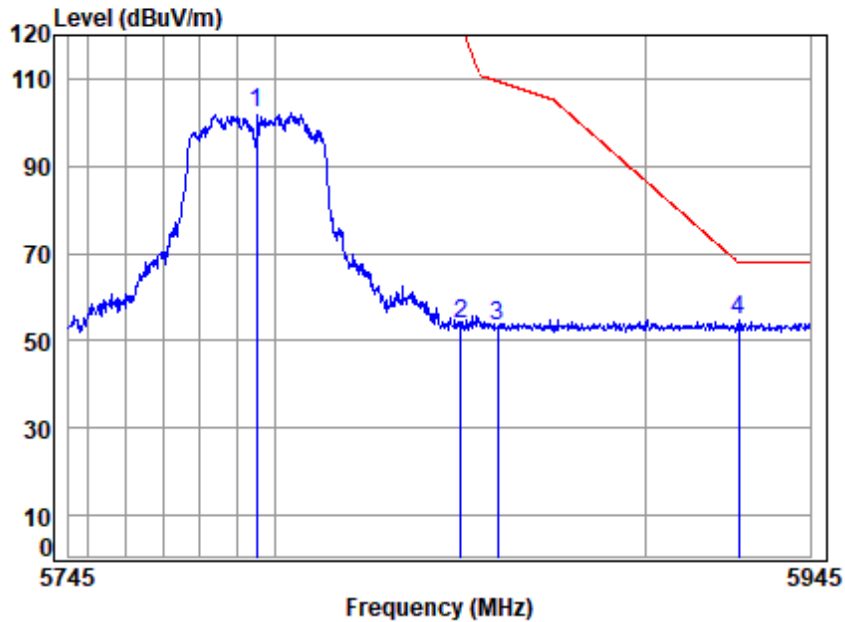

Site : chamber
 Condition: 3m HORIZONTAL
 Job No : 00955AT/00956AT
 Mode : 5795 Band edge
 : 5G WIFI 11AC40

	Freq	Cable Loss	Ant Factor	Preamp Factor	Read Level	Limit Level	Limit Line	Over Limit	Remark
	MHz	dB	dB/m	dB	dBuV	dBuV/m	dBuV/m	dB	
1	5795.000	8.03	34.29	34.99	94.75	102.08	-----	-----	peak
2	5850.000	8.07	34.40	34.97	46.51	54.01	122.20	-68.19	peak
3	5860.000	8.07	34.44	34.96	45.71	53.26	109.40	-56.14	peak
4 p	5925.501	8.12	34.65	34.93	46.91	54.75	68.20	-13.45	peak



Unless otherwise agreed in writing, this document is issued by the Company subject to its General Conditions of Service printed overleaf, available on request or accessible at <https://www.sgs.com/en/Terms-and-Conditions>. Attention is drawn to the limitation of liability, indemnification and jurisdiction issues defined therein. Any holder of this document is advised that information contained hereon reflects the Company's findings at the time of its intervention only and within the limits of Client's instructions, if any. The Company's sole responsibility is to its Client and this document does not exonerate parties to a transaction from exercising all their rights and obligations under the transaction documents. This document cannot be reproduced except in full, without prior written approval of the Company. Any unauthorized alteration, forgery or falsification of the content or appearance of this document is unlawful and offenders may be prosecuted to the fullest extent of the law. Unless otherwise stated the results shown in this test report refer only to the sample(s) tested and such sample(s) are retained for 30 days only.

Test Mode: 24; Polarity: Vertical; Modulation:802.11ac; Bandwidth:40MHz; Channel:High

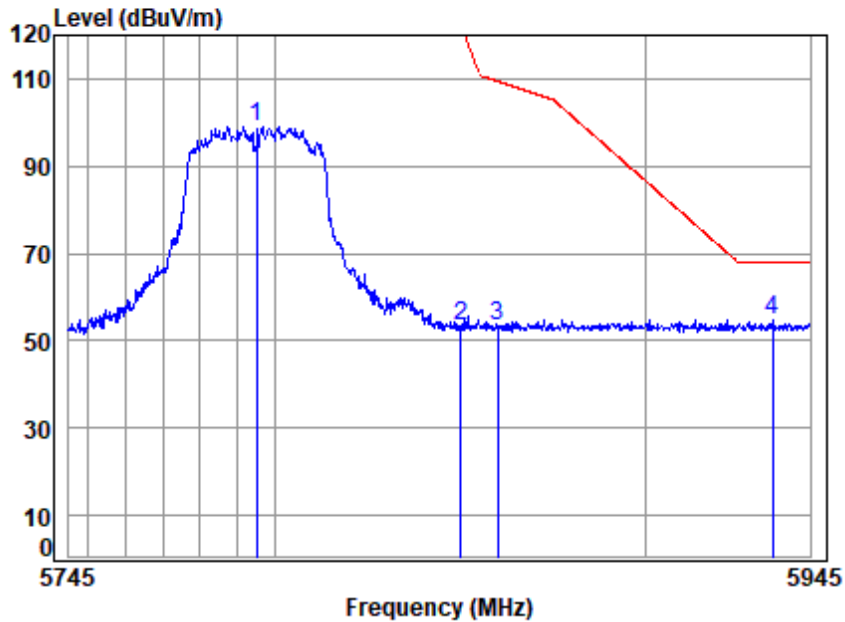

Site : chamber
 Condition: 3m VERTICAL
 Job No : 00955AT/00956AT
 Mode : 5795 Band edge
 : 5G WIFI 11AC40

	Freq	Cable Loss	Ant Factor	Preamp Factor	Read Level	Limit Level	Over Line	Over Limit	Remark
	MHz	dB	dB/m	dB	dBuV	dBuV/m	dBuV/m	dB	
1	5795.000	8.03	34.29	34.99	91.75	99.08	-----	-----	peak
2	5850.000	8.07	34.40	34.97	45.82	53.32	122.20	-68.88	peak
3	5860.000	8.07	34.44	34.96	45.64	53.19	109.40	-56.21	peak
4 p	5934.633	8.13	34.67	34.93	47.09	54.96	68.20	-13.24	peak



Unless otherwise agreed in writing, this document is issued by the Company subject to its General Conditions of Service printed overleaf, available on request or accessible at <https://www.sgs.com/en/Terms-and-Conditions>. Attention is drawn to the limitation of liability, indemnification and jurisdiction issues defined therein. Any holder of this document is advised that information contained hereon reflects the Company's findings at the time of its intervention only and within the limits of Client's instructions, if any. The Company's sole responsibility is to its Client and this document does not exonerate parties to a transaction from exercising all their rights and obligations under the transaction documents. This document cannot be reproduced except in full, without prior written approval of the Company. Any unauthorized alteration, forgery or falsification of the content or appearance of this document is unlawful and offenders may be prosecuted to the fullest extent of the law. Unless otherwise stated the results shown in this test report refer only to the sample(s) tested and such sample(s) are retained for 30 days only.

Test Mode: 24; Polarity: Horizontal; Modulation:802.11ac; Bandwidth:80MHz; Channel:middle

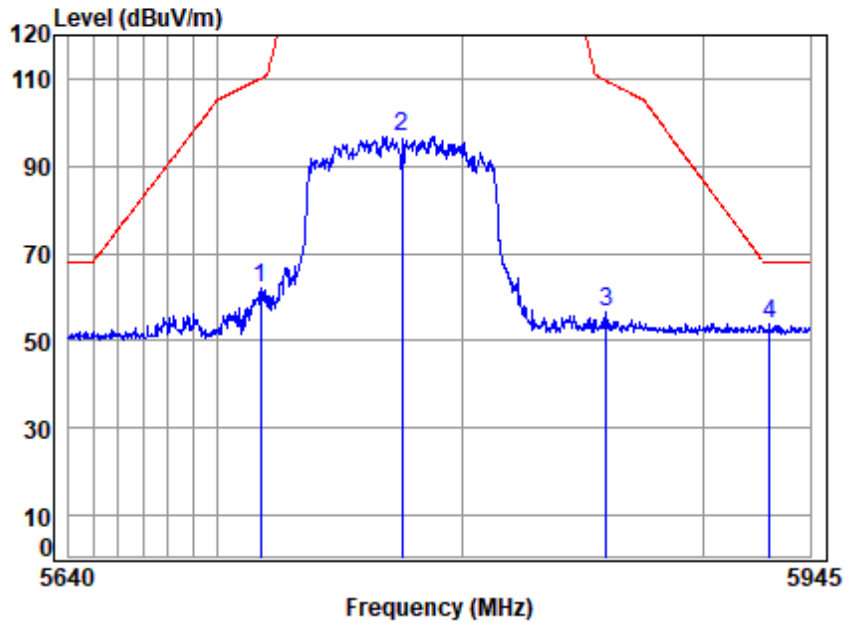

Site : chamber
 Condition: 3m HORIZONTAL
 Job No : 00955AT/00956AT
 Mode : 5775 Band edge
 : 5G WIFI 11AC80

	Cable	Ant	Preamp	Read	Limit	Over		
Freq	Loss	Factor	Factor	Level	Level	Line	Limit	Remark
MHz	dB	dB/m	dB	dBuV	dBuV/m	dBuV/m	dB	
1	7.97	34.27	35.03	54.72	61.93	110.09	-48.16	peak
2	8.01	34.25	35.00	89.48	96.74	-----	-----	peak
3	8.07	34.44	34.96	49.14	56.69	109.53	-52.84	peak
4 p	8.12	34.66	34.93	46.14	53.99	68.20	-14.21	peak



Unless otherwise agreed in writing, this document is issued by the Company subject to its General Conditions of Service printed overleaf, available on request or accessible at <https://www.sgs.com/en/Terms-and-Conditions>. Attention is drawn to the limitation of liability, indemnification and jurisdiction issues defined therein. Any holder of this document is advised that information contained hereon reflects the Company's findings at the time of its intervention only and within the limits of Client's instructions, if any. The Company's sole responsibility is to its Client and this document does not exonerate parties to a transaction from exercising all their rights and obligations under the transaction documents. This document cannot be reproduced except in full, without prior written approval of the Company. Any unauthorized alteration, forgery or falsification of the content or appearance of this document is unlawful and offenders may be prosecuted to the fullest extent of the law. Unless otherwise stated the results shown in this test report refer only to the sample(s) tested and such sample(s) are retained for 30 days only.

Attention: To check the authenticity of testing /inspection report & certificate, please contact us at telephone: (86-755) 8307 1443, or email: CN.Doccheck@sgs.com
 No.1 Workshop, M-10, Middle Section, Science & Technology Park, Nanshan District, Shenzhen, Guangdong, China 518057 t (86-755) 26012053 f (86-755) 26710594 www.sgs.com.cn
 中国·广东·深圳市南山区科技园中区M-10栋1号厂房 邮编: 518057 t (86-755) 26012053 f (86-755) 26710594 sgs.china@sgs.com

Test Mode: 24; Polarity: Vertical; Modulation:802.11ac; Bandwidth:80MHz; Channel:middle

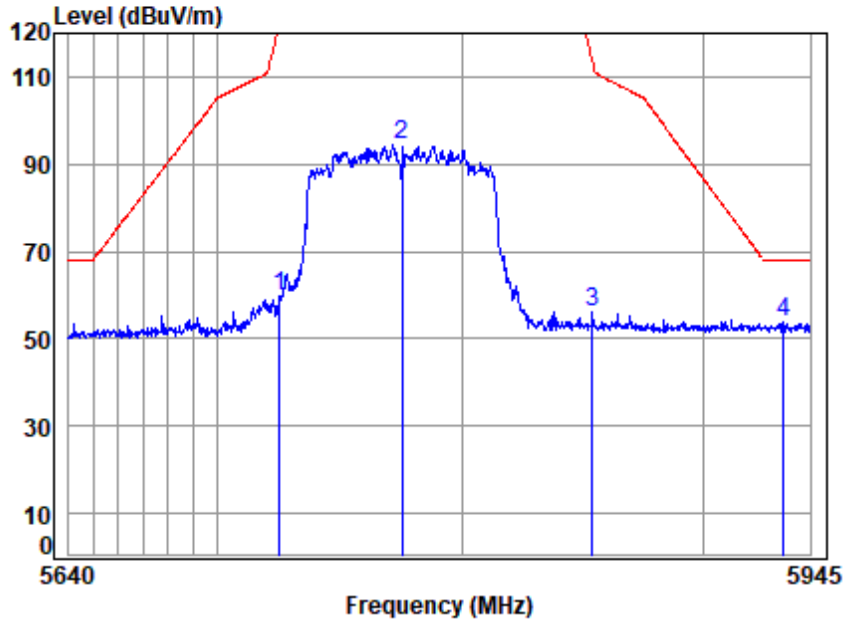

Site : chamber
 Condition: 3m VERTICAL
 Job No : 00955AT/00956AT
 Mode : 5775 Band edge
 : 5G WIFI 11AC80

	Cable	Ant	Preamp	Read	Limit	Over		
Freq	Loss	Factor	Factor	Level	Level	Line	Limit	Remark
MHz	dB	dB/m	dB	dBuV	dBuV/m	dBuV/m	dB	
1	7.98	34.25	35.03	52.35	59.55	122.18	-62.63	peak
2	8.01	34.25	35.00	87.32	94.58	-----	-----	peak
3	8.07	34.41	34.97	48.72	56.23	113.86	-57.63	peak
4 p	8.12	34.67	34.93	45.88	53.74	68.20	-14.46	peak



Unless otherwise agreed in writing, this document is issued by the Company subject to its General Conditions of Service printed overleaf, available on request or accessible at <https://www.sgs.com/en/Terms-and-Conditions>. Attention is drawn to the limitation of liability, indemnification and jurisdiction issues defined therein. Any holder of this document is advised that information contained hereon reflects the Company's findings at the time of its intervention only and within the limits of Client's instructions, if any. The Company's sole responsibility is to its Client and this document does not exonerate parties to a transaction from exercising all their rights and obligations under the transaction documents. This document cannot be reproduced except in full, without prior written approval of the Company. Any unauthorized alteration, forgery or falsification of the content or appearance of this document is unlawful and offenders may be prosecuted to the fullest extent of the law. Unless otherwise stated the results shown in this test report refer only to the sample(s) tested and such sample(s) are retained for 30 days only.

Attention: To check the authenticity of testing /inspection report & certificate, please contact us at telephone: (86-755) 8307 1443, or email: CN.Doccheck@sgs.com
 No.1 Workshop, M-10, Middle Section, Science & Technology Park, Nanshan District, Shenzhen, Guangdong, China 518057 t (86-755) 26012053 f (86-755) 26710594 www.sgs.com.cn
 中国·广东·深圳市南山区科技园中区M-10栋1号厂房 邮编: 518057 t (86-755) 26012053 f (86-755) 26710594 sgs.china@sgs.com

Test Mode: 25; Polarity: Horizontal; Modulation:802.11a; Bandwidth:20MHz; Channel:Low

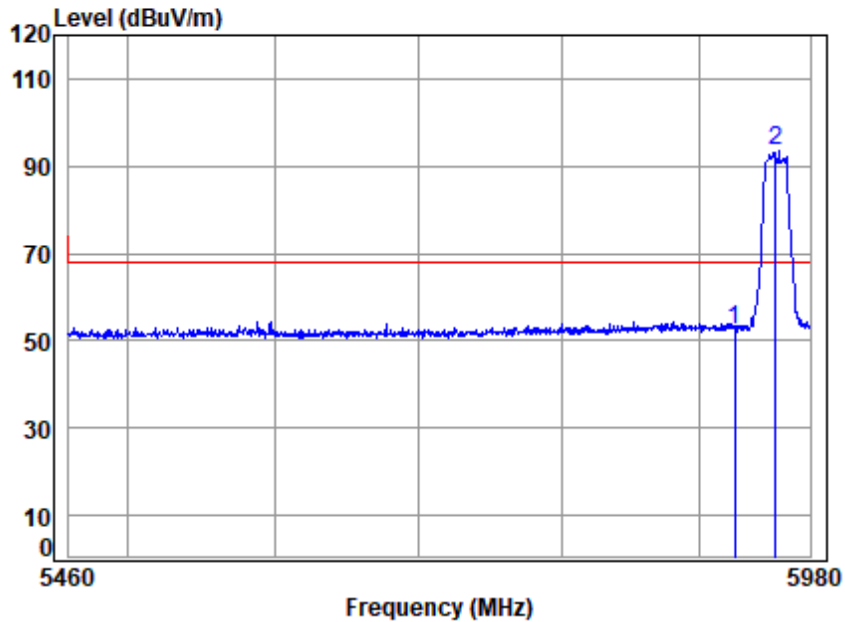

Site : chamber
 Condition: 3m HORIZONTAL
 Job No : 00955AT/00956AT
 Mode : 5955 Band edge
 : 5G WIFI 11A

	Cable	Ant	Preamp	Read	Limit	Over	
Freq	Loss	Factor	Factor	Level	Level	Line	Limit Remark
MHz	dB	dB/m	dB	dBuV	dBuV/m	dBuV/m	dB
1	5925.000	8.12	34.65	34.93	44.84	52.68	68.20 -15.52 peak
2 p	5955.000	8.14	34.72	34.92	85.69	93.63	68.20 25.43 peak



Unless otherwise agreed in writing, this document is issued by the Company subject to its General Conditions of Service printed overleaf, available on request or accessible at <https://www.sgs.com/en/Terms-and-Conditions>. Attention is drawn to the limitation of liability, indemnification and jurisdiction issues defined therein. Any holder of this document is advised that information contained hereon reflects the Company's findings at the time of its intervention only and within the limits of Client's instructions, if any. The Company's sole responsibility is to its Client and this document does not exonerate parties to a transaction from exercising all their rights and obligations under the transaction documents. This document cannot be reproduced except in full, without prior written approval of the Company. Any unauthorized alteration, forgery or falsification of the content or appearance of this document is unlawful and offenders may be prosecuted to the fullest extent of the law. Unless otherwise stated the results shown in this test report refer only to the sample(s) tested and such sample(s) are retained for 30 days only.

Test Mode: 25; Polarity: Vertical; Modulation:802.11a; Bandwidth:20MHz; Channel:Low

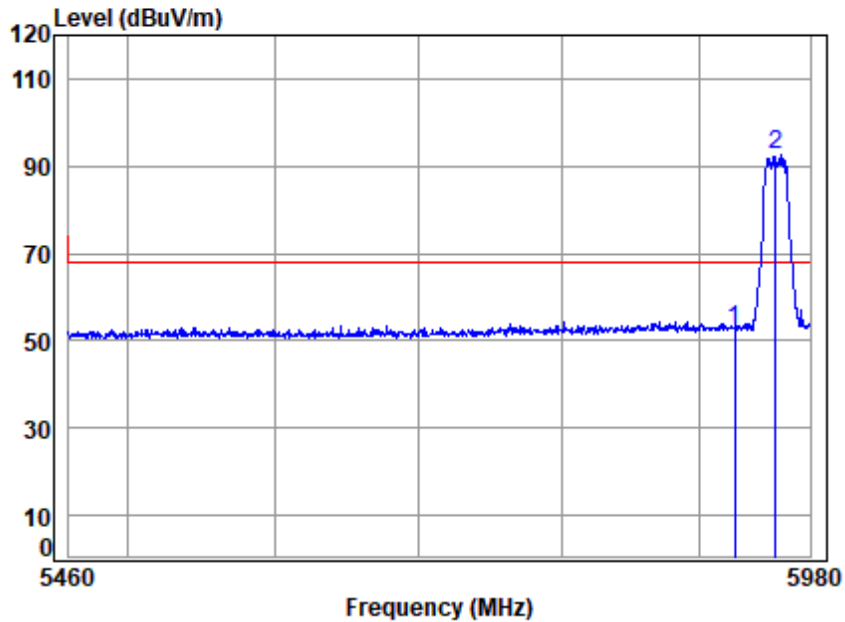

Site : chamber
 Condition: 3m VERTICAL
 Job No : 00955AT/00956AT
 Mode : 5955 Band edge
 : 5G WIFI 11A

	Cable	Ant	Preamp	Read	Limit	Over	
Freq	Loss	Factor	Factor	Level	Level	Line	Limit Remark
MHz	dB	dB/m	dB	dBuV	dBuV/m	dBuV/m	dB
1	5925.000	8.12	34.65	34.93	44.83	52.67	68.20 -15.53 peak
2 p	5955.000	8.14	34.72	34.92	84.62	92.56	68.20 24.36 peak



Unless otherwise agreed in writing, this document is issued by the Company subject to its General Conditions of Service printed overleaf, available on request or accessible at <https://www.sgs.com/en/Terms-and-Conditions>. Attention is drawn to the limitation of liability, indemnification and jurisdiction issues defined therein. Any holder of this document is advised that information contained hereon reflects the Company's findings at the time of its intervention only and within the limits of Client's instructions, if any. The Company's sole responsibility is to its Client and this document does not exonerate parties to a transaction from exercising all their rights and obligations under the transaction documents. This document cannot be reproduced except in full, without prior written approval of the Company. Any unauthorized alteration, forgery or falsification of the content or appearance of this document is unlawful and offenders may be prosecuted to the fullest extent of the law. Unless otherwise stated the results shown in this test report refer only to the sample(s) tested and such sample(s) are retained for 30 days only.

Attention: To check the authenticity of testing /inspection report & certificate, please contact us at telephone: (86-755) 8307 1443, or email: CN.Doccheck@sgs.com
 No.1 Workshop, M-10, Middle Section, Science & Technology Park, Nanshan District, Shenzhen, Guangdong, China 518057 t (86-755) 26012053 f (86-755) 26710594 www.sgs.com.cn
 中国·广东·深圳市南山区科技园中区M-10栋1号厂房 邮编: 518057 t (86-755) 26012053 f (86-755) 26710594 sgs.china@sgs.com

Test Mode: 25; Polarity: Horizontal; Modulation:802.11ac; Bandwidth:20MHz; Channel:Low

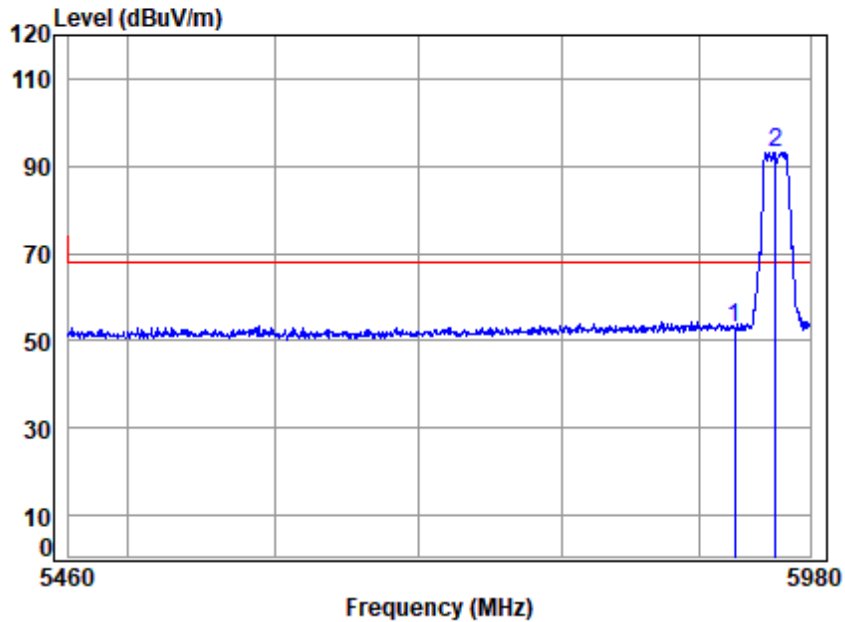

Site : chamber
 Condition: 3m HORIZONTAL
 Job No : 00955AT/00956AT
 Mode : 5955 Band edge
 : 5G WIFI 11AC20

	Cable	Ant	Preamp	Read	Limit	Over	
Freq	Loss	Factor	Factor	Level	Level	Line	Limit Remark
MHz	dB	dB/m	dB	dBuV	dBuV/m	dBuV/m	dB
1	5925.000	8.12	34.65	34.93	45.03	52.87	68.20 -15.33 peak
2 p	5955.000	8.14	34.72	34.92	85.31	93.25	68.20 25.05 peak



Unless otherwise agreed in writing, this document is issued by the Company subject to its General Conditions of Service printed overleaf, available on request or accessible at <https://www.sgs.com/en/Terms-and-Conditions>. Attention is drawn to the limitation of liability, indemnification and jurisdiction issues defined therein. Any holder of this document is advised that information contained hereon reflects the Company's findings at the time of its intervention only and within the limits of Client's instructions, if any. The Company's sole responsibility is to its Client and this document does not exonerate parties to a transaction from exercising all their rights and obligations under the transaction documents. This document cannot be reproduced except in full, without prior written approval of the Company. Any unauthorized alteration, forgery or falsification of the content or appearance of this document is unlawful and offenders may be prosecuted to the fullest extent of the law. Unless otherwise stated the results shown in this test report refer only to the sample(s) tested and such sample(s) are retained for 30 days only.

Attention: To check the authenticity of testing /inspection report & certificate, please contact us at telephone: (86-755) 8307 1443, or email: CN.Doccheck@sgs.com
 No.1 Workshop, M-10, Middle Section, Science & Technology Park, Nanshan District, Shenzhen, Guangdong, China 518057 t (86-755) 26012053 f (86-755) 26710594 www.sgs.com.cn
 中国·广东·深圳市南山区科技园中区M-10栋1号厂房 邮编: 518057 t (86-755) 26012053 f (86-755) 26710594 sgs.china@sgs.com

Test Mode: 25; Polarity: Vertical; Modulation:802.11ac; Bandwidth:20MHz; Channel:Low

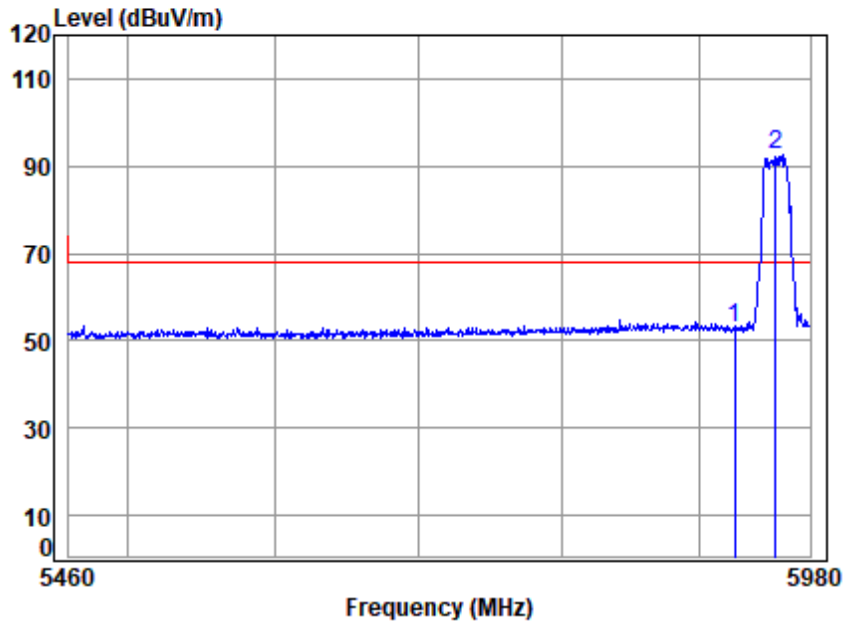

Site : chamber
 Condition: 3m VERTICAL
 Job No : 00955AT/00956AT
 Mode : 5955 Band edge
 : 5G WIFI 11AC20

	Cable	Ant	Preamp	Read	Limit	Over	
Freq	Loss	Factor	Factor	Level	Level	Line	Limit Remark
MHz	dB	dB/m	dB	dBuV	dBuV/m	dBuV/m	dB
1	5925.000	8.12	34.65	34.93	45.31	53.15	68.20 -15.05 peak
2 p	5955.000	8.14	34.72	34.92	84.56	92.50	68.20 24.30 peak



Unless otherwise agreed in writing, this document is issued by the Company subject to its General Conditions of Service printed overleaf, available on request or accessible at <https://www.sgs.com/en/Terms-and-Conditions>. Attention is drawn to the limitation of liability, indemnification and jurisdiction issues defined therein. Any holder of this document is advised that information contained hereon reflects the Company's findings at the time of its intervention only and within the limits of Client's instructions, if any. The Company's sole responsibility is to its Client and this document does not exonerate parties to a transaction from exercising all their rights and obligations under the transaction documents. This document cannot be reproduced except in full, without prior written approval of the Company. Any unauthorized alteration, forgery or falsification of the content or appearance of this document is unlawful and offenders may be prosecuted to the fullest extent of the law. Unless otherwise stated the results shown in this test report refer only to the sample(s) tested and such sample(s) are retained for 30 days only.

Attention: To check the authenticity of testing /inspection report & certificate, please contact us at telephone: (86-755) 8307 1443, or email: CN.Doccheck@sgs.com
 No.1 Workshop, M-10, Middle Section, Science & Technology Park, Nanshan District, Shenzhen, Guangdong, China 518057 t (86-755) 26012053 f (86-755) 26710594 www.sgs.com.cn
 中国·广东·深圳市南山区科技园中区M-10栋1号厂房 邮编: 518057 t (86-755) 26012053 f (86-755) 26710594 sgs.china@sgs.com

Test Mode: 25; Polarity: Horizontal; Modulation:802.11ac; Bandwidth:40MHz; Channel:Low

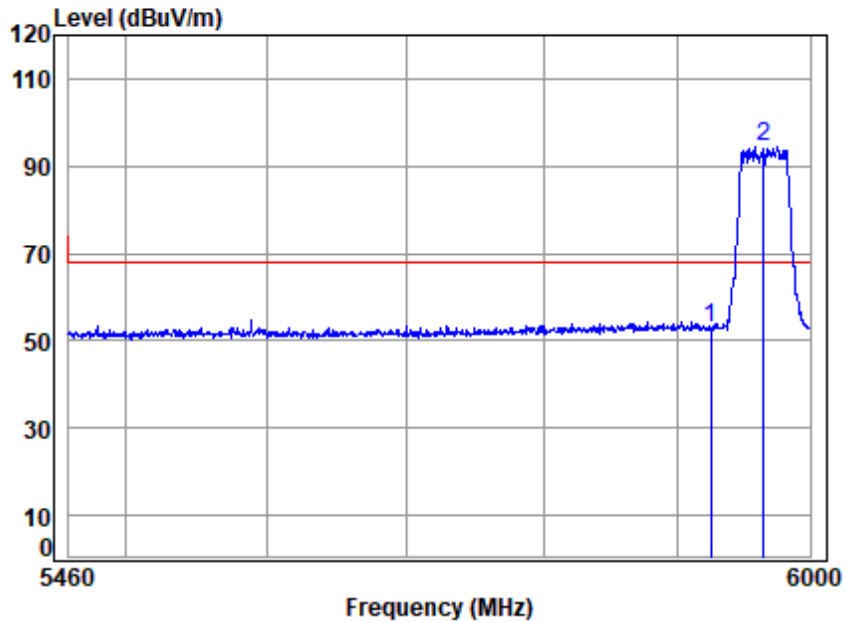

Site : chamber
 Condition: 3m HORIZONTAL
 Job No : 00955AT/00956AT
 Mode : 5965 Band edge
 : 5G WIFI 11AC40

	Cable	Ant	Preamp	Read	Limit	Over	
Freq	Loss	Factor	Factor	Level	Level	Line	Limit Remark
MHz	dB	dB/m	dB	dBuV	dBuV/m	dBuV/m	dB
1	5925.000	8.12	34.65	34.93	45.08	52.92	68.20 -15.28 peak
2 p	5965.000	8.15	34.76	34.92	86.60	94.59	68.20 26.39 peak



Unless otherwise agreed in writing, this document is issued by the Company subject to its General Conditions of Service printed overleaf, available on request or accessible at <https://www.sgs.com/en/Terms-and-Conditions>. Attention is drawn to the limitation of liability, indemnification and jurisdiction issues defined therein. Any holder of this document is advised that information contained hereon reflects the Company's findings at the time of its intervention only and within the limits of Client's instructions, if any. The Company's sole responsibility is to its Client and this document does not exonerate parties to a transaction from exercising all their rights and obligations under the transaction documents. This document cannot be reproduced except in full, without prior written approval of the Company. Any unauthorized alteration, forgery or falsification of the content or appearance of this document is unlawful and offenders may be prosecuted to the fullest extent of the law. Unless otherwise stated the results shown in this test report refer only to the sample(s) tested and such sample(s) are retained for 30 days only.

Test Mode: 25; Polarity: Vertical; Modulation:802.11ac; Bandwidth:40MHz; Channel:Low

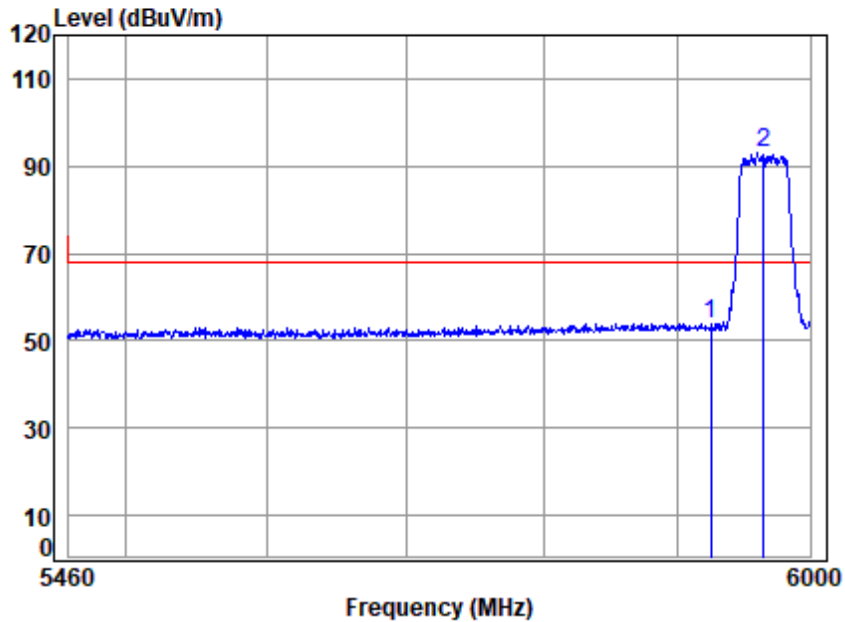

Site : chamber
 Condition: 3m VERTICAL
 Job No : 00955AT/00956AT
 Mode : 5965 Band edge
 : 5G WIFI 11AC40

	Cable	Ant	Preamp	Read	Limit	Over	
Freq	Loss	Factor	Factor	Level	Level	Line	Limit Remark
MHz	dB	dB/m	dB	dBuV	dBuV/m	dBuV/m	dB
1	5925.000	8.12	34.65	34.93	45.97	53.81	68.20 -14.39 peak
2 p	5965.000	8.15	34.76	34.92	84.95	92.94	68.20 24.74 peak



Unless otherwise agreed in writing, this document is issued by the Company subject to its General Conditions of Service printed overleaf, available on request or accessible at <https://www.sgs.com/en/Terms-and-Conditions>. Attention is drawn to the limitation of liability, indemnification and jurisdiction issues defined therein. Any holder of this document is advised that information contained hereon reflects the Company's findings at the time of its intervention only and within the limits of Client's instructions, if any. The Company's sole responsibility is to its Client and this document does not exonerate parties to a transaction from exercising all their rights and obligations under the transaction documents. This document cannot be reproduced except in full, without prior written approval of the Company. Any unauthorized alteration, forgery or falsification of the content or appearance of this document is unlawful and offenders may be prosecuted to the fullest extent of the law. Unless otherwise stated the results shown in this test report refer only to the sample(s) tested and such sample(s) are retained for 30 days only.

Attention: To check the authenticity of testing /inspection report & certificate, please contact us at telephone: (86-755) 8307 1443, or email: CN.Doccheck@sgs.com
 No.1 Workshop, M-10, Middle Section, Science & Technology Park, Nanshan District, Shenzhen, Guangdong, China 518057 t (86-755) 26012053 f (86-755) 26710594 www.sgs.com.cn
 中国·广东·深圳市南山区科技园中区M-10栋1号厂房 邮编: 518057 t (86-755) 26012053 f (86-755) 26710594 sgs.china@sgs.com

Test Mode: 25; Polarity: Horizontal; Modulation:802.11ac; Bandwidth:80MHz; Channel:Low

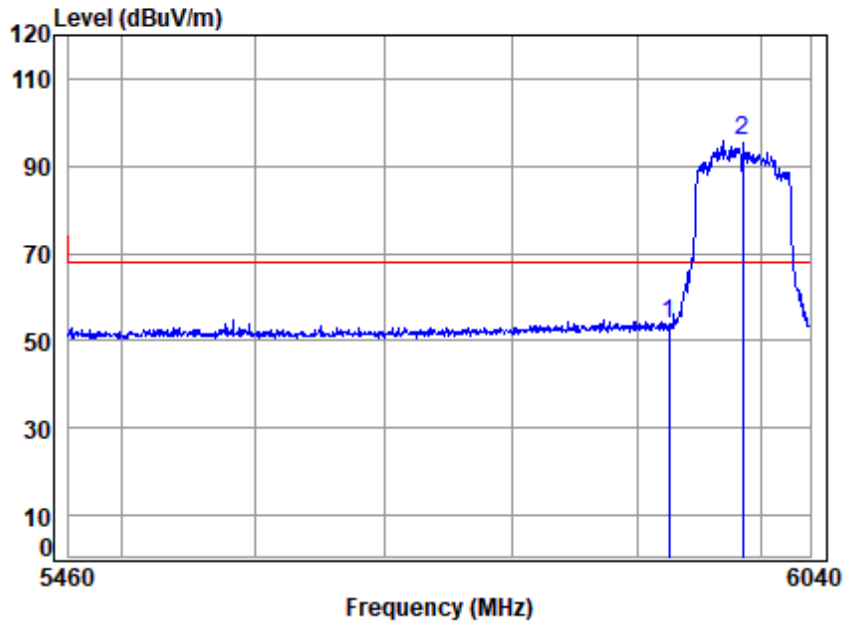

Site : chamber
 Condition: 3m HORIZONTAL
 Job No : 00955AT/00956AT
 Mode : 5985 Band edge
 : 5G WIFI 11AC80

	Cable	Ant	Preamp	Read	Limit	Over	
Freq	Loss	Factor	Factor	Level	Level	Line	Limit Remark
MHz	dB	dB/m	dB	dBuV	dBuV/m	dBuV/m	dB
1	5925.000	8.12	34.65	34.93	46.06	53.90	68.20 -14.30 peak
2 p	5985.000	8.16	34.84	34.91	87.77	95.86	68.20 27.66 peak



Unless otherwise agreed in writing, this document is issued by the Company subject to its General Conditions of Service printed overleaf, available on request or accessible at <https://www.sgs.com/en/Terms-and-Conditions>. Attention is drawn to the limitation of liability, indemnification and jurisdiction issues defined therein. Any holder of this document is advised that information contained hereon reflects the Company's findings at the time of its intervention only and within the limits of Client's instructions, if any. The Company's sole responsibility is to its Client and this document does not exonerate parties to a transaction from exercising all their rights and obligations under the transaction documents. This document cannot be reproduced except in full, without prior written approval of the Company. Any unauthorized alteration, forgery or falsification of the content or appearance of this document is unlawful and offenders may be prosecuted to the fullest extent of the law. Unless otherwise stated the results shown in this test report refer only to the sample(s) tested and such sample(s) are retained for 30 days only.

Test Mode: 25; Polarity: Vertical; Modulation:802.11ac; Bandwidth:80MHz; Channel:Low

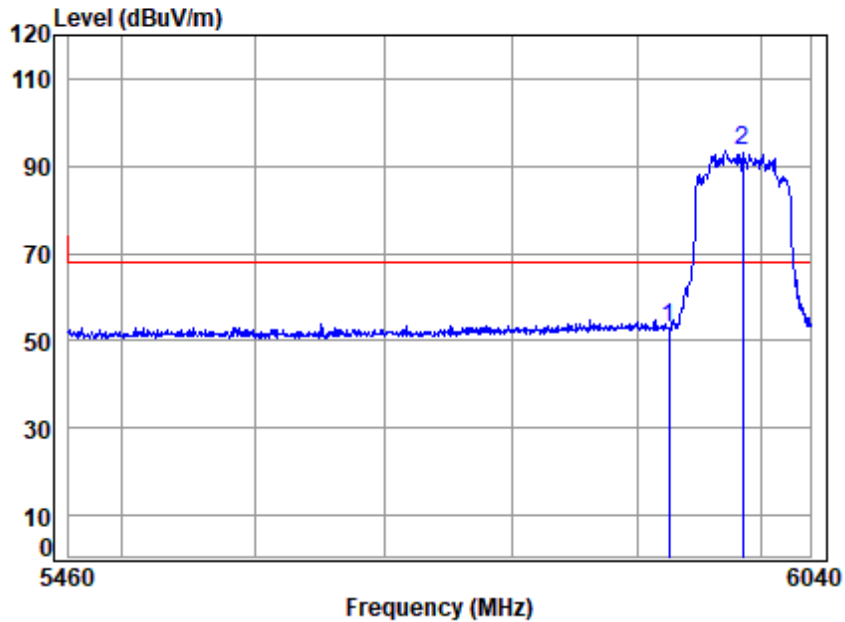

Site : chamber
 Condition: 3m VERTICAL
 Job No : 00955AT/00956AT
 Mode : 5985 Band edge
 : 5G WIFI 11AC80

	Cable	Ant	Preamp	Read	Limit	Over	
Freq	Loss	Factor	Factor	Level	Level	Line	Limit Remark
MHz	dB	dB/m	dB	dBuV	dBuV/m	dBuV/m	dB
1	5925.000	8.12	34.65	34.93	45.24	53.08	68.20 -15.12 peak
2 p	5985.000	8.16	34.84	34.91	85.29	93.38	68.20 25.18 peak



Unless otherwise agreed in writing, this document is issued by the Company subject to its General Conditions of Service printed overleaf, available on request or accessible at <https://www.sgs.com/en/Terms-and-Conditions>. Attention is drawn to the limitation of liability, indemnification and jurisdiction issues defined therein. Any holder of this document is advised that information contained hereon reflects the Company's findings at the time of its intervention only and within the limits of Client's instructions, if any. The Company's sole responsibility is to its Client and this document does not exonerate parties to a transaction from exercising all their rights and obligations under the transaction documents. This document cannot be reproduced except in full, without prior written approval of the Company. Any unauthorized alteration, forgery or falsification of the content or appearance of this document is unlawful and offenders may be prosecuted to the fullest extent of the law. Unless otherwise stated the results shown in this test report refer only to the sample(s) tested and such sample(s) are retained for 30 days only.

Attention: To check the authenticity of testing /inspection report & certificate, please contact us at telephone: (86-755) 8307 1443, or email: CN.Doccheck@sgs.com
 No.1 Workshop, M-10, Middle Section, Science & Technology Park, Nanshan District, Shenzhen, Guangdong, China 518057 t (86-755) 26012053 f (86-755) 26710594 www.sgs.com.cn
 中国·广东·深圳市南山区科技园中区M-10栋1号厂房 邮编: 518057 t (86-755) 26012053 f (86-755) 26710594 sgs.china@sgs.com

Test Mode: 28; Polarity: Horizontal; Modulation:802.11a; Bandwidth:20MHz; Channel:High

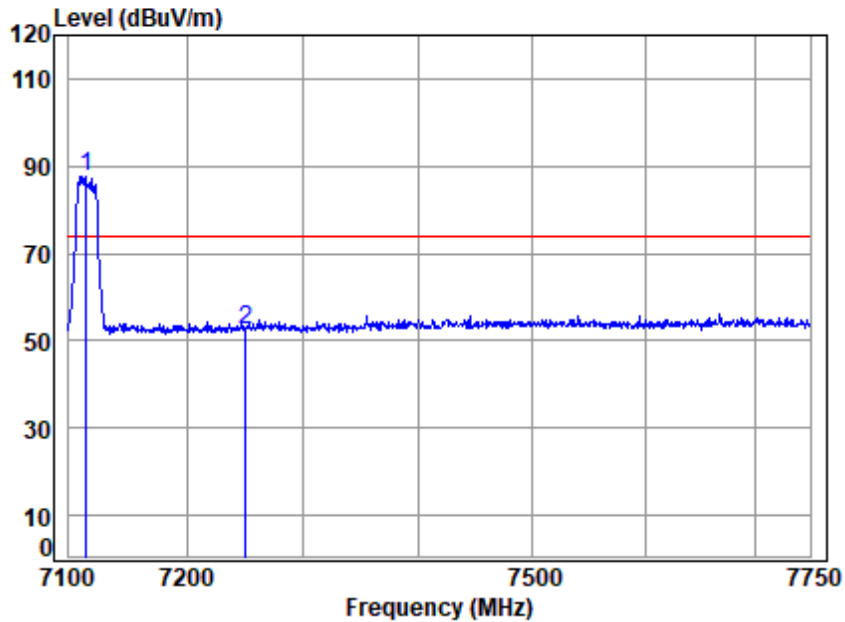

Site : chamber
 Condition: 3m HORIZONTAL
 Job No : 00955AT/00956AT
 Mode : 7115 Band edge
 : 5G WIFI 11A

	Cable	Ant	Preamp	Read	Limit	Over	
Freq	Loss	Factor	Factor	Level	Level	Line	Limit Remark
MHz	dB	dB/m	dB	dBuV	dBuV/m	dBuV/m	dB
1 p 7115.000	9.06	35.80	35.69	78.38	87.55	74.00	13.55 peak
2 7250.000	9.23	35.70	35.83	43.54	52.64	74.00	-21.36 peak



Unless otherwise agreed in writing, this document is issued by the Company subject to its General Conditions of Service printed overleaf, available on request or accessible at <https://www.sgs.com/en/Terms-and-Conditions>. Attention is drawn to the limitation of liability, indemnification and jurisdiction issues defined therein. Any holder of this document is advised that information contained hereon reflects the Company's findings at the time of its intervention only and within the limits of Client's instructions, if any. The Company's sole responsibility is to its Client and this document does not exonerate parties to a transaction from exercising all their rights and obligations under the transaction documents. This document cannot be reproduced except in full, without prior written approval of the Company. Any unauthorized alteration, forgery or falsification of the content or appearance of this document is unlawful and offenders may be prosecuted to the fullest extent of the law. Unless otherwise stated the results shown in this test report refer only to the sample(s) tested and such sample(s) are retained for 30 days only.
 Attention: To check the authenticity of testing /inspection report & certificate, please contact us at telephone: (86-755) 8307 1443, or email: CN.Doccheck@sgs.com
 No.1 Workshop, M-10, Middle Section, Science & Technology Park, Nanshan District, Shenzhen, Guangdong, China 518057 t (86-755) 26012053 f (86-755) 26710594 www.sgs.com.cn
 中国·广东·深圳市南山区科技园中区M-10栋1号厂房 邮编: 518057 t (86-755) 26012053 f (86-755) 26710594 sgs.china@sgs.com

Test Mode: 28; Polarity: Horizontal; Modulation:802.11a; Bandwidth:20MHz; Channel:High

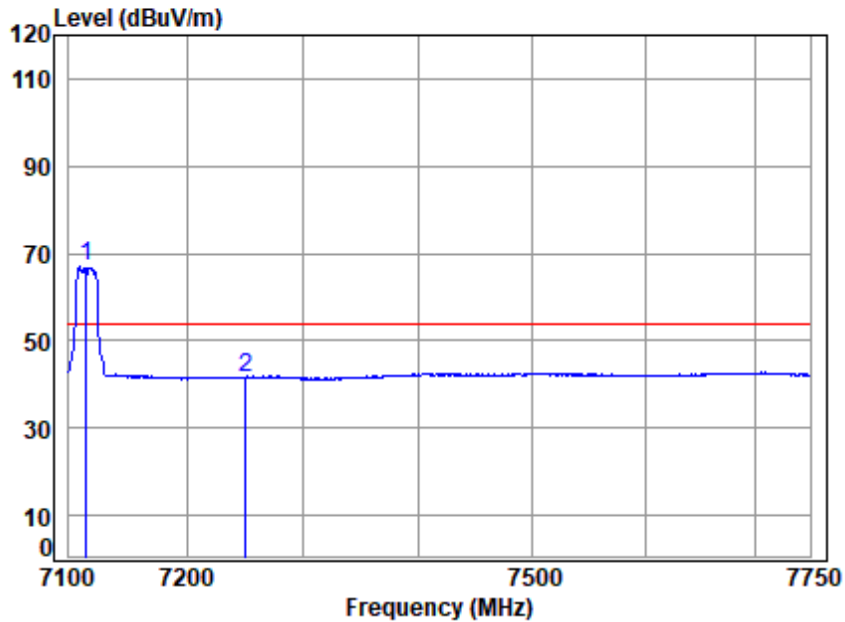

Site : chamber
 Condition: 3m HORIZONTAL
 Job No : 00955AT/00956AT
 Mode : 7115 Band edge
 : 5G WIFI 11A

	Cable	Ant	Preamp	Read	Limit	Over		
Freq	Loss	Factor	Factor	Level	Level	Line	Limit	Remark
MHz	dB	dB/m	dB	dBuV	dBuV/m	dBuV/m	dB	
1 q 7115.000	9.06	35.80	35.69	57.70	66.87	54.00	12.87	Average
2 7250.000	9.23	35.70	35.83	32.46	41.56	54.00	-12.44	Average



Unless otherwise agreed in writing, this document is issued by the Company subject to its General Conditions of Service printed overleaf, available on request or accessible at <https://www.sgs.com/en/Terms-and-Conditions>. Attention is drawn to the limitation of liability, indemnification and jurisdiction issues defined therein. Any holder of this document is advised that information contained hereon reflects the Company's findings at the time of its intervention only and within the limits of Client's instructions, if any. The Company's sole responsibility is to its Client and this document does not exonerate parties to a transaction from exercising all their rights and obligations under the transaction documents. This document cannot be reproduced except in full, without prior written approval of the Company. Any unauthorized alteration, forgery or falsification of the content or appearance of this document is unlawful and offenders may be prosecuted to the fullest extent of the law. Unless otherwise stated the results shown in this test report refer only to the sample(s) tested and such sample(s) are retained for 30 days only.
 Attention: To check the authenticity of testing /inspection report & certificate, please contact us at telephone: (86-755) 8307 1443, or email: CN.Doccheck@sgs.com
 No.1 Workshop, M-10, Middle Section, Science & Technology Park, Nanshan District, Shenzhen, Guangdong, China 518057 t (86-755) 26012053 f (86-755) 26710594 www.sgs.com.cn
 中国·广东·深圳市南山区科技园中区M-10栋1号厂房 邮编: 518057 t (86-755) 26012053 f (86-755) 26710594 sgs.china@sgs.com

Test Mode: 28; Polarity: Vertical; Modulation:802.11a; Bandwidth:20MHz; Channel:High

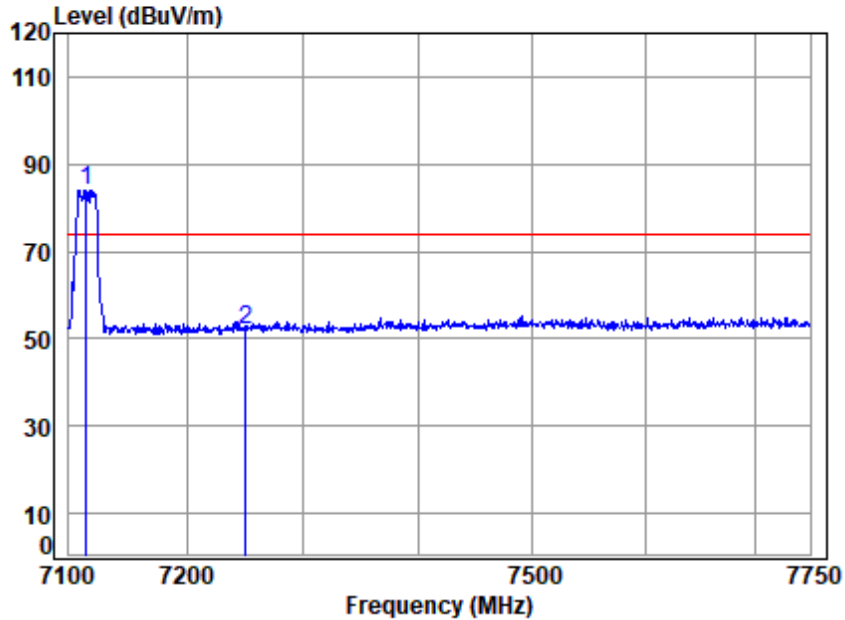

Site : chamber
 Condition: 3m VERTICAL
 Job No : 00955AT/00956AT
 Mode : 7115 Band edge
 : 5G WIFI 11A

	Cable	Ant	Preamp	Read	Limit	Over	
Freq	Loss	Factor	Factor	Level	Level	Line	Limit Remark
MHz	dB	dB/m	dB	dBuV	dBuV/m	dBuV/m	dB
1 p 7115.000	9.06	35.80	35.69	75.01	84.18	74.00	10.18 Peak
2 7250.000	9.23	35.70	35.83	43.02	52.12	74.00	-21.88 Peak



Unless otherwise agreed in writing, this document is issued by the Company subject to its General Conditions of Service printed overleaf, available on request or accessible at <https://www.sgs.com/en/Terms-and-Conditions>. Attention is drawn to the limitation of liability, indemnification and jurisdiction issues defined therein. Any holder of this document is advised that information contained hereon reflects the Company's findings at the time of its intervention only and within the limits of Client's instructions, if any. The Company's sole responsibility is to its Client and this document does not exonerate parties to a transaction from exercising all their rights and obligations under the transaction documents. This document cannot be reproduced except in full, without prior written approval of the Company. Any unauthorized alteration, forgery or falsification of the content or appearance of this document is unlawful and offenders may be prosecuted to the fullest extent of the law. Unless otherwise stated the results shown in this test report refer only to the sample(s) tested and such sample(s) are retained for 30 days only.

Attention: To check the authenticity of testing /inspection report & certificate, please contact us at telephone: (86-755) 8307 1443, or email: CN.Doccheck@sgs.com
 No.1 Workshop, M-10, Middle Section, Science & Technology Park, Nanshan District, Shenzhen, Guangdong, China 518057 t (86-755) 26012053 f (86-755) 26710594 www.sgs.com.cn
 中国·广东·深圳市南山区科技园中区M-10栋1号厂房 邮编: 518057 t (86-755) 26012053 f (86-755) 26710594 sgs.china@sgs.com

Test Mode: 28; Polarity: Vertical; Modulation:802.11a; Bandwidth:20MHz; Channel:High

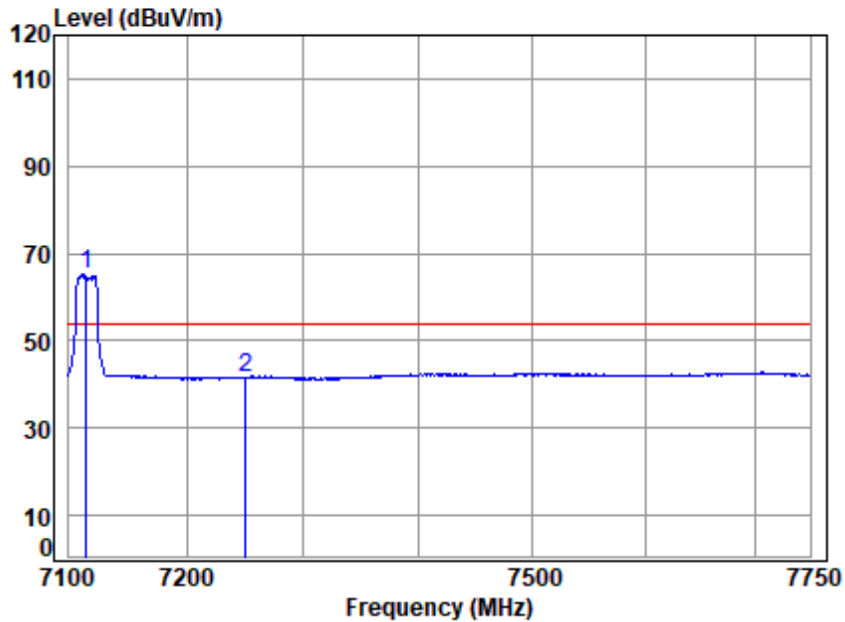

Site : chamber
 Condition: 3m VERTICAL
 Job No : 00955AT/00956AT
 Mode : 7115 Band edge
 : 5G WIFI 11A

	Cable	Ant	Preamp	Read	Limit	Over		
Freq	Loss	Factor	Factor	Level	Level	Line	Limit	Remark
MHz	dB	dB/m	dB	dBuV	dBuV/m	dBuV/m	dB	
1 q 7115.000	9.06	35.80	35.69	55.97	65.14	54.00	11.14	Average
2 7250.000	9.23	35.70	35.83	32.44	41.54	54.00	-12.46	Average



Unless otherwise agreed in writing, this document is issued by the Company subject to its General Conditions of Service printed overleaf, available on request or accessible at <https://www.sgs.com/en/Terms-and-Conditions>. Attention is drawn to the limitation of liability, indemnification and jurisdiction issues defined therein. Any holder of this document is advised that information contained hereon reflects the Company's findings at the time of its intervention only and within the limits of Client's instructions, if any. The Company's sole responsibility is to its Client and this document does not exonerate parties to a transaction from exercising all their rights and obligations under the transaction documents. This document cannot be reproduced except in full, without prior written approval of the Company. Any unauthorized alteration, forgery or falsification of the content or appearance of this document is unlawful and offenders may be prosecuted to the fullest extent of the law. Unless otherwise stated the results shown in this test report refer only to the sample(s) tested and such sample(s) are retained for 30 days only.
 Attention: To check the authenticity of testing /inspection report & certificate, please contact us at telephone: (86-755) 8307 1443, or email: CN.Doccheck@sgs.com
 No.1 Workshop, M-10, Middle Section, Science & Technology Park, Nanshan District, Shenzhen, Guangdong, China 518057 t (86-755) 26012053 f (86-755) 26710594 www.sgs.com.cn
 中国·广东·深圳市南山区科技园中区M-10栋1号厂房 邮编: 518057 t (86-755) 26012053 f (86-755) 26710594 sgs.china@sgs.com

Test Mode: 28; Polarity: Horizontal; Modulation:802.11ac; Bandwidth:20MHz; Channel:High

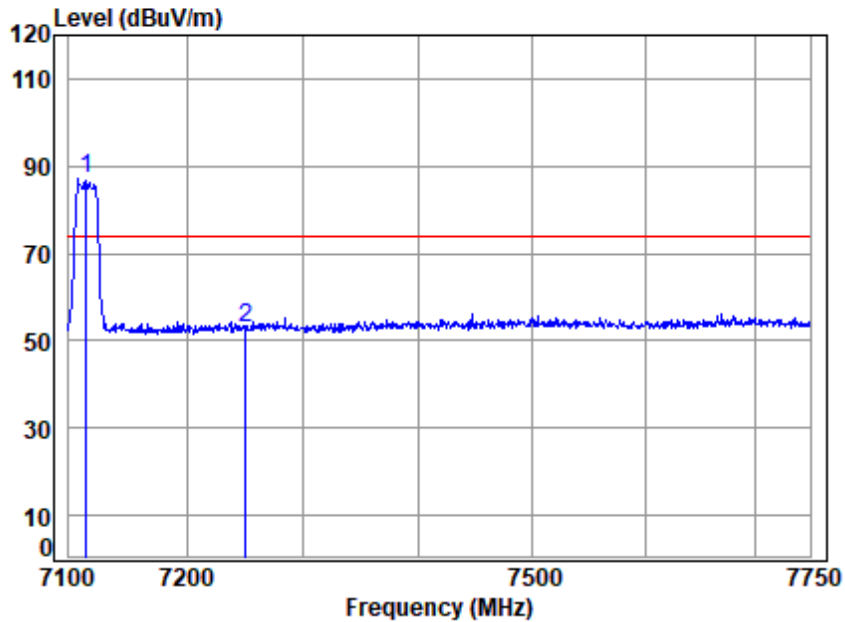

Site : chamber
 Condition: 3m HORIZONTAL
 Job No : 00955AT/00956AT
 Mode : 7115 Band edge
 : 5G WIFI 11AC20

	Cable	Ant	Preamp	Read	Limit	Over	
Freq	Loss	Factor	Factor	Level	Level	Line	Limit Remark
MHz	dB	dB/m	dB	dBuV	dBuV/m	dBuV/m	dB
1 p 7115.000	9.06	35.80	35.69	78.03	87.20	74.00	13.20 peak
2 7250.000	9.23	35.70	35.83	43.85	52.95	74.00	-21.05 peak



Unless otherwise agreed in writing, this document is issued by the Company subject to its General Conditions of Service printed overleaf, available on request or accessible at <https://www.sgs.com/en/Terms-and-Conditions>. Attention is drawn to the limitation of liability, indemnification and jurisdiction issues defined therein. Any holder of this document is advised that information contained hereon reflects the Company's findings at the time of its intervention only and within the limits of Client's instructions, if any. The Company's sole responsibility is to its Client and this document does not exonerate parties to a transaction from exercising all their rights and obligations under the transaction documents. This document cannot be reproduced except in full, without prior written approval of the Company. Any unauthorized alteration, forgery or falsification of the content or appearance of this document is unlawful and offenders may be prosecuted to the fullest extent of the law. Unless otherwise stated the results shown in this test report refer only to the sample(s) tested and such sample(s) are retained for 30 days only.
 Attention: To check the authenticity of testing /inspection report & certificate, please contact us at telephone: (86-755) 8307 1443, or email: CN.Doccheck@sgs.com
 No.1 Workshop, M-10, Middle Section, Science & Technology Park, Nanshan District, Shenzhen, Guangdong, China 518057 t (86-755) 26012053 f (86-755) 26710594 www.sgs.com.cn
 中国·广东·深圳市南山区科技园中区M-10栋1号厂房 邮编: 518057 t (86-755) 26012053 f (86-755) 26710594 sgs.china@sgs.com

Test Mode: 28; Polarity: Horizontal; Modulation:802.11ac; Bandwidth:20MHz; Channel:High

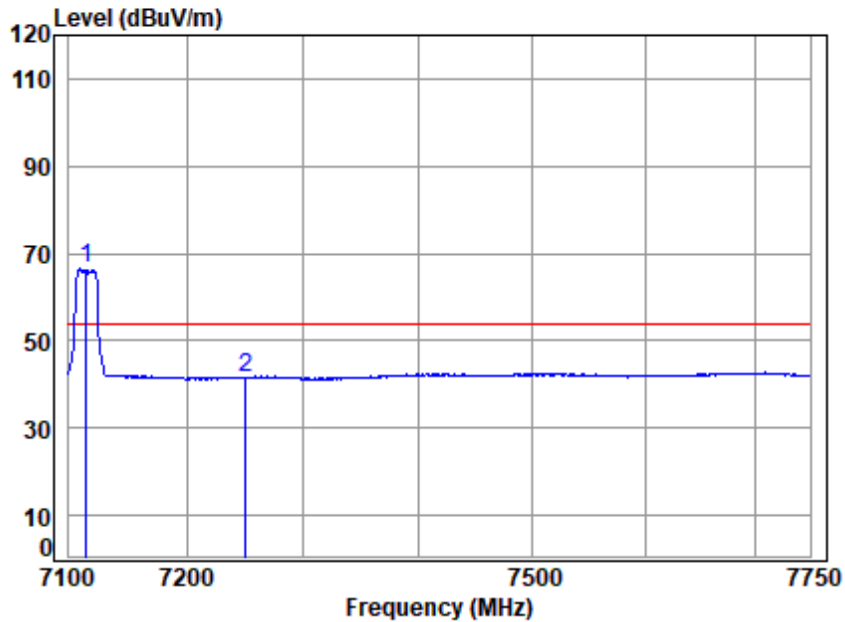

Site : chamber
 Condition: 3m HORIZONTAL
 Job No : 00955AT/00956AT
 Mode : 7115 Band edge
 : 5G WIFI 11AC20

	Cable	Ant	Preamp	Read	Limit	Over		
Freq	Loss	Factor	Factor	Level	Level	Line	Limit	Remark
MHz	dB	dB/m	dB	dBuV	dBuV/m	dBuV/m	dB	
1 q 7115.000	9.06	35.80	35.69	57.60	66.77	54.00	12.77	Average
2 7250.000	9.23	35.70	35.83	32.39	41.49	54.00	-12.51	Average



Unless otherwise agreed in writing, this document is issued by the Company subject to its General Conditions of Service printed overleaf, available on request or accessible at <https://www.sgs.com/en/Terms-and-Conditions>. Attention is drawn to the limitation of liability, indemnification and jurisdiction issues defined therein. Any holder of this document is advised that information contained hereon reflects the Company's findings at the time of its intervention only and within the limits of Client's instructions, if any. The Company's sole responsibility is to its Client and this document does not exonerate parties to a transaction from exercising all their rights and obligations under the transaction documents. This document cannot be reproduced except in full, without prior written approval of the Company. Any unauthorized alteration, forgery or falsification of the content or appearance of this document is unlawful and offenders may be prosecuted to the fullest extent of the law. Unless otherwise stated the results shown in this test report refer only to the sample(s) tested and such sample(s) are retained for 30 days only.
 Attention: To check the authenticity of testing /inspection report & certificate, please contact us at telephone: (86-755) 8307 1443, or email: CN.Doccheck@sgs.com
 No.1 Workshop, M-10, Middle Section, Science & Technology Park, Nanshan District, Shenzhen, Guangdong, China 518057 t (86-755) 26012053 f (86-755) 26710594 www.sgs.com.cn
 中国·广东·深圳市南山区科技园中区M-10栋1号厂房 邮编: 518057 t (86-755) 26012053 f (86-755) 26710594 sgs.china@sgs.com

Test Mode: 28; Polarity: Vertical; Modulation:802.11ac; Bandwidth:20MHz; Channel:High

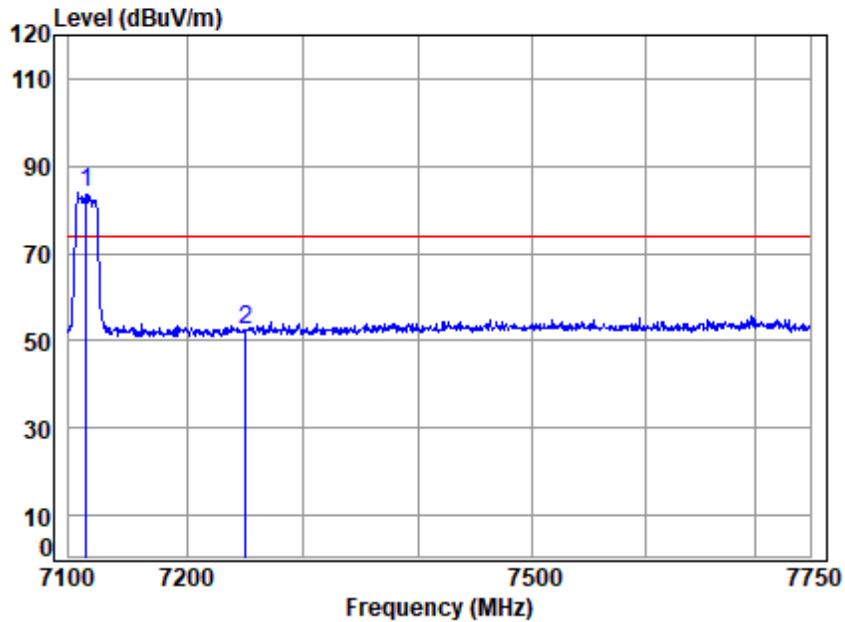

Site : chamber
 Condition: 3m VERTICAL
 Job No : 00955AT/00956AT
 Mode : 7115 Band edge
 : 5G WIFI 11AC20

	Cable	Ant	Preamp	Read	Limit	Over	
Freq	Loss	Factor	Factor	Level	Level	Line	Limit Remark
MHz	dB	dB/m	dB	dBuV	dBuV/m	dBuV/m	dB
1 p 7115.000	9.06	35.80	35.69	74.70	83.87	74.00	9.87 Peak
2 7250.000	9.23	35.70	35.83	43.19	52.29	74.00	-21.71 Peak



Unless otherwise agreed in writing, this document is issued by the Company subject to its General Conditions of Service printed overleaf, available on request or accessible at <https://www.sgs.com/en/Terms-and-Conditions>. Attention is drawn to the limitation of liability, indemnification and jurisdiction issues defined therein. Any holder of this document is advised that information contained hereon reflects the Company's findings at the time of its intervention only and within the limits of Client's instructions, if any. The Company's sole responsibility is to its Client and this document does not exonerate parties to a transaction from exercising all their rights and obligations under the transaction documents. This document cannot be reproduced except in full, without prior written approval of the Company. Any unauthorized alteration, forgery or falsification of the content or appearance of this document is unlawful and offenders may be prosecuted to the fullest extent of the law. Unless otherwise stated the results shown in this test report refer only to the sample(s) tested and such sample(s) are retained for 30 days only.

Attention: To check the authenticity of testing /inspection report & certificate, please contact us at telephone: (86-755) 8307 1443, or email: CN.Doccheck@sgs.com
 No.1 Workshop, M-10, Middle Section, Science & Technology Park, Nanshan District, Shenzhen, Guangdong, China 518057 t (86-755) 26012053 f (86-755) 26710594 www.sgs.com.cn
 中国·广东·深圳市南山区科技园中区M-10栋1号厂房 邮编: 518057 t (86-755) 26012053 f (86-755) 26710594 sgs.china@sgs.com

Test Mode: 28; Polarity: Vertical; Modulation:802.11ac; Bandwidth:20MHz; Channel:High

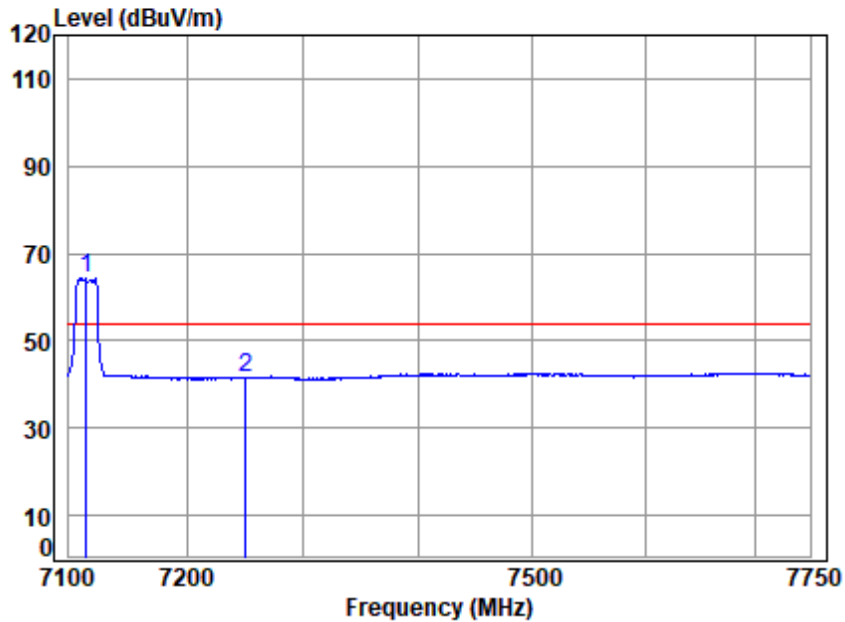

Site : chamber
 Condition: 3m VERTICAL
 Job No : 00955AT/00956AT
 Mode : 7115 Band edge
 : 5G WIFI 11AC20

	Cable	Ant	Preamp	Read	Limit	Over		
Freq	Loss	Factor	Factor	Level	Level	Line	Limit	Remark
MHz	dB	dB/m	dB	dBuV	dBuV/m	dBuV/m	dB	
1 q 7115.000	9.06	35.80	35.69	55.17	64.34	54.00	10.34	Average
2 7250.000	9.23	35.70	35.83	32.46	41.56	54.00	-12.44	Average



Unless otherwise agreed in writing, this document is issued by the Company subject to its General Conditions of Service printed overleaf, available on request or accessible at <https://www.sgs.com/en/Terms-and-Conditions>. Attention is drawn to the limitation of liability, indemnification and jurisdiction issues defined therein. Any holder of this document is advised that information contained hereon reflects the Company's findings at the time of its intervention only and within the limits of Client's instructions, if any. The Company's sole responsibility is to its Client and this document does not exonerate parties to a transaction from exercising all their rights and obligations under the transaction documents. This document cannot be reproduced except in full, without prior written approval of the Company. Any unauthorized alteration, forgery or falsification of the content or appearance of this document is unlawful and offenders may be prosecuted to the fullest extent of the law. Unless otherwise stated the results shown in this test report refer only to the sample(s) tested and such sample(s) are retained for 30 days only.
 Attention: To check the authenticity of testing /inspection report & certificate, please contact us at telephone: (86-755) 8307 1443, or email: CN.Doccheck@sgs.com
 No.1 Workshop, M-10, Middle Section, Science & Technology Park, Nanshan District, Shenzhen, Guangdong, China 518057 t (86-755) 26012053 f (86-755) 26710594 www.sgs.com.cn
 中国·广东·深圳市南山区科技园中区M-10栋1号厂房 邮编: 518057 t (86-755) 26012053 f (86-755) 26710594 sgs.china@sgs.com

Test Mode: 28; Polarity: Horizontal; Modulation:802.11ac; Bandwidth:40MHz; Channel:High

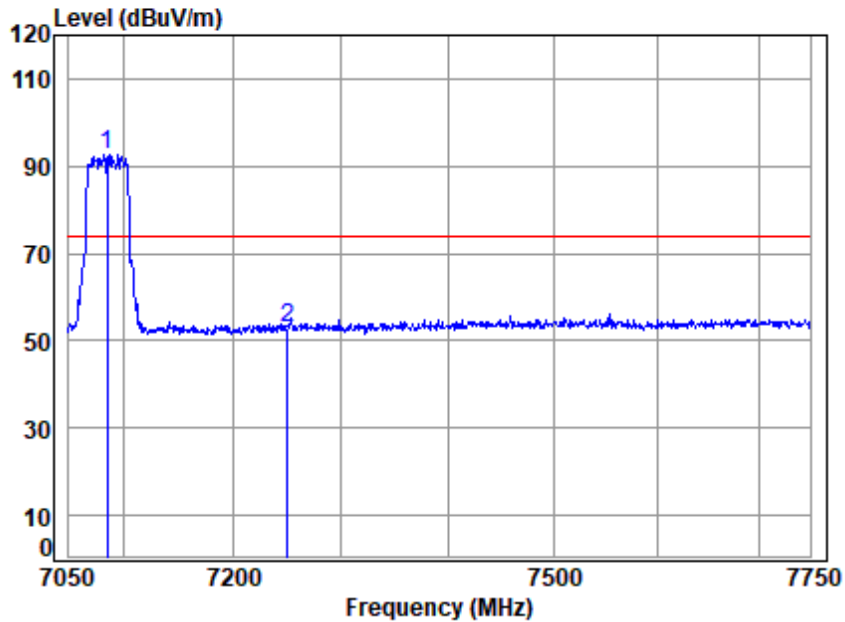

Site : chamber
 Condition: 3m HORIZONTAL
 Job No : 00955AT/00956AT
 Mode : 7085 Band edge
 : 5G WIFI 11AC40

	Cable	Ant	Preamp	Read	Limit	Over	
Freq	Loss	Factor	Factor	Level	Level	Line	Limit Remark
MHz	dB	dB/m	dB	dBuV	dBuV/m	dBuV/m	dB
1 p 7085.000	9.03	35.77	35.66	83.47	92.61	74.00	18.61 peak
2 7250.000	9.23	35.70	35.83	43.78	52.88	74.00	-21.12 peak



Unless otherwise agreed in writing, this document is issued by the Company subject to its General Conditions of Service printed overleaf, available on request or accessible at <https://www.sgs.com/en/Terms-and-Conditions>. Attention is drawn to the limitation of liability, indemnification and jurisdiction issues defined therein. Any holder of this document is advised that information contained hereon reflects the Company's findings at the time of its intervention only and within the limits of Client's instructions, if any. The Company's sole responsibility is to its Client and this document does not exonerate parties to a transaction from exercising all their rights and obligations under the transaction documents. This document cannot be reproduced except in full, without prior written approval of the Company. Any unauthorized alteration, forgery or falsification of the content or appearance of this document is unlawful and offenders may be prosecuted to the fullest extent of the law. Unless otherwise stated the results shown in this test report refer only to the sample(s) tested and such sample(s) are retained for 30 days only.

Test Mode: 28; Polarity: Horizontal; Modulation:802.11ac; Bandwidth:40MHz; Channel:High

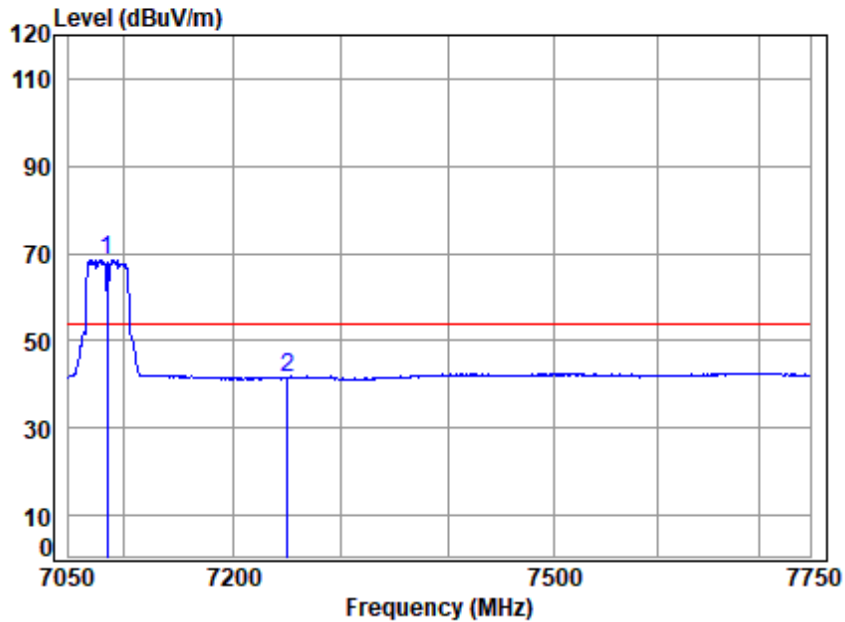

Site : chamber
 Condition: 3m HORIZONTAL
 Job No : 00955AT/00956AT
 Mode : 7085 Band edge
 : 5G WIFI 11AC40

	Cable	Ant	Preamp	Read	Limit	Over		
Freq	Loss	Factor	Factor	Level	Level	Line	Limit	Remark
MHz	dB	dB/m	dB	dBuV	dBuV/m	dBuV/m	dB	
1 q 7085.000	9.03	35.77	35.66	59.43	68.57	54.00	14.57	Average
2 7250.000	9.23	35.70	35.83	32.42	41.52	54.00	-12.48	Average



Unless otherwise agreed in writing, this document is issued by the Company subject to its General Conditions of Service printed overleaf, available on request or accessible at <https://www.sgs.com/en/Terms-and-Conditions>. Attention is drawn to the limitation of liability, indemnification and jurisdiction issues defined therein. Any holder of this document is advised that information contained hereon reflects the Company's findings at the time of its intervention only and within the limits of Client's instructions, if any. The Company's sole responsibility is to its Client and this document does not exonerate parties to a transaction from exercising all their rights and obligations under the transaction documents. This document cannot be reproduced except in full, without prior written approval of the Company. Any unauthorized alteration, forgery or falsification of the content or appearance of this document is unlawful and offenders may be prosecuted to the fullest extent of the law. Unless otherwise stated the results shown in this test report refer only to the sample(s) tested and such sample(s) are retained for 30 days only.
 Attention: To check the authenticity of testing /inspection report & certificate, please contact us at telephone: (86-755) 8307 1443, or email: CN.Doccheck@sgs.com
 No.1 Workshop, M-10, Middle Section, Science & Technology Park, Nanshan District, Shenzhen, Guangdong, China 518057 t (86-755) 26012053 f (86-755) 26710594 www.sgs.com.cn
 中国·广东·深圳市南山区科技园中区M-10栋1号厂房 邮编: 518057 t (86-755) 26012053 f (86-755) 26710594 sgs.china@sgs.com

Test Mode: 28; Polarity: Vertical; Modulation:802.11ac; Bandwidth:40MHz; Channel:High

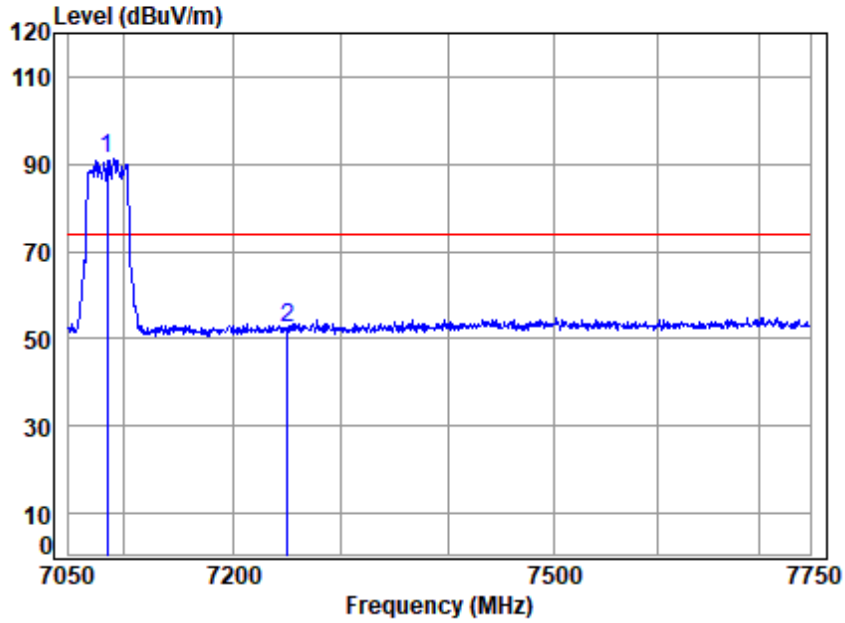

Site : chamber
 Condition: 3m VERTICAL
 Job No : 00955AT/00956AT
 Mode : 7085 Band edge
 : 5G WIFI 11AC40

	Cable	Ant	Preamp	Read	Limit	Over	
Freq	Loss	Factor	Factor	Level	Level	Line	Limit Remark
MHz	dB	dB/m	dB	dBuV	dBuV/m	dBuV/m	dB
1 p 7085.000	9.03	35.77	35.66	81.93	91.07	74.00	17.07 Peak
2 7250.000	9.23	35.70	35.83	43.38	52.48	74.00	-21.52 Peak



Unless otherwise agreed in writing, this document is issued by the Company subject to its General Conditions of Service printed overleaf, available on request or accessible at <https://www.sgs.com/en/Terms-and-Conditions>. Attention is drawn to the limitation of liability, indemnification and jurisdiction issues defined therein. Any holder of this document is advised that information contained hereon reflects the Company's findings at the time of its intervention only and within the limits of Client's instructions, if any. The Company's sole responsibility is to its Client and this document does not exonerate parties to a transaction from exercising all their rights and obligations under the transaction documents. This document cannot be reproduced except in full, without prior written approval of the Company. Any unauthorized alteration, forgery or falsification of the content or appearance of this document is unlawful and offenders may be prosecuted to the fullest extent of the law. Unless otherwise stated the results shown in this test report refer only to the sample(s) tested and such sample(s) are retained for 30 days only.
 Attention: To check the authenticity of testing /inspection report & certificate, please contact us at telephone: (86-755) 8307 1443, or email: CN.Doccheck@sgs.com
 No.1 Workshop, M-10, Middle Section, Science & Technology Park, Nanshan District, Shenzhen, Guangdong, China 518057 t (86-755) 26012053 f (86-755) 26710594 www.sgs.com.cn
 中国·广东·深圳市南山区科技园中区M-10栋1号厂房 邮编: 518057 t (86-755) 26012053 f (86-755) 26710594 sgs.china@sgs.com

Test Mode: 28; Polarity: Vertical; Modulation:802.11ac; Bandwidth:40MHz; Channel:High

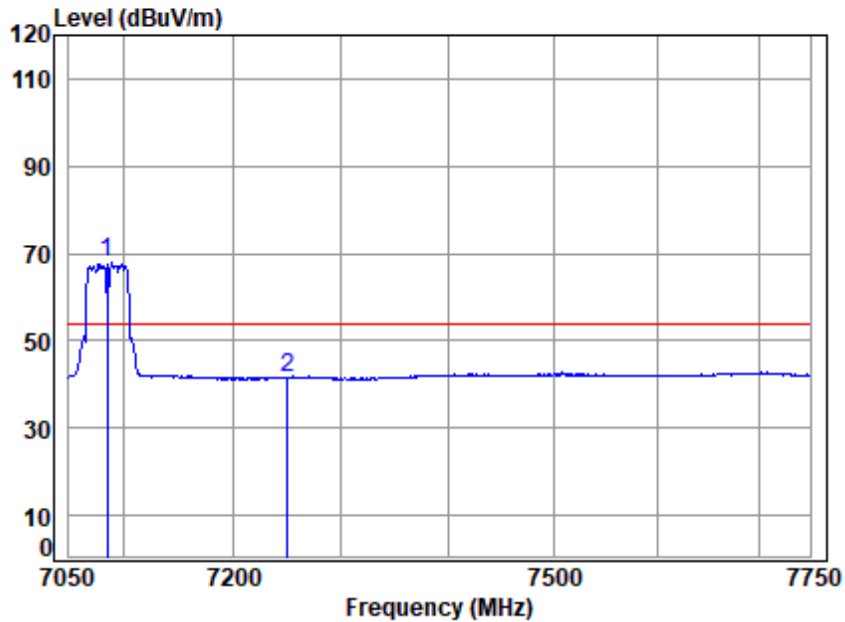

Site : chamber
 Condition: 3m VERTICAL
 Job No : 00955AT/00956AT
 Mode : 7085 Band edge
 : 5G WIFI 11AC40

	Cable	Ant	Preamp	Read	Limit	Over		
Freq	Loss	Factor	Factor	Level	Level	Line	Limit	Remark
MHz	dB	dB/m	dB	dBuV	dBuV/m	dBuV/m	dB	
1 q 7085.000	9.03	35.77	35.66	58.83	67.97	54.00	13.97	Average
2 7250.000	9.23	35.70	35.83	32.39	41.49	54.00	-12.51	Average



Unless otherwise agreed in writing, this document is issued by the Company subject to its General Conditions of Service printed overleaf, available on request or accessible at <https://www.sgs.com/en/Terms-and-Conditions>. Attention is drawn to the limitation of liability, indemnification and jurisdiction issues defined therein. Any holder of this document is advised that information contained hereon reflects the Company's findings at the time of its intervention only and within the limits of Client's instructions, if any. The Company's sole responsibility is to its Client and this document does not exonerate parties to a transaction from exercising all their rights and obligations under the transaction documents. This document cannot be reproduced except in full, without prior written approval of the Company. Any unauthorized alteration, forgery or falsification of the content or appearance of this document is unlawful and offenders may be prosecuted to the fullest extent of the law. Unless otherwise stated the results shown in this test report refer only to the sample(s) tested and such sample(s) are retained for 30 days only.
 Attention: To check the authenticity of testing /inspection report & certificate, please contact us at telephone: (86-755) 8307 1443, or email: CN.Doccheck@sgs.com
 No.1 Workshop, M-10, Middle Section, Science & Technology Park, Nanshan District, Shenzhen, Guangdong, China 518057 t (86-755) 26012053 f (86-755) 26710594 www.sgs.com.cn
 中国·广东·深圳市南山区科技园中区M-10栋1号厂房 邮编: 518057 t (86-755) 26012053 f (86-755) 26710594 sgs.china@sgs.com

Test Mode: 28; Polarity: Horizontal; Modulation:802.11ac; Bandwidth:80MHz; Channel:middle

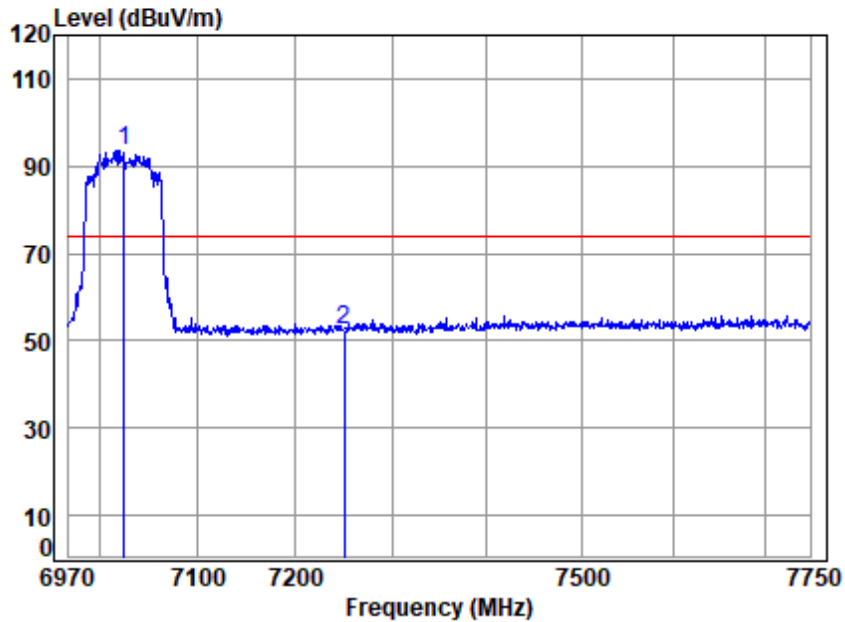

Site : chamber
 Condition: 3m HORIZONTAL
 Job No : 00955AT/00956AT
 Mode : 7025 Band edge
 : 5G WIFI 11AC80

	Cable	Ant	Preamp	Read	Limit	Over	
Freq	Loss	Factor	Factor	Level	Level	Line	Limit Remark
MHz	dB	dB/m	dB	dBuV	dBuV/m	dBuV/m	dB
1 p 7025.000	8.95	35.70	35.60	84.44	93.49	74.00	19.49 peak
2 7250.000	9.23	35.70	35.83	43.59	52.69	74.00	-21.31 peak



Unless otherwise agreed in writing, this document is issued by the Company subject to its General Conditions of Service printed overleaf, available on request or accessible at <https://www.sgs.com/en/Terms-and-Conditions>. Attention is drawn to the limitation of liability, indemnification and jurisdiction issues defined therein. Any holder of this document is advised that information contained hereon reflects the Company's findings at the time of its intervention only and within the limits of Client's instructions, if any. The Company's sole responsibility is to its Client and this document does not exonerate parties to a transaction from exercising all their rights and obligations under the transaction documents. This document cannot be reproduced except in full, without prior written approval of the Company. Any unauthorized alteration, forgery or falsification of the content or appearance of this document is unlawful and offenders may be prosecuted to the fullest extent of the law. Unless otherwise stated the results shown in this test report refer only to the sample(s) tested and such sample(s) are retained for 30 days only.
 Attention: To check the authenticity of testing /inspection report & certificate, please contact us at telephone: (86-755) 8307 1443, or email: CN.Doccheck@sgs.com
 No.1 Workshop, M-10, Middle Section, Science & Technology Park, Nanshan District, Shenzhen, Guangdong, China 518057 t (86-755) 26012053 f (86-755) 26710594 www.sgs.com.cn
 中国·广东·深圳市南山区科技园中区M-10栋1号厂房 邮编: 518057 t (86-755) 26012053 f (86-755) 26710594 sgs.china@sgs.com

Test Mode: 28; Polarity: Horizontal; Modulation:802.11ac; Bandwidth:80MHz; Channel:middle

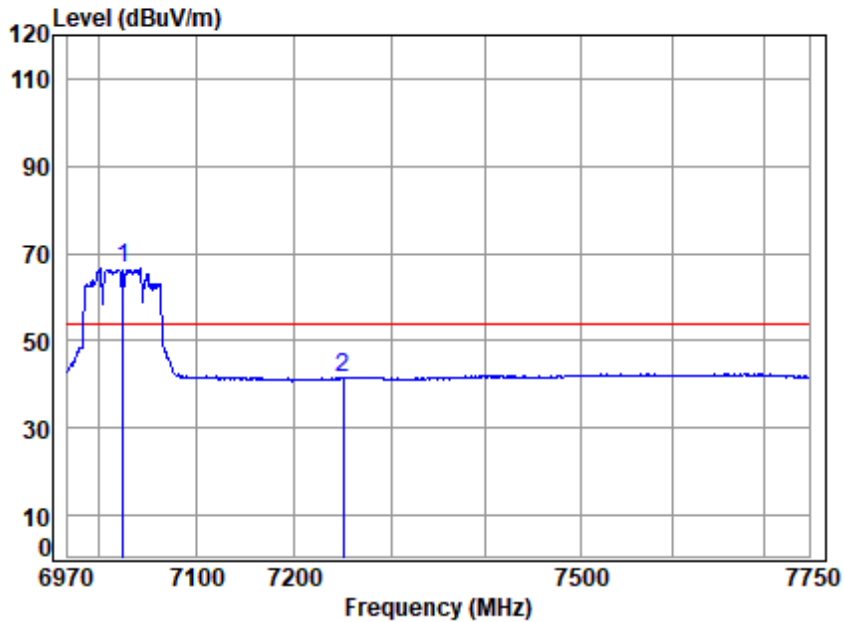

Site : chamber
 Condition: 3m HORIZONTAL
 Job No : 00955AT/00956AT
 Mode : 7025 Band edge
 : 5G WIFI 11AC80

	Cable	Ant	Preamp	Read	Limit	Over		
Freq	Loss	Factor	Factor	Level	Level	Line	Limit	Remark
MHz	dB	dB/m	dB	dBuV	dBuV/m	dBuV/m	dB	
1 q 7025.000	8.95	35.70	35.60	57.65	66.70	54.00	12.70	Average
2 7250.000	9.23	35.70	35.83	32.24	41.34	54.00	-12.66	Average



Unless otherwise agreed in writing, this document is issued by the Company subject to its General Conditions of Service printed overleaf, available on request or accessible at <https://www.sgs.com/en/Terms-and-Conditions>. Attention is drawn to the limitation of liability, indemnification and jurisdiction issues defined therein. Any holder of this document is advised that information contained hereon reflects the Company's findings at the time of its intervention only and within the limits of Client's instructions, if any. The Company's sole responsibility is to its Client and this document does not exonerate parties to a transaction from exercising all their rights and obligations under the transaction documents. This document cannot be reproduced except in full, without prior written approval of the Company. Any unauthorized alteration, forgery or falsification of the content or appearance of this document is unlawful and offenders may be prosecuted to the fullest extent of the law. Unless otherwise stated the results shown in this test report refer only to the sample(s) tested and such sample(s) are retained for 30 days only.
 Attention: To check the authenticity of testing /inspection report & certificate, please contact us at telephone: (86-755) 8307 1443, or email: CN.Doccheck@sgs.com

SGS-CSTC Standards Technical Services Co., Ltd. Shenzhen Branch
 No.1 Workshop, M-10, Middle Section, Science & Technology Park, Nanshan District, Shenzhen, Guangdong, China 518057 t (86-755) 26012053 f (86-755) 26710594 www.sgs.com.cn
 中国·广东·深圳市南山区科技园中区M-10栋1号厂房 邮编: 518057 t (86-755) 26012053 f (86-755) 26710594 sgs.china@sgs.com

Test Mode: 28; Polarity: Vertical; Modulation:802.11ac; Bandwidth:80MHz; Channel:middle

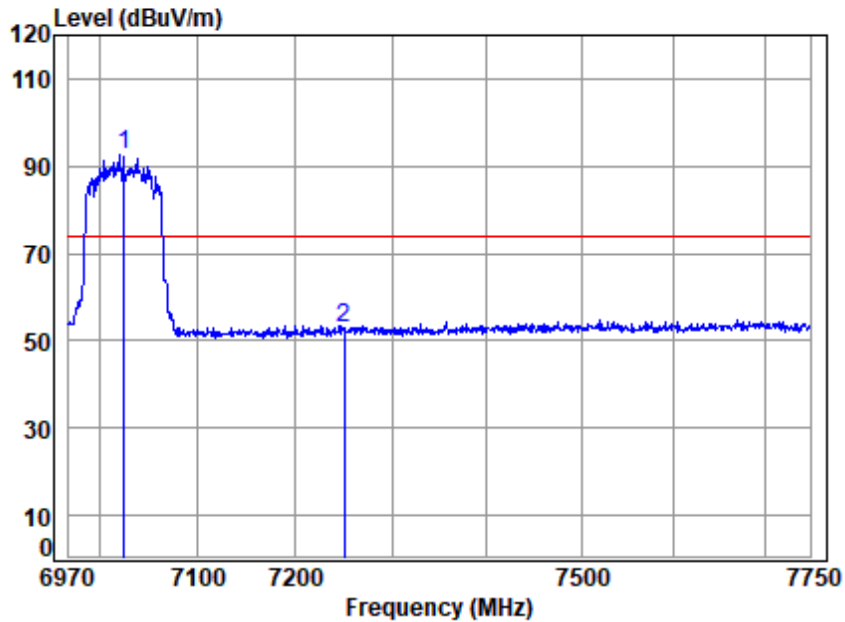

Site : chamber
 Condition: 3m VERTICAL
 Job No : 00955AT/00956AT
 Mode : 7025 Band edge
 : 5G WIFI 11AC80

	Cable	Ant	Preamp	Read	Limit	Over	
Freq	Loss	Factor	Factor	Level	Level	Line	Limit Remark
MHz	dB	dB/m	dB	dBuV	dBuV/m	dBuV/m	dB
1 p 7025.000	8.95	35.70	35.60	83.67	92.72	74.00	18.72 Peak
2 7250.000	9.23	35.70	35.83	43.65	52.75	74.00	-21.25 Peak



Test Mode: 28; Polarity: Vertical; Modulation:802.11ac; Bandwidth:80MHz; Channel:middle

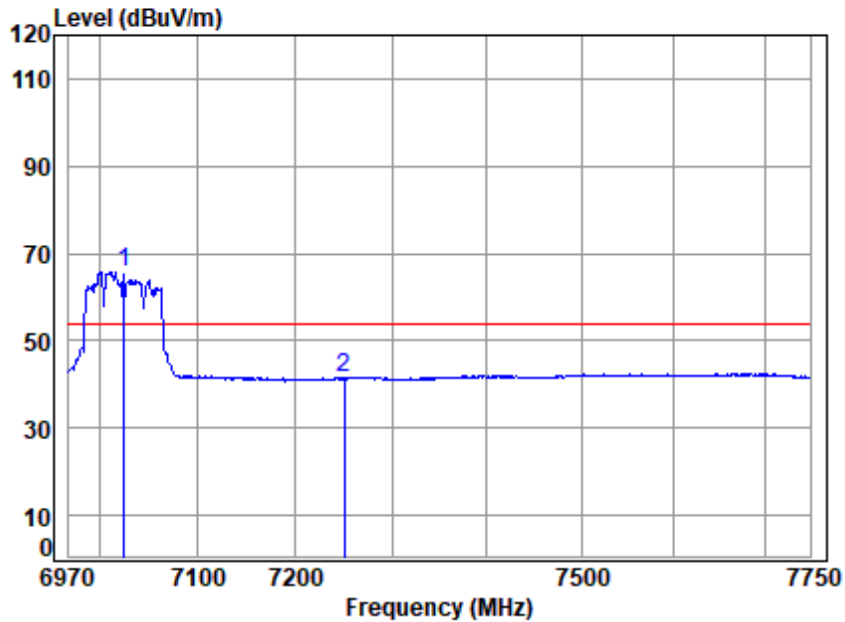

Site : chamber
 Condition: 3m VERTICAL
 Job No : 00955AT/00956AT
 Mode : 7025 Band edge
 : 5G WIFI 11AC80

	Cable	Ant	Preamp	Read	Limit	Over		
Freq	Loss	Factor	Factor	Level	Level	Line	Limit	Remark
MHz	dB	dB/m	dB	dBuV	dBuV/m	dBuV/m	dB	
1 q 7025.000	8.95	35.70	35.60	56.88	65.93	54.00	11.93	Average
2 7250.000	9.23	35.70	35.83	32.35	41.45	54.00	-12.55	Average



Unless otherwise agreed in writing, this document is issued by the Company subject to its General Conditions of Service printed overleaf, available on request or accessible at <https://www.sgs.com/en/Terms-and-Conditions>. Attention is drawn to the limitation of liability, indemnification and jurisdiction issues defined therein. Any holder of this document is advised that information contained hereon reflects the Company's findings at the time of its intervention only and within the limits of Client's instructions, if any. The Company's sole responsibility is to its Client and this document does not exonerate parties to a transaction from exercising all their rights and obligations under the transaction documents. This document cannot be reproduced except in full, without prior written approval of the Company. Any unauthorized alteration, forgery or falsification of the content or appearance of this document is unlawful and offenders may be prosecuted to the fullest extent of the law. Unless otherwise stated the results shown in this test report refer only to the sample(s) tested and such sample(s) are retained for 30 days only.
 Attention: To check the authenticity of testing /inspection report & certificate, please contact us at telephone: (86-755) 8307 1443, or email: CN.Doccheck@sgs.com
 No.1 Workshop, M-10, Middle Section, Science & Technology Park, Nanshan District, Shenzhen, Guangdong, China 518057 t (86-755) 26012053 f (86-755) 26710594 www.sgs.com.cn
 中国·广东·深圳市南山区科技园中区M-10栋1号厂房 邮编: 518057 t (86-755) 26012053 f (86-755) 26710594 sgs.china@sgs.com

7.4 Radiated Emissions (Below 1GHz)

Test Requirement 47 CFR Part 15, Subpart C 15.209 & Subpart E 15.407(b)
 Test Method: KDB 789033 D02 II G
 Measurement Distance: 3m
 Limit:

Frequency(MHz)	Field strength(microvolts/meter)	Measurement distance(meters)
0.009-0.490	2400/F(kHz)	300
0.490-1.705	24000/F(kHz)	30
1.705-30.0	30	30
30-88	100	3
88-216	150	3
216-960	200	3
960-1000	500	3

7.4.1 E.U.T. Operation

Operating Environment:
 Temperature: 23.2 °C Humidity: 50.5 % RH Atmospheric Pressure: 1020 mbar

7.4.2 Test Mode Description

Pre-scan / Final test	Mode Code	Description
Pre-scan	21	TX mode (U-NII-1)_Keep the EUT in continuously transmitting mode with all modulation types. All data rates for each modulation type have been tested and found the data rate @ 6Mbps is the worst case of IEEE 802.11a; data rate @ HT0/HT8 is the worst case of IEEE 802.11n(HT20); data rate @ HT0/HT8 is the worst case of IEEE 802.11n(HT40); data rate @ VHT0 is the worst case of IEEE 802.11ac(HT80); data rate @ VHT0 is the worst case of IEEE 802.11ac(HT160); data rate @ HE0 is the worst case of IEEE 802.11ax(HT20); data rate @ HE0 is the worst case of IEEE 802.11ax(HT40); data rate @ HE0 is the worst case of IEEE 802.11ax(HT80); data rate @ HE0 is the worst case of IEEE 802.11ax(HT160). Only the data of worst case is recorded in the report.
Pre-scan	22	TX mode (U-NII-2A)_Keep the EUT in continuously transmitting mode with all modulation types. All data rates for each modulation type have been tested and found the data rate @ 6Mbps is the worst case of IEEE 802.11a; data rate @ HT0/HT8 is the worst case of IEEE 802.11n(HT20); data rate @ HT0/HT8 is the worst case of IEEE 802.11n(HT40); data rate @ VHT0 is the worst case of IEEE 802.11ac(HT80); data rate @ HE0 is the worst case of IEEE 802.11ax(HT20); data rate @ HE0 is the worst case of IEEE 802.11ax(HT40); data rate @ HE0 is the worst case of IEEE 802.11ax(HT80). Only the data of worst case is recorded in the report.
Pre-scan	23	TX mode (U-NII-2C)_Keep the EUT in continuously transmitting mode with all modulation types.All data rates for each modulation type have been tested and found the data rate @ 6Mbps is the worst case of IEEE 802.11a; data rate @ HT0/HT8 is the worst case of IEEE 802.11n(HT20); data rate @ HT0/HT8 is the worst case of



Unless otherwise agreed in writing, this document is issued by the Company subject to its General Conditions of Service printed overleaf, available on request or accessible at <https://www.sgs.com/en/Terms-and-Conditions>. Attention is drawn to the limitation of liability, indemnification and jurisdiction issues defined therein. Any holder of this document is advised that information contained hereon reflects the Company's findings at the time of its intervention only and within the limits of Client's instructions, if any. The Company's sole responsibility is to its Client and this document does not exonerate parties to a transaction from exercising all their rights and obligations under the transaction documents. This document cannot be reproduced except in full, without prior written approval of the Company. Any unauthorized alteration, forgery or falsification of the content or appearance of this document is unlawful and offenders may be prosecuted to the fullest extent of the law. Unless otherwise stated the results shown in this test report refer only to the sample(s) tested and such sample(s) are retained for 30 days only.
 Attention: To check the authenticity of testing /inspection report & certificate, please contact us at telephone: (86-755) 8307 1443, or email: CN.Doccheck@sgs.com
 No.1 Workshop, M-10, Middle Section, Science & Technology Park, Nanshan District, Shenzhen, Guangdong, China 518057 t (86-755) 26012053 f (86-755) 26710594 www.sgs.com.cn
 中国·广东·深圳市南山区科技园中区M-10栋1号厂房 邮编: 518057 t (86-755) 26012053 f (86-755) 26710594 sgs.china@sgs.com

		IEEE 802.11n(HT40); data rate @ VHT0 is the worst case of IEEE 802.11ac(HT80); data rate @ VHT0 is the worst case of IEEE 802.11ac(HT160); data rate @ HE0 is the worst case of IEEE 802.11ax(HT20); data rate @ HE0 is the worst case of IEEE 802.11ax(HT40); data rate @ HE0 is the worst case of IEEE 802.11ax(HT80); data rate @ HE0 is the worst case of IEEE 802.11ax(HT160). Only the data of worst case is recorded in the report.
Pre-scan	24	TX mode (U-NII-3)_Keep the EUT in continuously transmitting mode with all modulation types.All data rates for each modulation type have been tested and found the data rate @ 6Mbps is the worst case of IEEE 802.11a; data rate @ HT0/HT8 is the worst case of IEEE 802.11n(HT20); data rate @ HT0/HT8 is the worst case of IEEE 802.11n(HT40); data rate @ VHT0 is the worst case of IEEE 802.11ac(HT80); data rate @ HE0 is the worst case of IEEE 802.11ax(HT20); data rate @ HE0 is the worst case of IEEE 802.11ax(HT40); data rate @ HE0 is the worst case of IEEE 802.11ax(HT80). Only the data of worst case is recorded in the report.
Pre-scan	25	TX mode (U-NII-5)_Keep the EUT in continuously transmitting mode with all modulation types. All data rates for each modulation type have been tested and found the data rate @ 6Mbps is the worst case of IEEE 802.11a; data rate @ HT0/HT8 is the worst case of IEEE 802.11n(HT20); data rate @ HT0/HT8 is the worst case of IEEE 802.11n(HT40); data rate @ VHT0 is the worst case of IEEE 802.11ac(HT80); data rate @ VHT0 is the worst case of IEEE 802.11ac(HT160); data rate @ HE0 is the worst case of IEEE 802.11ax(HT20); data rate @ HE0 is the worst case of IEEE 802.11ax(HT40); data rate @ HE0 is the worst case of IEEE 802.11ax(HT80); data rate @ HE0 is the worst case of IEEE 802.11ax(HT160). Only the data of worst case is recorded in the report.
Pre-scan	26	TX mode (U-NII-6)_Keep the EUT in continuously transmitting mode with all modulation types. All data rates for each modulation type have been tested and found the data rate @ 6Mbps is the worst case of IEEE 802.11a; data rate @ HT0/HT8 is the worst case of IEEE 802.11n(HT20); data rate @ HT0/HT8 is the worst case of IEEE 802.11n(HT40); data rate @ VHT0 is the worst case of IEEE 802.11ac(HT80); data rate @ VHT0 is the worst case of IEEE 802.11ac(HT160); data rate @ HE0 is the worst case of IEEE 802.11ax(HT20); data rate @ HE0 is the worst case of IEEE 802.11ax(HT40); data rate @ HE0 is the worst case of IEEE 802.11ax(HT80); data rate @ HE0 is the worst case of IEEE 802.11ax(HT160). Only the data of worst case is recorded in the report.
Pre-scan	27	TX mode (U-NII-7)_Keep the EUT in continuously transmitting mode with all modulation types. All data rates for each modulation type have been tested and found the data rate @ 6Mbps is the worst case of IEEE 802.11a; data rate @ HT0/HT8 is the worst case of IEEE 802.11n(HT20); data rate @ HT0/HT8 is the worst case of IEEE 802.11n(HT40); data rate @ VHT0 is the worst case of IEEE 802.11ac(HT80); data rate @ VHT0 is the worst case of IEEE 802.11ac(HT160); data rate @ HE0 is the worst case of IEEE 802.11ax(HT20); data rate @ HE0 is the worst case of IEEE 802.11ax(HT40); data rate @ HE0 is the worst case of IEEE 802.11ax(HT80); data rate @ HE0 is the worst case of IEEE 802.11ax(HT160). Only the data of worst case is recorded in the report.
Final test	28	TX mode (U-NII-8)_Keep the EUT in continuously transmitting mode with all modulation types. All data rates for each modulation type have been tested and found the data rate @ 6Mbps is the worst case of IEEE 802.11a; data rate @ HT0/HT8 is the worst case of IEEE 802.11n(HT20); data rate @ HT0/HT8 is the worst case of IEEE 802.11n(HT40); data rate @ VHT0 is the worst case of IEEE 802.11ac(HT80); data rate @ VHT0 is the worst case of IEEE 802.11ac(HT160); data rate @ HE0 is the worst case of IEEE 802.11ax(HT20); data rate @ HE0 is the worst



Unless otherwise agreed in writing, this document is issued by the Company subject to its General Conditions of Service printed overleaf, available on request or accessible at <https://www.sgs.com/en/Terms-and-Conditions>. Attention is drawn to the limitation of liability, indemnification and jurisdiction issues defined therein. Any holder of this document is advised that information contained hereon reflects the Company's findings at the time of its intervention only and within the limits of Client's instructions, if any. The Company's sole responsibility is to its Client and this document does not exonerate parties to a transaction from exercising all their rights and obligations under the transaction documents. This document cannot be reproduced except in full, without prior written approval of the Company. Any unauthorized alteration, forgery or falsification of the content or appearance of this document is unlawful and offenders may be prosecuted to the fullest extent of the law. Unless otherwise stated the results shown in this test report refer only to the sample(s) tested and such sample(s) are retained for 30 days only.

		case of IEEE 802.11ax(HT40); data rate @ HE0 is the worst case of IEEE 802.11ax(HT80); data rate @ HE0 is the worst case of IEEE 802.11ax(HT160). Only the data of worst case is recorded in the report.
--	--	--

7.4.3 Test Setup Diagram

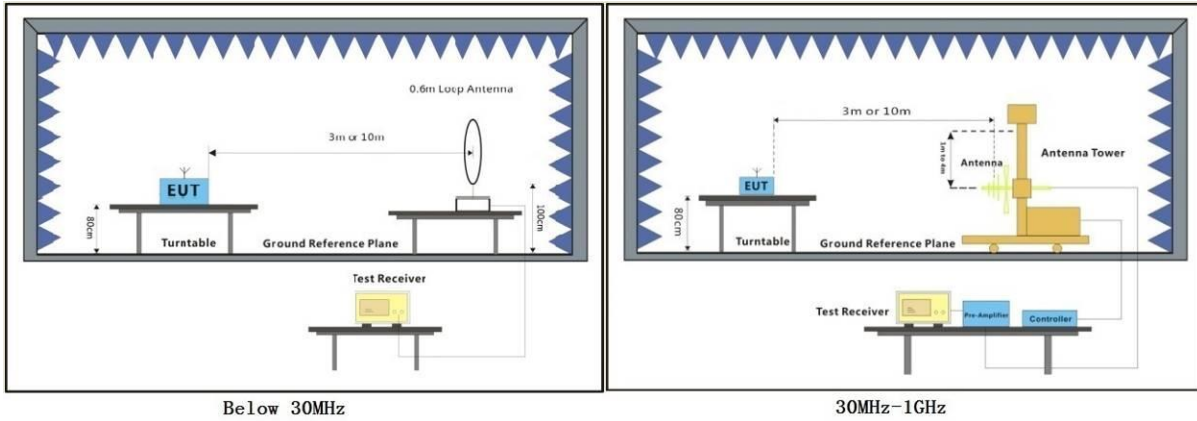

Unless otherwise agreed in writing, this document is issued by the Company subject to its General Conditions of Service printed overleaf, available on request or accessible at <https://www.sgs.com/en/Terms-and-Conditions>. Attention is drawn to the limitation of liability, indemnification and jurisdiction issues defined therein. Any holder of this document is advised that information contained hereon reflects the Company's findings at the time of its intervention only and within the limits of Client's instructions, if any. The Company's sole responsibility is to its Client and this document does not exonerate parties to a transaction from exercising all their rights and obligations under the transaction documents. This document cannot be reproduced except in full, without prior written approval of the Company. Any unauthorized alteration, forgery or falsification of the content or appearance of this document is unlawful and offenders may be prosecuted to the fullest extent of the law. Unless otherwise stated the results shown in this test report refer only to the sample(s) tested and such sample(s) are retained for 30 days only.

Attention: To check the authenticity of testing /inspection report & certificate, please contact us at telephone: (86-755) 8307 1443, or email: CN.Doccheck@sgs.com

7.4.4 Measurement Procedure and Data

- a. For below 1GHz, the EUT was placed on the top of a rotating table 0.8 meters above the ground at a 3 meter semi-anechoic chamber. The table was rotated 360 degrees to determine the position of the highest radiation.
- b. The EUT was set 3 or 10 meters away from the interference-receiving antenna, which was mounted on the top of a variable-height antenna tower.
- c. The antenna height is varied from one meter to four meters above the ground to determine the maximum value of the field strength. Both horizontal and vertical polarizations of the antenna are set to make the measurement.
- d. For each suspected emission, the EUT was arranged to its worst case and then the antenna was tuned to heights from 1 meter to 4 meters (for the test frequency of below 30MHz, the antenna was tuned to heights 1 meter) and the rotatable table was turned from 0 degrees to 360 degrees to find the maximum reading.
- e. The test-receiver system was set to Peak Detect Function and Specified Bandwidth with Maximum Hold Mode.
- f. If the emission level of the EUT in peak mode was 10dB lower than the limit specified, then testing could be stopped and the peak values of the EUT would be reported. Otherwise the emissions that did not have 10dB margin would be re-tested one by one using quasi-peak method as specified and then reported in a data sheet.
- g. Test the EUT in the lowest channel, the middle channel, the Highest channel.
- h. The radiation measurements are performed in X, Y, Z axis positioning for Transmitting mode, and found the X axis positioning which it is the worst case.
- i. Repeat above procedures until all frequencies measured was complete.

Remark:

- 1. Level= Read Level+ Cable Loss+ Antenna Factor- Preamp Factor
- 2. For emission below 1GHz, through the pre-scan found the worst case is the lowest channel of 802.11a. Only the worst case is recorded in the report.
- 3. Scan from 9kHz to 30MHz, the disturbance below 30MHz was very low. The points marked on above plots are the highest emissions could be found when testing, so only above points had been displayed. The amplitude of spurious emissions from the radiator which are attenuated more than 20dB below the limit need not be reported.



Test Mode: 28; Polarity: Horizontal

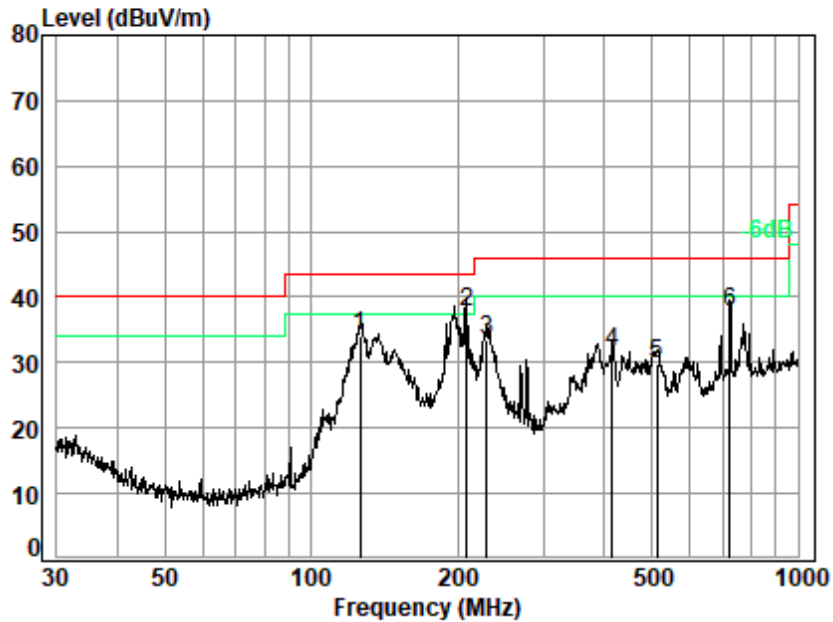

Site : chamber
 Condition: 3m HORIZONTAL
 Job No. : 00955AT
 Test Mode: 28

	Ant Freq	Cable Factor	Preamp Loss	Read Level	Limit Level	Over Limit	Remark	
	MHz	dB/m	dB	dBuV	dBuV/m	dBuV/m	dB	
1	125.89	10.98	1.33	27.52	49.30	34.09	43.50	-9.41 QP
2 q	208.58	14.74	1.77	27.22	48.58	37.87	43.50	-5.63 QP
3	229.29	16.34	1.86	27.14	42.50	33.56	46.00	-12.44 QP
4	414.72	20.52	2.60	27.40	35.77	31.49	46.00	-14.51 QP
5	513.63	23.26	2.93	27.84	31.56	29.91	46.00	-16.09 QP
6	724.26	26.22	3.59	27.84	35.70	37.67	46.00	-8.33 QP



Unless otherwise agreed in writing, this document is issued by the Company subject to its General Conditions of Service printed overleaf, available on request or accessible at <https://www.sgs.com/en/Terms-and-Conditions>. Attention is drawn to the limitation of liability, indemnification and jurisdiction issues defined therein. Any holder of this document is advised that information contained hereon reflects the Company's findings at the time of its intervention only and within the limits of Client's instructions, if any. The Company's sole responsibility is to its Client and this document does not exonerate parties to a transaction from exercising all their rights and obligations under the transaction documents. This document cannot be reproduced except in full, without prior written approval of the Company. Any unauthorized alteration, forgery or falsification of the content or appearance of this document is unlawful and offenders may be prosecuted to the fullest extent of the law. Unless otherwise stated the results shown in this test report refer only to the sample(s) tested and such sample(s) are retained for 30 days only.

Test Mode: 28; Polarity: Vertical

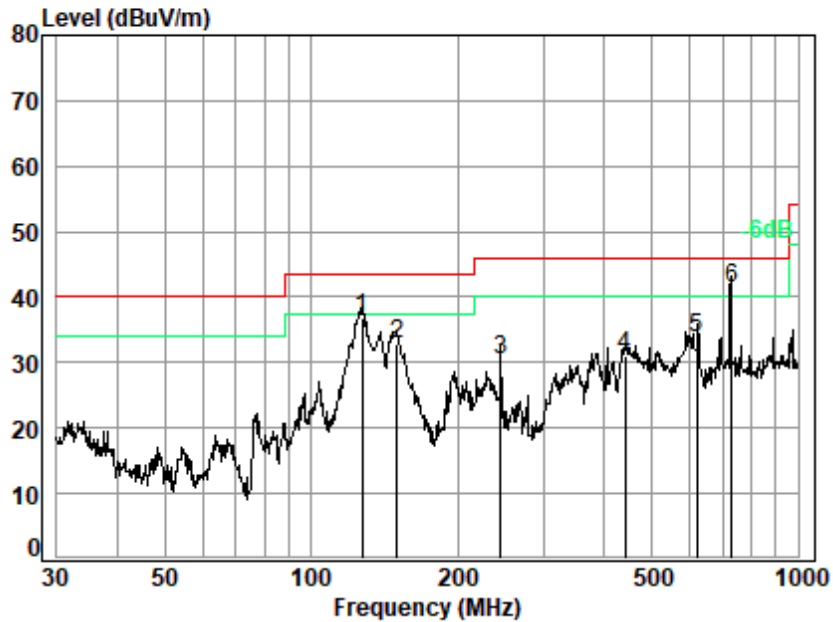

Site : chamber
 Condition: 3m VERTICAL
 Job No. : 00955AT
 Test Mode: 28

	Ant Freq	Cable Factor	Preamp Loss	Read Level	Limit Level	Over Limit	Remark	
	MHz	dB/m	dB	dBuV	dBuV/m	dBuV/m	dB	
1	127.22	10.98	1.34	27.51	51.94	36.75	43.50 -6.75	QP
2	150.01	13.04	1.46	27.43	45.73	32.80	43.50 -10.70	QP
3	245.09	17.10	1.93	27.09	38.56	30.50	46.00 -15.50	QP
4	441.74	21.09	2.69	27.52	34.65	30.91	46.00 -15.09	QP
5	620.71	25.07	3.27	28.17	33.66	33.83	46.00 -12.17	QP
6 q	729.36	26.12	3.60	27.83	39.46	41.35	46.00 -4.65	QP



Unless otherwise agreed in writing, this document is issued by the Company subject to its General Conditions of Service printed overleaf, available on request or accessible at <https://www.sgs.com/en/Terms-and-Conditions>. Attention is drawn to the limitation of liability, indemnification and jurisdiction issues defined therein. Any holder of this document is advised that information contained hereon reflects the Company's findings at the time of its intervention only and within the limits of Client's instructions, if any. The Company's sole responsibility is to its Client and this document does not exonerate parties to a transaction from exercising all their rights and obligations under the transaction documents. This document cannot be reproduced except in full, without prior written approval of the Company. Any unauthorized alteration, forgery or falsification of the content or appearance of this document is unlawful and offenders may be prosecuted to the fullest extent of the law. Unless otherwise stated the results shown in this test report refer only to the sample(s) tested and such sample(s) are retained for 30 days only.

7.5 Radiated Emissions (Above 1GHz)

Test Requirement 47 CFR Part 15, Subpart C 15.209 & Subpart E 15.407(b)
 Test Method: KDB 789033 D02 II G
 Measurement Distance: 3m
 Limit:

Frequency(MHz)	Field strength(microvolts/meter)	Measurement distance(meters)
Above 1GHz	500	3
<p>*(1) For transmitters operating in the 5.15-5.25 GHz band: All emissions outside of the 5.15-5.35 GHz band shall not exceed an e.i.r.p. of -27 dBm/MHz.</p> <p>(2) For transmitters operating in the 5.25-5.35 GHz band: All emissions outside of the 5.15-5.35 GHz band shall not exceed an e.i.r.p. of -27 dBm/MHz.</p> <p>(3) For transmitters operating in the 5.47-5.725 GHz band: All emissions outside of the 5.47-5.725 GHz band shall not exceed an e.i.r.p. of -27 dBm/MHz.</p> <p>(4) For transmitters operating in the 5.725-5.85 GHz band:</p> <p>(i) All emissions shall be limited to a level of -27 dBm/MHz at 75 MHz or more above or below the band edge increasing linearly to 10 dBm/MHz at 25 MHz above or below the band edge, and from 25 MHz above or below the band edge increasing linearly to a level of 15.6 dBm/MHz at 5 MHz above or below the band edge, and from 5 MHz above or below the band edge increasing linearly to a level of 27 dBm/MHz at the band edge.</p> <p>Remark: The emission limits shown in the above table are based on measurements employing a CISPR quasi-peak detector except for the frequency bands 9-90kHz, 110-490kHz and above 1000 MHz. Radiated emission limits in these three bands are based on measurements employing an average detector, the peak field strength of any emission shall not exceed the maximum permitted average limits specified above by more than 20 dB under any condition of modulation.</p>		

7.5.1 E.U.T. Operation

Operating Environment:
 Temperature: 21.9 °C Humidity: 54.4 % RH Atmospheric Pressure: 1020 mbar

7.5.2 Test Mode Description

Pre-scan / Final test	Mode Code	Description
Final test	21	TX mode (U-NII-1)_Keep the EUT in continuously transmitting mode with all modulation types. All data rates for each modulation type have been tested and found the data rate @ 6Mbps is the worst case of IEEE 802.11a; data rate @ HT0/HT8 is the worst case of IEEE 802.11n(HT20); data rate @ HT0/HT8 is the worst case of IEEE 802.11n(HT40); data rate @ VHT0 is the worst case of IEEE 802.11ac(HT80); data rate @ VHT0 is the worst case of IEEE 802.11ac(HT160); data rate @ HE0 is the worst case of IEEE 802.11ax(HT20); data rate @ HE0 is the worst case of IEEE 802.11ax(HT40); data rate @ HE0 is the worst case of IEEE 802.11ax(HT80); data rate @ HE0 is the worst case of IEEE 802.11ax(HT160). Only the data of worst case is recorded in the report.



Unless otherwise agreed in writing, this document is issued by the Company subject to its General Conditions of Service printed overleaf, available on request or accessible at <https://www.sgs.com/en/Terms-and-Conditions>. Attention is drawn to the limitation of liability, indemnification and jurisdiction issues defined therein. Any holder of this document is advised that information contained hereon reflects the Company's findings at the time of its intervention only and within the limits of Client's instructions, if any. The Company's sole responsibility is to its Client and this document does not exonerate parties to a transaction from exercising all their rights and obligations under the transaction documents. This document cannot be reproduced except in full, without prior written approval of the Company. Any unauthorized alteration, forgery or falsification of the content or appearance of this document is unlawful and offenders may be prosecuted to the fullest extent of the law. Unless otherwise stated the results shown in this test report refer only to the sample(s) tested and such sample(s) are retained for 30 days only.
 Attention: To check the authenticity of testing /inspection report & certificate, please contact us at telephone: (86-755) 8307 1443, or email: CN.Doccheck@sgs.com
 No.1 Workshop, M-10, Middle Section, Science & Technology Park, Nanshan District, Shenzhen, Guangdong, China 518057 t (86-755) 26012053 f (86-755) 26710594 www.sgs.com.cn
 中国·广东·深圳市南山区科技园中区M-10栋1号厂房 邮编: 518057 t (86-755) 26012053 f (86-755) 26710594 sgs.china@sgs.com

Final test	22	TX mode (U-NII-2A)_Keep the EUT in continuously transmitting mode with all modulation types. All data rates for each modulation type have been tested and found the data rate @ 6Mbps is the worst case of IEEE 802.11a; data rate @ HT0/HT8 is the worst case of IEEE 802.11n(HT20); data rate @ HT0/HT8 is the worst case of IEEE 802.11n(HT40); data rate @ VHT0 is the worst case of IEEE 802.11ac(HT80); data rate @ HE0 is the worst case of IEEE 802.11ax(HT20); data rate @ HE0 is the worst case of IEEE 802.11ax(HT40); data rate @ HE0 is the worst case of IEEE 802.11ax(HT80). Only the data of worst case is recorded in the report.
Final test	23	TX mode (U-NII-2C)_Keep the EUT in continuously transmitting mode with all modulation types.All data rates for each modulation type have been tested and found the data rate @ 6Mbps is the worst case of IEEE 802.11a; data rate @ HT0/HT8 is the worst case of IEEE 802.11n(HT20); data rate @ HT0/HT8 is the worst case of IEEE 802.11n(HT40); data rate @ VHT0 is the worst case of IEEE 802.11ac(HT80); data rate @ VHT0 is the worst case of IEEE 802.11ac(HT160); data rate @ HE0 is the worst case of IEEE 802.11ax(HT20); data rate @ HE0 is the worst case of IEEE 802.11ax(HT40); data rate @ HE0 is the worst case of IEEE 802.11ax(HT80); data rate @ HE0 is the worst case of IEEE 802.11ax(HT160). Only the data of worst case is recorded in the report.
Final test	24	TX mode (U-NII-3)_Keep the EUT in continuously transmitting mode with all modulation types.All data rates for each modulation type have been tested and found the data rate @ 6Mbps is the worst case of IEEE 802.11a; data rate @ HT0/HT8 is the worst case of IEEE 802.11n(HT20); data rate @ HT0/HT8 is the worst case of IEEE 802.11n(HT40); data rate @ VHT0 is the worst case of IEEE 802.11ac(HT80); data rate @ HE0 is the worst case of IEEE 802.11ax(HT20); data rate @ HE0 is the worst case of IEEE 802.11ax(HT40); data rate @ HE0 is the worst case of IEEE 802.11ax(HT80). Only the data of worst case is recorded in the report.
Final test	25	TX mode (U-NII-5)_Keep the EUT in continuously transmitting mode with all modulation types. All data rates for each modulation type have been tested and found the data rate @ 6Mbps is the worst case of IEEE 802.11a; data rate @ HT0/HT8 is the worst case of IEEE 802.11n(HT20); data rate @ HT0/HT8 is the worst case of IEEE 802.11n(HT40); data rate @ VHT0 is the worst case of IEEE 802.11ac(HT80); data rate @ VHT0 is the worst case of IEEE 802.11ac(HT160); data rate @ HE0 is the worst case of IEEE 802.11ax(HT20); data rate @ HE0 is the worst case of IEEE 802.11ax(HT40); data rate @ HE0 is the worst case of IEEE 802.11ax(HT80); data rate @ HE0 is the worst case of IEEE 802.11ax(HT160). Only the data of worst case is recorded in the report.
Final test	26	TX mode (U-NII-6)_Keep the EUT in continuously transmitting mode with all modulation types. All data rates for each modulation type have been tested and found the data rate @ 6Mbps is the worst case of IEEE 802.11a; data rate @ HT0/HT8 is the worst case of IEEE 802.11n(HT20); data rate @ HT0/HT8 is the worst case of IEEE 802.11n(HT40); data rate @ VHT0 is the worst case of IEEE 802.11ac(HT80); data rate @ VHT0 is the worst case of IEEE 802.11ac(HT160); data rate @ HE0 is the worst case of IEEE 802.11ax(HT20); data rate @ HE0 is the worst case of IEEE 802.11ax(HT40); data rate @ HE0 is the worst case of IEEE 802.11ax(HT80); data rate @ HE0 is the worst case of IEEE 802.11ax(HT160). Only the data of worst case is recorded in the report.
Final test	27	TX mode (U-NII-7)_Keep the EUT in continuously transmitting mode with all modulation types. All data rates for each modulation type have been tested and found the data rate @ 6Mbps is the worst case of IEEE 802.11a; data rate @ HT0/HT8 is the worst case of IEEE 802.11n(HT20); data rate @ HT0/HT8 is the worst case of IEEE 802.11n(HT40); data rate @ VHT0 is the worst case of IEEE



Unless otherwise agreed in writing, this document is issued by the Company subject to its General Conditions of Service printed overleaf, available on request or accessible at <https://www.sgs.com/en/Terms-and-Conditions>. Attention is drawn to the limitation of liability, indemnification and jurisdiction issues defined therein. Any holder of this document is advised that information contained hereon reflects the Company's findings at the time of its intervention only and within the limits of Client's instructions, if any. The Company's sole responsibility is to its Client and this document does not exonerate parties to a transaction from exercising all their rights and obligations under the transaction documents. This document cannot be reproduced except in full, without prior written approval of the Company. Any unauthorized alteration, forgery or falsification of the content or appearance of this document is unlawful and offenders may be prosecuted to the fullest extent of the law. Unless otherwise stated the results shown in this test report refer only to the sample(s) tested and such sample(s) are retained for 30 days only.

		802.11ac(HT80); data rate @ VHT0 is the worst case of IEEE 802.11ac(HT160); data rate @ HE0 is the worst case of IEEE 802.11ax(HT20); data rate @ HE0 is the worst case of IEEE 802.11ax(HT40); data rate @ HE0 is the worst case of IEEE 802.11ax(HT80); data rate @ HE0 is the worst case of IEEE 802.11ax(HT160). Only the data of worst case is recorded in the report.
Final test	28	TX mode (U-NII-8)_Keep the EUT in continuously transmitting mode with all modulation types. All data rates for each modulation type have been tested and found the data rate @ 6Mbps is the worst case of IEEE 802.11a; data rate @ HT0/HT8 is the worst case of IEEE 802.11n(HT20); data rate @ HT0/HT8 is the worst case of IEEE 802.11n(HT40); data rate @ VHT0 is the worst case of IEEE 802.11ac(HT80); data rate @ VHT0 is the worst case of IEEE 802.11ac(HT160); data rate @ HE0 is the worst case of IEEE 802.11ax(HT20); data rate @ HE0 is the worst case of IEEE 802.11ax(HT40); data rate @ HE0 is the worst case of IEEE 802.11ax(HT80); data rate @ HE0 is the worst case of IEEE 802.11ax(HT160). Only the data of worst case is recorded in the report.

7.5.3 Test Setup Diagram

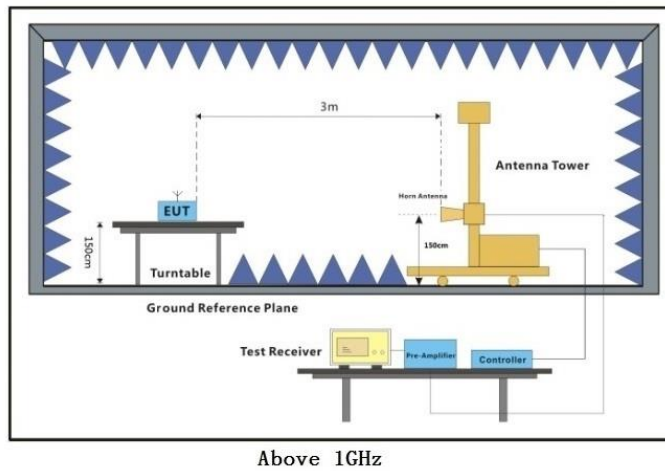

7.5.4 Measurement Procedure and Data

- a. For above 1GHz, the EUT was placed on the top of a rotating table 1.5 meters above the ground at a 3 meter fully-anechoic chamber. The table was rotated 360 degrees to determine the position of the highest radiation.
- b. The EUT was set 3 meters away from the interference-receiving antenna, which was mounted on the top of a variable-height antenna tower.
- c. The antenna height is varied from one meter to four meters above the ground to determine the maximum value of the field strength. Both horizontal and vertical polarizations of the antenna are set to make the measurement.
- d. For each suspected emission, the EUT was arranged to its worst case and then the antenna was tuned to heights from 1 meter to 4 meters (for the test frequency of below 30MHz, the antenna was tuned to heights 1 meter) and the rotatable table was turned from 0 degrees to 360 degrees to find the maximum reading.
- e. The test-receiver system was set to Peak Detect Function and Specified Bandwidth with Maximum Hold Mode.
- f. If the emission level of the EUT in peak mode was 10dB lower than the limit specified, then testing could be stopped and the peak values of the EUT would be reported. Otherwise the emissions that did not have 10dB margin would be re-tested one by one using peak or average method as specified and then reported in a data sheet.
- g. Test the EUT in the lowest channel, the middle channel, the Highest channel.
- h. The radiation measurements are performed in X, Y, Z axis positioning for Transmitting mode, and found the X axis positioning which it is the worst case.
- i. Repeat above procedures until all frequencies measured was complete.

Remark:

- 1. Level= Read Level+ Cable Loss+ Antenna Factor- Preamp Factor
- 2. Scan from 18GHz to 40GHz, the disturbance above 18GHz was very low. The points marked on above plots are the highest emissions could be found when testing, so only above points had been displayed. The amplitude of spurious emissions from the radiator which are attenuated more than 20dB below the limit need not be reported.
- 3. As shown in this section, for frequencies above 1GHz, the field strength limits are based on average limits. However, the peak field strength of any emission shall not exceed the maximum permitted average limits specified above by more than 20 dB under any condition of modulation. For the emissions whose peak level is lower than the average limit, only the peak measurement is shown in the report.
- 4. The disturbance above 18GHz were very low and the harmonics were the highest point could be found when testing, so only the above harmonics had been displayed.
- 5. For devices with multiple operating modes, measurements on the middle channel is used to determine the worst-case mode(s). Only the worst case mode with the highest output power and the mode with the highest output power spectral density for each modulation family (e.g., OFDM and direct sequence spread spectrum) is recorded in the test report.
- 6. All modes and channels have been tested, only record the worst test result.



Test Mode: 21; Polarity: Horizontal; Modulation:802.11a; Bandwidth:20MHz; Channel:Low

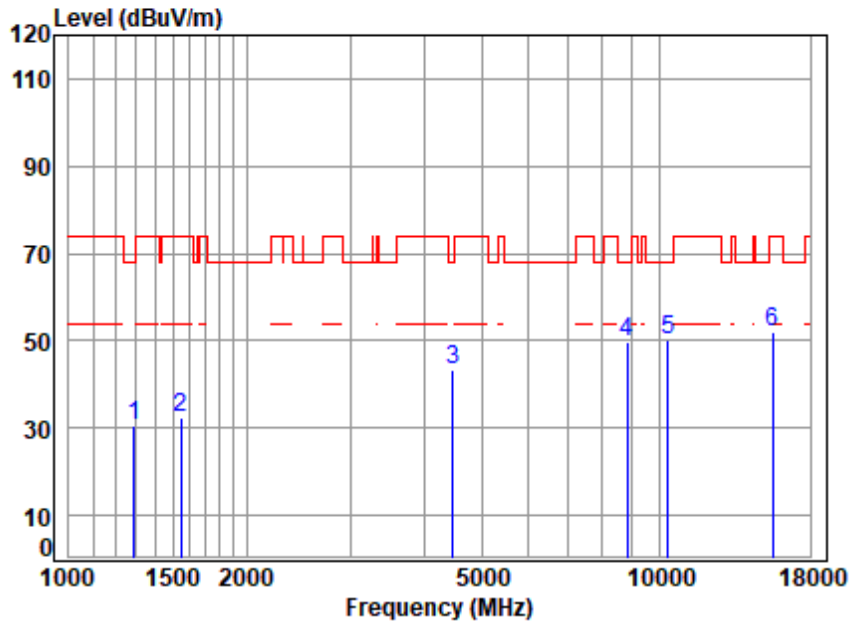

Site : chamber
 Condition: 3m HORIZONTAL
 Job No : 00955AT/00956AT
 Mode : 5180 TX RSE
 Note : 5G WIFI 11A

	Freq	Cable Loss	Ant Factor	Preamp Factor	Read Level	Level	Limit Line	Over Limit	Remark
	MHz	dB	dB/m	dB	dBuV	dBuV/m	dBuV/m	dB	
1	1289.627	3.74	24.86	38.36	40.17	30.41	68.20	-37.79	peak
2	1547.199	4.13	26.99	38.39	39.72	32.45	74.00	-41.55	peak
3	4469.214	7.10	33.97	35.75	37.97	43.29	68.20	-24.91	peak
4	8814.957	11.60	37.13	37.42	38.22	49.53	68.20	-18.67	peak
5	p10360.000	12.73	37.10	37.54	37.72	50.01	68.20	-18.19	peak
6	15540.000	14.23	41.10	37.23	33.86	51.96	74.00	-22.04	peak



Unless otherwise agreed in writing, this document is issued by the Company subject to its General Conditions of Service printed overleaf, available on request or accessible at <https://www.sgs.com/en/Terms-and-Conditions>. Attention is drawn to the limitation of liability, indemnification and jurisdiction issues defined therein. Any holder of this document is advised that information contained hereon reflects the Company's findings at the time of its intervention only and within the limits of Client's instructions, if any. The Company's sole responsibility is to its Client and this document does not exonerate parties to a transaction from exercising all their rights and obligations under the transaction documents. This document cannot be reproduced except in full, without prior written approval of the Company. Any unauthorized alteration, forgery or falsification of the content or appearance of this document is unlawful and offenders may be prosecuted to the fullest extent of the law. Unless otherwise stated the results shown in this test report refer only to the sample(s) tested and such sample(s) are retained for 30 days only.

Attention: To check the authenticity of testing /inspection report & certificate, please contact us at telephone: (86-755) 8307 1443, or email: CN.Doccheck@sgs.com
 No.1 Workshop, M-10, Middle Section, Science & Technology Park, Nanshan District, Shenzhen, Guangdong, China 518057 t (86-755) 26012053 f (86-755) 26710594 www.sgs.com.cn
 中国·广东·深圳市南山区科技园中区M-10栋1号厂房 邮编: 518057 t (86-755) 26012053 f (86-755) 26710594 sgs.china@sgs.com

Test Mode: 21; Polarity: Vertical; Modulation:802.11a; Bandwidth:20MHz; Channel:Low

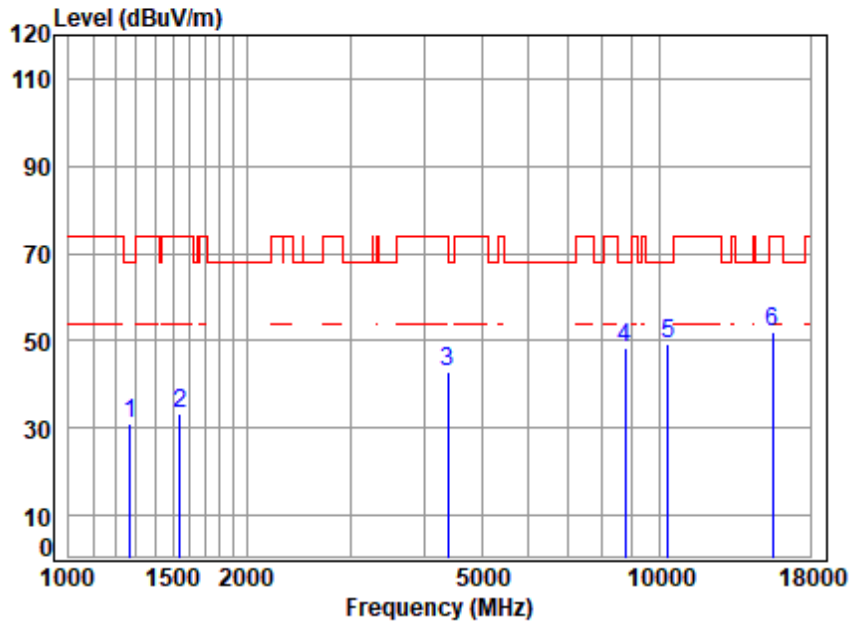

Site : chamber
 Condition: 3m VERTICAL
 Job No : 00955AT/00956AT
 Mode : 5180 TX RSE
 Note : 5G WIFI 11A

	Freq	Cable Loss	Ant Factor	Preamp Factor	Read Level	Level	Limit Line	Over Limit	Remark
	MHz	dB	dB/m	dB	dBuV	dBuV/m	dBuV/m	dB	
1	1271.123	3.71	24.97	38.35	40.59	30.92	68.20	-37.28	peak
2	1542.733	4.12	26.97	38.39	40.80	33.50	74.00	-40.50	peak
3	4379.699	7.04	34.64	35.81	37.14	43.01	74.00	-30.99	peak
4	8738.852	11.47	36.90	37.35	37.56	48.58	68.20	-19.62	peak
5	10360.000	12.73	37.10	37.54	37.21	49.50	68.20	-18.70	peak
6	15540.000	14.23	41.10	37.23	34.10	52.20	74.00	-21.80	peak



Unless otherwise agreed in writing, this document is issued by the Company subject to its General Conditions of Service printed overleaf, available on request or accessible at <https://www.sgs.com/en/Terms-and-Conditions>. Attention is drawn to the limitation of liability, indemnification and jurisdiction issues defined therein. Any holder of this document is advised that information contained hereon reflects the Company's findings at the time of its intervention only and within the limits of Client's instructions, if any. The Company's sole responsibility is to its Client and this document does not exonerate parties to a transaction from exercising all their rights and obligations under the transaction documents. This document cannot be reproduced except in full, without prior written approval of the Company. Any unauthorized alteration, forgery or falsification of the content or appearance of this document is unlawful and offenders may be prosecuted to the fullest extent of the law. Unless otherwise stated the results shown in this test report refer only to the sample(s) tested and such sample(s) are retained for 30 days only.

Test Mode: 21; Polarity: Horizontal; Modulation:802.11a; Bandwidth:20MHz; Channel:middle

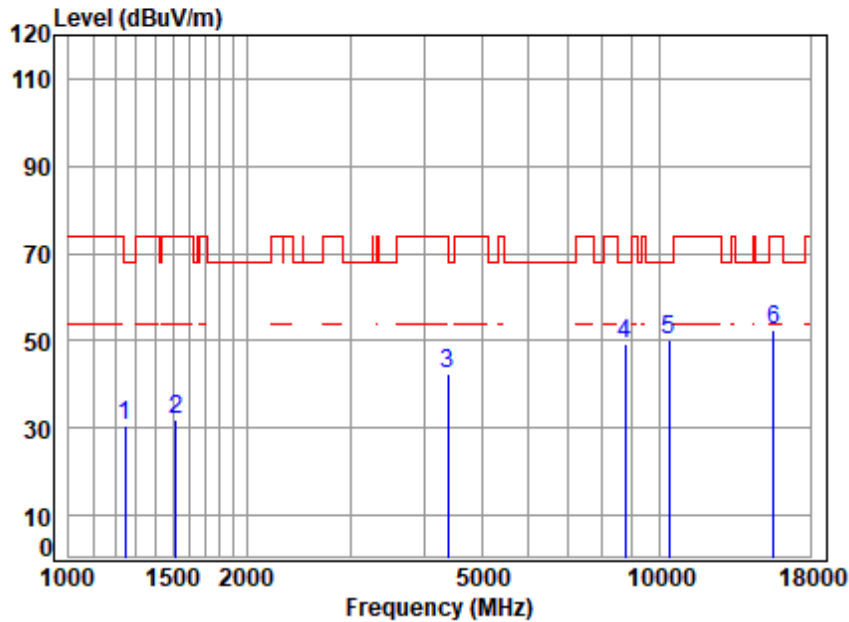

Site : chamber
 Condition: 3m HORIZONTAL
 Job No : 00955AT/00956AT
 Mode : 5200 TX RSE
 Note : 5G WIFI 11A

	Freq	Cable Loss	Ant Factor	Preamp Factor	Read Level	Level	Limit Line	Over Limit	Remark
	MHz	dB	dB/m	dB	dBuV	dBuV/m	dBuV/m	dB	
1	1245.663	3.66	25.04	38.35	40.12	30.47	68.20	-37.73	peak
2	1516.210	4.08	26.86	38.39	39.53	32.08	74.00	-41.92	peak
3	4392.376	7.05	34.74	35.80	36.53	42.52	74.00	-31.48	peak
4	8764.146	11.51	36.96	37.37	38.18	49.28	68.20	-18.92	peak
5	10400.000	12.74	37.10	37.56	37.82	50.10	68.20	-18.10	peak
6	15600.000	14.25	41.10	37.26	34.29	52.38	74.00	-21.62	peak



Unless otherwise agreed in writing, this document is issued by the Company subject to its General Conditions of Service printed overleaf, available on request or accessible at <https://www.sgs.com/en/Terms-and-Conditions>. Attention is drawn to the limitation of liability, indemnification and jurisdiction issues defined therein. Any holder of this document is advised that information contained hereon reflects the Company's findings at the time of its intervention only and within the limits of Client's instructions, if any. The Company's sole responsibility is to its Client and this document does not exonerate parties to a transaction from exercising all their rights and obligations under the transaction documents. This document cannot be reproduced except in full, without prior written approval of the Company. Any unauthorized alteration, forgery or falsification of the content or appearance of this document is unlawful and offenders may be prosecuted to the fullest extent of the law. Unless otherwise stated the results shown in this test report refer only to the sample(s) tested and such sample(s) are retained for 30 days only.

Test Mode: 21; Polarity: Vertical; Modulation:802.11a; Bandwidth:20MHz; Channel:middle

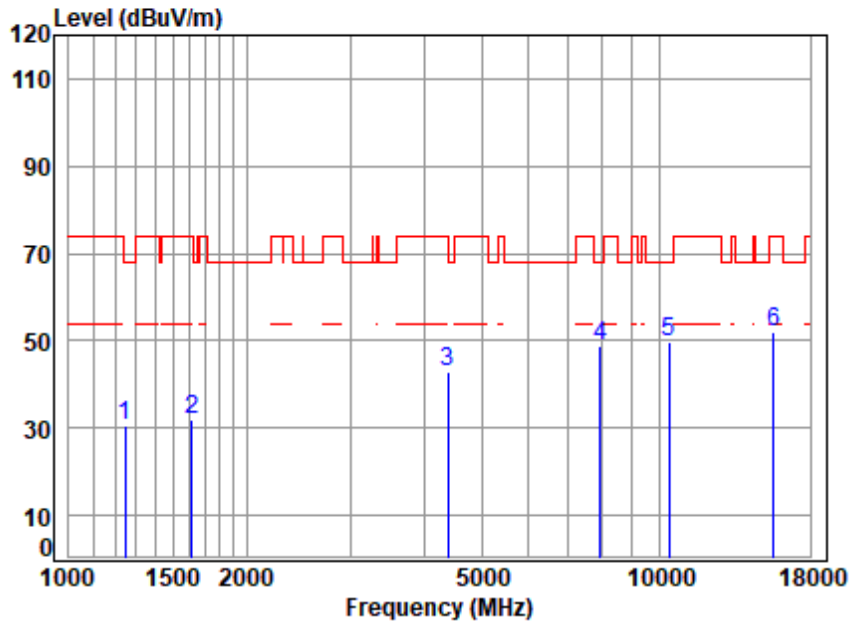

Site : chamber
 Condition: 3m VERTICAL
 Job No : 00955AT/00956AT
 Mode : 5200 TX RSE
 Note : 5G WIFI 11A

	Freq	Cable Loss	Ant Factor	Preamp Factor	Read Level	Level	Limit Line	Over Limit	Remark
	MHz	dB	dB/m	dB	dBuV	dBuV/m	dBuV/m	dB	
1	1245.663	3.66	25.04	38.35	40.36	30.71	68.20	-37.49	peak
2	1615.754	4.22	26.64	38.40	39.61	32.07	74.00	-41.93	peak
3	4392.376	7.05	34.74	35.80	36.98	42.97	74.00	-31.03	peak
4	7943.838	10.04	36.41	36.51	39.01	48.95	68.20	-19.25	peak
5	10400.000	12.74	37.10	37.56	37.57	49.85	68.20	-18.35	peak
6	15600.000	14.25	41.10	37.26	33.95	52.04	74.00	-21.96	peak



Unless otherwise agreed in writing, this document is issued by the Company subject to its General Conditions of Service printed overleaf, available on request or accessible at <https://www.sgs.com/en/Terms-and-Conditions>. Attention is drawn to the limitation of liability, indemnification and jurisdiction issues defined therein. Any holder of this document is advised that information contained hereon reflects the Company's findings at the time of its intervention only and within the limits of Client's instructions, if any. The Company's sole responsibility is to its Client and this document does not exonerate parties to a transaction from exercising all their rights and obligations under the transaction documents. This document cannot be reproduced except in full, without prior written approval of the Company. Any unauthorized alteration, forgery or falsification of the content or appearance of this document is unlawful and offenders may be prosecuted to the fullest extent of the law. Unless otherwise stated the results shown in this test report refer only to the sample(s) tested and such sample(s) are retained for 30 days only.

Test Mode: 21; Polarity: Horizontal; Modulation:802.11a; Bandwidth:20MHz; Channel:High

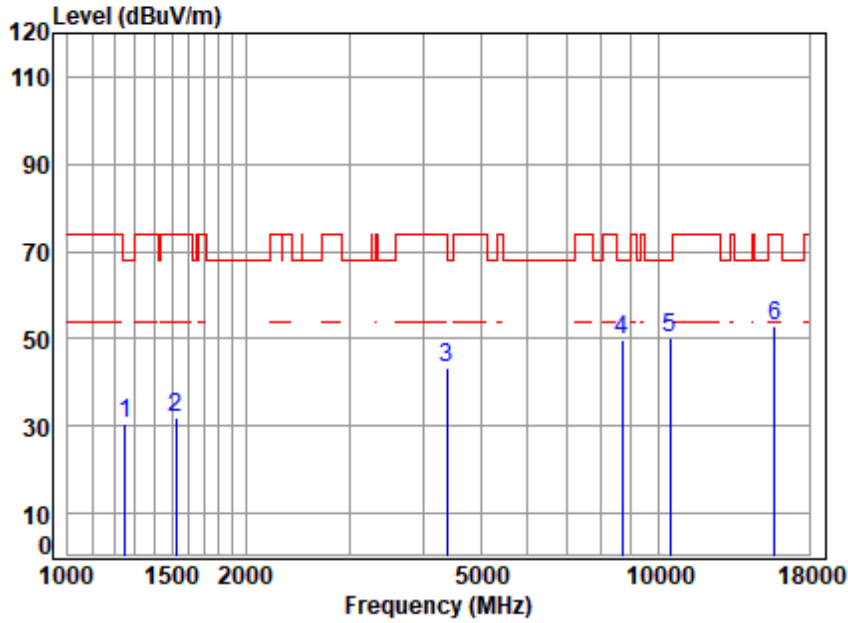

Site : chamber
 Condition: 3m HORIZONTAL
 Job No : 00955AT/00956AT
 Mode : 5240 TX RSE
 Note : 5G WIFI 11A

	Freq	Cable Loss	Ant Factor	Preamp Factor	Read Level	Level	Limit Line	Over Limit	Remark
	MHz	dB	dB/m	dB	dBuV	dBuV/m	dBuV/m	dB	
1	1252.885	3.67	25.08	38.35	39.99	30.39	68.20	-37.81	peak
2	1525.000	4.10	26.90	38.39	39.45	32.06	74.00	-41.94	peak
3	4379.699	7.04	34.64	35.81	37.41	43.28	74.00	-30.72	peak
4	8688.480	11.38	36.90	37.30	38.66	49.64	68.20	-18.56	peak
5	10480.000	12.76	37.26	37.60	37.58	50.00	68.20	-18.20	peak
6	15720.000	14.29	41.22	37.31	34.82	53.02	74.00	-20.98	peak



Unless otherwise agreed in writing, this document is issued by the Company subject to its General Conditions of Service printed overleaf, available on request or accessible at <https://www.sgs.com/en/Terms-and-Conditions>. Attention is drawn to the limitation of liability, indemnification and jurisdiction issues defined therein. Any holder of this document is advised that information contained hereon reflects the Company's findings at the time of its intervention only and within the limits of Client's instructions, if any. The Company's sole responsibility is to its Client and this document does not exonerate parties to a transaction from exercising all their rights and obligations under the transaction documents. This document cannot be reproduced except in full, without prior written approval of the Company. Any unauthorized alteration, forgery or falsification of the content or appearance of this document is unlawful and offenders may be prosecuted to the fullest extent of the law. Unless otherwise stated the results shown in this test report refer only to the sample(s) tested and such sample(s) are retained for 30 days only.

Test Mode: 21; Polarity: Vertical; Modulation:802.11a; Bandwidth:20MHz; Channel:High

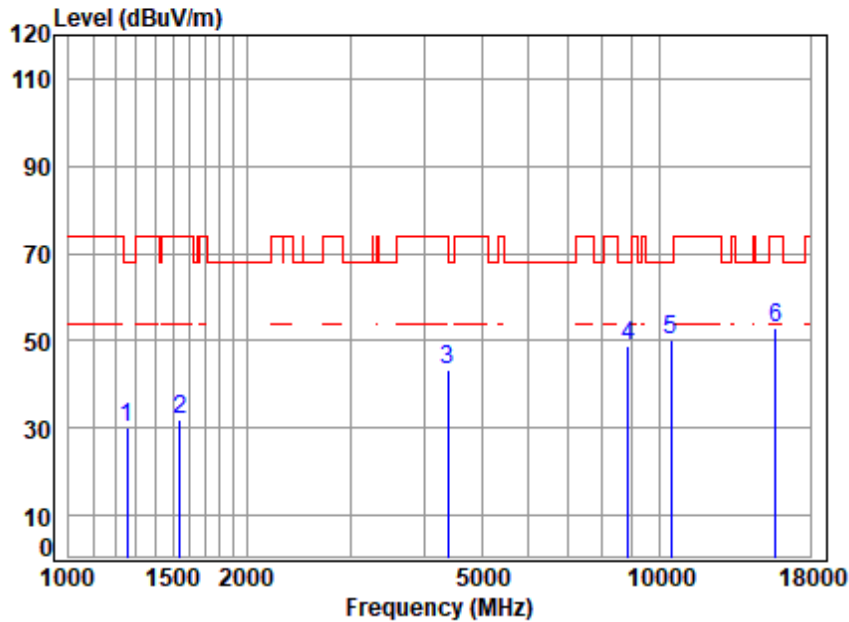

Site : chamber
 Condition: 3m VERTICAL
 Job No : 00955AT/00956AT
 Mode : 5240 TX RSE
 Note : 5G WIFI 11A

	Freq	Cable Loss	Ant Factor	Preamp Factor	Read Level	Level	Limit Line	Over Limit	Remark
	MHz	dB	dB/m	dB	dBuV	dBuV/m	dBuV/m	dB	
1	1256.512	3.68	25.06	38.35	39.78	30.17	68.20	-38.03	peak
2	1542.733	4.12	26.97	38.39	39.29	31.99	74.00	-42.01	peak
3	4392.376	7.05	34.74	35.80	37.25	43.24	74.00	-30.76	peak
4	8866.062	11.69	37.20	37.48	37.31	48.72	68.20	-19.48	peak
5	10480.000	12.76	37.26	37.60	37.94	50.36	68.20	-17.84	peak
6	15720.000	14.29	41.22	37.31	34.50	52.70	74.00	-21.30	peak



Unless otherwise agreed in writing, this document is issued by the Company subject to its General Conditions of Service printed overleaf, available on request or accessible at <https://www.sgs.com/en/Terms-and-Conditions>. Attention is drawn to the limitation of liability, indemnification and jurisdiction issues defined therein. Any holder of this document is advised that information contained hereon reflects the Company's findings at the time of its intervention only and within the limits of Client's instructions, if any. The Company's sole responsibility is to its Client and this document does not exonerate parties to a transaction from exercising all their rights and obligations under the transaction documents. This document cannot be reproduced except in full, without prior written approval of the Company. Any unauthorized alteration, forgery or falsification of the content or appearance of this document is unlawful and offenders may be prosecuted to the fullest extent of the law. Unless otherwise stated the results shown in this test report refer only to the sample(s) tested and such sample(s) are retained for 30 days only.

Attention: To check the authenticity of testing /inspection report & certificate, please contact us at telephone: (86-755) 8307 1443, or email: CN.Doccheck@sgs.com
 No.1 Workshop, M-10, Middle Section, Science & Technology Park, Nanshan District, Shenzhen, Guangdong, China 518057 t (86-755) 26012053 f (86-755) 26710594 www.sgs.com.cn
 中国·广东·深圳市南山区科技园中区M-10栋1号厂房 邮编: 518057 t (86-755) 26012053 f (86-755) 26710594 sgs.china@sgs.com

Test Mode: 21; Polarity: Horizontal; Modulation:802.11ac; Bandwidth:20MHz; Channel:Low

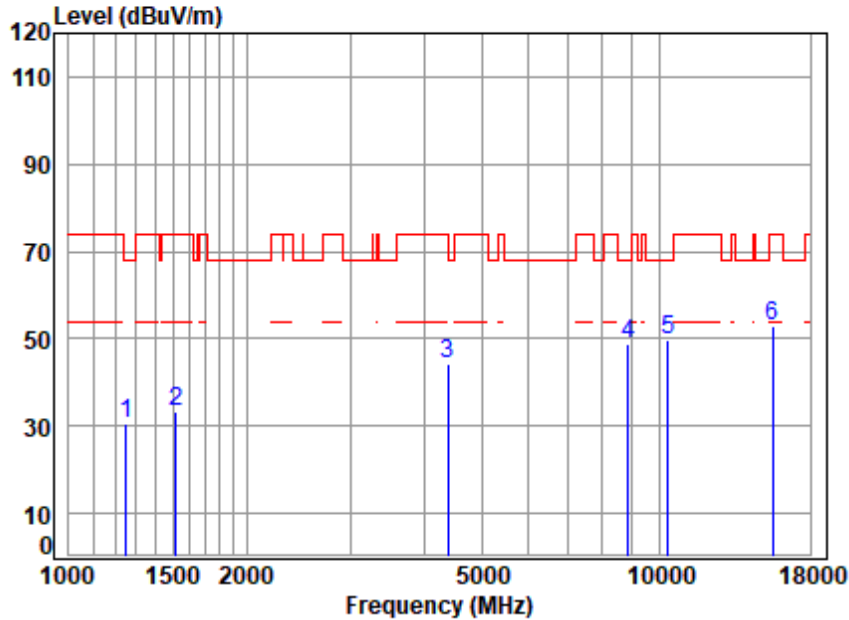

Site : chamber
 Condition: 3m HORIZONTAL
 Job No : 00955AT/00956AT
 Mode : 5180 TX RSE
 Note : 5G WIFI 11AC20

	Freq	Cable Loss	Ant Factor	Preamp Factor	Read Level	Level	Limit Line	Over Limit	Remark
	MHz	dB	dB/m	dB	dBuV	dBuV/m	dBuV/m	dB	
1	1249.269	3.67	25.09	38.35	40.07	30.48	68.20	-37.72	peak
2	1520.598	4.09	26.88	38.39	40.94	33.52	74.00	-40.48	peak
3	4379.699	7.04	34.64	35.81	38.17	44.04	74.00	-29.96	peak
4	8866.062	11.69	37.20	37.48	37.56	48.97	68.20	-19.23	peak
5	10360.000	12.73	37.10	37.54	37.49	49.78	68.20	-18.42	peak
6	15540.000	14.23	41.10	37.23	34.96	53.06	74.00	-20.94	peak



Unless otherwise agreed in writing, this document is issued by the Company subject to its General Conditions of Service printed overleaf, available on request or accessible at <https://www.sgs.com/en/Terms-and-Conditions>. Attention is drawn to the limitation of liability, indemnification and jurisdiction issues defined therein. Any holder of this document is advised that information contained hereon reflects the Company's findings at the time of its intervention only and within the limits of Client's instructions, if any. The Company's sole responsibility is to its Client and this document does not exonerate parties to a transaction from exercising all their rights and obligations under the transaction documents. This document cannot be reproduced except in full, without prior written approval of the Company. Any unauthorized alteration, forgery or falsification of the content or appearance of this document is unlawful and offenders may be prosecuted to the fullest extent of the law. Unless otherwise stated the results shown in this test report refer only to the sample(s) tested and such sample(s) are retained for 30 days only.

Test Mode: 21; Polarity: Vertical; Modulation:802.11ac; Bandwidth:20MHz; Channel:Low

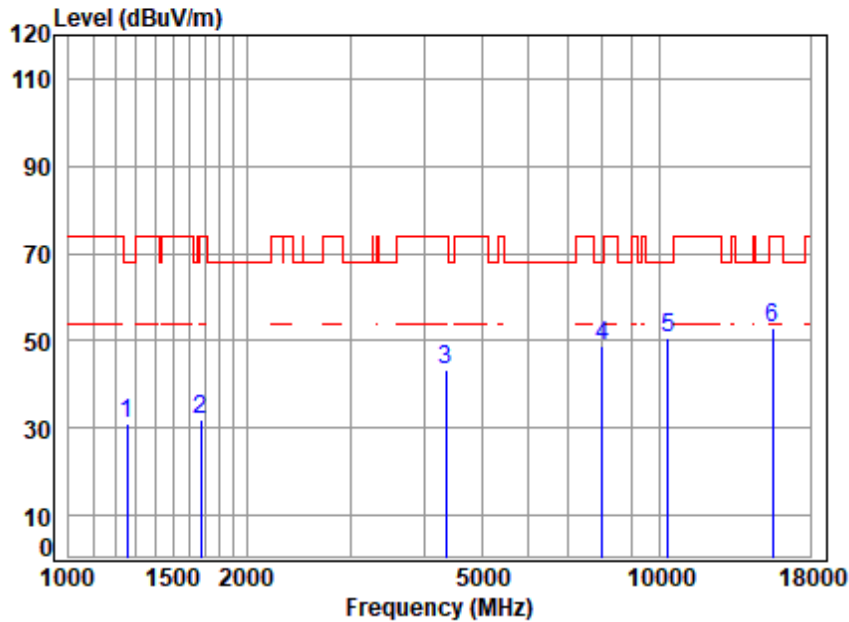

Site : chamber
 Condition: 3m VERTICAL
 Job No : 00955AT/00956AT
 Mode : 5180 TX RSE
 Note : 5G WIFI 11AC20

	Freq	Cable Loss	Ant Factor	Preamp Factor	Read Level	Level	Limit Line	Over Limit	Remark
	MHz	dB	dB/m	dB	dBuV	dBuV/m	dBuV/m	dB	
1	1256.512	3.68	25.06	38.35	40.75	31.14	68.20	-37.06	peak
2	1672.779	4.30	26.25	38.41	39.67	31.81	74.00	-42.19	peak
3	4354.454	7.03	34.44	35.83	37.61	43.25	74.00	-30.75	peak
4	8013.020	10.13	36.40	36.57	38.75	48.71	68.20	-19.49	peak
5	10360.000	12.73	37.10	37.54	38.13	50.42	68.20	-17.78	peak
6	15540.000	14.23	41.10	37.23	34.67	52.77	74.00	-21.23	peak



Unless otherwise agreed in writing, this document is issued by the Company subject to its General Conditions of Service printed overleaf, available on request or accessible at <https://www.sgs.com/en/Terms-and-Conditions>. Attention is drawn to the limitation of liability, indemnification and jurisdiction issues defined therein. Any holder of this document is advised that information contained hereon reflects the Company's findings at the time of its intervention only and within the limits of Client's instructions, if any. The Company's sole responsibility is to its Client and this document does not exonerate parties to a transaction from exercising all their rights and obligations under the transaction documents. This document cannot be reproduced except in full, without prior written approval of the Company. Any unauthorized alteration, forgery or falsification of the content or appearance of this document is unlawful and offenders may be prosecuted to the fullest extent of the law. Unless otherwise stated the results shown in this test report refer only to the sample(s) tested and such sample(s) are retained for 30 days only.

Test Mode: 21; Polarity: Horizontal; Modulation:802.11ac; Bandwidth:20MHz; Channel:middle

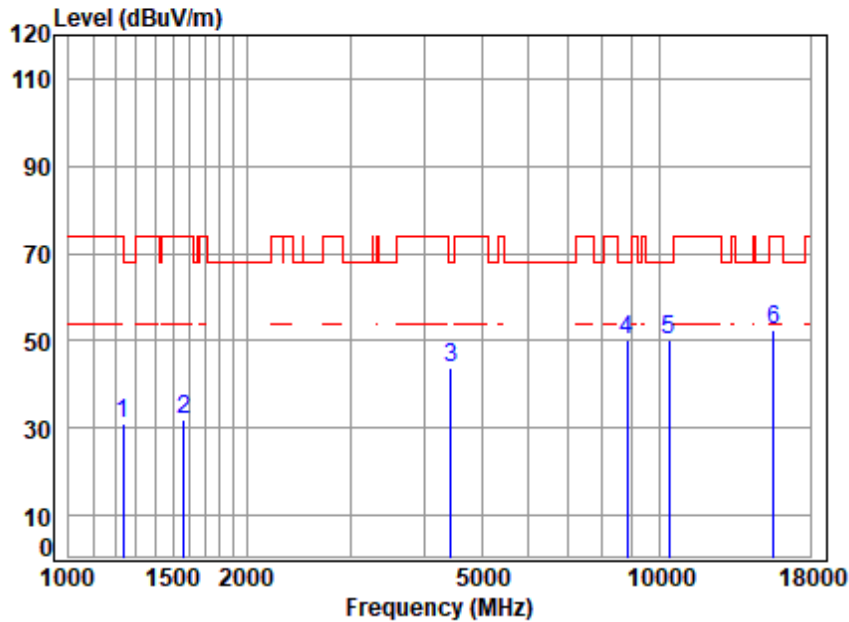

Site : chamber
 Condition: 3m HORIZONTAL
 Job No : 00955AT/00956AT
 Mode : 5200 TX RSE
 Note : 5G WIFI 11AC20

	Freq	Cable Loss	Ant Factor	Preamp Factor	Read Level	Level	Limit Line	Over Limit	Remark
	MHz	dB	dB/m	dB	dBuV	dBuV/m	dBuV/m	dB	
1	1238.483	3.65	24.94	38.35	40.68	30.92	74.00	-43.08	peak
2	1565.191	4.15	26.94	38.40	39.34	32.03	74.00	-41.97	peak
3	4430.628	7.08	34.43	35.77	38.17	43.91	68.20	-24.29	peak
4	8814.957	11.60	37.13	37.42	38.67	49.98	68.20	-18.22	peak
5	10400.000	12.74	37.10	37.56	38.07	50.35	68.20	-17.85	peak
6	15600.000	14.25	41.10	37.26	34.21	52.30	74.00	-21.70	peak



Unless otherwise agreed in writing, this document is issued by the Company subject to its General Conditions of Service printed overleaf, available on request or accessible at <https://www.sgs.com/en/Terms-and-Conditions>. Attention is drawn to the limitation of liability, indemnification and jurisdiction issues defined therein. Any holder of this document is advised that information contained hereon reflects the Company's findings at the time of its intervention only and within the limits of Client's instructions, if any. The Company's sole responsibility is to its Client and this document does not exonerate parties to a transaction from exercising all their rights and obligations under the transaction documents. This document cannot be reproduced except in full, without prior written approval of the Company. Any unauthorized alteration, forgery or falsification of the content or appearance of this document is unlawful and offenders may be prosecuted to the fullest extent of the law. Unless otherwise stated the results shown in this test report refer only to the sample(s) tested and such sample(s) are retained for 30 days only.

Attention: To check the authenticity of testing /inspection report & certificate, please contact us at telephone: (86-755) 8307 1443, or email: CN.Doccheck@sgs.com
 No.1 Workshop, M-10, Middle Section, Science & Technology Park, Nanshan District, Shenzhen, Guangdong, China 518057 t (86-755) 26012053 f (86-755) 26710594 www.sgs.com.cn
 中国·广东·深圳市南山区科技园中区M-10栋1号厂房 邮编: 518057 t (86-755) 26012053 f (86-755) 26710594 sgs.china@sgs.com

Test Mode: 21; Polarity: Vertical; Modulation:802.11ac; Bandwidth:20MHz; Channel:middle

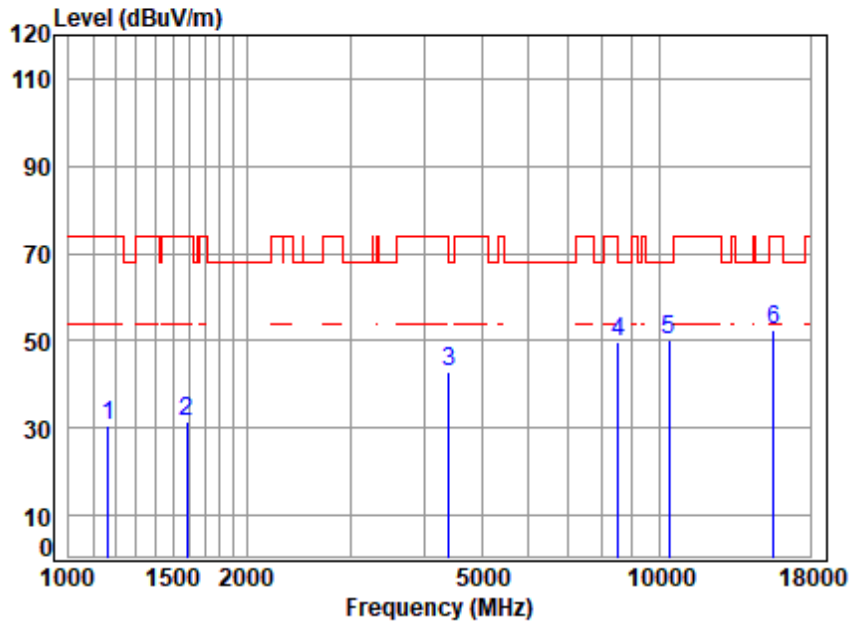

Site : chamber
 Condition: 3m VERTICAL
 Job No : 00955AT/00956AT
 Mode : 5200 TX RSE
 Note : 5G WIFI 11AC20

	Freq	Cable Loss	Ant Factor	Preamp Factor	Read Level	Level	Limit Line	Over Limit	Remark
	MHz	dB	dB/m	dB	dBuV	dBuV/m	dBuV/m	dB	
1	1165.546	3.52	24.06	38.33	41.23	30.48	74.00	-43.52	peak
2	1587.975	4.18	26.85	38.40	38.96	31.59	74.00	-42.41	peak
3	4405.090	7.06	34.74	35.79	36.77	42.78	68.20	-25.42	peak
4	8514.456	11.06	36.73	37.12	39.26	49.93	68.20	-18.27	peak
5	10400.000	12.74	37.10	37.56	38.11	50.39	68.20	-17.81	peak
6	15600.000	14.25	41.10	37.26	34.56	52.65	74.00	-21.35	peak



Unless otherwise agreed in writing, this document is issued by the Company subject to its General Conditions of Service printed overleaf, available on request or accessible at <https://www.sgs.com/en/Terms-and-Conditions>. Attention is drawn to the limitation of liability, indemnification and jurisdiction issues defined therein. Any holder of this document is advised that information contained hereon reflects the Company's findings at the time of its intervention only and within the limits of Client's instructions, if any. The Company's sole responsibility is to its Client and this document does not exonerate parties to a transaction from exercising all their rights and obligations under the transaction documents. This document cannot be reproduced except in full, without prior written approval of the Company. Any unauthorized alteration, forgery or falsification of the content or appearance of this document is unlawful and offenders may be prosecuted to the fullest extent of the law. Unless otherwise stated the results shown in this test report refer only to the sample(s) tested and such sample(s) are retained for 30 days only.

Attention: To check the authenticity of testing /inspection report & certificate, please contact us at telephone: (86-755) 8307 1443, or email: CN.Doccheck@sgs.com
 No.1 Workshop, M-10, Middle Section, Science & Technology Park, Nanshan District, Shenzhen, Guangdong, China 518057 t (86-755) 26012053 f (86-755) 26710594 www.sgs.com.cn
 中国·广东·深圳市南山区科技园中区M-10栋1号厂房 邮编: 518057 t (86-755) 26012053 f (86-755) 26710594 sgs.china@sgs.com

Test Mode: 21; Polarity: Horizontal; Modulation:802.11ac; Bandwidth:20MHz; Channel:High

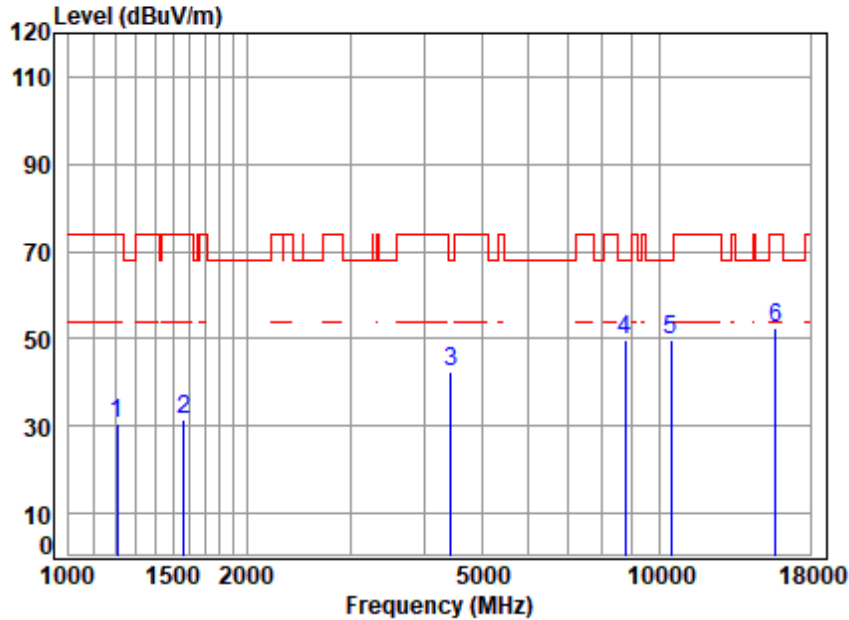

Site : chamber
 Condition: 3m HORIZONTAL
 Job No : 00955AT/00956AT
 Mode : 5240 TX RSE
 Note : 5G WIFI 11AC20

	Freq	Cable Loss	Ant Factor	Preamp Factor	Read Level	Level	Limit Line	Over Limit	Remark
	MHz	dB	dB/m	dB	dBuV	dBuV/m	dBuV/m	dB	
1	1206.682	3.59	24.49	38.34	40.82	30.56	74.00	-43.44	peak
2	1565.191	4.15	26.94	38.40	38.81	31.50	74.00	-42.50	peak
3	4430.628	7.08	34.43	35.77	36.58	42.32	68.20	-25.88	peak
4	8738.852	11.47	36.90	37.35	38.62	49.64	68.20	-18.56	peak
5	10480.000	12.76	37.26	37.60	37.32	49.74	68.20	-18.46	peak
6	15720.000	14.29	41.22	37.31	34.21	52.41	74.00	-21.59	peak



Unless otherwise agreed in writing, this document is issued by the Company subject to its General Conditions of Service printed overleaf, available on request or accessible at <https://www.sgs.com/en/Terms-and-Conditions>. Attention is drawn to the limitation of liability, indemnification and jurisdiction issues defined therein. Any holder of this document is advised that information contained hereon reflects the Company's findings at the time of its intervention only and within the limits of Client's instructions, if any. The Company's sole responsibility is to its Client and this document does not exonerate parties to a transaction from exercising all their rights and obligations under the transaction documents. This document cannot be reproduced except in full, without prior written approval of the Company. Any unauthorized alteration, forgery or falsification of the content or appearance of this document is unlawful and offenders may be prosecuted to the fullest extent of the law. Unless otherwise stated the results shown in this test report refer only to the sample(s) tested and such sample(s) are retained for 30 days only.

Test Mode: 21; Polarity: Vertical; Modulation:802.11ac; Bandwidth:20MHz; Channel:High

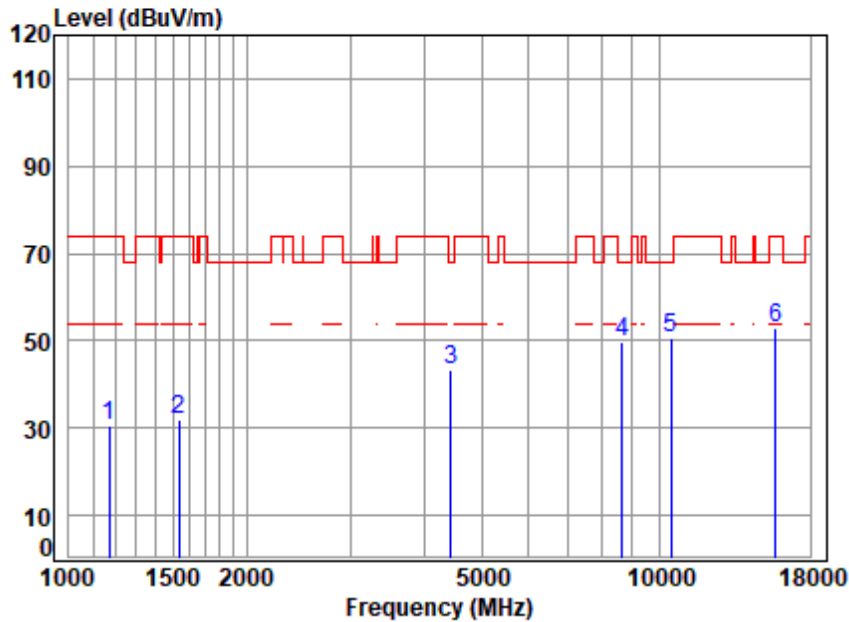

Site : chamber
 Condition: 3m VERTICAL
 Job No : 00955AT/00956AT
 Mode : 5240 TX RSE
 Note : 5G WIFI 11AC20

	Freq	Cable Loss	Ant Factor	Preamp Factor	Read Level	Level	Limit Line	Over Limit	Remark
	MHz	dB	dB/m	dB	dBuV	dBuV/m	dBuV/m	dB	
1	1172.303	3.53	24.12	38.33	41.23	30.55	74.00	-43.45	peak
2	1533.841	4.11	26.94	38.39	39.33	31.99	74.00	-42.01	peak
3	4430.628	7.08	34.43	35.77	37.82	43.56	68.20	-24.64	peak
4	8638.399	11.29	36.90	37.24	38.76	49.71	68.20	-18.49	peak
5	10480.000	12.76	37.26	37.60	38.00	50.42	68.20	-17.78	peak
6	15720.000	14.29	41.22	37.31	34.70	52.90	74.00	-21.10	peak



Unless otherwise agreed in writing, this document is issued by the Company subject to its General Conditions of Service printed overleaf, available on request or accessible at <https://www.sgs.com/en/Terms-and-Conditions>. Attention is drawn to the limitation of liability, indemnification and jurisdiction issues defined therein. Any holder of this document is advised that information contained hereon reflects the Company's findings at the time of its intervention only and within the limits of Client's instructions, if any. The Company's sole responsibility is to its Client and this document does not exonerate parties to a transaction from exercising all their rights and obligations under the transaction documents. This document cannot be reproduced except in full, without prior written approval of the Company. Any unauthorized alteration, forgery or falsification of the content or appearance of this document is unlawful and offenders may be prosecuted to the fullest extent of the law. Unless otherwise stated the results shown in this test report refer only to the sample(s) tested and such sample(s) are retained for 30 days only.

Attention: To check the authenticity of testing /inspection report & certificate, please contact us at telephone: (86-755) 8307 1443, or email: CN.Doccheck@sgs.com
 No.1 Workshop, M-10, Middle Section, Science & Technology Park, Nanshan District, Shenzhen, Guangdong, China 518057 t (86-755) 26012053 f (86-755) 26710594 www.sgs.com.cn
 中国·广东·深圳市南山区科技园中区M-10栋1号厂房 邮编: 518057 t (86-755) 26012053 f (86-755) 26710594 sgs.china@sgs.com

Test Mode: 21; Polarity: Horizontal; Modulation:802.11ac; Bandwidth:40MHz; Channel:Low

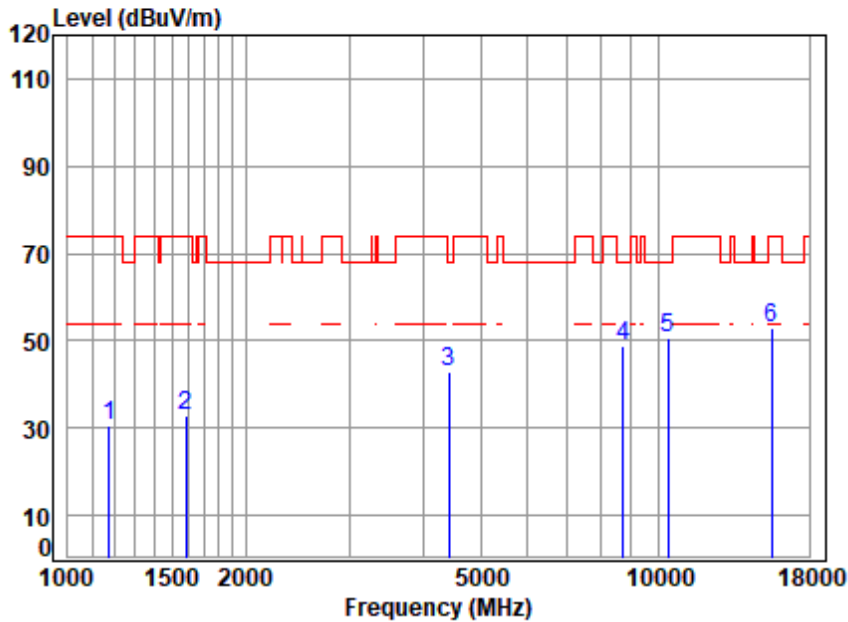

Site : chamber
 Condition: 3m HORIZONTAL
 Job No : 00955AT/00956AT
 Mode : 5190 TX RSE
 Note : 5G WIFI 11AC40

	Freq	Cable Loss	Ant Factor	Preamp Factor	Read Level	Level	Limit Line	Over Limit	Remark
	MHz	dB	dB/m	dB	dBuV	dBuV/m	dBuV/m	dB	
1	1175.697	3.54	24.16	38.34	41.30	30.66	74.00	-43.34	peak
2	1587.975	4.18	26.85	38.40	40.03	32.66	74.00	-41.34	peak
3	4417.841	7.07	34.59	35.78	37.12	43.00	68.20	-25.20	peak
4	8713.630	11.42	36.90	37.32	37.89	48.89	68.20	-19.31	peak
5	10380.000	12.74	37.10	37.55	38.32	50.61	68.20	-17.59	peak
6	15570.000	14.24	41.10	37.25	34.79	52.88	74.00	-21.12	peak



Unless otherwise agreed in writing, this document is issued by the Company subject to its General Conditions of Service printed overleaf, available on request or accessible at <https://www.sgs.com/en/Terms-and-Conditions>. Attention is drawn to the limitation of liability, indemnification and jurisdiction issues defined therein. Any holder of this document is advised that information contained hereon reflects the Company's findings at the time of its intervention only and within the limits of Client's instructions, if any. The Company's sole responsibility is to its Client and this document does not exonerate parties to a transaction from exercising all their rights and obligations under the transaction documents. This document cannot be reproduced except in full, without prior written approval of the Company. Any unauthorized alteration, forgery or falsification of the content or appearance of this document is unlawful and offenders may be prosecuted to the fullest extent of the law. Unless otherwise stated the results shown in this test report refer only to the sample(s) tested and such sample(s) are retained for 30 days only.

Attention: To check the authenticity of testing /inspection report & certificate, please contact us at telephone: (86-755) 8307 1443, or email: CN.Doccheck@sgs.com
 No.1 Workshop, M-10, Middle Section, Science & Technology Park, Nanshan District, Shenzhen, Guangdong, China 518057 t (86-755) 26012053 f (86-755) 26710594 www.sgs.com.cn
 中国·广东·深圳市南山区科技园中区M-10栋1号厂房 邮编: 518057 t (86-755) 26012053 f (86-755) 26710594 sgs.china@sgs.com

Test Mode: 21; Polarity: Vertical; Modulation:802.11ac; Bandwidth:40MHz; Channel:Low

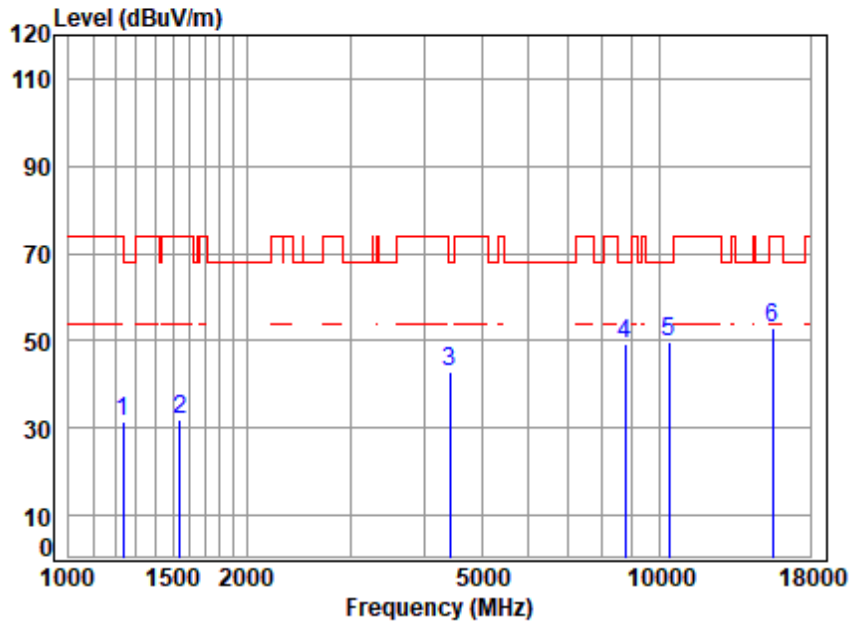

Site : chamber
 Condition: 3m VERTICAL
 Job No : 00955AT/00956AT
 Mode : 5190 TX RSE
 Note : 5G WIFI 11AC40

	Freq	Cable Loss	Ant Factor	Preamp Factor	Read Level	Level	Limit Line	Over Limit	Remark
	MHz	dB	dB/m	dB	dBuV	dBuV/m	dBuV/m	dB	
1	1238.483	3.65	24.94	38.35	41.41	31.65	74.00	-42.35	peak
2	1542.733	4.12	26.97	38.39	39.34	32.04	74.00	-41.96	peak
3	4417.841	7.07	34.59	35.78	37.13	43.01	68.20	-25.19	peak
4	8764.146	11.51	36.96	37.37	37.97	49.07	68.20	-19.13	peak
5	10380.000	12.74	37.10	37.55	37.65	49.94	68.20	-18.26	peak
6	15570.000	14.24	41.10	37.25	34.94	53.03	74.00	-20.97	peak



Unless otherwise agreed in writing, this document is issued by the Company subject to its General Conditions of Service printed overleaf, available on request or accessible at <https://www.sgs.com/en/Terms-and-Conditions>. Attention is drawn to the limitation of liability, indemnification and jurisdiction issues defined therein. Any holder of this document is advised that information contained hereon reflects the Company's findings at the time of its intervention only and within the limits of Client's instructions, if any. The Company's sole responsibility is to its Client and this document does not exonerate parties to a transaction from exercising all their rights and obligations under the transaction documents. This document cannot be reproduced except in full, without prior written approval of the Company. Any unauthorized alteration, forgery or falsification of the content or appearance of this document is unlawful and offenders may be prosecuted to the fullest extent of the law. Unless otherwise stated the results shown in this test report refer only to the sample(s) tested and such sample(s) are retained for 30 days only.

Test Mode: 21; Polarity: Horizontal; Modulation:802.11ac; Bandwidth:40MHz; Channel:High

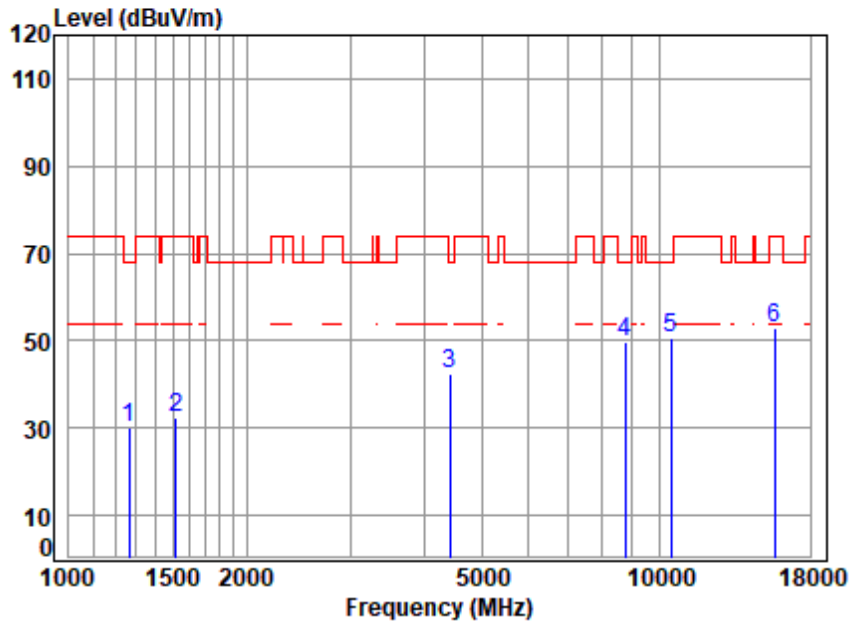

Site : chamber
 Condition: 3m HORIZONTAL
 Job No : 00955AT/00956AT
 Mode : 5230 TX RSE
 Note : 5G WIFI 11AC40

	Freq	Cable Loss	Ant Factor	Preamp Factor	Read Level	Level	Limit Line	Over Limit	Remark
	MHz	dB	dB/m	dB	dBuV	dBuV/m	dBuV/m	dB	
1	1263.796	3.69	25.02	38.35	39.92	30.28	68.20	-37.92	peak
2	1520.598	4.09	26.88	38.39	39.72	32.30	74.00	-41.70	peak
3	4417.841	7.07	34.59	35.78	36.61	42.49	68.20	-25.71	peak
4	8738.852	11.47	36.90	37.35	38.78	49.80	68.20	-18.40	peak
5	10460.000	12.76	37.22	37.59	38.30	50.69	68.20	-17.51	peak
6	15690.000	14.28	41.19	37.30	34.55	52.72	74.00	-21.28	peak



Unless otherwise agreed in writing, this document is issued by the Company subject to its General Conditions of Service printed overleaf, available on request or accessible at <https://www.sgs.com/en/Terms-and-Conditions>. Attention is drawn to the limitation of liability, indemnification and jurisdiction issues defined therein. Any holder of this document is advised that information contained hereon reflects the Company's findings at the time of its intervention only and within the limits of Client's instructions, if any. The Company's sole responsibility is to its Client and this document does not exonerate parties to a transaction from exercising all their rights and obligations under the transaction documents. This document cannot be reproduced except in full, without prior written approval of the Company. Any unauthorized alteration, forgery or falsification of the content or appearance of this document is unlawful and offenders may be prosecuted to the fullest extent of the law. Unless otherwise stated the results shown in this test report refer only to the sample(s) tested and such sample(s) are retained for 30 days only.

Test Mode: 21; Polarity: Vertical; Modulation:802.11ac; Bandwidth:40MHz; Channel:High

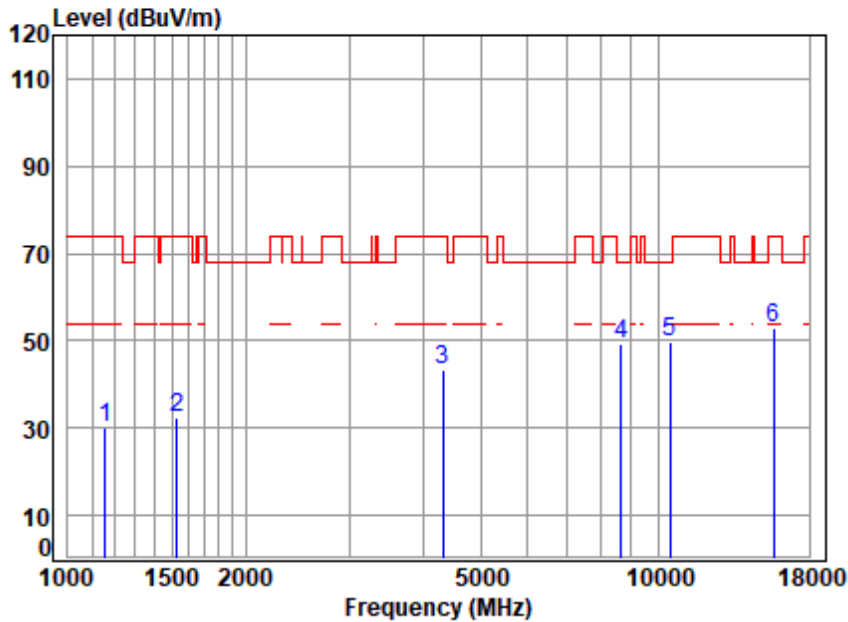

Site : chamber
 Condition: 3m VERTICAL
 Job No : 00955AT/00956AT
 Mode : 5230 TX RSE
 Note : 5G WIFI 11AC40

	Freq	Cable Loss	Ant Factor	Preamp Factor	Read Level	Level	Limit Line	Over Limit	Remark
	MHz	dB	dB/m	dB	dBuV	dBuV/m	dBuV/m	dB	
1	1155.483	3.50	23.95	38.33	40.95	30.07	74.00	-43.93	peak
2	1529.414	4.10	26.92	38.39	39.98	32.61	74.00	-41.39	peak
3	4316.859	7.00	34.13	35.86	37.86	43.13	74.00	-30.87	peak
4	8663.404	11.33	36.90	37.27	38.31	49.27	68.20	-18.93	peak
5	10460.000	12.76	37.22	37.59	37.24	49.63	68.20	-18.57	peak
6	15690.000	14.28	41.19	37.30	34.87	53.04	74.00	-20.96	peak



Unless otherwise agreed in writing, this document is issued by the Company subject to its General Conditions of Service printed overleaf, available on request or accessible at <https://www.sgs.com/en/Terms-and-Conditions>. Attention is drawn to the limitation of liability, indemnification and jurisdiction issues defined therein. Any holder of this document is advised that information contained hereon reflects the Company's findings at the time of its intervention only and within the limits of Client's instructions, if any. The Company's sole responsibility is to its Client and this document does not exonerate parties to a transaction from exercising all their rights and obligations under the transaction documents. This document cannot be reproduced except in full, without prior written approval of the Company. Any unauthorized alteration, forgery or falsification of the content or appearance of this document is unlawful and offenders may be prosecuted to the fullest extent of the law. Unless otherwise stated the results shown in this test report refer only to the sample(s) tested and such sample(s) are retained for 30 days only.

Test Mode: 21; Polarity: Horizontal; Modulation:802.11ac; Bandwidth:80MHz; Channel:middle

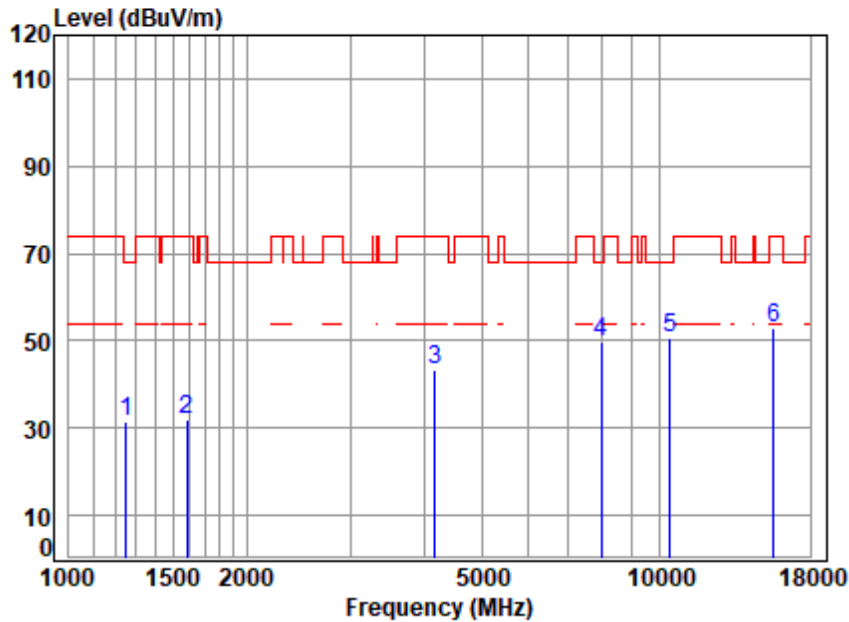

Site : chamber
 Condition: 3m HORIZONTAL
 Job No : 00955AT/00956AT
 Mode : 5210 TX RSE
 Note : 5G WIFI 11AC80

	Freq	Cable Loss	Ant Factor	Preamp Factor	Read Level	Level	Limit Line	Over Limit	Remark
	MHz	dB	dB/m	dB	dBuV	dBuV/m	dBuV/m	dB	
1	1252.885	3.67	25.08	38.35	40.92	31.32	68.20	-36.88	peak
2	1587.975	4.18	26.85	38.40	39.23	31.86	74.00	-42.14	peak
3	4169.698	6.90	33.80	35.97	38.76	43.49	74.00	-30.51	peak
4	7989.893	10.09	36.40	36.55	39.74	49.68	68.20	-18.52	peak
5	10420.000	12.75	37.14	37.57	38.15	50.47	68.20	-17.73	peak
6	15630.000	14.26	41.13	37.27	34.70	52.82	74.00	-21.18	peak



Unless otherwise agreed in writing, this document is issued by the Company subject to its General Conditions of Service printed overleaf, available on request or accessible at <https://www.sgs.com/en/Terms-and-Conditions>. Attention is drawn to the limitation of liability, indemnification and jurisdiction issues defined therein. Any holder of this document is advised that information contained hereon reflects the Company's findings at the time of its intervention only and within the limits of Client's instructions, if any. The Company's sole responsibility is to its Client and this document does not exonerate parties to a transaction from exercising all their rights and obligations under the transaction documents. This document cannot be reproduced except in full, without prior written approval of the Company. Any unauthorized alteration, forgery or falsification of the content or appearance of this document is unlawful and offenders may be prosecuted to the fullest extent of the law. Unless otherwise stated the results shown in this test report refer only to the sample(s) tested and such sample(s) are retained for 30 days only.

Test Mode: 21; Polarity: Vertical; Modulation:802.11ac; Bandwidth:80MHz; Channel:middle

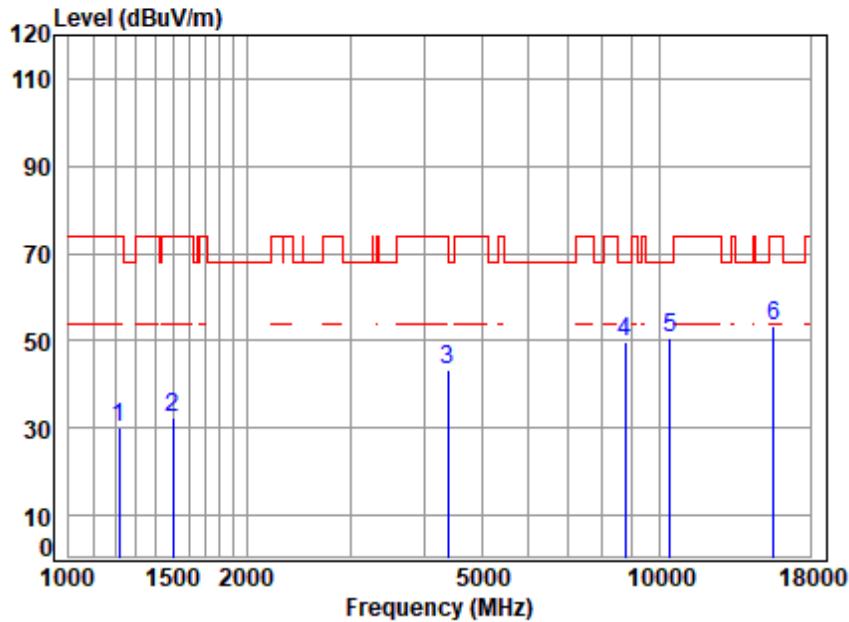

Site : chamber
 Condition: 3m VERTICAL
 Job No : 00955AT/00956AT
 Mode : 5210 TX RSE
 Note : 5G WIFI 11AC80

	Freq	Cable Loss	Ant Factor	Preamp Factor	Read Level	Level	Limit Line	Over Limit	Remark
	MHz	dB	dB/m	dB	dBuV	dBuV/m	dBuV/m	dB	
1	1217.190	3.61	24.64	38.34	40.21	30.12	74.00	-43.88	peak
2	1503.119	4.07	26.81	38.39	39.69	32.18	74.00	-41.82	peak
3	4392.376	7.05	34.74	35.80	37.14	43.13	74.00	-30.87	peak
4	8764.146	11.51	36.96	37.37	38.76	49.86	68.20	-18.34	peak
5	10420.000	12.75	37.14	37.57	38.21	50.53	68.20	-17.67	peak
6	15630.000	14.26	41.13	37.27	35.30	53.42	74.00	-20.58	peak



Unless otherwise agreed in writing, this document is issued by the Company subject to its General Conditions of Service printed overleaf, available on request or accessible at <https://www.sgs.com/en/Terms-and-Conditions>. Attention is drawn to the limitation of liability, indemnification and jurisdiction issues defined therein. Any holder of this document is advised that information contained hereon reflects the Company's findings at the time of its intervention only and within the limits of Client's instructions, if any. The Company's sole responsibility is to its Client and this document does not exonerate parties to a transaction from exercising all their rights and obligations under the transaction documents. This document cannot be reproduced except in full, without prior written approval of the Company. Any unauthorized alteration, forgery or falsification of the content or appearance of this document is unlawful and offenders may be prosecuted to the fullest extent of the law. Unless otherwise stated the results shown in this test report refer only to the sample(s) tested and such sample(s) are retained for 30 days only.

Test Mode: 22; Polarity: Horizontal; Modulation:802.11a; Bandwidth:20MHz; Channel:Low

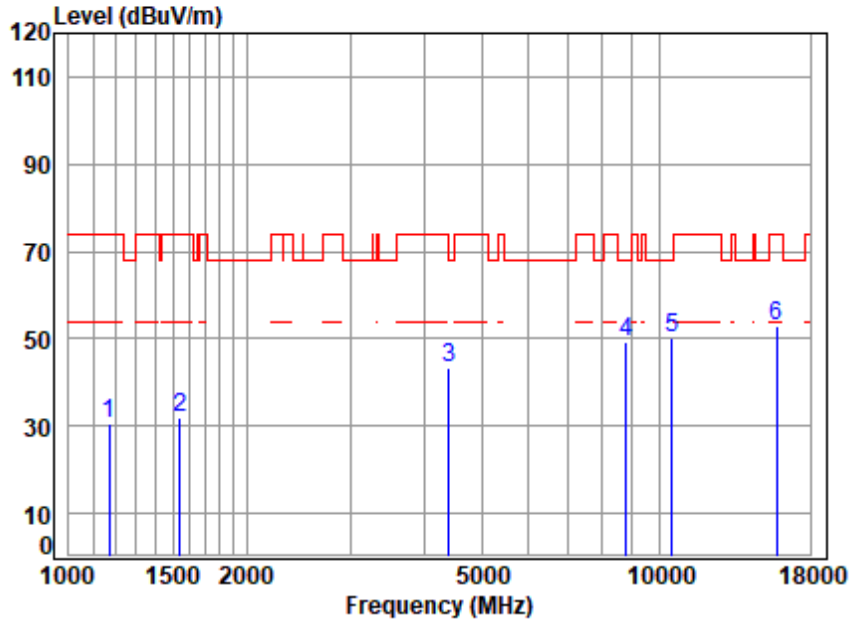

Site : chamber
 Condition: 3m HORIZONTAL
 Job No : 00955AT/00956AT
 Mode : 5260 TX RSE
 Note : 5G WIFI 11A

	Freq	Cable Loss	Ant Factor	Preamp Factor	Read Level	Level	Limit Line	Over Limit	Remark
	MHz	dB	dB/m	dB	dBuV	dBuV/m	dBuV/m	dB	
1	1168.920	3.53	24.09	38.33	41.22	30.51	74.00	-43.49	peak
2	1542.733	4.12	26.97	38.39	39.31	32.01	74.00	-41.99	peak
3	4405.090	7.06	34.74	35.79	37.19	43.20	68.20	-25.00	peak
4	8789.516	11.55	37.06	37.40	38.29	49.50	68.20	-18.70	peak
5	10520.000	12.77	37.30	37.62	37.83	50.28	68.20	-17.92	peak
6	15780.000	14.31	41.28	37.33	34.76	53.02	74.00	-20.98	peak



Unless otherwise agreed in writing, this document is issued by the Company subject to its General Conditions of Service printed overleaf, available on request or accessible at <https://www.sgs.com/en/Terms-and-Conditions>. Attention is drawn to the limitation of liability, indemnification and jurisdiction issues defined therein. Any holder of this document is advised that information contained hereon reflects the Company's findings at the time of its intervention only and within the limits of Client's instructions, if any. The Company's sole responsibility is to its Client and this document does not exonerate parties to a transaction from exercising all their rights and obligations under the transaction documents. This document cannot be reproduced except in full, without prior written approval of the Company. Any unauthorized alteration, forgery or falsification of the content or appearance of this document is unlawful and offenders may be prosecuted to the fullest extent of the law. Unless otherwise stated the results shown in this test report refer only to the sample(s) tested and such sample(s) are retained for 30 days only.

Attention: To check the authenticity of testing /inspection report & certificate, please contact us at telephone: (86-755) 8307 1443, or email: CN.Doccheck@sgs.com
 No.1 Workshop, M-10, Middle Section, Science & Technology Park, Nanshan District, Shenzhen, Guangdong, China 518057 t (86-755) 26012053 f (86-755) 26710594 www.sgs.com.cn
 中国·广东·深圳市南山区科技园中区M-10栋1号厂房 邮编: 518057 t (86-755) 26012053 f (86-755) 26710594 sgs.china@sgs.com

Test Mode: 22; Polarity: Vertical; Modulation:802.11a; Bandwidth:20MHz; Channel:Low

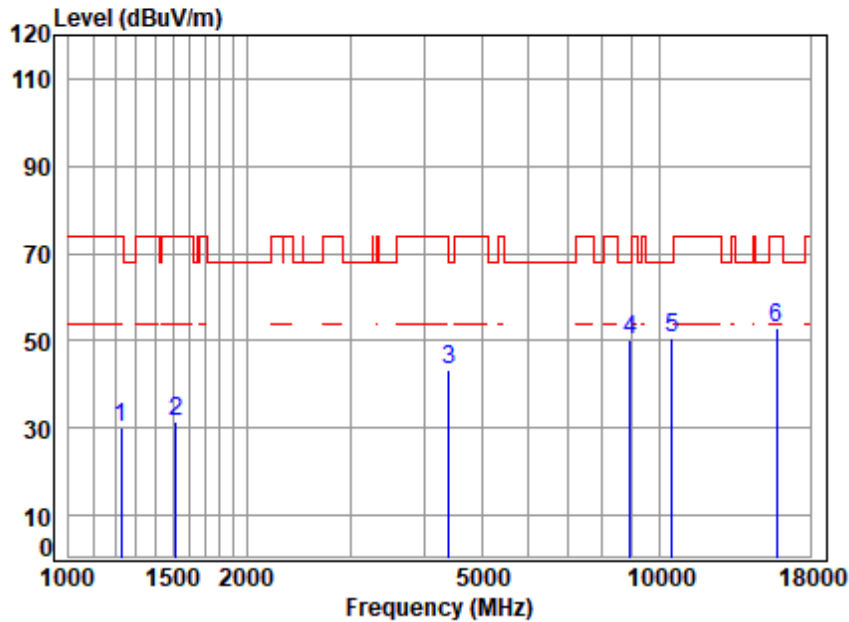

Site : chamber
 Condition: 3m VERTICAL
 Job No : 00955AT/00956AT
 Mode : 5260 TX RSE
 Note : 5G WIFI 11A

	Freq	Cable Loss	Ant Factor	Preamp Factor	Read Level	Level	Limit Line	Over Limit	Remark
	MHz	dB	dB/m	dB	dBuV	dBuV/m	dBuV/m	dB	
1	1227.791	3.63	24.79	38.34	40.04	30.12	74.00	-43.88	peak
2	1520.598	4.09	26.88	38.39	39.02	31.60	74.00	-42.40	peak
3	4405.090	7.06	34.74	35.79	37.45	43.46	68.20	-24.74	peak
4	8917.462	11.78	37.13	37.53	38.71	50.09	68.20	-18.11	peak
5	10520.000	12.77	37.30	37.62	38.03	50.48	68.20	-17.72	peak
6	15780.000	14.31	41.28	37.33	34.87	53.13	74.00	-20.87	peak



Unless otherwise agreed in writing, this document is issued by the Company subject to its General Conditions of Service printed overleaf, available on request or accessible at <https://www.sgs.com/en/Terms-and-Conditions>. Attention is drawn to the limitation of liability, indemnification and jurisdiction issues defined therein. Any holder of this document is advised that information contained hereon reflects the Company's findings at the time of its intervention only and within the limits of Client's instructions, if any. The Company's sole responsibility is to its Client and this document does not exonerate parties to a transaction from exercising all their rights and obligations under the transaction documents. This document cannot be reproduced except in full, without prior written approval of the Company. Any unauthorized alteration, forgery or falsification of the content or appearance of this document is unlawful and offenders may be prosecuted to the fullest extent of the law. Unless otherwise stated the results shown in this test report refer only to the sample(s) tested and such sample(s) are retained for 30 days only.

Test Mode: 22; Polarity: Horizontal; Modulation:802.11a; Bandwidth:20MHz; Channel:middle

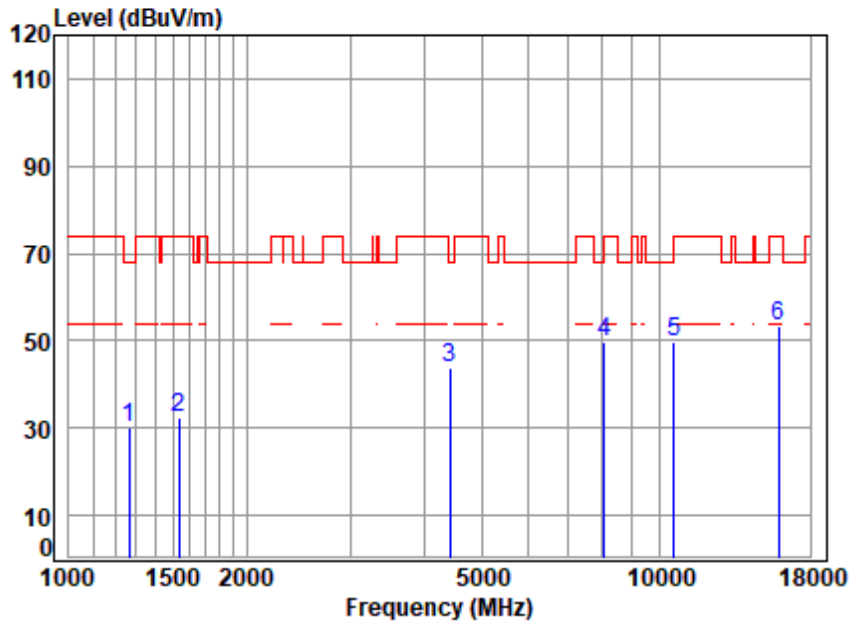

Site : chamber
 Condition: 3m HORIZONTAL
 Job No : 00955AT/00956AT
 Mode : 5300 TX RSE
 Note : 5G WIFI 11A

	Freq	Cable Loss	Ant Factor	Preamp Factor	Read Level	Level	Limit Line	Over Limit	Remark
	MHz	dB	dB/m	dB	dBuV	dBuV/m	dBuV/m	dB	
1	1263.796	3.69	25.02	38.35	39.90	30.26	68.20	-37.94	peak
2	1533.841	4.11	26.94	38.39	39.59	32.25	74.00	-41.75	peak
3	4417.841	7.07	34.59	35.78	37.70	43.58	68.20	-24.62	peak
4	8082.804	10.26	36.47	36.65	39.52	49.60	74.00	-24.40	peak
5	10600.000	12.80	37.30	37.66	37.16	49.60	68.20	-18.60	peak
6	15900.000	14.35	41.40	37.38	35.02	53.39	74.00	-20.61	peak



Unless otherwise agreed in writing, this document is issued by the Company subject to its General Conditions of Service printed overleaf, available on request or accessible at <https://www.sgs.com/en/Terms-and-Conditions>. Attention is drawn to the limitation of liability, indemnification and jurisdiction issues defined therein. Any holder of this document is advised that information contained hereon reflects the Company's findings at the time of its intervention only and within the limits of Client's instructions, if any. The Company's sole responsibility is to its Client and this document does not exonerate parties to a transaction from exercising all their rights and obligations under the transaction documents. This document cannot be reproduced except in full, without prior written approval of the Company. Any unauthorized alteration, forgery or falsification of the content or appearance of this document is unlawful and offenders may be prosecuted to the fullest extent of the law. Unless otherwise stated the results shown in this test report refer only to the sample(s) tested and such sample(s) are retained for 30 days only.

Test Mode: 22; Polarity: Vertical; Modulation:802.11a; Bandwidth:20MHz; Channel:middle

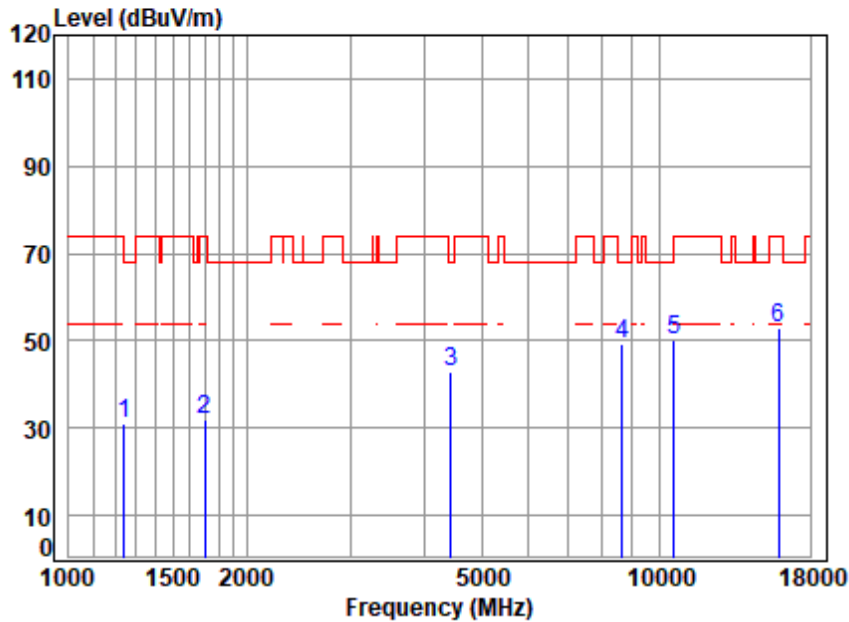

Site : chamber
 Condition: 3m VERTICAL
 Job No : 00955AT/00956AT
 Mode : 5300 TX RSE
 Note : 5G WIFI 11A

	Freq	Cable Loss	Ant Factor	Preamp Factor	Read Level	Level	Limit Line	Over Limit	Remark
	MHz	dB	dB/m	dB	dBuV	dBuV/m	dBuV/m	dB	
1	1242.068	3.66	24.99	38.35	40.51	30.81	68.20	-37.39	peak
2	1697.129	4.33	26.21	38.41	39.64	31.77	74.00	-42.23	peak
3	4430.628	7.08	34.43	35.77	37.11	42.85	68.20	-25.35	peak
4	8663.404	11.33	36.90	37.27	38.52	49.48	68.20	-18.72	peak
5	10600.000	12.80	37.30	37.66	37.68	50.12	68.20	-18.08	peak
6	15900.000	14.35	41.40	37.38	34.76	53.13	74.00	-20.87	peak



Unless otherwise agreed in writing, this document is issued by the Company subject to its General Conditions of Service printed overleaf, available on request or accessible at <https://www.sgs.com/en/Terms-and-Conditions>. Attention is drawn to the limitation of liability, indemnification and jurisdiction issues defined therein. Any holder of this document is advised that information contained hereon reflects the Company's findings at the time of its intervention only and within the limits of Client's instructions, if any. The Company's sole responsibility is to its Client and this document does not exonerate parties to a transaction from exercising all their rights and obligations under the transaction documents. This document cannot be reproduced except in full, without prior written approval of the Company. Any unauthorized alteration, forgery or falsification of the content or appearance of this document is unlawful and offenders may be prosecuted to the fullest extent of the law. Unless otherwise stated the results shown in this test report refer only to the sample(s) tested and such sample(s) are retained for 30 days only.

Test Mode: 22; Polarity: Horizontal; Modulation:802.11a; Bandwidth:20MHz; Channel:High

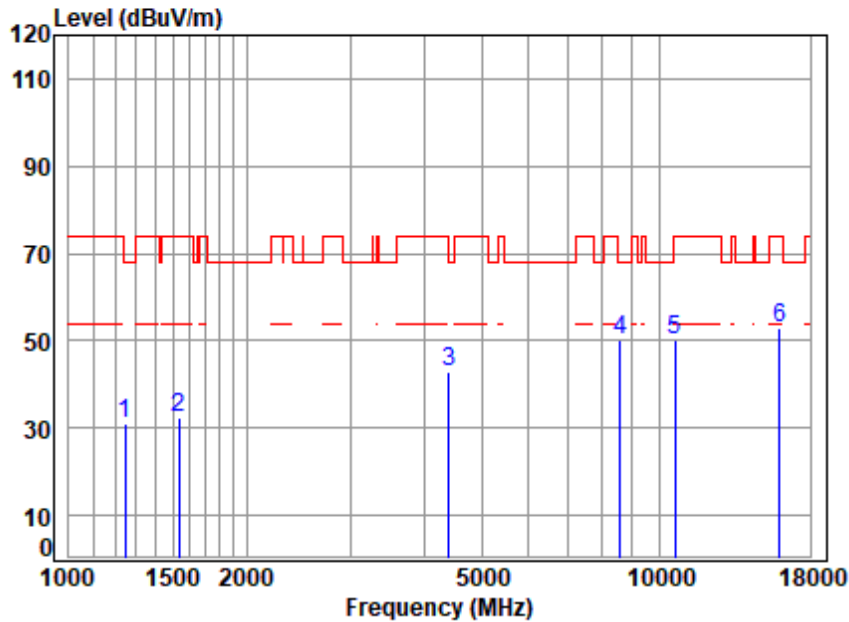

Site : chamber
 Condition: 3m HORIZONTAL
 Job No : 00955AT/00956AT
 Mode : 5320 TX RSE
 Note : 5G WIFI 11A

	Freq	Cable Loss	Ant Factor	Preamp Factor	Read Level	Level	Limit Line	Over Limit	Remark
	MHz	dB	dB/m	dB	dBuV	dBuV/m	dBuV/m	dB	
1	1245.663	3.66	25.04	38.35	40.55	30.90	68.20	-37.30	peak
2	1538.281	4.12	26.95	38.39	39.72	32.40	74.00	-41.60	peak
3	4405.090	7.06	34.74	35.79	36.80	42.81	68.20	-25.39	peak
4 p	8588.607	11.20	36.88	37.19	39.27	50.16	68.20	-18.04	peak
5	10640.000	12.81	37.22	37.68	38.01	50.36	74.00	-23.64	peak
6	15960.000	14.37	41.52	37.40	34.53	53.02	74.00	-20.98	peak



Unless otherwise agreed in writing, this document is issued by the Company subject to its General Conditions of Service printed overleaf, available on request or accessible at <https://www.sgs.com/en/Terms-and-Conditions>. Attention is drawn to the limitation of liability, indemnification and jurisdiction issues defined therein. Any holder of this document is advised that information contained hereon reflects the Company's findings at the time of its intervention only and within the limits of Client's instructions, if any. The Company's sole responsibility is to its Client and this document does not exonerate parties to a transaction from exercising all their rights and obligations under the transaction documents. This document cannot be reproduced except in full, without prior written approval of the Company. Any unauthorized alteration, forgery or falsification of the content or appearance of this document is unlawful and offenders may be prosecuted to the fullest extent of the law. Unless otherwise stated the results shown in this test report refer only to the sample(s) tested and such sample(s) are retained for 30 days only.

Test Mode: 22; Polarity: Vertical; Modulation:802.11a; Bandwidth:20MHz; Channel:High

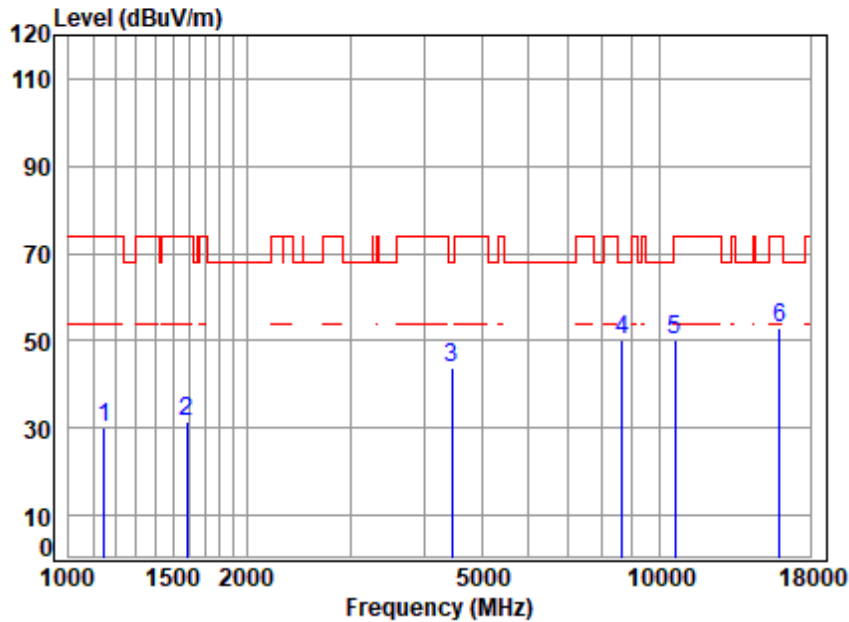

Site : chamber
 Condition: 3m VERTICAL
 Job No : 00955AT/00956AT
 Mode : 5320 TX RSE
 Note : 5G WIFI 11A

	Freq	Cable Loss	Ant Factor	Preamp Factor	Read Level	Level	Limit Line	Over Limit	Remark
	MHz	dB	dB/m	dB	dBuV	dBuV/m	dBuV/m	dB	
1	1148.823	3.49	23.90	38.33	41.22	30.28	74.00	-43.72	peak
2	1583.392	4.18	26.87	38.40	38.82	31.47	74.00	-42.53	peak
3	4456.315	7.09	34.12	35.76	38.25	43.70	68.20	-24.50	peak
4	8663.404	11.33	36.90	37.27	39.06	50.02	68.20	-18.18	peak
5	10640.000	12.81	37.22	37.68	37.97	50.32	74.00	-23.68	peak
6	15960.000	14.37	41.52	37.40	34.57	53.06	74.00	-20.94	peak



Unless otherwise agreed in writing, this document is issued by the Company subject to its General Conditions of Service printed overleaf, available on request or accessible at <https://www.sgs.com/en/Terms-and-Conditions>. Attention is drawn to the limitation of liability, indemnification and jurisdiction issues defined therein. Any holder of this document is advised that information contained hereon reflects the Company's findings at the time of its intervention only and within the limits of Client's instructions, if any. The Company's sole responsibility is to its Client and this document does not exonerate parties to a transaction from exercising all their rights and obligations under the transaction documents. This document cannot be reproduced except in full, without prior written approval of the Company. Any unauthorized alteration, forgery or falsification of the content or appearance of this document is unlawful and offenders may be prosecuted to the fullest extent of the law. Unless otherwise stated the results shown in this test report refer only to the sample(s) tested and such sample(s) are retained for 30 days only.

Test Mode: 22; Polarity: Horizontal; Modulation:802.11ac; Bandwidth:20MHz; Channel:Low

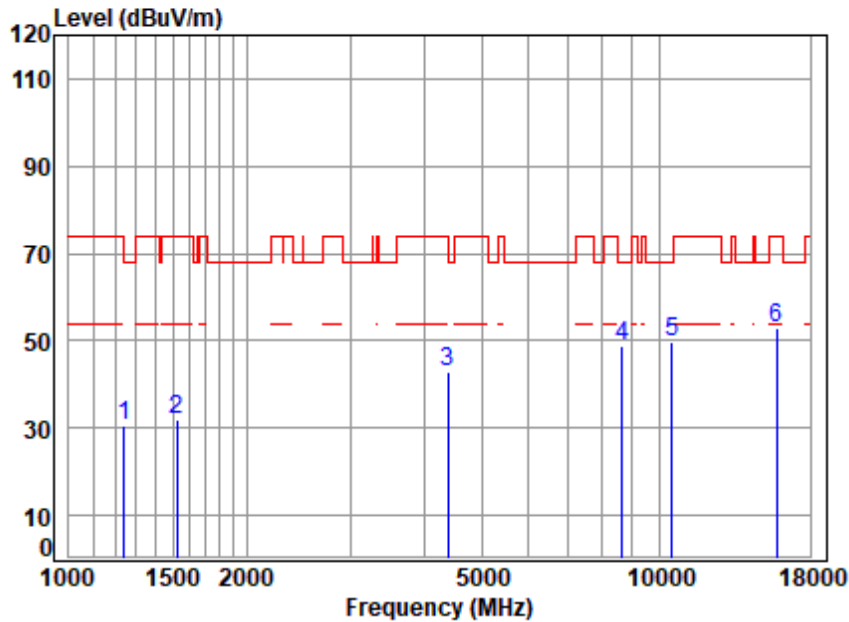

Site : chamber
 Condition: 3m HORIZONTAL
 Job No : 00955AT/00956AT
 Mode : 5260 TX RSE
 Note : 5G WIFI 11AC20

	Freq	Cable Loss	Ant Factor	Preamp Factor	Read Level	Limit Level	Over Limit	Remark
	MHz	dB	dB/m	dB	dBuV	dBuV/m	dBuV/m	dB
1	1242.068	3.66	24.99	38.35	40.31	30.61	68.20	-37.59 peak
2	1525.000	4.10	26.90	38.39	39.42	32.03	74.00	-41.97 peak
3	4379.699	7.04	34.64	35.81	36.89	42.76	74.00	-31.24 peak
4	8663.404	11.33	36.90	37.27	37.96	48.92	68.20	-19.28 peak
5	10520.000	12.77	37.30	37.62	37.31	49.76	68.20	-18.44 peak
6	15780.000	14.31	41.28	37.33	34.56	52.82	74.00	-21.18 peak



Unless otherwise agreed in writing, this document is issued by the Company subject to its General Conditions of Service printed overleaf, available on request or accessible at <https://www.sgs.com/en/Terms-and-Conditions>. Attention is drawn to the limitation of liability, indemnification and jurisdiction issues defined therein. Any holder of this document is advised that information contained hereon reflects the Company's findings at the time of its intervention only and within the limits of Client's instructions, if any. The Company's sole responsibility is to its Client and this document does not exonerate parties to a transaction from exercising all their rights and obligations under the transaction documents. This document cannot be reproduced except in full, without prior written approval of the Company. Any unauthorized alteration, forgery or falsification of the content or appearance of this document is unlawful and offenders may be prosecuted to the fullest extent of the law. Unless otherwise stated the results shown in this test report refer only to the sample(s) tested and such sample(s) are retained for 30 days only.

Attention: To check the authenticity of testing /inspection report & certificate, please contact us at telephone: (86-755) 8307 1443, or email: CN.Doccheck@sgs.com
 No.1 Workshop, M-10, Middle Section, Science & Technology Park, Nanshan District, Shenzhen, Guangdong, China 518057 t (86-755) 26012053 f (86-755) 26710594 www.sgs.com.cn
 中国·广东·深圳市南山区科技园中区M-10栋1号厂房 邮编: 518057 t (86-755) 26012053 f (86-755) 26710594 sgs.china@sgs.com

Test Mode: 22; Polarity: Vertical; Modulation:802.11ac; Bandwidth:20MHz; Channel:Low

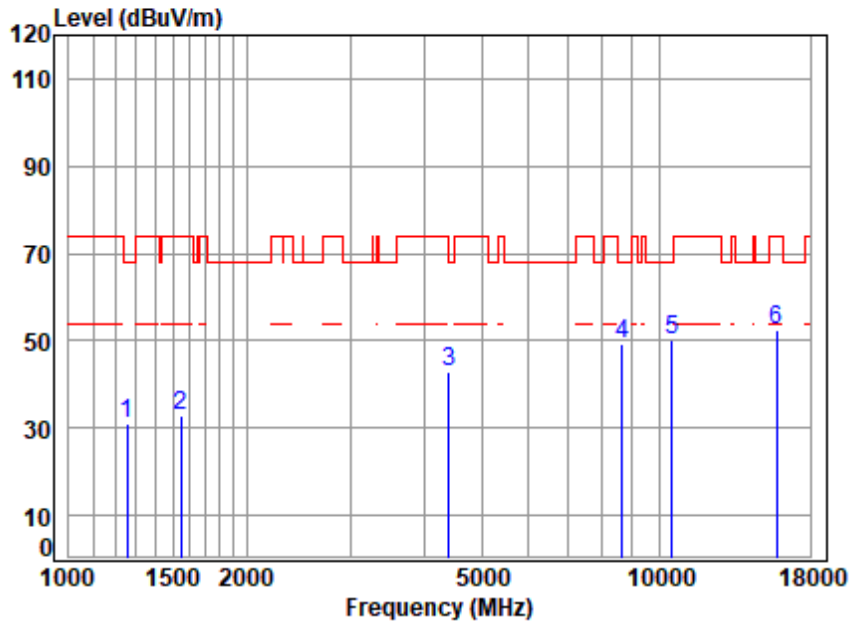

Site : chamber
 Condition: 3m VERTICAL
 Job No : 00955AT/00956AT
 Mode : 5260 TX RSE
 Note : 5G WIFI 11AC20

	Freq	Cable Loss	Ant Factor	Preamp Factor	Read Level	Level	Limit Line	Over Limit	Remark
	MHz	dB	dB/m	dB	dBuV	dBuV/m	dBuV/m	dB	
1	1256.512	3.68	25.06	38.35	40.73	31.12	68.20	-37.08	peak
2	1547.199	4.13	26.99	38.39	40.00	32.73	74.00	-41.27	peak
3	4405.090	7.06	34.74	35.79	37.02	43.03	68.20	-25.17	peak
4	8638.399	11.29	36.90	37.24	38.39	49.34	68.20	-18.86	peak
5	10520.000	12.77	37.30	37.62	37.61	50.06	68.20	-18.14	peak
6	15780.000	14.31	41.28	37.33	34.38	52.64	74.00	-21.36	peak



Unless otherwise agreed in writing, this document is issued by the Company subject to its General Conditions of Service printed overleaf, available on request or accessible at <https://www.sgs.com/en/Terms-and-Conditions>. Attention is drawn to the limitation of liability, indemnification and jurisdiction issues defined therein. Any holder of this document is advised that information contained hereon reflects the Company's findings at the time of its intervention only and within the limits of Client's instructions, if any. The Company's sole responsibility is to its Client and this document does not exonerate parties to a transaction from exercising all their rights and obligations under the transaction documents. This document cannot be reproduced except in full, without prior written approval of the Company. Any unauthorized alteration, forgery or falsification of the content or appearance of this document is unlawful and offenders may be prosecuted to the fullest extent of the law. Unless otherwise stated the results shown in this test report refer only to the sample(s) tested and such sample(s) are retained for 30 days only.

Attention: To check the authenticity of testing /inspection report & certificate, please contact us at telephone: (86-755) 8307 1443, or email: CN.Doccheck@sgs.com
 No.1 Workshop, M-10, Middle Section, Science & Technology Park, Nanshan District, Shenzhen, Guangdong, China 518057 t (86-755) 26012053 f (86-755) 26710594 www.sgs.com.cn
 中国·广东·深圳市南山区科技园中区M-10栋1号厂房 邮编: 518057 t (86-755) 26012053 f (86-755) 26710594 sgs.china@sgs.com

Test Mode: 22; Polarity: Horizontal; Modulation:802.11ac; Bandwidth:20MHz; Channel:middle

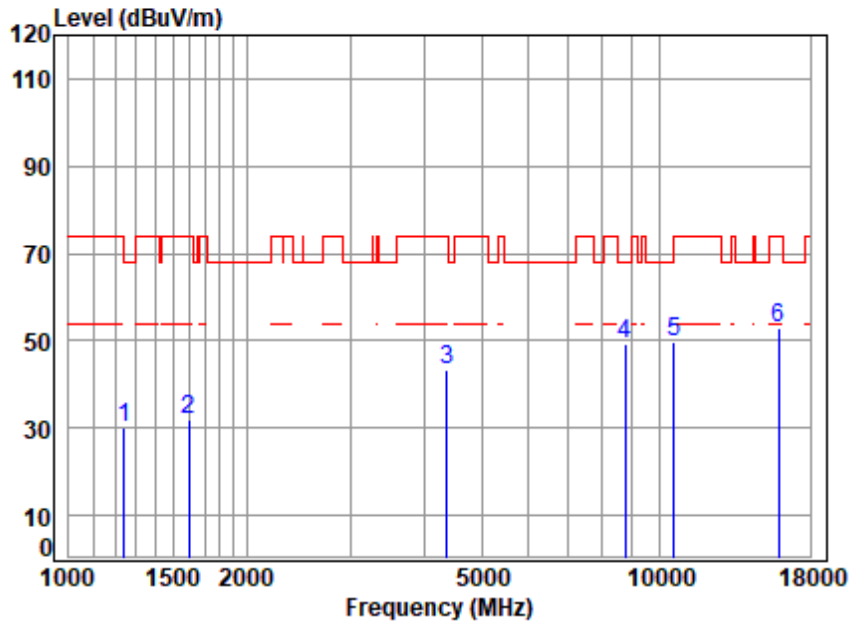

Site : chamber
 Condition: 3m HORIZONTAL
 Job No : 00955AT/00956AT
 Mode : 5300 TX RSE
 Note : 5G WIFI 11AC20

	Freq	Cable Loss	Ant Factor	Preamp Factor	Read Level	Level	Limit Line	Over Limit	Remark
	MHz	dB	dB/m	dB	dBuV	dBuV/m	dBuV/m	dB	
1	1242.068	3.66	24.99	38.35	39.85	30.15	68.20	-38.05	peak
2	1597.181	4.20	26.81	38.40	39.41	32.02	74.00	-41.98	peak
3	4367.058	7.04	34.54	35.82	37.57	43.33	74.00	-30.67	peak
4	8738.852	11.47	36.90	37.35	38.35	49.37	68.20	-18.83	peak
5	10600.000	12.80	37.30	37.66	37.20	49.64	68.20	-18.56	peak
6	15900.000	14.35	41.40	37.38	34.35	52.72	74.00	-21.28	peak



Unless otherwise agreed in writing, this document is issued by the Company subject to its General Conditions of Service printed overleaf, available on request or accessible at <https://www.sgs.com/en/Terms-and-Conditions>. Attention is drawn to the limitation of liability, indemnification and jurisdiction issues defined therein. Any holder of this document is advised that information contained hereon reflects the Company's findings at the time of its intervention only and within the limits of Client's instructions, if any. The Company's sole responsibility is to its Client and this document does not exonerate parties to a transaction from exercising all their rights and obligations under the transaction documents. This document cannot be reproduced except in full, without prior written approval of the Company. Any unauthorized alteration, forgery or falsification of the content or appearance of this document is unlawful and offenders may be prosecuted to the fullest extent of the law. Unless otherwise stated the results shown in this test report refer only to the sample(s) tested and such sample(s) are retained for 30 days only.

Attention: To check the authenticity of testing /inspection report & certificate, please contact us at telephone: (86-755) 8307 1443, or email: CN.Doccheck@sgs.com
 No.1 Workshop, M-10, Middle Section, Science & Technology Park, Nanshan District, Shenzhen, Guangdong, China 518057 t (86-755) 26012053 f (86-755) 26710594 www.sgs.com.cn
 中国·广东·深圳市南山区科技园中区M-10栋1号厂房 邮编: 518057 t (86-755) 26012053 f (86-755) 26710594 sgs.china@sgs.com

Test Mode: 22; Polarity: Vertical; Modulation:802.11ac; Bandwidth:20MHz; Channel:middle

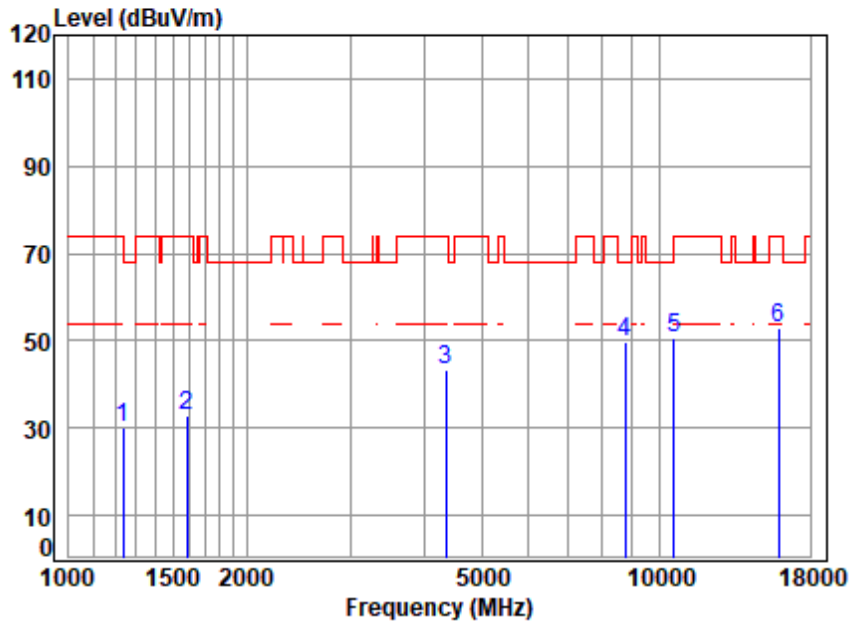

Site : chamber
 Condition: 3m VERTICAL
 Job No : 00955AT/00956AT
 Mode : 5300 TX RSE
 Note : 5G WIFI 11AC20

	Freq	Cable Loss	Ant Factor	Preamp Factor	Read Level	Level	Limit Line	Over Limit	Remark
	MHz	dB	dB/m	dB	dBuV	dBuV/m	dBuV/m	dB	
1	1238.483	3.65	24.94	38.35	39.79	30.03	74.00	-43.97	peak
2	1587.975	4.18	26.85	38.40	40.45	33.08	74.00	-40.92	peak
3	4354.454	7.03	34.44	35.83	37.59	43.23	74.00	-30.77	peak
4	8738.852	11.47	36.90	37.35	38.60	49.62	68.20	-18.58	peak
5	10600.000	12.80	37.30	37.66	38.18	50.62	68.20	-17.58	peak
6	15900.000	14.35	41.40	37.38	34.75	53.12	74.00	-20.88	peak



Unless otherwise agreed in writing, this document is issued by the Company subject to its General Conditions of Service printed overleaf, available on request or accessible at <https://www.sgs.com/en/Terms-and-Conditions>. Attention is drawn to the limitation of liability, indemnification and jurisdiction issues defined therein. Any holder of this document is advised that information contained hereon reflects the Company's findings at the time of its intervention only and within the limits of Client's instructions, if any. The Company's sole responsibility is to its Client and this document does not exonerate parties to a transaction from exercising all their rights and obligations under the transaction documents. This document cannot be reproduced except in full, without prior written approval of the Company. Any unauthorized alteration, forgery or falsification of the content or appearance of this document is unlawful and offenders may be prosecuted to the fullest extent of the law. Unless otherwise stated the results shown in this test report refer only to the sample(s) tested and such sample(s) are retained for 30 days only.

Attention: To check the authenticity of testing /inspection report & certificate, please contact us at telephone: (86-755) 8307 1443, or email: CN.Doccheck@sgs.com
 No.1 Workshop, M-10, Middle Section, Science & Technology Park, Nanshan District, Shenzhen, Guangdong, China 518057 t (86-755) 26012053 f (86-755) 26710594 www.sgs.com.cn
 中国·广东·深圳市南山区科技园中区M-10栋1号厂房 邮编: 518057 t (86-755) 26012053 f (86-755) 26710594 sgs.china@sgs.com

Test Mode: 22; Polarity: Horizontal; Modulation:802.11ac; Bandwidth:20MHz; Channel:High

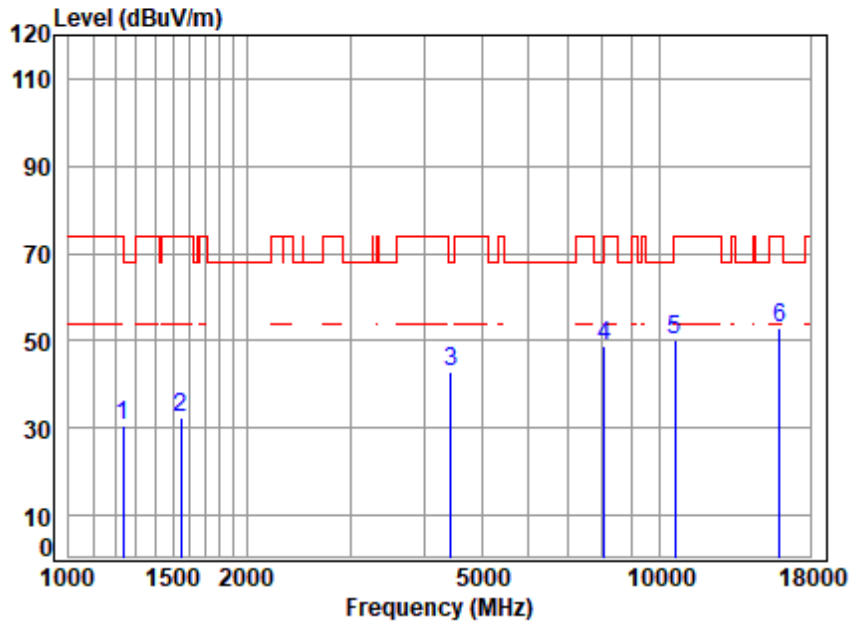

Site : chamber
 Condition: 3m HORIZONTAL
 Job No : 00955AT/00956AT
 Mode : 5320 TX RSE
 Note : 5G WIFI 11AC20

	Freq	Cable Loss	Ant Factor	Preamp Factor	Read Level	Level	Limit Line	Over Limit	Remark
	MHz	dB	dB/m	dB	dBuV	dBuV/m	dBuV/m	dB	
1	1238.483	3.65	24.94	38.35	40.51	30.75	74.00	-43.25	peak
2	1547.199	4.13	26.99	38.39	39.62	32.35	74.00	-41.65	peak
3	4430.628	7.08	34.43	35.77	37.06	42.80	68.20	-25.40	peak
4	8059.475	10.21	36.42	36.63	38.70	48.70	74.00	-25.30	peak
5	10640.000	12.81	37.22	37.68	38.04	50.39	74.00	-23.61	peak
6	p15960.000	14.37	41.52	37.40	34.47	52.96	74.00	-21.04	peak



Unless otherwise agreed in writing, this document is issued by the Company subject to its General Conditions of Service printed overleaf, available on request or accessible at <https://www.sgs.com/en/Terms-and-Conditions>. Attention is drawn to the limitation of liability, indemnification and jurisdiction issues defined therein. Any holder of this document is advised that information contained hereon reflects the Company's findings at the time of its intervention only and within the limits of Client's instructions, if any. The Company's sole responsibility is to its Client and this document does not exonerate parties to a transaction from exercising all their rights and obligations under the transaction documents. This document cannot be reproduced except in full, without prior written approval of the Company. Any unauthorized alteration, forgery or falsification of the content or appearance of this document is unlawful and offenders may be prosecuted to the fullest extent of the law. Unless otherwise stated the results shown in this test report refer only to the sample(s) tested and such sample(s) are retained for 30 days only.

Test Mode: 22; Polarity: Vertical; Modulation:802.11ac; Bandwidth:20MHz; Channel:High

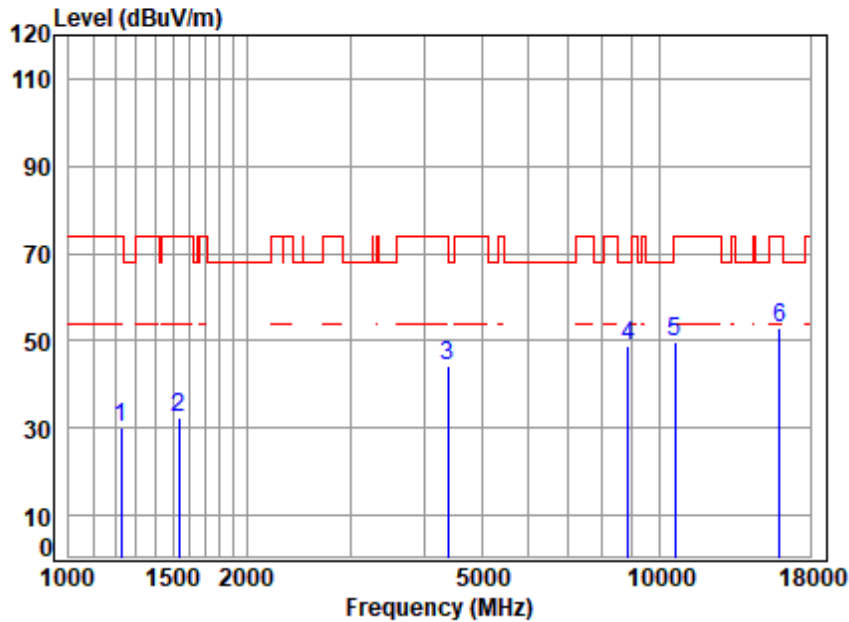

Site : chamber
 Condition: 3m VERTICAL
 Job No : 00955AT/00956AT
 Mode : 5320 TX RSE
 Note : 5G WIFI 11AC20

	Freq	Cable Loss	Ant Factor	Preamp Factor	Read Level	Level	Limit Line	Over Limit	Remark
	MHz	dB	dB/m	dB	dBuV	dBuV/m	dBuV/m	dB	
1	1227.791	3.63	24.79	38.34	39.83	29.91	74.00	-44.09	peak
2	1538.281	4.12	26.95	38.39	39.62	32.30	74.00	-41.70	peak
3	4392.376	7.05	34.74	35.80	38.05	44.04	74.00	-29.96	peak
4	8866.062	11.69	37.20	37.48	37.62	49.03	68.20	-19.17	peak
5	10640.000	12.81	37.22	37.68	37.47	49.82	74.00	-24.18	peak
6	15960.000	14.37	41.52	37.40	34.34	52.83	74.00	-21.17	peak



Unless otherwise agreed in writing, this document is issued by the Company subject to its General Conditions of Service printed overleaf, available on request or accessible at <https://www.sgs.com/en/Terms-and-Conditions>. Attention is drawn to the limitation of liability, indemnification and jurisdiction issues defined therein. Any holder of this document is advised that information contained hereon reflects the Company's findings at the time of its intervention only and within the limits of Client's instructions, if any. The Company's sole responsibility is to its Client and this document does not exonerate parties to a transaction from exercising all their rights and obligations under the transaction documents. This document cannot be reproduced except in full, without prior written approval of the Company. Any unauthorized alteration, forgery or falsification of the content or appearance of this document is unlawful and offenders may be prosecuted to the fullest extent of the law. Unless otherwise stated the results shown in this test report refer only to the sample(s) tested and such sample(s) are retained for 30 days only.

Test Mode: 22; Polarity: Horizontal; Modulation:802.11ac; Bandwidth:40MHz; Channel:Low

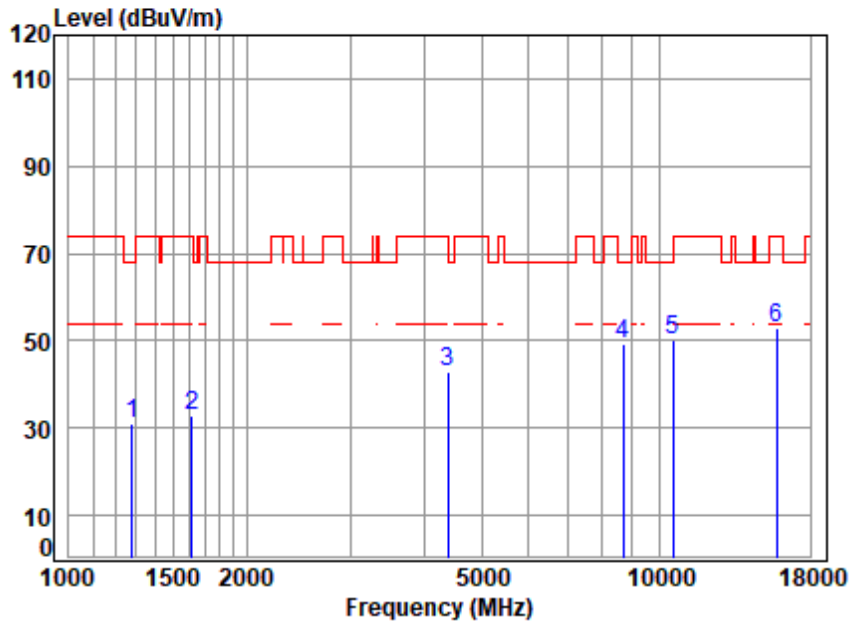

Site : chamber
 Condition: 3m HORIZONTAL
 Job No : 00955AT/00956AT
 Mode : 5270 TX RSE
 Note : 5G WIFI 11AC40

	Freq	Cable Loss	Ant Factor	Preamp Factor	Read Level	Level	Limit Line	Over Limit	Remark
	MHz	dB	dB/m	dB	dBuV	dBuV/m	dBuV/m	dB	
1	1278.492	3.72	24.93	38.35	40.91	31.21	68.20	-36.99	peak
2	1615.754	4.22	26.64	38.40	40.49	32.95	74.00	-41.05	peak
3	4379.699	7.04	34.64	35.81	36.85	42.72	74.00	-31.28	peak
4	8688.480	11.38	36.90	37.30	38.17	49.15	68.20	-19.05	peak
5	10540.000	12.78	37.30	37.63	37.53	49.98	68.20	-18.22	peak
6	15810.000	14.32	41.31	37.34	34.53	52.82	74.00	-21.18	peak



Unless otherwise agreed in writing, this document is issued by the Company subject to its General Conditions of Service printed overleaf, available on request or accessible at <https://www.sgs.com/en/Terms-and-Conditions>. Attention is drawn to the limitation of liability, indemnification and jurisdiction issues defined therein. Any holder of this document is advised that information contained hereon reflects the Company's findings at the time of its intervention only and within the limits of Client's instructions, if any. The Company's sole responsibility is to its Client and this document does not exonerate parties to a transaction from exercising all their rights and obligations under the transaction documents. This document cannot be reproduced except in full, without prior written approval of the Company. Any unauthorized alteration, forgery or falsification of the content or appearance of this document is unlawful and offenders may be prosecuted to the fullest extent of the law. Unless otherwise stated the results shown in this test report refer only to the sample(s) tested and such sample(s) are retained for 30 days only.

Attention: To check the authenticity of testing /inspection report & certificate, please contact us at telephone: (86-755) 8307 1443, or email: CN.Doccheck@sgs.com
 No.1 Workshop, M-10, Middle Section, Science & Technology Park, Nanshan District, Shenzhen, Guangdong, China 518057 t (86-755) 26012053 f (86-755) 26710594 www.sgs.com.cn
 中国·广东·深圳市南山区科技园中区M-10栋1号厂房 邮编: 518057 t (86-755) 26012053 f (86-755) 26710594 sgs.china@sgs.com

Test Mode: 22; Polarity: Vertical; Modulation:802.11ac; Bandwidth:40MHz; Channel:Low

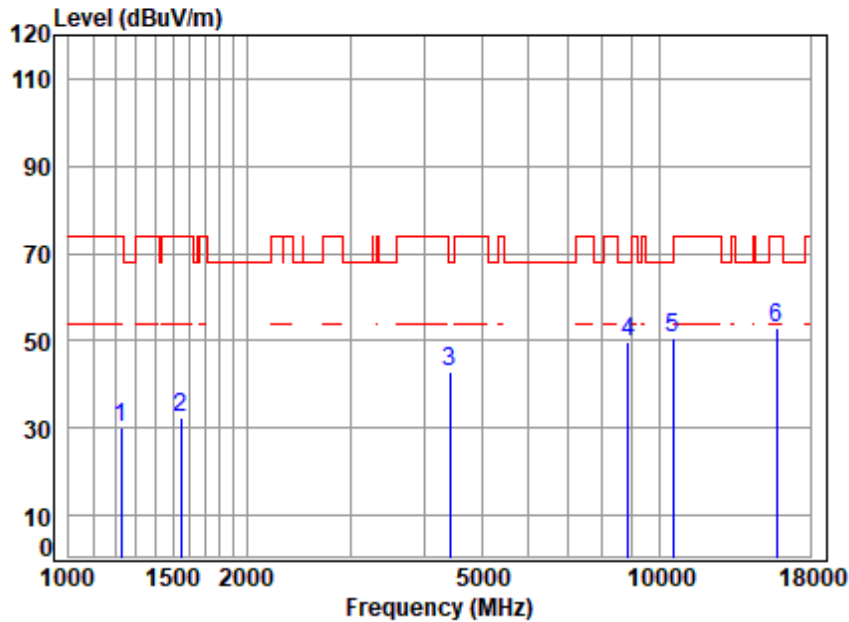

Site : chamber
 Condition: 3m VERTICAL
 Job No : 00955AT/00956AT
 Mode : 5270 TX RSE
 Note : 5G WIFI 11AC40

	Freq	Cable Loss	Ant Factor	Preamp Factor	Read Level	Level	Limit Line	Over Limit	Remark
	MHz	dB	dB/m	dB	dBuV	dBuV/m	dBuV/m	dB	
1	1227.791	3.63	24.79	38.34	39.82	29.90	74.00	-44.10	peak
2	1547.199	4.13	26.99	38.39	39.45	32.18	74.00	-41.82	peak
3	4417.841	7.07	34.59	35.78	36.78	42.66	68.20	-25.54	peak
4	8840.473	11.64	37.18	37.45	38.33	49.70	68.20	-18.50	peak
5	10540.000	12.78	37.30	37.63	38.12	50.57	68.20	-17.63	peak
6	15810.000	14.32	41.31	37.34	34.54	52.83	74.00	-21.17	peak



Unless otherwise agreed in writing, this document is issued by the Company subject to its General Conditions of Service printed overleaf, available on request or accessible at <https://www.sgs.com/en/Terms-and-Conditions>. Attention is drawn to the limitation of liability, indemnification and jurisdiction issues defined therein. Any holder of this document is advised that information contained hereon reflects the Company's findings at the time of its intervention only and within the limits of Client's instructions, if any. The Company's sole responsibility is to its Client and this document does not exonerate parties to a transaction from exercising all their rights and obligations under the transaction documents. This document cannot be reproduced except in full, without prior written approval of the Company. Any unauthorized alteration, forgery or falsification of the content or appearance of this document is unlawful and offenders may be prosecuted to the fullest extent of the law. Unless otherwise stated the results shown in this test report refer only to the sample(s) tested and such sample(s) are retained for 30 days only.

Test Mode: 22; Polarity: Horizontal; Modulation:802.11ac; Bandwidth:40MHz; Channel:High

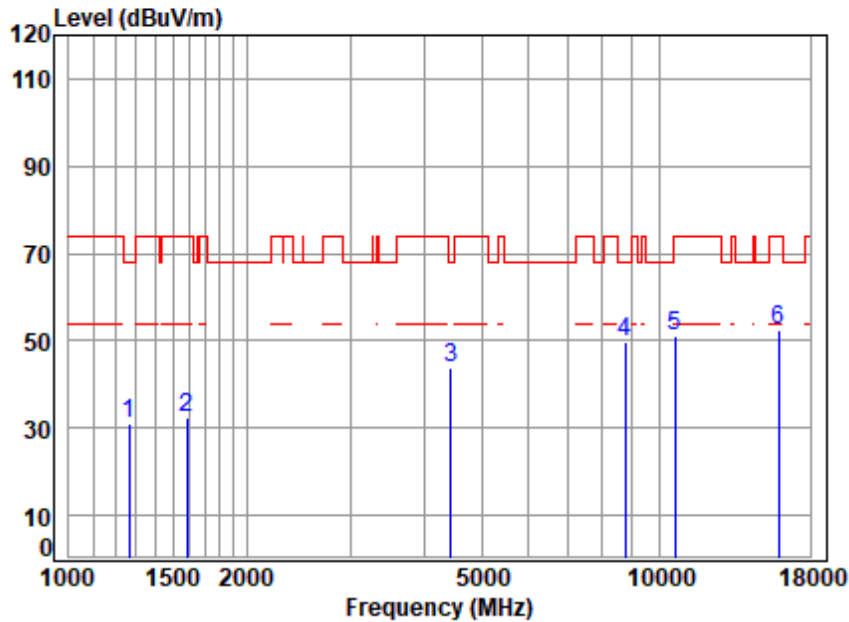

Site : chamber
 Condition: 3m HORIZONTAL
 Job No : 00955AT/00956AT
 Mode : 5310 TX RSE
 Note : 5G WIFI 11AC40

	Freq	Cable Loss	Ant Factor	Preamp Factor	Read Level	Level	Limit Line	Over Limit	Remark
	MHz	dB	dB/m	dB	dBuV	dBuV/m	dBuV/m	dB	
1	1263.796	3.69	25.02	38.35	40.52	30.88	68.20	-37.32	peak
2	1587.975	4.18	26.85	38.40	39.91	32.54	74.00	-41.46	peak
3	4443.453	7.09	34.28	35.77	38.19	43.79	68.20	-24.41	peak
4	8738.852	11.47	36.90	37.35	38.59	49.61	68.20	-18.59	peak
5	10620.000	12.80	37.26	37.67	38.58	50.97	74.00	-23.03	peak
6	15930.000	14.36	41.46	37.39	33.88	52.31	74.00	-21.69	peak



Unless otherwise agreed in writing, this document is issued by the Company subject to its General Conditions of Service printed overleaf, available on request or accessible at <https://www.sgs.com/en/Terms-and-Conditions>. Attention is drawn to the limitation of liability, indemnification and jurisdiction issues defined therein. Any holder of this document is advised that information contained hereon reflects the Company's findings at the time of its intervention only and within the limits of Client's instructions, if any. The Company's sole responsibility is to its Client and this document does not exonerate parties to a transaction from exercising all their rights and obligations under the transaction documents. This document cannot be reproduced except in full, without prior written approval of the Company. Any unauthorized alteration, forgery or falsification of the content or appearance of this document is unlawful and offenders may be prosecuted to the fullest extent of the law. Unless otherwise stated the results shown in this test report refer only to the sample(s) tested and such sample(s) are retained for 30 days only.

Attention: To check the authenticity of testing /inspection report & certificate, please contact us at telephone: (86-755) 8307 1443, or email: CN.Doccheck@sgs.com
 No.1 Workshop, M-10, Middle Section, Science & Technology Park, Nanshan District, Shenzhen, Guangdong, China 518057 t (86-755) 26012053 f (86-755) 26710594 www.sgs.com.cn
 中国·广东·深圳市南山区科技园中区M-10栋1号厂房 邮编: 518057 t (86-755) 26012053 f (86-755) 26710594 sgs.china@sgs.com

Test Mode: 22; Polarity: Vertical; Modulation:802.11ac; Bandwidth:40MHz; Channel:High

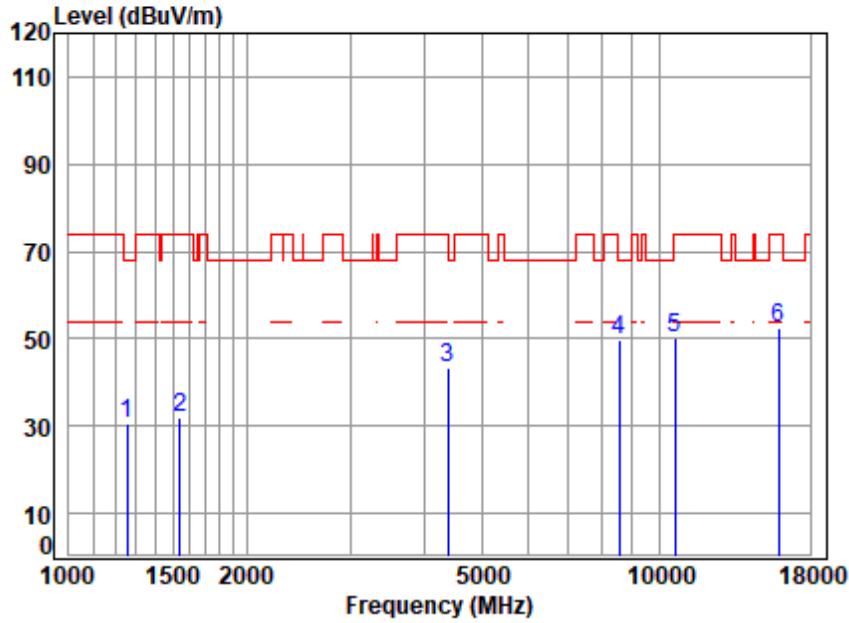

Site : chamber
 Condition: 3m VERTICAL
 Job No : 00955AT/00956AT
 Mode : 5310 TX RSE
 Note : 5G WIFI 11AC40

	Freq	Cable Loss	Ant Factor	Preamp Factor	Read Level	Level	Limit Line	Over Limit	Remark
	MHz	dB	dB/m	dB	dBuV	dBuV/m	dBuV/m	dB	
1	1256.512	3.68	25.06	38.35	40.03	30.42	68.20	-37.78	peak
2	1542.733	4.12	26.97	38.39	39.17	31.87	74.00	-42.13	peak
3	4379.699	7.04	34.64	35.81	37.62	43.49	74.00	-30.51	peak
4 p	8563.818	11.15	36.83	37.17	38.81	49.62	68.20	-18.58	peak
5	10620.000	12.80	37.26	37.67	37.73	50.12	74.00	-23.88	peak
6	15930.000	14.36	41.46	37.39	33.90	52.33	74.00	-21.67	peak



Unless otherwise agreed in writing, this document is issued by the Company subject to its General Conditions of Service printed overleaf, available on request or accessible at <https://www.sgs.com/en/Terms-and-Conditions>. Attention is drawn to the limitation of liability, indemnification and jurisdiction issues defined therein. Any holder of this document is advised that information contained hereon reflects the Company's findings at the time of its intervention only and within the limits of Client's instructions, if any. The Company's sole responsibility is to its Client and this document does not exonerate parties to a transaction from exercising all their rights and obligations under the transaction documents. This document cannot be reproduced except in full, without prior written approval of the Company. Any unauthorized alteration, forgery or falsification of the content or appearance of this document is unlawful and offenders may be prosecuted to the fullest extent of the law. Unless otherwise stated the results shown in this test report refer only to the sample(s) tested and such sample(s) are retained for 30 days only.

Test Mode: 22; Polarity: Horizontal; Modulation:802.11ac; Bandwidth:80MHz; Channel:middle

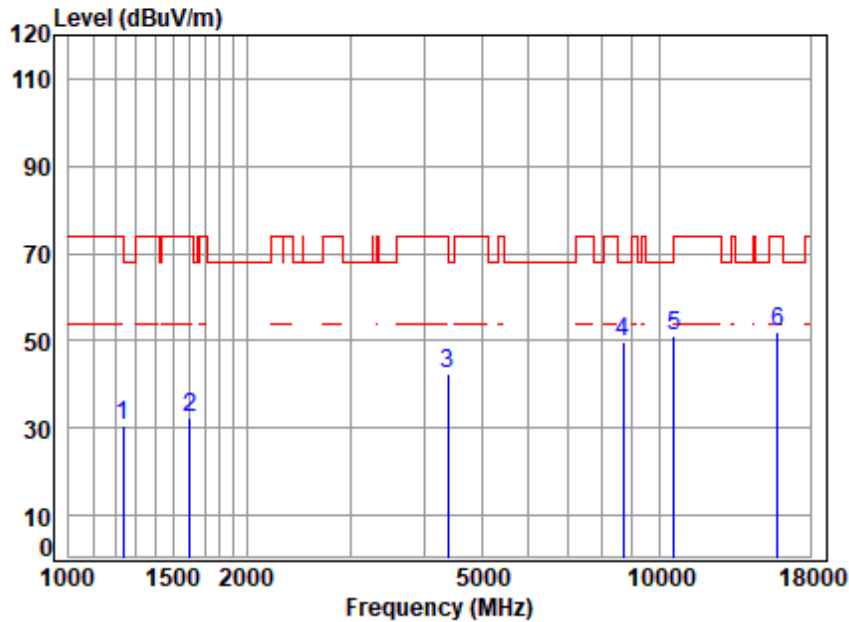

Site : chamber
 Condition: 3m HORIZONTAL
 Job No : 00955AT/00956AT
 Mode : 5290 TX RSE
 Note : 5G WIFI 11AC80

	Freq	Cable Loss	Ant Factor	Preamp Factor	Read Level	Level	Limit Line	Over Limit	Remark
	MHz	dB	dB/m	dB	dBuV	dBuV/m	dBuV/m	dB	
1	1238.483	3.65	24.94	38.35	40.17	30.41	74.00	-43.59	peak
2	1606.441	4.21	26.74	38.40	39.85	32.40	74.00	-41.60	peak
3	4392.376	7.05	34.74	35.80	36.55	42.54	74.00	-31.46	peak
4	8688.480	11.38	36.90	37.30	38.74	49.72	68.20	-18.48	peak
5	10580.000	12.79	37.30	37.65	38.54	50.98	68.20	-17.22	peak
6	15870.000	14.34	41.37	37.37	33.83	52.17	74.00	-21.83	peak



Unless otherwise agreed in writing, this document is issued by the Company subject to its General Conditions of Service printed overleaf, available on request or accessible at <https://www.sgs.com/en/Terms-and-Conditions>. Attention is drawn to the limitation of liability, indemnification and jurisdiction issues defined therein. Any holder of this document is advised that information contained hereon reflects the Company's findings at the time of its intervention only and within the limits of Client's instructions, if any. The Company's sole responsibility is to its Client and this document does not exonerate parties to a transaction from exercising all their rights and obligations under the transaction documents. This document cannot be reproduced except in full, without prior written approval of the Company. Any unauthorized alteration, forgery or falsification of the content or appearance of this document is unlawful and offenders may be prosecuted to the fullest extent of the law. Unless otherwise stated the results shown in this test report refer only to the sample(s) tested and such sample(s) are retained for 30 days only.

Attention: To check the authenticity of testing /inspection report & certificate, please contact us at telephone: (86-755) 8307 1443, or email: CN.Doccheck@sgs.com
 No.1 Workshop, M-10, Middle Section, Science & Technology Park, Nanshan District, Shenzhen, Guangdong, China 518057 t (86-755) 26012053 f (86-755) 26710594 www.sgs.com.cn
 中国·广东·深圳市南山区科技园中区M-10栋1号厂房 邮编: 518057 t (86-755) 26012053 f (86-755) 26710594 sgs.china@sgs.com

Test Mode: 22; Polarity: Vertical; Modulation:802.11ac; Bandwidth:80MHz; Channel:middle

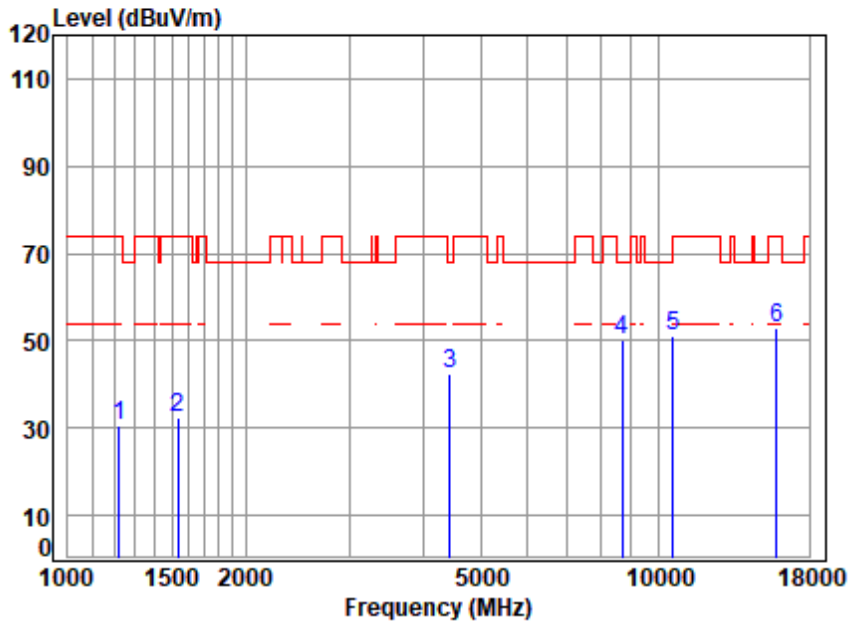

Site : chamber
 Condition: 3m VERTICAL
 Job No : 00955AT/00956AT
 Mode : 5290 TX RSE
 Note : 5G WIFI 11AC80

	Freq	Cable Loss	Ant Factor	Preamp Factor	Read Level	Limit Level	Over Line	Over Limit	Remark
	MHz	dB	dB/m	dB	dBuV	dBuV/m	dBuV/m	dB	
1	1220.714	3.62	24.69	38.34	40.56	30.53	74.00	-43.47	peak
2	1533.841	4.11	26.94	38.39	39.75	32.41	74.00	-41.59	peak
3	4443.453	7.09	34.28	35.77	37.04	42.64	68.20	-25.56	peak
4	8688.480	11.38	36.90	37.30	39.35	50.33	68.20	-17.87	peak
5	10580.000	12.79	37.30	37.65	38.50	50.94	68.20	-17.26	peak
6	15870.000	14.34	41.37	37.37	34.47	52.81	74.00	-21.19	peak



Unless otherwise agreed in writing, this document is issued by the Company subject to its General Conditions of Service printed overleaf, available on request or accessible at <https://www.sgs.com/en/Terms-and-Conditions>. Attention is drawn to the limitation of liability, indemnification and jurisdiction issues defined therein. Any holder of this document is advised that information contained hereon reflects the Company's findings at the time of its intervention only and within the limits of Client's instructions, if any. The Company's sole responsibility is to its Client and this document does not exonerate parties to a transaction from exercising all their rights and obligations under the transaction documents. This document cannot be reproduced except in full, without prior written approval of the Company. Any unauthorized alteration, forgery or falsification of the content or appearance of this document is unlawful and offenders may be prosecuted to the fullest extent of the law. Unless otherwise stated the results shown in this test report refer only to the sample(s) tested and such sample(s) are retained for 30 days only.

Attention: To check the authenticity of testing /inspection report & certificate, please contact us at telephone: (86-755) 8307 1443, or email: CN.Doccheck@sgs.com
 No.1 Workshop, M-10, Middle Section, Science & Technology Park, Nanshan District, Shenzhen, Guangdong, China 518057 t (86-755) 26012053 f (86-755) 26710594 www.sgsgroup.com.cn
 中国·广东·深圳市南山区科技园中区M-10栋1号厂房 邮编: 518057 t (86-755) 26012053 f (86-755) 26710594 sgs.china@sgs.com

Test Mode: 22; Polarity: Horizontal; Modulation:802.11ac; Bandwidth:160MHz; Channel:middle

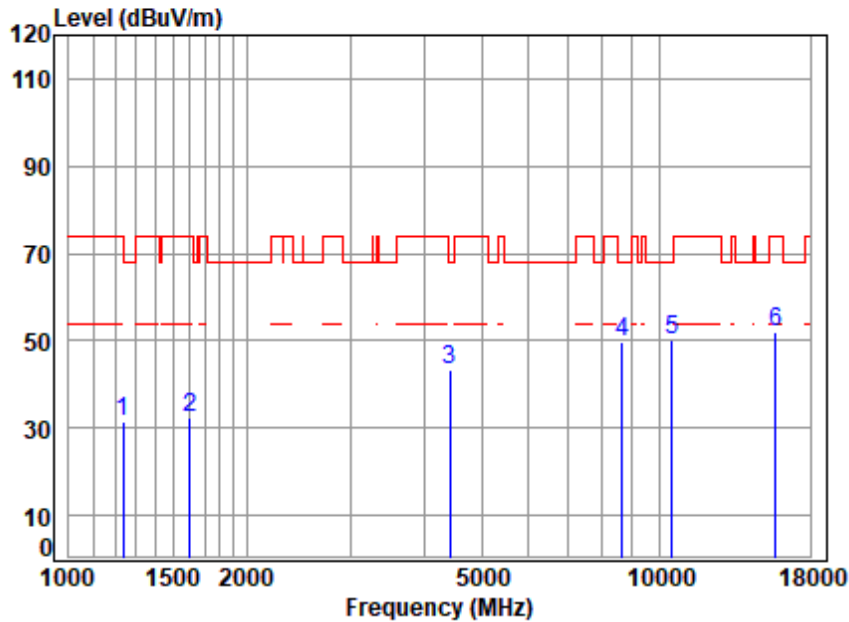

Site : chamber
 Condition: 3m HORIZONTAL
 Job No : 00955AT/00956AT
 Mode : 5250 TX RSE
 Note : 5G WIFI 11AC160

	Freq	Cable Loss	Ant Factor	Preamp Factor	Read Level	Level	Limit Line	Over Limit	Remark
	MHz	dB	dB/m	dB	dBuV	dBuV/m	dBuV/m	dB	
1	1238.483	3.65	24.94	38.35	41.11	31.35	74.00	-42.65	peak
2	1601.804	4.20	26.78	38.40	39.98	32.56	74.00	-41.44	peak
3	4417.841	7.07	34.59	35.78	37.28	43.16	68.20	-25.04	peak
4	8663.404	11.33	36.90	37.27	38.93	49.89	68.20	-18.31	peak
5	p10500.000	12.77	37.30	37.61	37.53	49.99	68.20	-18.21	peak
6	15750.000	14.30	41.25	37.32	33.91	52.14	74.00	-21.86	peak



Unless otherwise agreed in writing, this document is issued by the Company subject to its General Conditions of Service printed overleaf, available on request or accessible at <https://www.sgs.com/en/Terms-and-Conditions>. Attention is drawn to the limitation of liability, indemnification and jurisdiction issues defined therein. Any holder of this document is advised that information contained hereon reflects the Company's findings at the time of its intervention only and within the limits of Client's instructions, if any. The Company's sole responsibility is to its Client and this document does not exonerate parties to a transaction from exercising all their rights and obligations under the transaction documents. This document cannot be reproduced except in full, without prior written approval of the Company. Any unauthorized alteration, forgery or falsification of the content or appearance of this document is unlawful and offenders may be prosecuted to the fullest extent of the law. Unless otherwise stated the results shown in this test report refer only to the sample(s) tested and such sample(s) are retained for 30 days only.

Attention: To check the authenticity of testing /inspection report & certificate, please contact us at telephone: (86-755) 8307 1443, or email: CN.Doccheck@sgs.com
 No.1 Workshop, M-10, Middle Section, Science & Technology Park, Nanshan District, Shenzhen, Guangdong, China 518057 t (86-755) 26012053 f (86-755) 26710594 www.sgs.com.cn
 中国·广东·深圳市南山区科技园中区M-10栋1号厂房 邮编: 518057 t (86-755) 26012053 f (86-755) 26710594 sgs.china@sgs.com

Test Mode: 22; Polarity: Vertical; Modulation:802.11ac; Bandwidth:160MHz; Channel:middle

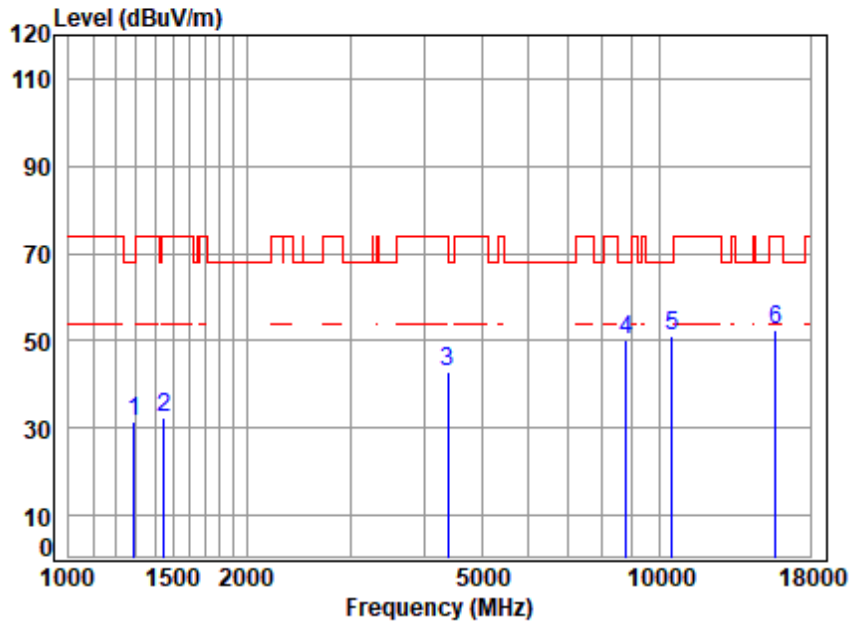

Site : chamber
 Condition: 3m VERTICAL
 Job No : 00955AT/00956AT
 Mode : 5250 TX RSE
 Note : 5G WIFI 11AC160

	Freq	Cable Loss	Ant Factor	Preamp Factor	Read Level	Level	Limit Line	Over Limit	Remark
	MHz	dB	dB/m	dB	dBuV	dBuV/m	dBuV/m	dB	
1	1289.627	3.74	24.86	38.36	41.21	31.45	68.20	-36.75	peak
2	1447.688	3.99	25.36	38.38	41.21	32.18	74.00	-41.82	peak
3	4392.376	7.05	34.74	35.80	37.08	43.07	74.00	-30.93	peak
4	8789.516	11.55	37.06	37.40	38.99	50.20	68.20	-18.00	peak
5	10500.000	12.77	37.30	37.61	38.59	51.05	68.20	-17.15	peak
6	15750.000	14.30	41.25	37.32	34.10	52.33	74.00	-21.67	peak



Unless otherwise agreed in writing, this document is issued by the Company subject to its General Conditions of Service printed overleaf, available on request or accessible at <https://www.sgs.com/en/Terms-and-Conditions>. Attention is drawn to the limitation of liability, indemnification and jurisdiction issues defined therein. Any holder of this document is advised that information contained hereon reflects the Company's findings at the time of its intervention only and within the limits of Client's instructions, if any. The Company's sole responsibility is to its Client and this document does not exonerate parties to a transaction from exercising all their rights and obligations under the transaction documents. This document cannot be reproduced except in full, without prior written approval of the Company. Any unauthorized alteration, forgery or falsification of the content or appearance of this document is unlawful and offenders may be prosecuted to the fullest extent of the law. Unless otherwise stated the results shown in this test report refer only to the sample(s) tested and such sample(s) are retained for 30 days only.

Test Mode: 23; Polarity: Horizontal; Modulation:802.11a; Bandwidth:20MHz; Channel:Low

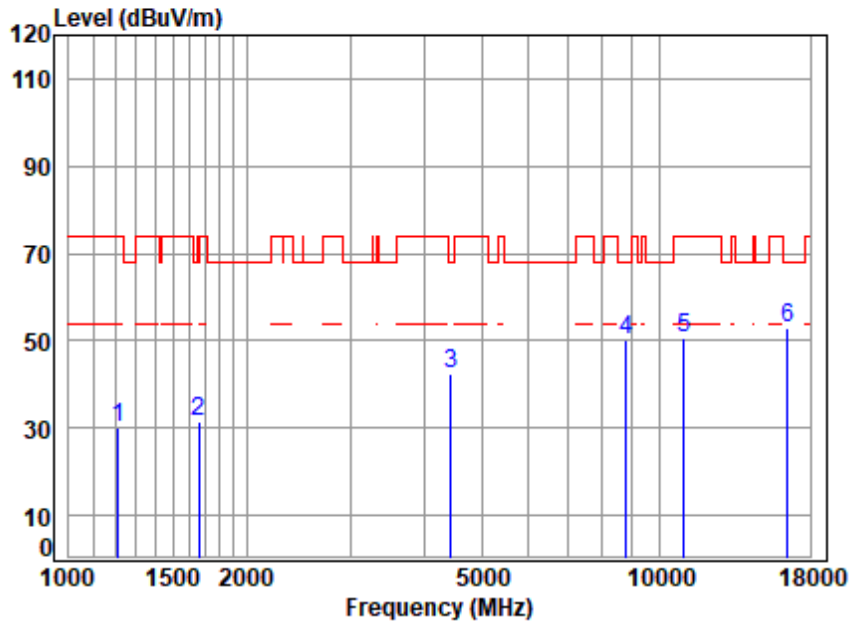

Site : chamber
 Condition: 3m HORIZONTAL
 Job No : 00955AT/00956AT
 Mode : 5500 TX RSE
 Note : 5G WIFI 11A

	Freq	Cable Loss	Ant Factor	Preamp Factor	Read Level	Level	Limit Line	Over Limit	Remark
	MHz	dB	dB/m	dB	dBuV	dBuV/m	dBuV/m	dB	
1	1210.174	3.60	24.54	38.34	40.33	30.13	74.00	-43.87	peak
2	1658.337	4.28	26.28	38.41	39.54	31.69	68.20	-36.51	peak
3	4443.453	7.09	34.28	35.77	36.81	42.41	68.20	-25.79	peak
4	8789.516	11.55	37.06	37.40	38.94	50.15	68.20	-18.05	peak
5	11000.000	12.90	37.50	37.84	38.26	50.82	74.00	-23.18	peak
6	p16500.000	14.47	42.10	37.47	33.80	52.90	68.20	-15.30	peak



Unless otherwise agreed in writing, this document is issued by the Company subject to its General Conditions of Service printed overleaf, available on request or accessible at <https://www.sgs.com/en/Terms-and-Conditions>. Attention is drawn to the limitation of liability, indemnification and jurisdiction issues defined therein. Any holder of this document is advised that information contained hereon reflects the Company's findings at the time of its intervention only and within the limits of Client's instructions, if any. The Company's sole responsibility is to its Client and this document does not exonerate parties to a transaction from exercising all their rights and obligations under the transaction documents. This document cannot be reproduced except in full, without prior written approval of the Company. Any unauthorized alteration, forgery or falsification of the content or appearance of this document is unlawful and offenders may be prosecuted to the fullest extent of the law. Unless otherwise stated the results shown in this test report refer only to the sample(s) tested and such sample(s) are retained for 30 days only.

Test Mode: 23; Polarity: Vertical; Modulation:802.11a; Bandwidth:20MHz; Channel:Low

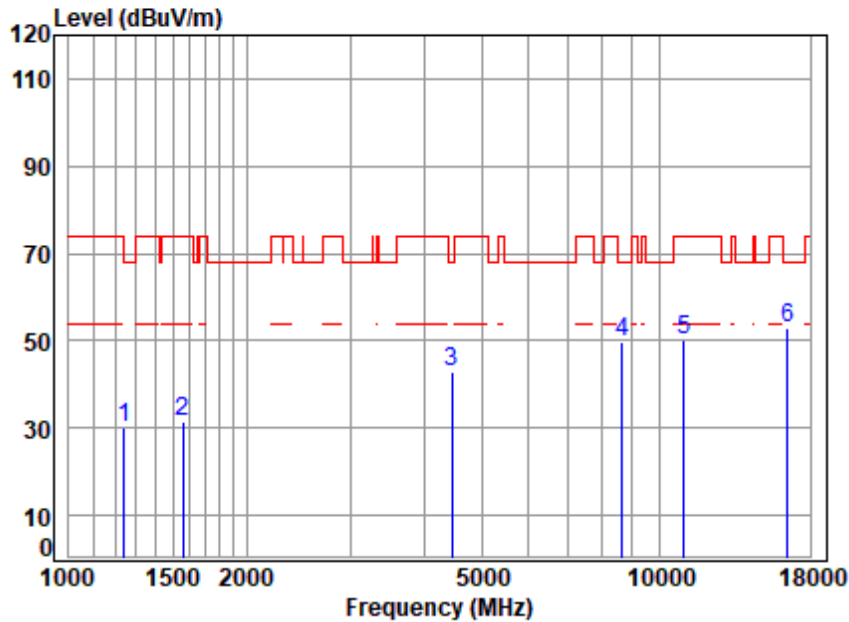

Site : chamber
 Condition: 3m VERTICAL
 Job No : 00955AT/00956AT
 Mode : 5500 TX RSE
 Note : 5G WIFI 11A

	Freq	Cable Loss	Ant Factor	Preamp Factor	Read Level	Level	Limit Line	Over Limit	Remark
	MHz	dB	dB/m	dB	dBuV	dBuV/m	dBuV/m	dB	
1	1242.068	3.66	24.99	38.35	39.95	30.25	68.20	-37.95	peak
2	1560.673	4.15	26.96	38.40	38.89	31.60	74.00	-42.40	peak
3	4456.315	7.09	34.12	35.76	37.22	42.67	68.20	-25.53	peak
4	8638.399	11.29	36.90	37.24	38.78	49.73	68.20	-18.47	peak
5	11000.000	12.90	37.50	37.84	37.81	50.37	74.00	-23.63	peak
6	p16500.000	14.47	42.10	37.47	33.73	52.83	68.20	-15.37	peak



Unless otherwise agreed in writing, this document is issued by the Company subject to its General Conditions of Service printed overleaf, available on request or accessible at <https://www.sgs.com/en/Terms-and-Conditions>. Attention is drawn to the limitation of liability, indemnification and jurisdiction issues defined therein. Any holder of this document is advised that information contained hereon reflects the Company's findings at the time of its intervention only and within the limits of Client's instructions, if any. The Company's sole responsibility is to its Client and this document does not exonerate parties to a transaction from exercising all their rights and obligations under the transaction documents. This document cannot be reproduced except in full, without prior written approval of the Company. Any unauthorized alteration, forgery or falsification of the content or appearance of this document is unlawful and offenders may be prosecuted to the fullest extent of the law. Unless otherwise stated the results shown in this test report refer only to the sample(s) tested and such sample(s) are retained for 30 days only.

Test Mode: 23; Polarity: Horizontal; Modulation:802.11a; Bandwidth:20MHz; Channel:middle

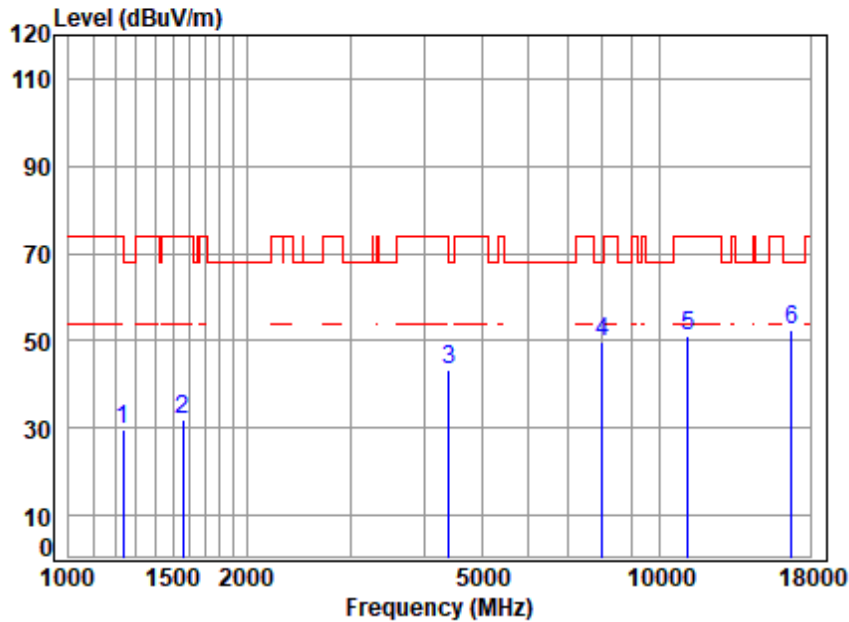

Site : chamber
 Condition: 3m HORIZONTAL
 Job No : 00955AT/00956AT
 Mode : 5580 TX RSE
 Note : 5G WIFI 11A

	Freq	Cable Loss	Ant Factor	Preamp Factor	Read Level	Level	Limit Line	Over Limit	Remark
	MHz	dB	dB/m	dB	dBuV	dBuV/m	dBuV/m	dB	
1	1234.909	3.64	24.89	38.35	39.69	29.87	74.00	-44.13	peak
2	1560.673	4.15	26.96	38.40	39.10	31.81	74.00	-42.19	peak
3	4405.090	7.06	34.74	35.79	37.17	43.18	68.20	-25.02	peak
4	8013.020	10.13	36.40	36.57	39.75	49.71	68.20	-18.49	peak
5	11160.000	12.93	37.62	37.79	38.18	50.94	74.00	-23.06	peak
6	p16740.000	14.51	42.78	37.49	32.75	52.55	68.20	-15.65	peak



Unless otherwise agreed in writing, this document is issued by the Company subject to its General Conditions of Service printed overleaf, available on request or accessible at <https://www.sgs.com/en/Terms-and-Conditions>. Attention is drawn to the limitation of liability, indemnification and jurisdiction issues defined therein. Any holder of this document is advised that information contained hereon reflects the Company's findings at the time of its intervention only and within the limits of Client's instructions, if any. The Company's sole responsibility is to its Client and this document does not exonerate parties to a transaction from exercising all their rights and obligations under the transaction documents. This document cannot be reproduced except in full, without prior written approval of the Company. Any unauthorized alteration, forgery or falsification of the content or appearance of this document is unlawful and offenders may be prosecuted to the fullest extent of the law. Unless otherwise stated the results shown in this test report refer only to the sample(s) tested and such sample(s) are retained for 30 days only.

Test Mode: 23; Polarity: Vertical; Modulation:802.11a; Bandwidth:20MHz; Channel:middle

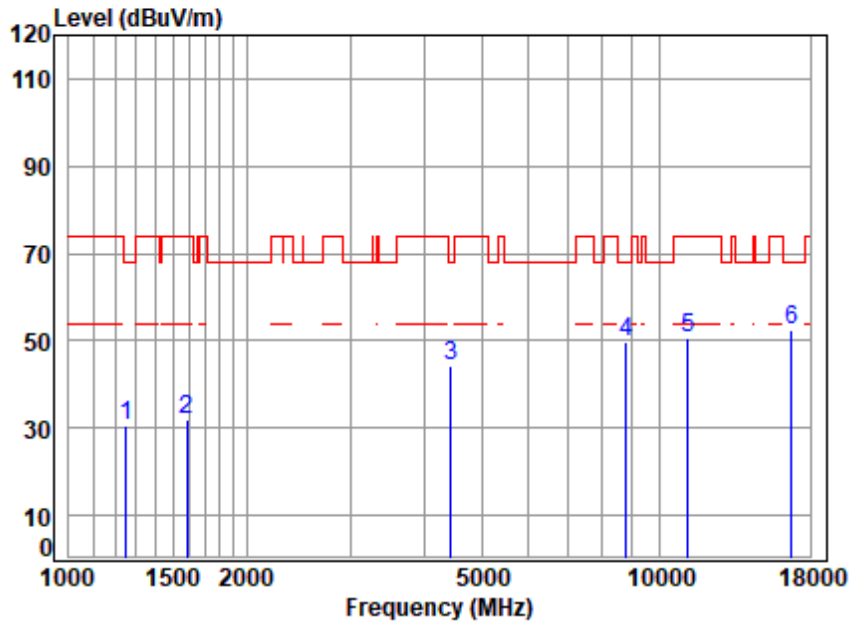

Site : chamber
 Condition: 3m VERTICAL
 Job No : 00955AT/00956AT
 Mode : 5580 TX RSE
 Note : 5G WIFI 11A

	Cable	Ant	Preamp	Read	Limit	Over		
Freq	Loss	Factor	Factor	Level	Level	Line	Limit	Remark
MHz	dB	dB/m	dB	dBuV	dBuV/m	dBuV/m	dB	
1	1249.269	3.67	25.09	38.35	40.30	30.71	68.20	-37.49 peak
2	1583.392	4.18	26.87	38.40	39.35	32.00	74.00	-42.00 peak
3	4443.453	7.09	34.28	35.77	38.57	44.17	68.20	-24.03 peak
4	8789.516	11.55	37.06	37.40	38.39	49.60	68.20	-18.60 peak
5	11160.000	12.93	37.62	37.79	37.82	50.58	74.00	-23.42 peak
6	p16740.000	14.51	42.78	37.49	32.60	52.40	68.20	-15.80 peak



Unless otherwise agreed in writing, this document is issued by the Company subject to its General Conditions of Service printed overleaf, available on request or accessible at <https://www.sgs.com/en/Terms-and-Conditions>. Attention is drawn to the limitation of liability, indemnification and jurisdiction issues defined therein. Any holder of this document is advised that information contained hereon reflects the Company's findings at the time of its intervention only and within the limits of Client's instructions, if any. The Company's sole responsibility is to its Client and this document does not exonerate parties to a transaction from exercising all their rights and obligations under the transaction documents. This document cannot be reproduced except in full, without prior written approval of the Company. Any unauthorized alteration, forgery or falsification of the content or appearance of this document is unlawful and offenders may be prosecuted to the fullest extent of the law. Unless otherwise stated the results shown in this test report refer only to the sample(s) tested and such sample(s) are retained for 30 days only.

Attention: To check the authenticity of testing /inspection report & certificate, please contact us at telephone: (86-755) 8307 1443, or email: CN.Doccheck@sgs.com
 No.1 Workshop, M-10, Middle Section, Science & Technology Park, Nanshan District, Shenzhen, Guangdong, China 518057 t (86-755) 26012053 f (86-755) 26710594 www.sgs.com.cn
 中国·广东·深圳市南山区科技园中区M-10栋1号厂房 邮编: 518057 t (86-755) 26012053 f (86-755) 26710594 sgs.china@sgs.com

Test Mode: 23; Polarity: Horizontal; Modulation:802.11a; Bandwidth:20MHz; Channel:High

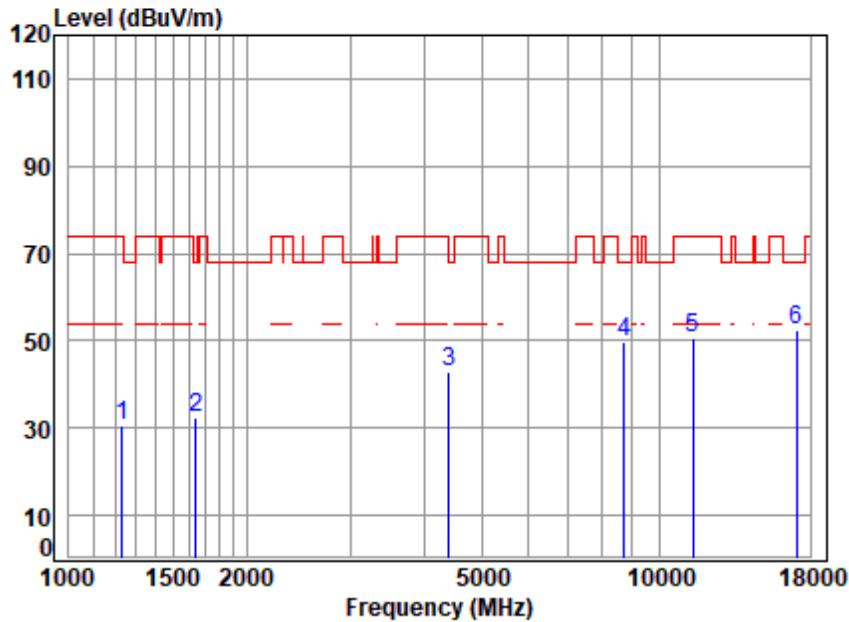

Site : chamber
 Condition: 3m HORIZONTAL
 Job No : 00955AT/00956AT
 Mode : 5700 TX RSE
 Note : 5G WIFI 11A

	Freq	Cable Loss	Ant Factor	Preamp Factor	Read Level	Level	Limit Line	Over Limit	Remark
	MHz	dB	dB/m	dB	dBuV	dBuV/m	dBuV/m	dB	
1	1231.345	3.64	24.84	38.35	40.39	30.52	74.00	-43.48	peak
2	1644.019	4.26	26.36	38.41	40.01	32.22	68.20	-35.98	peak
3	4405.090	7.06	34.74	35.79	36.88	42.89	68.20	-25.31	peak
4	8713.630	11.42	36.90	37.32	38.94	49.94	68.20	-18.26	peak
5	11400.000	12.98	37.70	37.72	37.62	50.58	74.00	-23.42	peak
6	p17100.000	14.62	43.10	37.53	32.32	52.51	68.20	-15.69	peak



Unless otherwise agreed in writing, this document is issued by the Company subject to its General Conditions of Service printed overleaf, available on request or accessible at <https://www.sgs.com/en/Terms-and-Conditions>. Attention is drawn to the limitation of liability, indemnification and jurisdiction issues defined therein. Any holder of this document is advised that information contained hereon reflects the Company's findings at the time of its intervention only and within the limits of Client's instructions, if any. The Company's sole responsibility is to its Client and this document does not exonerate parties to a transaction from exercising all their rights and obligations under the transaction documents. This document cannot be reproduced except in full, without prior written approval of the Company. Any unauthorized alteration, forgery or falsification of the content or appearance of this document is unlawful and offenders may be prosecuted to the fullest extent of the law. Unless otherwise stated the results shown in this test report refer only to the sample(s) tested and such sample(s) are retained for 30 days only.

Attention: To check the authenticity of testing /inspection report & certificate, please contact us at telephone: (86-755) 8307 1443, or email: CN.Doccheck@sgs.com
 No.1 Workshop, M-10, Middle Section, Science & Technology Park, Nanshan District, Shenzhen, Guangdong, China 518057 t (86-755) 26012053 f (86-755) 26710594 www.sgs.com.cn
 中国·广东·深圳市南山区科技园中区M-10栋1号厂房 邮编: 518057 t (86-755) 26012053 f (86-755) 26710594 sgs.china@sgs.com

Test Mode: 23; Polarity: Vertical; Modulation:802.11a; Bandwidth:20MHz; Channel:High

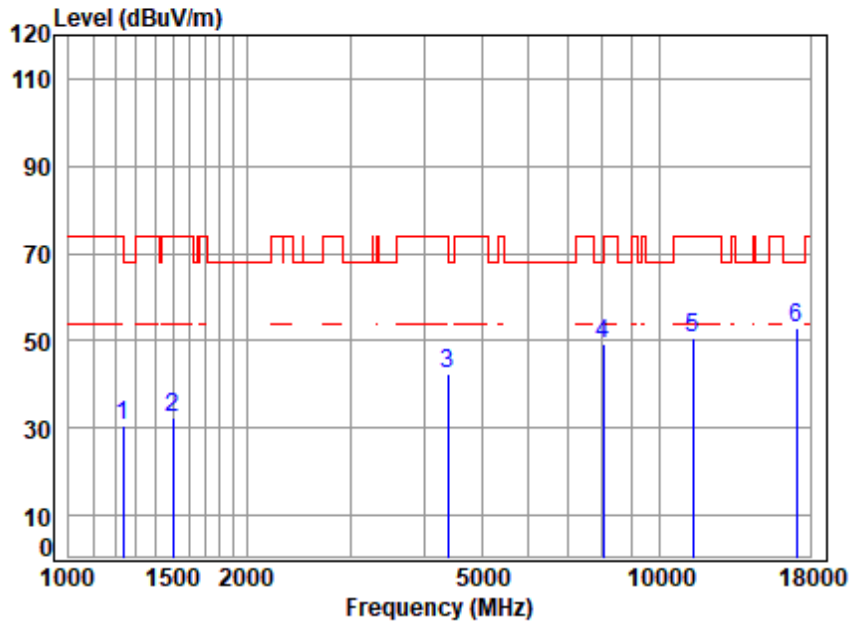

Site : chamber
 Condition: 3m VERTICAL
 Job No : 00955AT/00956AT
 Mode : 5700 TX RSE
 Note : 5G WIFI 11A

	Freq	Cable Loss	Ant Factor	Preamp Factor	Read Level	Level	Limit Line	Over Limit	Remark
	MHz	dB	dB/m	dB	dBuV	dBuV/m	dBuV/m	dB	
1	1238.483	3.65	24.94	38.35	40.20	30.44	74.00	-43.56	peak
2	1503.119	4.07	26.81	38.39	39.94	32.43	74.00	-41.57	peak
3	4379.699	7.04	34.64	35.81	36.35	42.22	74.00	-31.78	peak
4	8036.214	10.17	36.40	36.60	39.26	49.23	74.00	-24.77	peak
5	11400.000	12.98	37.70	37.72	37.58	50.54	74.00	-23.46	peak
6	p17100.000	14.62	43.10	37.53	32.82	53.01	68.20	-15.19	peak



Unless otherwise agreed in writing, this document is issued by the Company subject to its General Conditions of Service printed overleaf, available on request or accessible at <https://www.sgs.com/en/Terms-and-Conditions>. Attention is drawn to the limitation of liability, indemnification and jurisdiction issues defined therein. Any holder of this document is advised that information contained hereon reflects the Company's findings at the time of its intervention only and within the limits of Client's instructions, if any. The Company's sole responsibility is to its Client and this document does not exonerate parties to a transaction from exercising all their rights and obligations under the transaction documents. This document cannot be reproduced except in full, without prior written approval of the Company. Any unauthorized alteration, forgery or falsification of the content or appearance of this document is unlawful and offenders may be prosecuted to the fullest extent of the law. Unless otherwise stated the results shown in this test report refer only to the sample(s) tested and such sample(s) are retained for 30 days only.
 Attention: To check the authenticity of testing /inspection report & certificate, please contact us at telephone: (86-755) 8307 1443, or email: CN.Doccheck@sgs.com
 No.1 Workshop, M-10, Middle Section, Science & Technology Park, Nanshan District, Shenzhen, Guangdong, China 518057 t (86-755) 26012053 f (86-755) 26710594 www.sgs.com.cn
 中国·广东·深圳市南山区科技园中区M-10栋1号厂房 邮编: 518057 t (86-755) 26012053 f (86-755) 26710594 sgs.china@sgs.com

Test Mode: 23; Polarity: Horizontal; Modulation:802.11ac; Bandwidth:20MHz; Channel:Low

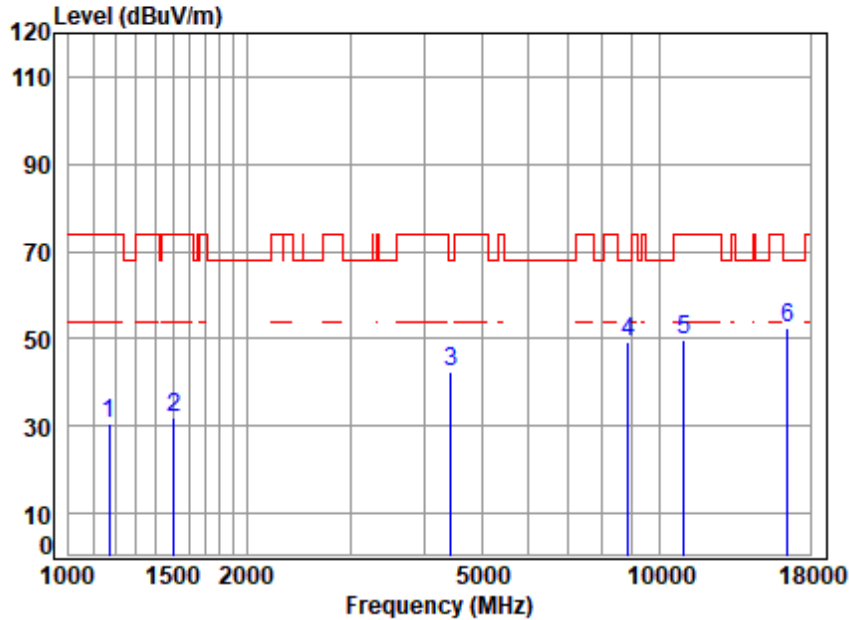

Site : chamber
 Condition: 3m HORIZONTAL
 Job No : 00955AT/00956AT
 Mode : 5500 TX RSE
 Note : 5G WIFI 11AC20

	Freq	Cable Loss	Ant Factor	Preamp Factor	Read Level	Level	Limit Line	Over Limit	Remark
	MHz	dB	dB/m	dB	dBuV	dBuV/m	dBuV/m	dB	
1	1172.303	3.53	24.12	38.33	41.14	30.46	74.00	-43.54	peak
2	1507.470	4.07	26.83	38.39	39.50	32.01	74.00	-41.99	peak
3	4430.628	7.08	34.43	35.77	36.82	42.56	68.20	-25.64	peak
4	8840.473	11.64	37.18	37.45	38.10	49.47	68.20	-18.73	peak
5	11000.000	12.90	37.50	37.84	37.30	49.86	74.00	-24.14	peak
6	p16500.000	14.47	42.10	37.47	33.32	52.42	68.20	-15.78	peak



Unless otherwise agreed in writing, this document is issued by the Company subject to its General Conditions of Service printed overleaf, available on request or accessible at <https://www.sgs.com/en/Terms-and-Conditions>. Attention is drawn to the limitation of liability, indemnification and jurisdiction issues defined therein. Any holder of this document is advised that information contained hereon reflects the Company's findings at the time of its intervention only and within the limits of Client's instructions, if any. The Company's sole responsibility is to its Client and this document does not exonerate parties to a transaction from exercising all their rights and obligations under the transaction documents. This document cannot be reproduced except in full, without prior written approval of the Company. Any unauthorized alteration, forgery or falsification of the content or appearance of this document is unlawful and offenders may be prosecuted to the fullest extent of the law. Unless otherwise stated the results shown in this test report refer only to the sample(s) tested and such sample(s) are retained for 30 days only.

Test Mode: 23; Polarity: Vertical; Modulation:802.11ac; Bandwidth:20MHz; Channel:Low

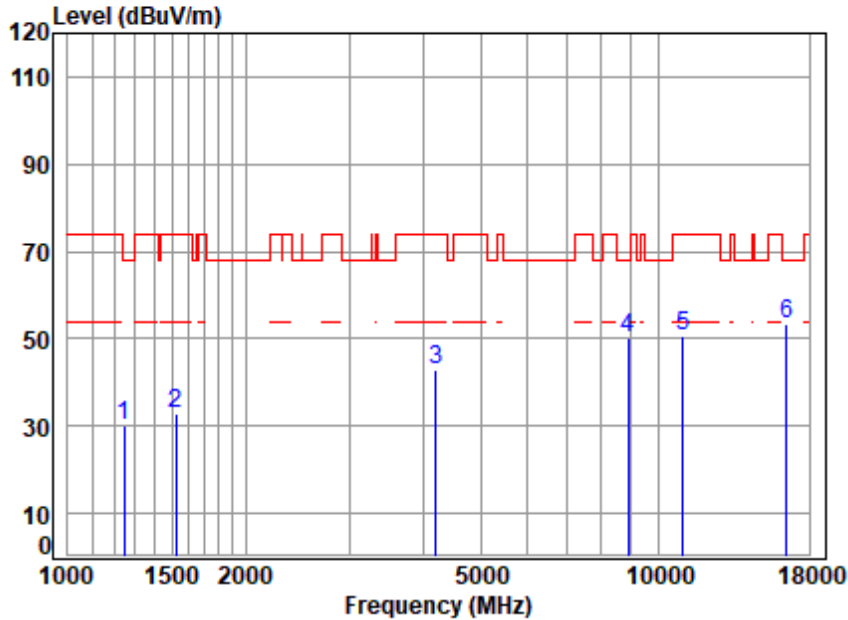

Site : chamber
 Condition: 3m VERTICAL
 Job No : 00955AT/00956AT
 Mode : 5500 TX RSE
 Note : 5G WIFI 11AC20

	Freq	Cable Loss	Ant Factor	Preamp Factor	Read Level	Level	Limit Line	Over Limit	Remark
	MHz	dB	dB/m	dB	dBuV	dBuV/m	dBuV/m	dB	
1	1245.663	3.66	25.04	38.35	39.87	30.22	68.20	-37.98	peak
2	1525.000	4.10	26.90	38.39	40.31	32.92	74.00	-41.08	peak
3	4193.872	6.92	33.80	35.95	38.04	42.81	74.00	-31.19	peak
4	8891.725	11.73	37.20	37.50	38.57	50.00	68.20	-18.20	peak
5	11000.000	12.90	37.50	37.84	38.00	50.56	74.00	-23.44	peak
6	p16500.000	14.47	42.10	37.47	34.19	53.29	68.20	-14.91	peak



Unless otherwise agreed in writing, this document is issued by the Company subject to its General Conditions of Service printed overleaf, available on request or accessible at <https://www.sgs.com/en/Terms-and-Conditions>. Attention is drawn to the limitation of liability, indemnification and jurisdiction issues defined therein. Any holder of this document is advised that information contained hereon reflects the Company's findings at the time of its intervention only and within the limits of Client's instructions, if any. The Company's sole responsibility is to its Client and this document does not exonerate parties to a transaction from exercising all their rights and obligations under the transaction documents. This document cannot be reproduced except in full, without prior written approval of the Company. Any unauthorized alteration, forgery or falsification of the content or appearance of this document is unlawful and offenders may be prosecuted to the fullest extent of the law. Unless otherwise stated the results shown in this test report refer only to the sample(s) tested and such sample(s) are retained for 30 days only.

Attention: To check the authenticity of testing /inspection report & certificate, please contact us at telephone: (86-755) 8307 1443, or email: CN.Doccheck@sgs.com
 No.1 Workshop, M-10, Middle Section, Science & Technology Park, Nanshan District, Shenzhen, Guangdong, China 518057 t (86-755) 26012053 f (86-755) 26710594 www.sgs.com.cn
 中国·广东·深圳市南山区科技园中区M-10栋1号厂房 邮编: 518057 t (86-755) 26012053 f (86-755) 26710594 sgs.china@sgs.com

Test Mode: 23; Polarity: Horizontal; Modulation:802.11ac; Bandwidth:20MHz; Channel:middle

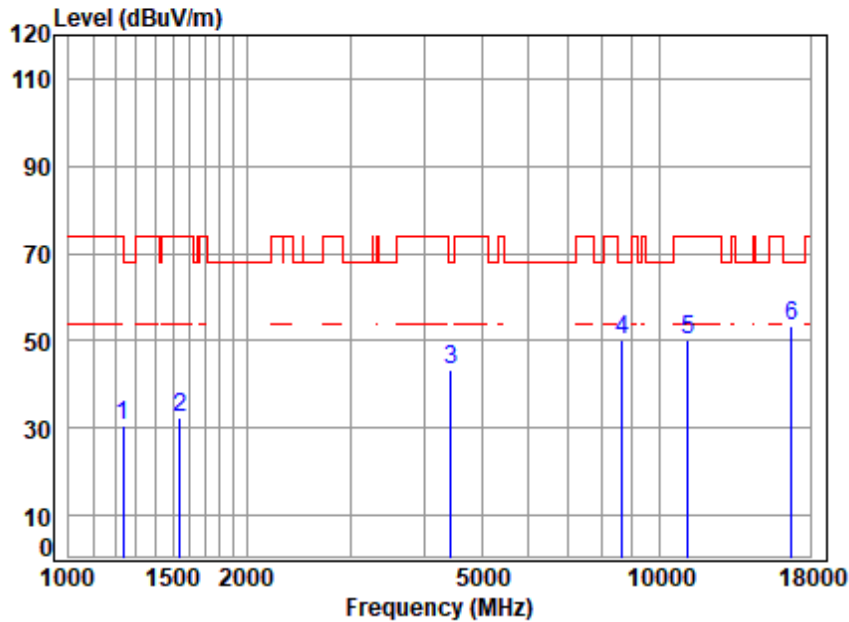

Site : chamber
 Condition: 3m HORIZONTAL
 Job No : 00955AT/00956AT
 Mode : 5580 TX RSE
 Note : 5G WIFI 11AC20

	Freq	Cable Loss	Ant Factor	Preamp Factor	Read Level	Level	Limit Line	Over Limit	Remark
	MHz	dB	dB/m	dB	dBuV	dBuV/m	dBuV/m	dB	
1	1234.909	3.64	24.89	38.35	40.30	30.48	74.00	-43.52	peak
2	1542.733	4.12	26.97	38.39	39.64	32.34	74.00	-41.66	peak
3	4430.628	7.08	34.43	35.77	37.65	43.39	68.20	-24.81	peak
4	8663.404	11.33	36.90	37.27	39.18	50.14	68.20	-18.06	peak
5	11160.000	12.93	37.62	37.79	37.34	50.10	74.00	-23.90	peak
6	p16740.000	14.51	42.78	37.49	33.45	53.25	68.20	-14.95	peak



Unless otherwise agreed in writing, this document is issued by the Company subject to its General Conditions of Service printed overleaf, available on request or accessible at <https://www.sgs.com/en/Terms-and-Conditions>. Attention is drawn to the limitation of liability, indemnification and jurisdiction issues defined therein. Any holder of this document is advised that information contained hereon reflects the Company's findings at the time of its intervention only and within the limits of Client's instructions, if any. The Company's sole responsibility is to its Client and this document does not exonerate parties to a transaction from exercising all their rights and obligations under the transaction documents. This document cannot be reproduced except in full, without prior written approval of the Company. Any unauthorized alteration, forgery or falsification of the content or appearance of this document is unlawful and offenders may be prosecuted to the fullest extent of the law. Unless otherwise stated the results shown in this test report refer only to the sample(s) tested and such sample(s) are retained for 30 days only.

Attention: To check the authenticity of testing /inspection report & certificate, please contact us at telephone: (86-755) 8307 1443, or email: CN.Doccheck@sgs.com
 No.1 Workshop, M-10, Middle Section, Science & Technology Park, Nanshan District, Shenzhen, Guangdong, China 518057 t (86-755) 26012053 f (86-755) 26710594 www.sgs.com.cn
 中国·广东·深圳市南山区科技园中区M-10栋1号厂房 邮编: 518057 t (86-755) 26012053 f (86-755) 26710594 sgs.china@sgs.com

Test Mode: 23; Polarity: Vertical; Modulation:802.11ac; Bandwidth:20MHz; Channel:middle

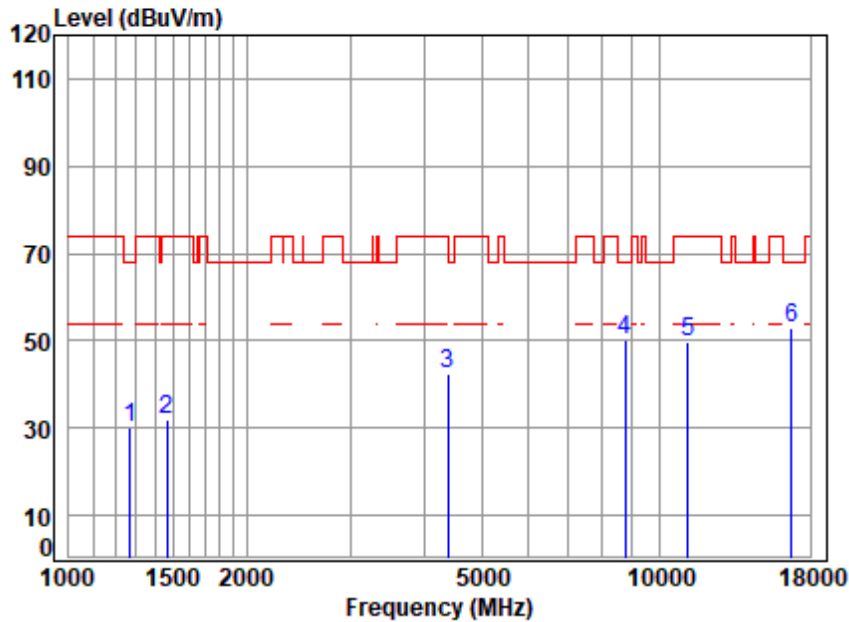

Site : chamber
 Condition: 3m VERTICAL
 Job No : 00955AT/00956AT
 Mode : 5580 TX RSE
 Note : 5G WIFI 11AC20

	Freq	Cable Loss	Ant Factor	Preamp Factor	Read Level	Level	Limit Line	Over Limit	Remark
	MHz	dB	dB/m	dB	dBuV	dBuV/m	dBuV/m	dB	
1	1271.123	3.71	24.97	38.35	39.83	30.16	68.20	-38.04	peak
2	1468.761	4.02	25.93	38.38	40.20	31.77	74.00	-42.23	peak
3	4379.699	7.04	34.64	35.81	36.72	42.59	74.00	-31.41	peak
4	8738.852	11.47	36.90	37.35	38.98	50.00	68.20	-18.20	peak
5	11160.000	12.93	37.62	37.79	36.96	49.72	74.00	-24.28	peak
6	p16740.000	14.51	42.78	37.49	33.34	53.14	68.20	-15.06	peak



Unless otherwise agreed in writing, this document is issued by the Company subject to its General Conditions of Service printed overleaf, available on request or accessible at <https://www.sgs.com/en/Terms-and-Conditions>. Attention is drawn to the limitation of liability, indemnification and jurisdiction issues defined therein. Any holder of this document is advised that information contained hereon reflects the Company's findings at the time of its intervention only and within the limits of Client's instructions, if any. The Company's sole responsibility is to its Client and this document does not exonerate parties to a transaction from exercising all their rights and obligations under the transaction documents. This document cannot be reproduced except in full, without prior written approval of the Company. Any unauthorized alteration, forgery or falsification of the content or appearance of this document is unlawful and offenders may be prosecuted to the fullest extent of the law. Unless otherwise stated the results shown in this test report refer only to the sample(s) tested and such sample(s) are retained for 30 days only.

Attention: To check the authenticity of testing /inspection report & certificate, please contact us at telephone: (86-755) 8307 1443, or email: CN.Doccheck@sgs.com
 No.1 Workshop, M-10, Middle Section, Science & Technology Park, Nanshan District, Shenzhen, Guangdong, China 518057 t (86-755) 26012053 f (86-755) 26710594 www.sgs.com.cn
 中国·广东·深圳市南山区科技园中区M-10栋1号厂房 邮编: 518057 t (86-755) 26012053 f (86-755) 26710594 sgs.china@sgs.com

Test Mode: 23; Polarity: Horizontal; Modulation:802.11ac; Bandwidth:20MHz; Channel:High

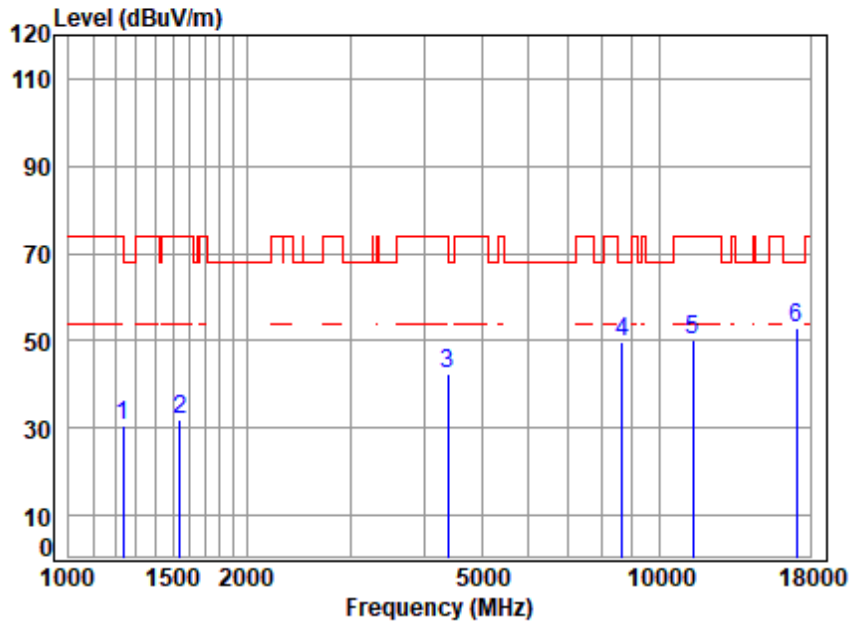

Site : chamber
 Condition: 3m HORIZONTAL
 Job No : 00955AT/00956AT
 Mode : 5700 TX RSE
 Note : 5G WIFI 11AC20

	Freq	Cable Loss	Ant Factor	Preamp Factor	Read Level	Level	Limit Line	Over Limit	Remark
	MHz	dB	dB/m	dB	dBuV	dBuV/m	dBuV/m	dB	
1	1238.483	3.65	24.94	38.35	40.12	30.36	74.00	-43.64	peak
2	1542.733	4.12	26.97	38.39	39.42	32.12	74.00	-41.88	peak
3	4379.699	7.04	34.64	35.81	36.66	42.53	74.00	-31.47	peak
4	8663.404	11.33	36.90	37.27	38.89	49.85	68.20	-18.35	peak
5	11400.000	12.98	37.70	37.72	37.32	50.28	74.00	-23.72	peak
6	p17100.000	14.62	43.10	37.53	32.72	52.91	68.20	-15.29	peak



Unless otherwise agreed in writing, this document is issued by the Company subject to its General Conditions of Service printed overleaf, available on request or accessible at <https://www.sgs.com/en/Terms-and-Conditions>. Attention is drawn to the limitation of liability, indemnification and jurisdiction issues defined therein. Any holder of this document is advised that information contained hereon reflects the Company's findings at the time of its intervention only and within the limits of Client's instructions, if any. The Company's sole responsibility is to its Client and this document does not exonerate parties to a transaction from exercising all their rights and obligations under the transaction documents. This document cannot be reproduced except in full, without prior written approval of the Company. Any unauthorized alteration, forgery or falsification of the content or appearance of this document is unlawful and offenders may be prosecuted to the fullest extent of the law. Unless otherwise stated the results shown in this test report refer only to the sample(s) tested and such sample(s) are retained for 30 days only.

Test Mode: 23; Polarity: Vertical; Modulation:802.11ac; Bandwidth:20MHz; Channel:High

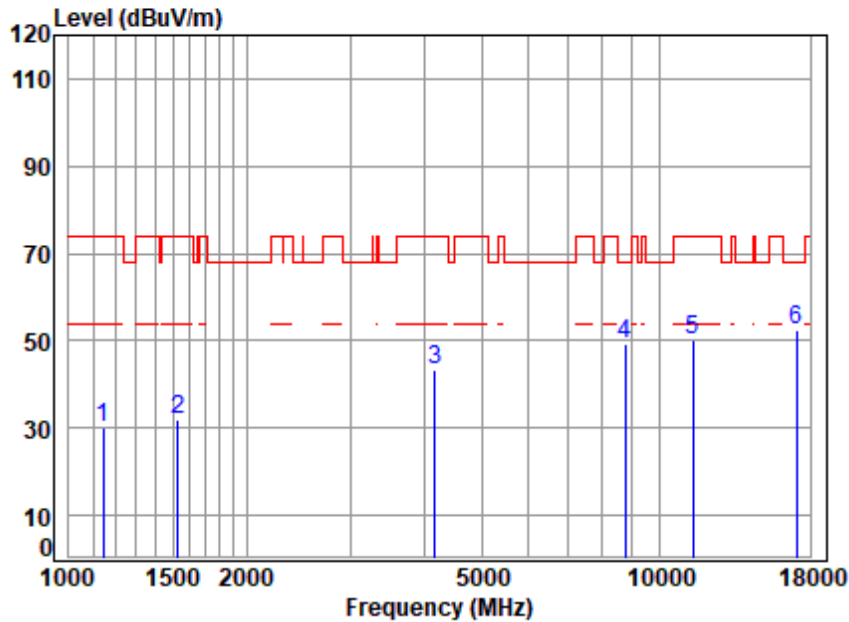

Site : chamber
 Condition: 3m VERTICAL
 Job No : 00955AT/00956AT
 Mode : 5700 TX RSE
 Note : 5G WIFI 11AC20

	Freq	Cable Loss	Ant Factor	Preamp Factor	Read Level	Level	Limit Line	Over Limit	Remark
	MHz	dB	dB/m	dB	dBuV	dBuV/m	dBuV/m	dB	
1	1145.507	3.48	23.88	38.33	41.19	30.22	74.00	-43.78	peak
2	1529.414	4.10	26.92	38.39	39.53	32.16	74.00	-41.84	peak
3	4169.698	6.90	33.80	35.97	38.49	43.22	74.00	-30.78	peak
4	8764.146	11.51	36.96	37.37	38.27	49.37	68.20	-18.83	peak
5	11400.000	12.98	37.70	37.72	37.27	50.23	74.00	-23.77	peak
6	p17100.000	14.62	43.10	37.53	32.34	52.53	68.20	-15.67	peak



Unless otherwise agreed in writing, this document is issued by the Company subject to its General Conditions of Service printed overleaf, available on request or accessible at <https://www.sgs.com/en/Terms-and-Conditions>. Attention is drawn to the limitation of liability, indemnification and jurisdiction issues defined therein. Any holder of this document is advised that information contained hereon reflects the Company's findings at the time of its intervention only and within the limits of Client's instructions, if any. The Company's sole responsibility is to its Client and this document does not exonerate parties to a transaction from exercising all their rights and obligations under the transaction documents. This document cannot be reproduced except in full, without prior written approval of the Company. Any unauthorized alteration, forgery or falsification of the content or appearance of this document is unlawful and offenders may be prosecuted to the fullest extent of the law. Unless otherwise stated the results shown in this test report refer only to the sample(s) tested and such sample(s) are retained for 30 days only.

Test Mode: 23; Polarity: Horizontal; Modulation:802.11ac; Bandwidth:40MHz; Channel:Low

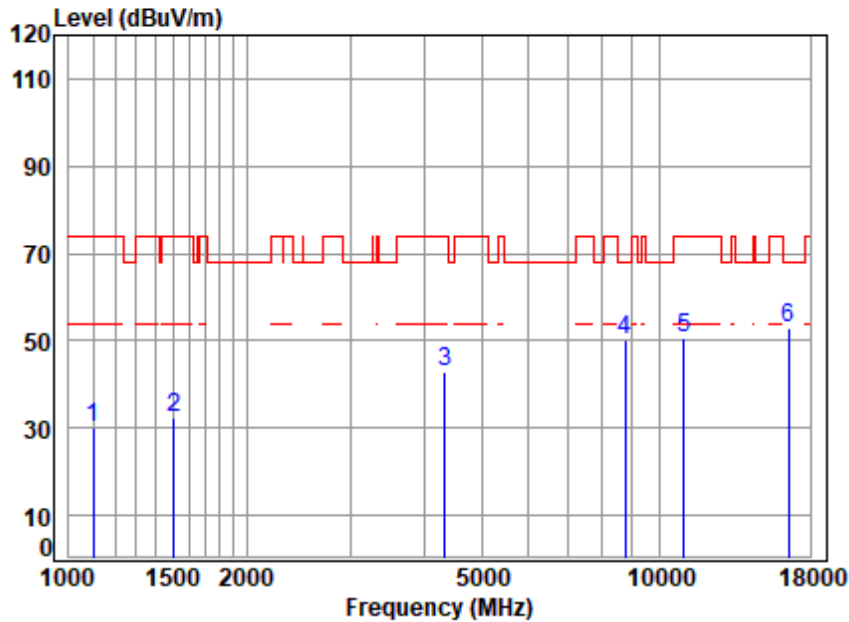

Site : chamber
 Condition: 3m HORIZONTAL
 Job No : 00955AT/00956AT
 Mode : 5510 TX RSE
 Note : 5G WIFI 11AC40

	Cable	Ant	Preamp	Read	Limit	Over		
Freq	Loss	Factor	Factor	Level	Level	Line	Limit	Remark
MHz	dB	dB/m	dB	dBuV	dBuV/m	dBuV/m	dB	
1	1100.079	3.40	23.70	38.32	41.53	30.31	74.00	-43.69 peak
2	1507.470	4.07	26.83	38.39	39.69	32.20	74.00	-41.80 peak
3	4329.354	7.01	34.23	35.85	37.42	42.81	74.00	-31.19 peak
4	8764.146	11.51	36.96	37.37	39.12	50.22	68.20	-17.98 peak
5	11020.000	12.90	37.50	37.83	38.26	50.83	74.00	-23.17 peak
6	p16530.000	14.48	42.16	37.47	33.79	52.96	68.20	-15.24 peak



Unless otherwise agreed in writing, this document is issued by the Company subject to its General Conditions of Service printed overleaf, available on request or accessible at <https://www.sgs.com/en/Terms-and-Conditions>. Attention is drawn to the limitation of liability, indemnification and jurisdiction issues defined therein. Any holder of this document is advised that information contained hereon reflects the Company's findings at the time of its intervention only and within the limits of Client's instructions, if any. The Company's sole responsibility is to its Client and this document does not exonerate parties to a transaction from exercising all their rights and obligations under the transaction documents. This document cannot be reproduced except in full, without prior written approval of the Company. Any unauthorized alteration, forgery or falsification of the content or appearance of this document is unlawful and offenders may be prosecuted to the fullest extent of the law. Unless otherwise stated the results shown in this test report refer only to the sample(s) tested and such sample(s) are retained for 30 days only.

Attention: To check the authenticity of testing /inspection report & certificate, please contact us at telephone: (86-755) 8307 1443, or email: CN.Doccheck@sgs.com
 No.1 Workshop, M-10, Middle Section, Science & Technology Park, Nanshan District, Shenzhen, Guangdong, China 518057 t (86-755) 26012053 f (86-755) 26710594 www.sgs.com.cn
 中国·广东·深圳市南山区科技园中区M-10栋1号厂房 邮编: 518057 t (86-755) 26012053 f (86-755) 26710594 sgs.china@sgs.com

Test Mode: 23; Polarity: Vertical; Modulation:802.11ac; Bandwidth:40MHz; Channel:Low

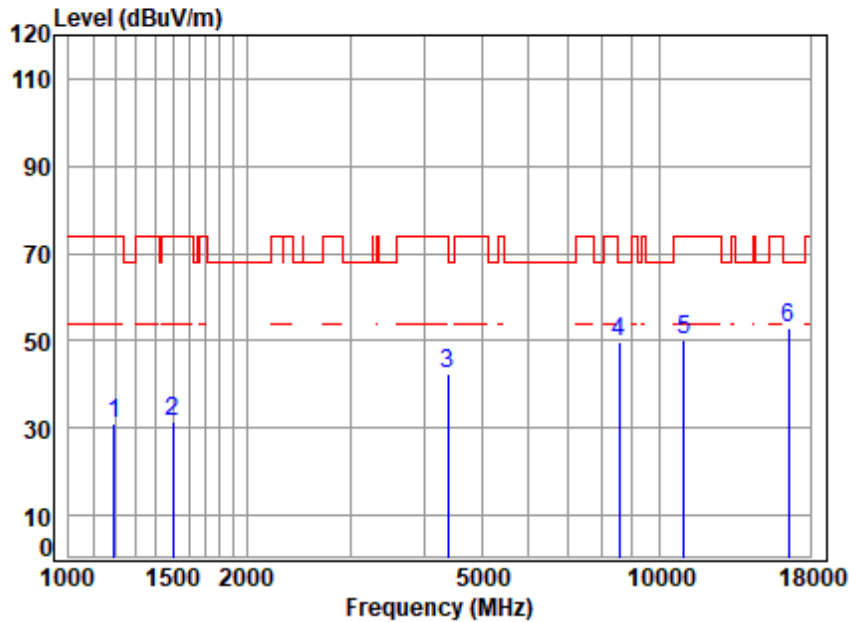

Site : chamber
 Condition: 3m VERTICAL
 Job No : 00955AT/00956AT
 Mode : 5510 TX RSE
 Note : 5G WIFI 11AC40

	Cable	Ant	Preamp	Read	Limit	Over		
Freq	Loss	Factor	Factor	Level	Level	Line	Limit	Remark
MHz	dB	dB/m	dB	dBuV	dBuV/m	dBuV/m	dB	
1	1192.811	3.57	24.33	38.34	41.26	30.82	74.00	-43.18 peak
2	1498.781	4.06	26.77	38.39	39.13	31.57	74.00	-42.43 peak
3	4392.376	7.05	34.74	35.80	36.60	42.59	74.00	-31.41 peak
4	8563.818	11.15	36.83	37.17	38.96	49.77	68.20	-18.43 peak
5	11020.000	12.90	37.50	37.83	37.78	50.35	74.00	-23.65 peak
6	p16530.000	14.48	42.16	37.47	33.61	52.78	68.20	-15.42 peak



Unless otherwise agreed in writing, this document is issued by the Company subject to its General Conditions of Service printed overleaf, available on request or accessible at <https://www.sgs.com/en/Terms-and-Conditions>. Attention is drawn to the limitation of liability, indemnification and jurisdiction issues defined therein. Any holder of this document is advised that information contained hereon reflects the Company's findings at the time of its intervention only and within the limits of Client's instructions, if any. The Company's sole responsibility is to its Client and this document does not exonerate parties to a transaction from exercising all their rights and obligations under the transaction documents. This document cannot be reproduced except in full, without prior written approval of the Company. Any unauthorized alteration, forgery or falsification of the content or appearance of this document is unlawful and offenders may be prosecuted to the fullest extent of the law. Unless otherwise stated the results shown in this test report refer only to the sample(s) tested and such sample(s) are retained for 30 days only.

Attention: To check the authenticity of testing /inspection report & certificate, please contact us at telephone: (86-755) 8307 1443, or email: CN.Doccheck@sgs.com
 No.1 Workshop, M-10, Middle Section, Science & Technology Park, Nanshan District, Shenzhen, Guangdong, China 518057 t (86-755) 26012053 f (86-755) 26710594 www.sgs.com.cn
 中国·广东·深圳市南山区科技园中区M-10栋1号厂房 邮编: 518057 t (86-755) 26012053 f (86-755) 26710594 sgs.china@sgs.com

Test Mode: 23; Polarity: Horizontal; Modulation:802.11ac; Bandwidth:40MHz; Channel:High

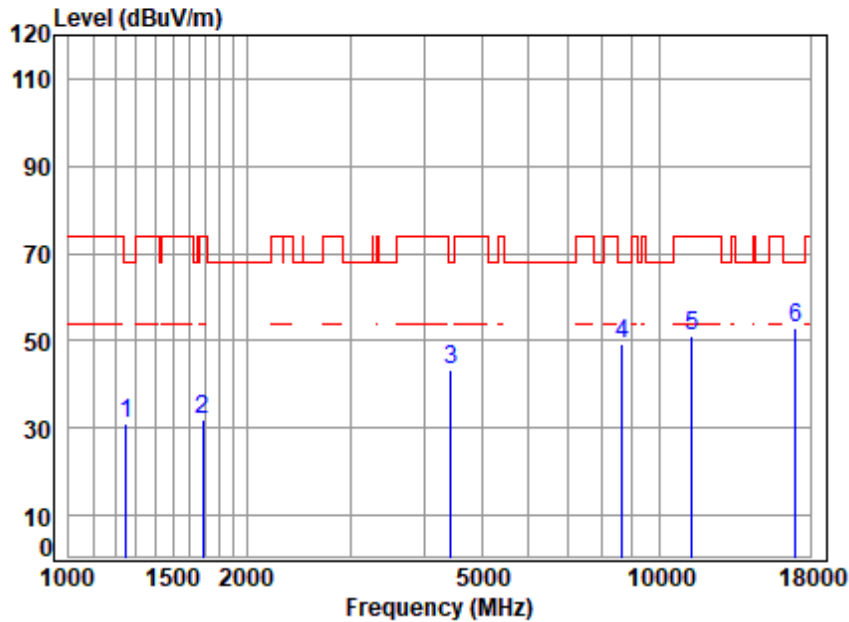

Site : chamber
 Condition: 3m HORIZONTAL
 Job No : 00955AT/00956AT
 Mode : 5670 TX RSE
 Note : 5G WIFI 11AC40

	Freq	Cable Loss	Ant Factor	Preamp Factor	Read Level	Level	Limit Line	Over Limit	Remark
	MHz	dB	dB/m	dB	dBuV	dBuV/m	dBuV/m	dB	
1	1249.269	3.67	25.09	38.35	40.63	31.04	68.20	-37.16	peak
2	1687.347	4.31	26.23	38.41	39.64	31.77	74.00	-42.23	peak
3	4430.628	7.08	34.43	35.77	37.49	43.23	68.20	-24.97	peak
4	8638.399	11.29	36.90	37.24	38.50	49.45	68.20	-18.75	peak
5	11340.000	12.97	37.76	37.74	38.09	51.08	74.00	-22.92	peak
6	p17010.000	14.57	43.10	37.51	32.65	52.81	68.20	-15.39	peak



Unless otherwise agreed in writing, this document is issued by the Company subject to its General Conditions of Service printed overleaf, available on request or accessible at <https://www.sgs.com/en/Terms-and-Conditions>. Attention is drawn to the limitation of liability, indemnification and jurisdiction issues defined therein. Any holder of this document is advised that information contained hereon reflects the Company's findings at the time of its intervention only and within the limits of Client's instructions, if any. The Company's sole responsibility is to its Client and this document does not exonerate parties to a transaction from exercising all their rights and obligations under the transaction documents. This document cannot be reproduced except in full, without prior written approval of the Company. Any unauthorized alteration, forgery or falsification of the content or appearance of this document is unlawful and offenders may be prosecuted to the fullest extent of the law. Unless otherwise stated the results shown in this test report refer only to the sample(s) tested and such sample(s) are retained for 30 days only.

Test Mode: 23; Polarity: Vertical; Modulation:802.11ac; Bandwidth:40MHz; Channel:High

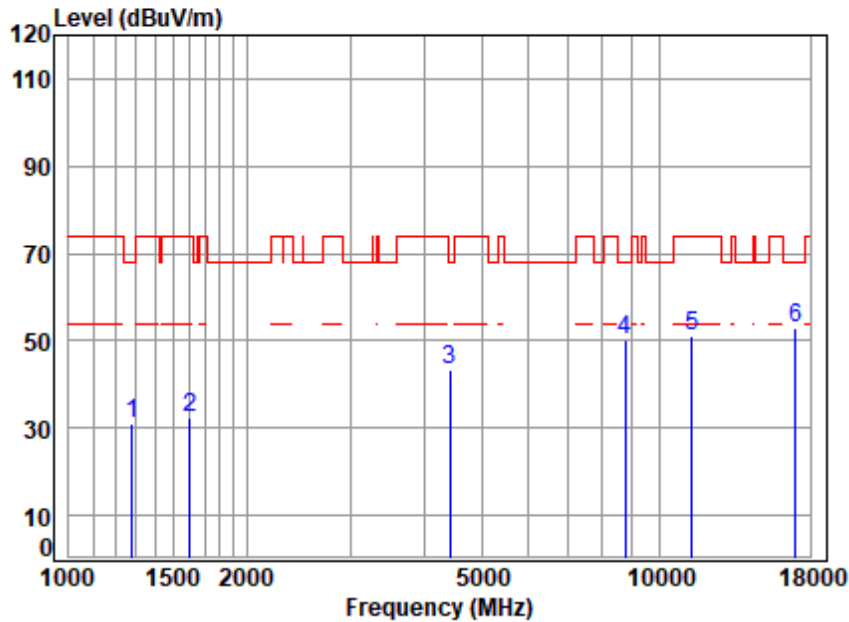

Site : chamber
 Condition: 3m VERTICAL
 Job No : 00955AT/00956AT
 Mode : 5670 TX RSE
 Note : 5G WIFI 11AC40

	Cable	Ant	Preamp	Read	Limit	Over		
Freq	Loss	Factor	Factor	Level	Level	Line	Limit	Remark
MHz	dB	dB/m	dB	dBuV	dBuV/m	dBuV/m	dB	
1	1282.193	3.72	24.91	38.35	40.67	30.95	68.20	-37.25 peak
2	1606.441	4.21	26.74	38.40	39.87	32.42	74.00	-41.58 peak
3	4417.841	7.07	34.59	35.78	37.42	43.30	68.20	-24.90 peak
4	8738.852	11.47	36.90	37.35	39.06	50.08	68.20	-18.12 peak
5	11340.000	12.97	37.76	37.74	37.89	50.88	74.00	-23.12 peak
6	p17010.000	14.57	43.10	37.51	32.67	52.83	68.20	-15.37 peak



Unless otherwise agreed in writing, this document is issued by the Company subject to its General Conditions of Service printed overleaf, available on request or accessible at <https://www.sgs.com/en/Terms-and-Conditions>. Attention is drawn to the limitation of liability, indemnification and jurisdiction issues defined therein. Any holder of this document is advised that information contained hereon reflects the Company's findings at the time of its intervention only and within the limits of Client's instructions, if any. The Company's sole responsibility is to its Client and this document does not exonerate parties to a transaction from exercising all their rights and obligations under the transaction documents. This document cannot be reproduced except in full, without prior written approval of the Company. Any unauthorized alteration, forgery or falsification of the content or appearance of this document is unlawful and offenders may be prosecuted to the fullest extent of the law. Unless otherwise stated the results shown in this test report refer only to the sample(s) tested and such sample(s) are retained for 30 days only.

Attention: To check the authenticity of testing /inspection report & certificate, please contact us at telephone: (86-755) 8307 1443, or email: CN.Doccheck@sgs.com
 No.1 Workshop, M-10, Middle Section, Science & Technology Park, Nanshan District, Shenzhen, Guangdong, China 518057 t (86-755) 26012053 f (86-755) 26710594 www.sgs.com.cn
 中国·广东·深圳市南山区科技园中区M-10栋1号厂房 邮编: 518057 t (86-755) 26012053 f (86-755) 26710594 sgs.china@sgs.com

Test Mode: 23; Polarity: Horizontal; Modulation:802.11ac; Bandwidth:80MHz; Channel:Low

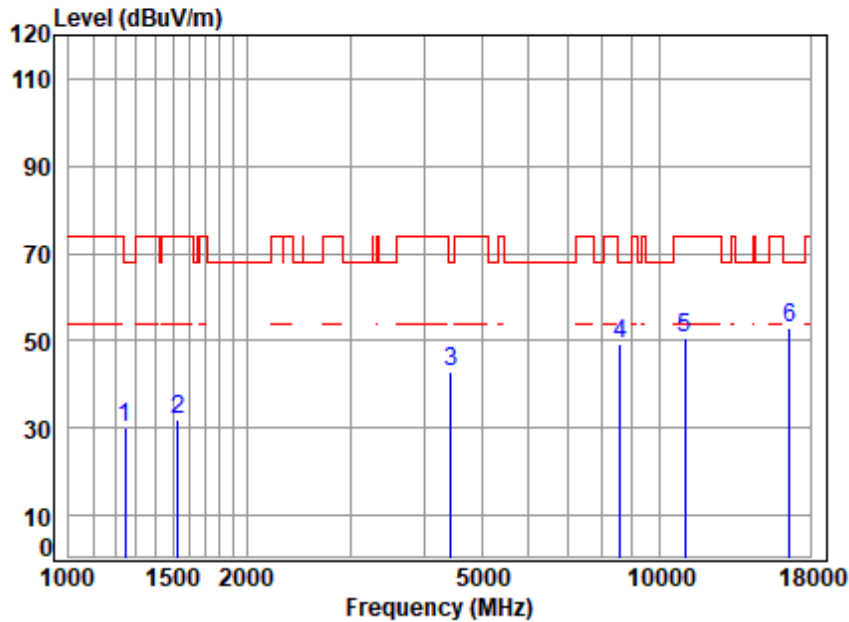

Site : chamber
 Condition: 3m HORIZONTAL
 Job No : 00955AT/00956AT
 Mode : 5530 TX RSE
 Note : 5G WIFI 11AC80

	Freq	Cable Loss	Ant Factor	Preamp Factor	Read Level	Level	Limit Line	Over Limit	Remark
	MHz	dB	dB/m	dB	dBuV	dBuV/m	dBuV/m	dB	
1	1245.663	3.66	25.04	38.35	39.70	30.05	68.20	-38.15	peak
2	1529.414	4.10	26.92	38.39	39.44	32.07	74.00	-41.93	peak
3	4443.453	7.09	34.28	35.77	37.40	43.00	68.20	-25.20	peak
4	8588.607	11.20	36.88	37.19	38.53	49.42	68.20	-18.78	peak
5	11060.000	12.91	37.50	37.82	38.03	50.62	74.00	-23.38	peak
6	p16590.000	14.49	42.28	37.47	33.78	53.08	68.20	-15.12	peak



Unless otherwise agreed in writing, this document is issued by the Company subject to its General Conditions of Service printed overleaf, available on request or accessible at <https://www.sgs.com/en/Terms-and-Conditions>. Attention is drawn to the limitation of liability, indemnification and jurisdiction issues defined therein. Any holder of this document is advised that information contained hereon reflects the Company's findings at the time of its intervention only and within the limits of Client's instructions, if any. The Company's sole responsibility is to its Client and this document does not exonerate parties to a transaction from exercising all their rights and obligations under the transaction documents. This document cannot be reproduced except in full, without prior written approval of the Company. Any unauthorized alteration, forgery or falsification of the content or appearance of this document is unlawful and offenders may be prosecuted to the fullest extent of the law. Unless otherwise stated the results shown in this test report refer only to the sample(s) tested and such sample(s) are retained for 30 days only.

Test Mode: 23; Polarity: Vertical; Modulation:802.11ac; Bandwidth:80MHz; Channel:Low

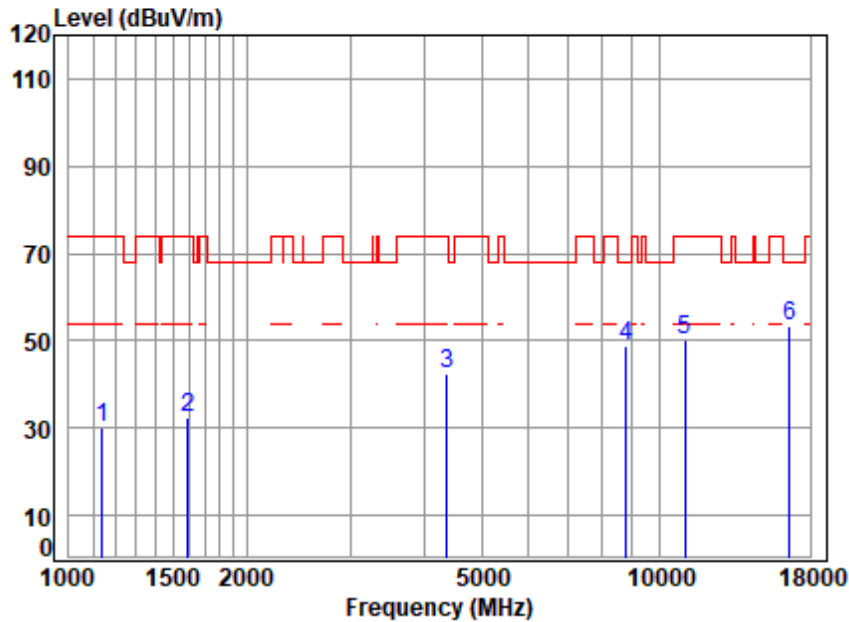

Site : chamber
 Condition: 3m VERTICAL
 Job No : 00955AT/00956AT
 Mode : 5530 TX RSE
 Note : 5G WIFI 11AC80

	Cable	Ant	Preamp	Read	Limit	Over		
Freq	Loss	Factor	Factor	Level	Level	Line	Limit	Remark
MHz	dB	dB/m	dB	dBuV	dBuV/m	dBuV/m	dB	
1	1138.904	3.47	23.86	38.33	41.20	30.20	74.00	-43.80 peak
2	1592.571	4.19	26.83	38.40	39.97	32.59	74.00	-41.41 peak
3	4367.058	7.04	34.54	35.82	36.74	42.50	74.00	-31.50 peak
4	8789.516	11.55	37.06	37.40	37.51	48.72	68.20	-19.48 peak
5	11060.000	12.91	37.50	37.82	37.59	50.18	74.00	-23.82 peak
6	p16590.000	14.49	42.28	37.47	33.86	53.16	68.20	-15.04 peak



Unless otherwise agreed in writing, this document is issued by the Company subject to its General Conditions of Service printed overleaf, available on request or accessible at <https://www.sgs.com/en/Terms-and-Conditions>. Attention is drawn to the limitation of liability, indemnification and jurisdiction issues defined therein. Any holder of this document is advised that information contained hereon reflects the Company's findings at the time of its intervention only and within the limits of Client's instructions, if any. The Company's sole responsibility is to its Client and this document does not exonerate parties to a transaction from exercising all their rights and obligations under the transaction documents. This document cannot be reproduced except in full, without prior written approval of the Company. Any unauthorized alteration, forgery or falsification of the content or appearance of this document is unlawful and offenders may be prosecuted to the fullest extent of the law. Unless otherwise stated the results shown in this test report refer only to the sample(s) tested and such sample(s) are retained for 30 days only.

Test Mode: 23; Polarity: Horizontal; Modulation:802.11ac; Bandwidth:80MHz; Channel:High

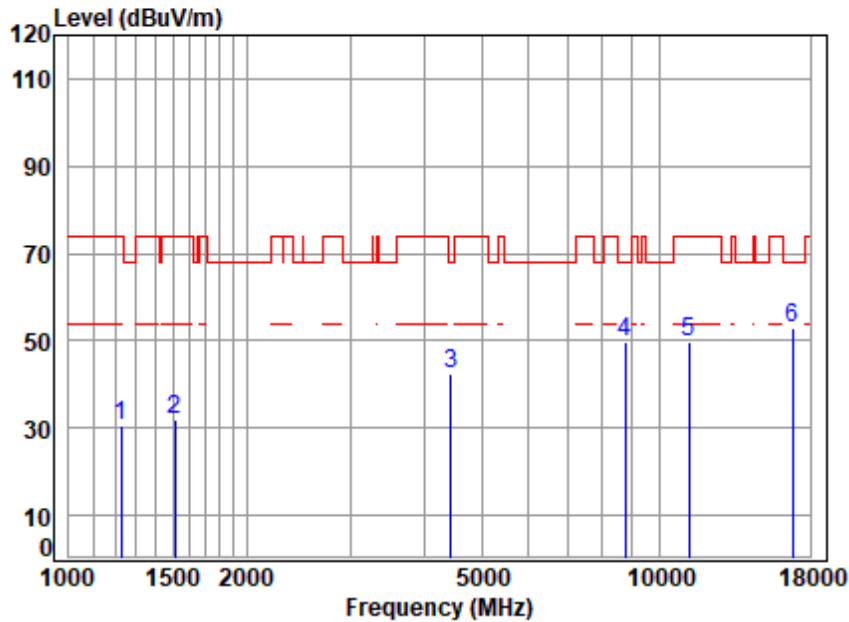

Site : chamber
 Condition: 3m HORIZONTAL
 Job No : 00955AT/00956AT
 Mode : 5610 TX RSE
 Note : 5G WIFI 11AC80

	Freq	Cable Loss	Ant Factor	Preamp Factor	Read Level	Level	Limit Line	Over Limit	Remark
	MHz	dB	dB/m	dB	dBuV	dBuV/m	dBuV/m	dB	
1	1227.791	3.63	24.79	38.34	40.47	30.55	74.00	-43.45	peak
2	1511.833	4.08	26.85	38.39	39.60	32.14	74.00	-41.86	peak
3	4430.628	7.08	34.43	35.77	36.87	42.61	68.20	-25.59	peak
4	8738.852	11.47	36.90	37.35	38.51	49.53	68.20	-18.67	peak
5	11220.000	12.94	37.72	37.77	37.07	49.96	74.00	-24.04	peak
6	p16830.000	14.53	42.99	37.50	32.76	52.78	68.20	-15.42	peak



Unless otherwise agreed in writing, this document is issued by the Company subject to its General Conditions of Service printed overleaf, available on request or accessible at <https://www.sgs.com/en/Terms-and-Conditions>. Attention is drawn to the limitation of liability, indemnification and jurisdiction issues defined therein. Any holder of this document is advised that information contained hereon reflects the Company's findings at the time of its intervention only and within the limits of Client's instructions, if any. The Company's sole responsibility is to its Client and this document does not exonerate parties to a transaction from exercising all their rights and obligations under the transaction documents. This document cannot be reproduced except in full, without prior written approval of the Company. Any unauthorized alteration, forgery or falsification of the content or appearance of this document is unlawful and offenders may be prosecuted to the fullest extent of the law. Unless otherwise stated the results shown in this test report refer only to the sample(s) tested and such sample(s) are retained for 30 days only.

Attention: To check the authenticity of testing /inspection report & certificate, please contact us at telephone: (86-755) 8307 1443, or email: CN.Doccheck@sgs.com
 No.1 Workshop, M-10, Middle Section, Science & Technology Park, Nanshan District, Shenzhen, Guangdong, China 518057 t (86-755) 26012053 f (86-755) 26710594 www.sgs.com.cn
 中国·广东·深圳市南山区科技园中区M-10栋1号厂房 邮编: 518057 t (86-755) 26012053 f (86-755) 26710594 sgs.china@sgs.com

Test Mode: 23; Polarity: Vertical; Modulation:802.11ac; Bandwidth:80MHz; Channel:High

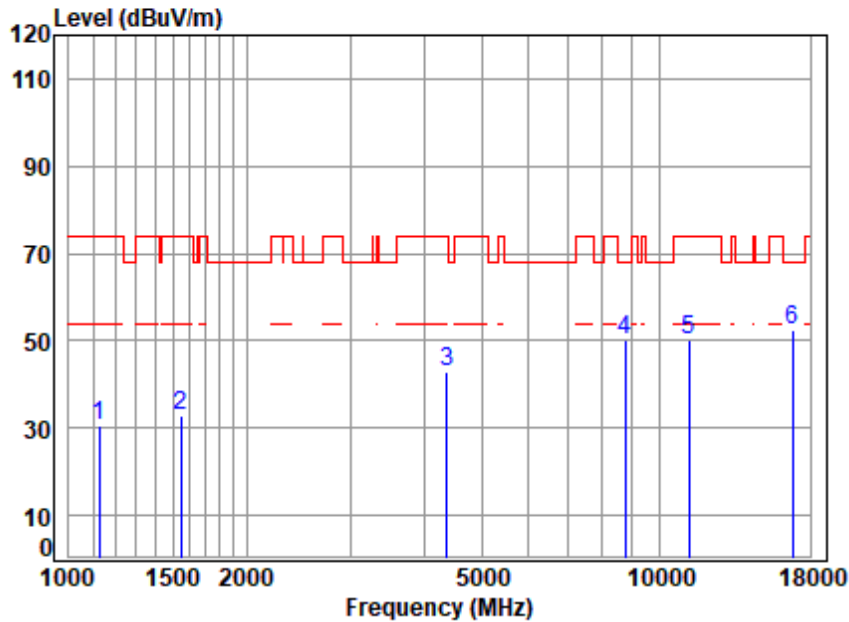

Site : chamber
 Condition: 3m VERTICAL
 Job No : 00955AT/00956AT
 Mode : 5610 TX RSE
 Note : 5G WIFI 11AC80

	Cable	Ant	Preamp	Read	Limit	Over		
Freq	Loss	Factor	Factor	Level	Level	Line	Limit	Remark
MHz	dB	dB/m	dB	dBuV	dBuV/m	dBuV/m	dB	
1	1125.813	3.44	23.80	38.33	41.62	30.53	74.00	-43.47 peak
2	1547.199	4.13	26.99	38.39	39.92	32.65	74.00	-41.35 peak
3	4367.058	7.04	34.54	35.82	37.31	43.07	74.00	-30.93 peak
4	8764.146	11.51	36.96	37.37	38.99	50.09	68.20	-18.11 peak
5	11220.000	12.94	37.72	37.77	37.25	50.14	74.00	-23.86 peak
6	p16830.000	14.53	42.99	37.50	32.64	52.66	68.20	-15.54 peak



Unless otherwise agreed in writing, this document is issued by the Company subject to its General Conditions of Service printed overleaf, available on request or accessible at <https://www.sgs.com/en/Terms-and-Conditions>. Attention is drawn to the limitation of liability, indemnification and jurisdiction issues defined therein. Any holder of this document is advised that information contained hereon reflects the Company's findings at the time of its intervention only and within the limits of Client's instructions, if any. The Company's sole responsibility is to its Client and this document does not exonerate parties to a transaction from exercising all their rights and obligations under the transaction documents. This document cannot be reproduced except in full, without prior written approval of the Company. Any unauthorized alteration, forgery or falsification of the content or appearance of this document is unlawful and offenders may be prosecuted to the fullest extent of the law. Unless otherwise stated the results shown in this test report refer only to the sample(s) tested and such sample(s) are retained for 30 days only.

Attention: To check the authenticity of testing /inspection report & certificate, please contact us at telephone: (86-755) 8307 1443, or email: CN.Doccheck@sgs.com
 No.1 Workshop, M-10, Middle Section, Science & Technology Park, Nanshan District, Shenzhen, Guangdong, China 518057 t (86-755) 26012053 f (86-755) 26710594 www.sgs.com.cn
 中国·广东·深圳市南山区科技园中区M-10栋1号厂房 邮编: 518057 t (86-755) 26012053 f (86-755) 26710594 sgs.china@sgs.com

Test Mode: 23; Polarity: Horizontal; Modulation:802.11ac; Bandwidth:160MHz; Channel:middle

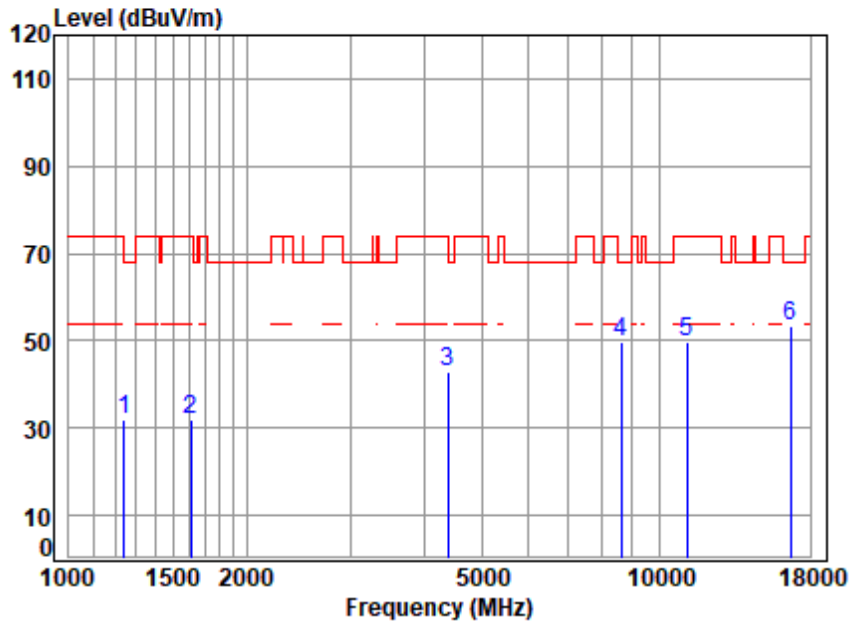

Site : chamber
 Condition: 3m HORIZONTAL
 Job No : 00955AT/00956AT
 Mode : 5570 TX RSE
 Note : 5G WIFI 11AC160

	Cable	Ant	Preamp	Read	Limit	Over		
Freq	Loss	Factor	Factor	Level	Level	Line	Limit	Remark
MHz	dB	dB/m	dB	dBuV	dBuV/m	dBuV/m	dB	
1	1242.068	3.66	24.99	38.35	41.74	32.04	68.20	-36.16 peak
2	1611.091	4.22	26.69	38.40	39.30	31.81	74.00	-42.19 peak
3	4379.699	7.04	34.64	35.81	37.05	42.92	74.00	-31.08 peak
4	8613.468	11.24	36.90	37.22	38.98	49.90	68.20	-18.30 peak
5	11140.000	12.93	37.58	37.80	37.15	49.86	74.00	-24.14 peak
6	p16710.000	14.51	42.72	37.48	33.55	53.30	68.20	-14.90 peak



Unless otherwise agreed in writing, this document is issued by the Company subject to its General Conditions of Service printed overleaf, available on request or accessible at <https://www.sgs.com/en/Terms-and-Conditions>. Attention is drawn to the limitation of liability, indemnification and jurisdiction issues defined therein. Any holder of this document is advised that information contained hereon reflects the Company's findings at the time of its intervention only and within the limits of Client's instructions, if any. The Company's sole responsibility is to its Client and this document does not exonerate parties to a transaction from exercising all their rights and obligations under the transaction documents. This document cannot be reproduced except in full, without prior written approval of the Company. Any unauthorized alteration, forgery or falsification of the content or appearance of this document is unlawful and offenders may be prosecuted to the fullest extent of the law. Unless otherwise stated the results shown in this test report refer only to the sample(s) tested and such sample(s) are retained for 30 days only.

Attention: To check the authenticity of testing /inspection report & certificate, please contact us at telephone: (86-755) 8307 1443, or email: CN.Doccheck@sgs.com

SGS-CSTC Standards Technical Services Co., Ltd. Shenzhen Branch
 No.1 Workshop, M-10, Middle Section, Science & Technology Park, Nanshan District, Shenzhen, Guangdong, China 518057 t (86-755) 26012053 f (86-755) 26710594 www.sgs.com.cn
 中国·广东·深圳市南山区科技园中区M-10栋1号厂房 邮编: 518057 t (86-755) 26012053 f (86-755) 26710594 sgs.china@sgs.com

Test Mode: 23; Polarity: Vertical; Modulation:802.11ac; Bandwidth:160MHz; Channel:middle

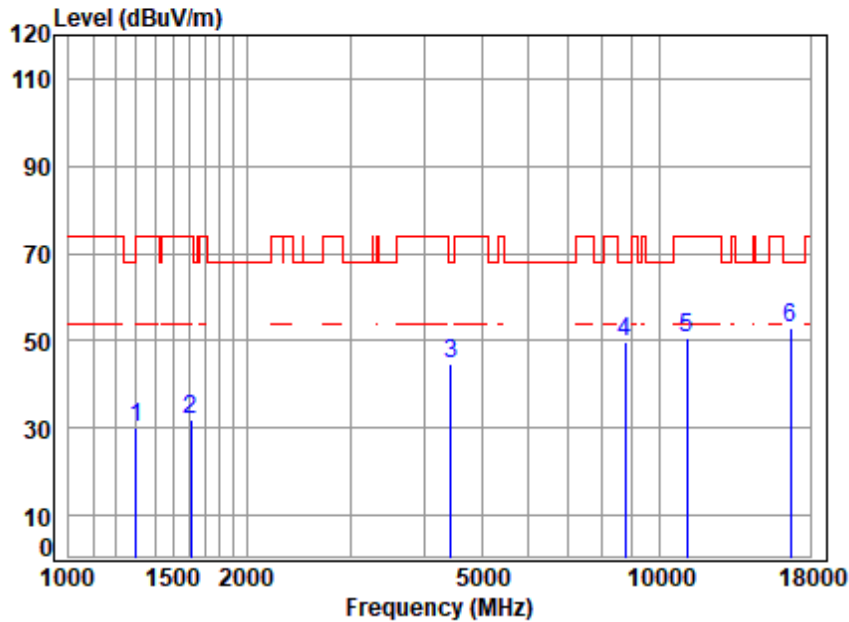

Site : chamber
 Condition: 3m VERTICAL
 Job No : 00955AT/00956AT
 Mode : 5570 TX RSE
 Note : 5G WIFI 11AC160

	Cable	Ant	Preamp	Read	Limit	Over		
Freq	Loss	Factor	Factor	Level	Level	Line	Limit	Remark
MHz	dB	dB/m	dB	dBuV	dBuV/m	dBuV/m	dB	
1	1300.858	3.76	24.79	38.36	39.88	30.07	74.00	-43.93 peak
2	1611.091	4.22	26.69	38.40	39.53	32.04	74.00	-41.96 peak
3	4430.628	7.08	34.43	35.77	38.92	44.66	68.20	-23.54 peak
4	8738.852	11.47	36.90	37.35	38.55	49.57	68.20	-18.63 peak
5	11140.000	12.93	37.58	37.80	37.84	50.55	74.00	-23.45 peak
6	p16710.000	14.51	42.72	37.48	33.25	53.00	68.20	-15.20 peak



Unless otherwise agreed in writing, this document is issued by the Company subject to its General Conditions of Service printed overleaf, available on request or accessible at <https://www.sgs.com/en/Terms-and-Conditions>. Attention is drawn to the limitation of liability, indemnification and jurisdiction issues defined therein. Any holder of this document is advised that information contained hereon reflects the Company's findings at the time of its intervention only and within the limits of Client's instructions, if any. The Company's sole responsibility is to its Client and this document does not exonerate parties to a transaction from exercising all their rights and obligations under the transaction documents. This document cannot be reproduced except in full, without prior written approval of the Company. Any unauthorized alteration, forgery or falsification of the content or appearance of this document is unlawful and offenders may be prosecuted to the fullest extent of the law. Unless otherwise stated the results shown in this test report refer only to the sample(s) tested and such sample(s) are retained for 30 days only.

Attention: To check the authenticity of testing /inspection report & certificate, please contact us at telephone: (86-755) 8307 1443, or email: CN.Doccheck@sgs.com
 No.1 Workshop, M-10, Middle Section, Science & Technology Park, Nanshan District, Shenzhen, Guangdong, China 518057 t (86-755) 26012053 f (86-755) 26710594 www.sgs.com.cn
 中国·广东·深圳市南山区科技园中区M-10栋1号厂房 邮编: 518057 t (86-755) 26012053 f (86-755) 26710594 sgs.china@sgs.com

Test Mode: 24; Polarity: Horizontal; Modulation:802.11a; Bandwidth:20MHz; Channel:Low

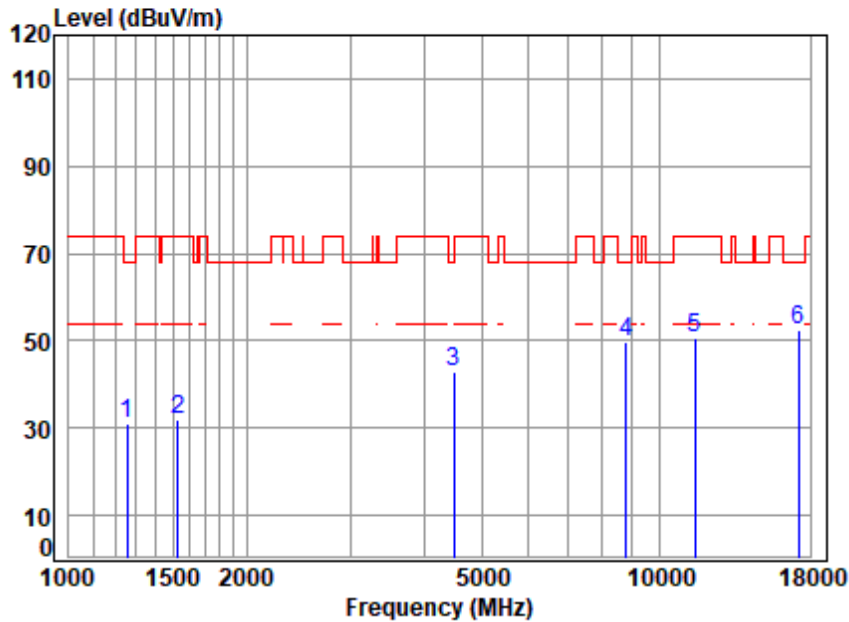

Site : chamber
 Condition: 3m HORIZONTAL
 Job No : 00955AT/00956AT
 Mode : 5745 TX RSE
 Note : 5G WIFI 11A

	Freq	Cable Loss	Ant Factor	Preamp Factor	Read Level	Level	Limit Line	Over Limit	Remark
	MHz	dB	dB/m	dB	dBuV	dBuV/m	dBuV/m	dB	
1	1256.512	3.68	25.06	38.35	40.48	30.87	68.20	-37.33	peak
2	1529.414	4.10	26.92	38.39	39.18	31.81	74.00	-42.19	peak
3	4495.125	7.12	33.66	35.73	37.66	42.71	68.20	-25.49	peak
4	8789.516	11.55	37.06	37.40	38.46	49.67	68.20	-18.53	peak
5	11490.000	13.00	37.79	37.69	37.54	50.64	74.00	-23.36	peak
6	p17235.000	14.70	43.03	37.55	32.50	52.68	68.20	-15.52	peak



Unless otherwise agreed in writing, this document is issued by the Company subject to its General Conditions of Service printed overleaf, available on request or accessible at <https://www.sgs.com/en/Terms-and-Conditions>. Attention is drawn to the limitation of liability, indemnification and jurisdiction issues defined therein. Any holder of this document is advised that information contained hereon reflects the Company's findings at the time of its intervention only and within the limits of Client's instructions, if any. The Company's sole responsibility is to its Client and this document does not exonerate parties to a transaction from exercising all their rights and obligations under the transaction documents. This document cannot be reproduced except in full, without prior written approval of the Company. Any unauthorized alteration, forgery or falsification of the content or appearance of this document is unlawful and offenders may be prosecuted to the fullest extent of the law. Unless otherwise stated the results shown in this test report refer only to the sample(s) tested and such sample(s) are retained for 30 days only.

Test Mode: 24; Polarity: Vertical; Modulation:802.11a; Bandwidth:20MHz; Channel:Low

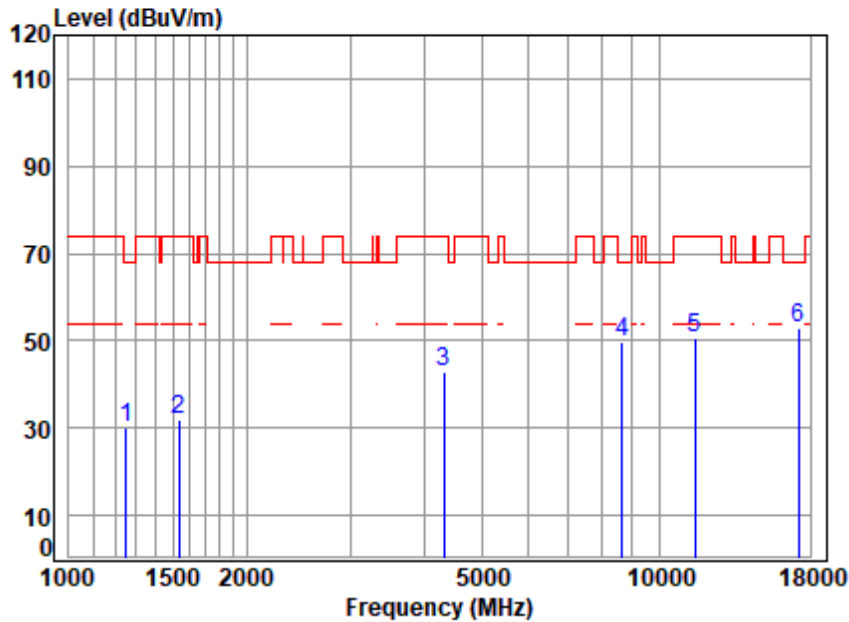

Site : chamber
 Condition: 3m VERTICAL
 Job No : 00955AT/00956AT
 Mode : 5745 TX RSE
 Note : 5G WIFI 11A

	Freq	Cable Loss	Ant Factor	Preamp Factor	Read Level	Level	Limit Line	Over Limit	Remark
	MHz	dB	dB/m	dB	dBuV	dBuV/m	dBuV/m	dB	
1	1249.269	3.67	25.09	38.35	39.69	30.10	68.20	-38.10	peak
2	1538.281	4.12	26.95	38.39	39.37	32.05	74.00	-41.95	peak
3	4316.859	7.00	34.13	35.86	37.46	42.73	74.00	-31.27	peak
4	8663.404	11.33	36.90	37.27	38.80	49.76	68.20	-18.44	peak
5	11490.000	13.00	37.79	37.69	37.59	50.69	74.00	-23.31	peak
6	p17235.000	14.70	43.03	37.55	32.90	53.08	68.20	-15.12	peak



Unless otherwise agreed in writing, this document is issued by the Company subject to its General Conditions of Service printed overleaf, available on request or accessible at <https://www.sgs.com/en/Terms-and-Conditions>. Attention is drawn to the limitation of liability, indemnification and jurisdiction issues defined therein. Any holder of this document is advised that information contained hereon reflects the Company's findings at the time of its intervention only and within the limits of Client's instructions, if any. The Company's sole responsibility is to its Client and this document does not exonerate parties to a transaction from exercising all their rights and obligations under the transaction documents. This document cannot be reproduced except in full, without prior written approval of the Company. Any unauthorized alteration, forgery or falsification of the content or appearance of this document is unlawful and offenders may be prosecuted to the fullest extent of the law. Unless otherwise stated the results shown in this test report refer only to the sample(s) tested and such sample(s) are retained for 30 days only.

Attention: To check the authenticity of testing /inspection report & certificate, please contact us at telephone: (86-755) 8307 1443, or email: CN.Doccheck@sgs.com
 No.1 Workshop, M-10, Middle Section, Science & Technology Park, Nanshan District, Shenzhen, Guangdong, China 518057 t (86-755) 26012053 f (86-755) 26710594 www.sgs.com.cn
 中国·广东·深圳市南山区科技园中区M-10栋1号厂房 邮编: 518057 t (86-755) 26012053 f (86-755) 26710594 sgs.china@sgs.com

Test Mode: 24; Polarity: Horizontal; Modulation:802.11a; Bandwidth:20MHz; Channel:middle

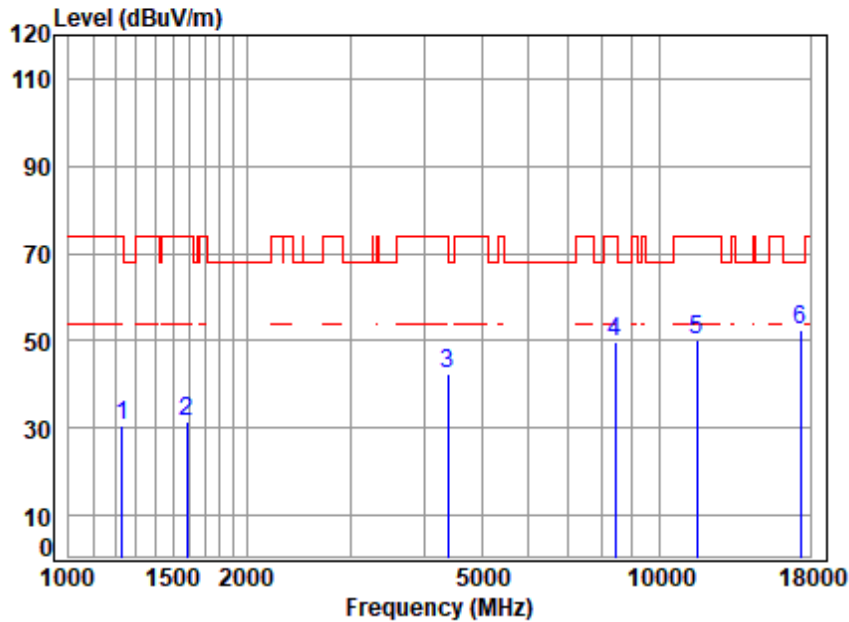

Site : chamber
 Condition: 3m HORIZONTAL
 Job No : 00955AT/00956AT
 Mode : 5785 TX RSE
 Note : 5G WIFI 11A

	Freq	Cable Loss	Ant Factor	Preamp Factor	Read Level	Level	Limit Line	Over Limit	Remark
	MHz	dB	dB/m	dB	dBuV	dBuV/m	dBuV/m	dB	
1	1231.345	3.64	24.84	38.35	40.55	30.68	74.00	-43.32	peak
2	1583.392	4.18	26.87	38.40	38.85	31.50	74.00	-42.50	peak
3	4392.376	7.05	34.74	35.80	36.49	42.48	74.00	-31.52	peak
4	8416.584	10.88	36.67	37.01	39.35	49.89	74.00	-24.11	peak
5	11570.000	13.01	37.73	37.67	37.25	50.32	74.00	-23.68	peak
6	p17355.000	14.77	43.26	37.56	32.17	52.64	68.20	-15.56	peak



Unless otherwise agreed in writing, this document is issued by the Company subject to its General Conditions of Service printed overleaf, available on request or accessible at <https://www.sgs.com/en/Terms-and-Conditions>. Attention is drawn to the limitation of liability, indemnification and jurisdiction issues defined therein. Any holder of this document is advised that information contained hereon reflects the Company's findings at the time of its intervention only and within the limits of Client's instructions, if any. The Company's sole responsibility is to its Client and this document does not exonerate parties to a transaction from exercising all their rights and obligations under the transaction documents. This document cannot be reproduced except in full, without prior written approval of the Company. Any unauthorized alteration, forgery or falsification of the content or appearance of this document is unlawful and offenders may be prosecuted to the fullest extent of the law. Unless otherwise stated the results shown in this test report refer only to the sample(s) tested and such sample(s) are retained for 30 days only.

Test Mode: 24; Polarity: Vertical; Modulation:802.11a; Bandwidth:20MHz; Channel:middle

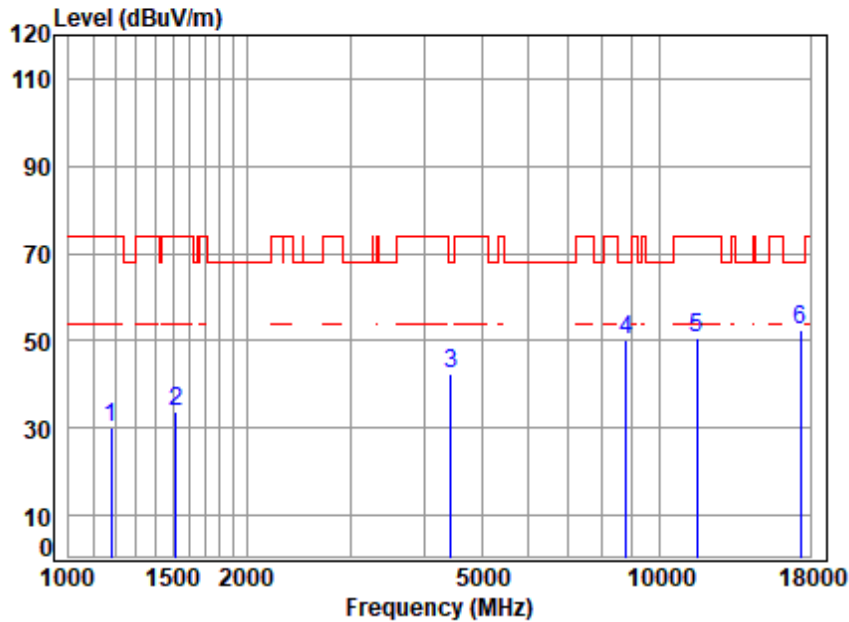

Site : chamber
 Condition: 3m VERTICAL
 Job No : 00955AT/00956AT
 Mode : 5785 TX RSE
 Note : 5G WIFI 11A

	Freq	Cable Loss	Ant Factor	Preamp Factor	Read Level	Level	Limit Line	Over Limit	Remark
	MHz	dB	dB/m	dB	dBuV	dBuV/m	dBuV/m	dB	
1	1179.100	3.54	24.19	38.34	40.92	30.31	74.00	-43.69	peak
2	1520.598	4.09	26.88	38.39	41.08	33.66	74.00	-40.34	peak
3	4443.453	7.09	34.28	35.77	36.72	42.32	68.20	-25.88	peak
4	8789.516	11.55	37.06	37.40	38.82	50.03	68.20	-18.17	peak
5	11570.000	13.01	37.73	37.67	37.64	50.71	74.00	-23.29	peak
6	p17355.000	14.77	43.26	37.56	32.01	52.48	68.20	-15.72	peak



Unless otherwise agreed in writing, this document is issued by the Company subject to its General Conditions of Service printed overleaf, available on request or accessible at <https://www.sgs.com/en/Terms-and-Conditions>. Attention is drawn to the limitation of liability, indemnification and jurisdiction issues defined therein. Any holder of this document is advised that information contained hereon reflects the Company's findings at the time of its intervention only and within the limits of Client's instructions, if any. The Company's sole responsibility is to its Client and this document does not exonerate parties to a transaction from exercising all their rights and obligations under the transaction documents. This document cannot be reproduced except in full, without prior written approval of the Company. Any unauthorized alteration, forgery or falsification of the content or appearance of this document is unlawful and offenders may be prosecuted to the fullest extent of the law. Unless otherwise stated the results shown in this test report refer only to the sample(s) tested and such sample(s) are retained for 30 days only.

Attention: To check the authenticity of testing /inspection report & certificate, please contact us at telephone: (86-755) 8307 1443, or email: CN.Doccheck@sgs.com
 No.1 Workshop, M-10, Middle Section, Science & Technology Park, Nanshan District, Shenzhen, Guangdong, China 518057 t (86-755) 26012053 f (86-755) 26710594 www.sgs.com.cn
 中国·广东·深圳市南山区科技园中区M-10栋1号厂房 邮编: 518057 t (86-755) 26012053 f (86-755) 26710594 sgs.china@sgs.com

Test Mode: 24; Polarity: Horizontal; Modulation:802.11a; Bandwidth:20MHz; Channel:High

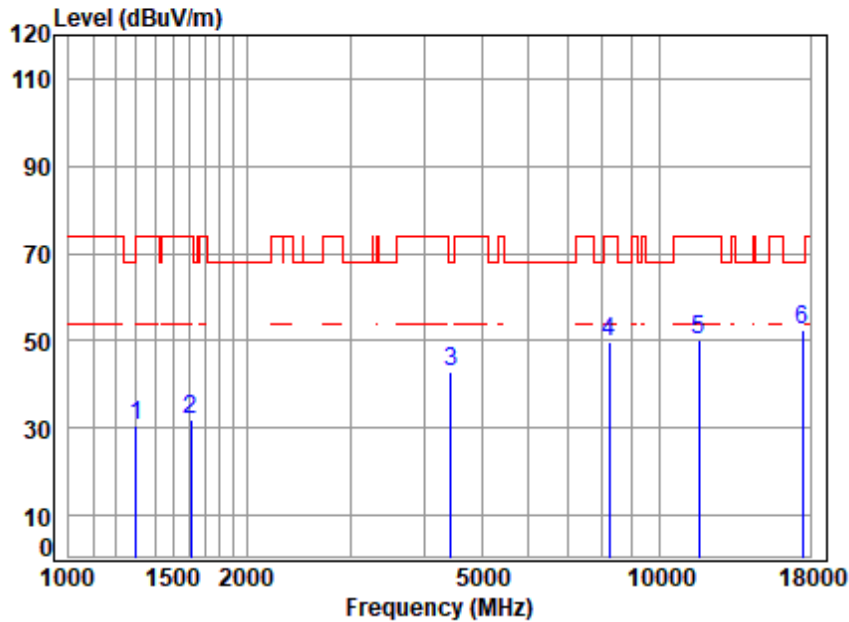

Site : chamber
 Condition: 3m HORIZONTAL
 Job No : 00955AT/00956AT
 Mode : 5825 TX RSE
 Note : 5G WIFI 11A

	Freq	Cable Loss	Ant Factor	Preamp Factor	Read Level	Level	Limit Line	Over Limit	Remark
	MHz	dB	dB/m	dB	dBuV	dBuV/m	dBuV/m	dB	
1	1300.858	3.76	24.79	38.36	40.40	30.59	74.00	-43.41	peak
2	1611.091	4.22	26.69	38.40	39.55	32.06	74.00	-41.94	peak
3	4430.628	7.08	34.43	35.77	37.19	42.93	68.20	-25.27	peak
4	8224.200	10.53	36.65	36.81	39.30	49.67	74.00	-24.33	peak
5	11650.000	13.03	37.80	37.65	37.13	50.31	74.00	-23.69	peak
6	p17475.000	14.84	43.40	37.58	31.89	52.55	68.20	-15.65	peak



Unless otherwise agreed in writing, this document is issued by the Company subject to its General Conditions of Service printed overleaf, available on request or accessible at <https://www.sgs.com/en/Terms-and-Conditions>. Attention is drawn to the limitation of liability, indemnification and jurisdiction issues defined therein. Any holder of this document is advised that information contained hereon reflects the Company's findings at the time of its intervention only and within the limits of Client's instructions, if any. The Company's sole responsibility is to its Client and this document does not exonerate parties to a transaction from exercising all their rights and obligations under the transaction documents. This document cannot be reproduced except in full, without prior written approval of the Company. Any unauthorized alteration, forgery or falsification of the content or appearance of this document is unlawful and offenders may be prosecuted to the fullest extent of the law. Unless otherwise stated the results shown in this test report refer only to the sample(s) tested and such sample(s) are retained for 30 days only.

Attention: To check the authenticity of testing /inspection report & certificate, please contact us at telephone: (86-755) 8307 1443, or email: CN.Doccheck@sgs.com
 No.1 Workshop, M-10, Middle Section, Science & Technology Park, Nanshan District, Shenzhen, Guangdong, China 518057 t (86-755) 26012053 f (86-755) 26710594 www.sgs.com.cn
 中国·广东·深圳市南山区科技园中区M-10栋1号厂房 邮编: 518057 t (86-755) 26012053 f (86-755) 26710594 sgs.china@sgs.com

Test Mode: 24; Polarity: Vertical; Modulation:802.11a; Bandwidth:20MHz; Channel:High

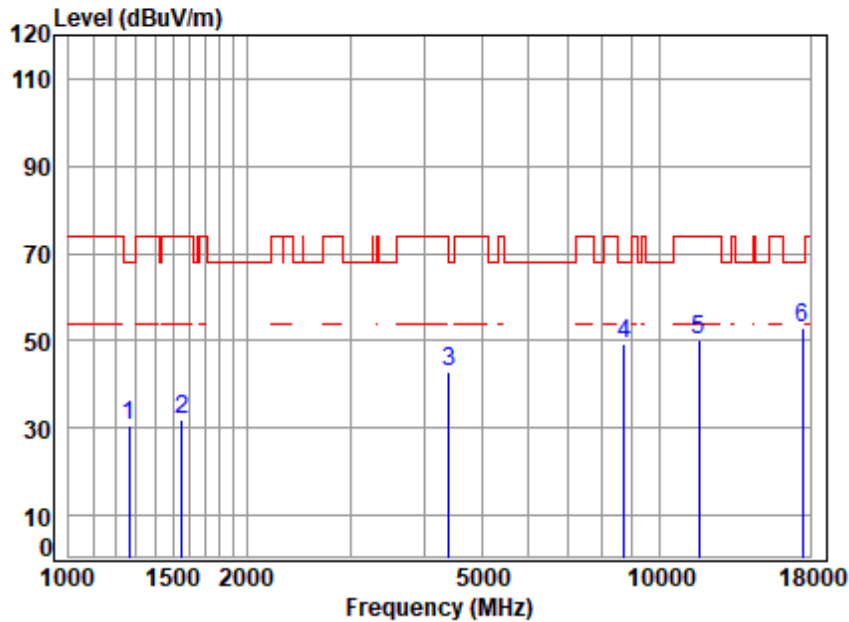

Site : chamber
 Condition: 3m VERTICAL
 Job No : 00955AT/00956AT
 Mode : 5825 TX RSE
 Note : 5G WIFI 11A

	Freq	Cable Loss	Ant Factor	Preamp Factor	Read Level	Level	Limit Line	Over Limit	Remark
	MHz	dB	dB/m	dB	dBuV	dBuV/m	dBuV/m	dB	
1	1263.796	3.69	25.02	38.35	40.29	30.65	68.20	-37.55	peak
2	1551.677	4.13	26.99	38.40	39.06	31.78	74.00	-42.22	peak
3	4405.090	7.06	34.74	35.79	36.84	42.85	68.20	-25.35	peak
4	8713.630	11.42	36.90	37.32	38.45	49.45	68.20	-18.75	peak
5	11650.000	13.03	37.80	37.65	37.12	50.30	74.00	-23.70	peak
6	p17475.000	14.84	43.40	37.58	32.23	52.89	68.20	-15.31	peak



Unless otherwise agreed in writing, this document is issued by the Company subject to its General Conditions of Service printed overleaf, available on request or accessible at <https://www.sgs.com/en/Terms-and-Conditions>. Attention is drawn to the limitation of liability, indemnification and jurisdiction issues defined therein. Any holder of this document is advised that information contained hereon reflects the Company's findings at the time of its intervention only and within the limits of Client's instructions, if any. The Company's sole responsibility is to its Client and this document does not exonerate parties to a transaction from exercising all their rights and obligations under the transaction documents. This document cannot be reproduced except in full, without prior written approval of the Company. Any unauthorized alteration, forgery or falsification of the content or appearance of this document is unlawful and offenders may be prosecuted to the fullest extent of the law. Unless otherwise stated the results shown in this test report refer only to the sample(s) tested and such sample(s) are retained for 30 days only.

Test Mode: 24; Polarity: Horizontal; Modulation:802.11ac; Bandwidth:20MHz; Channel:Low

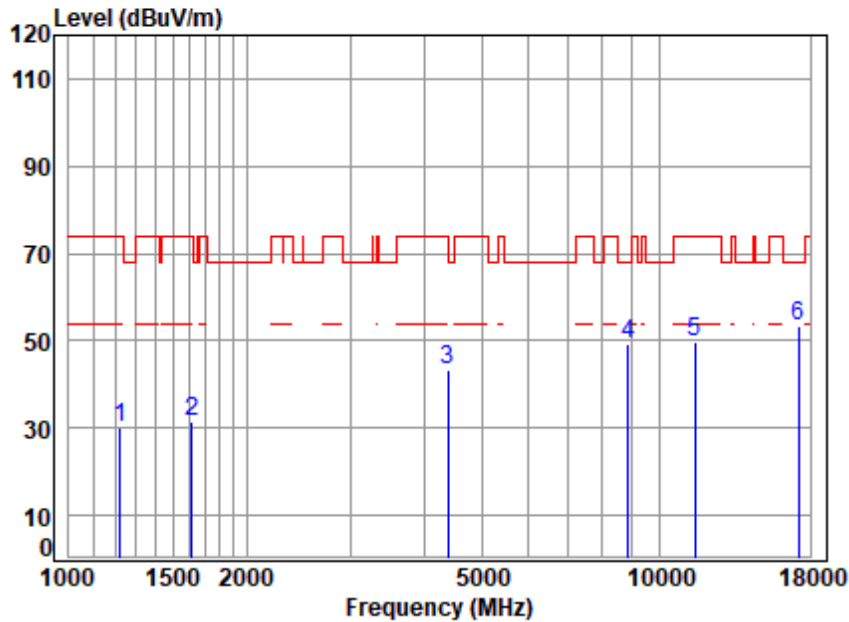

Site : chamber
 Condition: 3m HORIZONTAL
 Job No : 00955AT/00956AT
 Mode : 5745 TX RSE
 Note : 5G WIFI 11AC20

	Freq	Cable Loss	Ant Factor	Preamp Factor	Read Level	Level	Limit Line	Over Limit	Remark
	MHz	dB	dB/m	dB	dBuV	dBuV/m	dBuV/m	dB	
1	1224.247	3.62	24.74	38.34	40.30	30.32	74.00	-43.68	peak
2	1615.754	4.22	26.64	38.40	39.04	31.50	74.00	-42.50	peak
3	4379.699	7.04	34.64	35.81	37.54	43.41	74.00	-30.59	peak
4	8866.062	11.69	37.20	37.48	38.05	49.46	68.20	-18.74	peak
5	11490.000	13.00	37.79	37.69	36.85	49.95	74.00	-24.05	peak
6	p17235.000	14.70	43.03	37.55	33.07	53.25	68.20	-14.95	peak



Unless otherwise agreed in writing, this document is issued by the Company subject to its General Conditions of Service printed overleaf, available on request or accessible at <https://www.sgs.com/en/Terms-and-Conditions>. Attention is drawn to the limitation of liability, indemnification and jurisdiction issues defined therein. Any holder of this document is advised that information contained hereon reflects the Company's findings at the time of its intervention only and within the limits of Client's instructions, if any. The Company's sole responsibility is to its Client and this document does not exonerate parties to a transaction from exercising all their rights and obligations under the transaction documents. This document cannot be reproduced except in full, without prior written approval of the Company. Any unauthorized alteration, forgery or falsification of the content or appearance of this document is unlawful and offenders may be prosecuted to the fullest extent of the law. Unless otherwise stated the results shown in this test report refer only to the sample(s) tested and such sample(s) are retained for 30 days only.

Attention: To check the authenticity of testing /inspection report & certificate, please contact us at telephone: (86-755) 8307 1443, or email: CN.Doccheck@sgs.com
 No.1 Workshop, M-10, Middle Section, Science & Technology Park, Nanshan District, Shenzhen, Guangdong, China 518057 t (86-755) 26012053 f (86-755) 26710594 www.sgs.com.cn
 中国·广东·深圳市南山区科技园中区M-10栋1号厂房 邮编: 518057 t (86-755) 26012053 f (86-755) 26710594 sgs.china@sgs.com

Test Mode: 24; Polarity: Vertical; Modulation:802.11ac; Bandwidth:20MHz; Channel:Low

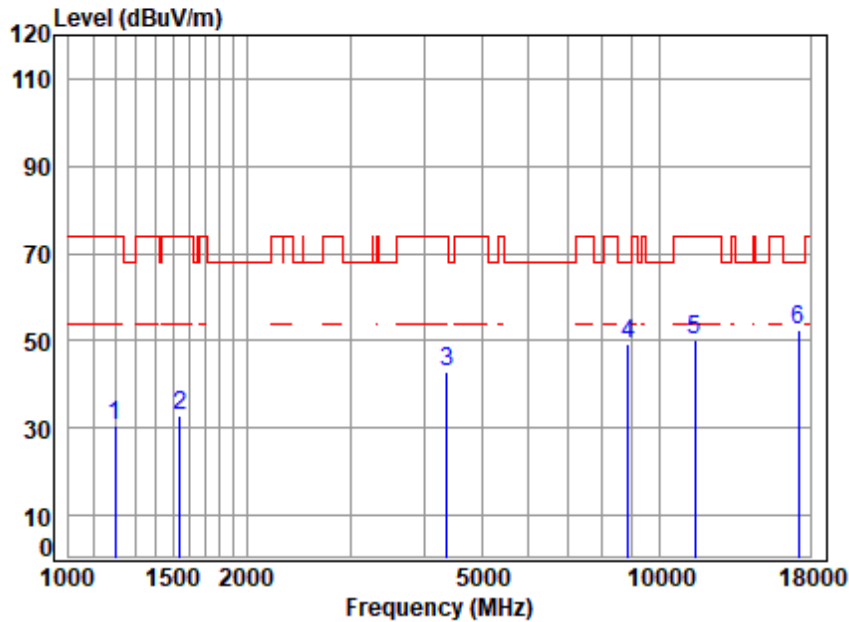

Site : chamber
 Condition: 3m VERTICAL
 Job No : 00955AT/00956AT
 Mode : 5745 TX RSE
 Note : 5G WIFI 11AC20

	Cable	Ant	Preamp	Read	Limit	Over		
Freq	Loss	Factor	Factor	Level	Level	Line	Limit	Remark
MHz	dB	dB/m	dB	dBuV	dBuV/m	dBuV/m	dB	
1	1196.264	3.58	24.36	38.34	40.75	30.35	74.00	-43.65 peak
2	1542.733	4.12	26.97	38.39	40.23	32.93	74.00	-41.07 peak
3	4367.058	7.04	34.54	35.82	36.91	42.67	74.00	-31.33 peak
4	8840.473	11.64	37.18	37.45	37.94	49.31	68.20	-18.89 peak
5	11490.000	13.00	37.79	37.69	37.18	50.28	74.00	-23.72 peak
6	p17235.000	14.70	43.03	37.55	32.52	52.70	68.20	-15.50 peak



Unless otherwise agreed in writing, this document is issued by the Company subject to its General Conditions of Service printed overleaf, available on request or accessible at <https://www.sgs.com/en/Terms-and-Conditions>. Attention is drawn to the limitation of liability, indemnification and jurisdiction issues defined therein. Any holder of this document is advised that information contained hereon reflects the Company's findings at the time of its intervention only and within the limits of Client's instructions, if any. The Company's sole responsibility is to its Client and this document does not exonerate parties to a transaction from exercising all their rights and obligations under the transaction documents. This document cannot be reproduced except in full, without prior written approval of the Company. Any unauthorized alteration, forgery or falsification of the content or appearance of this document is unlawful and offenders may be prosecuted to the fullest extent of the law. Unless otherwise stated the results shown in this test report refer only to the sample(s) tested and such sample(s) are retained for 30 days only.

Attention: To check the authenticity of testing /inspection report & certificate, please contact us at telephone: (86-755) 8307 1443, or email: CN.Doccheck@sgs.com
 No.1 Workshop, M-10, Middle Section, Science & Technology Park, Nanshan District, Shenzhen, Guangdong, China 518057 t (86-755) 26012053 f (86-755) 26710594 www.sgs.com.cn
 中国·广东·深圳市南山区科技园中区M-10栋1号厂房 邮编: 518057 t (86-755) 26012053 f (86-755) 26710594 sgs.china@sgs.com

Test Mode: 24; Polarity: Horizontal; Modulation:802.11ac; Bandwidth:20MHz; Channel:middle

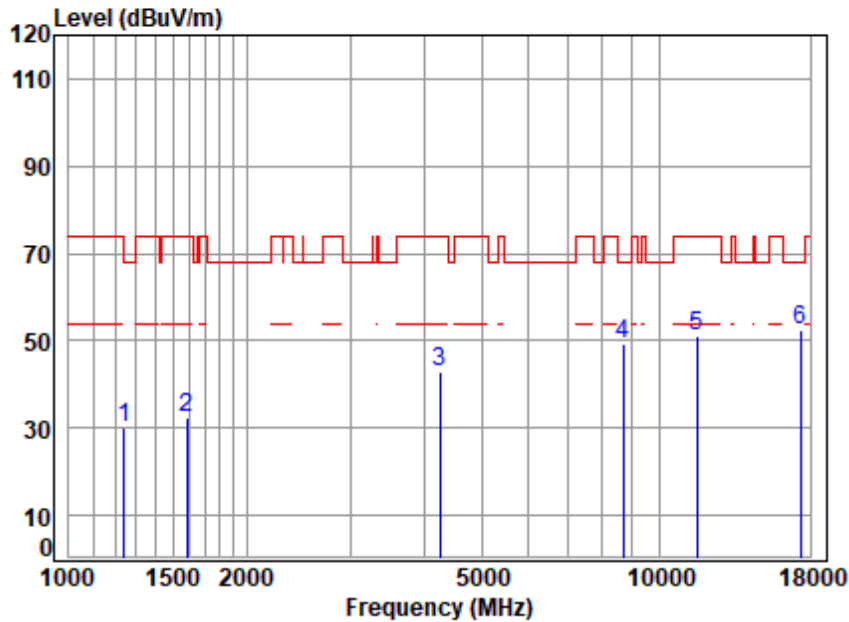

Site : chamber
 Condition: 3m HORIZONTAL
 Job No : 00955AT/00956AT
 Mode : 5785 TX RSE
 Note : 5G WIFI 11AC20

	Freq	Cable Loss	Ant Factor	Preamp Factor	Read Level	Level	Limit Line	Over Limit	Remark
	MHz	dB	dB/m	dB	dBuV	dBuV/m	dBuV/m	dB	
1	1242.068	3.66	24.99	38.35	39.97	30.27	68.20	-37.93	peak
2	1583.392	4.18	26.87	38.40	39.80	32.45	74.00	-41.55	peak
3	4254.921	6.96	33.82	35.90	38.12	43.00	74.00	-31.00	peak
4	8688.480	11.38	36.90	37.30	38.43	49.41	68.20	-18.79	peak
5	11570.000	13.01	37.73	37.67	38.09	51.16	74.00	-22.84	peak
6	p17355.000	14.77	43.26	37.56	32.09	52.56	68.20	-15.64	peak



Unless otherwise agreed in writing, this document is issued by the Company subject to its General Conditions of Service printed overleaf, available on request or accessible at <https://www.sgs.com/en/Terms-and-Conditions>. Attention is drawn to the limitation of liability, indemnification and jurisdiction issues defined therein. Any holder of this document is advised that information contained hereon reflects the Company's findings at the time of its intervention only and within the limits of Client's instructions, if any. The Company's sole responsibility is to its Client and this document does not exonerate parties to a transaction from exercising all their rights and obligations under the transaction documents. This document cannot be reproduced except in full, without prior written approval of the Company. Any unauthorized alteration, forgery or falsification of the content or appearance of this document is unlawful and offenders may be prosecuted to the fullest extent of the law. Unless otherwise stated the results shown in this test report refer only to the sample(s) tested and such sample(s) are retained for 30 days only.

Attention: To check the authenticity of testing /inspection report & certificate, please contact us at telephone: (86-755) 8307 1443, or email: CN.Doccheck@sgs.com
 No.1 Workshop, M-10, Middle Section, Science & Technology Park, Nanshan District, Shenzhen, Guangdong, China 518057 t (86-755) 26012053 f (86-755) 26710594 www.sgs.com.cn
 中国·广东·深圳市南山区科技园中区M-10栋1号厂房 邮编: 518057 t (86-755) 26012053 f (86-755) 26710594 sgs.china@sgs.com

Test Mode: 24; Polarity: Vertical; Modulation:802.11ac; Bandwidth:20MHz; Channel:middle

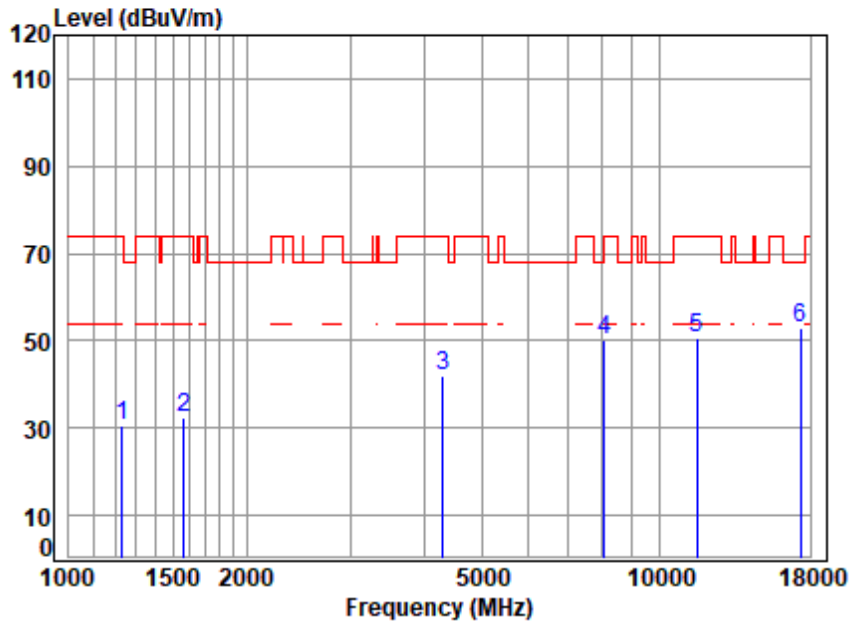

Site : chamber
 Condition: 3m VERTICAL
 Job No : 00955AT/00956AT
 Mode : 5785 TX RSE
 Note : 5G WIFI 11AC20

	Freq	Cable Loss	Ant Factor	Preamp Factor	Read Level	Level	Limit Line	Over Limit	Remark
	MHz	dB	dB/m	dB	dBuV	dBuV/m	dBuV/m	dB	
1	1231.345	3.64	24.84	38.35	40.25	30.38	74.00	-43.62	peak
2	1565.191	4.15	26.94	38.40	39.72	32.41	74.00	-41.59	peak
3	4304.400	6.99	34.04	35.87	37.00	42.16	74.00	-31.84	peak
4	8082.804	10.26	36.47	36.65	40.03	50.11	74.00	-23.89	peak
5	11570.000	13.01	37.73	37.67	37.66	50.73	74.00	-23.27	peak
6	p17355.000	14.77	43.26	37.56	32.29	52.76	68.20	-15.44	peak



Unless otherwise agreed in writing, this document is issued by the Company subject to its General Conditions of Service printed overleaf, available on request or accessible at <https://www.sgs.com/en/Terms-and-Conditions>. Attention is drawn to the limitation of liability, indemnification and jurisdiction issues defined therein. Any holder of this document is advised that information contained hereon reflects the Company's findings at the time of its intervention only and within the limits of Client's instructions, if any. The Company's sole responsibility is to its Client and this document does not exonerate parties to a transaction from exercising all their rights and obligations under the transaction documents. This document cannot be reproduced except in full, without prior written approval of the Company. Any unauthorized alteration, forgery or falsification of the content or appearance of this document is unlawful and offenders may be prosecuted to the fullest extent of the law. Unless otherwise stated the results shown in this test report refer only to the sample(s) tested and such sample(s) are retained for 30 days only.

Test Mode: 24; Polarity: Horizontal; Modulation:802.11ac; Bandwidth:20MHz; Channel:High

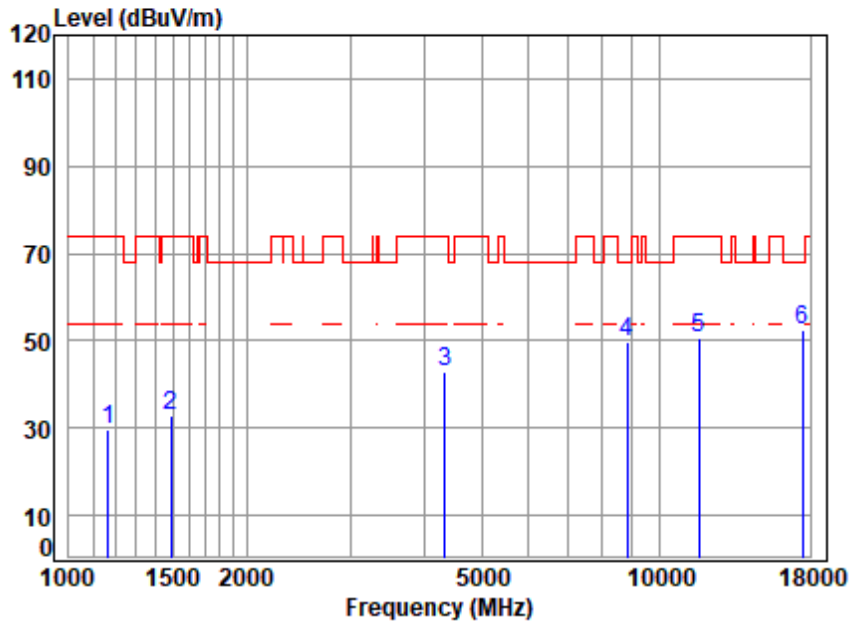

Site : chamber
 Condition: 3m HORIZONTAL
 Job No : 00955AT/00956AT
 Mode : 5825 TX RSE
 Note : 5G WIFI 11AC20

	Cable	Ant	Preamp	Read	Limit	Over		
Freq	Loss	Factor	Factor	Level	Level	Line	Limit	Remark
MHz	dB	dB/m	dB	dBuV	dBuV/m	dBuV/m	dB	
1	1165.546	3.52	24.06	38.33	40.50	29.75	74.00	-44.25 peak
2	1490.142	4.05	26.52	38.39	40.73	32.91	74.00	-41.09 peak
3	4341.886	7.02	34.34	35.84	37.15	42.67	74.00	-31.33 peak
4	8814.957	11.60	37.13	37.42	38.25	49.56	68.20	-18.64 peak
5	11650.000	13.03	37.80	37.65	37.43	50.61	74.00	-23.39 peak
6	p17475.000	14.84	43.40	37.58	31.91	52.57	68.20	-15.63 peak



Unless otherwise agreed in writing, this document is issued by the Company subject to its General Conditions of Service printed overleaf, available on request or accessible at <https://www.sgs.com/en/Terms-and-Conditions>. Attention is drawn to the limitation of liability, indemnification and jurisdiction issues defined therein. Any holder of this document is advised that information contained hereon reflects the Company's findings at the time of its intervention only and within the limits of Client's instructions, if any. The Company's sole responsibility is to its Client and this document does not exonerate parties to a transaction from exercising all their rights and obligations under the transaction documents. This document cannot be reproduced except in full, without prior written approval of the Company. Any unauthorized alteration, forgery or falsification of the content or appearance of this document is unlawful and offenders may be prosecuted to the fullest extent of the law. Unless otherwise stated the results shown in this test report refer only to the sample(s) tested and such sample(s) are retained for 30 days only.

Attention: To check the authenticity of testing /inspection report & certificate, please contact us at telephone: (86-755) 8307 1443, or email: CN.Doccheck@sgs.com
 No.1 Workshop, M-10, Middle Section, Science & Technology Park, Nanshan District, Shenzhen, Guangdong, China 518057 t (86-755) 26012053 f (86-755) 26710594 www.sgs.com.cn
 中国·广东·深圳市南山区科技园中区M-10栋1号厂房 邮编: 518057 t (86-755) 26012053 f (86-755) 26710594 sgs.china@sgs.com

Test Mode: 24; Polarity: Vertical; Modulation:802.11ac; Bandwidth:20MHz; Channel:High

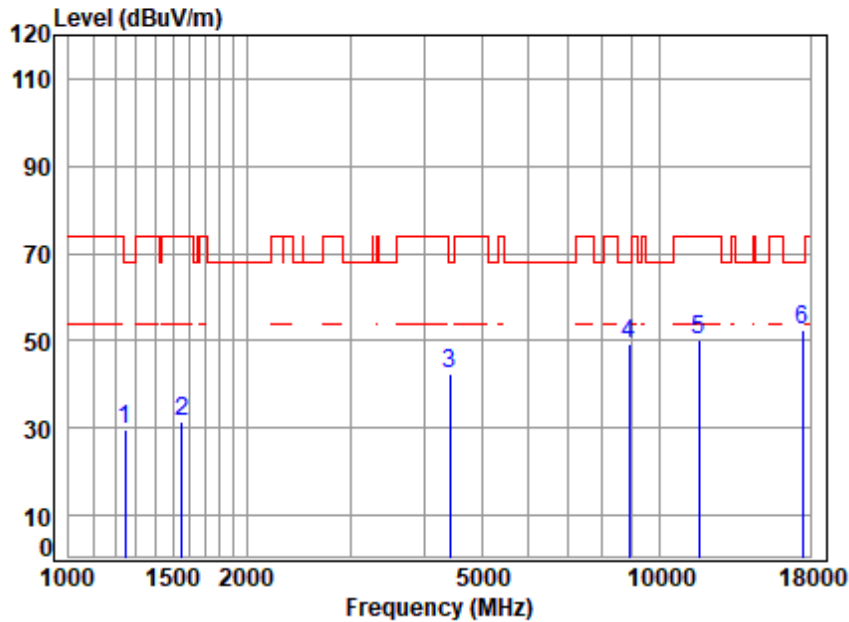

Site : chamber
 Condition: 3m VERTICAL
 Job No : 00955AT/00956AT
 Mode : 5825 TX RSE
 Note : 5G WIFI 11AC20

	Freq	Cable Loss	Ant Factor	Preamp Factor	Read Level	Level	Limit Line	Over Limit	Remark
	MHz	dB	dB/m	dB	dBuV	dBuV/m	dBuV/m	dB	
1	1245.663	3.66	25.04	38.35	39.43	29.78	68.20	-38.42	peak
2	1551.677	4.13	26.99	38.40	38.98	31.70	74.00	-42.30	peak
3	4417.841	7.07	34.59	35.78	36.39	42.27	68.20	-25.93	peak
4	8891.725	11.73	37.20	37.50	37.70	49.13	68.20	-19.07	peak
5	11650.000	13.03	37.80	37.65	36.95	50.13	74.00	-23.87	peak
6	p17475.000	14.84	43.40	37.58	32.00	52.66	68.20	-15.54	peak



Unless otherwise agreed in writing, this document is issued by the Company subject to its General Conditions of Service printed overleaf, available on request or accessible at <https://www.sgs.com/en/Terms-and-Conditions>. Attention is drawn to the limitation of liability, indemnification and jurisdiction issues defined therein. Any holder of this document is advised that information contained hereon reflects the Company's findings at the time of its intervention only and within the limits of Client's instructions, if any. The Company's sole responsibility is to its Client and this document does not exonerate parties to a transaction from exercising all their rights and obligations under the transaction documents. This document cannot be reproduced except in full, without prior written approval of the Company. Any unauthorized alteration, forgery or falsification of the content or appearance of this document is unlawful and offenders may be prosecuted to the fullest extent of the law. Unless otherwise stated the results shown in this test report refer only to the sample(s) tested and such sample(s) are retained for 30 days only.

Attention: To check the authenticity of testing /inspection report & certificate, please contact us at telephone: (86-755) 8307 1443, or email: CN.Doccheck@sgs.com
 No.1 Workshop, M-10, Middle Section, Science & Technology Park, Nanshan District, Shenzhen, Guangdong, China 518057 t (86-755) 26012053 f (86-755) 26710594 www.sgs.com.cn
 中国·广东·深圳市南山区科技园中区M-10栋1号厂房 邮编: 518057 t (86-755) 26012053 f (86-755) 26710594 sgs.china@sgs.com

Test Mode: 24; Polarity: Horizontal; Modulation:802.11ac; Bandwidth:40MHz; Channel:Low

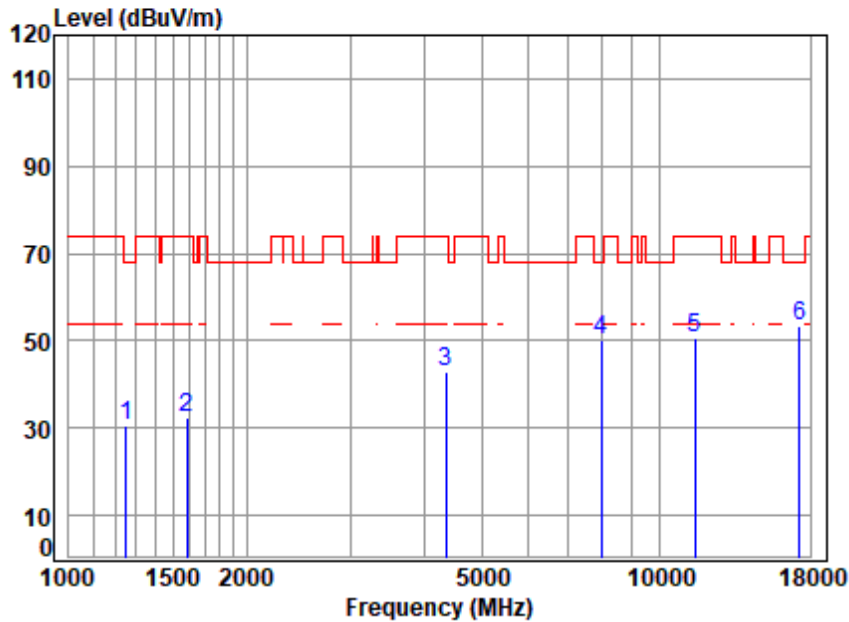

Site : chamber
 Condition: 3m HORIZONTAL
 Job No : 00955AT/00956AT
 Mode : 5755 TX RSE
 Note : 5G WIFI 11AC40

	Cable	Ant	Preamp	Read	Limit	Over		
Freq	Loss	Factor	Factor	Level	Level	Line	Limit	Remark
MHz	dB	dB/m	dB	dBuV	dBuV/m	dBuV/m	dB	
1	1252.885	3.67	25.08	38.35	40.18	30.58	68.20	-37.62 peak
2	1583.392	4.18	26.87	38.40	39.67	32.32	74.00	-41.68 peak
3	4354.454	7.03	34.44	35.83	37.22	42.86	74.00	-31.14 peak
4	7989.893	10.09	36.40	36.55	40.17	50.11	68.20	-18.09 peak
5	11510.000	13.00	37.79	37.69	37.75	50.85	74.00	-23.15 peak
6	p17265.000	14.72	43.06	37.55	33.06	53.29	68.20	-14.91 peak



Unless otherwise agreed in writing, this document is issued by the Company subject to its General Conditions of Service printed overleaf, available on request or accessible at <https://www.sgs.com/en/Terms-and-Conditions>. Attention is drawn to the limitation of liability, indemnification and jurisdiction issues defined therein. Any holder of this document is advised that information contained hereon reflects the Company's findings at the time of its intervention only and within the limits of Client's instructions, if any. The Company's sole responsibility is to its Client and this document does not exonerate parties to a transaction from exercising all their rights and obligations under the transaction documents. This document cannot be reproduced except in full, without prior written approval of the Company. Any unauthorized alteration, forgery or falsification of the content or appearance of this document is unlawful and offenders may be prosecuted to the fullest extent of the law. Unless otherwise stated the results shown in this test report refer only to the sample(s) tested and such sample(s) are retained for 30 days only.

Attention: To check the authenticity of testing /inspection report & certificate, please contact us at telephone: (86-755) 8307 1443, or email: CN.Doccheck@sgs.com
 No.1 Workshop, M-10, Middle Section, Science & Technology Park, Nanshan District, Shenzhen, Guangdong, China 518057 t (86-755) 26012053 f (86-755) 26710594 www.sgs.com.cn
 中国·广东·深圳市南山区科技园中区M-10栋1号厂房 邮编: 518057 t (86-755) 26012053 f (86-755) 26710594 sgs.china@sgs.com

Test Mode: 24; Polarity: Vertical; Modulation:802.11ac; Bandwidth:40MHz; Channel:Low

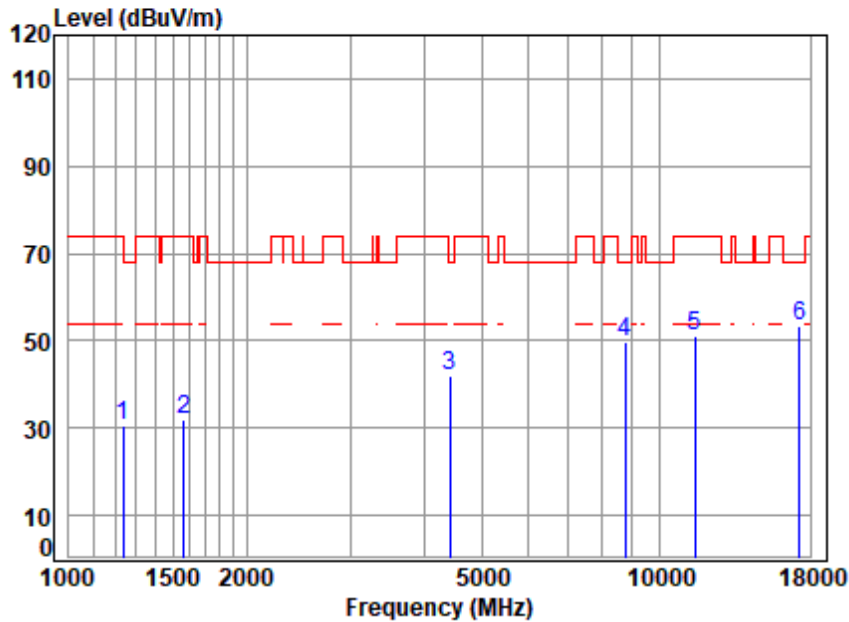

Site : chamber
 Condition: 3m VERTICAL
 Job No : 00955AT/00956AT
 Mode : 5755 TX RSE
 Note : 5G WIFI 11AC40

	Freq	Cable Loss	Ant Factor	Preamp Factor	Read Level	Level	Limit Line	Over Limit	Remark
	MHz	dB	dB/m	dB	dBuV	dBuV/m	dBuV/m	dB	
1	1238.483	3.65	24.94	38.35	40.26	30.50	74.00	-43.50	peak
2	1565.191	4.15	26.94	38.40	39.22	31.91	74.00	-42.09	peak
3	4417.841	7.07	34.59	35.78	36.08	41.96	68.20	-26.24	peak
4	8738.852	11.47	36.90	37.35	38.50	49.52	68.20	-18.68	peak
5	11510.000	13.00	37.79	37.69	37.83	50.93	74.00	-23.07	peak
6	p17265.000	14.72	43.06	37.55	33.11	53.34	68.20	-14.86	peak



Unless otherwise agreed in writing, this document is issued by the Company subject to its General Conditions of Service printed overleaf, available on request or accessible at <https://www.sgs.com/en/Terms-and-Conditions>. Attention is drawn to the limitation of liability, indemnification and jurisdiction issues defined therein. Any holder of this document is advised that information contained hereon reflects the Company's findings at the time of its intervention only and within the limits of Client's instructions, if any. The Company's sole responsibility is to its Client and this document does not exonerate parties to a transaction from exercising all their rights and obligations under the transaction documents. This document cannot be reproduced except in full, without prior written approval of the Company. Any unauthorized alteration, forgery or falsification of the content or appearance of this document is unlawful and offenders may be prosecuted to the fullest extent of the law. Unless otherwise stated the results shown in this test report refer only to the sample(s) tested and such sample(s) are retained for 30 days only.

Attention: To check the authenticity of testing /inspection report & certificate, please contact us at telephone: (86-755) 8307 1443, or email: CN.Doccheck@sgs.com
 No.1 Workshop, M-10, Middle Section, Science & Technology Park, Nanshan District, Shenzhen, Guangdong, China 518057 t (86-755) 26012053 f (86-755) 26710594 www.sgs.com.cn
 中国·广东·深圳市南山区科技园中区M-10栋1号厂房 邮编: 518057 t (86-755) 26012053 f (86-755) 26710594 sgs.china@sgs.com

Test Mode: 24; Polarity: Horizontal; Modulation:802.11ac; Bandwidth:40MHz; Channel:High

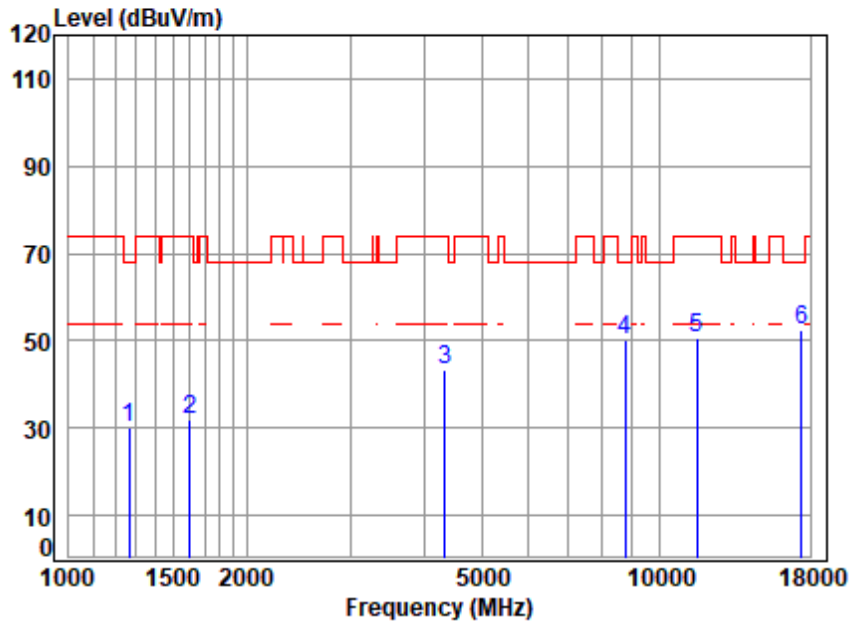

Site : chamber
 Condition: 3m HORIZONTAL
 Job No : 00955AT/00956AT
 Mode : 5795 TX RSE
 Note : 5G WIFI 11AC40

	Freq	Cable Loss	Ant Factor	Preamp Factor	Read Level	Level	Limit Line	Over Limit	Remark
	MHz	dB	dB/m	dB	dBuV	dBuV/m	dBuV/m	dB	
1	1267.454	3.70	25.00	38.35	39.75	30.10	68.20	-38.10	peak
2	1606.441	4.21	26.74	38.40	39.16	31.71	74.00	-42.29	peak
3	4329.354	7.01	34.23	35.85	37.84	43.23	74.00	-30.77	peak
4	8764.146	11.51	36.96	37.37	38.95	50.05	68.20	-18.15	peak
5	11590.000	13.01	37.71	37.67	37.65	50.70	74.00	-23.30	peak
6	p17385.000	14.79	43.35	37.57	32.12	52.69	68.20	-15.51	peak



Unless otherwise agreed in writing, this document is issued by the Company subject to its General Conditions of Service printed overleaf, available on request or accessible at <https://www.sgs.com/en/Terms-and-Conditions>. Attention is drawn to the limitation of liability, indemnification and jurisdiction issues defined therein. Any holder of this document is advised that information contained hereon reflects the Company's findings at the time of its intervention only and within the limits of Client's instructions, if any. The Company's sole responsibility is to its Client and this document does not exonerate parties to a transaction from exercising all their rights and obligations under the transaction documents. This document cannot be reproduced except in full, without prior written approval of the Company. Any unauthorized alteration, forgery or falsification of the content or appearance of this document is unlawful and offenders may be prosecuted to the fullest extent of the law. Unless otherwise stated the results shown in this test report refer only to the sample(s) tested and such sample(s) are retained for 30 days only.

Test Mode: 24; Polarity: Vertical; Modulation:802.11ac; Bandwidth:40MHz; Channel:High

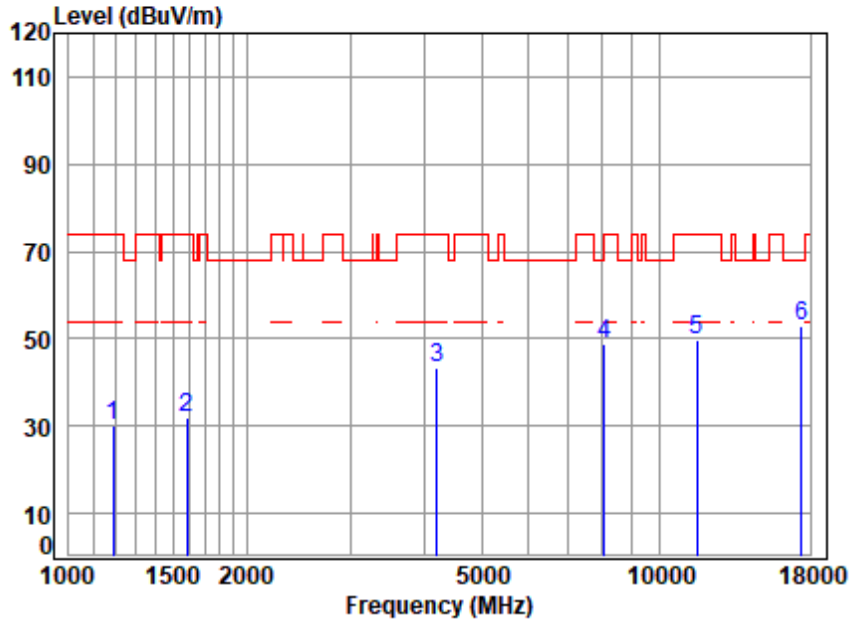

Site : chamber
 Condition: 3m VERTICAL
 Job No : 00955AT/00956AT
 Mode : 5795 TX RSE
 Note : 5G WIFI 11AC40

	Cable	Ant	Preamp	Read	Limit	Over		
Freq	Loss	Factor	Factor	Level	Level	Line	Limit	Remark
MHz	dB	dB/m	dB	dBuV	dBuV/m	dBuV/m	dB	
1	1189.368	3.56	24.29	38.34	40.71	30.22	74.00	-43.78 peak
2	1583.392	4.18	26.87	38.40	39.49	32.14	74.00	-41.86 peak
3	4193.872	6.92	33.80	35.95	38.52	43.29	74.00	-30.71 peak
4	8059.475	10.21	36.42	36.63	38.70	48.70	74.00	-25.30 peak
5	11590.000	13.01	37.71	37.67	36.71	49.76	74.00	-24.24 peak
6	p17385.000	14.79	43.35	37.57	32.20	52.77	68.20	-15.43 peak



Unless otherwise agreed in writing, this document is issued by the Company subject to its General Conditions of Service printed overleaf, available on request or accessible at <https://www.sgs.com/en/Terms-and-Conditions>. Attention is drawn to the limitation of liability, indemnification and jurisdiction issues defined therein. Any holder of this document is advised that information contained hereon reflects the Company's findings at the time of its intervention only and within the limits of Client's instructions, if any. The Company's sole responsibility is to its Client and this document does not exonerate parties to a transaction from exercising all their rights and obligations under the transaction documents. This document cannot be reproduced except in full, without prior written approval of the Company. Any unauthorized alteration, forgery or falsification of the content or appearance of this document is unlawful and offenders may be prosecuted to the fullest extent of the law. Unless otherwise stated the results shown in this test report refer only to the sample(s) tested and such sample(s) are retained for 30 days only.

Attention: To check the authenticity of testing /inspection report & certificate, please contact us at telephone: (86-755) 8307 1443, or email: CN.Doccheck@sgs.com
 No.1 Workshop, M-10, Middle Section, Science & Technology Park, Nanshan District, Shenzhen, Guangdong, China 518057 t (86-755) 26012053 f (86-755) 26710594 www.sgs.com.cn
 中国·广东·深圳市南山区科技园中区M-10栋1号厂房 邮编: 518057 t (86-755) 26012053 f (86-755) 26710594 sgs.china@sgs.com

Test Mode: 24; Polarity: Horizontal; Modulation:802.11ac; Bandwidth:80MHz; Channel:middle

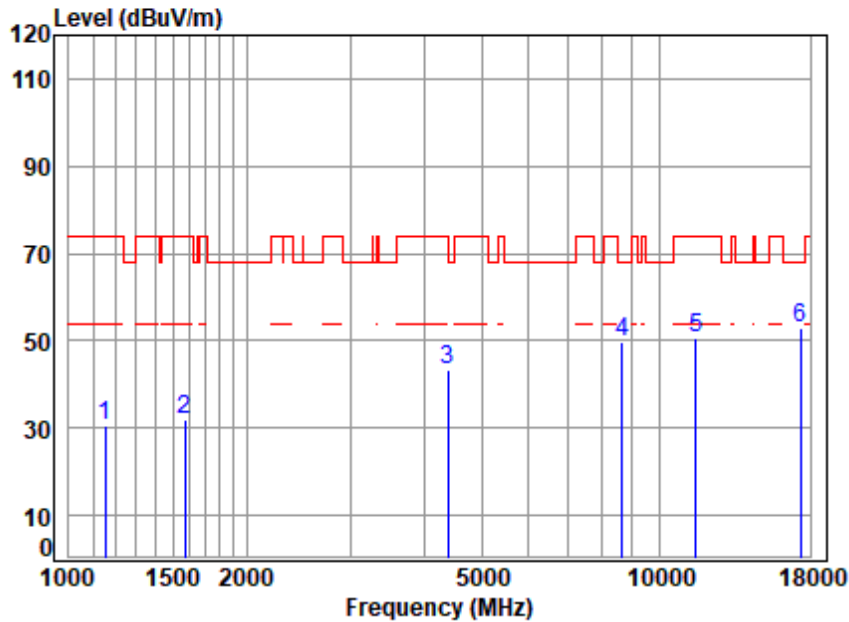

Site : chamber
 Condition: 3m HORIZONTAL
 Job No : 00955AT/00956AT
 Mode : 5775 TX RSE
 Note : 5G WIFI 11AC80

	Freq	Cable Loss	Ant Factor	Preamp Factor	Read Level	Level	Limit Line	Over Limit	Remark
	MHz	dB	dB/m	dB	dBuV	dBuV/m	dBuV/m	dB	
1	1152.148	3.49	23.92	38.33	41.29	30.37	74.00	-43.63	peak
2	1574.265	4.17	26.90	38.40	39.47	32.14	74.00	-41.86	peak
3	4379.699	7.04	34.64	35.81	37.60	43.47	74.00	-30.53	peak
4	8663.404	11.33	36.90	37.27	38.88	49.84	68.20	-18.36	peak
5	11550.000	13.01	37.75	37.68	37.55	50.63	74.00	-23.37	peak
6	p17325.000	14.76	43.17	37.56	32.44	52.81	68.20	-15.39	peak



Unless otherwise agreed in writing, this document is issued by the Company subject to its General Conditions of Service printed overleaf, available on request or accessible at <https://www.sgs.com/en/Terms-and-Conditions>. Attention is drawn to the limitation of liability, indemnification and jurisdiction issues defined therein. Any holder of this document is advised that information contained hereon reflects the Company's findings at the time of its intervention only and within the limits of Client's instructions, if any. The Company's sole responsibility is to its Client and this document does not exonerate parties to a transaction from exercising all their rights and obligations under the transaction documents. This document cannot be reproduced except in full, without prior written approval of the Company. Any unauthorized alteration, forgery or falsification of the content or appearance of this document is unlawful and offenders may be prosecuted to the fullest extent of the law. Unless otherwise stated the results shown in this test report refer only to the sample(s) tested and such sample(s) are retained for 30 days only.

Attention: To check the authenticity of testing /inspection report & certificate, please contact us at telephone: (86-755) 8307 1443, or email: CN.Doccheck@sgs.com
 No.1 Workshop, M-10, Middle Section, Science & Technology Park, Nanshan District, Shenzhen, Guangdong, China 518057 t (86-755) 26012053 f (86-755) 26710594 www.sgs.com.cn
 中国·广东·深圳市南山区科技园中区M-10栋1号厂房 邮编: 518057 t (86-755) 26012053 f (86-755) 26710594 sgs.china@sgs.com

Test Mode: 24; Polarity: Vertical; Modulation:802.11ac; Bandwidth:80MHz; Channel:middle

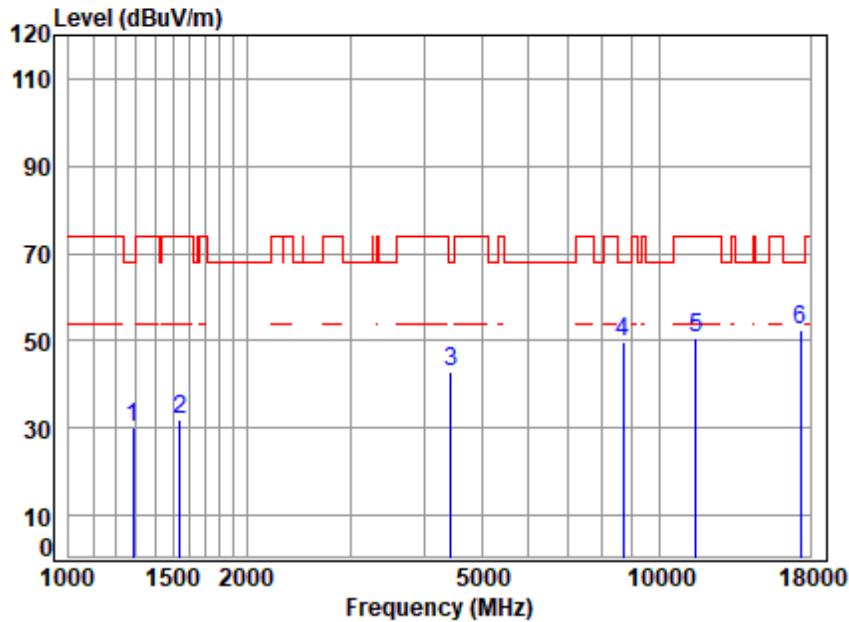

Site : chamber
 Condition: 3m VERTICAL
 Job No : 00955AT/00956AT
 Mode : 5775 TX RSE
 Note : 5G WIFI 11AC80

	Freq	Cable Loss	Ant Factor	Preamp Factor	Read Level	Level	Limit Line	Over Limit	Remark
	MHz	dB	dB/m	dB	dBuV	dBuV/m	dBuV/m	dB	
1	1285.904	3.73	24.88	38.35	39.86	30.12	68.20	-38.08	peak
2	1542.733	4.12	26.97	38.39	39.45	32.15	74.00	-41.85	peak
3	4443.453	7.09	34.28	35.77	37.38	42.98	68.20	-25.22	peak
4	8688.480	11.38	36.90	37.30	38.93	49.91	68.20	-18.29	peak
5	11550.000	13.01	37.75	37.68	37.79	50.87	74.00	-23.13	peak
6	p17325.000	14.76	43.17	37.56	32.15	52.52	68.20	-15.68	peak



Unless otherwise agreed in writing, this document is issued by the Company subject to its General Conditions of Service printed overleaf, available on request or accessible at <https://www.sgs.com/en/Terms-and-Conditions>. Attention is drawn to the limitation of liability, indemnification and jurisdiction issues defined therein. Any holder of this document is advised that information contained hereon reflects the Company's findings at the time of its intervention only and within the limits of Client's instructions, if any. The Company's sole responsibility is to its Client and this document does not exonerate parties to a transaction from exercising all their rights and obligations under the transaction documents. This document cannot be reproduced except in full, without prior written approval of the Company. Any unauthorized alteration, forgery or falsification of the content or appearance of this document is unlawful and offenders may be prosecuted to the fullest extent of the law. Unless otherwise stated the results shown in this test report refer only to the sample(s) tested and such sample(s) are retained for 30 days only.

Test Mode: 25; Polarity: Horizontal; Modulation:802.11a; Bandwidth:20MHz; Channel:Low

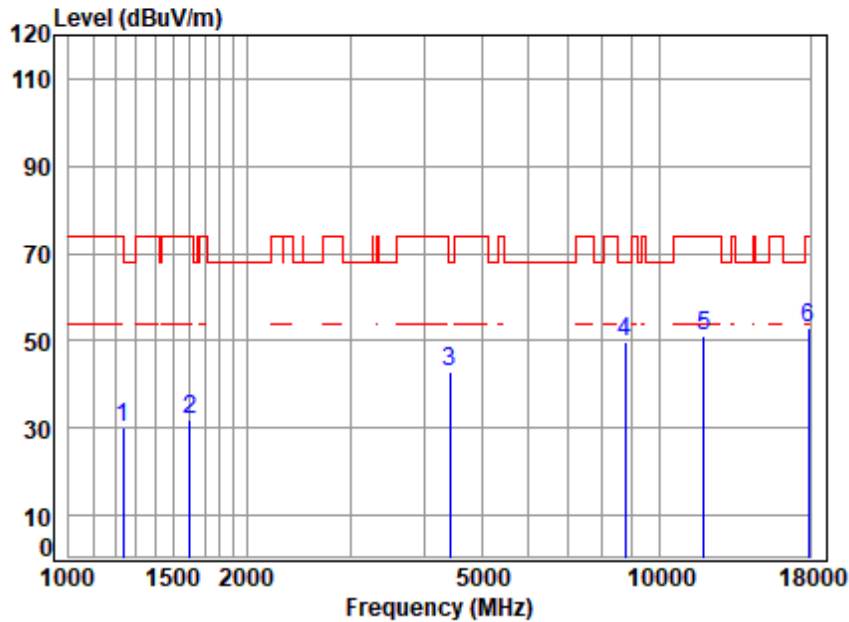

Site : chamber
 Condition: 3m HORIZONTAL
 Job No : 00955AT/00956AT
 Mode : 5955 TX RSE
 Note : 6E WIFI 11A

	Freq	Cable Loss	Ant Factor	Preamp Factor	Read Level	Level	Limit Line	Over Limit	Remark
	MHz	dB	dB/m	dB	dBuV	dBuV/m	dBuV/m	dB	
1	1238.483	3.65	24.94	38.35	39.92	30.16	74.00	-43.84	peak
2	1606.441	4.21	26.74	38.40	39.46	32.01	74.00	-41.99	peak
3	4417.841	7.07	34.59	35.78	36.86	42.74	68.20	-25.46	peak
4	8738.852	11.47	36.90	37.35	38.70	49.72	68.20	-18.48	peak
5	11910.000	13.07	37.71	37.58	37.99	51.19	74.00	-22.81	peak
6	17865.000	15.07	43.90	37.64	31.82	53.15	74.00	-20.85	peak



Unless otherwise agreed in writing, this document is issued by the Company subject to its General Conditions of Service printed overleaf, available on request or accessible at <https://www.sgs.com/en/Terms-and-Conditions>. Attention is drawn to the limitation of liability, indemnification and jurisdiction issues defined therein. Any holder of this document is advised that information contained hereon reflects the Company's findings at the time of its intervention only and within the limits of Client's instructions, if any. The Company's sole responsibility is to its Client and this document does not exonerate parties to a transaction from exercising all their rights and obligations under the transaction documents. This document cannot be reproduced except in full, without prior written approval of the Company. Any unauthorized alteration, forgery or falsification of the content or appearance of this document is unlawful and offenders may be prosecuted to the fullest extent of the law. Unless otherwise stated the results shown in this test report refer only to the sample(s) tested and such sample(s) are retained for 30 days only.

Test Mode: 25; Polarity: Vertical; Modulation:802.11a; Bandwidth:20MHz; Channel:Low

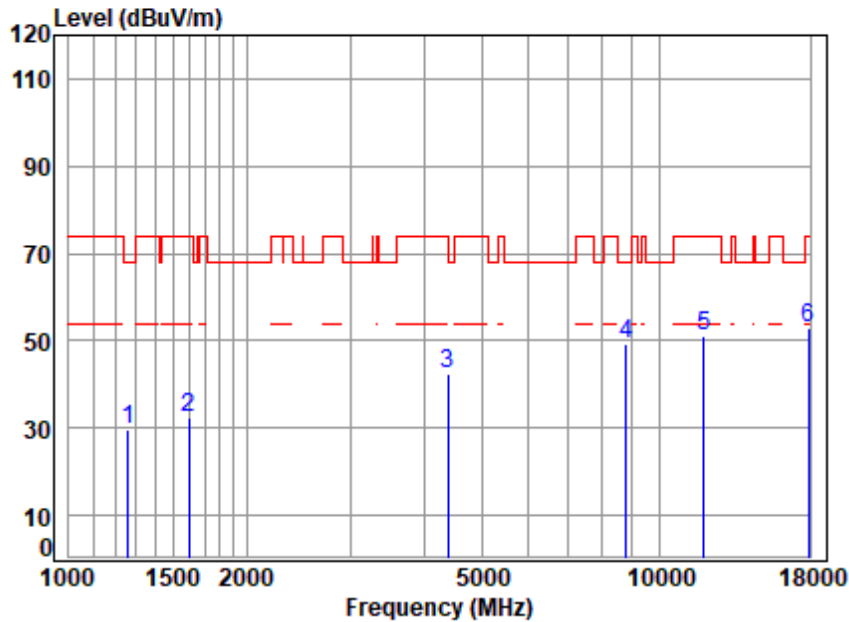

Site : chamber
 Condition: 3m VERTICAL
 Job No : 00955AT/00956AT
 Mode : 5955 TX RSE
 Note : 6E WIFI 11A

	Freq	Cable Loss	Ant Factor	Preamp Factor	Read Level	Level	Limit Line	Over Limit	Remark
	MHz	dB	dB/m	dB	dBuV	dBuV/m	dBuV/m	dB	
1	1260.149	3.69	25.04	38.35	39.39	29.77	68.20	-38.43	peak
2	1597.181	4.20	26.81	38.40	39.78	32.39	74.00	-41.61	peak
3	4392.376	7.05	34.74	35.80	36.60	42.59	74.00	-31.41	peak
4 p	8789.516	11.55	37.06	37.40	38.20	49.41	68.20	-18.79	peak
5	11910.000	13.07	37.71	37.58	37.78	50.98	74.00	-23.02	peak
6	17865.000	15.07	43.90	37.64	31.52	52.85	74.00	-21.15	peak



Unless otherwise agreed in writing, this document is issued by the Company subject to its General Conditions of Service printed overleaf, available on request or accessible at <https://www.sgs.com/en/Terms-and-Conditions>. Attention is drawn to the limitation of liability, indemnification and jurisdiction issues defined therein. Any holder of this document is advised that information contained hereon reflects the Company's findings at the time of its intervention only and within the limits of Client's instructions, if any. The Company's sole responsibility is to its Client and this document does not exonerate parties to a transaction from exercising all their rights and obligations under the transaction documents. This document cannot be reproduced except in full, without prior written approval of the Company. Any unauthorized alteration, forgery or falsification of the content or appearance of this document is unlawful and offenders may be prosecuted to the fullest extent of the law. Unless otherwise stated the results shown in this test report refer only to the sample(s) tested and such sample(s) are retained for 30 days only.

Test Mode: 25; Polarity: Horizontal; Modulation:802.11a; Bandwidth:20MHz; Channel:middle

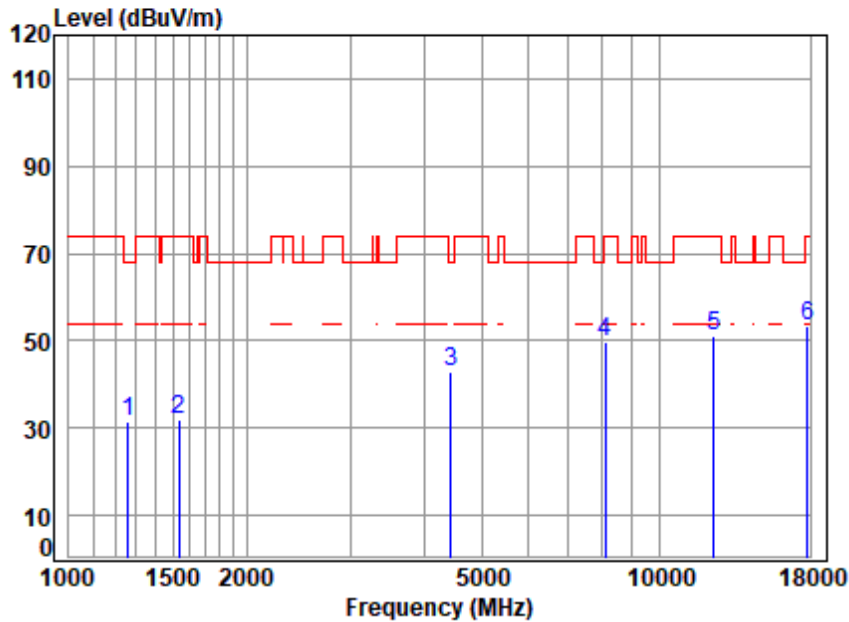

Site : chamber
 Condition: 3m HORIZONTAL
 Job No : 00955AT/00956AT
 Mode : 6175 TX RSE
 Note : 6E WIFI 11A

	Freq	Cable Loss	Ant Factor	Preamp Factor	Read Level	Level	Limit Line	Over Limit	Remark
	MHz	dB	dB/m	dB	dBuV	dBuV/m	dBuV/m	dB	
1	1260.149	3.69	25.04	38.35	41.02	31.40	68.20	-36.80	peak
2	1538.281	4.12	26.95	38.39	39.24	31.92	74.00	-42.08	peak
3	4443.453	7.09	34.28	35.77	37.28	42.88	68.20	-25.32	peak
4	8106.200	10.30	36.50	36.68	39.54	49.66	74.00	-24.34	peak
5	12350.000	13.26	37.90	37.45	37.51	51.22	74.00	-22.78	peak
6	p17793.090	15.03	43.89	37.63	32.04	53.33	74.00	-20.67	peak



Unless otherwise agreed in writing, this document is issued by the Company subject to its General Conditions of Service printed overleaf, available on request or accessible at <https://www.sgs.com/en/Terms-and-Conditions>. Attention is drawn to the limitation of liability, indemnification and jurisdiction issues defined therein. Any holder of this document is advised that information contained hereon reflects the Company's findings at the time of its intervention only and within the limits of Client's instructions, if any. The Company's sole responsibility is to its Client and this document does not exonerate parties to a transaction from exercising all their rights and obligations under the transaction documents. This document cannot be reproduced except in full, without prior written approval of the Company. Any unauthorized alteration, forgery or falsification of the content or appearance of this document is unlawful and offenders may be prosecuted to the fullest extent of the law. Unless otherwise stated the results shown in this test report refer only to the sample(s) tested and such sample(s) are retained for 30 days only.

Attention: To check the authenticity of testing /inspection report & certificate, please contact us at telephone: (86-755) 8307 1443, or email: CN.Doccheck@sgs.com
 No.1 Workshop, M-10, Middle Section, Science & Technology Park, Nanshan District, Shenzhen, Guangdong, China 518057 t (86-755) 26012053 f (86-755) 26710594 www.sgs.com.cn
 中国·广东·深圳市南山区科技园中区M-10栋1号厂房 邮编: 518057 t (86-755) 26012053 f (86-755) 26710594 sgs.china@sgs.com

Test Mode: 25; Polarity: Vertical; Modulation:802.11a; Bandwidth:20MHz; Channel:middle

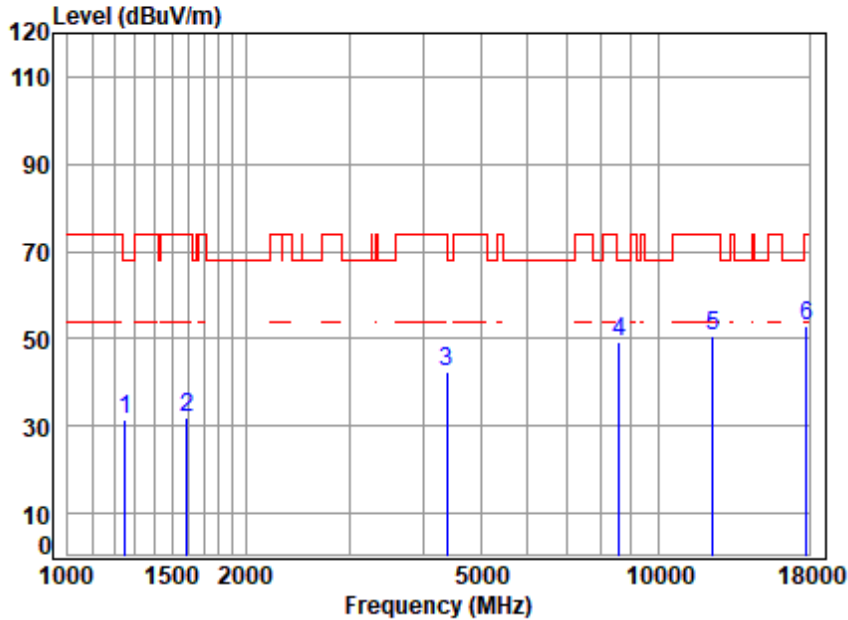

Site : chamber
 Condition: 3m VERTICAL
 Job No : 00955AT/00956AT
 Mode : 6175 TX RSE
 Note : 6E WIFI 11A

	Freq	Cable Loss	Ant Factor	Preamp Factor	Read Level	Level	Limit Line	Over Limit	Remark
	MHz	dB	dB/m	dB	dBuV	dBuV/m	dBuV/m	dB	
1	1249.269	3.67	25.09	38.35	40.89	31.30	68.20	-36.90	peak
2	1592.571	4.19	26.83	38.40	39.34	31.96	74.00	-42.04	peak
3	4392.376	7.05	34.74	35.80	36.38	42.37	74.00	-31.63	peak
4 p	8588.607	11.20	36.88	37.19	38.57	49.46	68.20	-18.74	peak
5	12350.000	13.26	37.90	37.45	36.74	50.45	74.00	-23.55	peak
6	17793.090	15.03	43.89	37.63	31.78	53.07	74.00	-20.93	peak



Unless otherwise agreed in writing, this document is issued by the Company subject to its General Conditions of Service printed overleaf, available on request or accessible at <https://www.sgs.com/en/Terms-and-Conditions>. Attention is drawn to the limitation of liability, indemnification and jurisdiction issues defined therein. Any holder of this document is advised that information contained hereon reflects the Company's findings at the time of its intervention only and within the limits of Client's instructions, if any. The Company's sole responsibility is to its Client and this document does not exonerate parties to a transaction from exercising all their rights and obligations under the transaction documents. This document cannot be reproduced except in full, without prior written approval of the Company. Any unauthorized alteration, forgery or falsification of the content or appearance of this document is unlawful and offenders may be prosecuted to the fullest extent of the law. Unless otherwise stated the results shown in this test report refer only to the sample(s) tested and such sample(s) are retained for 30 days only.

Test Mode: 25; Polarity: Horizontal; Modulation:802.11a; Bandwidth:20MHz; Channel:High

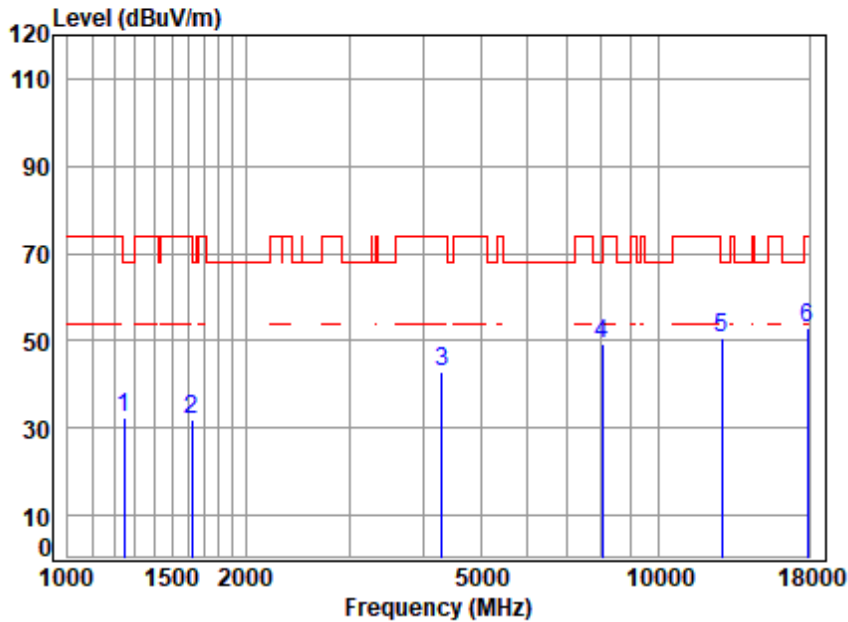

Site : chamber
 Condition: 3m HORIZONTAL
 Job No : 00955AT/00956AT
 Mode : 6395 TX RSE
 Note : 6E WIFI 11A

	Freq	Cable Loss	Ant Factor	Preamp Factor	Read Level	Level	Limit Line	Over Limit	Remark
	MHz	dB	dB/m	dB	dBuV	dBuV/m	dBuV/m	dB	
1	1245.663	3.66	25.04	38.35	41.92	32.27	68.20	-35.93	peak
2	1625.121	4.23	26.55	38.41	39.74	32.11	74.00	-41.89	peak
3	4304.400	6.99	34.04	35.87	37.58	42.74	74.00	-31.26	peak
4	8036.214	10.17	36.40	36.60	39.47	49.44	74.00	-24.56	peak
5	12790.000	13.46	38.10	37.33	36.24	50.47	68.20	-17.73	peak
6	17896.250	15.09	43.90	37.64	31.48	52.83	74.00	-21.17	peak



Unless otherwise agreed in writing, this document is issued by the Company subject to its General Conditions of Service printed overleaf, available on request or accessible at <https://www.sgs.com/en/Terms-and-Conditions>. Attention is drawn to the limitation of liability, indemnification and jurisdiction issues defined therein. Any holder of this document is advised that information contained hereon reflects the Company's findings at the time of its intervention only and within the limits of Client's instructions, if any. The Company's sole responsibility is to its Client and this document does not exonerate parties to a transaction from exercising all their rights and obligations under the transaction documents. This document cannot be reproduced except in full, without prior written approval of the Company. Any unauthorized alteration, forgery or falsification of the content or appearance of this document is unlawful and offenders may be prosecuted to the fullest extent of the law. Unless otherwise stated the results shown in this test report refer only to the sample(s) tested and such sample(s) are retained for 30 days only.

Attention: To check the authenticity of testing /inspection report & certificate, please contact us at telephone: (86-755) 8307 1443, or email: CN.Doccheck@sgs.com
 No.1 Workshop, M-10, Middle Section, Science & Technology Park, Nanshan District, Shenzhen, Guangdong, China 518057 t (86-755) 26012053 f (86-755) 26710594 www.sgs.com.cn
 中国·广东·深圳市南山区科技园中区M-10栋1号厂房 邮编: 518057 t (86-755) 26012053 f (86-755) 26710594 sgs.china@sgs.com

Test Mode: 25; Polarity: Vertical; Modulation:802.11a; Bandwidth:20MHz; Channel:High

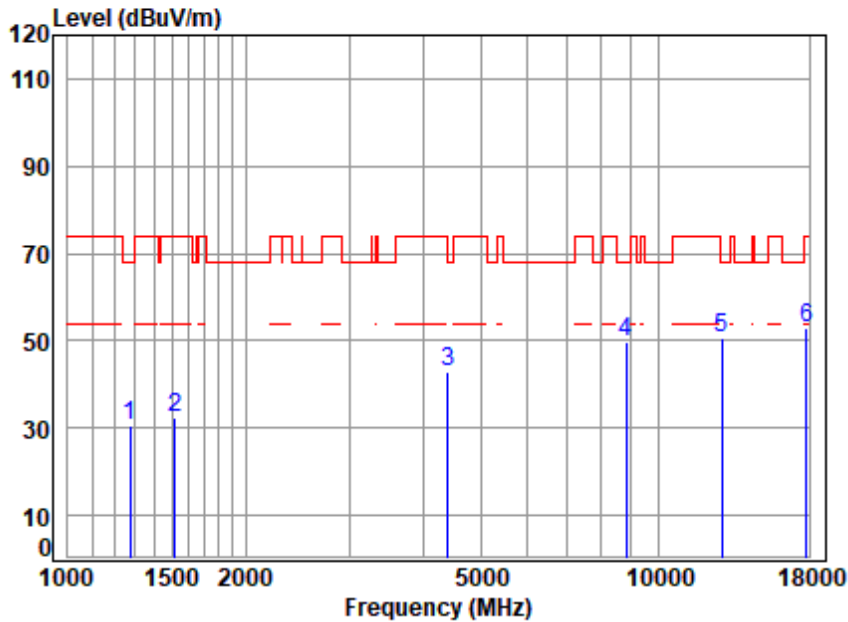

Site : chamber
 Condition: 3m VERTICAL
 Job No : 00955AT/00956AT
 Mode : 6395 TX RSE
 Note : 6E WIFI 11A

	Freq	Cable Loss	Ant Factor	Preamp Factor	Read Level	Level	Limit Line	Over Limit	Remark
	MHz	dB	dB/m	dB	dBuV	dBuV/m	dBuV/m	dB	
1	1274.802	3.71	24.95	38.35	40.06	30.37	68.20	-37.83	peak
2	1516.210	4.08	26.86	38.39	40.05	32.60	74.00	-41.40	peak
3	4405.090	7.06	34.74	35.79	36.92	42.93	68.20	-25.27	peak
4	8814.957	11.60	37.13	37.42	38.49	49.80	68.20	-18.40	peak
5	12790.000	13.46	38.10	37.33	36.62	50.85	68.20	-17.35	peak
6	17793.090	15.03	43.89	37.63	31.76	53.05	74.00	-20.95	peak



Unless otherwise agreed in writing, this document is issued by the Company subject to its General Conditions of Service printed overleaf, available on request or accessible at <https://www.sgs.com/en/Terms-and-Conditions>. Attention is drawn to the limitation of liability, indemnification and jurisdiction issues defined therein. Any holder of this document is advised that information contained hereon reflects the Company's findings at the time of its intervention only and within the limits of Client's instructions, if any. The Company's sole responsibility is to its Client and this document does not exonerate parties to a transaction from exercising all their rights and obligations under the transaction documents. This document cannot be reproduced except in full, without prior written approval of the Company. Any unauthorized alteration, forgery or falsification of the content or appearance of this document is unlawful and offenders may be prosecuted to the fullest extent of the law. Unless otherwise stated the results shown in this test report refer only to the sample(s) tested and such sample(s) are retained for 30 days only.

Test Mode: 25; Polarity: Horizontal; Modulation:802.11ac; Bandwidth:20MHz; Channel:Low

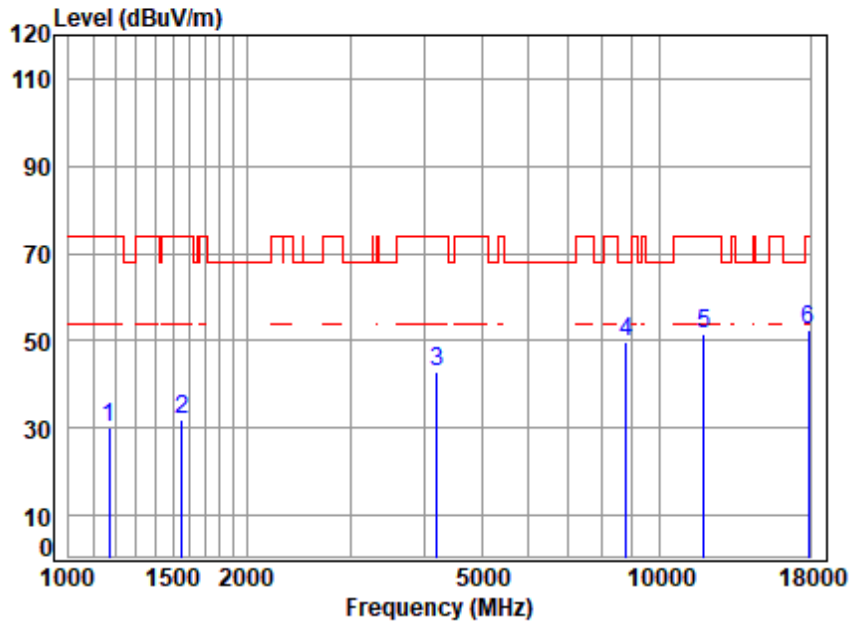

Site : chamber
 Condition: 3m HORIZONTAL
 Job No : 00955AT/00956AT
 Mode : 5955 TX RSE
 Note : 6E WIFI 11AC20

	Freq	Cable Loss	Ant Factor	Preamp Factor	Read Level	Level	Limit Line	Over Limit	Remark
	MHz	dB	dB/m	dB	dBuV	dBuV/m	dBuV/m	dB	
1	1168.920	3.53	24.09	38.33	40.72	30.01	74.00	-43.99	peak
2	1556.169	4.14	26.98	38.40	39.28	32.00	74.00	-42.00	peak
3	4206.011	6.93	33.80	35.94	38.30	43.09	74.00	-30.91	peak
4 p	8789.516	11.55	37.06	37.40	38.42	49.63	68.20	-18.57	peak
5	11910.000	13.07	37.71	37.58	38.25	51.45	74.00	-22.55	peak
6	17865.000	15.07	43.90	37.64	31.08	52.41	74.00	-21.59	peak



Unless otherwise agreed in writing, this document is issued by the Company subject to its General Conditions of Service printed overleaf, available on request or accessible at <https://www.sgs.com/en/Terms-and-Conditions>. Attention is drawn to the limitation of liability, indemnification and jurisdiction issues defined therein. Any holder of this document is advised that information contained hereon reflects the Company's findings at the time of its intervention only and within the limits of Client's instructions, if any. The Company's sole responsibility is to its Client and this document does not exonerate parties to a transaction from exercising all their rights and obligations under the transaction documents. This document cannot be reproduced except in full, without prior written approval of the Company. Any unauthorized alteration, forgery or falsification of the content or appearance of this document is unlawful and offenders may be prosecuted to the fullest extent of the law. Unless otherwise stated the results shown in this test report refer only to the sample(s) tested and such sample(s) are retained for 30 days only.

Test Mode: 25; Polarity: Vertical; Modulation:802.11ac; Bandwidth:20MHz; Channel:Low

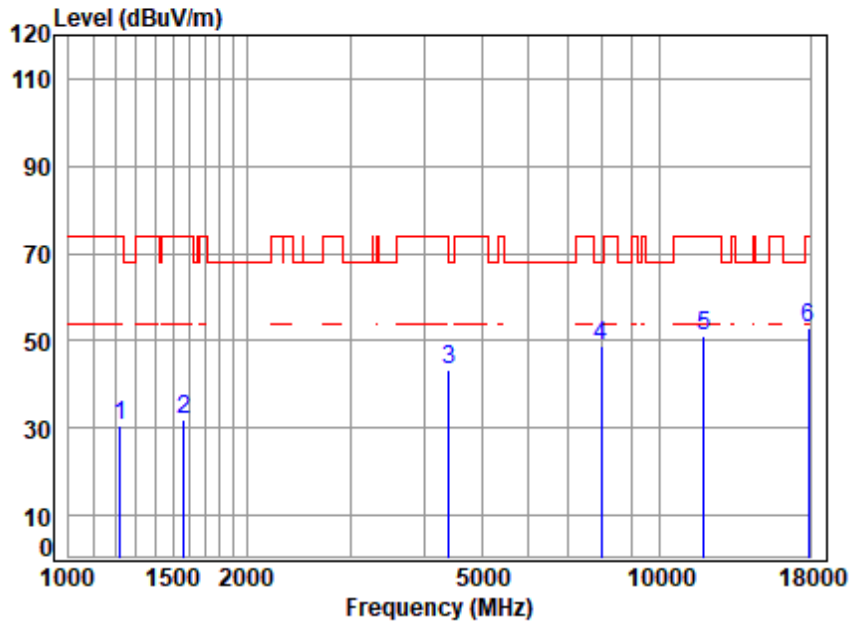

Site : chamber
 Condition: 3m VERTICAL
 Job No : 00955AT/00956AT
 Mode : 5955 TX RSE
 Note : 6E WIFI 11AC20

	Freq	Cable Loss	Ant Factor	Preamp Factor	Read Level	Level	Limit Line	Over Limit	Remark
	MHz	dB	dB/m	dB	dBuV	dBuV/m	dBuV/m	dB	
1	1220.714	3.62	24.69	38.34	40.57	30.54	74.00	-43.46	peak
2	1565.191	4.15	26.94	38.40	39.29	31.98	74.00	-42.02	peak
3	4405.090	7.06	34.74	35.79	37.26	43.27	68.20	-24.93	peak
4	7989.893	10.09	36.40	36.55	38.99	48.93	68.20	-19.27	peak
5	11910.000	13.07	37.71	37.58	37.68	50.88	74.00	-23.12	peak
6	17865.000	15.07	43.90	37.64	31.48	52.81	74.00	-21.19	peak



Unless otherwise agreed in writing, this document is issued by the Company subject to its General Conditions of Service printed overleaf, available on request or accessible at <https://www.sgs.com/en/Terms-and-Conditions>. Attention is drawn to the limitation of liability, indemnification and jurisdiction issues defined therein. Any holder of this document is advised that information contained hereon reflects the Company's findings at the time of its intervention only and within the limits of Client's instructions, if any. The Company's sole responsibility is to its Client and this document does not exonerate parties to a transaction from exercising all their rights and obligations under the transaction documents. This document cannot be reproduced except in full, without prior written approval of the Company. Any unauthorized alteration, forgery or falsification of the content or appearance of this document is unlawful and offenders may be prosecuted to the fullest extent of the law. Unless otherwise stated the results shown in this test report refer only to the sample(s) tested and such sample(s) are retained for 30 days only.

Test Mode: 25; Polarity: Horizontal; Modulation:802.11ac; Bandwidth:20MHz; Channel:middle

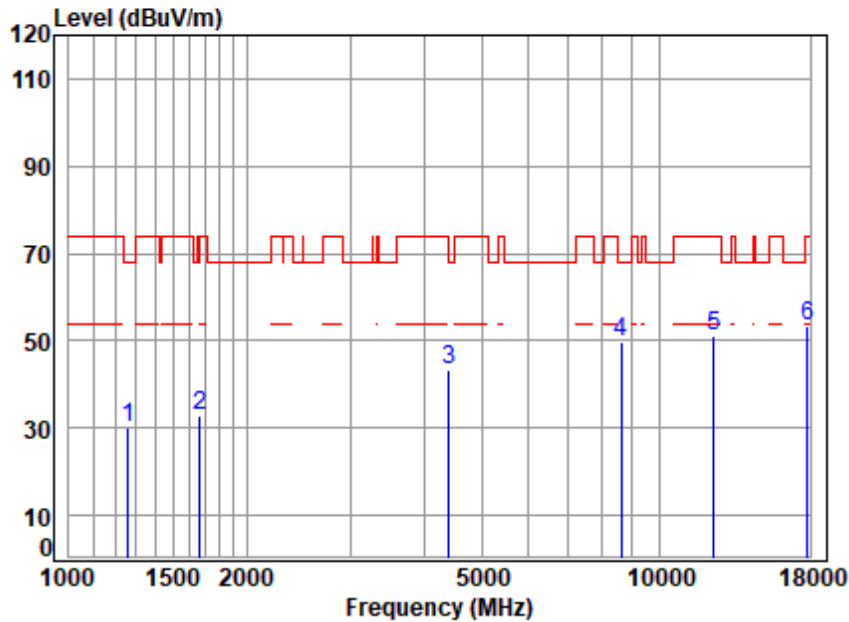

Site : chamber
 Condition: 3m HORIZONTAL
 Job No : 00955AT/00956AT
 Mode : 6175 TX RSE
 Note : 6E WIFI 11AC20

	Freq	Cable Loss	Ant Factor	Preamp Factor	Read Level	Level	Limit Line	Over Limit	Remark
	MHz	dB	dB/m	dB	dBuV	dBuV/m	dBuV/m	dB	
1	1260.149	3.69	25.04	38.35	39.87	30.25	68.20	-37.95	peak
2	1667.951	4.29	26.26	38.41	40.51	32.65	74.00	-41.35	peak
3	4405.090	7.06	34.74	35.79	37.42	43.43	68.20	-24.77	peak
4 p	8613.468	11.24	36.90	37.22	38.74	49.66	68.20	-18.54	peak
5	12350.000	13.26	37.90	37.45	37.40	51.11	74.00	-22.89	peak
6	17793.090	15.03	43.89	37.63	32.07	53.36	74.00	-20.64	peak



Unless otherwise agreed in writing, this document is issued by the Company subject to its General Conditions of Service printed overleaf, available on request or accessible at <https://www.sgs.com/en/Terms-and-Conditions>. Attention is drawn to the limitation of liability, indemnification and jurisdiction issues defined therein. Any holder of this document is advised that information contained hereon reflects the Company's findings at the time of its intervention only and within the limits of Client's instructions, if any. The Company's sole responsibility is to its Client and this document does not exonerate parties to a transaction from exercising all their rights and obligations under the transaction documents. This document cannot be reproduced except in full, without prior written approval of the Company. Any unauthorized alteration, forgery or falsification of the content or appearance of this document is unlawful and offenders may be prosecuted to the fullest extent of the law. Unless otherwise stated the results shown in this test report refer only to the sample(s) tested and such sample(s) are retained for 30 days only.

Test Mode: 25; Polarity: Vertical; Modulation:802.11ac; Bandwidth:20MHz; Channel:middle

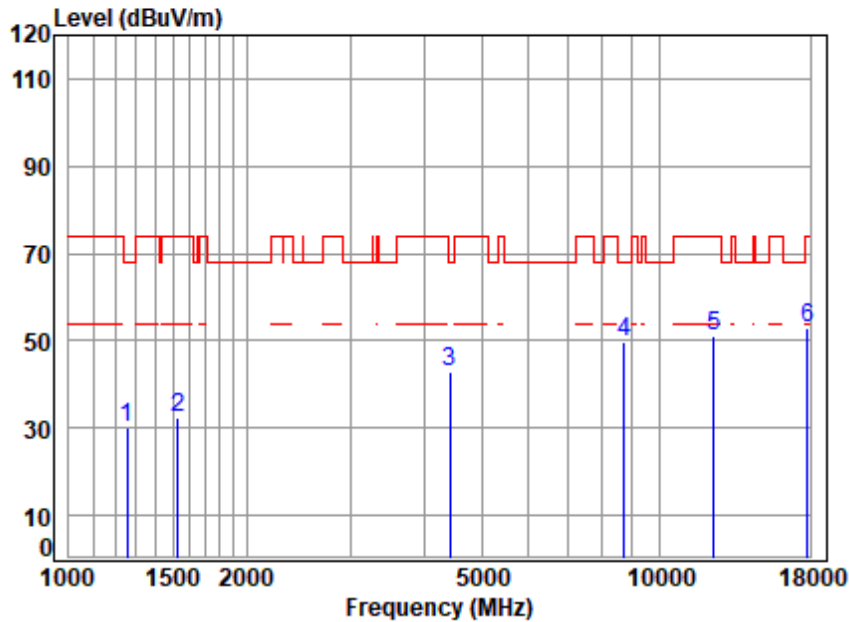

Site : chamber
 Condition: 3m VERTICAL
 Job No : 00955AT/00956AT
 Mode : 6175 TX RSE
 Note : 6E WIFI 11AC20

	Freq	Cable Loss	Ant Factor	Preamp Factor	Read Level	Level	Limit Line	Over Limit	Remark
	MHz	dB	dB/m	dB	dBuV	dBuV/m	dBuV/m	dB	
1	1256.512	3.68	25.06	38.35	39.85	30.24	68.20	-37.96	peak
2	1529.414	4.10	26.92	38.39	39.76	32.39	74.00	-41.61	peak
3	4417.841	7.07	34.59	35.78	36.92	42.80	68.20	-25.40	peak
4	8713.630	11.42	36.90	37.32	38.76	49.76	68.20	-18.44	peak
5	12350.000	13.26	37.90	37.45	37.52	51.23	74.00	-22.77	peak
6	17793.090	15.03	43.89	37.63	31.65	52.94	74.00	-21.06	peak



Unless otherwise agreed in writing, this document is issued by the Company subject to its General Conditions of Service printed overleaf, available on request or accessible at <https://www.sgs.com/en/Terms-and-Conditions>. Attention is drawn to the limitation of liability, indemnification and jurisdiction issues defined therein. Any holder of this document is advised that information contained hereon reflects the Company's findings at the time of its intervention only and within the limits of Client's instructions, if any. The Company's sole responsibility is to its Client and this document does not exonerate parties to a transaction from exercising all their rights and obligations under the transaction documents. This document cannot be reproduced except in full, without prior written approval of the Company. Any unauthorized alteration, forgery or falsification of the content or appearance of this document is unlawful and offenders may be prosecuted to the fullest extent of the law. Unless otherwise stated the results shown in this test report refer only to the sample(s) tested and such sample(s) are retained for 30 days only.

Test Mode: 25; Polarity: Horizontal; Modulation:802.11ac; Bandwidth:20MHz; Channel:High

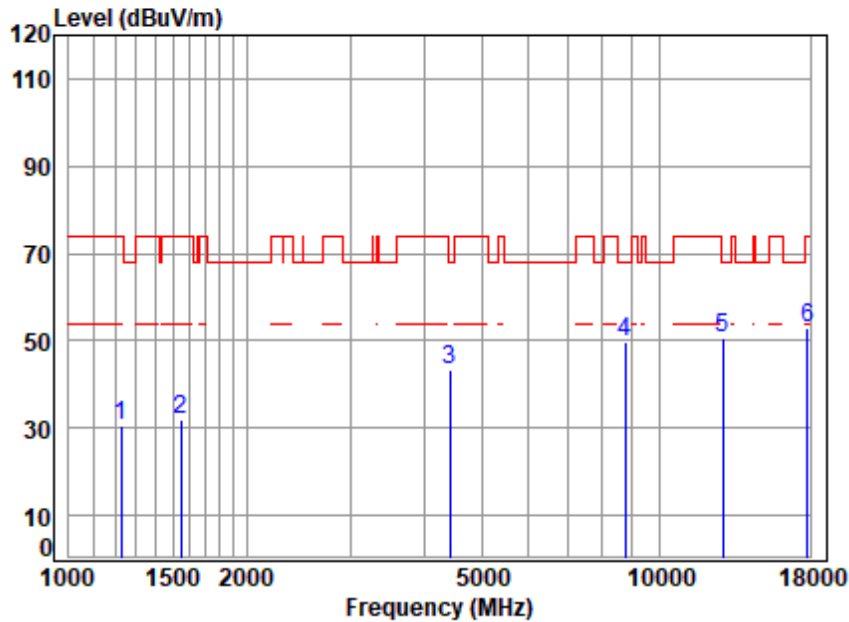

Site : chamber
 Condition: 3m HORIZONTAL
 Job No : 00955AT/00956AT
 Mode : 6395 TX RSE
 Note : 6E WIFI 11AC20

	Cable	Ant	Preamp	Read	Limit	Over		
Freq	Loss	Factor	Factor	Level	Level	Line	Limit	Remark
MHz	dB	dB/m	dB	dBuV	dBuV/m	dBuV/m	dB	
1	1227.791	3.63	24.79	38.34	40.52	30.60	74.00	-43.40 peak
2	1547.199	4.13	26.99	38.39	39.12	31.85	74.00	-42.15 peak
3	4417.841	7.07	34.59	35.78	37.37	43.25	68.20	-24.95 peak
4	8764.146	11.51	36.96	37.37	38.67	49.77	68.20	-18.43 peak
5	12790.000	13.46	38.10	37.33	36.53	50.76	68.20	-17.44 peak
6	17793.090	15.03	43.89	37.63	31.84	53.13	74.00	-20.87 peak



Unless otherwise agreed in writing, this document is issued by the Company subject to its General Conditions of Service printed overleaf, available on request or accessible at <https://www.sgs.com/en/Terms-and-Conditions>. Attention is drawn to the limitation of liability, indemnification and jurisdiction issues defined therein. Any holder of this document is advised that information contained hereon reflects the Company's findings at the time of its intervention only and within the limits of Client's instructions, if any. The Company's sole responsibility is to its Client and this document does not exonerate parties to a transaction from exercising all their rights and obligations under the transaction documents. This document cannot be reproduced except in full, without prior written approval of the Company. Any unauthorized alteration, forgery or falsification of the content or appearance of this document is unlawful and offenders may be prosecuted to the fullest extent of the law. Unless otherwise stated the results shown in this test report refer only to the sample(s) tested and such sample(s) are retained for 30 days only.

Attention: To check the authenticity of testing /inspection report & certificate, please contact us at telephone: (86-755) 8307 1443, or email: CN.Doccheck@sgs.com
 No.1 Workshop, M-10, Middle Section, Science & Technology Park, Nanshan District, Shenzhen, Guangdong, China 518057 t (86-755) 26012053 f (86-755) 26710594 www.sgs.com.cn
 中国·广东·深圳市南山区科技园中区M-10栋1号厂房 邮编: 518057 t (86-755) 26012053 f (86-755) 26710594 sgs.china@sgs.com

Test Mode: 25; Polarity: Vertical; Modulation:802.11ac; Bandwidth:20MHz; Channel:High

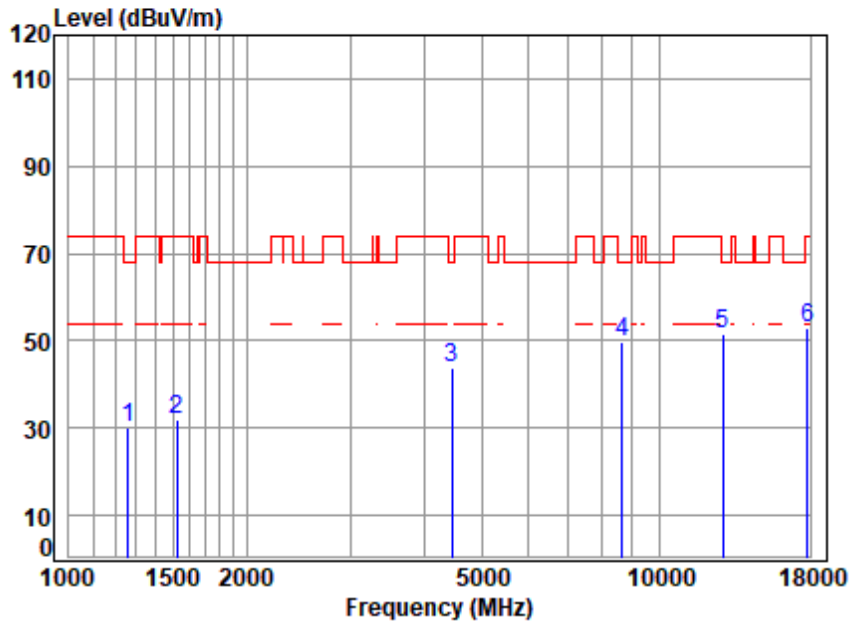

Site : chamber
 Condition: 3m VERTICAL
 Job No : 00955AT/00956AT
 Mode : 6395 TX RSE
 Note : 6E WIFI 11AC20

	Freq	Cable Loss	Ant Factor	Preamp Factor	Read Level	Level	Limit Line	Over Limit	Remark
	MHz	dB	dB/m	dB	dBuV	dBuV/m	dBuV/m	dB	
1	1260.149	3.69	25.04	38.35	39.64	30.02	68.20	-38.18	peak
2	1525.000	4.10	26.90	38.39	39.50	32.11	74.00	-41.89	peak
3	4456.315	7.09	34.12	35.76	38.22	43.67	68.20	-24.53	peak
4	8638.399	11.29	36.90	37.24	38.84	49.79	68.20	-18.41	peak
5	12790.000	13.46	38.10	37.33	37.28	51.51	68.20	-16.69	peak
6	17844.590	15.06	43.90	37.64	31.40	52.72	74.00	-21.28	peak



Unless otherwise agreed in writing, this document is issued by the Company subject to its General Conditions of Service printed overleaf, available on request or accessible at <https://www.sgs.com/en/Terms-and-Conditions>. Attention is drawn to the limitation of liability, indemnification and jurisdiction issues defined therein. Any holder of this document is advised that information contained hereon reflects the Company's findings at the time of its intervention only and within the limits of Client's instructions, if any. The Company's sole responsibility is to its Client and this document does not exonerate parties to a transaction from exercising all their rights and obligations under the transaction documents. This document cannot be reproduced except in full, without prior written approval of the Company. Any unauthorized alteration, forgery or falsification of the content or appearance of this document is unlawful and offenders may be prosecuted to the fullest extent of the law. Unless otherwise stated the results shown in this test report refer only to the sample(s) tested and such sample(s) are retained for 30 days only.

Attention: To check the authenticity of testing /inspection report & certificate, please contact us at telephone: (86-755) 8307 1443, or email: CN.Doccheck@sgs.com

Test Mode: 25; Polarity: Horizontal; Modulation:802.11ac; Bandwidth:40MHz; Channel:Low

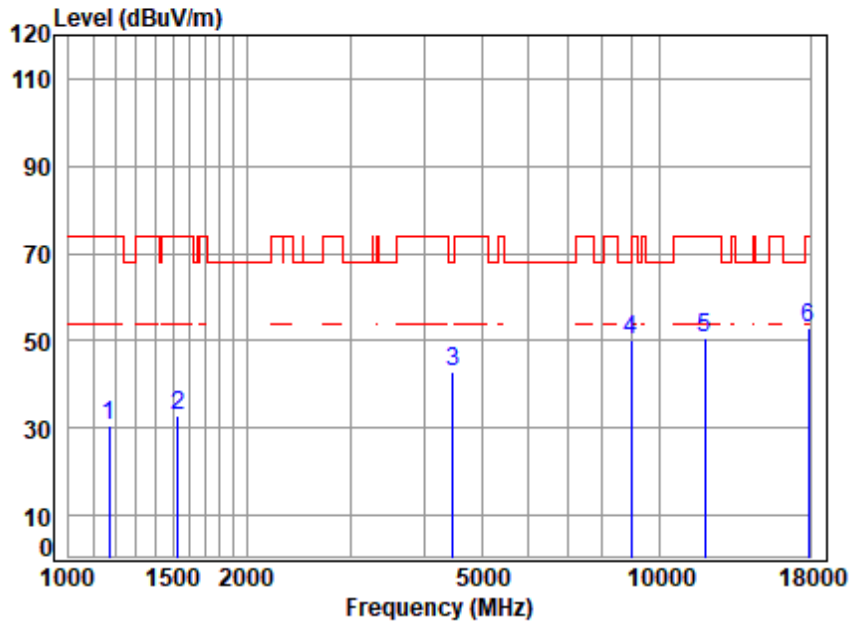

Site : chamber
 Condition: 3m HORIZONTAL
 Job No : 00955AT/00956AT
 Mode : 5965 TX RSE
 Note : 6E WIFI 11AC40

	Freq	Cable Loss	Ant Factor	Preamp Factor	Read Level	Limit Level	Over Limit	Remark
	MHz	dB	dB/m	dB	dBuV	dBuV/m	dBuV/m	dB
1	1168.920	3.53	24.09	38.33	41.11	30.40	74.00	-43.60 peak
2	1529.414	4.10	26.92	38.39	40.19	32.82	74.00	-41.18 peak
3	4469.214	7.10	33.97	35.75	37.68	43.00	68.20	-25.20 peak
4 p	8943.274	11.82	37.03	37.55	38.95	50.25	68.20	-17.95 peak
5	11930.000	13.08	37.73	37.57	37.62	50.86	74.00	-23.14 peak
6	17895.000	15.09	43.90	37.64	31.60	52.95	74.00	-21.05 peak



Unless otherwise agreed in writing, this document is issued by the Company subject to its General Conditions of Service printed overleaf, available on request or accessible at <https://www.sgs.com/en/Terms-and-Conditions>. Attention is drawn to the limitation of liability, indemnification and jurisdiction issues defined therein. Any holder of this document is advised that information contained hereon reflects the Company's findings at the time of its intervention only and within the limits of Client's instructions, if any. The Company's sole responsibility is to its Client and this document does not exonerate parties to a transaction from exercising all their rights and obligations under the transaction documents. This document cannot be reproduced except in full, without prior written approval of the Company. Any unauthorized alteration, forgery or falsification of the content or appearance of this document is unlawful and offenders may be prosecuted to the fullest extent of the law. Unless otherwise stated the results shown in this test report refer only to the sample(s) tested and such sample(s) are retained for 30 days only.

Test Mode: 25; Polarity: Vertical; Modulation:802.11ac; Bandwidth:40MHz; Channel:Low

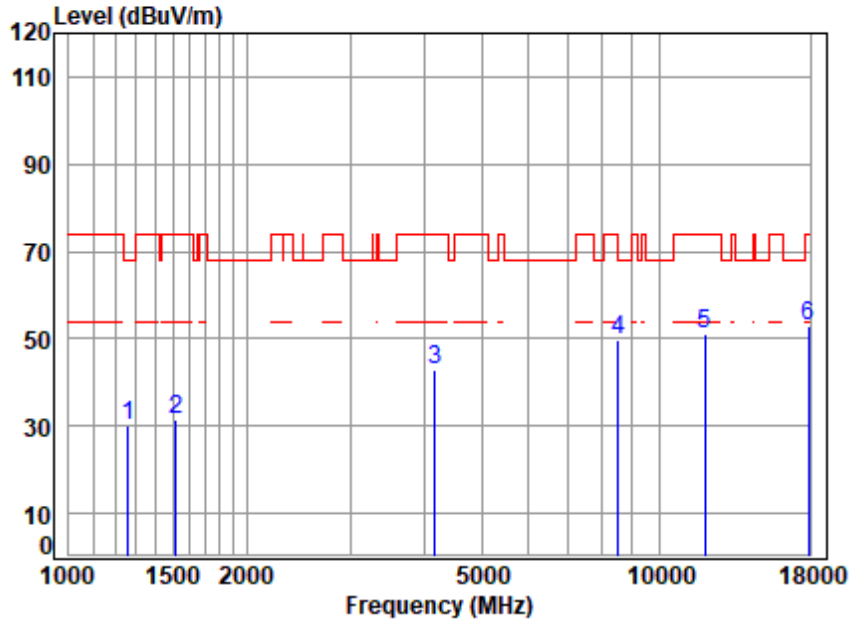

Site : chamber
 Condition: 3m VERTICAL
 Job No : 00955AT/00956AT
 Mode : 5965 TX RSE
 Note : 6E WIFI 11AC40

	Freq	Cable Loss	Ant Factor	Preamp Factor	Read Level	Level	Limit Line	Over Limit	Remark
	MHz	dB	dB/m	dB	dBuV	dBuV/m	dBuV/m	dB	
1	1260.149	3.69	25.04	38.35	39.84	30.22	68.20	-37.98	peak
2	1516.210	4.08	26.86	38.39	39.04	31.59	74.00	-42.41	peak
3	4169.698	6.90	33.80	35.97	38.13	42.86	74.00	-31.14	peak
4	8514.456	11.06	36.73	37.12	39.00	49.67	68.20	-18.53	peak
5	11930.000	13.08	37.73	37.57	37.94	51.18	74.00	-22.82	peak
6	17895.000	15.09	43.90	37.64	31.47	52.82	74.00	-21.18	peak



Unless otherwise agreed in writing, this document is issued by the Company subject to its General Conditions of Service printed overleaf, available on request or accessible at <https://www.sgs.com/en/Terms-and-Conditions>. Attention is drawn to the limitation of liability, indemnification and jurisdiction issues defined therein. Any holder of this document is advised that information contained hereon reflects the Company's findings at the time of its intervention only and within the limits of Client's instructions, if any. The Company's sole responsibility is to its Client and this document does not exonerate parties to a transaction from exercising all their rights and obligations under the transaction documents. This document cannot be reproduced except in full, without prior written approval of the Company. Any unauthorized alteration, forgery or falsification of the content or appearance of this document is unlawful and offenders may be prosecuted to the fullest extent of the law. Unless otherwise stated the results shown in this test report refer only to the sample(s) tested and such sample(s) are retained for 30 days only.

Test Mode: 25; Polarity: Horizontal; Modulation:802.11ac; Bandwidth:40MHz; Channel:middle

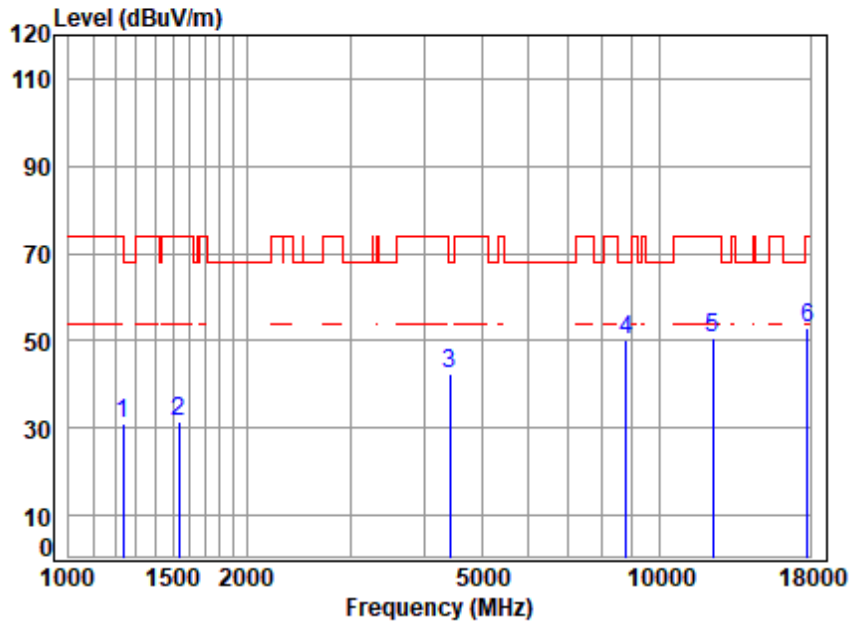

Site : chamber
 Condition: 3m HORIZONTAL
 Job No : 00955AT/00956AT
 Mode : 6165 TX RSE
 Note : 6E WIFI 11AC40

	Freq	Cable Loss	Ant Factor	Preamp Factor	Read Level	Level	Limit Line	Over Limit	Remark
	MHz	dB	dB/m	dB	dBuV	dBuV/m	dBuV/m	dB	
1	1238.483	3.65	24.94	38.35	40.59	30.83	74.00	-43.17	peak
2	1538.281	4.12	26.95	38.39	38.91	31.59	74.00	-42.41	peak
3	4417.841	7.07	34.59	35.78	36.45	42.33	68.20	-25.87	peak
4 p	8789.516	11.55	37.06	37.40	38.88	50.09	68.20	-18.11	peak
5	12330.000	13.25	37.90	37.46	37.03	50.72	74.00	-23.28	peak
6	17844.590	15.06	43.90	37.64	31.74	53.06	74.00	-20.94	peak



Unless otherwise agreed in writing, this document is issued by the Company subject to its General Conditions of Service printed overleaf, available on request or accessible at <https://www.sgs.com/en/Terms-and-Conditions>. Attention is drawn to the limitation of liability, indemnification and jurisdiction issues defined therein. Any holder of this document is advised that information contained hereon reflects the Company's findings at the time of its intervention only and within the limits of Client's instructions, if any. The Company's sole responsibility is to its Client and this document does not exonerate parties to a transaction from exercising all their rights and obligations under the transaction documents. This document cannot be reproduced except in full, without prior written approval of the Company. Any unauthorized alteration, forgery or falsification of the content or appearance of this document is unlawful and offenders may be prosecuted to the fullest extent of the law. Unless otherwise stated the results shown in this test report refer only to the sample(s) tested and such sample(s) are retained for 30 days only.

Attention: To check the authenticity of testing /inspection report & certificate, please contact us at telephone: (86-755) 8307 1443, or email: CN.Doccheck@sgs.com
 No.1 Workshop, M-10, Middle Section, Science & Technology Park, Nanshan District, Shenzhen, Guangdong, China 518057 t (86-755) 26012053 f (86-755) 26710594 www.sgs.com.cn
 中国·广东·深圳市南山区科技园中区M-10栋1号厂房 邮编: 518057 t (86-755) 26012053 f (86-755) 26710594 sgs.china@sgs.com

Test Mode: 25; Polarity: Vertical; Modulation:802.11ac; Bandwidth:40MHz; Channel:middle

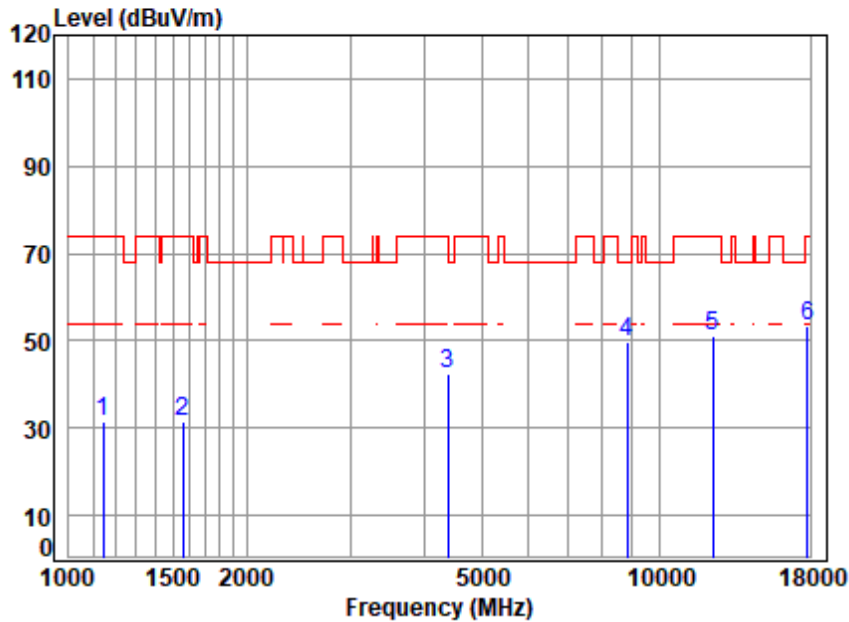

Site : chamber
 Condition: 3m VERTICAL
 Job No : 00955AT/00956AT
 Mode : 6165 TX RSE
 Note : 6E WIFI 11AC40

	Freq	Cable Loss	Ant Factor	Preamp Factor	Read Level	Level	Limit Line	Over Limit	Remark
	MHz	dB	dB/m	dB	dBuV	dBuV/m	dBuV/m	dB	
1	1145.507	3.48	23.88	38.33	42.45	31.48	74.00	-42.52	peak
2	1560.673	4.15	26.96	38.40	38.81	31.52	74.00	-42.48	peak
3	4392.376	7.05	34.74	35.80	36.23	42.22	74.00	-31.78	peak
4 p	8814.957	11.60	37.13	37.42	38.54	49.85	68.20	-18.35	peak
5	12330.000	13.25	37.90	37.46	37.37	51.06	74.00	-22.94	peak
6	17844.590	15.06	43.90	37.64	32.07	53.39	74.00	-20.61	peak



Unless otherwise agreed in writing, this document is issued by the Company subject to its General Conditions of Service printed overleaf, available on request or accessible at <https://www.sgs.com/en/Terms-and-Conditions>. Attention is drawn to the limitation of liability, indemnification and jurisdiction issues defined therein. Any holder of this document is advised that information contained hereon reflects the Company's findings at the time of its intervention only and within the limits of Client's instructions, if any. The Company's sole responsibility is to its Client and this document does not exonerate parties to a transaction from exercising all their rights and obligations under the transaction documents. This document cannot be reproduced except in full, without prior written approval of the Company. Any unauthorized alteration, forgery or falsification of the content or appearance of this document is unlawful and offenders may be prosecuted to the fullest extent of the law. Unless otherwise stated the results shown in this test report refer only to the sample(s) tested and such sample(s) are retained for 30 days only.

Attention: To check the authenticity of testing /inspection report & certificate, please contact us at telephone: (86-755) 8307 1443, or email: CN.Doccheck@sgs.com
 No.1 Workshop, M-10, Middle Section, Science & Technology Park, Nanshan District, Shenzhen, Guangdong, China 518057 t (86-755) 26012053 f (86-755) 26710594 www.sgs.com.cn
 中国·广东·深圳市南山区科技园中区M-10栋1号厂房 邮编: 518057 t (86-755) 26012053 f (86-755) 26710594 sgs.china@sgs.com

Test Mode: 25; Polarity: Horizontal; Modulation:802.11ac; Bandwidth:40MHz; Channel:High

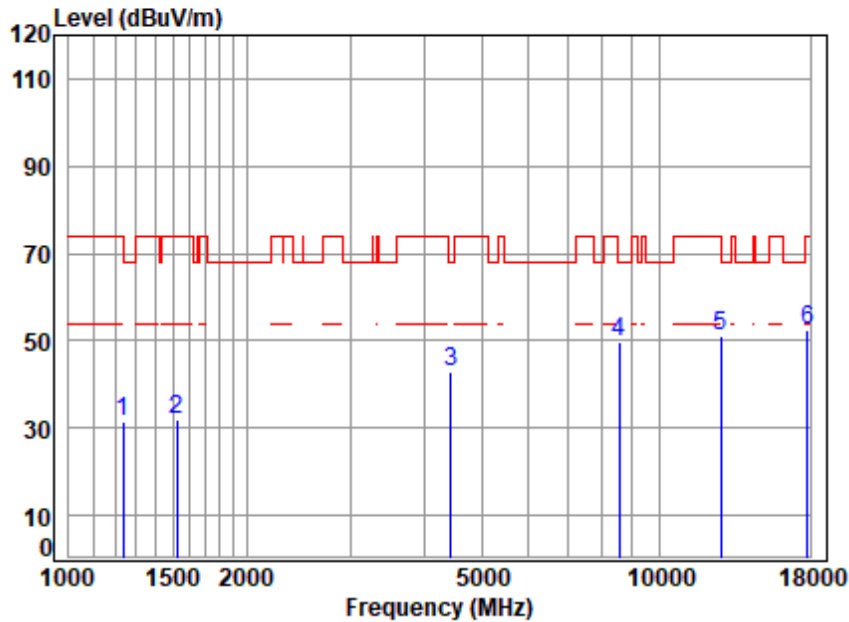

Site : chamber
 Condition: 3m HORIZONTAL
 Job No : 00955AT/00956AT
 Mode : 6365 TX RSE
 Note : 6E WIFI 11AC40

	Freq	Cable Loss	Ant Factor	Preamp Factor	Read Level	Level	Limit Line	Over Limit	Remark
	MHz	dB	dB/m	dB	dBuV	dBuV/m	dBuV/m	dB	
1	1238.483	3.65	24.94	38.35	41.12	31.36	74.00	-42.64	peak
2	1525.000	4.10	26.90	38.39	39.27	31.88	74.00	-42.12	peak
3	4443.453	7.09	34.28	35.77	37.09	42.69	68.20	-25.51	peak
4	8539.102	11.11	36.78	37.14	38.80	49.55	68.20	-18.65	peak
5	12730.000	13.43	38.10	37.34	37.10	51.29	68.20	-16.91	peak
6	17844.590	15.06	43.90	37.64	31.28	52.60	74.00	-21.40	peak



Unless otherwise agreed in writing, this document is issued by the Company subject to its General Conditions of Service printed overleaf, available on request or accessible at <https://www.sgs.com/en/Terms-and-Conditions>. Attention is drawn to the limitation of liability, indemnification and jurisdiction issues defined therein. Any holder of this document is advised that information contained hereon reflects the Company's findings at the time of its intervention only and within the limits of Client's instructions, if any. The Company's sole responsibility is to its Client and this document does not exonerate parties to a transaction from exercising all their rights and obligations under the transaction documents. This document cannot be reproduced except in full, without prior written approval of the Company. Any unauthorized alteration, forgery or falsification of the content or appearance of this document is unlawful and offenders may be prosecuted to the fullest extent of the law. Unless otherwise stated the results shown in this test report refer only to the sample(s) tested and such sample(s) are retained for 30 days only.

Test Mode: 25; Polarity: Vertical; Modulation:802.11ac; Bandwidth:40MHz; Channel:High

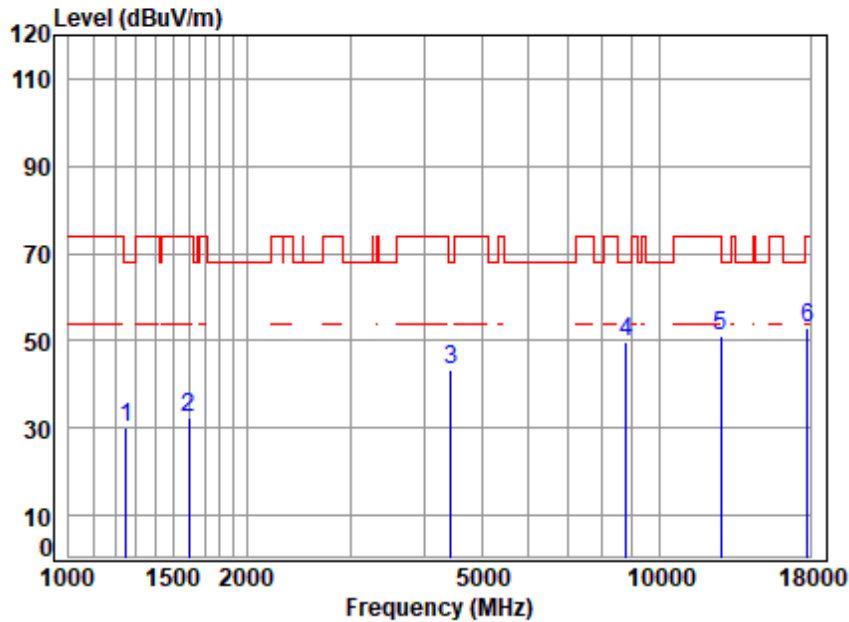

Site : chamber
 Condition: 3m VERTICAL
 Job No : 00955AT/00956AT
 Mode : 6365 TX RSE
 Note : 6E WIFI 11AC40

	Freq	Cable Loss	Ant Factor	Preamp Factor	Read Level	Level	Limit Line	Over Limit	Remark
	MHz	dB	dB/m	dB	dBuV	dBuV/m	dBuV/m	dB	
1	1252.885	3.67	25.08	38.35	39.92	30.32	68.20	-37.88	peak
2	1597.181	4.20	26.81	38.40	39.63	32.24	74.00	-41.76	peak
3	4443.453	7.09	34.28	35.77	37.92	43.52	68.20	-24.68	peak
4	8789.516	11.55	37.06	37.40	38.41	49.62	68.20	-18.58	peak
5	12730.000	13.43	38.10	37.34	36.70	50.89	68.20	-17.31	peak
6	17844.590	15.06	43.90	37.64	31.52	52.84	74.00	-21.16	peak



Unless otherwise agreed in writing, this document is issued by the Company subject to its General Conditions of Service printed overleaf, available on request or accessible at <https://www.sgs.com/en/Terms-and-Conditions>. Attention is drawn to the limitation of liability, indemnification and jurisdiction issues defined therein. Any holder of this document is advised that information contained hereon reflects the Company's findings at the time of its intervention only and within the limits of Client's instructions, if any. The Company's sole responsibility is to its Client and this document does not exonerate parties to a transaction from exercising all their rights and obligations under the transaction documents. This document cannot be reproduced except in full, without prior written approval of the Company. Any unauthorized alteration, forgery or falsification of the content or appearance of this document is unlawful and offenders may be prosecuted to the fullest extent of the law. Unless otherwise stated the results shown in this test report refer only to the sample(s) tested and such sample(s) are retained for 30 days only.

Test Mode: 25; Polarity: Horizontal; Modulation:802.11ac; Bandwidth:80MHz; Channel:Low

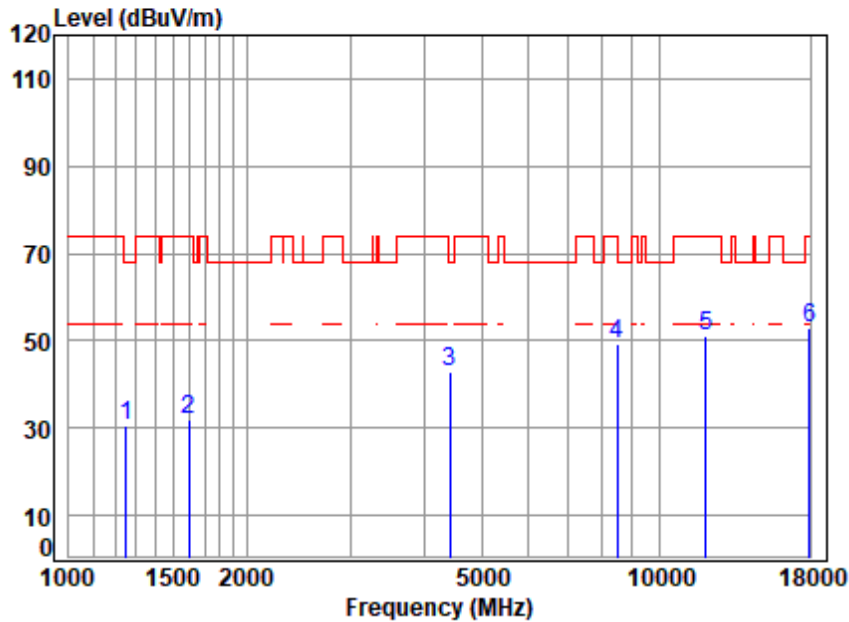

Site : chamber
 Condition: 3m HORIZONTAL
 Job No : 00955AT/00956AT
 Mode : 5985 TX RSE
 Note : 6E WIFI 11AC80

	Freq	Cable Loss	Ant Factor	Preamp Factor	Read Level	Level	Limit Line	Over Limit	Remark
	MHz	dB	dB/m	dB	dBuV	dBuV/m	dBuV/m	dB	
1	1252.885	3.67	25.08	38.35	40.16	30.56	68.20	-37.64	peak
2	1597.181	4.20	26.81	38.40	39.38	31.99	74.00	-42.01	peak
3	4417.841	7.07	34.59	35.78	37.09	42.97	68.20	-25.23	peak
4	8489.882	11.02	36.68	37.09	38.80	49.41	74.00	-24.59	peak
5	11970.000	13.08	37.77	37.56	37.94	51.23	74.00	-22.77	peak
6	p17955.000	15.12	44.12	37.65	31.27	52.86	74.00	-21.14	peak



Unless otherwise agreed in writing, this document is issued by the Company subject to its General Conditions of Service printed overleaf, available on request or accessible at <https://www.sgs.com/en/Terms-and-Conditions>. Attention is drawn to the limitation of liability, indemnification and jurisdiction issues defined therein. Any holder of this document is advised that information contained hereon reflects the Company's findings at the time of its intervention only and within the limits of Client's instructions, if any. The Company's sole responsibility is to its Client and this document does not exonerate parties to a transaction from exercising all their rights and obligations under the transaction documents. This document cannot be reproduced except in full, without prior written approval of the Company. Any unauthorized alteration, forgery or falsification of the content or appearance of this document is unlawful and offenders may be prosecuted to the fullest extent of the law. Unless otherwise stated the results shown in this test report refer only to the sample(s) tested and such sample(s) are retained for 30 days only.

Attention: To check the authenticity of testing /inspection report & certificate, please contact us at telephone: (86-755) 8307 1443, or email: CN.Doccheck@sgs.com
 No.1 Workshop, M-10, Middle Section, Science & Technology Park, Nanshan District, Shenzhen, Guangdong, China 518057 t (86-755) 26012053 f (86-755) 26710594 www.sgs.com.cn
 中国·广东·深圳市南山区科技园中区M-10栋1号厂房 邮编: 518057 t (86-755) 26012053 f (86-755) 26710594 sgs.china@sgs.com

Test Mode: 25; Polarity: Vertical; Modulation:802.11ac; Bandwidth:80MHz; Channel:Low

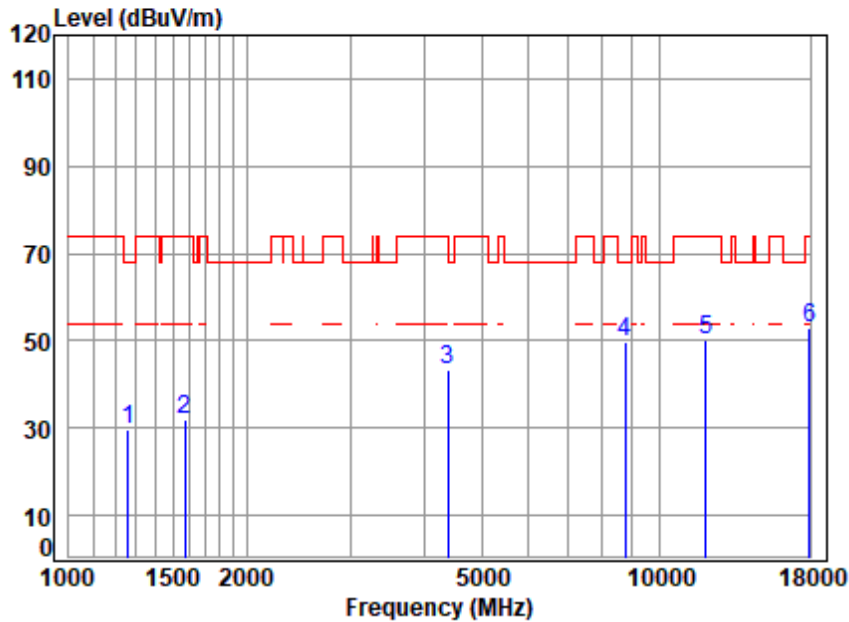

Site : chamber
 Condition: 3m VERTICAL
 Job No : 00955AT/00956AT
 Mode : 5985 TX RSE
 Note : 6E WIFI 11AC80

	Freq	Cable Loss	Ant Factor	Preamp Factor	Read Level	Level	Limit Line	Over Limit	Remark
	MHz	dB	dB/m	dB	dBuV	dBuV/m	dBuV/m	dB	
1	1260.149	3.69	25.04	38.35	39.36	29.74	68.20	-38.46	peak
2	1574.265	4.17	26.90	38.40	39.19	31.86	74.00	-42.14	peak
3	4392.376	7.05	34.74	35.80	37.14	43.13	74.00	-30.87	peak
4 p	8738.852	11.47	36.90	37.35	38.73	49.75	68.20	-18.45	peak
5	11970.000	13.08	37.77	37.56	36.89	50.18	74.00	-23.82	peak
6	17955.000	15.12	44.12	37.65	31.31	52.90	74.00	-21.10	peak



Unless otherwise agreed in writing, this document is issued by the Company subject to its General Conditions of Service printed overleaf, available on request or accessible at <https://www.sgs.com/en/Terms-and-Conditions>. Attention is drawn to the limitation of liability, indemnification and jurisdiction issues defined therein. Any holder of this document is advised that information contained hereon reflects the Company's findings at the time of its intervention only and within the limits of Client's instructions, if any. The Company's sole responsibility is to its Client and this document does not exonerate parties to a transaction from exercising all their rights and obligations under the transaction documents. This document cannot be reproduced except in full, without prior written approval of the Company. Any unauthorized alteration, forgery or falsification of the content or appearance of this document is unlawful and offenders may be prosecuted to the fullest extent of the law. Unless otherwise stated the results shown in this test report refer only to the sample(s) tested and such sample(s) are retained for 30 days only.

Test Mode: 25; Polarity: Horizontal; Modulation:802.11ac; Bandwidth:80MHz; Channel:middle

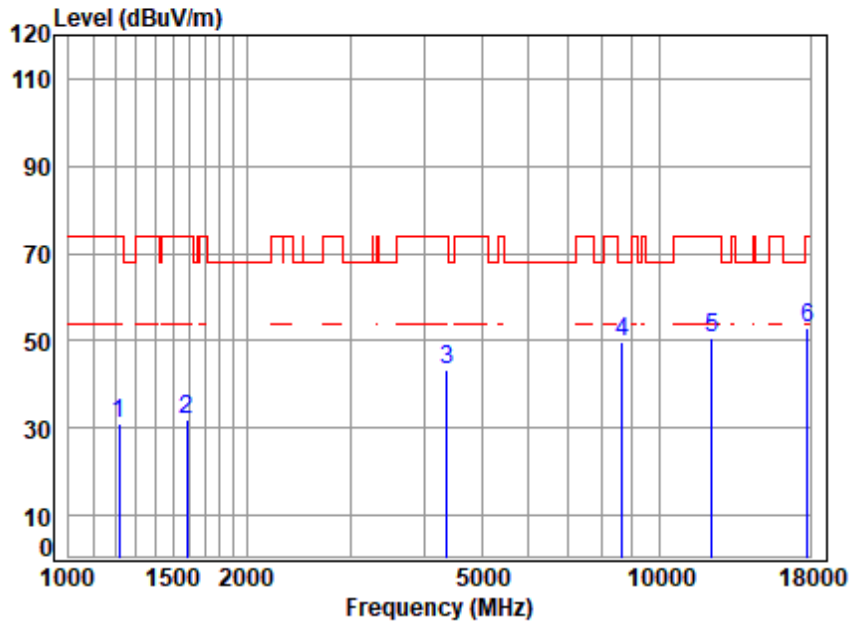

Site : chamber
 Condition: 3m HORIZONTAL
 Job No : 00955AT/00956AT
 Mode : 6145 TX RSE
 Note : 6E WIFI 11AC80

	Freq	Cable Loss	Ant Factor	Preamp Factor	Read Level	Level	Limit Line	Over Limit	Remark
	MHz	dB	dB/m	dB	dBuV	dBuV/m	dBuV/m	dB	
1	1217.190	3.61	24.64	38.34	41.32	31.23	74.00	-42.77	peak
2	1587.975	4.18	26.85	38.40	39.20	31.83	74.00	-42.17	peak
3	4367.058	7.04	34.54	35.82	37.77	43.53	74.00	-30.47	peak
4 p	8638.399	11.29	36.90	37.24	38.75	49.70	68.20	-18.50	peak
5	12290.000	13.23	37.90	37.47	36.81	50.47	74.00	-23.53	peak
6	17844.590	15.06	43.90	37.64	31.69	53.01	74.00	-20.99	peak



Unless otherwise agreed in writing, this document is issued by the Company subject to its General Conditions of Service printed overleaf, available on request or accessible at <https://www.sgs.com/en/Terms-and-Conditions>. Attention is drawn to the limitation of liability, indemnification and jurisdiction issues defined therein. Any holder of this document is advised that information contained hereon reflects the Company's findings at the time of its intervention only and within the limits of Client's instructions, if any. The Company's sole responsibility is to its Client and this document does not exonerate parties to a transaction from exercising all their rights and obligations under the transaction documents. This document cannot be reproduced except in full, without prior written approval of the Company. Any unauthorized alteration, forgery or falsification of the content or appearance of this document is unlawful and offenders may be prosecuted to the fullest extent of the law. Unless otherwise stated the results shown in this test report refer only to the sample(s) tested and such sample(s) are retained for 30 days only.
 Attention: To check the authenticity of testing /inspection report & certificate, please contact us at telephone: (86-755) 8307 1443, or email: CN.Doccheck@sgs.com
 No.1 Workshop, M-10, Middle Section, Science & Technology Park, Nanshan District, Shenzhen, Guangdong, China 518057 t (86-755) 26012053 f (86-755) 26710594 www.sgs.com.cn
 中国·广东·深圳市南山区科技园中区M-10栋1号厂房 邮编: 518057 t (86-755) 26012053 f (86-755) 26710594 sgs.china@sgs.com