



**CENTRE OF TESTING SERVICE  
INTERNATIONAL**

**OPERATE ACCORDING TO ISO/IEC 17025**

# **FCC TEST REPORT**

**TEST REPORT NUMBER : CGZ3170519-00961-EF**



**CENTRE OF TESTING SERVICE CO., LTD.**

A101, No.65, Zhuji Highway, Tianhe District, Guangzhou, China



<b>TEST REPORT For FCC ID</b>	
<b>47 CFR PART 15 OCT, 2016</b>	
<b>Report Reference No.</b> .....	CGZ3170519-00961-EF
<b>Date of issue</b> .....	27 May 2017
<b>Testing Laboratory Name</b> .....	<b>CETRE OF TESTING SERVICE CO., LTD.</b>
<b>Address</b> .....	A101, No.65, Zhuji Highway, Tianhe District, Guangzhou, China
<b>Testing location/ procedure</b> .....	Full application of Harmonised standards <input checked="" type="checkbox"/> Partial application of Harmonised standards <input type="checkbox"/> Other standard testing method <input type="checkbox"/>
<b>Applicant's name</b> .....	Mun Ah Plastic Electronic Toys CO., LTD.
<b>Address</b> .....	Flat G & H, 21/F., Blk. 2, Kingsway Ind Bldg., 173-5 Wo Yi Hop Rd., Kwai Chung, NT, Hong Kong
<b>Test specification</b> .....	
<b>Standard</b> .....	<b>47 CFR PART 15 OCT, 2016; ANSI C63.10-2013</b>
<b>Test Report Form No.</b> .....	CTSEMC-1.0
<b>TRF Originator</b> .....	CENTRE OF TESTING SERVICE CO., LTD.
<b>Master TRF</b> .....	Dated 2009-01
<b>CENTRE OF TESTING SERVICE CO., LTD. All rights reserved.</b>	
This publication may be reproduced in whole or in part for non-commercial purposes as long as the CENTRE OF TESTING SERVICE CO., LTD. is acknowledged as copyright owner and source of the material. CENTRE OF TESTING SERVICE CO., LTD takes no responsibility for and will not assume liability for damages resulting from the reader's interpretation of the reproduced material due to its placement and context.	
<b>Test item description</b> .....	: 2.4GHz Transmitter
<b>Trade Mark</b> .....	CARISMA
<b>Manufacturer</b> .....	Mun Ah Plastic Electronic Toys CO., LTD.
<b>Model/Type reference</b> .....	CTX-8000
<b>Ratings</b> .....	Battery 1.5V*4
<b>Operating Frequency</b> .....	2406.0 MHz ~2420.0 MHz
<b>Result</b> .....	<b>Positive</b>

**Compiled by:**

Kate zhang / Fileadministrators

**Supervised by:**

Duke yang / Technique principal

**Approved by:**

Vincent yao / Manager

Copyright of this report is owned by Centre of Testing Service and may not be reproduced other than in full except with the written approval of the issuing Company.

**CENTRE OF TESTING SERVICE CO., LTD.**

A101, No.65, Zhuji Highway, Tianhe District, Guangzhou, China

Tel: +86-20-85543113 (32 lines)

Fax: +86-20-38780406

Complaint line: +86-20-85533471

E-mail: cts@cts-lab.com.cn

See Reverse For Terms And Conditions of Service



## FCC ID -- TEST REPORT

<b>Test Report No. :</b> CGZ3170519-00961-EF	<u>27 May 2017</u> Date of issue
--	-------------------------------------

Type / Model.....	CTX-8000
EUT.....	2.4GHz Transmitter
<b>Applicant</b> .....	Mun Ah Plastic Electronic Toys CO., LTD.
Address.....	Flat G & H, 21/F., Blk. 2, Kingsway Ind Bldg., 173-5 Wo Yi Hop Rd., Kwai Chung, NT, Hong Kong
Telephone.....	+852-24275831
Fax.....	+852-24803087
Contact.....	Billy Yeung
<b>Manufacturer</b> .....	Mun Ah Plastic Electronic Toys CO., LTD.
Address.....	Flat G & H, 21/F., Blk. 2, Kingsway Ind Bldg., 173-5 Wo Yi Hop Rd., Kwai Chung, NT, Hong Kong
Telephone.....	+852-24275831
Fax.....	+852-24803087
Contact.....	Billy Yeung
<b>Factory</b> .....	Mun Ah Plastic Electronic Toys CO., LTD.
Address.....	Flat G & H, 21/F., Blk. 2, Kingsway Ind Bldg., 173-5 Wo Yi Hop Rd., Kwai Chung, NT, Hong Kong
Telephone.....	+852-24275831
Fax.....	+852-24803087
Contact.....	Billy Yeung

<b>Test Result</b> according to the standards on page 1: <b>PASSED</b>
--

The test report merely corresponds to the test sample.  
 It is not permitted to copy extracts of these test result without the written permission of the test laboratory.

Copyright of this report is owned by Centre of Testing Service and may not be reproduced other than in full except with the written approval of the issuing Company.

**CENTRE OF TESTING SERVICE CO., LTD.**

A101, No.65, Zhuji Highway, Tianhe District, Guangzhou, China  
 Tel: +86-20-85543113 (32 lines) Fax: +86-20-38780406  
 Complaint line: +86-20-85533471 E-mail: cts@cts-lab.com.cn

See Reverse For Terms And Conditions of Service



**TABLE OF CONTENTS**

<b>Description</b>	<b>Page</b>
<b>1.0 TEST STANDARDS</b> .....	<b>6</b>
<b>2.0 SUMMARY</b> .....	<b>6</b>
<b>2.1 GENERAL REMARKS</b> .....	<b>6</b>
<b>2.2 FINAL ASSESSMENT</b> .....	<b>6</b>
<b>3.0 EQUIPMENT UNDER TEST</b> .....	<b>6</b>
<b>3.1 POWER SUPPLY SYSTEM UTILISED</b> .....	<b>6</b>
<b>3.2 SHORT DESCRIPTION OF THE EQUIPMENT UNDER TEST (EUT)</b> .....	<b>6</b>
<b>3.3 EUT OPERATION MODE</b> .....	<b>6</b>
<b>3.4 EUT CONFIGURATION</b> .....	<b>7</b>
<b>4.0 TEST ENVIRONMENT</b> .....	<b>8</b>
<b>4.1 ADDRESS OF THE TEST LABORATORY</b> .....	<b>8</b>
<b>4.2 TEST FACILITY</b> .....	<b>8</b>
<b>4.3 ENVIRONMENTAL CONDITIONS</b> .....	<b>8</b>
<b>4.4 DEFINITIONS OF SYMBOLS USED IN THIS TEST REPORT</b> .....	<b>8</b>
<b>4.5 STATEMENT OF THE MEASUREMENT UNCERTAINTY</b> .....	<b>8</b>
<b>4.6 MEASUREMENT UNCERTAINTY</b> .....	<b>9</b>
<b>5.0 SUMMARY OF STANDARDS AND RESULTS</b> .....	<b>10</b>
<b>5.1.DESCRPTION OF STANDARDS AND RESULTS</b> .....	<b>10</b>
<b>6.0 POWER LINE CONDUCTED EMISSION TEST</b> .....	<b>11</b>
<b>6.1.TEST EQUIPMENTS</b> .....	<b>11</b>
<b>6.2. BLOCK DIAGRAM OF TEST SETUP</b> .....	<b>11</b>
<b>6.3. POWER LINE CONDUCTED EMISSION TEST LIMITS</b> .....	<b>11</b>
<b>6.4.TEST PROCEDURE</b> .....	<b>11</b>
<b>6.5. POWER LINE CONDUCTED EMISSION TEST RESULTS</b> .....	<b>11</b>
<b>7.0 20DB BANDWIDTH</b> .....	<b>12</b>
<b>7.1 MEASUREMENT EQUIPMENT USED</b> .....	<b>12</b>
<b>7.2 TEST CONFIGURATION</b> .....	<b>12</b>
<b>7.3 TEST PROCEDURE</b> .....	<b>12</b>
<b>7.4 TEST RESULTS</b> .....	<b>12</b>
<b>8.0 PEAK POWER</b> .....	<b>15</b>
<b>8.1 LIMIT</b> .....	<b>15</b>
<b>8.2 MEASUREMENT EQUIPMENT USED</b> .....	<b>15</b>
<b>8.3 TEST CONDIGURATION</b> .....	<b>15</b>
<b>8.4 TEST PROCEDURE</b> .....	<b>16</b>
<b>8.5 TEST RESULTS</b> .....	<b>17</b>

Copyright of this report is owned by Centre of Testing Service and may not be reproduced other than in full except with the written approval of the issuing Company.

**CENTRE OF TESTING SERVICE CO., LTD.**

A101, No.65, Zhuji Highway, Tianhe District, Guangzhou, China

Tel: +86-20-85543113 (32 lines)

Fax: +86-20-38780406

Complaint line: +86-20-85533471

E-mail: cts@cts-lab.com.cn

See Reverse For Terms And Conditions of Service



**9.0 PEAK POWER SPECTRAL DENSITY ..... 19**

    9.1 LIMIT.....19

    9.2 MEASUREMENT EQUIPMENT USED.....19

    9.2 TEST CONFIGURATION .....19

    9.3 TEST PROCEDURE .....19

    9.4 TEST RESULTS .....19

**10.0 100KHZ BANDWIDTH OF BAND EDGES MEASUREMENT .....20**

    10.1 LIMIT.....20

    10.2 MEASUREMENT EQUIPMENT USED .....20

    10.3 TEST CONFIGURATION .....20

    10.4 TEST PROCEDURE .....20

    10.5 TEST RESULTS .....21

**11.0 FREQUENCY SEPARATION .....25**

    11.1 LIMIT.....25

    11.2 MEASUREMENT EQUIPMENT USED .....25

    11.3 TEST CONFIGURATION .....25

    11.4 TEST PROCEDURE .....25

    11.5 TEST RESULTS .....25

**12.0 NUMBER OF HOPPING FREQUENCY.....27**

    12.1 LIMIT.....27

    12.2 MEASUREMENT EQUIPMENT USED .....27

    12.3 TEST CONFIGURATION .....27

    12.4 TEST PROCEDURE .....27

    12.5 TEST RESULTS .....27

    12.6 TEST DATA.....27

**13.0 TIME OF OCCUPANCY (DWELL TIME) .....29**

    13.1 LIMIT.....29

    13.2 MEASUREMENT EQUIPMENT USED .....29

    13.3 TEST CONFIGURATION .....29

    13.4 TEST PROCEDURE.....29

    13.5 TEST RESULTS .....29

    13.6 TEST DATA.....29

**14.0 TRANSMITTER UNWANTED EMISSIONS .....31**

    14.1 LIMIT.....31

    14.2 TEST EQUIPMENT .....31

    14.3 TEST CONFIGURATION .....32

    14.4 TEST PROCEDURE.....33

    14.5 TEST RESULTS .....33

**15.0 ANTENNA REQUIREMENTS .....41**

    15.1 STANDARD APPLICABLE .....41

    15.2 ANTENNA CONSTRUCTION AND DIRECTIONAL GAIN .....41

Copyright of this report is owned by Centre of Testing Service and may not be reproduced other than in full except with the written approval of the issuing Company.

**CENTRE OF TESTING SERVICE CO., LTD.**

A101, No.65, Zhuji Highway,Tianhe District, Guangzhou, China

Tel: +86-20-85543113 (32 lines)

Fax: +86-20-38780406

Complaint line: +86-20-85533471

E-mail: cts@cts-lab.com.cn

See Reverse For Terms And Conditions of Service



---

17.0 DEVIATION TO TEST SPECIFICATIONS .....41

Copyright of this report is owned by Centre of Testing Service and may not be reproduced other than in full except with the written approval of the issuing Company.

**CENTRE OF TESTING SERVICE CO., LTD.**

A101, No.65, Zhuji Highway, Tianhe District, Guangzhou, China

Tel: +86-20-85543113 (32 lines)

Fax: +86-20-38780406

Complaint line: +86-20-85533471

E-mail: cts@cts-lab.com.cn

See Reverse For Terms And Conditions of Service

## 1.0 TEST STANDARDS

The tests were performed according to following standards:

- 47 CFR PART 15 OCT, 2016
- ANSI C63.10-2013

## 2.0 SUMMARY

### 2.1 GENERAL REMARKS

Date of receipt of test sample	19 May 2017
Testing commenced on	19~27 May 2017
Testing concluded on	27 May 2017

### 2.2 FINAL ASSESSMENT

The IC requirements pertaining to the technical standards and tested operation modes are

- - fulfilled.
- - **not** fulfilled.

The equipment under test

- - fulfils the FCC ID requirements cited on page 1.
- - **does not** fulfil the FCC ID requirements cited on page 1.

## 3.0 EQUIPMENT UNDER TEST

### 3.1 POWER SUPPLY SYSTEM UNILISED

Power supply voltage : ■ Battery 1.5V\*4

### 3.2 SHORT DESCRIPTION OF THE EQUIPMENT UNDER TEST (EUT)

Number of tested samples: 1

Serial number: Prototype

### 3.3 EUT OPERATION MODE

The equipment under test was operated during the measurement under the following conditions:

- - Standby
- TX- Y position
- TX- Z position
- TX- X position

Operation mode 1:TX-X Position Low (2406.0 MHz) , TX-X Position Middle (2413.0 MHz) ,  
TX-X Position High (2420.0 MHz)

Note:Operation mode 1 TX -X position and RX Mode of EUT is the radiated test worst case. so only these test results be recorded in the test report.

### 3.4 EUT CONFIGURATION

#### 3.4.1. Description of configuration (EUT)

Description	:	2.4GHz Transmitter
Model Number	:	CTX-8000
Operation frequency	:	2406.0 MHz~ 2420.0 MHz ISM Band
Modulation Technology	:	FHSS
Antenna	:	External antenna, met requirement of FCC 15.203

#### 3.4.2. Tested Supporting System Details

N/A



## 4.0 TEST ENVIRONMENT

### 4.1 ADDRESS OF THE TEST LABORATORY

A101, No.65, Zhuji Highway, Tianhe District, Guangzhou, China

Tel: +86-20-85543113 (32 lines)

Fax: +86-20-38780406

### 4.2 TEST FACILITY

The test facility is recognized, certified, or accredited by the following organizations:

#### **CNAS-Lab Code: L3394**

CENTRE OF TESTING SERVICE CO., LTD has been assessed and proved to be in compliance with CNAS-CL01: 2006 Accreditation Criteria for Testing and Calibration Laboratories (identical to ISO/IEC 17025: 2005 General Requirements) for the Competence of Testing and Calibration Laboratories.

#### **IC-Registration No.: 8374A**

The 3m Alternate Test Site of CENTRE OF TESTING SERVICE CO., LTD has been registered by Certification and Engineering Bureau of Industry Canada for the performance of radiated measurements with Registration No. 8374A on May 22, 2014.

#### **FCC-Registration No.: 971995**

CENTRE OF TESTING SERVICE CO., LTD, EMC Laboratory has been registered and fully described in a report filed with the FCC (Federal Communications Commission). The acceptance letter from the FCC is maintained in our files. Registration No.791995, July 13,2012.

### 4.3 ENVIRONMENTAL CONDITIONS

During the measurement the environmental conditions were within the listed ranges:

Temperature:	15~35 ° C
Humidity:	25~75 %
Atmospheric pressure:	86~106 kPa

### 4.4 DEFINITIONS OF SYMBOLS USED IN THIS TEST REPORT

- - The black square indicates that the listed condition, standard or equipment is applicable for this report.
- - The empty square indicates that the listed condition, standard or equipment is **not** applicable for this report.

### 4.5 STATEMENT OF THE MEASUREMENT UNCERTAINTY

The data and results referenced in this document are true and accurate. The reader is cautioned that there may be errors within the calibration limits of the equipment and facilities. The measurement uncertainty was calculated for all measurements listed in this test report acc. to CISPR 16 - 4 "Specification for radio disturbance and immunity measuring apparatus and methods – Part 4: Uncertainty in EMC Measurements" and is documented in the CTS quality system acc. to DIN EN ISO/IEC 17025. Furthermore, component and process variability of devices similar to that tested may result in additional deviation. The manufacturer has the sole responsibility of continued compliance of the device.

Copyright of this report is owned by Centre of Testing Service and may not be reproduced other than in full except with the written approval of the issuing Company.

#### **CENTRE OF TESTING SERVICE CO., LTD.**

A101, No.65, Zhuji Highway, Tianhe District, Guangzhou, China

Tel: +86-20-85543113 (32 lines)

Fax: +86-20-38780406

Complaint line: +86-20-85533471

E-mail: cts@cts-lab.com.cn

See Reverse For Terms And Conditions of Service

#### 4.6 MEASUREMENT UNCERTAINTY

Test Item	Frequency Range	Uncertainty	Note
Conduction disturbance	150kHz~30MHz	$\pm 1.22\text{dB}$	(1)
Power disturbance	30MHz~300MHz	$\pm 1.38\text{dB}$	(1)
Radiation emission (3m)	30MHz~300MHz	$\pm 3.14\text{dB}$	(1)
	300MHz~1000MHz	$\pm 3.18\text{dB}$	(1)
	1GHz~26.5GHz	$\pm 3.54\text{dB}$	(1)

(1). This uncertainty represents an expanded uncertainty expressed at approximately the 95% confidence level using a coverage factor of  $k=2$ .

Copyright of this report is owned by Centre of Testing Service and may not be reproduced other than in full except with the written approval of the issuing Company.

#### CENTRE OF TESTING SERVICE CO., LTD.

A101, No.65, Zhuji Highway, Tianhe District, Guangzhou, China

Tel: +86-20-85543113 (32 lines)

Fax: +86-20-38780406

Complaint line: +86-20-85533471

E-mail: cts@cts-lab.com.cn

See Reverse For Terms And Conditions of Service

## 5.0 SUMMARY OF STANDARDS AND RESULTS

### 5.1.DESCRPTION OF STANDARDS AND RESULTS

The EUT have been tested according to the applicable standards as referenced below.

EMISSION		
Description of Test Item	Standard	Results
Conducted Emission Test	FCC Part 15:15.207 ANSI C63.10-2013	N/A
20dB Bandwidth	FCC Part 15.247(a)(1) ANSI C63.10-2013	PASSED
Peak Power	FCC Part 15.247(b)(1) ANSI C63.10-2013	PASSED
Peak Power Spectral Density	15.247(e) ANSI C63.10-2013	N/A
100KHz Bandwidth Band edges measurement	FCC Part 15.247(d) ANSI C63.10-2013	PASSED
Conducted Spurious Emissions	FCC Part 15.247(d) ANSI C63.10-2013	PASSED
Frequency Separation	FCC Part 15.247(a)(1) ANSI C63.10-2013	PASSED
Number of Hopping Frequency	FCC Part 15.247(a)(1)(iii) ANSI C63.10-2013	PASSED
Dwell Time	FCC Part 15.247(a)(1)(iii) ANSI C63.10-2013	PASSED
Transmitter Unwanted Emissions	FCC Part 15: 15.209 ANSI C63.10-2013	PASSED
N/A is an abbreviation for Not Applicable.		

Copyright of this report is owned by Centre of Testing Service and may not be reproduced other than in full except with the written approval of the issuing Company.

#### CENTRE OF TESTING SERVICE CO., LTD.

A101, No.65, Zhuji Highway, Tianhe District, Guangzhou, China

Tel: +86-20-85543113 (32 lines)

Fax: +86-20-38780406

Complaint line: +86-20-85533471

E-mail: cts@cts-lab.com.cn

See Reverse For Terms And Conditions of Service



## 6.0 POWER LINE CONDUCTED EMISSION TEST

### 6.1. TEST EQUIPMENTS

Conducted Disturbance					
Item	Test Equipment	Manufacturer	Model No.	Serial No.	Last Cal.
1	EMI Test Receiver	ROHDE & SCHWARZ	ESHS10	842884/012	2016/10
2	Artificial Mains	ROHDE & SCHWARZ	ESH3-Z5	832479/025	2016/10
3	Artificial Mains	ROHDE & SCHWARZ	ESH3-Z5	832479/026	2016/10
4	Pulse Limiter	ROHDE & SCHWARZ	ESHSZ2	100301	2016/10
5	EMI Test Software	EZ-EMC	Farad	N/A	N/A

### 6.2. BLOCK DIAGRAM OF TEST SETUP



(EUT: 2.4GHz Transmitter)

### 6.3. POWER LINE CONDUCTED EMISSION TEST LIMITS

Standard: FCC Part 15:15.207, ANSI C63.10-2013

Frequency	Maximum RF Line Voltage	
	Quasi-Peak Level dB(μV)	Average Level dB(μV)
150kHz ~ 500kHz	66 ~ 56*	56 ~ 46*
500kHz ~ 5MHz	56	46
5MHz ~ 30MHz	60	50

Notes: 1. \* Decreasing linearly with logarithm of frequency.  
2. The lower limit shall apply at the transition frequencies.

### 6.4. TEST PROCEDURE

The EUT Power connected to the power mains through a line impedance stabilization network (L.I.S.N.#2). This provides a 50 ohm coupling impedance for the EUT. Please refer the block diagram of the test setup and photographs. The other peripheral devices power cord connected to the power mains through a line impedance stabilization network (L.I.S.N.#1). Power on the PC and let it work normally, we use a keyboard test soft ware, let EUT working in test mode, then test it. Both sides of AC line are checked to find out the maximum conducted emission. In order to find the maximum emission levels, the relative positions of equipment and all of the interface cables shall be changed according to FCC Part 15C on Conducted Emission Test.

### 6.5. POWER LINE CONDUCTED EMISSION TEST RESULTS

The EUT power supply by DC Battery, Not applicable.

## 7.0 20dB BANDWIDTH

### 7.1 MEASUREMENT EQUIPMENT USED

20dB Bandwidth					
Item	Test Equipment	Manufacturer	Model No.	Serial No.	Last Cal.
1	Signal analyzer	ROHDE & SCHWARZ	FSIQ26	100311	2017/03

### 7.2 TEST CONFIGURATION

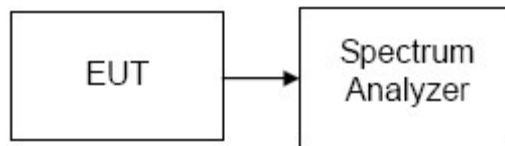

### 7.3 TEST PROCEDURE

1. Place the EUT on the table and set it in the transmitting mode.
2. Remove the antenna from the EUT, then connect a low loss RF cable from antenna port to the spectrum analyzer.
3. Set the spectrum analyzer as RBW=100kHz, VBW=300kHz, Span=3MHz, Sweep = auto.
4. Mark the peak frequency and 20dB (upper and lower) frequency.
5. Repeat until all the test channels are investigated.

### 7.4 TEST RESULTS

Channel	Frequency (MHz)	20dB Bandwidth (MHz)	Limit (dBm)	Result
Low	2406	0.840	-----	PASS
Middle	2413	0.964	-----	PASS
High	2420	0.939	-----	PASS

Copyright of this report is owned by Centre of Testing Service and may not be reproduced other than in full except with the written approval of the issuing Company.

#### CENTRE OF TESTING SERVICE CO., LTD.

A101, No.65, Zhuji Highway, Tianhe District, Guangzhou, China

Tel: +86-20-85543113 (32 lines)

Fax: +86-20-38780406

Complaint line: +86-20-85533471

E-mail: cts@cts-lab.com.cn

See Reverse For Terms And Conditions of Service



Test Plot

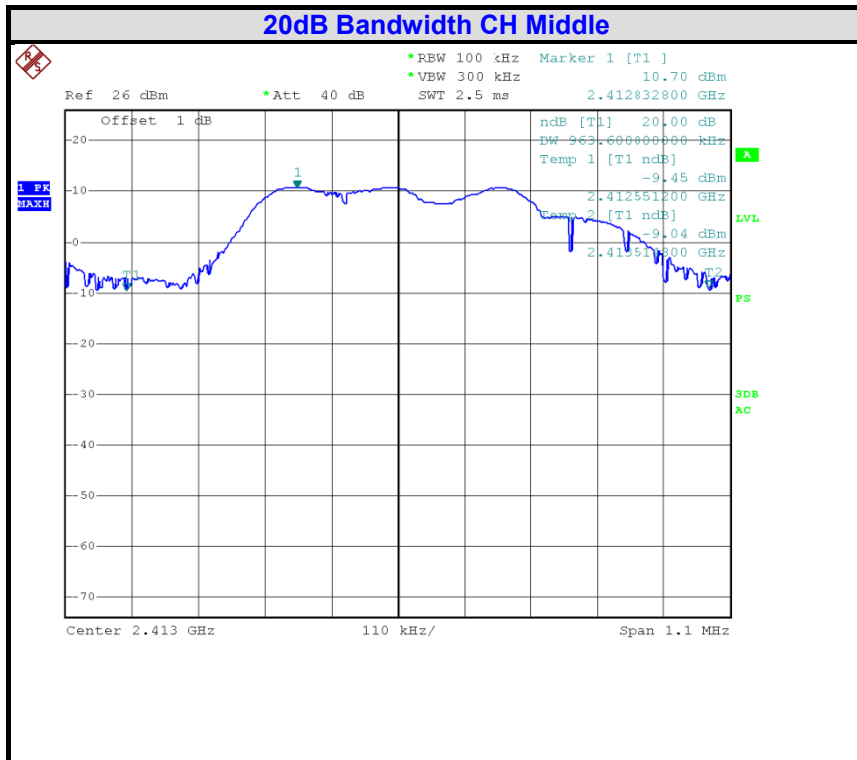
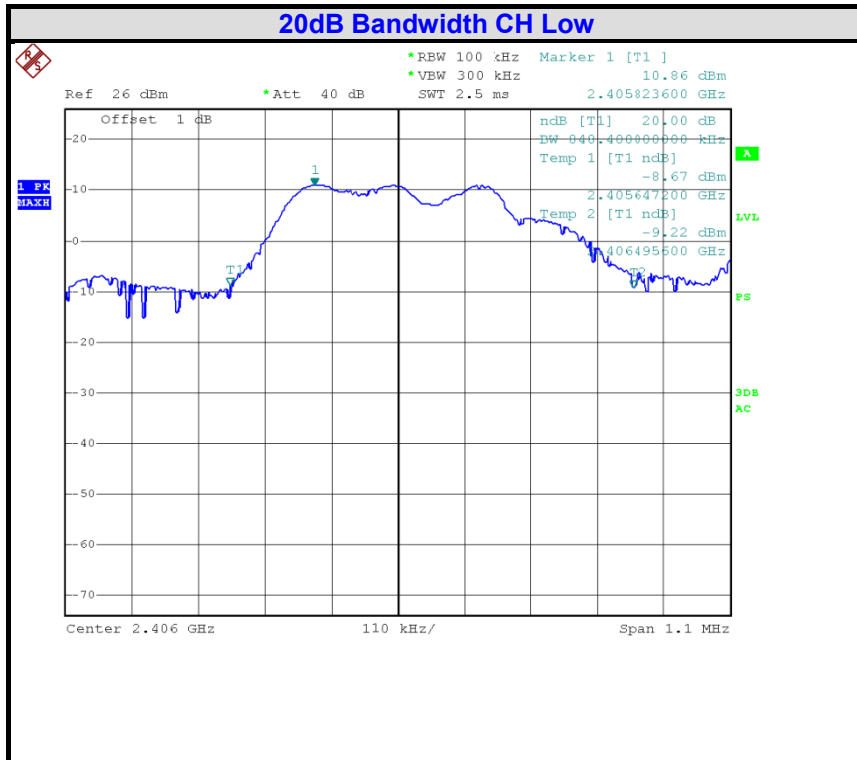

Copyright of this report is owned by Centre of Testing Service and may not be reproduced other than in full except with the written approval of the issuing Company.

**CENTRE OF TESTING SERVICE CO., LTD.**

A101, No.65, Zhuji Highway, Tianhe District, Guangzhou, China

Tel: +86-20-85543113 (32 lines)

Fax: +86-20-38780406

Complaint line: +86-20-85533471

E-mail: cts@cts-lab.com.cn

See Reverse For Terms And Conditions of Service

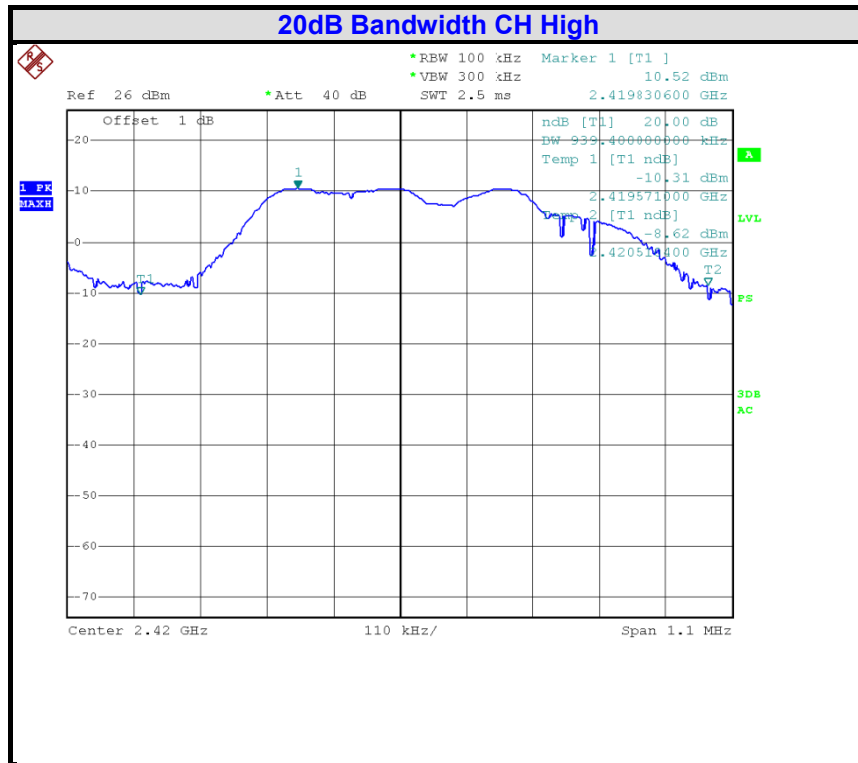

Copyright of this report is owned by Centre of Testing Service and may not be reproduced other than in full except with the written approval of the issuing Company.

**CENTRE OF TESTING SERVICE CO., LTD.**

A101, No.65, Zhuji Highway, Tianhe District, Guangzhou, China  
 Tel: +86-20-85543113 (32 lines)      Fax: +86-20-38780406  
 Complaint line: +86-20-85533471      E-mail: cts@cts-lab.com.cn

See Reverse For Terms And Conditions of Service

## 8.0 PEAK POWER

### 8.1 LIMIT

The maximum peak output power of the intentional radiator shall not exceed the following:

1. For frequency hopping systems operating in the 2400–2483.5 MHz band employing at least 75 non-overlapping hopping channels, and all frequency hopping systems in the 5725–5850 MHz band: 1 watt. For all other frequency hopping systems in the 2400–2483.5 MHz band: 0.125 watts.
2. For frequency hopping systems operating in the 902–928 MHz band: 1 watt for systems employing at least 50 hopping channels; and, 0.25 watts for systems employing less than 50 hopping channels, but at least 25 hopping channels, as permitted under paragraph (a)(1)(i) of this section.
3. For systems using digital modulation in the 902–928 MHz, 2400–2483.5MHz, and 5725–5850 MHz bands: 1 Watt. As an alternative to a peak power measurement, compliance with the one Watt limit can be based on a measurement of the maximum conducted output power. Maximum Conducted Output Power is defined as the total transmit power delivered to all antennas and antenna elements averaged across all symbols in the signaling alphabet when the transmitter is operating at its maximum power control level. Power must be summed across all antennas and antenna elements. The average must not include any time intervals during which the transmitter is off or is transmitting at reduced power level. If multiple modes of operation are possible (e.g., alternative modulation methods), the maximum conducted output power is the highest total transmit power occurring in any mode.

### 8.2 MEASUREMENT EQUIPMENT USED

Peak Power					
Item	Test Equipment	Manufacturer	Model No.	Serial No.	Last Cal.
1	Signal analyzer	ROHDE & SCHWARZ	FSIQ26	100311	2017/03
2	Power meter	ROHDE & SCHWARZ	NRVS	842856/049	2017/03

### 8.3 TEST CONDIGURATION

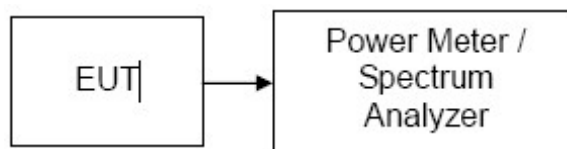

Copyright of this report is owned by Centre of Testing Service and may not be reproduced other than in full except with the written approval of the issuing Company.

**CENTRE OF TESTING SERVICE CO., LTD.**

A101, No.65, Zhuji Highway, Tianhe District, Guangzhou, China

Tel: +86-20-85543113 (32 lines)

Fax: +86-20-38780406

Complaint line: +86-20-85533471

E-mail: cts@cts-lab.com.cn

See Reverse For Terms And Conditions of Service



## 8.4 TEST PROCEDURE

1. Set span to encompass the entire emission bandwidth of the signal.
2. Set RBW = 1 MHz.
3. Set VBW = 3 MHz.
4. Use sample detector mode if bin width (i.e., span/number of points in spectrum display) < 0.5 RBW. Otherwise use peak detector mode.
5. Use a video trigger with the trigger level set to enable triggering only on full power pulses. Transmitter must operate at full control power for entire sweep of every sweep. If the device transmits continuously, with no off intervals or reduced power intervals, the trigger may be set to "free run".
6. Mark the peak frequency and channel power function on spectrum.
7. Repeat until all the test channels are investigated.

Copyright of this report is owned by Centre of Testing Service and may not be reproduced other than in full except with the written approval of the issuing Company.

**CENTRE OF TESTING SERVICE CO., LTD.**

A101, No.65, Zhuji Highway, Tianhe District, Guangzhou, China

Tel: +86-20-85543113 (32 lines)

Fax: +86-20-38780406

Complaint line: +86-20-85533471

E-mail: [cts@cts-lab.com.cn](mailto:cts@cts-lab.com.cn)

See Reverse For Terms And Conditions of Service



8.5 TEST RESULTS

Passed  
Test Data

Channel	Frequency (MHz)	Output Power (dBm)	Limit (dBm)	Result
Low	2406	9.62	21	PASS
Middle	2413	9.43	21	PASS
High	2420	9.20	21	PASS

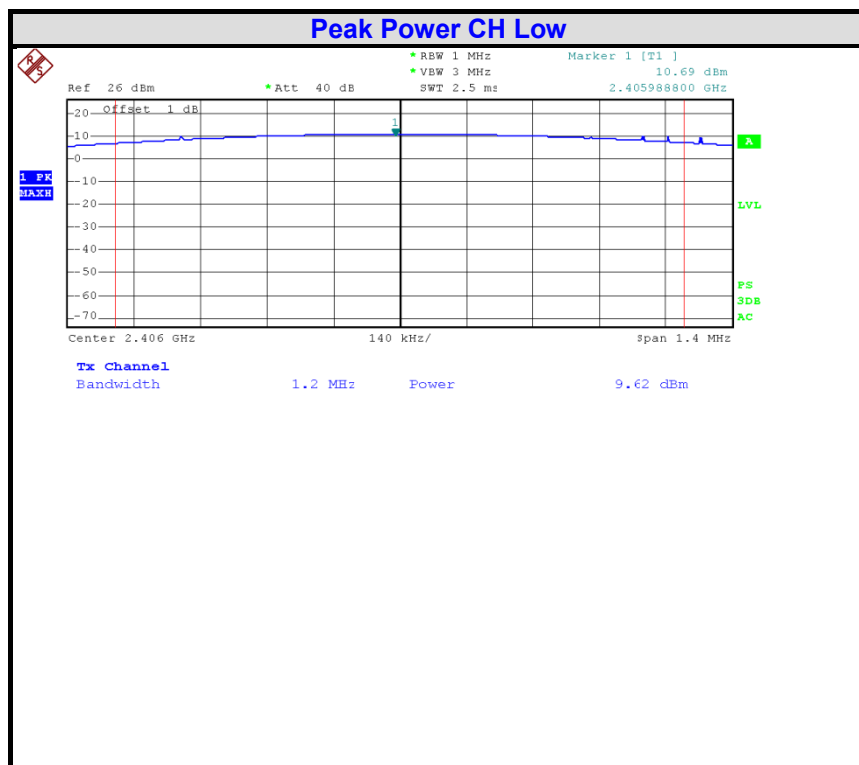

Copyright of this report is owned by Centre of Testing Service and may not be reproduced other than in full except with the written approval of the issuing Company.

**CENTRE OF TESTING SERVICE CO., LTD.**

A101, No.65, Zhuji Highway, Tianhe District, Guangzhou, China

Tel: +86-20-85543113 (32 lines)

Fax: +86-20-38780406

Complaint line: +86-20-85533471

E-mail: cts@cts-lab.com.cn

See Reverse For Terms And Conditions of Service

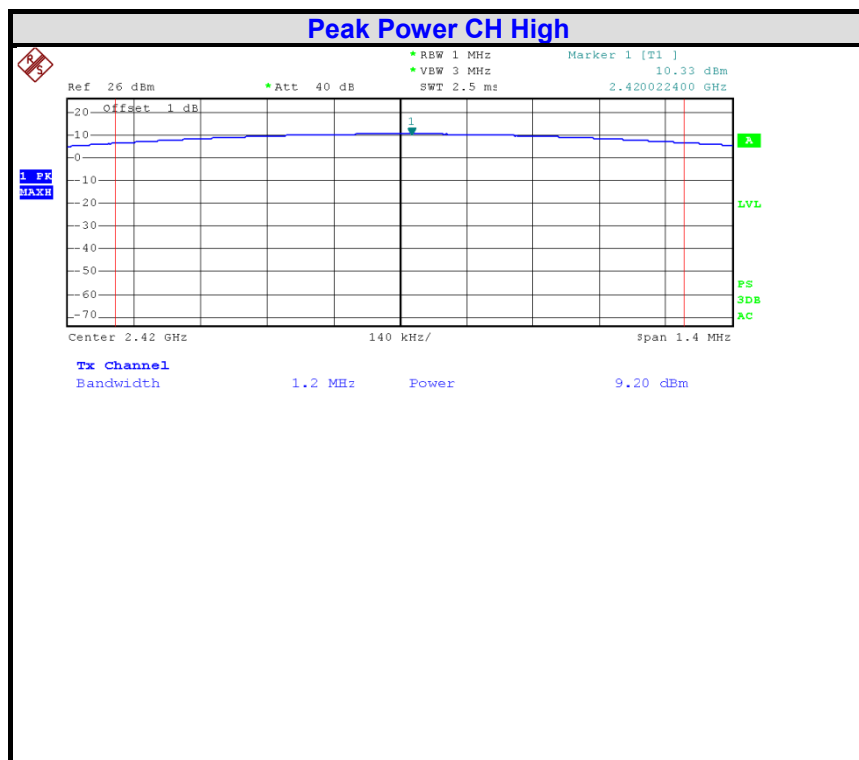
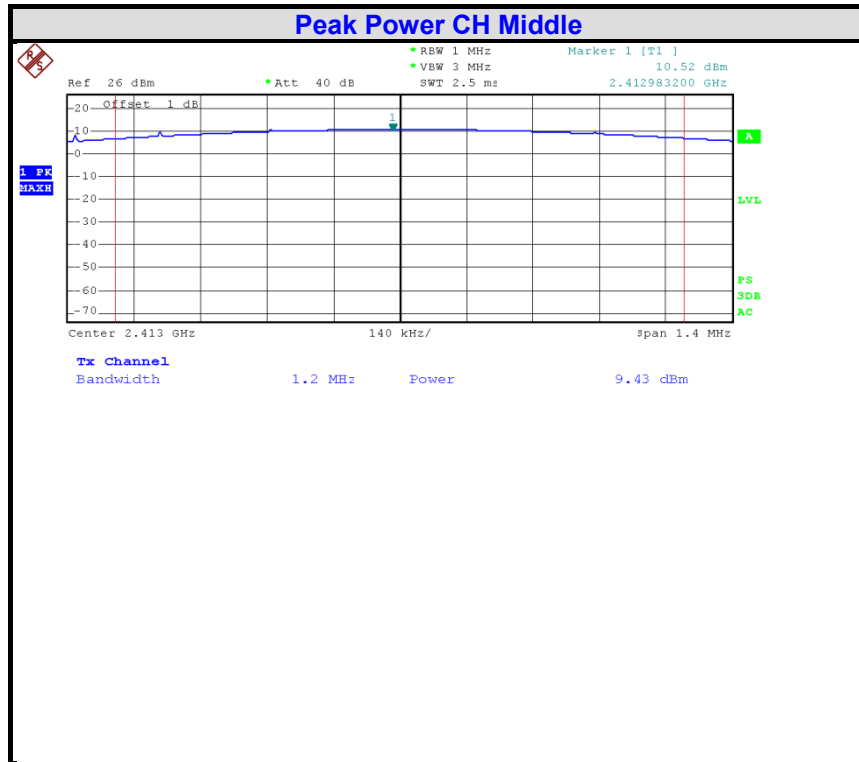

Copyright of this report is owned by Centre of Testing Service and may not be reproduced other than in full except with the written approval of the issuing Company.

**CENTRE OF TESTING SERVICE CO., LTD.**

A101, No.65, Zhuji Highway, Tianhe District, Guangzhou, China

Tel: +86-20-85543113 (32 lines)

Fax: +86-20-38780406

Complaint line: +86-20-85533471

E-mail: cts@cts-lab.com.cn

See Reverse For Terms And Conditions of Service

## 9.0 PEAK POWER SPECTRAL DENSITY

### 9.1 LIMIT

1. For direct sequence systems, the peak power spectral density conducted from the intentional radiator to the antenna shall not be greater than 8dBm in any 3kHz band during any time interval of continuous transmission.
2. The direct sequence operating of the hybrid system, with the frequency hopping operation turned off, shall comply with the power density requirements of paragraph (d) of this section

### 9.2 MEASUREMENT EQUIPMENT USED

Peak Power Spectral Density					
Item	Test Equipment	Manufacturer	Model No.	Serial No.	Last Cal.
1	Signal analyzer	ROHDE & SCHWARZ	FSIQ26	100311	2017/03

### 9.2 TEST CONFIGURATION

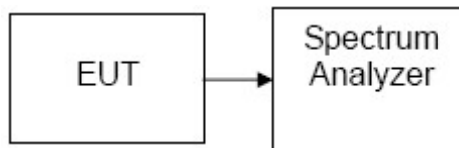

### 9.3 TEST PROCEDURE

1. Place the EUT on the table and set it in transmitting mode.
2. Remove the antenna from the EUT and then connect a low loss RF cable from the antenna port to the spectrum analyzer.
3. Set the spectrum analyzer as RBW = 3kHz, VBW = 10kHz, Span = 300kHz, Sweep=100s
4. Record the max. reading.
5. Repeat the above procedure until the measurements for all frequencies are completed.

### 9.4 TEST RESULTS

Not applicable for frequency hopping systems device.

## 10.0 100KHz BANDWIDTH OF BAND EDGES MEASUREMENT

### 10.1 LIMIT

In any 100 kHz bandwidth outside the frequency band in which the spread spectrum or digitally modulated intentional radiator is operating, the radio frequency power that is produced by the intentional radiator shall be at least 20 dB below that in the 100 kHz bandwidth within the band that contains the highest level of the desired power, based on either an RF conducted or a radiated measurement, provided the transmitter demonstrates compliance with the peak conducted power limits. If the transmitter complies with the conducted power limits based on the use of RMS averaging over a time interval, as permitted under paragraph (b)(3) of this section, the attenuation required under this paragraph shall be 30 dB instead of 20 dB. Attenuation below the general limits specified in § 15.209(a) is not required. In addition, radiated emissions which fall in the restricted bands, as defined in § 15.205(a), must also comply with the radiated emission limits specified in § 15.209(a) (see § 15.205(c)).

### 10.2 MEASUREMENT EQUIPMENT USED

Radiated disturbance (electric field)					
Item	Test Equipment	Manufacturer	Model No.	Serial No.	Last Cal.
1	Signal analyzer	ROHDE & SCHWARZ	FSIQ26	100311	2017/03

### 10.3 TEST CONFIGURATION

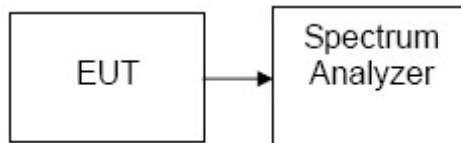

### 10.4 TEST PROCEDURE

Conducted Band-Edges:

1. Check the calibration of the measuring instrument using either an internal calibrator or a known signal from an external generator.
2. Position the EUT as shown in figure 4 without connection to measurement instrument. Turn on the EUT and connect its antenna terminal to measurement instrument via a low loss cable. Then set it to any one measured frequency within its operating range and make sure the instrument is operated in its linear range.
3. Use the following spectrum analyzer settings:  
Span = wide enough to capture the peak level of the emission operating on the channel

Copyright of this report is owned by Centre of Testing Service and may not be reproduced other than in full except with the written approval of the issuing Company.

**CENTRE OF TESTING SERVICE CO., LTD.**

A101, No.65, Zhuji Highway, Tianhe District, Guangzhou, China

Tel: +86-20-85543113 (32 lines)

Fax: +86-20-38780406

Complaint line: +86-20-85533471

E-mail: cts@cts-lab.com.cn

See Reverse For Terms And Conditions of Service

closest to the bandedge, as well as any modulation products which fall outside of the authorized band of operation

RBW = 100KHz(1% of the span)

VBW =3RBW

Sweep = auto

Detector function = peak

Trace = max hold

4. Allow the trace to stabilize. Set the marker on the emission at the bandedge, or on the highest modulation product outside of the band, if this level is greater than that at the bandedge. Enable the marker-delta function, then use the marker-to-peak function to move the marker to the peak of the in-band emission. Plot the result on the screen of spectrum analyzer.
5. Repeat above procedures until all measured frequencies were complete.

## 10.5 TEST RESULTS

Refer to attach spectrum analyzer data chart.

### **CENTRE OF TESTING SERVICE CO., LTD.**

A101, No.65, Zhuji Highway, Tianhe District, Guangzhou, China

Tel: +86-20-85543113 (32 lines)

Fax: +86-20-38780406

Complaint line: +86-20-85533471

E-mail: cts@cts-lab.com.cn

See Reverse For Terms And Conditions of Service

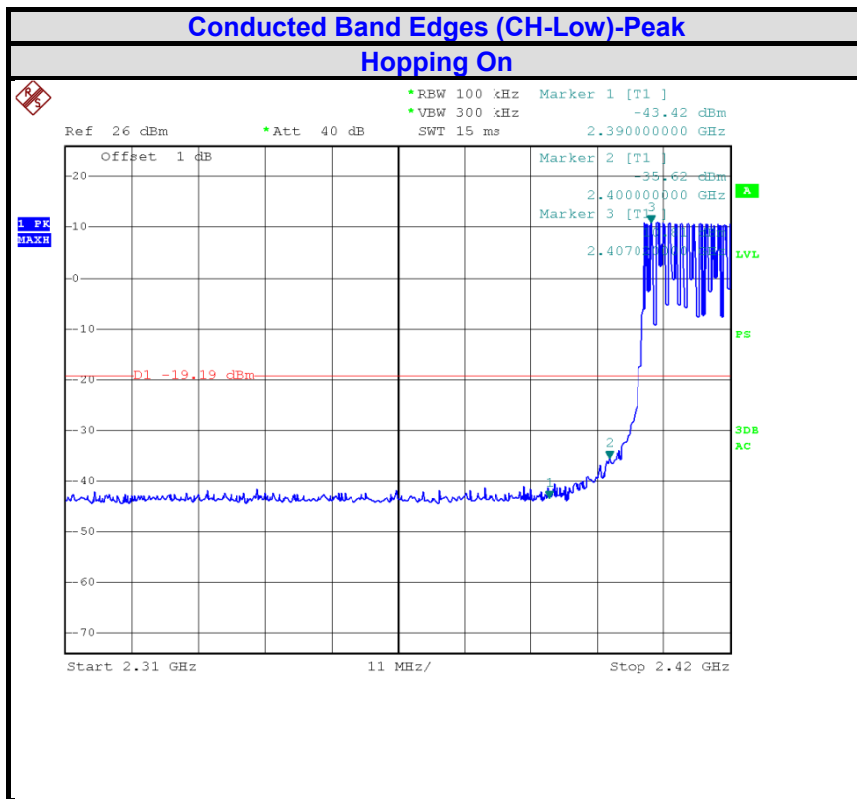
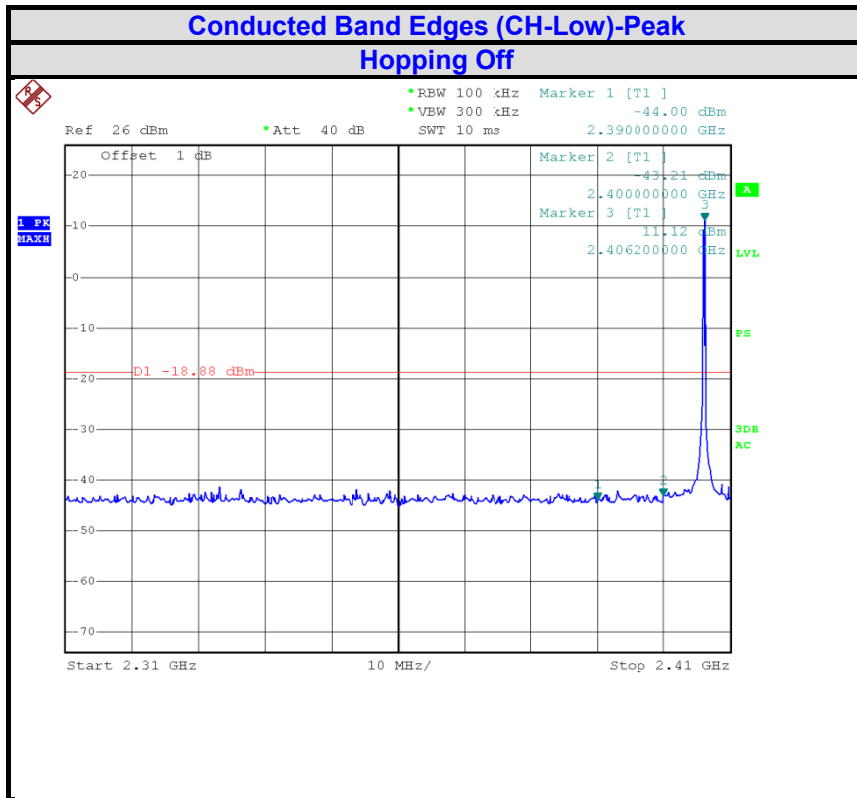

Copyright of this report is owned by Centre of Testing Service and may not be reproduced other than in full except with the written approval of the issuing Company.

**CENTRE OF TESTING SERVICE CO., LTD.**

A101, No.65, Zhuji Highway, Tianhe District, Guangzhou, China

Tel: +86-20-85543113 (32 lines)

Fax: +86-20-38780406

Complaint line: +86-20-85533471

E-mail: cts@cts-lab.com.cn

See Reverse For Terms And Conditions of Service

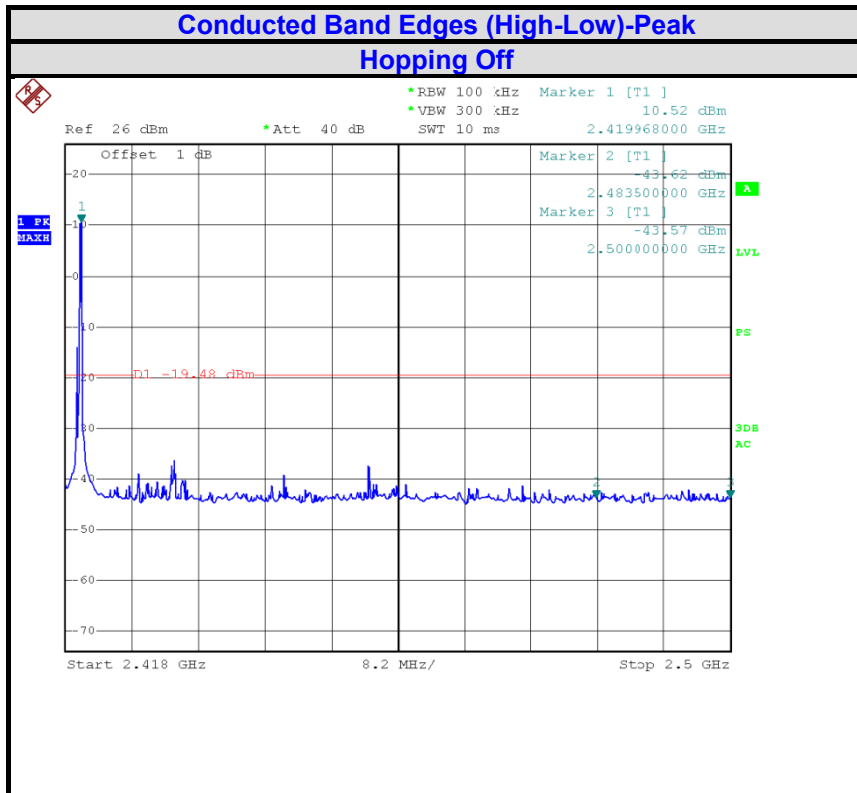
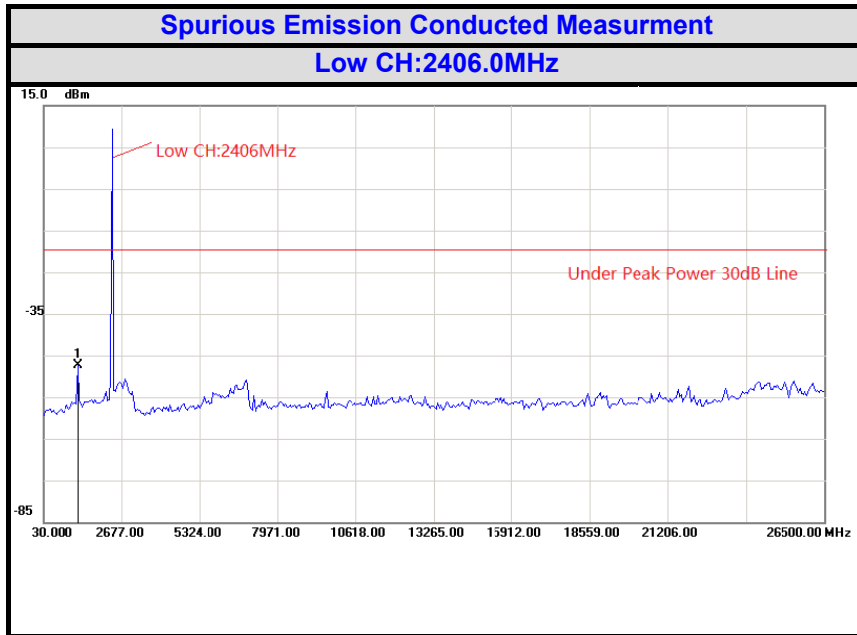

Copyright of this report is owned by Centre of Testing Service and may not be reproduced other than in full except with the written approval of the issuing Company.

**CENTRE OF TESTING SERVICE CO., LTD.**

A101, No.65, Zhuji Highway, Tianhe District, Guangzhou, China

Tel: +86-20-85543113 (32 lines)

Fax: +86-20-38780406

Complaint line: +86-20-85533471

E-mail: cts@cts-lab.com.cn

See Reverse For Terms And Conditions of Service



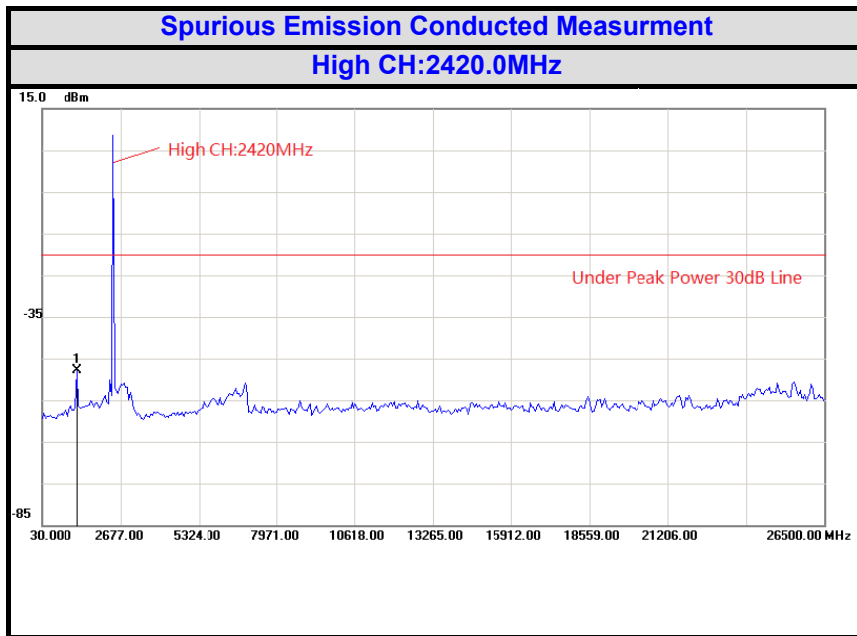
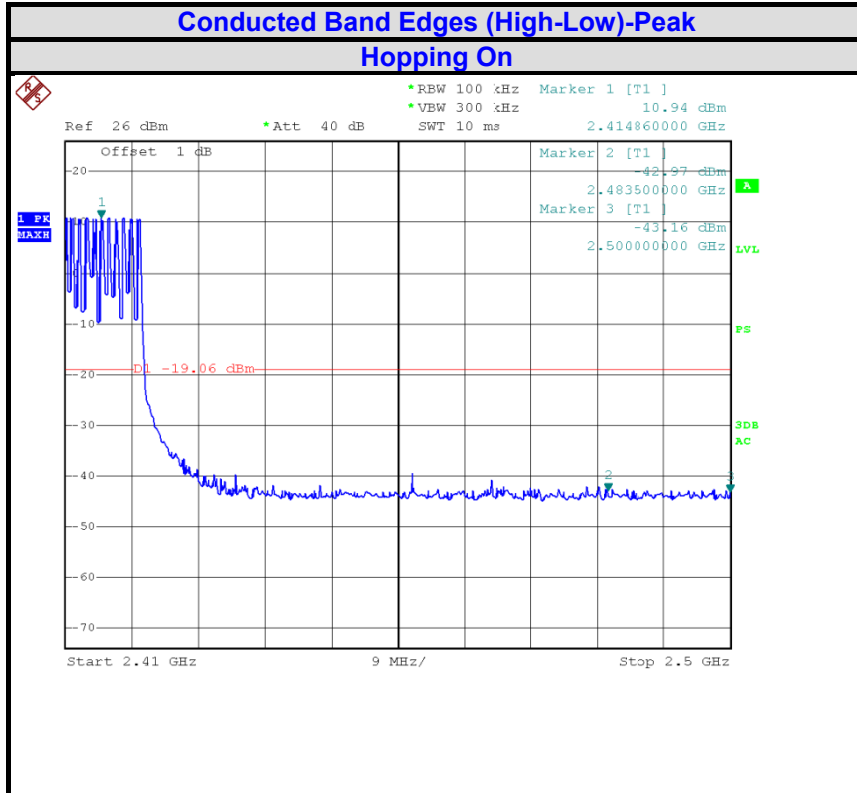

Copyright of this report is owned by Centre of Testing Service and may not be reproduced other than in full except with the written approval of the issuing Company.

**CENTRE OF TESTING SERVICE CO., LTD.**

A101, No.65, Zhuji Highway, Tianhe District, Guangzhou, China

Tel: +86-20-85543113 (32 lines)

Fax: +86-20-38780406

Complaint line: +86-20-85533471

E-mail: cts@cts-lab.com.cn

See Reverse For Terms And Conditions of Service

## 11.0 FREQUENCY SEPARATION

### 11.1 LIMIT

According to FCC Part 15.247(a)(1), Frequency hopping systems shall have hopping channel carrier frequencies separated by a minimum of 25 kHz or the 20 dB bandwidth of the hopping channel, whichever is greater. Alternatively, frequency hopping systems operating in the 2400-2483.5 MHz band may have hopping channel carrier frequencies that are separated by 25 kHz or two-thirds of the 20 dB bandwidth of the hopping channel, whichever is greater, provided the systems operate with an output power no greater than 125 mW.

### 11.2 MEASUREMENT EQUIPMENT USED

Frequency Separation					
Item	Test Equipment	Manufacturer	Model No.	Serial No.	Last Cal.
1	Signal analyzer	ROHDE & SCHWARZ	FSIQ26	100311	2017/03

### 11.3 TEST CONFIGURATION

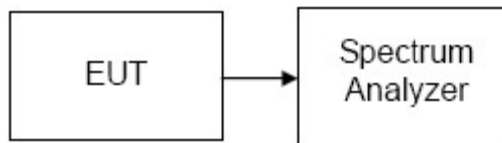

### 11.4 TEST PROCEDURE

1. Place the EUT on the table and set it in transmitting mode.
2. Remove the antenna from the EUT and then connect a low loss RF cable from the antenna port to the spectrum analyzer.
3. Set center frequency of spectrum analyzer = middle of hopping channel.
4. Set the spectrum analyzer as RBW=100KHz, VBW=300KHz, Adjust Span to 12 MHz, Sweep = auto.
5. Max hold. Mark 3 Peaks of hopping channel and record the 3 peaks frequency.

### 11.5 TEST RESULTS

PASSED

**Test Data**

Channel Separation (MHz)	Two-thirds of the 20dB Bandwidth (MHz)	Channel Separation Limit	Result
1.0	0.64	> Two-thirds of the 20 dB Bandwidth	PASSED

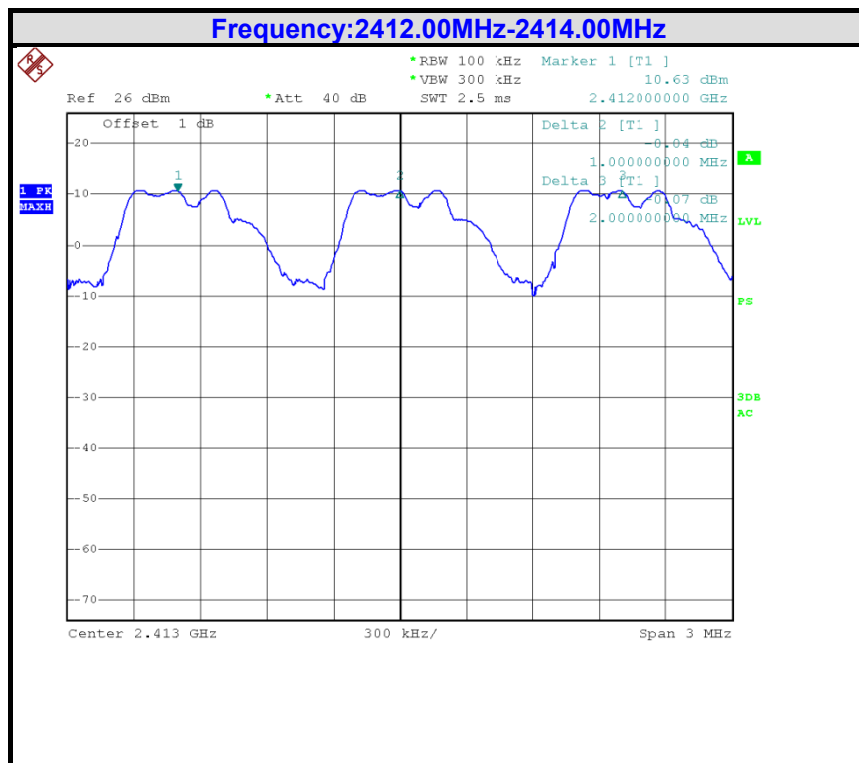

Copyright of this report is owned by Centre of Testing Service and may not be reproduced other than in full except with the written approval of the issuing Company.

**CENTRE OF TESTING SERVICE CO., LTD.**

A101, No.65, Zhuji Highway, Tianhe District, Guangzhou, China

Tel: +86-20-85543113 (32 lines)

Fax: +86-20-38780406

Complaint line: +86-20-85533471

E-mail: cts@cts-lab.com.cn

See Reverse For Terms And Conditions of Service

## 12.0 NUMBER OF HOPPING FREQUENCY

### 12.1 LIMIT

According to FCC Part 15.247(a)(1)(iii), Frequency hopping systems operating in the 2400MHz-2483.5 MHz bands shall use at least 15 hopping frequencies.

### 12.2 MEASUREMENT EQUIPMENT USED

Peak Power Spectral Density					
Item	Test Equipment	Manufacturer	Model No.	Serial No.	Last Cal.
1	Signal analyzer	ROHDE & SCHWARZ	FSIQ26	100311	2017/03

### 12.3 TEST CONFIGURATION

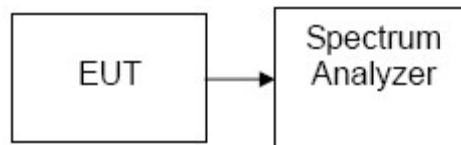

### 12.4 TEST PROCEDURE

1. Place the EUT on the table and set it in transmitting mode.
2. Remove the antenna from the EUT and then connect a low loss RF cable from the antenna port to the spectrum analyzer.
3. Set spectrum analyzer Start=2400MHz, Stop = 2483.5 MHz, Sweep = Auto,
4. Set the spectrum analyzer as RBW, VBW=1MHz,
5. Max hold, view and count how many channel in the band.

### 12.5 TEST RESULTS

PASSED

### 12.6 TEST DATA

Result(No. of CH)	Limit	Result
15	≥15	Pass

Test Plot :

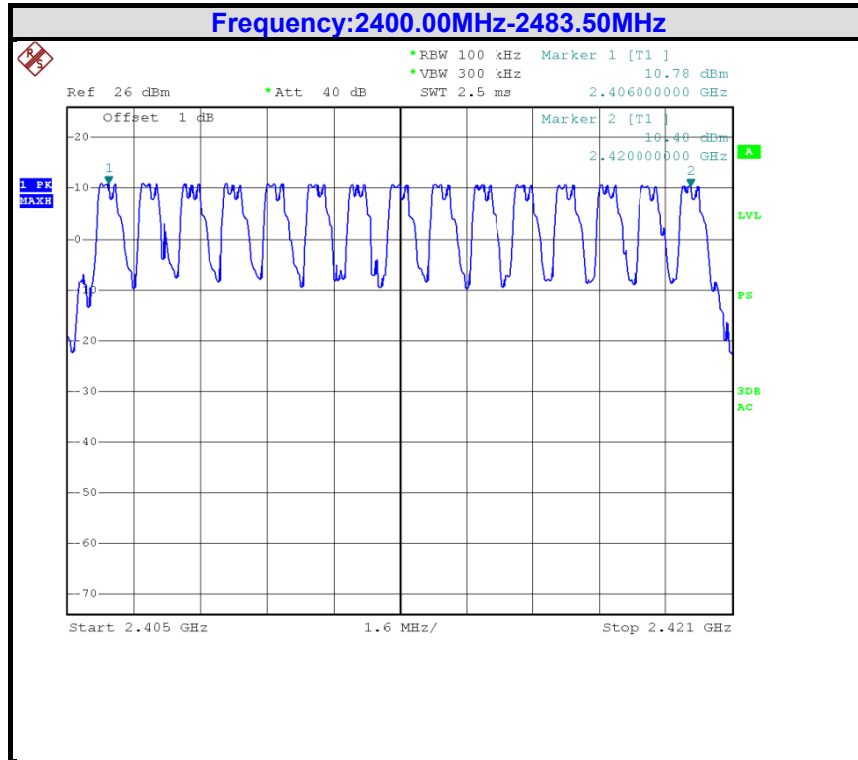

Copyright of this report is owned by Centre of Testing Service and may not be reproduced other than in full except with the written approval of the issuing Company.

**CENTRE OF TESTING SERVICE CO., LTD.**

A101, No.65, Zhuji Highway, Tianhe District, Guangzhou, China

Tel: +86-20-85543113 (32 lines)

Fax: +86-20-38780406

Complaint line: +86-20-85533471

E-mail: cts@cts-lab.com.cn

See Reverse For Terms And Conditions of Service

### 13.0 TIME OF OCCUPANCY (DWELL TIME)

#### 13.1 LIMIT

According to FCC Part 15.247(a)(1)(iii), Frequency hopping systems operating in the 2400MHz-2483.5 MHz bands. The average time of occupancy on any channels shall not greater than 0.4 s within a period 0.4 s multiplied by the number of hopping channels employed.

#### 13.2 MEASUREMENT EQUIPMENT USED

Frequency Separation					
Item	Test Equipment	Manufacturer	Model No.	Serial No.	Last Cal.
1	Signal analyzer	ROHDE & SCHWARZ	FSIQ26	100311	2017/03

#### 13.3 TEST CONFIGURATION

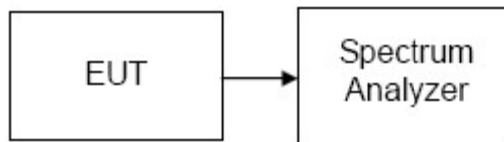

#### 13.4 TEST PROCEDURE

1. Place the EUT on the table and set it in transmitting mode.
2. Remove the antenna from the EUT and then connect a low loss RF cable from the antenna port to the spectrum analyzer.
3. Set center frequency of spectrum analyzer = operating frequency.
4. Set the spectrum analyzer as RBW, VBW=1MHz, Span = 0Hz, Sweep = auto.
5. Repeat above procedures until all frequency measured were complete.

#### 13.5 TEST RESULTS

PASSED

#### 13.6 TEST DATA

Dwell time:  $0.544 * 20 * 10 = 108.80(\text{ms})$

Pulse Time (ms)	Total of Dwell (ms)	Period Time (s)	Limit (ms)	Result
0.544	108.80	6.0(15*0.4)	400.00	PASS



Test Plot

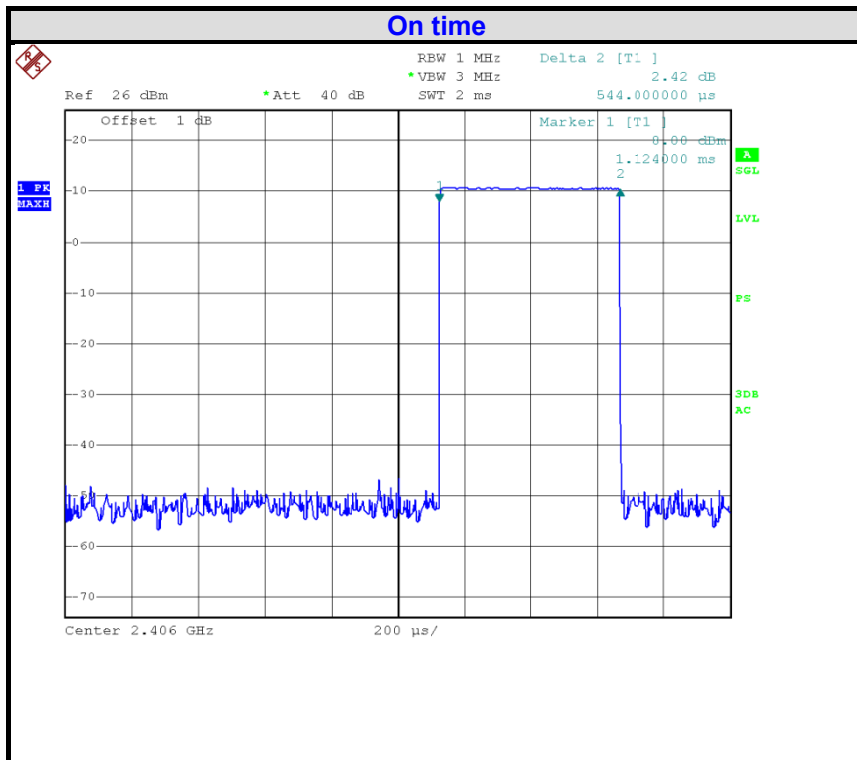
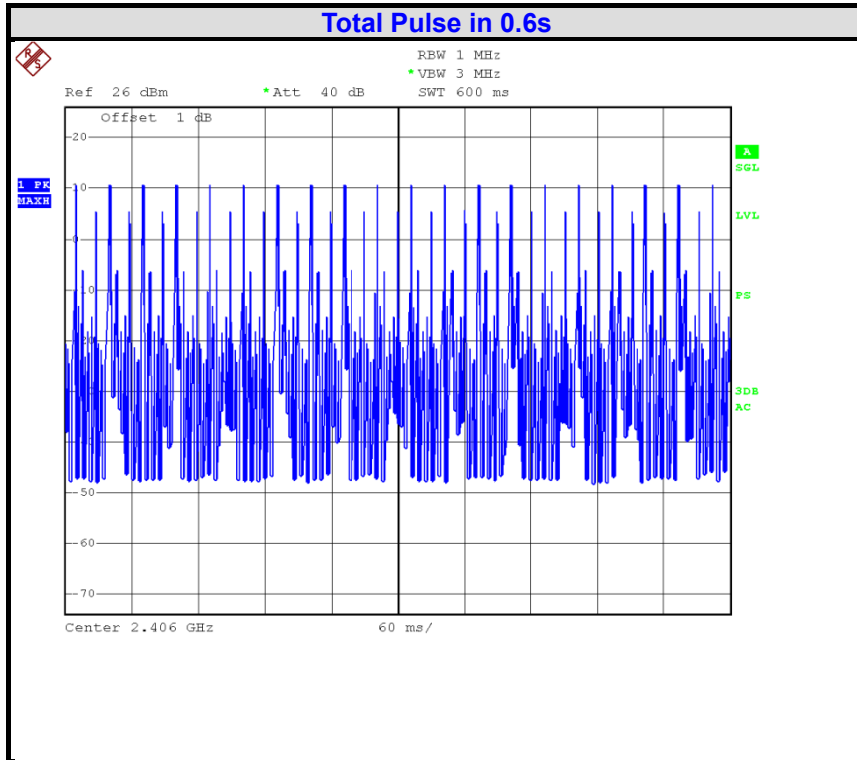

Copyright of this report is owned by Centre of Testing Service and may not be reproduced other than in full except with the written approval of the issuing Company.

**CENTRE OF TESTING SERVICE CO., LTD.**

A101, No.65, Zhuji Highway, Tianhe District, Guangzhou, China

Tel: +86-20-85543113 (32 lines)

Fax: +86-20-38780406

Complaint line: +86-20-85533471

E-mail: cts@cts-lab.com.cn

See Reverse For Terms And Conditions of Service

## 14.0 TRANSMITTER UNWANTED EMISSIONS

### 14.1 LIMIT

According to FCC Part 15.209 .Except as provided elsewhere in this Subpart, the emissions from an intentional radiator shall not exceed the field strength levels specified in the following table:

FREQUENCY MHz	DISTANCE Meters	FIELD STRENGTHS LIMIT	
		$\mu\text{V}/\text{m}$	$\text{dB}(\mu\text{V})/\text{m}$
0.009 ~ 0.490	300	2400/F(kHz)	---
0.490 ~ 1.705	30	24000/F(kHz)	---
1.705 ~ 30	30	30	---
30 ~ 88	3	100	40.0
88 ~ 216	3	150	43.5
216 ~ 960	3	200	46.0
960 ~ 1000	3	500	54.0
Above 1000	3	Other:74.0 $\text{dB}(\mu\text{V})/\text{m}$ (Peak) 54.0 $\text{dB}(\mu\text{V})/\text{m}$ (Average)	

Note: Except as provided in paragraph (g), fundamental emissions from intentional radiators operating under this Section shall not be located in the frequency bands 54-72 MHz, 76-88 MHz, 174-216 MHz or 470-806 MHz. However, operation within these frequency bands is permitted under other sections of this Part, e.g., Sections 15.231 and 15.241.

### 14.2 TEST EQUIPMENT

Radiated disturbance (electric field)					
Item	Test Equipment	Manufacturer	Model No.	Serial No.	Last Cal.
1	EMI Test Receiver	ROHDE & SCHWARZ	ESCI	100868	2016/10
2	Biconical Antenna	ROHDE & SCHWARZ	HK116	100221	2017/03
3	Log per Antenna	ROHDE & SCHWARZ	HL223	100226	2017/03
4	Log per Antenna	ROHDE & SCHWARZ	HL050	100186	2017/03
5	Signal analyzer	ROHDE & SCHWARZ	FSIQ26	100311	2017/03
6	Loop Antenna	A.R.A	PLA-1030/B	1030	2016/10
7	EMI Test Software	EZ-EMC	Farad	N/A	N/A

Copyright of this report is owned by Centre of Testing Service and may not be reproduced other than in full except with the written approval of the issuing Company.

#### CENTRE OF TESTING SERVICE CO., LTD.

A101, No.65, Zhuji Highway, Tianhe District, Guangzhou, China

Tel: +86-20-85543113 (32 lines)

Fax: +86-20-38780406

Complaint line: +86-20-85533471

E-mail: cts@cts-lab.com.cn

See Reverse For Terms And Conditions of Service



### 14.3 TEST CONFIGURATION

Below 30MHz

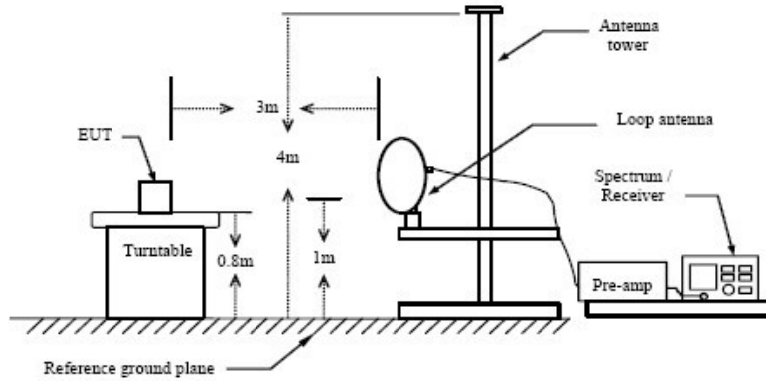

Below 1 GHz

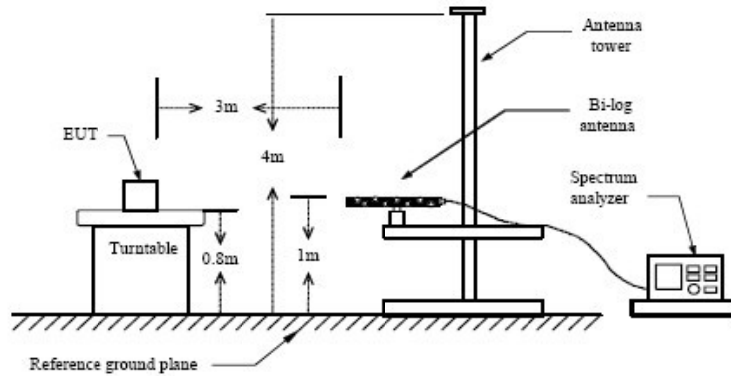

Above 1 GHz

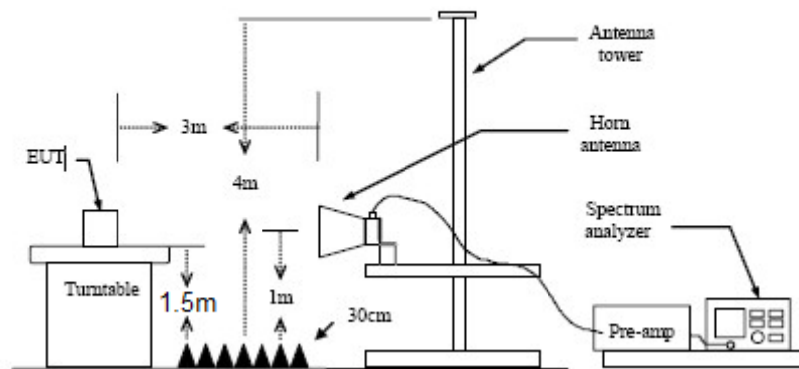

Copyright of this report is owned by Centre of Testing Service and may not be reproduced other than in full except with the written approval of the issuing Company.

**CENTRE OF TESTING SERVICE CO., LTD.**

A101, No.65, Zhuji Highway, Tianhe District, Guangzhou, China

Tel: +86-20-85543113 (32 lines)

Fax: +86-20-38780406

Complaint line: +86-20-85533471

E-mail: cts@cts-lab.com.cn

See Reverse For Terms And Conditions of Service

**14.4 TEST PROCEDURE**

1. The EUT is placed on a turntable, which is 0.8m (1.5m for Above 1GHz )above ground plane.
2. The turntable shall be rotated for 360 degrees to determine the position of maximum emission level.
3. EUT is set 3m away from the receiving antenna, which is varied from 1m to 4m to find out the highest emissions.
4. Maximum procedure was performed on the six highest emissions to ensure EUT compliance.
5. And also, each emission was to be maximized by changing the polarization of receiving antenna both horizontal and vertical.
6. Repeat above procedures until the measurements for all frequencies are complete.

**14.5 TEST RESULTS**

The frequency range from 9KHz~30MHz,30MHz to 230MHz, 230MHz to 1000MHz and above 1GHz. is investigated. Please see the following pages.



Test Mode:	TX -X Position Mode	Result:	<input checked="" type="checkbox"/> - passed
Frequency range:	9KHz~30MHz		<input type="checkbox"/> - not passed

No.	Frequency (MHz)	Factor (dB)	Reading (dBuV)	Level (dBuV/m)	Limit (dBuV/m)	Margin (dB)	Det.
Remark: The test result reading value is to low, margin all > 20dB of the limit.							

Copyright of this report is owned by Centre of Testing Service and may not be reproduced other than in full except with the written approval of the issuing Company.

**CENTRE OF TESTING SERVICE CO., LTD.**

A101, No.65, Zhuji Highway, Tianhe District, Guangzhou, China

Tel: +86-20-85543113 (32 lines)

Fax: +86-20-38780406

Complaint line: +86-20-85533471

E-mail: cts@cts-lab.com.cn

See Reverse For Terms And Conditions of Service

EUT	2.4GHz Transmitter
Operating Condition	Battery 1.5V*4
Test Condition	Ambient Temperature: 25°C Humidity: 56%
Test distance	3 Meter
Operator	Duke
MODEL NO	CTX-8000

Channel:	TX -X Position	Result:	<input checked="" type="checkbox"/> - passed
Test point:	Horizontal		<input type="checkbox"/> - not passed
Frequency range:	30MHz-1GHz		

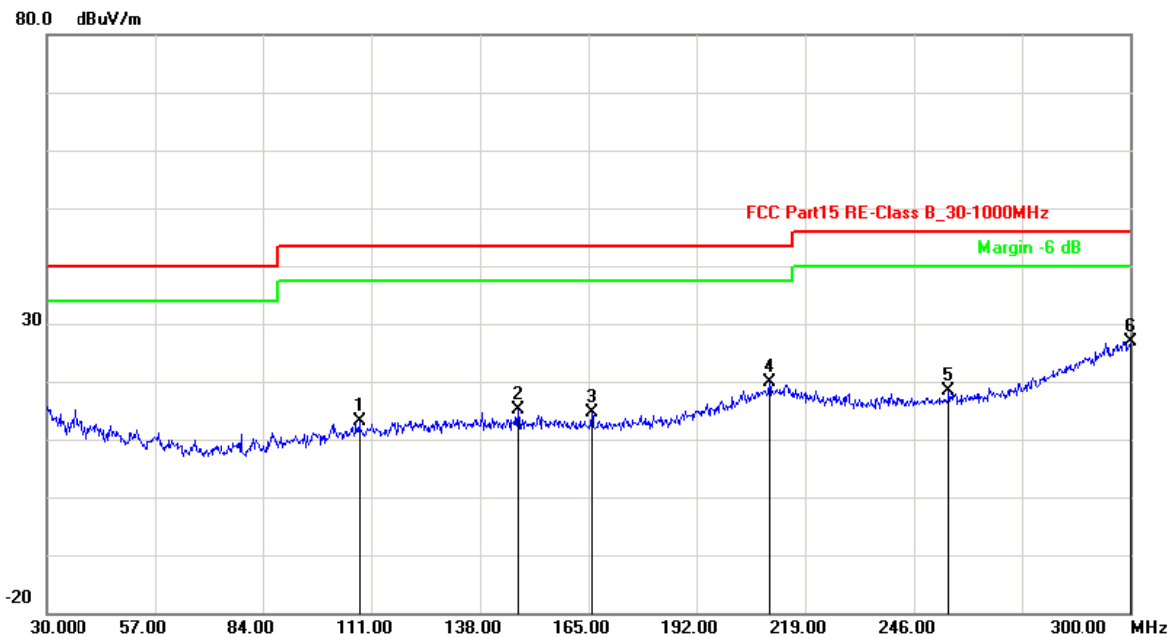

No.	Frequency (MHz)	Factor (dB)	Reading (dBuV)	Level (dBuV/m)	Limit (dBuV/m)	Margin (dB)	Det.
1	107.7600	-16.88	29.99	13.11	43.50	-30.39	QP
2	147.4500	-15.32	30.37	15.05	43.50	-28.45	QP
3	165.8100	-15.39	30.13	14.74	43.50	-28.76	QP
4	210.0900	-9.59	29.40	19.81	43.50	-23.69	QP
5	254.9100	-10.69	28.95	18.26	46.00	-27.74	QP
6	300.0000	-1.13	28.00	26.87	46.00	-19.13	QP

Remark: Other frequency mini margin all >6 dB of Limit

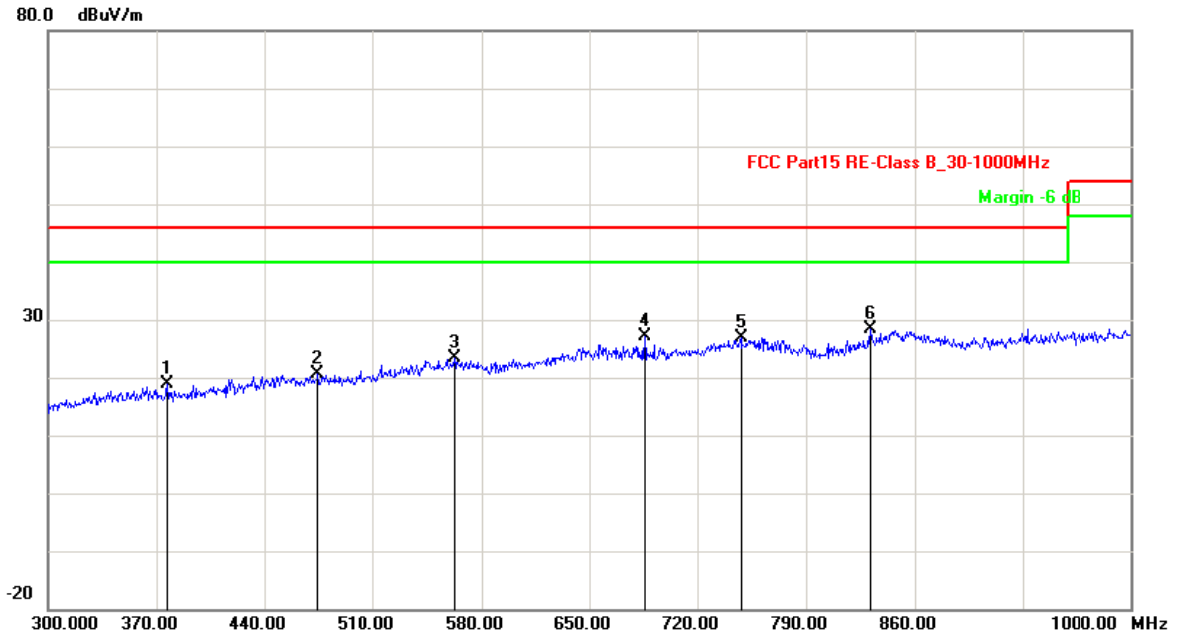

No.	Frequency (MHz)	Factor (dB)	Reading (dBuV)	Level (dBuV/m)	Limit (dBuV/m)	Margin (dB)	Det.
1	377.0000	-10.63	29.57	18.94	46.00	-27.06	QP
2	474.3000	-7.95	28.50	20.55	46.00	-25.45	QP
3	562.5000	-5.49	28.86	23.37	46.00	-22.63	QP
4	685.7000	-3.22	30.23	27.01	46.00	-18.99	QP
5	748.0000	-1.41	28.41	27.00	46.00	-19.00	QP
6	831.3000	-1.19	29.67	28.48	46.00	-17.52	QP

Remark: Other frequency mini margin all >6 dB of Limit

Channel:	Low Channel	Result:	<input checked="" type="checkbox"/> - passed
Test point:	Horizontal		<input type="checkbox"/> - not passed
Frequency range:	1GHz-26.5GHz		

No.	Frequency (MHz)	Factor (dB)	Reading (dBuV)	Level (dBuV/m)	Limit (dBuV/m)	Margin (dB)	Det.
1	3336.673	3.92	36.68	40.60	74.00	-33.40	peak
2	3336.673	3.92	24.49	28.41	54.00	-25.59	AVG
3	5871.743	8.50	40.31	48.81	74.00	-25.19	peak
4	5871.743	8.50	27.78	36.28	54.00	-17.72	AVG

Remark: Other frequency mini margin all >20 dB of Limit

Copyright of this report is owned by Centre of Testing Service and may not be reproduced other than in full except with the written approval of the issuing Company.

**CENTRE OF TESTING SERVICE CO., LTD.**

A101, No.65, Zhuji Highway, Tianhe District, Guangzhou, China

Tel: +86-20-85543113 (32 lines)

Fax: +86-20-38780406

Complaint line: +86-20-85533471

E-mail: cts@cts-lab.com.cn

See Reverse For Terms And Conditions of Service



Channel:	Middle Channel	Result: <input checked="" type="checkbox"/> - passed <input type="checkbox"/> - not passed
Test point:	Horizontal	
Frequency range:	1GHz-26.5GHz	

No.	Frequency (MHz)	Factor (dB)	Reading (dBuV)	Level (dBuV/m)	Limit (dBuV/m)	Margin (dB)	Det.
1	1507.014	1.86	40.21	42.07	74.00	-31.93	peak
2	1507.014	1.86	28.19	30.05	54.00	-23.95	AVG
3	5541.082	7.53	39.13	46.66	74.00	-27.34	peak
4	5541.082	7.53	26.18	33.71	54.00	-20.29	AVG

Remark: Other frequency mini margin all >20 dB of Limit

Channel:	High Channel	Result: <input checked="" type="checkbox"/> - passed <input type="checkbox"/> - not passed
Test point:	Horizontal	
Frequency range:	1GHz-26.5GHz	

No.	Frequency (MHz)	Factor (dB)	Reading (dBuV)	Level (dBuV/m)	Limit (dBuV/m)	Margin (dB)	Det.
1	1837.675	3.78	39.75	43.53	74.00	-30.47	peak
2	1837.675	3.78	27.63	31.41	54.00	-22.59	AVG
3	5452.906	7.27	39.16	46.43	74.00	-27.57	peak
4	5452.906	7.27	26.41	33.68	54.00	-20.32	AVG

Remark: Other frequency mini margin all >20 dB of Limit

Copyright of this report is owned by Centre of Testing Service and may not be reproduced other than in full except with the written approval of the issuing Company.

**CENTRE OF TESTING SERVICE CO., LTD.**

A101, No.65, Zhuji Highway, Tianhe District, Guangzhou, China

Tel: +86-20-85543113 (32 lines)

Fax: +86-20-38780406

Complaint line: +86-20-85533471

E-mail: cts@cts-lab.com.cn

See Reverse For Terms And Conditions of Service

Channel:	TX -X Position	Result:	■ - passed
Test point:	Vertical		□ - not passed
Frequency range:	30MHz-1GHz		

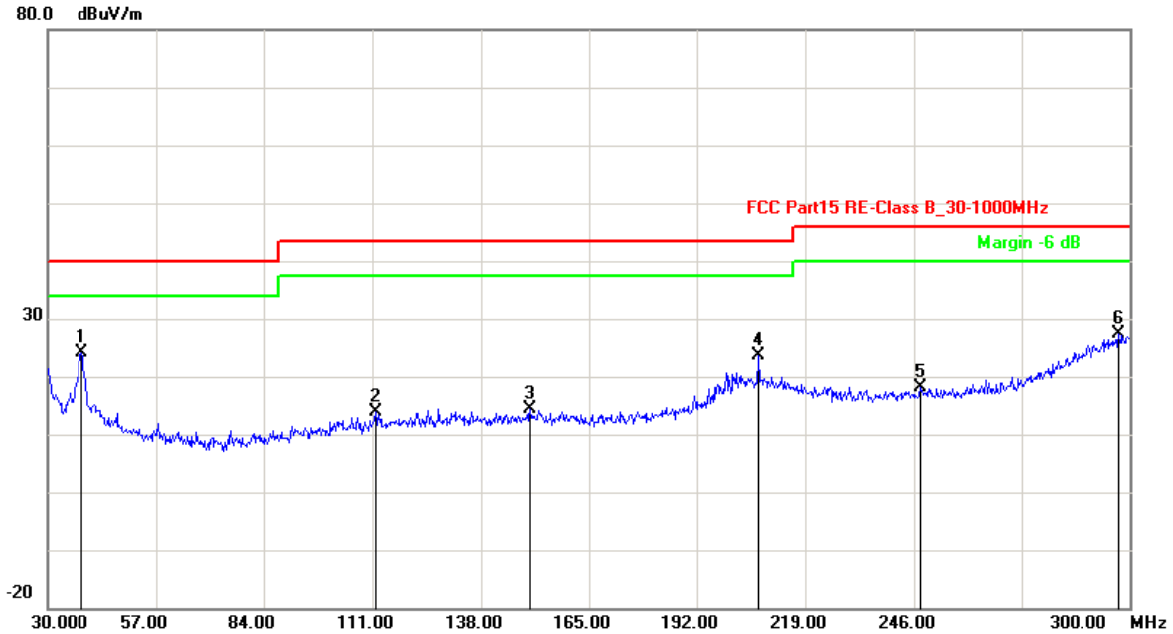

No.	Frequency (MHz)	Factor (dB)	Reading (dBuV)	Level (dBuV/m)	Limit (dBuV/m)	Margin (dB)	Det.
1	38.3700	-16.25	40.31	24.06	40.00	-15.94	QP
2	111.8100	-16.59	30.35	13.76	43.50	-29.74	QP
3	150.4200	-15.29	29.56	14.27	43.50	-29.23	QP
4	207.3900	-10.14	33.70	23.56	43.50	-19.94	QP
5	247.6200	-11.04	29.16	18.12	46.00	-27.88	QP
6	297.3000	-1.84	29.17	27.33	46.00	-18.67	QP

Remark: Other frequency mini margin all >6 dB of Limit

Copyright of this report is owned by Centre of Testing Service and may not be reproduced other than in full except with the written approval of the issuing Company.

**CENTRE OF TESTING SERVICE CO., LTD.**

A101, No.65, Zhuji Highway, Tianhe District, Guangzhou, China

Tel: +86-20-85543113 (32 lines)

Fax: +86-20-38780406

Complaint line: +86-20-85533471

E-mail: cts@cts-lab.com.cn

See Reverse For Terms And Conditions of Service

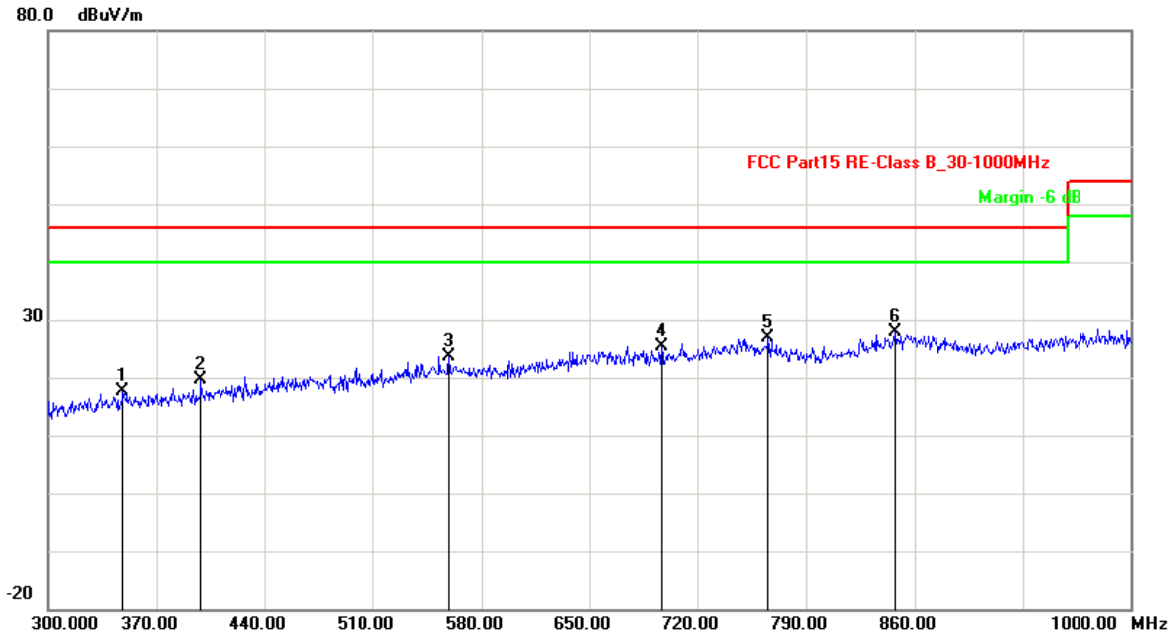

No.	Frequency (MHz)	Factor (dB)	Reading (dBuV)	Level (dBuV/m)	Limit (dBuV/m)	Margin (dB)	Det.
1	348.3000	-11.11	28.73	17.62	46.00	-28.38	QP
2	398.7000	-10.30	29.95	19.65	46.00	-26.35	QP
3	559.0000	-5.49	29.17	23.68	46.00	-22.32	QP
4	696.9000	-3.24	28.63	25.39	46.00	-20.61	QP
5	765.5000	-1.84	28.72	26.88	46.00	-19.12	QP
6	847.4000	-0.28	28.21	27.93	46.00	-18.07	QP

Remark: Other frequency mini margin all >6 dB of Limit

Channel:	Low Channel	Result:	<input checked="" type="checkbox"/> - passed
Test point:	Vertical		<input type="checkbox"/> - not passed
Frequency range:	1GHz-26.5GHz		

No.	Frequency (MHz)	Factor (dB)	Reading (dBuV)	Level (dBuV/m)	Limit (dBuV/m)	Margin (dB)	Det.
1	3821.643	2.93	37.35	40.28	74.00	-33.72	peak
2	3821.643	2.93	25.48	28.41	54.00	-25.59	AVG
3	6048.096	9.00	40.69	49.69	74.00	-24.31	peak
4	6048.096	9.00	28.62	37.62	54.00	-16.38	AVG

Remark: Other frequency mini margin all >20 dB of Limit

Copyright of this report is owned by Centre of Testing Service and may not be reproduced other than in full except with the written approval of the issuing Company.

**CENTRE OF TESTING SERVICE CO., LTD.**

A101, No.65, Zhuji Highway, Tianhe District, Guangzhou, China

Tel: +86-20-85543113 (32 lines)

Fax: +86-20-38780406

Complaint line: +86-20-85533471

E-mail: cts@cts-lab.com.cn

See Reverse For Terms And Conditions of Service





Channel:	Middle Channel	Result: <input checked="" type="checkbox"/> - passed <input type="checkbox"/> - not passed
Test point:	Vertical	
Frequency range:	1GHz-26.5GHz	

No.	Frequency (MHz)	Factor (dB)	Reading (dBuV)	Level (dBuV/m)	Limit (dBuV/m)	Margin (dB)	Det.
1	3821.643	2.93	35.81	38.74	74.00	-35.26	peak
2	3821.643	2.93	22.85	25.78	54.00	-28.22	AVG
3	5695.391	7.98	36.85	44.83	74.00	-29.17	peak
4	5695.391	7.98	24.32	32.30	54.00	-21.70	AVG
Remark: Other frequency mini margin all >20 dB of Limit							

Channel:	High Channel	Result: <input checked="" type="checkbox"/> - passed <input type="checkbox"/> - not passed
Test point:	Vertical	
Frequency range:	1GHz-26.5GHz	

No.	Frequency (MHz)	Factor (dB)	Reading (dBuV)	Level (dBuV/m)	Limit (dBuV/m)	Margin (dB)	Det.
1	3777.555	3.02	37.67	40.69	74.00	-33.31	peak
2	3777.555	3.02	25.39	28.41	54.00	-25.59	AVG
3	5651.303	7.85	39.50	47.35	74.00	-26.65	peak
4	5651.303	7.85	27.39	35.24	54.00	-18.76	AVG
Remark: Other frequency mini margin all >20 dB of Limit							

Copyright of this report is owned by Centre of Testing Service and may not be reproduced other than in full except with the written approval of the issuing Company.

**CENTRE OF TESTING SERVICE CO., LTD.**

A101, No.65, Zhuji Highway, Tianhe District, Guangzhou, China

Tel: +86-20-85543113 (32 lines)

Fax: +86-20-38780406

Complaint line: +86-20-85533471

E-mail: cts@cts-lab.com.cn

See Reverse For Terms And Conditions of Service

## 15.0 Antenna Requirements

### 15.1 Standard Applicable

For intentional device, according to FCC 47 CFR Section 15.203, an intentional radiator shall be designed to ensure that no antenna other than that furnished by the responsible party shall be used with the device.

And according to FCC 47 CFR Section 15.247 (b), if transmitting antennas of directional gain greater than 6dBi are used, the power shall be reduced by the amount in dB that the directional gain of the antenna exceeds 6dBi.

### 15.2 Antenna Construction and Directional Gain

Antenna type: External antenna  
Antenna Gain: 2dBi

## 17.0 DEVIATION TO TEST SPECIFICATIONS

The following identical model(s):

N/A

Belong to the tested device:

Product description: **2.4GHz Transmitter**  
Model name: **CTX-8000**

Copyright of this report is owned by Centre of Testing Service and may not be reproduced other than in full except with the written approval of the issuing Company.

### CENTRE OF TESTING SERVICE CO., LTD.

A101, No.65, Zhuji Highway, Tianhe District, Guangzhou, China

Tel: +86-20-85543113 (32 lines)

Fax: +86-20-38780406

Complaint line: +86-20-85533471

E-mail: cts@cts-lab.com.cn

See Reverse For Terms And Conditions of Service