



Rider
330

User's Manual



Table of Contents

Getting Started	4	Set Alert	19
Your Rider 330	4	Smart Pause	19
Accessories	5	Data Record	20
Status Icons	5	Personalize User Profile	21
Step 1: Charge your Rider 330 ...	6	Personalize Bike Profile	22
Step 2: Turn On Rider 330	6	Change System Settings	23
Step 3: Initial Setup.....	6	View GPS Status	25
Step 4: Acquire Satellite		View Software Version	26
Signals.....	7	Bluetooth	26
Step 5: Ride Your Bike with		Configure Acto Scroll	27
Rider 330.....	7	Enable File Saving Mode	27
Reset Rider 330	7	Start Reminder	28
Share Your Records	8	View Memory Usage	28
Training	9	Reset Data	29
Simple Workouts	9	Sensors	30
Interval Workouts	10	Appendix	31
My Workout	12	Specifications	31
Bryton Test	12	Battery Information	32
Stop Training	13	Install Rider 330	33
View Exercise/Training		Install the Speed/Cadence/ Dual Sensor (Optional)	34
Record	13	Install Heart Rate Belt (Optional).....	35
History Flow.....	14	Wheel Size and Circumference	36
Settings	15	Basic Care For Your Rider 330... Data Fields	37 38
Smart Lap.....	15		
Altitude	16		
Data Page	17		



WARNING

Always consult your physician before you begin or modify any training program. Please read the details in Warranty and Safety Information guide in the package.

Product Registration

Help us better support you by completing your device registration using Bryton Update Tool. Go to <http://corp.brytonsport.com/products/support>.

Bryton Software

Go to <http://brytonsport.com> to upload tracks and analyze your data on the web.

Australian Consumer Law

Our goods come with guarantees that can not be excluded under the New Zealand and Australian Consumer Laws. You are entitled to a replacement or refund for a major failure and for compensation for any other reasonably foreseeable loss or damage. You are also entitled to have the goods repaired or replaced if the goods fail to be of acceptable quality and the failure does not amount to a major failure.

Getting Started

This section will guide you on the basic preparations before you start using your Rider 330. Rider 330 is equipped with barometer which shows the real time altitude.

NOTE: To adjust the altitude settings on Rider 330, refer to page 16.

Your Rider 330

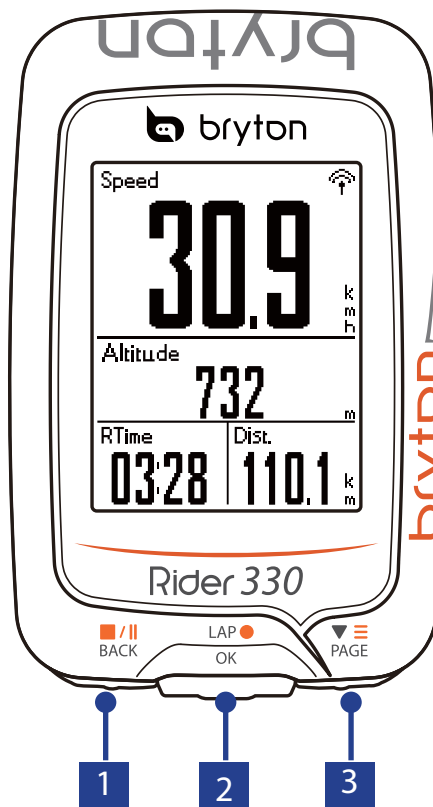

1 BACK (■/||)

- Press and hold to turn the device off.
- Press to return to the previous page or cancel an operation.
- When recording, press to pause recording. Press it again to stop recording.

2 LAP/OK (LAP/OK)

- Press to turn the device on.
- In Menu, press to enter or confirm a selection.
- In free cycling, press to start recording.
- When recording, press to mark the lap.

3 PAGE (▼/≡)

- In Menu, press to move down to scroll through menu options.
- In Meter view, press to switch meter screen page.

Accessories









The Rider 330 comes with the following accessories:









- USB cable
- Bike mount

Optional items:

- Heart rate belt
- Speed sensor
- Cadence sensor
- Speed/Cadence Dual sensor
- Out-front Bike Mount

Status Icons

Icon	Description
Bike Type	
	Bike 1
	Bike 2
GPS Signal Status	
	No signal (not fixed)
	Weak signal
	Strong signal
Power Status	
	Full battery
	Half battery
	Low battery

Icon	Description
	Heart Rate Sensor Active
	Cadence Sensor Active
	Speed Sensor Active
	Dual Sensor Active
	Notification
	Log Record in Progress
	Recording is paused
	Bluetooth function is enabled

NOTE: Only the active icons are displayed on the screen.
Some icons may only apply to certain models

Step 1: Charge your Rider 330

Connect Rider 330 to a PC to charge the battery for at least 4 hours. Unplug the device when it is fully charged.

- You may see a white screen when the battery is really low. Keep the device plugged for several minutes, it will automatically turn-on after battery is properly charged.
- The temperature suitable for charging battery is 0°C ~ 40°C. Beyond this temperature range, charging will be terminated and the device will draw power from battery.

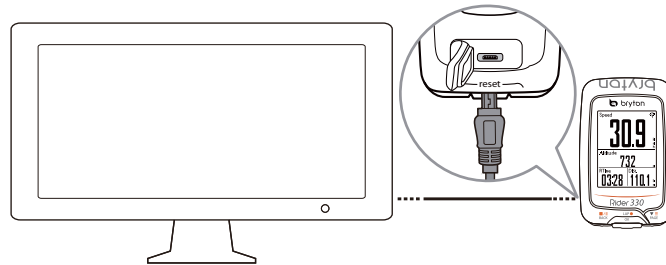

Step 2: Turn On Rider 330

Press $\overset{\text{LAP}}{\underset{\text{OK}}{\bullet}}$ to turn on the device.

Step 3: Initial Setup

When turning Rider 330 on for the first time, the setup wizard appears on screen. Follow the instructions to complete setup.

1. Select the display language.
2. Select the unit of measurement.





NOTE: Only when you choose English for the display language, you will need to select the unit of measurement. Otherwise, default would be metric unit.

Step 4: Acquire Satellite Signals

Once the Rider 330 is turned on, it will automatically search for satellite signals. It may take 30 to 60 seconds to acquire signals. Please make sure you acquire the satellite signal for the first time use.

The GPS signal icon (📶/📶) appears when GPS is fixed.

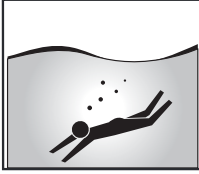
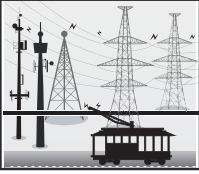
- If the GPS signal is not fixed, an 📶^x icon appears on the screen.
- Please avoid the obstructed environments since they might affect the GPS reception.



				
Tunnels	Inside rooms, building, or underground	Under water	High-voltage wires or television towers	Construction sites and heavy traffic

Step 5: Ride Your Bike with Rider 330

- **Free ride:**

In meter view, measurement starts and stops automatically in sync with the movement of the bicycle.

- **Start an exercise and record your data:**

In meter view, press  to start recording, press  to pause, press  again to stop.

- **Start a training:**

Select **Train** from the menu list. Training can be based on time, distance, calories burn, or the saved workouts.

Reset Rider 330

To reset the Rider 330, long press all three keys ( /  / ) at the same time.



Download Bryton Update Tool

NOTE: Bryton Update Tool can notify you if a new software version or GPS data is available. The newer GPS data can speed up the GPS acquisition. We highly recommend you to check for updates every 1-2 weeks.

1. Go to <http://www.brytonsport.com/help/start> and download Bryton Update Tool .
2. Follow the on-screen instructions to install Bryton Update Tool.

Share Your Records

Share Your Tracks to Brytonsport.com

1. Sign up/log in on Brytonsport.com
 - a. Go to <http://www.brytonsport.com/help/start>.
 - b. Register a new account or use your current Bryton account to log in.

NOTE: Bryton account is the email address used to register as a member of [brytonsport.com](http://www.brytonsport.com)

2. Connect to PC

Turn on your Rider 330 and connect it to your computer by using USB cable.

3. Share Your Records

- a. Go to <http://www.brytonsport.com/help/landing>. Click "Upload Files" button. Then, click "Select from Files".
- b. Choose to save as "History". Then, click "Select and Upload files".
- c. Select FIT files from Bryton folder in the device.

Train & Test

Bicycling is one of the best types of exercise for your body. It helps you to burn your calories, lose weight, and increase your overall fitness. With the Rider 330 Training feature, you can set simple/interval workouts and use the Rider 330 to track your training or workout progress.

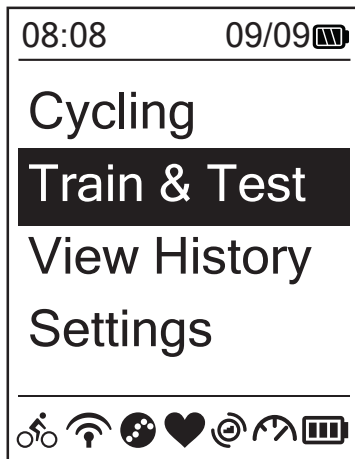

1. In the main screen, press $\nabla \equiv$ _{PAGE} to select **Train&Test**.
2. Press $\overset{\text{LAP}}{\bullet}$ _{OK} to enter the Training menu.

To Plan

You can set simple workouts by entering your time or distance goals.

The Rider 330 offers you three types of simple workouts: Time, Distance, and Calories.

Simple

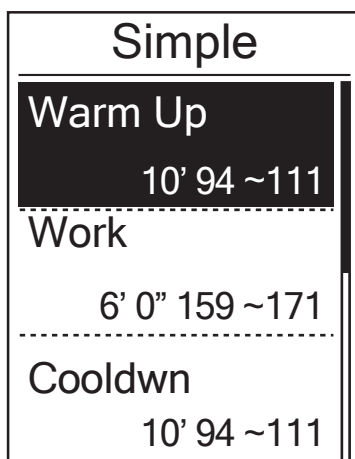

1. To set a simple workout, select **To Plan > Simple > Warm Up, Work , Cooldown**.
 - **Warm Up:**
Duration (manual, calorie,time, distance), Target (Pace, HR, MHR, LTHR).
 - **Work:**
Duration (calorie, time,distance), Target (Pace, MHR%, LTHR%, HR, MHR, LTHR, Off).
 - **Cooldown:**
Duration (manual, calorie,time, distance), Target (HR, MHR, LTHR).
2. Press \blacksquare / \parallel / $\nabla \equiv$ _{BACK / PAGE} to set your target and press $\overset{\text{LAP}}{\bullet}$ _{OK} to confirm.
3. Choose **Save** and enter the workout name using the on-screen keyboard.
4. Go for a ride.
Go to **Train & Test > My Workouts > View** and choose the saved workout. Press $\overset{\text{LAP}}{\bullet}$ _{OK} to start training and record log.

Using the On-screen Keyboard

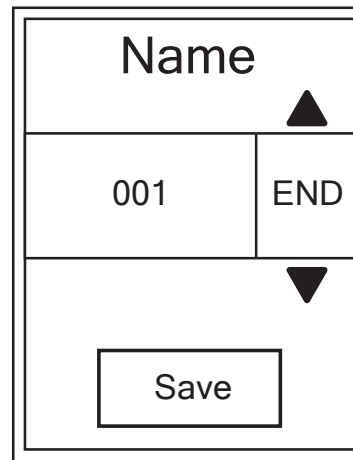
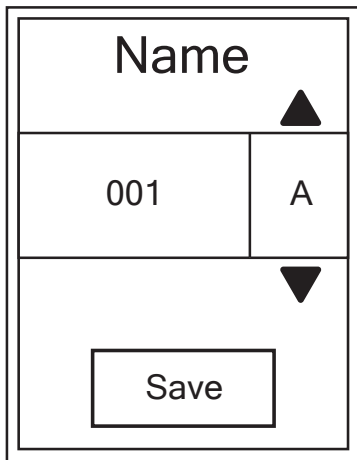

1. Press $\blacksquare/\parallel/\blacktriangledown\equiv$ to select the input character.
 - Select **DEL** to erase the data.
2. Press $\overset{\text{LAP}}{\underset{\text{OK}}{\bullet}}$ to confirm the selection.
3. When finished, press $\blacksquare/\parallel/\blacktriangledown\equiv$ to select **END** and press $\overset{\text{LAP}}{\underset{\text{OK}}{\bullet}}$ to confirm.

NOTE: If user does not enter the workout name, the system will automatically label the file name according to the current date and time.

Interval Workouts

With the Interval training feature, you can use your device to customize interval workouts which include the warm up, interval, and cool down sections.

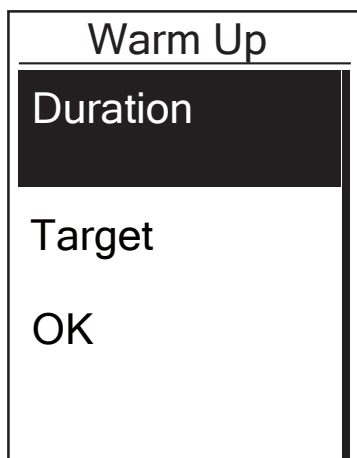

1. In the **Train & Test** menu, press $\blacktriangledown\equiv$ to select **To Plan > Interval** and press $\overset{\text{LAP}}{\underset{\text{OK}}{\bullet}}$ to enter.
2. A "Set warm up?" message appears on the screen. Press $\blacktriangledown\equiv$ to select **Yes** to set the "Warm up". After the settings are complete, select **OK** and press $\overset{\text{LAP}}{\underset{\text{OK}}{\bullet}}$ to continue.

Work 1	
Work	
6'00"	158~170bpm
Recovery	
2'00"	137~149bpm
Repeat Time	
2	

Cooldown	
Duration	
Target	
OK	

- Set the interval workout settings (Work, Recovery, and Repeat Time). When finished, press $\blacktriangledown \equiv$ _{PAGE} to select **Next** and press $\overset{\text{LAP}}{\bullet}$ _{OK}.
- A "Create a new main set?" message appears on the screen. To create another set of interval workout, select **Yes** and press $\overset{\text{LAP}}{\bullet}$ _{OK} to confirm.
- A "Set cool down?" message appears on the screen. Select **Yes** to set the "Cool down". After the settings are complete, select **OK** and press $\overset{\text{LAP}}{\bullet}$ _{OK} to continue.
- A "Save to My Workout" message appears on the screen. Select **Yes** and press $\overset{\text{LAP}}{\bullet}$ _{OK} to continue. Press \blacksquare / \parallel _{BACK} / $\blacktriangledown \equiv$ _{PAGE} to enter the workout name. When finishing the name, press \blacksquare / \parallel _{BACK} and press $\overset{\text{LAP}}{\bullet}$ _{OK} to save the workout.

My Workout

With My Workout feature, you can start your workout using the training plan that you have saved in **To Plan** menu.

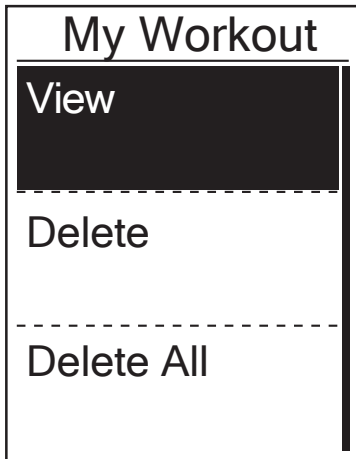

1. In the Training menu, press $\nabla \equiv$ _{PAGE} to select **My Workout** and press \bullet _{LAP OK}.
2. Press $\nabla \equiv$ _{PAGE} to select **View** and press \bullet _{LAP OK} to enter its submenu.
 - Press $\nabla \equiv$ _{PAGE} to select your desired training plan and press \bullet _{LAP OK} to confirm.
 - Go for a ride. Press \bullet _{LAP OK} to start training and record log.
3. To choose which workouts to delete, select **Delete**.
4. To delete all workouts to delete, select **Delete All**.

NOTE: If the selected workout includes several interval settings, a workout details appear on the screen. Select **Start** and press \bullet _{LAP OK} to proceed with the workout.

Bryton Test

Bryton Test has preloaded on Rider 330. If you don't have it on your device, please download from Bryton Update Tool. Bryton Test includes two test courses to help you measuring your MHR and/or LTHR. Knowing your MHR and/or LTHR gives you a benchmark of your overall efficiency. It also helps you to judge progress over time and measure your exercise intensity.

1. In the main screen, press $\nabla \equiv$ _{PAGE} to select **Train & Test** and press \bullet _{LAP OK} to enter Training menu.
2. Press $\nabla \equiv$ _{PAGE} to select **Bryton Test** and press \bullet _{LAP OK} to enter Bryton Test.
3. Press $\nabla \equiv$ _{PAGE} to select your desired test workout and press \bullet _{LAP OK} to enter the selected workout.
4. The selected workout details appear on the screen. Press \bullet _{LAP OK} to start exercise.
5. When finished the Bryton Test, press \blacksquare / \parallel _{BACK} and \bullet _{LAP OK} to save the result.

Stop Training

You can stop the current training after you have reached your goal or when you decide to end the current training.

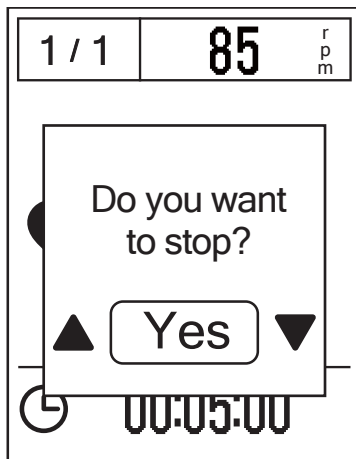

1. Press \blacksquare/\parallel BACK to pause the recording and press \blacksquare/\parallel BACK again to stop the recording.
2. A “Do you want to stop?” message appears on the screen. To stop the current training, press $\blacksquare/\parallel/\nabla\equiv$ BACK/PAGE to select **Yes** and press $\overset{\text{LAP}}{\bullet}$ OK to confirm.

View Exercise/Training Record

Use View History to view or delete your exercise/training history.

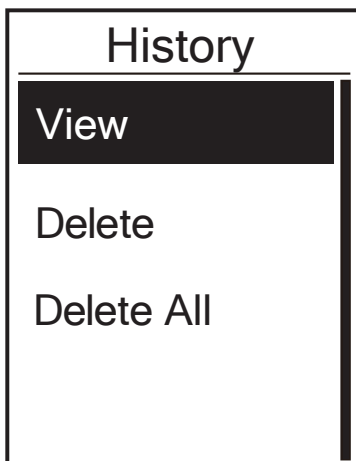

To view your history:

1. In the main screen, press $\nabla\equiv$ PAGE to select **View History** > **View** and press $\overset{\text{LAP}}{\bullet}$ OK.
2. Press $\nabla\equiv$ PAGE to select **View** and press $\overset{\text{LAP}}{\bullet}$ OK to confirm.
3. Press $\nabla\equiv$ PAGE to select a training history from the list and press $\overset{\text{LAP}}{\bullet}$ OK to view your history.

NOTE: You can also upload your history to brytonsport.com to keep track of all your ride data.

Delete History



To delete your history:

1. In the main screen, press $\nabla \equiv$ to select **View History > View** and press $\overset{\text{LAP}}{\bullet} \text{OK}$.
2. Press $\nabla \equiv$ to select **Delete** and press $\overset{\text{LAP}}{\bullet} \text{OK}$ to enter the history list.
3. Press $\nabla \equiv$ to select a training history from the list and press $\overset{\text{LAP}}{\bullet} \text{OK}$ to delete the selected history.
4. A "Backup data to web first. Delete?" message appears on the screen. To delete the data, press $\blacksquare / \parallel / \nabla \equiv$ to select **Yes** and press $\overset{\text{LAP}}{\bullet} \text{OK}$ to confirm.

History Flow

trip = Trip Time

09/19	21:44	$\nabla \equiv$
00:03:08	trip	
00:02:25	ride	
3.69	km	
39	kcal	
04	laps	
More	1/20	

Record#/Total records

AVG	MAX	
75.6	75.6	kmh
39	39	bpm
19	19	rpm

The arrow appears only when there is lap in this record.

Lap 01	00:49
0.25	km
81.4	kmh
13	kcal
0	bpm
0	rpm

The arrow appears only when there are more than 1 lap.

Settings

With the Settings feature, you can customize exercises settings, altitude, general settings, sensor settings, bike and user profiles.

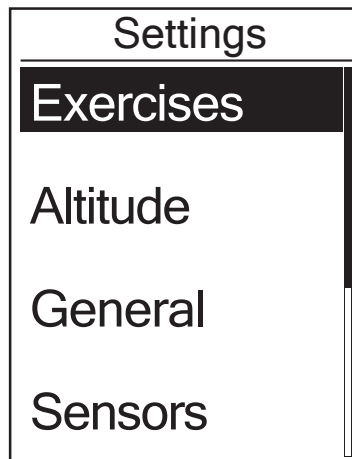

1. In the main screen, press $\nabla \equiv$ _{PAGE} to select **Settings**.
2. Press $\text{LAP} \bullet$ _{OK} to enter the Settings menu.

Smart Lap

With Smart Lap feature, you can use your device to automatically mark the lap at a specific location or after you have traveled a specific distance.

Lap by Location

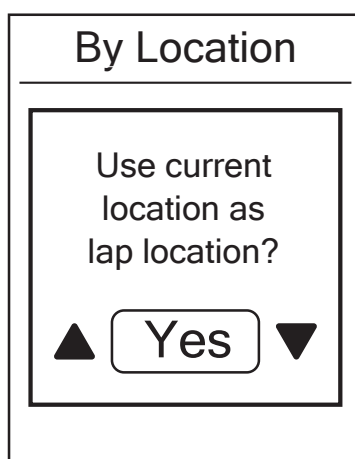

1. In the Settings menu, press $\nabla \equiv$ _{PAGE} to select **Exercises**> **Smart Lap** and press $\text{LAP} \bullet$ _{OK}.
2. Press $\text{LAP} \bullet$ _{OK} to enter the editing menu.
Press \blacksquare / \parallel _{BACK} / $\nabla \equiv$ _{PAGE} to select **Location** and press $\text{LAP} \bullet$ _{OK} to confirm.
3. A "Use current location as lap location?" message appears on the screen. To save the data, press $\nabla \equiv$ _{PAGE} to select **Yes** and press $\text{LAP} \bullet$ _{OK} to confirm.
4. Press \blacksquare / \parallel _{BACK} to exit this menu.

NOTE: If the GPS signal is not fixed, a "No GPS signal. Searching GPS, please wait" message appears on the screen. Check if the GPS is on and make sure you step outside to acquire the signal.

Lap by Distance

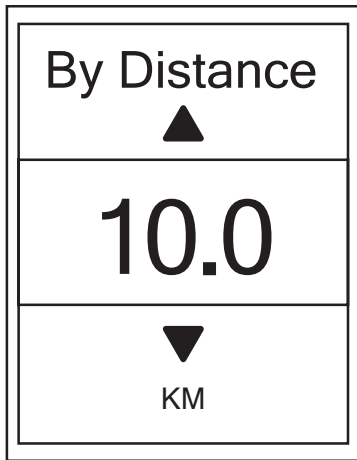

1. In the Settings menu, press $\nabla \equiv$ to select **Exercise > Smart Lap** and press $\text{LAP} \bullet \text{OK}$.
2. Press $\text{LAP} \bullet \text{OK}$ to enter the editing menu. Press $\blacksquare / \parallel / \nabla \equiv$ to select **Distance** and press $\text{LAP} \bullet \text{OK}$ to confirm.
3. Press $\blacksquare / \parallel / \nabla \equiv$ to select your desired distance and press $\text{LAP} \bullet \text{OK}$ to confirm.
4. Press \blacksquare / \parallel to exit this menu.

Altitude

You can set the altitude setting for the current location and four other locations.

Current Altitude

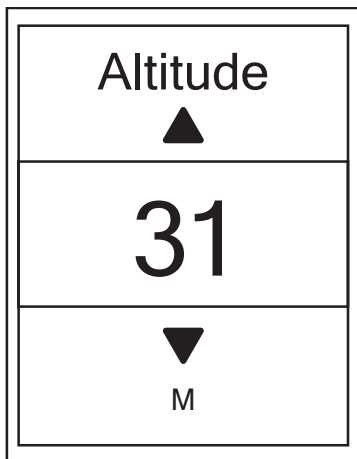

1. In the Settings menu, press $\nabla \equiv$ to select **Altitude > Altitude** and press $\text{LAP} \bullet \text{OK}$.
2. Press $\blacksquare / \parallel / \nabla \equiv$ to adjust the desired altitude and press $\text{LAP} \bullet \text{OK}$ to confirm the setting.
3. Press \blacksquare / \parallel to exit this menu.

Other Location Altitude

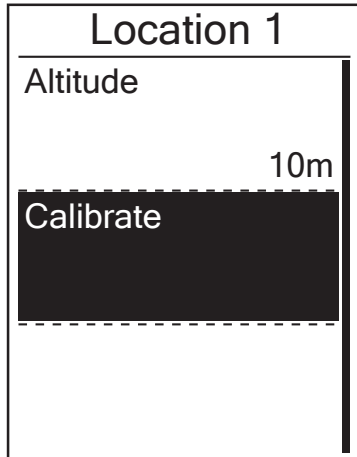

1. In the Settings menu, press $\nabla \equiv$ to select **Altitude > Location 1, Location 2, Location 3, Location 4, Location 5** and press $\overset{\text{LAP}}{\text{OK}} \bullet$.
2. To set the altitude, press $\nabla \equiv$ to select **Altitude** and press $\overset{\text{LAP}}{\text{OK}} \bullet$ to confirm.
3. Press $\blacksquare / \parallel / \nabla \equiv$ to adjust the desired altitude and press $\overset{\text{LAP}}{\text{OK}} \bullet$ to confirm the setting.
4. To calibrate the set altitude, press $\nabla \equiv$ to select **Calibrate** and press to $\overset{\text{LAP}}{\text{OK}} \bullet$ confirm.
5. Press \blacksquare / \parallel to exit this menu.

Data Page

You can set the display settings for the Meter and Lap.

Meter Display

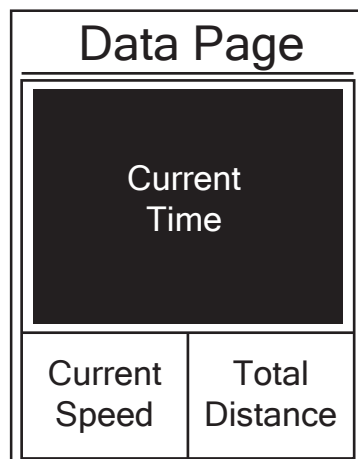

3-grid display

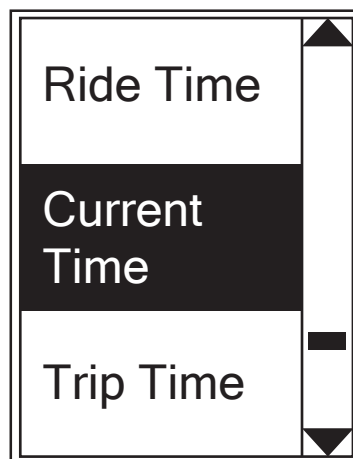

Item selection

1. In the Settings menu, press $\nabla \equiv$ to select **Exercises > Data Page** and press $\overset{\text{LAP}}{\text{OK}} \bullet$.
2. Press $\overset{\text{LAP}}{\text{OK}} \bullet$ to enter **Data Page** setting and change the setting from **Auto** to **Manual**.
3. Press $\nabla \equiv$ to enter **Data Page > Data Page 1, Data Page 2, Data Page 3, Data Page 4** or **Data Page 5** and press $\overset{\text{LAP}}{\text{OK}} \bullet$.
4. Press $\blacksquare / \parallel / \nabla \equiv$ to select the number of data fields and press $\overset{\text{LAP}}{\text{OK}} \bullet$ to confirm.

3. Press $\nabla \equiv$ _{PAGE} to select the item field that you want to customize, and press $\overset{\text{LAP}}{\bullet}$ _{OK} to confirm the selection.
4. Press $\blacksquare / \parallel / \nabla \equiv$ _{BACK / PAGE} to select the desired setting and press $\overset{\text{LAP}}{\bullet}$ _{OK} to confirm.
5. Press \blacksquare / \parallel _{BACK} to exit this menu.

NOTE: The number of data fields shown on the screen depends on the “Data fields” selection.

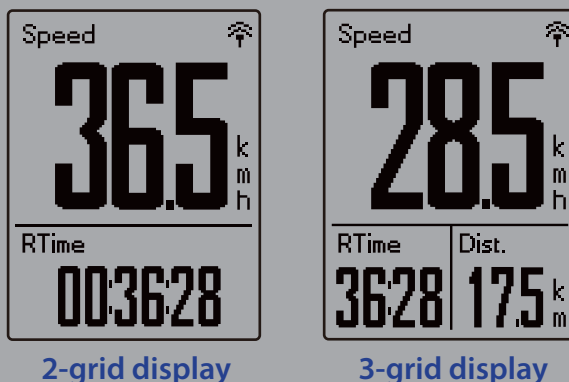

NOTE: If Data Page is set as **Auto**, Rider 330 will automatically adjust its data field display when detecting the paired sensors.

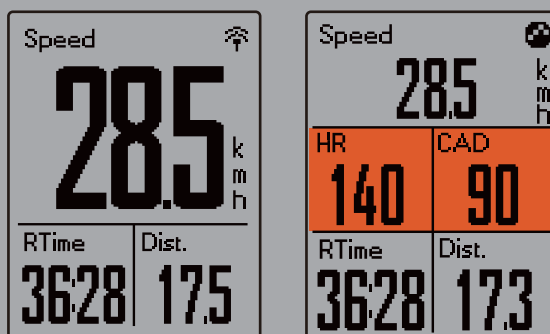

Lap Display

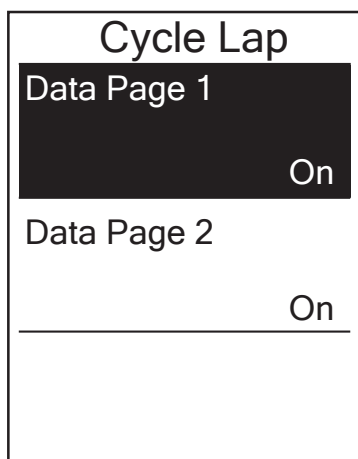

1. In the Settings menu, press $\nabla \equiv$ _{PAGE} to select **Exercises > Data Page > Data Page 1** or **Data Page 2** and press $\overset{\text{LAP}}{\bullet}$ _{OK}.
2. Press $\blacksquare / \parallel / \nabla \equiv$ _{BACK / PAGE} to select the number of data fields and press $\overset{\text{LAP}}{\bullet}$ _{OK} to confirm.
3. Press $\nabla \equiv$ _{PAGE} to select the item field that you want to customize, and press $\overset{\text{LAP}}{\bullet}$ _{OK} to confirm the selection.
4. Press $\blacksquare / \parallel / \nabla \equiv$ _{BACK / PAGE} to select the desired setting and press $\overset{\text{LAP}}{\bullet}$ _{OK} to confirm.
5. Press \blacksquare / \parallel _{BACK} to exit this menu.

Set Alert

With the Alert feature, the device displays a message to notify you if:

- your heart rate exceeds or drops below a specific number of beats per minute (bpm).
- you exceed or drop below a custom speed setting during your ride.
- your cadence speed exceeds or drops below a specific number of revolutions of the crank arm per minute (rpm).
- you reach a certain amount of distance for the long workouts.
- you reach a certain amount of time for the long workouts.

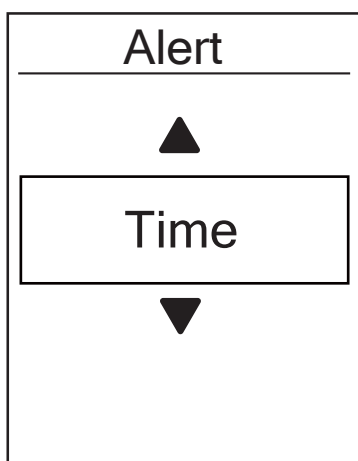

1. In the Settings menu, press $\nabla \equiv$ to select **Exercises** > **Alert** and press $\overset{\text{LAP}}{\underset{\text{OK}}{\bullet}}$ to enter its submenu.
2. Select **Time**, **Distance**, **Speed**, **HR**, or **Cadence** and press $\overset{\text{LAP}}{\underset{\text{OK}}{\bullet}}$ to configure the necessary settings.
3. Press \blacksquare / \parallel / $\nabla \equiv$ to select the desired setting and press $\overset{\text{LAP}}{\underset{\text{OK}}{\bullet}}$ to confirm.

Smart Pause

When you have a lot of obstacles along your route such as traffic lights, crosswalk, etc., this can really impact your recorded data. When the function is activated, the time and distance will automatically pause once you stop moving and resume once you start riding to enhance your data efficiency.

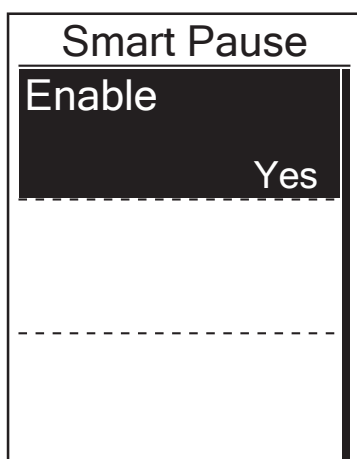

1. In the Settings menu, press $\nabla \equiv$ to select **Exercises** > **Smart Pause** and press $\overset{\text{LAP}}{\underset{\text{OK}}{\bullet}}$ to enter its submenu.
2. Select **Yes** to enable the function.

Data Record

With Data Record function, you can set your odometer and activate 1 second mode to get more accurate data.

Set ODO

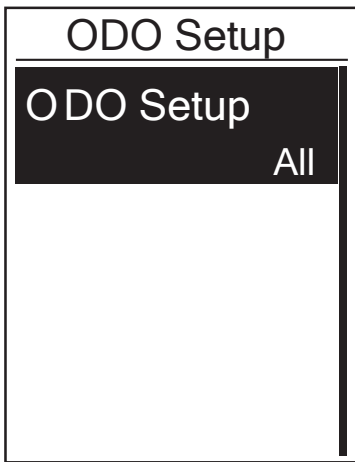

1. In the Settings menu, press $\nabla \equiv$ _{PAGE} to select **Exercise > Data Record** and press $\text{LAP} \bullet$ _{OK}.
2. Press $\nabla \equiv$ _{PAGE} to select **ODO Setup** and press $\text{LAP} \bullet$ _{OK} to enter.
3. Press $\text{LAP} \bullet$ _{OK} to enter its submenu and press \blacksquare / \parallel _{BACK} / $\nabla \equiv$ _{PAGE} to select the desired setting, then press $\text{LAP} \bullet$ _{OK} to confirm.

NOTE: **All** means the odometer would show the cumulative distance of all trips; **Recorded** would only show the cumulative distance of recorded trips.

Enable 1sec Mode

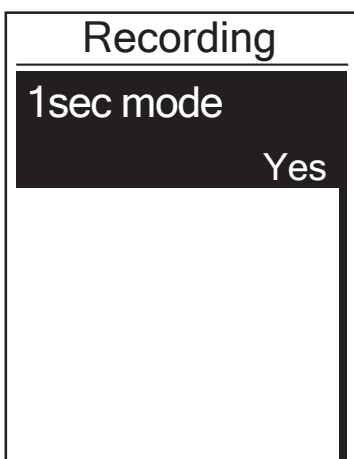

1. In the Settings menu, press $\nabla \equiv$ _{PAGE} to select **Exercise > Data Record** and press $\text{LAP} \bullet$ _{OK}.
2. Press $\nabla \equiv$ _{PAGE} to select **Recording** and press $\text{LAP} \bullet$ _{OK} to enter.
3. Press $\text{LAP} \bullet$ _{OK} to enter its submenu and press \blacksquare / \parallel _{BACK} / $\nabla \equiv$ _{PAGE} to select **Yes**, and press $\text{LAP} \bullet$ _{OK} to confirm.
4. Press \blacksquare / \parallel _{BACK} to exit this menu.

Personalize User Profile

You can change your personal information.

User	
Gender	Male
Birthday	1982/01/01
Height	177 cm

1. In the Settings menu, press $\blacktriangledown \equiv$ _{PAGE} to select **User** and press $\overset{\text{LAP}}{\bullet}$ _{OK}.
2. Press $\blacktriangledown \equiv$ _{PAGE} to select the setting that you want to change and press $\overset{\text{LAP}}{\bullet}$ _{OK} to enter its submenu.
 - Gender: select your gender.
 - Birthday : set your Birthday
 - Height: set your height.
 - Weight: set your weight.
 - Max HR: set your maximum heart rate.
 - LTHR: set your lactate threshold heart rate.
 - FTP: set your functional threshold power.
 - MAP: set your maximum aerobic power.
3. Press \blacksquare / \parallel _{BACK} / $\blacktriangledown \equiv$ _{PAGE} to adjust the desired setting and press $\overset{\text{LAP}}{\bullet}$ _{OK} to confirm.
4. Press \blacksquare / \parallel _{BACK} to exit this menu.

Personalize Bike Profile

You can customize and view your bicycle(s) profile.

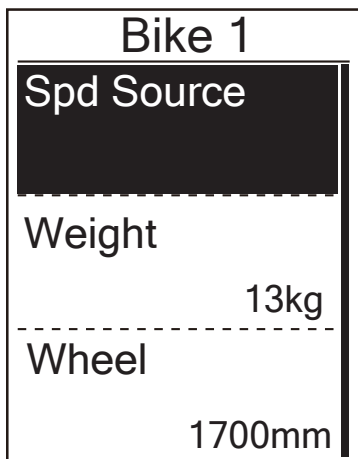

1. In the Settings menu, press $\nabla \equiv$ _{PAGE} to select **Profile > Bike Profile > Bike 1 or Bike 2** and press \bullet _{LAP OK}.
2. Press $\nabla \equiv$ _{PAGE} to select the setting that you want to change and press \bullet _{LAP OK} to enter its submenu.
 - Spd Source: set the priority of the speed sources
 - Weight: set the bike weight.
 - Wheel: set the bike wheel size.
 - Activate: select to activate the bike.
3. Press \blacksquare / \equiv _{BACK / PAGE} to adjust the desired setting and press \bullet _{LAP OK} to confirm.
4. Press \blacksquare / \equiv _{BACK} to exit this menu.

NOTE: For details on wheel size, see “Wheel Size and Circumference” on page 36.

View Bike Profile

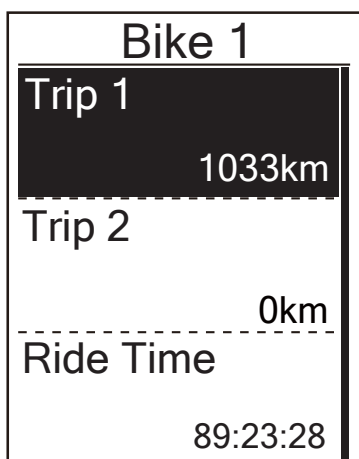

1. In the Settings menu, press $\nabla \equiv$ _{PAGE} to select **Profile > Bike Profile > Overview** and press \bullet _{LAP OK}.
2. Press $\nabla \equiv$ _{PAGE} to select the desired bike and press \bullet _{LAP OK} to confirm.
3. Press $\nabla \equiv$ _{PAGE} to view more data of the selected bike.
4. Press \blacksquare / \equiv _{BACK} to exit this menu.

Change System Settings

You can customize the device system settings such as backlight off, key tone, sound, time/unit, on-screen display language.

Backlight Off

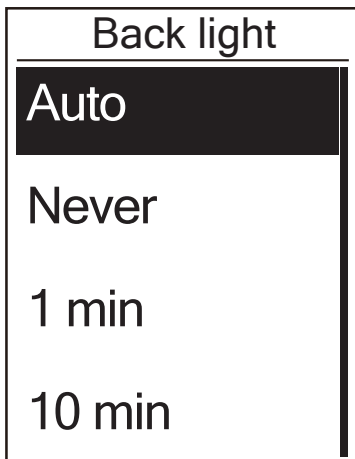

1. In the Settings menu, press $\nabla \equiv$ _{PAGE} to select **General > System > Backlight Off** and press $\overset{\text{LAP}}{\underset{\text{OK}}{\bullet}}$.
2. Press $\blacksquare / \parallel / \nabla \equiv$ _{BACK / PAGE} to select the desired setting and press $\overset{\text{LAP}}{\underset{\text{OK}}{\bullet}}$ to confirm.
3. Press \blacksquare / \parallel _{BACK} to exit this menu.

Key Tone

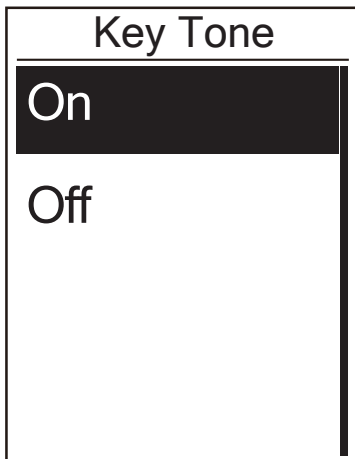

1. In the Settings menu, press $\nabla \equiv$ _{PAGE} to select **General > System > Key Tone** and press $\overset{\text{LAP}}{\underset{\text{OK}}{\bullet}}$.
2. Press $\blacksquare / \parallel / \nabla \equiv$ _{BACK / PAGE} to select the desired setting and press $\overset{\text{LAP}}{\underset{\text{OK}}{\bullet}}$ to confirm.
3. Press \blacksquare / \parallel _{BACK} to exit this menu.

Sound



1. In the Settings menu, press $\nabla \equiv$ to select **General > System > Sound** and press $\overset{\text{LAP}}{\underset{\text{OK}}{\bullet}}$.
2. Press $\blacksquare / \parallel \nabla \equiv$ to select the desired setting and press $\overset{\text{LAP}}{\underset{\text{OK}}{\bullet}}$ to confirm.
3. Press \blacksquare / \parallel to exit this menu.

Time/Unit



Daylight Save



Date format

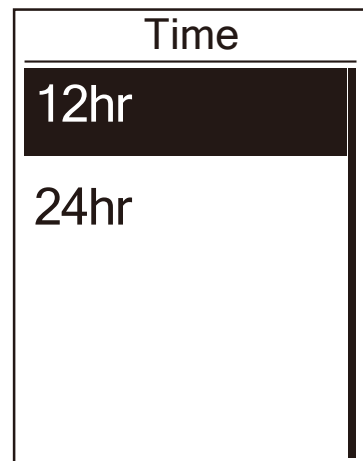

Time format



Unit

1. In the Settings menu, press $\nabla \equiv$ to select **General > System > Time/Unit > Daylight Save, Date format, Time format, Unit Temperature** and press $\overset{\text{LAP}}{\underset{\text{OK}}{\bullet}}$.
2. Press $\blacksquare / \parallel \nabla \equiv$ to select the desired setting/format and press $\overset{\text{LAP}}{\underset{\text{OK}}{\bullet}}$ to confirm.
3. Press \blacksquare / \parallel to exit this menu.

Language



1. In the Settings menu, press $\nabla \equiv$ to select **General > System > Language** and press $\text{LAP} \bullet$ OK .
2. Press $\blacksquare / \parallel / \nabla \equiv$ to select the desired setting and press $\text{LAP} \bullet$ OK to confirm.
3. Press \blacksquare / \parallel to exit this menu.

View GPS Status

You can view the GPS signal information that your device is currently receiving.

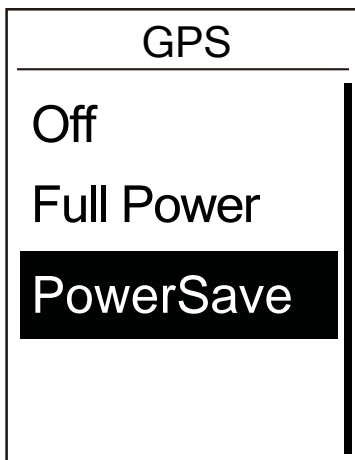

1. In the Settings menu, press $\nabla \equiv$ to select **General > GPS** and press $\text{LAP} \bullet$ OK .
2. To set the signal search mode, press $\text{LAP} \bullet$ OK to confirm.
3. Press $\blacksquare / \parallel / \nabla \equiv$ to select the desired setting and press $\text{LAP} \bullet$ OK to confirm.
 - Off: Turn-off GPS functions. Choose this to save power when GPS signal is not available, or when GPS information is not required (such as indoor use).
 - Full Power: maximum position and speed accuracy, consumes more power.
 - PowerSaving: Achieves longer battery life when used in good GPS signal condition, but less accurate.

View Software Version

You can view your device current software version.

1. In the Settings menu, press $\nabla \equiv$ _{PAGE} to select **General > About**.
2. Press $\overset{\text{LAP}}{\underset{\text{OK}}{\bullet}}$ to confirm.
The current software version is displayed on the screen.
3. Press \blacksquare / \parallel _{BACK} to exit this menu.

Bluetooth

Before pairing Rider 330 with your bluetooth enabled mobile phone, make sure the bluetooth function of your mobile phone and Rider 330 is turned on.

Enable Bluetooth

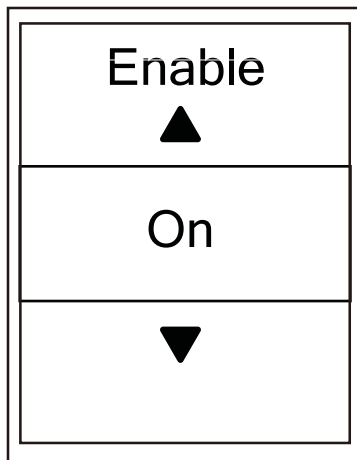

1. In the Settings menu, press $\nabla \equiv$ _{PAGE} to select **General > Bluetooth** and press $\overset{\text{LAP}}{\underset{\text{OK}}{\bullet}}$.
2. Press $\blacksquare / \parallel / \nabla \equiv$ _{BACK / PAGE} to select **On** and press $\overset{\text{LAP}}{\underset{\text{OK}}{\bullet}}$ to confirm.
3. Press \blacksquare / \parallel _{BACK} to exit this menu.

Configure Auto Scroll

When the feature is enabled, the data will automatically switch pages at the preset time.

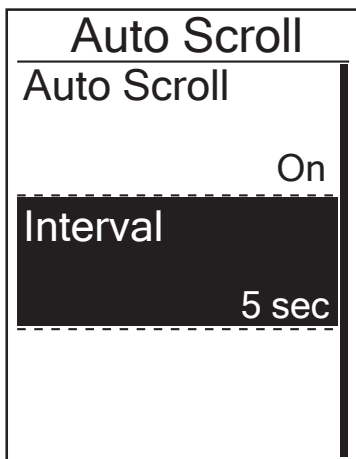

1. In the Settings menu, press $\nabla \equiv$ _{PAGE} to select **General > Auto Scroll** and press $\overset{\text{LAP}}{\bullet}$ _{OK}.
2. Press $\nabla \equiv$ _{PAGE} to select the setting that you want to change and press $\overset{\text{LAP}}{\bullet}$ _{OK} to enter its submenu.
 - Auto scroll: enable/disable the auto switch.
 - Interval: set the interval time.
3. Press $\blacksquare / \parallel / \nabla \equiv$ _{BACK / PAGE} to adjust the desired setting and press $\overset{\text{LAP}}{\bullet}$ _{OK} to confirm.
4. Press \blacksquare / \parallel _{BACK} to exit this menu.

Enable File Saving Mode

When the feature is enabled, the device will automatically overwrite from your oldest records when memory storage is full.

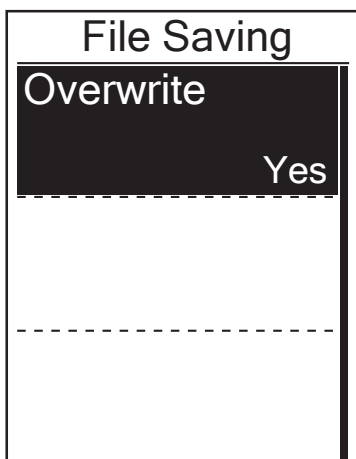

1. In the Settings menu, press $\nabla \equiv$ _{PAGE} to select **General > File Saving** and press $\overset{\text{LAP}}{\bullet}$ _{OK}.
2. Press $\overset{\text{LAP}}{\bullet}$ _{OK} to enter its submenu and press $\blacksquare / \parallel / \nabla \equiv$ _{BACK / PAGE} to adjust the desired setting and press $\overset{\text{LAP}}{\bullet}$ _{OK} to confirm.
3. Press \blacksquare / \parallel _{BACK} to exit this menu.

Start Reminder

When Rider 330 detects the motion of your bike, it would pop up a reminder to ask you if you would like to record or not. You can set the frequency of start reminder.

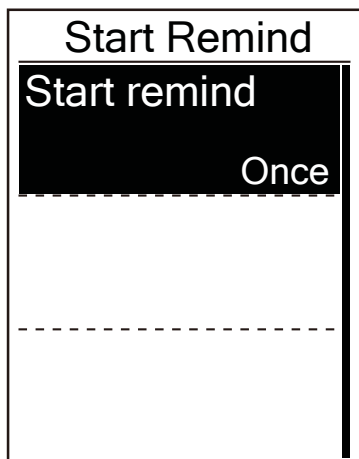

1. In the Settings menu, press $\blacktriangledown \equiv$ _{PAGE} to select **General > Start Remind** and press $\overset{\text{LAP}}{\underset{\text{OK}}{\bullet}}$.
2. Press $\overset{\text{LAP}}{\underset{\text{OK}}{\bullet}}$ to enter its submenu and press $\blacksquare / \parallel / \blacktriangledown \equiv$ _{BACK / PAGE} to adjust the desired setting and press $\overset{\text{LAP}}{\underset{\text{OK}}{\bullet}}$ to confirm.
3. Press \blacksquare / \parallel _{BACK} to exit this menu.

View Memory Usage

View the storage status of the device.

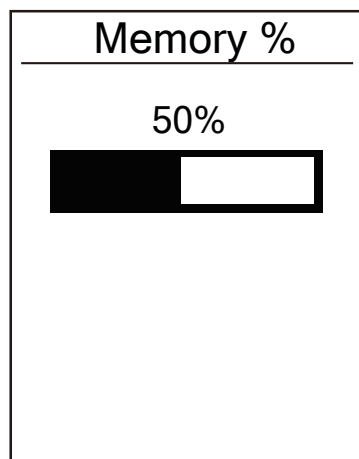

1. In the Settings menu, press $\blacktriangledown \equiv$ _{PAGE} to select **General > Memory %** and press $\overset{\text{LAP}}{\underset{\text{OK}}{\bullet}}$.
The storage status is displayed on the screen.
2. Press \blacksquare / \parallel _{BACK} to exit this menu.

Reset Data

You can resotre your Rider 330 to factory setting.

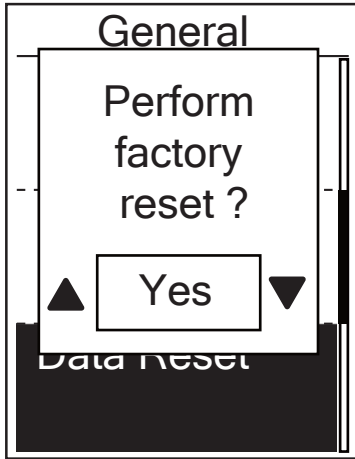

1. In the Settings menu, press $\blacktriangledown \equiv$ to select **General > Data Reset** and press $\overset{\text{LAP}}{\underset{\text{OK}}{\bullet}}$.
2. Press $\blacksquare / \parallel / \blacktriangledown \equiv$ to adjust the desired setting and press $\overset{\text{LAP}}{\underset{\text{OK}}{\bullet}}$ to confirm.

Sensors

You can customize the respective sensor settings such as enable/disable the function or rescan the sensor for the device.

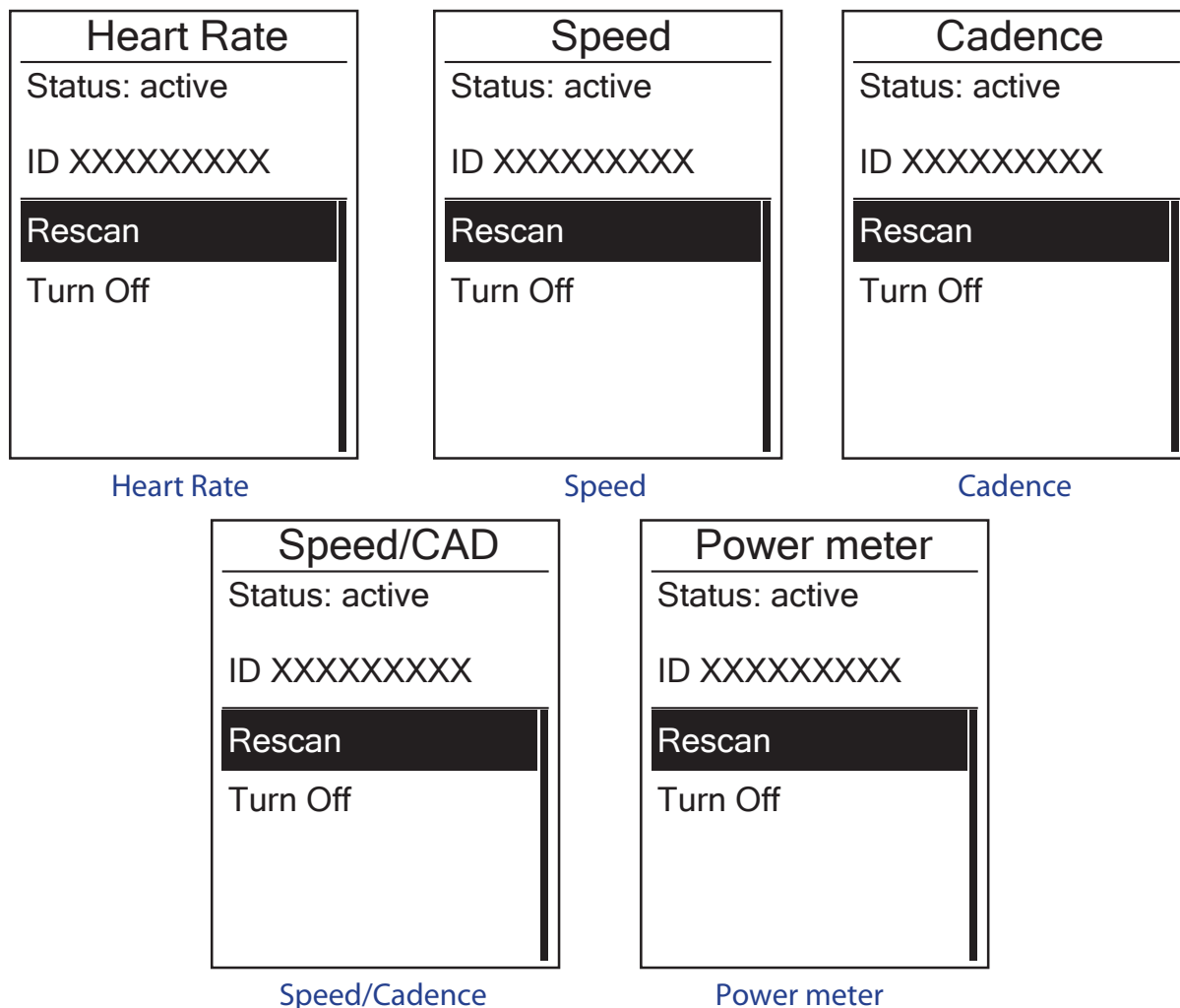

1. In the Settings menu, press $\nabla \equiv$ _{PAGE} to select **Sensors > Heart Rate, Speed, Cadence, or Speed/CAD Power Meter** and press \bullet _{LAP OK}.
2. Press \bullet _{LAP OK} to have more options. Press $\nabla \equiv$ _{PAGE} to select the desired setting and press \bullet _{LAP OK} to confirm.
 - Rescan: rescan to detect the sensor.
 - Turn on/Turn off: enable/disable the sensor.
3. Press \blacksquare / \parallel _{BACK} to exit this menu.

NOTE:

- When the heart rate monitor is paired, the heart rate icon appears on the main screen. While pairing your speed/cadence sensor/the heart rate belt and power meter, please make sure there is no other cadence/speed sensor/power meter within 5 m. When the cadence sensor is paired, the cadence sensor icon appears on the main screen.

Appendix

Specifications

Rider 330

Item	Description
Display	1.8" FSTN positive transfective dot-matrix LCD
Physical Size	45.1 x 69.5 x 17.3 mm
Weight	56g
Operating Temperature	-10°C ~ 50°C
Battery Charging Temperature	0°C ~ 40°C
Battery	Li polymer rechargeable battery
Battery Life	36 hours with open sky
RF Receiver	2.4GMHz receiver with embedded antenna to support ANT+ heart rate, speed sensor, cadence sensor
GPS	Integrated high-sensitivity GPS receiver with embedded antenna
BLE Smart	Bluetooth smart wireless technology with embedded antenna
Water Resistant	IPX7 waterproof rating
Wireless Local Area Network	IEEE 802.11 b/g/n

Cadence Sensor

Item	Description
Physical size	33.9 x 13.5 x 39 mm
Weight	14 g
Water Resistance	IPX7
Transmission range	5 m
Battery life	1 hour per day for 16 months
Operating temperature	-10°C ~ 60°C
Radio frequency/protocol	2.4GHz / Dynastream ANT+ Sport wireless communications protocol

Accuracy may be degraded by poor sensor contact, electrical interference, and receiver distance from the transmitter.

Heart Rate Monitor

Item	Description
Physical size	67~100 x 26 x 15 mm
Weight	14 g (sensor) / 35g (strap)
Water Resistance	20 m
Transmission range	5 m
Battery life	1 hour per day for 24 months
Operating temperature	5°C ~ 40°C
Radio frequency/protocol	2.4GHz / Dynastream ANT+ Sport wireless communications protocol

Accuracy may be degraded by poor sensor contact, electrical interference, and receiver distance from the transmitter.

Battery Information

Heart Rate Monitor and Cadence Sensor Battery

The heart rate monitor/cadence sensor contains a user-replaceable CR2032 battery.

To replace the battery:

1. Locate the circular battery cover on the back of the heart rate monitor/cadence sensor.
2. Use a coin to twist the cover counter-clockwise so the arrow on the cover points to OPEN.
3. Remove the cover and battery. Wait for 30 seconds.
4. Insert the new battery, with the positive connector first into the battery chamber.
5. Use a coin to twist the cover clockwise so the arrow on the cover points to CLOSE.

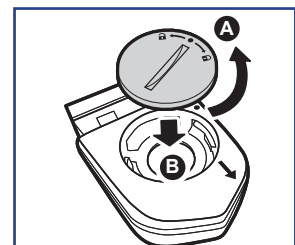
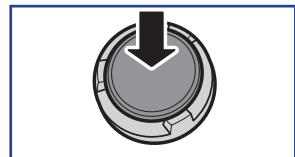
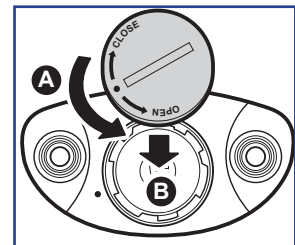

NOTE:

- When installing a new battery, if the battery is not placed with the positive connector first, the positive connector will easily deform and malfunction.
- Be careful not to damage or lose the O-ring gasket on the cover.
- Contact your local waste disposal department to properly dispose of used batteries.

Install Rider 330

Mount Rider 330 to the Bike

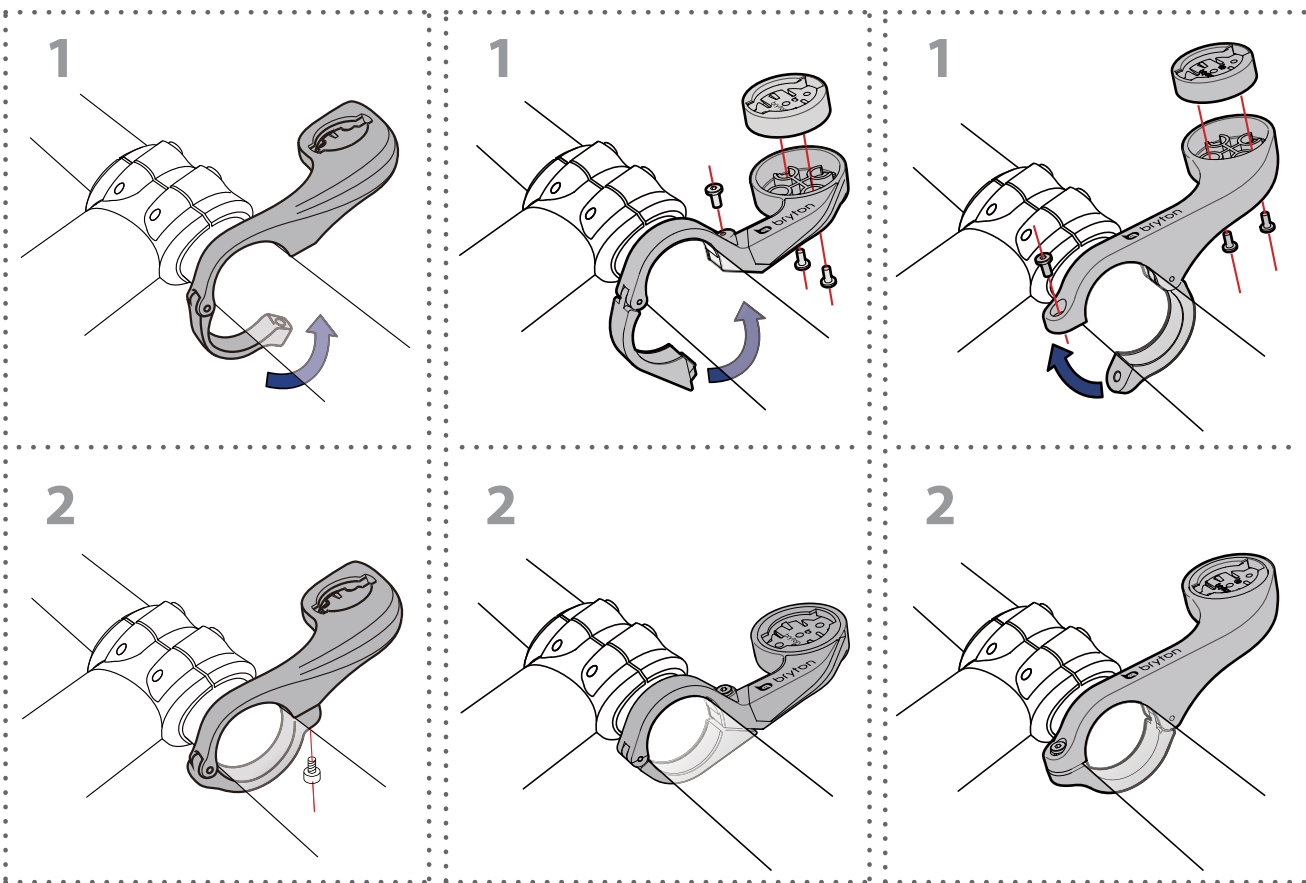
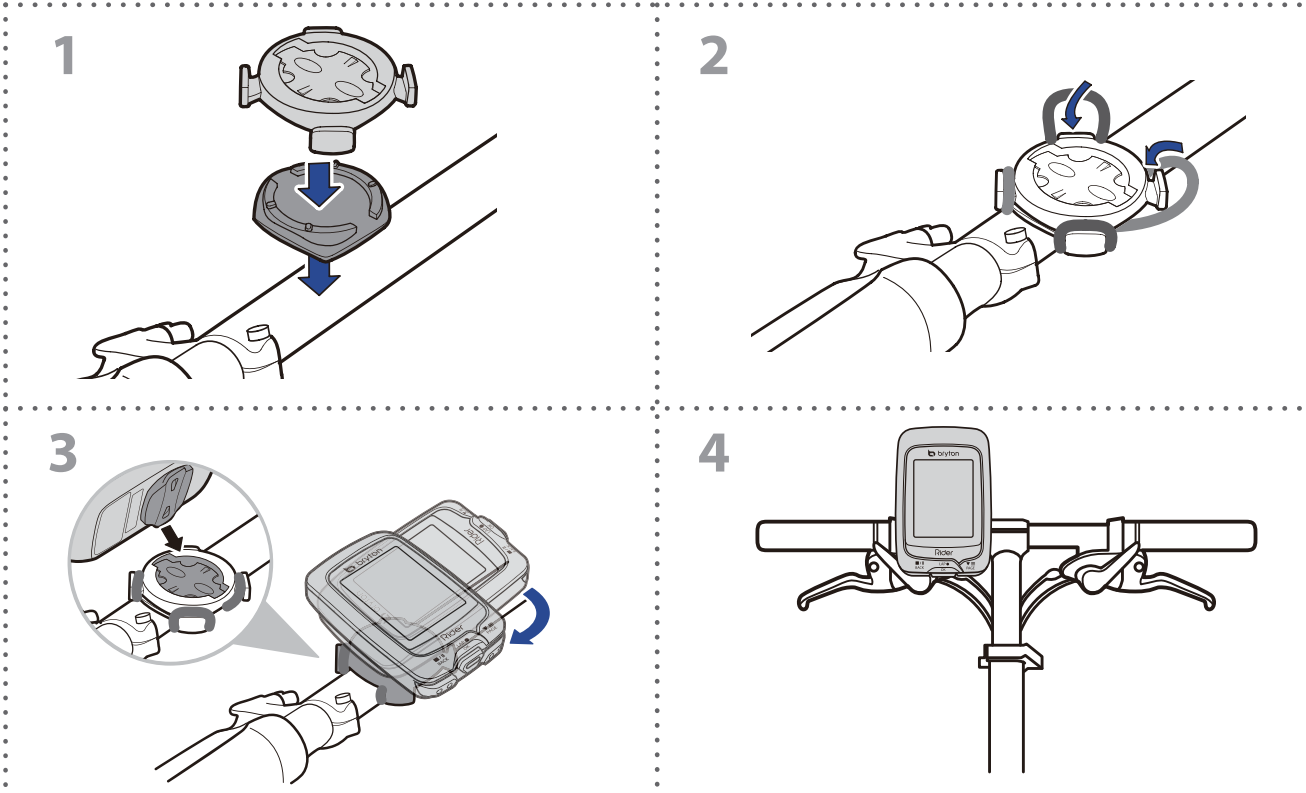

Install the Speed/Cadence/Dual Sensor (Optional)

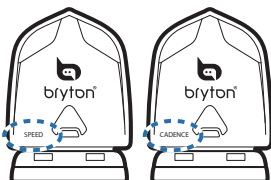
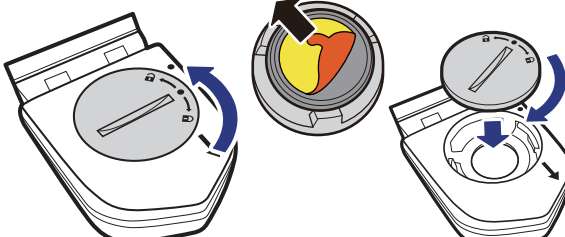
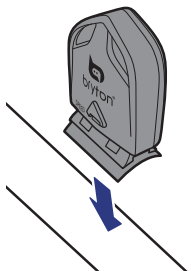
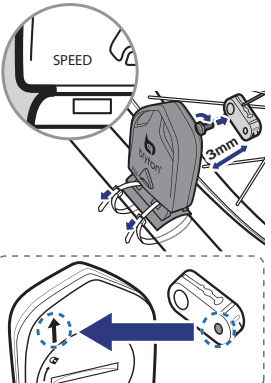
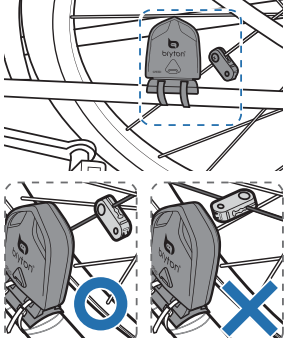
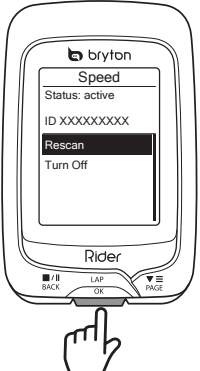
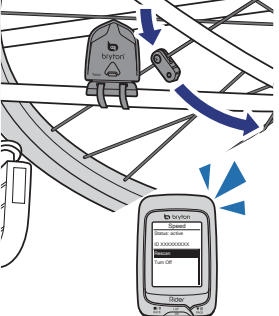
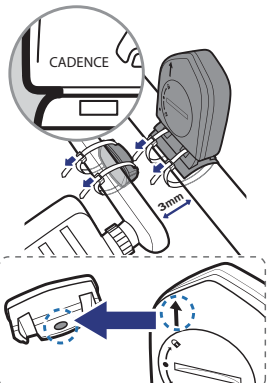
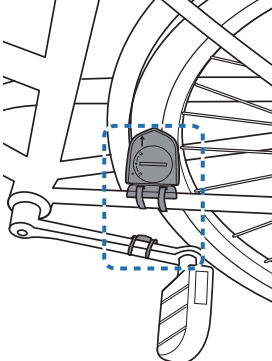
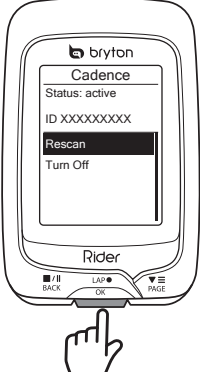
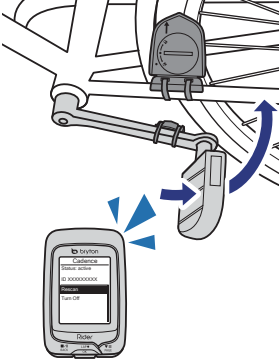
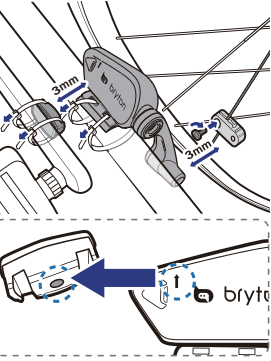
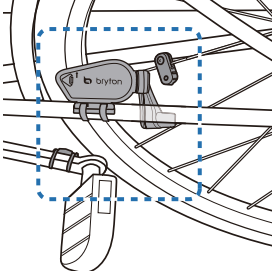
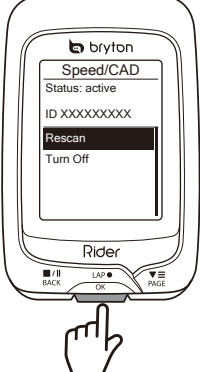
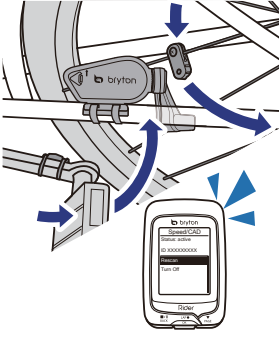
<p>1</p> 	<p>2 Remove battery tab before use</p> 	<p>3</p> 	
<p>4a</p> 	<p>5a</p> 	<p>6a</p> 	<p>7a</p> 
<p>4b</p> 	<p>5b</p> 	<p>6b</p> 	<p>7b</p> 
<p>4c</p> 	<p>5c</p> 	<p>6c</p> 	<p>7c</p> 

NOTE:

- To ensure optimum performance, do the following:
 - Align both sensor and magnet as shown in the illustration (5a / 5b). Pay attention on the alignment points.
 - Ensure the distance between the sensor and the magnet is within 3 mm.
- Ensure that both Speed sensor and Speed magnet are installed and aligned horizontally, not vertically.
- On the initial usage, press the front button to activate the sensor and start pedaling. When the sensor detects the magnet, the LED blinks once to indicate the alignment is correct (the LED blinks only for the first ten passes after pressing the button).

Install Heart Rate Belt (Optional)

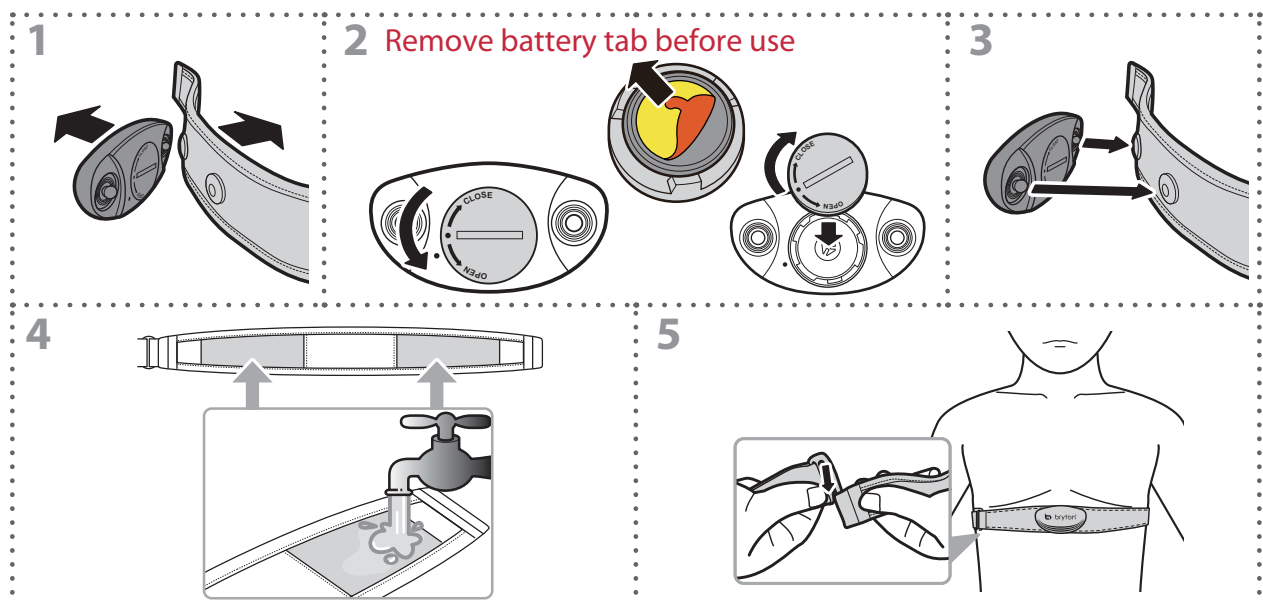
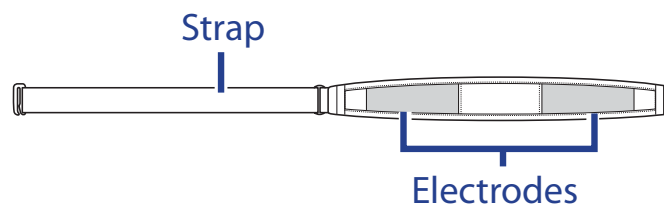
NOTE:

- In cold weather, wear appropriate clothing to keep the heart rate belt warm.
- The belt should be worn directly on your body.
- Adjust the sensor position to the middle part of the body (wear it slightly below the chest). The Bryton logo shown on the sensor should be facing upward. Tighten the elastic belt firmly so that it will not turn loose during the exercise.
- If the sensor cannot be detected or the reading is abnormal, please warm up for about 5 minutes.
- If the heart rate belt is not used for a period of time, remove the sensor from the heart rate belt.

Wheel Size and Circumference

The wheel size is marked on both sides of the tires.

	L(mm)
12x1.75	935
12x1.95	940
14x1.50	1020
14x1.75	1055
16x1.50	1185
16x1.75	1195
16x2.00	1245
16x1-1/8	1290
16x1-3/8	1300
17x1-1/4	1340
18x1.50	1340
18x1.75	1350
20x1.25	1450
20x1.35	1460
20x1.50	1490
20x1.75	1515
20x1.95	1565
20x1-1/8	1545
20x1-3/8	1615
22x1-3/8	1770
22x1-1/2	1785
24x1.75	1890
24x2.00	1925
24x2.125	1965
24x1(520)	1753
24x3/4 Tubular	1785
24x1-1/8	1795
24x1-1/4	1905
26x1(559)	1913
26x1.25	1950
26x1.40	2005
26x1.50	2010
26x1.75	2023
26x1.95	2050
26x2.10	2068
26x2.125	2070
26x2.35	2083

	L(mm)
26x3.00	2170
26x1-1/8	1970
26x1-3/8	2068
26x1-1/2	2100
650C Tubular 26x7/8	1920
650x20C	1938
650x23C	1944
650x25C 26x1(571)	1952
650x38A	2125
650x38B	2105
27x1(630)	2145
27x1-1/8	2155
27x1-1/4	2161
27x1-3/8	2169
27.5x1.50	2079
27.5x2.1	2148
27.5x2.25	2182
700x18C	2070
700x19C	2080
700x20C	2086
700x23C	2096
700x25C	2105
700x28C	2136
700x30C	2146
700x32C	2155
700C Tubular	2130
700x35C	2168
700x38C	2180
700x40C	2200
700x42C	2224
700x44C	2235
700x45C	2242
700x47C	2268
29x2.1	2288
29x2.2	2298
29x2.3	2326

Basic Care For Your Rider 330

Taking good care of your device will reduce the risk of damage to your device.

- Do not drop your device or subject it to severe shock.
- Do not expose your device to extreme temperatures and excessive moisture.
- The screen surface can easily be scratched. Use the non-adhesive generic screen protectors to help protect the screen from minor scratches.
- Use diluted neutral detergent on a soft cloth to clean your device.
- Do not attempt to disassemble, repair, or make any modifications to your device. Any attempt to do so will make the warranty invalid.

NOTE: Improper battery replacement may cause an explosion. When replacing a new battery, use only the original battery or a similar type of battery specified by the manufacturer. Disposal of the used batteries must be carried out in accordance to the regulations of your local authority.



For better environmental protection, waste batteries should be collected separately for recycling or special disposal.

Data Fields

Data Field	Complete Data Field Name
Sunrise	Sunrise Time
Sunset	Sunset Time
RTime	Ride Time
AvgSpd	Average Speed
Max Spd	Maximum Speed
HR	Heart Rate
Avg HR	Average Heart Rate
Max HR	Maximum Heart Rate
MHR Zone	Maximum Heart Rate Zone
LTHR Zone	Lactate Threshold Heart Rate Zone
MHR%	Maximum Heart Rate Percentage
LTHR%	Lactate Threshold Heart Rate Percentage
AvgCAD	Average Cadence
MaxCAD	Maximum Cadence
LapAvSpd	Lap Average Speed
LapMaSpd	Lap Maximum Speed
L'stLpAvSp	Last Lap Average Speed
LapDist	Lap Distance
L'stLpDist	Last Lap Distance
L'stLapT	Last Lap Time
LapAvHR	Lap Average Heart Rate
LapMaHR	Lap Maximum Heart Rate
L'LpAvHR	Last Lap Average Heart Rate
L'A'MHR%	Lap Average MHR Percentage
L'A'LTHR%	Lap Average LTHR Percentage
LpAvSt'dR	Lap Average Stride Rate
LpStr'dAvL	Lap Stride Average Length
LLpSt'dAvL	Last Lap Stride Average Length
LapAvP	Lap Average Pace
L'stLpAvP	Last Lap Average Pace

Data Fields	Complete Data Field Name
LapMaP	Lap Maximum Pace
LAvCAD	Lap Average Cadence
LLAvCad	Last Lap Average Cadence
ODO	Odometer
Temp.	Temperature
Dist.	Distance
T to Dest	Time to Destination
D to Dest	Distance to Destination
Max Alt.	Maximum Altitude
Alt. Gain	Altitude Gain
Alt. Loss	Altitude Loss
Str'dRate	Stride Rate
AvStr'dRt	Average Stride Rate
MaStr'dRt	Maximum Stride Rate
AvSt'dl'gth	Average Stride Length
AvgPace	Average Pace
MaxPace	Maximum Pace
L'st1kmP	Last 1 km/mile Pace
PW now	Current Power
Avg PW	Average Power
Max PW	Maximum Power
LapMaxPW	Lap Maximum Power
LLapMaxPW	Last Lap Maximum Power
LapAvgPW	Lap Average Power
LLapAvgPW	Last Lap Average Power
3s PW	3 Seconds Average Power
30s PW	30 Seconds Average Power
MAP Zone	Maximum Aerobic Power Zone
MAP%	Maximum Aerobic Power Percentage
FTP Zone	Functional Threshold Power Zone
FTP%	Functional Threshold Power Percentage

Data Fields	Complete Data Field Name
CPB-LR	Current Left and Right Power Balance
MPB-LR	Maximum Left and Right Power Balance
APB L-R	Average Left and Right Power Balance
CTE-LR	Current Left and Right Torque Effectiveness
MTE-LR	Maximum Left and Right Torque Effectiveness
ATE-LR	Average Left and Right Torque Effectiveness
CPS L-R	Current Left and Right Pedal Smoothness
APS L-R	Average Left and Right Pedal Smoothness
MPS-LR	Maximum Left and Right Pedal Smoothness
IF	Intensity Factor
NP	Normalized Power
SP	Specific Power
TSS	Training Stress Score

NOTE: Some data fields may only apply to certain models.



Warranty and Safety Information
Informations relatives à la garantie et à la sécurité
Garantie- und Sicherheitshinweise
Garanzia e Informazioni sulla sicurezza
Información sobre la garantía y la seguridad
Garantie-en veiligheidsinformatie
Informações sobre Garantia e segurança
Informações sobre garantia e segurança
Oplysninger om garanti og sikkerhed
Garanti och säkerhetsinformation
Garanti-og sikkerhetsinformasjon
Takuu- ja turvallisuustiedot
Informacje o gwarancji i bezpieczeństwie
Informace o záruce a bezpečnosti
Jótállási és biztonsági információ
產品保固和安全聲明
产品保固和安全声明
保証と安全に関する情報
보증 및 안전 정보



Safety Agreement

IMPORTANT: Please Read This Notice before Using This Product

Bryton products and accessories are not medical devices and its readings are for reference only. Bryton is not responsible for the consequences of any erroneous readings. Always consult your physician before beginning any training program or using a heart rate monitor. Please do not operate the product during any activities, because lack of proper attention may cause injury, death or material damage. When using or installing this product, please comply with all applicable local laws and regulation. We and our manufacturers and licensors shall not assume any responsibility for damages arising from using this product during activities, misuse, improper installation, act of God, any violation of traffic or safety regulations, or software or map data product therein. This product is not guaranteed to be free of errors or deficiencies, and is not guaranteed to be applicable for any defined purpose.

Battery Warnings

1. Do not leave the device exposed to a heat source or in a high temperature.
2. Do not puncture or incinerate.
3. Do not attempt to remove the non-user-replaceable battery.
4. Do not operate the device outside of the temperature range: -4 to 131°F (-20 to 55°C).
5. Store within the following temperature range for an extended time: 32 to 77°F (0 to 25°C)
6. Properly recycle or dispose of the device or battery.

CAUTION

RISK OF EXPLOSION IF BATTERY IS REPLACED BY AN INCORRECT TYPE.
DISPOSE OF USED BATTERIES ACCORDING TO THE INSTRUCTIONS.

FCC Regulations:

§ 15.19 (a)(3)

This device complies with part 15 of the FCC Rules. Operation is subject to the following two conditions: (1) This device may not cause harmful interference, and (2) this device must accept any interference received, including interference that may cause undesired operation.

§ 15.21

Changes or modifications not expressly approved by the party responsible for compliance could void the user's authority to operate the equipment.





§ 15.105 (b)

This equipment has been tested and found to comply with the limits for a Class B digital device, pursuant to part 15 of the FCC Rules. These limits are designed to provide reasonable protection against harmful interference in a residential installation. This equipment generates, uses and can radiate radio frequency energy and, if not installed and used in accordance with the instructions, may cause harmful interference to radio communications. However, there is no guarantee that interference will not occur in a particular installation. If this equipment does cause harmful interference to radio or television reception, which can be determined by turning the equipment off and on, the user is encouraged to try to correct the interference by one or more of the following measures:

- Reorient or relocate the receiving antenna.
- Increase the separation between the equipment and receiver.
- Connect the equipment into an outlet on a circuit different from that to which the receiver is connected.
- Consult the dealer or an experienced radio/TV technician for help.

FCC RF Exposure Compliance

This device is designed and manufactured not to exceed the emission limits for exposure to radio frequency (RF) energy set by the Federal Communications Commission for an uncontrolled environment.

This equipment complies with FCC RF radiation exposure limits set forth for an uncontrolled environment. This equipment should be installed and operated with a minimum distance of 0.5 centimeters between the radiator and your body.

This transmitter must not be co-located or operating in conjunction with any other antenna or transmitter.

The antennas used for this transmitter must be installed to provide a separation distance of at least 0.5 cm from all persons and must not be co-located or operating in conjunction with any other antenna or transmitter.

Australian Consumer Law

Our goods come with guarantees that cannot be excluded under Australian consumer law. You are entitled to a replacement or refund for a major failure and for compensation for any other reasonably foreseeable loss or damage. You are also entitled to have the goods repaired or replaced if the goods fail to be of acceptable quality and the failure does not amount to a major failure.





Industry Canada Compliance

IC Regulations:

This device complies with Industry Canada license-exempt RSS standard(s). Operation is subject to the following two conditions:

- (1) this device may not cause interference, and
- (2) this device must accept any interference, including interference that may cause undesired operation of the device.

Le présent appareil est conforme aux CNR d'Industrie Canada applicables aux appareils radio exempts de licence. L'exploitation est autorisée aux deux conditions suivantes:

- (1) l'appareil ne doit pas produire de brouillage, et
- (2) l'utilisateur de l'appareil doit accepter tout brouillage radioélectrique subi, même si le brouillage est susceptible d'en compromettre le fonctionnement."

CAN ICES-3(B)/NMB-3(B)

IC RF Exposure Compliance

This equipment complies with IC RSS-102 RF exposure limits set forth for an uncontrolled environment.

This Class B digital apparatus complies with Canadian ICES-003.
Cet appareil numérique de la classe B est conforme à la norme NMB-003 du Canada.

This Category II radiocommunication device complies with Industry Canada Standard RSS-310.
Ce dispositif de radiocommunication de catégorie II respecte la norme CNR-310 d'Industrie Canada.

IMPORTANT NOTE:

IC Radiation Exposure Statement:

This equipment complies with IC RSS-102 radiation exposure limits set forth for an uncontrolled environment. This equipment should be installed and operated with minimum distance 1.5 cm between the radiator & your body.

This device and its antenna(s) must not be co-located or operating in conjunction with any other antenna or transmitter.

CE Marking Warning

This is a Class B product, in a domestic environment, this product may cause radio interference, in which case the user may be required to take adequate measures.





Limited Warranty

Bryton Inc. warrants its products to be free from defects in materials or workmanship for one year from the date of purchase. Bryton Inc. will repair or replace any component that fails in normal use within this limited warranty period at no charge to the customer for parts or labor.

This warranty does not apply to

1. damage caused by misuse, accident, abuse, fire, or other external causes or acts of nature
2. physical damage to the surface, such as scratches and dents;
3. consumable parts, such as batteries, heart rate belt, unless product damage has occurred due to a defect in materials or workmanship
4. damage caused by anyone who is not an authorized service provider of Bryton Inc.

This Limited Warranty is subjected to the following terms and conditions:

1. To obtain warranty service, a proof of purchase, an original or copy of the sales receipt from the original retailer, is required.
2. Bryton Inc. retains the exclusive right to repair or replace the product or offer a full refund of the purchase price at its sole discretion.
3. Bryton Inc. will not replace missing components from any package purchased through an online auction. An original or copy of the sales receipt from the original retailer is required to obtain the Limited Warranty.
4. To obtain warranty service, contact Bryton Inc. (www.brytonsport.com) for shipping instructions.
5. This Limited Warranty covers expenses for inspecting and repairing the product during the Limited Warranty Period. The defective product shall be delivered by the purchaser at his/her own expense to the designated premises together with the proof of purchase.
6. All replaced faulty products or components will become the property of Bryton Inc.
7. The repaired or replaced parts by Bryton Inc. shall continue to be warranted for the remaining time of the original one year warranty period or for 90 days from the date of repair or replacement, depending upon which is longer.
8. Back up data and remove any confidential, proprietary, or personal information from the Product before returning any unit for service. Bryton Inc. is not responsible for damage to or loss of data.
9. Bryton Inc. products are intended to be used as personal aids and must not be used for precise measurement of direction, location, distance or topography and makes no warranty as to the accuracy or completeness of map data in its products.
10. Bryton Inc. reserves the right to refuse warranty claims against products or services that are obtained and/or used in contravention of the laws of any country.





11. For international purchases, a separate warranty may be provided by international distributors depending on the country. If applicable, this warranty is provided by the local in-country distributor and this distributor provides local service for your device. Distributor warranties are only valid in the area of intended distribution.

EXCLUSION OF OTHER DAMAGES. TO THE FULL EXTENT ALLOWED BY LAW, BRYTON INC. AND ITS SUPPLIERS, AFFILIATES AND AGENTS ARE NOT LIABLE FOR ANY:

- (i) CONSEQUENTIAL OR INCIDENTAL DAMAGES;
- (ii) DAMAGES OR LOSS OF ANY NATURE WHATSOEVER RELATING TO LOST PROFITS, BUSINESS INTERRUPTION, LOSS OF DATA OR PRIVACY OR CONFIDENTIALITY, ANY INABILITY TO USE ALL OR PART OF THE HARDWARE DEVICE OR SOFTWARE, PERSONAL INJURY, OR ANY FAILURE TO MEET ANY DUTY (INCLUDING BUT NOT LIMITED TO ANY DUTY OF NEGLIGENCE, GOOD FAITH OR OF WORKMANLIKE EFFORT); OR
- (iii) INDIRECT, SPECIAL, OR PUNITIVE DAMAGES ARISING OUT OF OR RELATING IN ANY WAY TO THE SOFTWARE OR HARDWARE DEVICE. THE FOREGOING APPLIES EVEN IF BRYTON INC. OR ANY SUPPLIER, AFFILIATE OR AGENT HAS BEEN ADVISED OF THE POSSIBILITY OF SUCH LOSSES OR DAMAGES; AND EVEN IN THE EVENT OF FAULT, TORT (INCLUDING NEGLIGENCE), STRICT OR PRODUCT LIABILITY, MISREPRESENTATION OR OTHER REASON.

Some jurisdictions do not allow the exclusion or limitation of incidental or consequential damages, so the above limitation or exclusions may not apply to You.





Accord relatif à la sécurité

IMPORTANT : *Veillez lire cet avis avant d'utiliser ce produit*

FR

Les produits et accessoires Bryton ne sont pas des dispositifs médicaux et leurs mesures sont pour référence seulement. Bryton n'est pas responsable des conséquences quelle que soit l'erreur de mesure. Consultez toujours votre médecin avant de commencer un programme de formation ou d'utiliser un moniteur de fréquence cardiaque. Veuillez ne pas utiliser le produit pendant une quelconque activité, car le manque d'attention peut entraîner des blessures, la mort ou des dommages matériels. Lors de l'utilisation ou de l'installation de ce produit, veuillez respecter toutes les législations et réglementations locales en vigueur. Ni nous, ni nos fabricants ou concédants de licence ne doivent assumer une quelconque responsabilité pour les dommages découlant de l'utilisation de ce produit pendant des activités, d'une mauvaise utilisation, d'une mauvaise installation, d'une catastrophe naturelle, de toute violation du code de la route ou de la sécurité, ou des logiciels et données cartographiques incluses dans le produit. Ce produit n'est pas garanti exempt d'erreurs ou des lacunes, et n'est pas garanti comme étant adéquat pour un but défini.

Avertissements concernant les piles

1. Ne laissez pas l'appareil exposé à une source de chaleur ou à une température élevée.
2. Ne pas perforer ni incinérer.
3. Ne tentez pas de retirer la pile non remplaçable par l'utilisateur.
4. Ne pas faire fonctionner l'appareil en dehors de la plage de température : -4 à 131°F (-20 à 55 °C).
5. Stocker dans la gamme de température suivante en cas de stockage prolongé : 32 à 77°F (0 à 25 °C)
6. Recycler ou mettre au rebut l'appareil ou la batterie de façon correcte.

ATTENTION

RISQUE D'EXPLOSION SI UNE PILE EST REMPLACÉE PAR UN TYPE INCORRECT.
DÉBARRASEZ-VOUS DES PILES USAGÉES SELON LES INSTRUCTIONS.

Avertissement relatif au marquage CE

Il s'agit d'un produit de classe B, dans un environnement domestique, ce produit peut provoquer des interférences radio, auquel cas l'utilisateur peut être amené à prendre des mesures adéquates.





Garantie limitée

Bryton Inc. garantit que ses produits sont exempts de défauts de pièces et de main-d'œuvre pendant un an à compter de la date d'achat. Bryton Inc. s'engage à réparer ou remplacer tout composant qui tombe en panne au cours d'une utilisation normale pendant cette période de garantie limitée, sans frais de pièces ou de main-d'œuvre pour le client.

Cette garantie ne s'applique pas aux

1. dommages causés par une mauvaise utilisation, un accident, un abus, un incendie, d'autres causes externes ou des catastrophes naturelles
2. dommages physiques de la surface, tels que les rayures et les bosses ;
3. La garantie ne s'applique pas aux pièces d'usure, comme les piles, la ceinture de fréquence cardiaque, sauf si le dommage est survenu en raison d'un défaut de pièce ou de fabrication.
4. dommages causés par toute personne qui n'est pas un fournisseur de services autorisé de Bryton Inc.

Cette garantie limitée est soumise aux termes et conditions suivants :

1. Pour obtenir un service sous garantie, une preuve d'achat, l'original ou une copie de la facture de vente du détaillant d'origine, est nécessaire.
-
- 
- 
- 
- 



2. Bryton Inc. se réserve le droit exclusif de réparer ou de remplacer le produit, ou d'offrir un remboursement intégral du prix d'achat, à son entière discrétion.
3. Bryton Inc. ne remplacera pas les composants manquants pour tout produit acheté dans une vente aux enchères en ligne. Un original ou une copie de la facture du détaillant d'origine est requis pour obtenir la garantie limitée.
4. Pour obtenir le service sous garantie, contactez Bryton Inc. (www.brytonsport.com) pour les instructions d'expédition.
5. Cette garantie limitée couvre les frais d'inspection et de réparation du produit au cours de la période de garantie limitée. Le produit défectueux doit être livré par l'acheteur à ses propres frais dans les locaux désignés, avec la preuve d'achat.
6. Tous les produits remplacés et les composants défectueux deviennent la propriété de Bryton Inc.
7. Les pièces réparées ou remplacées par Bryton Inc. continuent d'être garanties pour la durée restante de la période de garantie initiale d'une année ou pour une durée de 90 jours à compter de la date de réparation ou de remplacement, selon laquelle est la plus longue.
8. Sauvegardez les données et supprimez toutes les informations confidentielles, exclusives ou personnelles du produit avant de renvoyer tout appareil pour réparation. Bryton Inc. n'est pas responsable des dommages ni des pertes de données.
9. Les produits Bryton Inc. sont destinés à être utilisés comme aides personnelles et ne doivent pas être utilisés pour des mesures précises de direction, de position, de distance ni de topographie, et ils ne comprennent aucune garantie quant à l'exactitude ou à l'exhaustivité des données cartographiques intégrées.
10. Bryton Inc. se réserve le droit de refuser les réclamations sous garantie contre les produits ou services qui sont obtenus et / ou utilisés en violation des lois de tout pays.
11. Pour les achats internationaux, une garantie séparée peut être fournie par les distributeurs internationaux selon les pays. Le cas échéant, cette garantie est fournie par le distributeur du pays et ce distributeur offre une réparation locale de votre appareil. Les garanties du distributeur ne sont valides que dans la zone de distribution prévue.

EXCLUSION DES DOMMAGES AUTRES. DANS LA COMPLÈTE LIMITE DE LA LOI, BRYTON INC., SES FOURNISSEURS, FILIALES ET AGENTS SONT PAS RESPONSABLE D'AUCUN :

(i) DOMMAGE DIRECT OU INDIRECT ;

(ii) DOMMAGE OU PERTE DE QUELQUE NATURE, QU'ELLE SOIT RELATIVE À UNE PERTE DE PROFITS, UNE INTERRUPTION D'ACTIVITÉ, UNE PERTE DE DONNÉES, DE VIE PRIVÉE OU DE CONFIDENTIALITÉ, UNE INCAPACITÉ QUELCONQUE D'UTILISER TOUT OU PARTIE D'UN DISPOSITIF MATÉRIEL OU LOGICIEL, DES BLESSURES, OU À UN QUELCONQUE MANQUEMENT À UN DEVOIR (INCLUANT MAIS NON LIMITÉ À UN DEVOIR DE NÉGLIGENCE, DE BONNE FOI OU D'EFFORTS PROFESSIONNELS) ; OU

(iii) DÉGÂT INDIRECT, SPÉCIAL, OU PUNITIF ISSUE DE OU EN RAPPORT, DE QUELQUE FAÇON, AVEC LE LOGICIEL OU LE DISPOSITIF MATÉRIEL. CE QUI SUIV S'APPLIQUE MÊME SI BRYTON INC. OU TOUT AUTRE FOURNISSEUR, AFFILIÉ OU AGENT A ÉTÉ PRÉVENU DE LA POSSIBILITÉ DE TELLES PERTES OU DE TELS DOMMAGES ; ET CE MÊME DANS LES CAS DE FAUTE, DE TORT (Y COMPRIS POUR NÉGLIGENCE), DE RESPONSABILITÉ STRICTE OU DU PRODUIT, DE FAUSSE DÉCLARATION OU AUTRE.

Certaines juridictions n'autorisent pas l'exclusion ou la limitation des dommages fortuits ou consécutifs, les limitations ou exclusions susmentionnées peuvent donc ne pas s'appliquer à vous.





Sicherheitsvereinbarung

WICHTIG: Bitte lesen Sie sich diesen Hinweis vor der Inbetriebnahme des Produktes durch

Die Produkte und das Zubehör von Bryton sind keine medizinischen Geräte; die Messwerte dienen nur als Referenz. Bryton haftet nicht für die Konsequenzen jeglicher fehlerhafter Messwerte. Wenden Sie sich vor dem Beginn eines Trainingsprogramms bzw. der Nutzung eines Herzfrequenzmessers an Ihren Arzt. Bitte betreiben Sie das Gerät nicht während irgendwelcher Aktivitäten, da mangelnde Aufmerksamkeit (lebensgefährliche) Verletzungen sowie Materialschäden verursachen kann. Achten Sie bei der Verwendung und/oder Installation des Gerätes darauf, die geltenden örtlichen Gesetze und Richtlinien einzuhalten. Wir und unsere Hersteller und Lizenzgeber haften nicht für Schäden, die durch die Verwendung dieses Produktes während Aktivitäten, durch Missbrauch, unsachgemäße Installation, höhere Gewalt und Verletzung der Verkehrs- und Sicherheitsrichtlinien bzw. die im Produkt enthaltenen Software- oder Kartendaten entstanden sind. Der Hersteller garantiert nicht, dass dieses Produkt frei von Fehlern oder Mängeln ist; zudem erfolgt keine Zusicherung bezüglich der Eignung für einen bestimmten Zweck.

DE

Warnhinweise zum Akku

1. Bewahren Sie das Gerät nicht in der Nähe einer Hitzequelle bzw. in einer Umgebung mit hohen Temperaturen auf.
2. Durchstechen und verbrennen Sie den Akku nicht.
3. Versuchen Sie nicht, einen nicht durch den Benutzer herausnehmbaren Akku zu entfernen.
4. Betreiben Sie das Gerät nicht außerhalb des Temperaturbereichs: -20 bis 55 °C.
5. Bewahren Sie das Gerät innerhalb des folgenden Temperaturbereichs auf: 0 bis 25 °C
6. Recyceln bzw. entsorgen Sie das Gerät bzw. den Akku ordnungsgemäß.

CAUTION

RISK OF EXPLOSION IF BATTERY IS REPLACED BY AN INCORRECT TYPE.
DISPOSE OF USED BATTERIES ACCORDING TO THE INSTRUCTIONS.

Warnung zur CE-Kennzeichnung

Dies ist ein Produkt der Klasse B, das beim Einsatz in Wohnumgebungen Funkstörungen verursachen kann, die eventuell vom Anwender durch angemessene Maßnahmen zu kompensieren sind.

Eingeschränkte Garantie

Die Bryton Inc. garantiert, dass ihre Produkte innerhalb eines Jahres ab Kaufdatum frei von Material- und Verarbeitungsfehlern sind. Die Bryton Inc. repariert oder ersetzt dem Kunden innerhalb der Dauer der eingeschränkten Garantie kostenlos jegliche Komponenten, die bei einem normalen Gebrauch einen Fehler aufweisen.

Diese Garantie gilt nicht bei

1. Schäden, die durch fehlerhaften Einsatz, Unfall, Missbrauch, Feuer oder andere externe Ursachen bzw. Naturkatastrophen verursacht wurden;
2. Physikalischen Schäden der Oberfläche, wie z. B. Kratzer oder Druckstellen;
3. Verschleißmaterialien, solche wie z.B. Batterien, Herzfrequenzbrustgürte, etc., sofern dieser Produktschaden nicht aufgrund eines Produktions- oder Verarbeitungsfehlers entstanden ist.
4. Schäden, die durch eine Person verursacht wurde, die kein von der Bryton Inc. autorisierter Dienstleister ist.





Diese eingeschränkte Garantie unterliegt den folgenden Bedingungen:

1. Zur Inanspruchnahme des Garantiedienstes benötigen Sie einen Kaufbeleg - das Original bzw. eine Kopie der Rechnung vom Originalhändler.
2. Die Bryton Inc. behält sich das exklusive Recht vor, im eigenen Ermessen zwischen der Reparatur oder dem Ersatz des Produktes bzw. der Erstattung des vollen Kaufpreises zu wählen.
3. Die Bryton Inc. ersetzt keine im Lieferumfang fehlenden Komponenten von Produkten, die bei einer Online-Auktion erworben wurden. Zur Inanspruchnahme der eingeschränkten Garantie ist das Original oder eine Kopie der Rechnung vom Originalhändler erforderlich.
4. Wenden Sie sich zur Inanspruchnahme des Garantiedienstes an die Bryton Inc. (www.brytonsport.com) - daraufhin erhalten Sie Hinweise zum Versand des defekten Produktes.
5. Die eingeschränkte Garantie deckt die Kosten der Überprüfung und Reparatur des Produktes innerhalb der Dauer der eingeschränkten Garantie ab. Das defekte Produkt muss auf Verantwortung des Kunden unter den gegebenen Voraussetzungen gemeinsam mit dem Kaufbeleg versendet werden.
6. Alle ersetzten fehlerhaften Produkte oder Komponenten gehen in das Eigentum der Bryton Inc. über.
7. Die von der Bryton Inc. reparierten oder ersetzten Teile sind für die verbleibende Dauer der ursprünglichen einjährigen Garantie oder aber 90 Tage ab dem Datum der Reparatur oder des Ersatzes durch eine Garantie abgedeckt - je nachdem, welcher Zeitraum länger ist.
8. Sichern und entfernen Sie vor dem Einsenden des Produktes jegliche vertraulichen Daten sowie proprietäre oder persönliche Informationen vom Produkt. Die Bryton Inc. haftet nicht für Datenschutz- oder Datenverlust.
9. Produkte der Bryton Inc. dienen dem Benutzer als persönliche Hilfe und dürfen nicht zu präzisen Messungen der Richtung, des Standortes, der Entfernung oder Topographie eingesetzt werden; der Hersteller garantiert nicht die Genauigkeit oder Vollständigkeit der in seinen Produkten enthaltenen Kartendaten.
10. Die Bryton Inc. behält sich das Recht vor, Garantiebeschwerden gegenüber den Produkten oder Dienstleistungen abzulehnen, die nicht entsprechend der Gesetze in dem jeweiligen Land eingereicht wurden und/oder derartige Gesetze verletzen.
11. Bei internationalem Verkauf wird je nach Land möglicherweise eine separate Garantie durch den internationalen Vertreter bereitgestellt. Sofern möglich sollte diese Garantie durch den lokalen Inlandsvertreiter bereitgestellt werden; dieser Vertreter übernimmt auch die Reparatur Ihres Gerätes. Die Garantien der Vertreter sind nur in der zum Vertrieb angedachten Region gültig.

Ausnahmen anderer Schäden. In höchstzulässigem Umfang haften die Bryton Inc., ihre Lieferanten, Tochtergesellschaften und Händler haften nicht für:

- (i) beiläufige oder Folgeschäden;
 - (ii) Schäden oder Verluste jeglicher Art, die im Zusammenhang stehen mit: Entgangenem Gewinn, Geschäftsunterbrechungen, Datenverlusten oder Verletzungen der Privatsphäre, der Unfähigkeit zur Benutzung des gesamten oder eines Teiles des Hardware-Gerätes oder der Software, Personenschäden oder jegliches Versagen bei der Erfüllung von Pflichten (u. a. Sorgfaltspflicht, Fürsorgepflicht und der Pflicht des fachgerechten Bemühens); oder
 - (iii) indirekte, spezielle oder Strafschäden, die durch oder in Verbindung mit der Software oder dem Hardware-Gerät entstehen. Das Vorangegangene gilt auch, wenn die Bryton Inc. oder ihre Lieferanten, Tochtergesellschaften oder Händler von der Möglichkeit derartiger Verluste oder Schäden unterrichtet wurden; und auch im Falle von Fehlern, Vergehen (auch durch Nachlässigkeit), Kausal- oder Produkthaftung, falscher Darstellung oder bei anderen Ursachen.
- Einige Jurisdiktionen erlauben keine Ausnahme oder Beschränkung versehentlicher oder folgerichtiger Schäden; in diesem Fällen treffen die obengenannten Ausnahmen und Beschränkungen auf Sie möglicherweise nicht zu.





Accordo sulla sicurezza

IMPORTANTE: Leggere questo avviso prima di usare il prodotto

I prodotti e gli accessori Bryton non sono dispositivi medici e le loro letture sono solo indicative. Bryton non è responsabile per le conseguenze di qualsiasi lettura sbagliata. Consultare sempre il medico prima di iniziare un programma di preparazione o prima di usare il cardiofrequenzimetro. Non usare il prodotto durante qualsiasi attività, perché la mancanza della dovuta attenzione può provocare lesioni, la morte o danni materiali. Quando si usa o si installa questo prodotto, osservare tutte le leggi e le normative locali applicabili. Noi, i nostri produttori e concessionari di licenza non ci assumiamo alcuna responsabilità per i danni provocati da: uso del prodotto durante le attività, cattivo uso, installazione inappropriata, atti divini, violazione del traffico o delle norme di sicurezza, uso del software o dei dati mappa contenuti nel prodotto. Questo prodotto non è garantito essere privo di errori o difetti, e non è garantito per essere applicabile a qualsiasi scopo definito.

IT

Avvisi sulle batterie

1. Non lasciare il dispositivo esposto a sorgenti di calore o in ambienti soggetti ad alte temperature.
2. Non perforare o incenerire.
3. Non tentare di rimuovere la batteria non sostituibile.
4. Non usare il dispositivo a temperature che eccedono i seguenti valori: -4°F a 131°F (-20°C a 55°C)
5. L'immagazzinamento per periodi prolungati deve essere eseguito alle seguenti temperature: da 32°F a 77°F (da 0°C a 25°C)
6. Riciclare o smaltire in modo appropriato il dispositivo o la batteria.

ATTENZIONE

C'È IL RISCHIO D'ESPLOSIONI SE LA BATTERIA SOSTITUITA NON È DEL TIPO CORRETTO.
SMALTIRE LE BATTERIE USATE SECONDO LE ISTRUZIONI.

Avviso sul marchio CE

In un ambiente domestico questo prodotto di Classe B può provocare interferenze radio nel cui caso potrebbe essere richiesto all'utente di prendere misure adeguate.

GARANZIA LIMITATA

Bryton Inc. garantisce che i suoi prodotti sono liberi da difetti dei materiali o della lavorazione per un anno dalla data d'acquisto. Bryton Inc. riparerà o sostituirà tutti i componenti che si guastano durante l'uso normale entro il periodo di garanzia senza alcun addebito al cliente per i costi delle parti o della lavorazione.

Questa garanzia non si applica a

1. Danni causati da cattivo uso, incidente, abusi, incendio o altre cause naturali esterne
2. Danni fisici alla superficie come graffi e botte;
3. La garanzia non si applica sulle parti di consumo, quali batteria, fascia cardio, ecc. a meno che il problema sia dovuto ad un difetto di materiale o di lavorazione.
4. Danni provocati da chiunque non sia un centro assistenza autorizzato della Bryton Inc.





Questa garanzia limitata è soggetta ai seguenti termini e condizioni:

1. Per ottenere l'assistenza in garanzia è necessaria la prova d'acquisto, l'originale o la copia dello scontrino o fattura emessa dal rivenditore.
2. Bryton Inc. possiede il diritto esclusivo di riparare o sostituire il prodotto o di offrire il rimborso del prezzo d'acquisto a sua discrezione.
3. Bryton Inc. non sostituirà componenti mancanti dalle confezioni dei prodotti acquistati online. Per ottenere l'assistenza in garanzia è necessaria la copia o l'originale della prova d'acquisto emessa dal venditore originale.
4. Contattare Bryton Inc. (www.brytonsport.com) per ottenere l'assistenza in garanzia e le istruzioni per la spedizione.
5. Questa garanzia limitata copre le spese per l'ispezione e la riparazione del prodotto durante il periodo della garanzia limitata. Il prodotto difettoso sarà spedito a spese dell'acquirente all'indirizzo specificato insieme alla prova d'acquisto.
6. Tutti i prodotti o componenti difettosi sostituiti diventeranno di proprietà della Bryton Inc.
7. Le parti riparate o sostituite da Bryton Inc. continueranno ad essere garantite per il periodo rimanente della garanzia originale di un anno, oppure per 90 giorni dalla data della riparazione o sostituzione, in base a quale dei due sia più lungo.
8. Prima di inviare qualsiasi unità per la riparazione, assicurarsi di eseguire il backup dei dati e di rimuovere dal prodotto tutte le informazioni private, di proprietà intellettuale o personali. Bryton Inc. non è responsabile per la perdita o la corruzione dei dati.
9. I prodotti Bryton Inc. sono intesi per essere usati come supporti personali e non devono essere usati per la misurazione precisa di direzione, posizione, distanza o topografica; non è fatta alcuna garanzia riguardo all'accuratezza o alla completezza dei dati mappa contenuti nei prodotti.
10. Bryton Inc. si riserva il diritto di rifiutare richieste di riparazione o assistenza di prodotti che sono stati ottenuti e/o usati in contravvenzione alle leggi di qualsiasi paese.
11. Per gli acquisti internazionali potrebbe essere fornita una garanzia separata fornita dai distributori internazionali in base ai vari paesi. Se applicabile, questa garanzia è fornita dal distributore locale e questo distributore fornisce l'assistenza al dispositivo. Le garanzie dei distributori sono valide solo nella zona intesa per la distribuzione.

ESCLUSIONE DI ALTRI DANNI. NEI TERMINI CONSENTITI DALLA LEGGE BRYTON INC., I SUOI FORNITORI, AFFILIATI ED AGENTI, NON SONO RESPONSABILI PER ALCUN:

(i) DANNO CONSEGUENTE O ACCIDENTALE;

(ii) DANNO O PERDITA DI QUALSIVOGLIA NATURA RELATIVA AL DEFICIT DI PROFITTI, INTERRUZIONE DELL'ATTIVITÀ COMMERCIALE, PERDITA DI DATI O PRIVACY O SEGRETEZZA, QUALSIASI INABILITÀ ALL'USO COMPLETO O PARZIALE DEL DISPOSITIVO HARDWARE O DEL SOFTWARE, LESIONI PERSONALI, QUALSIASI CARENZA A SODDISFARE QUALSIASI DOVERE (INCLUDENDO SENZA LIMITAZIONE QUALSIASI DOVERE DI DILIGENZA, BUONA FEDE O IMPEGNO LAVORATIVO); OPPURE

(iii) DANNO INDIRETTO, SPECIALE O PUNITIVO PROVOCATO DA O RELATIVO IN QUALSIASI MODO AL SOFTWARE O A DISPOSITIVO HARDWARE. QUANTO DETTO SI APPLICA ANCHE SE BRYTON INC. O QUALSIASI SUO FORNITORE, AFFILIATO O AGENTE È STATO AVVISATO DELLA POSSIBILITÀ DI TALI PERDITE O DANNI; ED ANCHE NEL CASO DI GUASTO, TORTO (INCLUDENDO LA NEGLIGENZA), RESPONSABILITÀ DIRETTA O DEL PRODOTTO, FALSA DICHIARAZIONE O ALTRO MOTIVO.

Alcune giurisdizioni non consentono l'esclusione o la limitazione dei danni accidentali o conseguenti; quindi le limitazioni ed esclusioni di cui sopra potrebbero non esservi applicate.



Contrato de seguridad

IMPORTANTE: *lea esta notificación antes de utilizar este producto.*

Los productos y accesorios Bryton no son dispositivos médicos y sus lecturas solamente deben interpretarse como una referencia. Bryton no se responsabilizará de las consecuencias de lecturas erróneas. Consulte siempre a su médico antes de iniciar cualquier programa de entrenamiento o utilizar un monitor de frecuencia cardíaca. No utilice el producto durante ninguna actividad porque, si no se presta la atención adecuada, se pueden producir lesiones, podría morir o se podrían provocar daños materiales. Cuando utilice o instale este producto, cumpla todas las leyes y normativas locales vigentes. Nosotros, nuestros fabricantes y otorgantes de licencia no asumirán ninguna responsabilidad por los daños causados por el uso de este producto durante actividades, mal uso, instalación inadecuada, actos de la naturaleza, infracción de las normas de circulación o de seguridad, o el software o los datos cartográficos aquí contenidos. No se garantiza que este producto esté libre de errores o deficiencias y no se garantiza que sea aplicable para cualquier finalidad definida.

ES

Advertencias sobre la batería

1. No deje el dispositivo expuesto a una fuente de calor o a una temperatura elevada.
2. No lo perforo ni incinere.
3. No intente quitar la batería no reemplazable por el usuario.
4. No lo utilice el dispositivo fuera del siguiente intervalo de temperatura: -20 a 55 °C (-4 a 131 °F).
5. No almacene el dispositivo dentro del siguiente intervalo de temperatura durante un prolongado período de tiempo: 0 a 25 °C (32 a 77 °F)
6. Recicle o deshágase del dispositivo o la batería adecuadamente.

Cumplimiento de la normativa FCC

Este dispositivo cumple la Parte 15 de las Reglas de la FCC. El funcionamiento se encuentra sujeto a las siguientes dos condiciones: (1) este dispositivo no puede causar interferencias dañinas, y (2) este dispositivo debe aceptar cualquier interferencia recibida, incluyendo interferencias que puedan causar un funcionamiento no deseado. Este aparato digital de Clase B cumple la normativa canadiense ICES-003.

Advertencia de la marca CE

Éste es un producto de Clase B. En un entorno doméstico, este producto puede causar interferencias de radio, en cuyo caso se puede instar al usuario a que tome las medidas oportunas.

Garantía limitada

Bryton Inc. garantiza que sus productos están libres de defectos materiales o de mano de obra durante un año a partir de la fecha de compra. Bryton Inc. reparará o reemplazará cualquier componente que falle en condiciones de uso normal dentro de este período de garantía limitado sin coste alguno para el cliente en lo que a piezas y mano de obra se refiere.

Esta garantía no se aplica a:

1. daños causados por mal uso, accidentes, abuso, incendio u otras causas externas o actos de la naturaleza
2. daños físicos en la superficie, como arañazos y abolladuras;
3. Esta garantía no es de aplicación a piezas consumibles tales como baterías, cinturón textil que acompaña al sensor ritmo cardíaco, etc, salvo que el fallo del producto se halla producido por un defecto de montaje o de los materiales.
4. daños causados por cualquiera que no sea un proveedor de servicio autorizado de Bryton Inc.



Esta garantía limitada está sujeta a los siguientes términos y condiciones:

1. Para obtener el servicio de garantía, se necesita una prueba de compra, ya sea la factura del proveedor original o una copia de la misma.
2. Bryton Inc. conserva el derecho exclusivo de reparar o reemplazar el producto u ofrecer el reembolso completo del precio de compra, lo que estime más oportuno.
3. Bryton Inc. no reemplazará los componentes que falten de ningún paquete adquirido a través de subastas en línea. Para tener derecho a la Garantía limitada, se necesita el recibo de venta original del distribuidor original o una copia de dicho recibo.
4. Para obtener el servicio de garantía, póngase en contacto con Bryton Inc. (www.brytonsport.com) para obtener instrucciones sobre el envío.
5. Esta Garantía limitada cubre los gastos de inspección y reparación del producto durante el Período de garantía limitada. El producto defectuoso será entregado por el comprador, que asumirá los gastos, a las instalaciones designadas junto con la prueba de compra.
6. Todos los productos o componentes defectuosos reemplazados pasarán a ser propiedad de Bryton Inc.
7. Las piezas reparadas o reemplazadas por Bryton Inc. seguirán estando garantizadas durante el tiempo restante del período de garantía de un año o durante 90 días a partir de la fecha de la reparación o sustitución, lo que sea más largo.
8. Haga una copia de seguridad de los datos y quite cualquier información confidencial, patentada o personal del Producto antes de devolver cualquier unidad para que la reparen. Bryton Inc. no se responsabilizará de ningún daño causado a los datos o de la pérdida de estos.
9. Los productos Bryton Inc. están diseñados para utilizarse como ayuda personal y no se deben usar para medición precisa de direcciones, ubicaciones, distancias o topografía y no se garantiza la precisión o integridad de los datos cartográficos de este producto.
10. Bryton Inc. se reserva el derecho de rechazar las reclamaciones de garantía contra productos o servicios obtenidos y/o utilizados contraviniendo las leyes de cualquier país.
11. Para compras internacionales, los distribuidores internacionales pueden proporcionar una garantía independiente en función del país. Si procede, esta garantía la proporciona el distribuidor del país local, quien también ofrece servicio local para su dispositivo. Las garantías del distribuidor solamente son válidas en el área de distribución para el que se han sido pensadas.

EXCLUSIÓN DE OTROS DAÑOS. HASTA DONDE LO PERMITA LA LEY, BRYTON INC. Y SUS PROVEEDORES, FILIALES Y AGENTES NO SE RESPONSABILIZARÁN DE NINGÚN:

(i) DAÑO CONSECUENTE O INCIDENTAL;

(ii) DAÑO O PÉRDIDA DE NINGUNA NATURALEZA, SEA LA QUE FUERE, RELACIONADA CON LA PÉRDIDA DE BENEFICIOS, INTERRUPCIÓN DE NEGOCIO, PÉRDIDA DE DATOS, PRIVACIDAD O CONFIDENCIALIDAD, CUALQUIER INCAPACIDAD PARA UTILIZAR EL DISPOSITIVO DE HARDWARE O EL SOFTWARE TOTAL O PARCIALMENTE, LESIÓN PERSONAL O INCUMPLIMIENTO DE OBLIGACIONES (INCLUIDOS, SIN LIMITACIÓN, CUALQUIER RESPONSABILIDAD DE NEGLIGENCIA, BUENA FE ESFUERZO PROFESIONAL); O

(iii) DAÑOS INDIRECTOS, ESPECIALES O PUNITIVOS QUE SURJAN DE O ESTÉN RELACIONADOS DE CUALQUIER FORMA CON EL SOFTWARE O DISPOSITIVO DE HARDWARE. LO ANTERIOR SE APLICA AUNQUE BRYTON INC. O CUALQUIER PROVEEDOR, FILIAL O AGENTE HAYA SIDO AVISADO DE LA POSIBILIDAD DE TALES PÉRDIDAS O DAÑOS; E INCLUSO EN EL CASO DE RESPONSABILIDAD POR ERROR, AGRAVIO (INCLUIDA LA NEGLIGENCIA), E STRICTA O DE PRODUCTO, TERGIVERSACIÓN O CUALQUIER OTRA RAZÓN.

Debido a que algunas jurisdicciones no permiten la exclusión o limitación de daños incidentales o consecuentes, es posible que la limitación o exclusiones anteriores no se apliquen en su caso.





Veiligheidsovereenkomst

BELANGRIJK: Lees deze mededeling voordat u dit product gebruikt

Producten en accessoires van Bryton zijn geen medische apparaten en hun aflezingen zijn uitsluitend als referentie bedoeld. Bryton is niet aansprakelijk voor de gevolgen van verkeerde aflezingen. Raadpleeg altijd uw arts voordat u een trainingsprogramma start of een hartslagmonitor gebruikt. Gebruik het product niet tijdens eventuele activiteiten omdat gebrek aan aandacht letsels, overlijden of materiële schade kan veroorzaken. Wanneer u dit product gebruikt of installeert moet u voldoen aan alle toepasselijke wetten en voorschriften. Wij en onze fabrikanten en licentieverleners zullen geen enkele aansprakelijkheid aanvaarden voor schade die voortvloeit uit het gebruik van dit product tijdens activiteiten, misbruik, verkeerde installatie, overmacht, overtreding van verkeers- of veiligheidsvoorschriften of software of kaartgegevensproducten daarin. Dit product is niet gegarandeerd vrij van fouten of afwijkingen en is niet gegarandeerd als toepasselijk voor elk gedefinieerd doel.

NL

Batterijwaarschuwingen

1. Zorg dat het apparaat niet wordt blootgesteld aan een warmtebron of hoge temperaturen.
2. Niet doorprikken of verbranden.
3. Probeer nooit de niet door de gebruiker vervangbare batterij te vervangen.
4. Gebruik het apparaat niet buiten het temperatuurbereik: -20 tot 55°C).
5. Bewaar het binnen het volgende temperatuurbereik voor een langere periode: 0 tot 25°C
6. U moet het apparaat of de batterij op de juiste manier recyclen of wegwerpen.

WAARSCHUWING

ONTPLOFFINGSGEVAAR ALS DE BATTERIJ WORDT VERVANGEN DOOR EEN VERKEERD TYPE.
GOOI LEGE BATTERIJEN WEG IN OVEREENSTEMMING MET DE INSTRUCTIES.

Waarschuwing CE-markering

Dit is een Klasse B-product. In een huiselijke omgeving kan dit product radiostoringen veroorzaken. In dat geval kan de gebruiker worden gevraagd de nodige maatregelen te nemen.

Beperkte garantie

Bryton Inc. garandeert dat haar producten vrij zijn van defecten in materiaal of vakmanschap gedurende één jaar vanaf de datum van aankoop. Bryton Inc. zal elk onderdeel dat defect raakt bij normaal gebruik binnen deze beperkte garantieperiode repareren of vervangen zonder enige kosten voor de klant voor onderdelen of werken.

Deze garantie is niet van toepassing op het volgende:

1. Schade die wordt veroorzaakt door verkeerd gebruik, ongeval, misbruik, brand of andere externe oorzaken of gevallen van overdaad
2. materiële schade aan het oppervlak, zoals krassen en deuken;
3. Deze garantie voorwaarden gelden niet voor gebruikersonderdelen, zoals batterijen, hartslagband, etc. Tenzij er productschade is opgetreden ten gevolgen van het materiaal of het productieproces.
4. schade veroorzaakt door iedereen die geen erkende serviceprovider van Bryton Inc. is



Ta ograniczona gwarancja podlega następującym terminom i warunkom:

1. Aby uzyskać usługę gwarancyjną wymagany jest dowód zakupu, oryginał lub kopia pokwitowania sprzedaży od oryginalnego sprzedawcy.
2. Bryton Inc. zachowuje sobie wyłączne prawo, według własnego uznania, do wyboru do naprawy lub wymiany produktu lub zaoferowania pełnego zwrotu kosztów zakupu.
3. Bryton Inc. nie wymieni żadnych brakujących komponentów z opakowań zakupionych w trybie aukcji online. Do uzyskania ograniczonej gwarancji jest wymagany oryginał lub kopia dowodu zakupu od oryginalnego sprzedawcy.
4. Aby uzyskać usługę gwarancyjną należy skontaktować się z Bryton Inc. (www.brytonsport.com) w celu uzyskania instrukcji dostarczenia.
5. W czasie obowiązywania ta ograniczona gwarancja obejmuje wszelkie koszty sprawdzenia i naprawy produktu. Uszkodzony produkt powinien zostać dostarczony przez nabywcę na jego/jej własny koszt do określonego miejsca, łącznie z dowodem zakupu.
6. Wszelkie wymienione uszkodzone produkty lub komponenty stają się własnością Bryton Inc.
7. Części naprawione lub wymienione przez Bryton Inc., będą dalej objęte gwarancją na pozostały okres obowiązywania oryginalnej jednorocznej gwarancji lub na 90 dni, od daty naprawy lub wymiany, w zależności od tego, który okres jest dłuższy.
8. Przed oddaniem jakiegokolwiek urządzenia do naprawy należy wykonać kopię zapasową danych i usunąć z produktu wszelkie informacje poufne, dotyczące własności lub osobiste. Bryton Inc. nie odpowiada za uszkodzenia spowodowane utratą danych.
9. Produkty Bryton Inc. są przeznaczone do używania jako urządzenia osobiste i nie służą do precyzyjnego pomiaru kierunku, lokalizacji, odległości lub topografii i nie gwarantuje się dokładności lub kompletności danych mapy w produktach tej firmy.
10. Bryton Inc. zastrzega sobie prawo do odmowy roszczeń gwarancyjnych w odniesieniu do produktów lub usług, uzyskanych i/lub używanych z naruszeniem prawa jakiegokolwiek kraju.
11. Przy zakupach międzynarodowych, poprzez międzynarodowych dystrybutorów, może być dostarczona oddzielna gwarancja, w zależności od kraju. Ta gwarancja, tam gdzie jest to stosowane, jest dostarczana przez lokalnego krajowego dystrybutora, a ten dystrybutor zapewnia lokalną usługę dla urządzenia. Gwarancja dystrybutora są zawsze wyłączone w regionie zamierzonej dystrybucji.

PL

WYŁĄCZENIE INNYCH SZKÓD. W CAŁYM, DOPUSZCZONYM PRAWEM ZAKRESIE, BRYTON INC. ORAZ DOSTAWCY TEJ FIRMY, STOWARZYSZENIA I AGENCJI, NIE ODPOWIADAJĄ ZA:

- (i) KONSEKWENTNE LUB PRZYPADKOWE SZKODY;
- (ii) SZKODY LUB STRATY DOWOLNEJ NATURY, ODNOŚĄCE SIĘ DO UTRATY ZYSKÓW, PRZERWANIA DZIAŁANOŚCI, UTRATY DANYCH LUB PRYWATNOŚCI ALBO POUFNOŚCI, WSZELKIEJ NIEMOŻNOŚCI UŻYWANIA CAŁEGO URZĄDZENIA LUB JEGO CZĘŚCI ALBO OPROGRAMOWANIA, OBRAŻEN OSOBISTYCH LUB WZASZELKICH SYTUACJI NIESPEŁNIANIA WYMAGAŃ (WŁĄCZNIE ALE NIE TYLKO Z ZANIEDBANIAM, DZIAŁANIEM W DOBRZEJ WIERZE LUB WYSIŁKIEM WŁOŻONYM W WYTWARZANIE); ALBO
- (iii) NIEBIEZPOŚREDNIE, SPECJALNE LUB KARNE SZKODY, POWSTAŁE POZA LUB ODNOŚĄCE SIĘ W JAKIKOLWIEK SPOŚÓB DO OPROGRAMOWANIA LUB URZĄDZENIA. POWYŻSZE OKREŚLENIA MĄJĄ ZASTOSOWANIE, NAWET JEŚLI BRYTON INC. LUB DOWOLNY DOSTAWCA, STOWARZYSZENIE LUB AGENT ZOSTANIE OSTRZEŻONY O MOŻLIWOŚCI TAKICH STRAT LUB SZKÓD; NAWET W PRZYPADKU AWARII, NIEDOZWOLONEGO DZIAŁANIA (WŁĄCZNIE Z ZANIEDBANIE), OGÓLNEJ ODPOWIEDZIALNOŚCI LUB ODPOWIEDZIALNOŚCI ZA PRODUKT, WPROWADZENIA W BŁĄD LUB INNEJ PRZYCZYNY.

W niektórych jurysdykcjach nie dopuszcza się do wyłączeń lub ograniczeń za przypadkowe lub wynikowe szkody, dlatego powyższe ograniczenie lub wyłączenia, mogą nie dotyczyć danego użytkownika.





Dohoda o bezpečnosti

DŮLEŽITÉ: Před používáním tohoto produktu si přečtěte toto upozornění

Produkty a příslušenství Bryton nejsou zdravotnické přístroje a hodnoty, které indikují, jsou pouze orientační. Společnost Bryton nenese odpovědnost za důsledky jakýchkoli chybových indikací. Před zahájením tréninkového programu nebo před použitím monitoru srdeční činnosti se vždy poraďte s lékařem. Nepoužívejte produkt při žádných činnostech, protože by nedostatek odpovídající pozornosti mohl způsobit zranění, úmrtí nebo materiální škodu. Při používání nebo montáži tohoto produktu dodržujte veškeré platné místní zákony a vyhlášky. My a naši výrobci a poskytovatelé licencí neneseme žádnou odpovědnost za škody způsobené používáním tohoto produktu při činnostech, nevhodným používáním, nesprávnou montáží, zásahem vyšší moci, jakýmkoli porušením dopravních a bezpečnostních pravidel nebo nainstalovaným softwarem nebo produktem mapových dat. Nelze zaručit, že je tento produkt bez chyb nebo závad a nelze zaručit, že bude vhodný pro jakýkoli definovaný účel.

Upozornění k baterii

1. Nenechávejte přístroj vystavený zdroji tepla nebo vysoké teplotě.
2. Neperforujte ani nespalujte.
3. Nepokoušejte se vyjmout baterii, kterou nemůže uživatel vyměnit vlastními silami.
4. Nepoužívejte přístroj mimo následující rozsah teploty: - 4 až 131 °F (- 20 až 55 °C).
5. Dlouhodobě skladujte v následujícím rozsahu teploty: 32 až 77 °F (0 až 25 °C)
6. Zařízení nebo baterii řádně zrecyklujte nebo zlikvidujte.

POZOR

PŘI VLOŽENÍ NESPRÁVNÉHO TYPU BATERIE HROZÍ NEBEZPEČÍ VÝBUCHU.
POUŽITÉ BATERIE ZLIKVIDUJTE PODLE POKYNŮ.

Upozornění ke značce CE

Toto je výrobek třídy B, a v domácím prostředí může tento výrobek způsobit rušení radiových vln, a v tom případě bude uživatel možná nucen podniknout adekvátní opatření.

Omezená záruka

Společnost Bryton Inc. zaručuje, že její produkty budou bez závad na materiálu nebo provedení po dobu jednoho roku ode dne zakoupení. Společnost Bryton Inc. zákazníkovi opraví nebo vymění jakoukoli součást, která selže při běžném používání v době omezené záruky, bez úhrady dílů nebo práce.

Tato záruka se nevztahuje na

1. škody způsobené nevhodným používáním, náhodně, špatným zacházením, požárem nebo jinými vnějšími příčinami nebo přírodními živly
2. fyzické poškození povrchu, například škrábance a promáčknutí;
3. This warranty does not apply to consumable parts, such as batteries, heart rate belts, etc. unless failure has occurred due to a defect in materials or workmanship.
4. poškození způsobená kýmkoli, kdo není autorizovaným poskytovatelem servisu společnosti Bryton Inc.





Na tuto omezenou záruku se vztahují následující podmínky

1. Aby bylo možné využít záruční servis, je vyžadován doklad o nákupu, originál nebo kopie paragonu od původního prodejce.
2. Společnost Bryton Inc. si zachovává výsadní právo podle vlastního uvážení opravit nebo vyměnit produkt nebo nabídnout vrácení nákupní ceny v plné výši.
3. Společnost Bryton Inc. nevymění chybějící součásti ze žádné sady zakoupené prostřednictvím aukce online. Aby bylo možné využít tuto omezenou záruku, je vyžadován originál nebo kopie paragonu od původního prodejce.
4. Chcete-li využít záruční servis, kontaktujte společnost Bryton Inc. (www.brytonsport.com) a požádejte o pokyny k odeslání.
5. Tato omezená záruka pokrývá náklady na kontrolu a opravu produktu v záruční době. Kupující musí doručit závadný produkt na svoje náklady na určené místo společně s dokladem o nákupu.
6. Veškeré vyměněné produkty nebo součásti se stávají majetkem společnosti Bryton Inc.
7. Na díly opravené nebo vyměněné společností Bryton Inc. se bude nadále vztahovat zbývající doba původní jednoleté záruky nebo 90 dní od data opravy nebo výměny, podle toho, co je delší.
8. Před odesláním každého přístroje k servisu zazálohujte data a odstraňte veškeré důvěrné, proprietární nebo osobní informace z produktu. Společnost Bryton Inc. nenesе odpovědnost za poškození nebo ztrátu dat.
9. Produkty společnosti Bryton Inc. jsou určeny pro používání jako osobní pomůcky a nesmějí být používány pro přesné měření směru, umístění, vzdálenosti nebo topografie; společnost neposkytuje žádnou záruku na přesnost nebo úplnost mapových dat ve svých produktech.
10. Společnost Bryton Inc. si vyhrazuje právo odmítnout záruční reklamacie na produkty nebo služby, které jsou poskytovány a/nebo používány v rozporu se zákony jakékoli země.
11. V závislosti na zemi mohou nadnárodní distributori pro nadnárodní prodeje poskytovat samostatnou záruku. Tuto záruku pokud možno poskytují lokální distributor pro danou zemi a tento distributor zajišťuje lokální servis vašeho přístroje. Záruky distributora jsou platné pouze v oblasti cílené distribuce.

VYLOUČENÍ JINÝCH ŠKOD. V PLNÉM ROZSAHU, JAK TO ZÁKON UMOŽŇUJE, NENÍ SPOLEČNOST BRYTON INC. ANI ŽÁDNÝ Z JEJICH DODAVATELŮ, Poboček či ZÁSTUPCŮ ODPOVĚDNÁ ZA ŽÁDNÉ:



- (i) NÁSLEDNÉ NEBO NÁHODNÉ ŠKODY;
- (ii) ŠKODY NEBO ZTRÁTY JAKÉKOLI POVAHY VZTAHUJÍCÍ SE K UŠLÉMU ZISKU, PŘERUŠENÍ PODNIKÁNÍ, ZTRÁTY DAT NEBO SOUKROMÍ NEBO DŮVĚRNOSTI, JAKÉKOLI NEMOŽNOSTI POUŽÍVAT ČELE NEBO ČÁST HARDWAROVÉHO ZAŘÍZENÍ NEBO SOFTWARE, ZRANĚNÍ OSOB NEBO PORUŠENÍ POVINNOSTI (VČETNĚ, NIKOLI VŠAK POUZE, POVINNOSTI PROVÁDĚNÝCH BEZ NEDBALOSTI, V DOBRÉ MÍŘE NEBO ODBORNÉ PRÁCE); NEBO
- (iii) NEPŘÍMÉ, ZVLÁŠTNÍ NEBO ODŠKODNĚNÍ VZNIKLÉ NEBO JAKÝMKOLI ZPŮSOBEM SE VZTAHUJÍCÍ K SOFTWARE NEBO K HARDWAROVÉMU ZAŘÍZENÍ. VÝŠE UVEDENÉ PODMÍNKY PLATÍ I V PŘÍPADĚ, ŽE SPOLEČNOST BRYTON INC. NEBO JAKÝKOLI DODAVATEL, Pobočka NEBO ZÁSTUPCE BYLI INFORMOVANI O MOŽNOSTI VZNIKU TAKOVÝCH ZTRÁT NEBO ŠKOD; ČI V PŘÍPADĚ CHYBY, PŘEČINU (VČETNĚ NEDBALOSTI), ABSOLUTNÍ ODPOVĚDNOSTI NEBO ODPOVĚDNOSTI ZA PRODUKT, ŠPATNÉHO VYJÁDRĚNÍ NEBO Z JINÉ PŘÍČINY.

V některých právních řádech není dovoleno vyloučit či omezit následné nebo nepřímé škody, proto se výše omezené omezení na vás nemusí vztahovat.





Biztonsági Megállapodás

FONTOS! Kérjük, olvassa el a felhívás szövegét, mielőtt használni kezdené a terméket.

A Bryton termékei és kiegészítői nem minősülnek orvosi eszköznek, ezért a kijelzett adatok kizárólag hivatkozással célját szolgálják. A Bryton nem vállal felelősséget a hibás adatok következményeiért. Tréningprogram megkezdése vagy a pulzsmérő használata előtt konzultáljon orvosával. Kérjük, ne működtesse a terméket egyéb feladatok végzése közben, mert a megfelelő figyelem hiánya személyi sérülést, halált vagy anyagi kárt okozhat. A termék használata, illetve üzembe helyezése közben tarts be az összes vonatkozó helyi törvényt és jogszabályt. Mi és gyártóink, illetve engedélyeseink nem vállalunk semmilyen kártérítési felelősséget a termék más tevékenység közben történő használata, helytelen használata, helytelen telepítése, Vis Maior, a közlekedési és biztonsági rendszabályok be nem tartása, illetve a benne lévő szoftver, illetve térképadat termék használata kapcsán. Nem garantáljuk, hogy a termék hiba- és hiányosságoktól mentes és nem garantáljuk, hogy bármilyen adott célra alkalmas.

Akkumulátorral kapcsolatos figyelmeztetés

1. Ne tegye ki hosszú ideig a készüléket hőforrásnak vagy túlzott hőnek.
2. Ne lyukassza ki vagy égesse el.
3. Ne kísérelje meg eltávolítani a felhasználó által nem cserélhető akkumulátort.
4. Ne üzemeltesse az eszközt a javasolt hőmérséklet-tartományon kívül: -4 - 131°F (-20 - 55°C).
5. Huzamosabb ideig az alábbi hőmérséklet-tartományban tárolja: 32 - 77°F (0 - 25°C)
6. Az eszközt és a benne lévő akkumulátort megfelelően kell újrahasznosítani, illetve elhelyezni.

VIGYÁZAT:

A NEM MEGFELELŐ AKKUMULÁTOR HASZNÁLATA ROBBANÁSVESZÉLYES.
AZ ÚTMUTATÁSOKNAK MEGFELELŐEN SZABADULJON MEG A HASZNÁLT AKKUMULÁTORTÓL.

Figyelmeztetés a CE jelzés használatával kapcsolatban

Ez egy B osztályú termék. Lakókörnyezetben a termék rádiófrekvenciás zavart okozhat, amelynek esetében a felhasználó a megfelelő intézkedések megtételére kötelezhető.

Korlátozott jótállás

A Bryton Inc. a vásárlás napjától számított egy évig garanciát vállal azért, hogy a termék mentes mind a gyártási, mind az anyaghibáktól. Ha a termék részegysége a korlátozott garanciális időszakon belül megfelelő használat mellett elromlik, a Bryton Inc. ingyenesen megjavítja, vagy kicseréli a hibás részegységet.

A garancia nem vonatkozik az alábbiakra:

1. A nem rendeltetésszerű használat, baleset, gondatlan használat, tűz, illetve egyéb külső tényezők vagy Vis Maior által okozott meghibásodás
2. A felület fizikai károsodása pl. karcoldás és horpadás
3. This warranty does not apply to consumable parts, such as batteries, heart rate belts, etc. unless failure has occurred due to a defect in materials or workmanship.
4. A Bryton Inc. hivatalos szervizétől eltérő személy által okozott rongálódás.





A jelen Korlátozott Jótállásra a következő feltételek és kikötések érvényesek:

1. Garanciális szolgáltatás igénybe vételéhez a vásárlást bizonyító szelvény, valamint az eredeti kiskereskedőtől származó számla vagy blokk eredeti, illetve másolati példánya szükséges.
2. A Bryton Inc. fenntartja a jogot, hogy saját döntése szerint megjavítsa vagy kicserélje a terméket, illetve hogy visszatérítse a teljes vételárát.
3. A Bryton Inc. nem pótolja az online árverésen vásárolt csomagból esetleg hiányzó részegységeket. A Korlátozott Jótállás igénybe vételéhez az eredeti kiskereskedőtől származó számla vagy blokk eredeti, illetve másolati példánya szükséges.
4. Garanciális szolgáltatás igénybe vételéhez vegye fel a kapcsolatot Bryton Inc. (www.brytonsport.com) céggel a szállítási utasításokért.
5. Ez a Korlátozott Jótállás fedezi a termék vizsgálatának és javításának költségét a Korlátozott Jótállás időtartama során. A hibás terméket a vásárló saját költségén köteles elszállíttatni a megadott rendezetési helyre a vásárlást bizonyító szelvénnyel együtt.
6. A kicserélt hibás termékek és részegységek a Bryton Inc. tulajdonává válnak.
7. A Bryton Inc. által megjavított vagy kicserélt minden részegység garancia alá esik 90 napig, illetve az eredeti egy éves garancia hátralévő időtartamára, amennyiben az hosszabb ideig tart.
8. Készítsen biztonsági mentést az adatokról, és töltse le a bizzalmat, magánjellegű vagy személyes információt a Termékről, mielőtt visszaküldené a készüléket javításra. A Bryton Inc. nem felelős semmilyen adatfájl sérülésért vagy adatvesztésért.
9. A Bryton Inc. termékeit személyes segédeszközként történő használatra szánja, ezért tilos az irány, helyzet, távolság vagy topográfia pontosságot igénylő mérésekre használni, valamint nem garantálja a termékekben lévő térképadatok pontosságát, illetve teljességét.
10. A Bryton Inc. fenntartja a jogot arra, hogy elutasítsa a garanciális szolgáltatás igényét olyan termékek vagy szolgáltatások tekintetében, amelyekhez bármely ország törvényeinek megsértésével jutottak hozzá és/vagy használnak.
11. A nemzetközi vásárlás tekintetében a nemzetközi forgalmazók országtól függően külön garanciát biztosíthatnak. Amennyiben alkalmazható, a garanciát az adott ország helyi forgalmazója adja, és ugyanaz végzi az eszköz helyi szervizét. A forgalmazói garancia kizárólag a hivatalos forgalmazási területen érvényes.

EGYÉB KÁROK KIZÁRÁSA. A TÖRVÉNY ÁLTAL MEGENGEDETT MÉRTÉKIG A BRYTON INC., BESZÁLLÍTÓI, TÁRSULT CÉGEI ÉS ÜGYNÖKEI FELELŐSÉGE KIZÁRT AZ ALÁBBIK TEKINTETÉBEN:

- (i) KÖVETKEZMÉNYES VAGY ESETI KÁROK;
- (ii) BÁRMILYEN KÁR VAGY VESZTESÉG, AMIBŐL PROFITVESZTESÉG, ÜZLETMENET-MEGSZAKÍTÁS, ADATVESZTÉS, BIZALMAS VAGY MÁS INFORMÁCIÓ ELVESZTÉSE, TITKOSÁG ELVESZTÉSE, A HARDVERESZKÖZ VAGY SZOFTVER EGÉSZE VAGY RÉSE HASZNÁLATÁNAK LEHETETLENISÉGE, SZEMÉLYI SÉRÜLÉS, VAGY BÁRMELY KÖTELEZETTSÉG TELJESÍTÉS ELMULASZTÁSÁBÓL (BELEÉRTVE, DE NEM KIZÁRÓLAGOSAN A JÓ HÍRNEVET VAGY ÉSSZERŰ ELŐVIGYÁZATOSSÁGOT) KELEZKEZIK;
- (iii) KÖZVETETT, KÜLÖNLEGES, VAGY BÜNTETŐJOGI KÁROK, AMELYEK BÁRMILYEN MÓDON A HARDVERESZKÖZBŐL VAGY SZOFTVERBŐL EREDNEK VAGY AZOKHOZ KAPCSOLÓDNAK. A FENTIEK AKKOR IS ERVÉNYESEK MARADNÁK, HA A BRYTON INC.-ET, VAGY BÁRMELY BESZÁLLÍTÓJÁT, TÁRSULT CÉGÉT VAGY ÜGYNÖKÉT TÁJÉKOZTATTÁK ILYEN KÁR VAGY VESZTESÉG LEHETŐSÉGÉRŐL, MÉG FELELŐSSÉG MEGÁLLAPÍTÁSA, MAGÁNJOGI VÉTKES CSELEKMÉNY (IDEÉRTVE A HANYAGSÁGOT), A TELJES VAGY TERMÉKFELELŐSÉGET, A HAMIS BEÁLLÍTÁST ÉS EGYÉB VÉTKES CSELEKMÉNYEKET.

Egyes joghatóságok nem engedélyezik a véletlen vagy következményes károk kizárását vagy korlátozását, így a fenti korlátozás vagy kizárás nem feltétlenül vonatkozik Önre.

HU





安全聲明

注意：使用本產品之前，請先閱讀此聲明。

Bryton 產品與其配件非醫療性設備，經由本產品所生成之數據僅供使用者參考。Bryton 不負責任何因數據解讀錯誤所導致的傷害及損失。在開始任何的訓練計畫之前，請先諮詢專業醫生或教練。運動過程中，請勿操作此產品，缺乏適當的注意力有可能引起意外的人身傷害或物品損壞。使用或安裝本產品請遵循當地的相關法律規定。本公司與其產品生產製造商和產品授權商將不承擔任何運動過程當中因操作產品、不當操作、不當安裝、不可抗力、違反交通規則、違反安全規章、或者因軟體，地圖數據損壞所導致之損失。本產品不保證無任何問題，亦無保證任何特定之目的及效果。

電池警告

1. 請勿將產品放置於熱源處或高溫環境。
2. 請勿對產品進行穿透性破壞或燃燒。
3. 本產品所使用的電池是消費者不可自行更換的。
4. 當環境溫度超出於所列範圍，請勿操作產品：-4到131°F (-20到55°C)
5. 產品適當儲存溫度：32到77°F (0到25°C)
6. 請適當的回收處置廢棄產品或電池。

低功率電波輻射電機管理宣告

本Bryton 產品正體中文版，僅遵循中華民國國家通訊傳播委員會所頒佈低功率電波輻射性電機管理辦法規範，並經驗證通過合格，請使用者遵循相關電信法規以避免違反規定受罰。若使用者欲攜帶本機至其它國家應用，也請遵循該地區或國家之相關法令限制。根據交通部低功率電波輻射性電機管理辦法規定：

第十二條

經型式認證合格之低功率射頻電機，非經許可，公司、商號或使用者均不得擅自變更頻率，加大功率或變更原設計之特性及功能。

第十四條

低功率射頻電機之使用不得影響飛航安全及干擾合法通信；經發現有干擾現象時，應立即停用，並改善至無干擾時方得繼續使用。

前項合法通信，依電信法規定作業之無線電通信。

低功率射頻電機須忍受合法通信或工業、科學及醫療用電波輻射性電機設備之干擾。

售後保固範圍

自產品購買日起，Bryton提供一年時間的產品保固。產品保固期間內，在正常使用產品狀況下所發生的零件故障，Bryton將會提供維修或更換產品的服務，並且不予收取費用。



以下狀況不適用於售後保固範圍：

1. 因不當操作、意外事故、濫用產品、火災、外部原因、或天然災害所引起的產品損害。
2. 產品表面損傷。例如：刮痕、凹痕。
3. 消耗性零件。例如：電池、心跳或測器的彈性帶，除非產品故障或損壞是因零件材料或生產瑕疵所引起。
4. 非Bryton所授權的服務供應商所引起的產品損壞。

售後保固適用於以下條件：

1. 為享有完整的售後保固，購買產品時請務必向經銷商索取正本或副本發票。
2. 本公司持有對產品進行維修、替換產品、或是全額退費考慮之決定權。
3. 在網路購物通路所購買到之產品組合，若有零配件遺失本公司將不予負責。為享有本公司的保固服務，請務必持有並保存原始零售商開立之發票正本或副本。
4. 售後保固與產品送修相關訊息，請上Bryton網站查詢。(Brytonsport.com)
5. 產品保固期間內，Bryton將承擔產品檢查及維修所產生的費用。需檢修之產品，請購買者陪同購買證明自行遞交或寄送至指定維修地點。保固日期以購買憑證為主，若無法提供購買憑證，將以產品序號第五到八碼上的年月再加六個月為保固期限。
6. 所有維修時被替換的產品或零件，為Bryton之財產。
7. 經過維修或替換零件的產品仍繼續享有其剩餘的保固期限，或是自送維修日起算，享有90天的保固期限。兩者取其天數較長者為最終期限。
8. 產品送修前請自行備份數據資料並且刪除任何機密、財產或個人私密的訊息。若有數據資料的遺失或毀損，Bryton不予負責。
9. Bryton的產品是屬於消費型電子產品。請勿將產品用於精確的方向測量、位置距離測量，地形採集。本產品不保證其廠商之地圖數據的正確及完整性。
10. 因產品使用或服務是違反任何國家當地的法律時，Bryton公司有權拒絕履行產品售後服務。
11. 因應全球性銷售，經銷商有可能因應當地情況提供另外的售後保固形式。若條件符合，可由當地經銷商提供售後保固。該售後保固聲明僅在該經銷商經銷地區範圍內有效。

不列計的其他損壞。在法律的保障之下，若有下列情事，Bryton Inc. 及其供應商、關係企業及代理商恕不擔負任何責任：

- (i) 間接或意外損壞；
- (ii) 造成收益損失、業務中斷、資料或隱私性或機密性損失、無法使用全部或部分硬體裝置/軟體、人身傷害或無法達成使用目的(包括但不限於任何疏忽、誠信或技術層面的責任)等損壞或任何類型的損失；或
- (iii) 源自於或關聯於軟體或硬體的任何間接、特殊或懲罰性損壞賠償。即使Bryton Inc. 及其供應商、關係企業及代理商已知悉發生該類損失及損壞的可能性；抑或即使有失誤、民事侵權行為(包括疏忽行為)、絕對性的或產品責任、不實陳述或其他原因，前述事項亦均適用。

由於部分地區的司法主管機關不容許排除條款或對意外/間接損壞的限制性，因此，費用戶可能不適用上述的限制性或排除條款。



安全声明

注意：使用本产品之前，请先阅读此声明

Bryton 产品与其配件非医疗性设备，经由本产品所生成之数据仅供使用者参考。Bryton 不会负责任何因数据解读错误所导致的伤害及损失。在开始任何的训练计划之前，请先咨询专业医生或教练。运动过程中，请勿操作此产品，缺乏适当的注意力有可能引起意外的人身伤害或物品损坏。使用或安装本产品请遵循当地的相关法律规定。本公司与其产品生产制造商和产品授权商将不承担任何运动过程当中因操作产品、不当操作、不当安装、不可抗力、违反交通规则、违反安全规章、或者因软件、地图数据损坏所导致之损失。本产品不保证无任何缺陷问题，亦无保证任何特定之目的及效果。

电池警告

1. 请勿将产品放置于热源处或高温环境。
2. 请勿对产品进行穿透性破坏或燃烧。
3. 本产品所使用的电池是用户不可自行更换的。
4. 当环境温度超出于所列范围，请勿操作产品：-4到131°F (-20到55°C)
5. 产品适当储存温度：32到77°F(0到25°C)
6. 请适当的回收处置废弃产品或电池。



售后保固范围

自产品购买日起算，Bryton提供一年时间的产品保固。产品保固期间内，在正常正确使用产品状况下所发生的零件故障，Bryton将会提供维修或更换产品的服务，并且不予收取费用。

以下状况不适用于售后保固范围：

1. 因不当操作、意外事故、滥用产品、火灾、外部原因、或自然灾害所引起的产品损害。
2. 产品表面损伤。例如：刮痕、凹痕。
3. 消耗性零件。例如：电池、心率带子，除非产品故障或损坏是因零件材料或生产瑕疵所引起。
4. 非Bryton所授权的服务供货商所引起的产品损坏。

售后保固适用于以下条件：

1. 为享有完整的售后保固，购买产品时请务必向经销商索取正本或副本发票。
 2. 本公司持有对产品进行维修、替换产品、或是全额退费考虑之决定权。
- 
- 
- 



3. 在网络购物通路所购买到之产品组合，若有零配件遗失本公司将不予负责。为享有本公司的保固服务，请务必持有并保存原始经销商开立之发票正本或副本。
4. 售后保固与产品运送送修相关讯息，请上Bryton网站查询。(www.brytonsport.com)
5. 产品保固期间内，Bryton将承担产品检查及维修所产生的费用。需检修之产品，购买者需连同购买证明自行递交或运送至指定维修地点。
6. 所有维修时被替换的产品或零件，为Bryton之财产。
7. 经过维修或替换零件的产品仍继续享有其剩余的保固期限，或是自送维修日起算，享有90天的保固期限。两者取其天数较长者为最终期限。
8. 产品送修前请自行备份数据数据并且删除任何机密、财产或个人私密的讯息。若有数据数据的遗失或毁损，Bryton不予负责。
9. Bryton的产品是属于消费型电子产品。请勿将产品用于精确的方向测量、位置距离测量、地形采集。本产品不保证其厂商之地图数据的彻底正确及完整性。
10. 因产品使用或服务是违反任何国家在当地的法律时，Bryton公司有权拒绝履行产品售后服务
11. 因应全球性销售，经销商有可能因应当地情况提供另外的售后保固形式。若条件符合，可由当地经销商提供售后保固。该售后保固声明仅在该经销商经销地区范围内有效。

不列计的其它损坏，在法律的保障下，若有下列事情，Bryton Inc.及其供货商、关系企业及代理商恕不承担任何责任：

- (i) 间接或意外损坏；
- (ii) 造成收益损失、业务中断、数据或隐私性或机密性损失、无法使用全部或部分硬件装置/软件、人身伤害或无法达成使用目的（包括但不限于任何疏忽、诚信或技术层面的责任）等损坏或任何类型的损失；或
- (iii) 源自于或关联于软件或硬件的任何间接、特殊或惩罚性损坏赔偿。即使Bryton Inc.及其供货商、关系企业及代理商已知悉发生该类损失及损坏的可能性；亦或即使有失误、民事侵权行为（包括疏忽行为）、绝对性的或产品责任、不实陈述或其它原因，前述事项亦均适用。

由于部分地区的司法主管机关不容许排他条款或对意外/间接损坏的限制性，因此，贵用户可能不适用上述的限制性或排他条款。

SC





安全に関する同意書

Bryton の製品およびアクセサリーは、医療器具ではありません。また、その計測値等は参考用としてお使いいただくためのものです。Bryton は、正確でない読取値が引き起こした結果については保証いたしかねますのでご了承ください。トレーニングプログラムや心拍計の使用を開始されるときはいかなる場合も、お近くの医師にご

相談ください。何らかのアクティビティの最中には、本製品を稼働しないでください。適切な注意を怠ると、怪我、死亡、または重大な損害に至る恐れがあります。本製品を使用する、または取り付けられる際は、該当する地域法や規制に従ってください。

当社と当社の製造者およびライセンサーは、本製品のアクティビティ中の使用、誤った使用、不適切な取付、不可抗力、交通規則若しくは安全規制の違反、または本製品に含まれるソフトウェア若しくはマップデータの使用によって発生した損害について、何ら責任を負わないものとします。本製品は、誤作動や欠陥が無いことを保証するものではなく、定義されたあらゆる目的に適合することを保証するものでもありません。

バッテリーに関するご注意

1. 熱源または高温になる場所に本装置を放置しないでください。
2. 本装置に穴を開けたり、燃やしたりしないでください。
3. ユーザーが自分で交換できる場所以外にある電池は、無理に取り外さないでください。
4. 本装置は、-20~55°C (-4~131°F) の動作温度の範囲外で稼働しないでください。
5. 長期間保管する際は、次の温度範囲内で保管してください。0~25°C (32~77°F)。
6. 装置またはバッテリーは、適切にリサイクルまたは処理してください。

注意

電池交換の際に間違った電池を挿入すると、爆発の危険があります。

使用済電池は、各地域の法令等に従って処分してください。





CE マーキングに関する警告

本製品は、クラス B 機器です。屋内環境で利用する場合、本製品が無線通信に対して電波干渉を引き起こす可能性があります。このような場合、ユーザーは適切な処置を講じる必要があります。

制限付き保証

Bryton Inc. は、お客様が本製品をお買求めになった日から1年間、本製品の部品と労働について瑕疵が無いことを保証します。Bryton Inc. は、この制限付き保証期間において、お客様が通常にご本製品を使用して部品が故障した場合、部品および作業に関する費用をお客様に請求せずにかかる部品を修理、または交換します。

この保証書は、次のような状況に該当するときは適用されません。

1. 誤った使用、事故、濫用、またはその他の外部的な原因若しくは不可抗力
 2. ひっかき傷やへこみなど本製品表面への物理的な損害
 3. 例えば電池またはハートレートベルトといった消耗部品。但し、製品の損害がまたは労働における瑕疵に起因する場合は除く。
 4. Bryton Inc. によって承認されていないサービス プロバイダによる破損。
- 
- 
- 
- 
- 

制限付き保証は、次の条件に従います。

1. 保証サービスを受けるには、購入証明書、本製品をお買求めになった店舗が発行した領収書の原本またはそのコピーが必要です。
2. Bryton Inc.は、本製品を修理する、交換する、またはお買い求め価格を全額お返しの、のいずれかを選択するに当たり、単独の判断によってこれを行うための排他的な権利を保持します。
3. Bryton Inc.は、オンラインオークションによってお買求めになったパッケージについて、不足する部品の補充を行いません。制限付き保証のサービスをご利用いただくには、最初の販売店から取得した領収書の原本またはコピーが必要です。
4. 保証サービスをご利用いただくには、Bryton Inc. (www.brytonsport.com) に連絡して本製品の配送手続きをご確認ください。
5. この制限付き保証は、制限付き保証期間内の本製品の点検および修理に関する費用を対象とします。欠陥のある製品は、ご購入を証明する書類とともに、指定された場所にお客様の費用でお届けいただく必要があります。
6. 交換済みとなった製品と部品はすべて、Bryton Inc.の所有物となります。
7. Bryton Inc.によって修理済みまたは交換済みとなった部品の保証は、当初の1年間の保証期限が終了するまで、または修理または交換をした日から90日間のいずれか長いほうの期間に対し、引き続き保証されます。
8. 本製品のユニットをサービスにお届けになる前に、データをバックアップし、機密、専有、または個人情報製品から取り除いてください。Bryton Inc.は、データの破損や損失について責任を負いませんのでご了承ください。
9. Bryton Inc.の製品は、個人的なサポートを用途としているため、方角、場所、距離または地形学に関する詳細な測定のために使用しないでください。当社は、本製品のマップデータの正確性や完全性について保証いたしません。
10. Bryton Inc.は、いかなる国の法律に違反して取得または利用された製品またはサービスに対して、保証請求を拒否する権利を留保します。
11. 国境を越えた販売については、国によって国際的な販売者によって提供される別の保証書が用意されている場合があります。該当する場合、この保証書は国内の地元販売店により提供され、この販売店がお手持ちの装置のローカル サービスをご提供します。販売店による保証書は、目的の販売地域内でのみ有効です。

その他の損害の例外。法律が許容する最大限の範囲において、BRYTON INC.およびそのサプライヤー、子会社、並びに代理店は次の内容に対する責任を負いません。

- (i) 付随的または偶発的な損害。
- (ii) 利益の損失、事業中断、データ、プライバシー、または機密情報の損失、ハードウェアまたはソフトウェアの全部または一部の利用不能、または責任達成の失敗（職務怠慢、善意または職人努力などを含む）。または
- (iii) ソフトウェアまたはハードウェア デバイスに起因する、若しくは関連する間接的、懲罰的、または特別損害。前述の事項は、BRYTON INC.またはあらゆるサプライヤー、子会社、または代理店が、かかる損失または損害の可能性について予め警告を受けていたか否かにかかわらず、過失、不法行為（過失を含む）、厳格責任、不実表示またはその他の理由による場合であっても適用するものとする。

一部の裁判管轄区は、偶発的または付随的な損害に対する除外規定または制限規定を認めていないため、該当しない場合もあります。



책임 배제

중요: 본 제품을 사용하기 전에 아래 통지문을 읽으십시오.

Bryton 제품 및 액세서리는 의료 기기가 아니며 이에 따른 내용은 참조용입니다. Bryton은 잘못된 내용으로 인한 결과에 대해 책임을 지지 않습니다. 훈련 프로그램 또는 심장 박동 모니터를 시작하기 전에 항상 의사와 상의하십시오. 활동 중에는 제품을 작동하지 마십시오. 작동 시 집중하지 않으면 인체에 해를 입히거나 물리적인 피해 또는 죽음에 이를 수 있습니다. 본 제품을 사용 또는 설치할 때에는 현지 국가의 법 및 규정에 따르십시오. 당사 그리고 본 제품 제조업체 및 라이센스 보유자는 본 제품의 사용, 오용, 부적절한 설치, 불가항력, 교통 법규 또는 안전 규정 위반, 소프트웨어, 또는 그에 따른 지도 데이터 제품으로 인한 손해에 대하여 책임을 지지 않습니다. 본 제품은 무결점, 무오류를 보증하지 않으며 어떠한 정의된 목적에 적합함을 보증하지 않습니다.

배터리 경고

1. 본 제품을 열원 또는 고온 상태에 놓지 마십시오.
2. 구멍을 뚫거나 태우지 마십시오.
3. 사용자가 교체할 수 없는 배터리를 제거하려고 시도하지 마십시오.
4. 작동 온도 범위 밖에서 작동하지 마십시오. -4 ~ 131°F (-20 ~ 55°C).
5. 다음의 온도 범위 내에서 보관하십시오. 32 ~ 77°F (0 ~ 25°C)
6. 배터리는 적절하게 재활용하거나 처분하십시오.

주의

다른 유형의 배터리로 교체할 경우 폭발의 위험이 있습니다.

사용한 배터리는 폐기 규정에 따라 처리하십시오.

CE 표시 경고

본 제품은 클래스 B 제품입니다. 주거 환경에서 전파 간섭을 일으킬 수 있으며, 전파 간섭이 발생하는 경우에는 사용자가 적절한 조치를 취해야 합니다.

한정 보증

Bryton Inc.는 구매일로부터 일년 동안 제품의 하자 또는 기능에 대하여 보증합니다. Bryton Inc.는 본 제품의 정상적인 사용 하에 상기 제한된 기간 동안 소비자에게 부품의 수리 또는 교체 및 기술을 무료로 제공합니다.

다음의 경우에는 보증이 제공되지 않습니다

1. 오용, 사고, 남용, 화재 또는 기타 외부 원인 또는 천재지변으로 인한 파손
2. 스크래치 및 흉과 같은 표면의 물리적인 파손;
3. 본 보증은, 소재 또는 공정상의 결함으로 인한 제품 불량을 제외한, 배터리, 심박계 벨트 등과 같은 소모성 부품에 대해서는 보증하지 않습니다.
4. Bryton Inc.의 승인된 서비스 제공업체가 아닌 사람으로 인한 파손



본 한정 보증은 다음과 같은 조건을 갖추어야 합니다:

1. 보증 서비스를 받으려면 구입처에서 발행한 영수증 원본이 있어야 합니다.
2. **Bryton Inc.**는 제품의 수리 또는 교체에 대한 독점권을 보유하고 있으며 또는 단독 재량으로 구입가격을 환불해 줄 수 있습니다.
3. **Bryton Inc.**는 인터넷 구매로 구입한 제품에 대한 누락된 부품은 보완해 주지 않습니다. 한정 보증으로 서비스를 받으려면 영수증 원본 또는 사본이 있어야 합니다.
4. 보증 서비스를 받으려면 **Bryton Inc. (www.brytonsport.com)**에 연락하여 제품 발송에 대한 안내를 받으십시오.
5. 본 한정 보증은 보증 기간 동안 검사 및 수리 비용을 무상으로 제공합니다. 결함 제품은 발송 비용 소비자 부담으로 구매 영수증과 함께 지정된 장소로 보내야 합니다.
6. 모든 교체된 결함 제품 또는 구성 부품은 **Bryton Inc.**의 자산입니다.
7. **Bryton Inc.**이 수리 또는 교체한 부품은 수리 날짜로부터 **90**일간 또는 남은 보증 기간 동안 중 더 긴 기간을 기준으로 보증이 지속됩니다.
8. 서비스 센터로 보내기 전에 기밀, 소유권 또는 개인 정보를 백업 받은 후 삭제하십시오. **Bryton Inc.**는 데이터 손실 또는 파손에 대하여 책임지지 않습니다.
9. **Bryton Inc.** 제품은 개인 보호 용구로 제작된 것이 아니며 방향, 위치, 거리 또는 지형도로 사용될 수 없으며 제품에 있는 지도의 완벽성 또는 정확성에 대해 보증하지 않습니다.
10. **Bryton Inc.**는 해당 국가의 법에 저촉되는 사용 또는 획득으로 인한 서비스 또는 제품에 대하여 청구된 보증은 거부할 권리가 있습니다.
11. 해외에서 구입한 제품은 국가에 따라 국제 판매 대리점에서 제공하는 별도의 보증이 있을 수 있습니다. 가능한 경우 본 보증은 현지 국가의 판매업자가 제공한 보증이며 판매업자가 현지에서 서비스를 제공합니다. 판매자 보증은 해당 국가에서만 유효합니다.

기타 파손에 대한 배제 범이 허용하는 한도 내에서 **BRYTON INC.**와 공급자, 관련자 및 대리점은 다음에 관하여 책임을 지지 않습니다:

- (i) 결과적 또는 부수적인 손해;
- (ii) 이익 손실, 영업 중단, 데이터 또는 개인 정보 또는 기밀 손실, 장비 하드웨어 또는 소프트웨어의 일부 또는 전부 사용 불능, 개인 상해, 또는 의도 불이행(적무 태만, 성실 또는 기술 노력 포함)과 연관한 어떠한 파손 또는 손해; 또는
- (iii) 소프트웨어 또는 하드웨어 장비의 고장으로 인한 간접, 특별, 또는 심한 파손. 위 사항은 **BRYTON INC.** 또는 제공업체, 관련자 또는 대리점이 그와 같은 손실 또는 손해; 및 과실, 불법 행위(적무 태만 포함), 제품 무과실 책임, 잘못된 설명 또는 기타 이유의 가능성이 종지된 경우라도 적용됩니다.

관할 지역에 따라 부수적 또는 결과적 손해의 제한 또는 배제를 허용하지 않을 수 있으므로 위의 배제 또는 제한 사항이 귀하에게 적용되지 않을 수 있습니다.

KO





Model Number:

Distributor Stamp Here



brytonsport.com



WSI_R004_AUG

