

Click to navigate

2	Welcome
3	Safety
6	Quick reference
9	Getting started
14	Using your IsatPhone 2
35	Location services
41	Phonebook & Contacts
45	Data
46	Personal settings
53	Security
56	Troubleshooting
59	Care and maintenance
61	Regulatory and compliance
64	Disclaimer
65	Accessories
66	Export controls
67	Malware
68	Downloading content
69	Notices
70	Protection of personal information
71	Type and specification
72	Index

IsatPhone²

USER GUIDE



inmarsat.com/isatphone

inmarsat
The mobile satellite company

Click to navigate

2	Welcome
3	Safety
6	Quick reference
9	Getting started
14	Using your IsatPhone 2
35	Location services
41	Phonebook & Contacts
45	Data
46	Personal settings
53	Security
56	Troubleshooting
59	Care and maintenance
61	Regulatory and compliance
64	Disclaimer
65	Accessories
66	Export controls
67	Malware
68	Downloading content
69	Notices
70	Protection of personal information
71	Type and specification
72	Index

Congratulations on buying your IsatPhone 2. The satellite phone that delivers:

- > Dependable connectivity
- > High quality voice
- > Rugged design
- + Assistance button, call alerts and tracking
- + Extended battery capacity

From the world's leading provider
of mobile satellite communications

Please follow this user guide for further information on how to set up,
connect, personalise and use your phone safely. Further information
is available at inmarsat.com/isatphone.

2	Welcome
3	Safety
6	Quick reference
9	Getting started
14	Using your IsatPhone 2
35	Location services
41	Phonebook & Contacts
45	Data
46	Personal settings
53	Security
56	Troubleshooting
59	Care and maintenance
61	Regulatory and compliance
64	Disclaimer
65	Accessories
66	Export controls
67	Malware
68	Downloading content
69	Notices
70	Protection of personal information
71	Type and specification
72	Index

Exposure to radio frequency energy

IsatPhone 2 is a radio transmitter and receiver. When the phone or Bluetooth handsfree is turned on, it emits low levels of radio frequency energy. The phone is designed and manufactured not to exceed the safety limits for exposure to radio frequencies (RF) as recommended by the ICNIRP (International Commission on Non-Ionising Radiation Protection) and as adopted within mandatory standards of the European Commission and the United States of America.

Specific Absorption Rate (SAR) is used to measure radio frequency energy absorbed by the body when using a mobile phone. IsatPhone 2 is compliant with the EC standards for exposure specified in EN 50360:2017 in accordance with EN 62209-1:2016. For use of the phone at the ear, these standards set a SAR limit of 2.0 W/kg averaged over a 10g volume.

IsatPhone 2 is also compliant with the Federal Communications Commission (FCC) standards and test procedures as reflected in the requirements of 47 CFR 2.1093 in accordance with KDB 447498 D01 v06, and of ISED RSS-102 in accordance with Health Canada Safety Code 6. For use of the phone at the ear, these standards set a SAR limit of 1.6 W/kg averaged over a 1g volume.

Tests for SAR are conducted in accordance with international guidelines for testing using standard operating positions as per the procedures for the applicable standards, with the device transmitting at the highest certified power levels in all operational frequency bands.

Note: The SAR requirements for IsatPhone 2 are met for radiating operation whilst handheld at the ear. No measures have been taken for SAR compliance when radiating in a body-mounted position. Hence, radiating operation of the IsatPhone 2 is not recommended when in a body-mounted position.

It should be noted that the IsatPhone 2 is not capable of radiating when the antenna is in the stowed position. Hence, when operating in 'incoming call alerting' mode (see [page 20](#)) with the antenna stowed, (either with or without the handset in the holster), the handset cannot radiate and may be body-mounted without posing a safety/health risk.

Pacemakers

Wireless phones may adversely affect the operation of some implanted cardiac pacemakers and other medically implanted equipment. Pacemaker patients should be aware that the use of an IsatPhone 2 in close proximity to a pacemaker might cause the device to malfunction. If a minimum distance of 15cm is kept between an IsatPhone 2 and a pacemaker, the risk of interference is limited. If you have any reason to suspect interference is occurring, immediately switch off your IsatPhone 2. Contact your cardiologist for more information.

2	Welcome
3	Safety
6	Quick reference
9	Getting started
14	Using your IsatPhone 2
35	Location services
41	Phonebook & Contacts
45	Data
46	Personal settings
53	Security
56	Troubleshooting
59	Care and maintenance
61	Regulatory and compliance
64	Disclaimer
65	Accessories
66	Export controls
67	Malware
68	Downloading content
69	Notices
70	Protection of personal information
71	Type and specification
72	Index

Hearing aids

Although most modern hearing aids are immune to radio frequency interference from satellite terminals, some wireless devices may interfere with some hearing aids. In the event of such interference from the use of the IsatPhone 2, maintain additional separation between you and your IsatPhone 2 and/or consult with your doctor or audiologist.

Other medical devices

Although most modern electronic medical equipment in hospitals and other clinical environments is shielded from RF energy, there is still a risk that a wireless device could cause interference. As such, never use your IsatPhone 2 near electronic medical equipment without first requesting permission.

Blasting areas and potentially explosive environments

As with any wireless phone, do not use your IsatPhone 2 where blasting work is in progress. Observe all restrictions and follow any regulations or rules. Do not use your IsatPhone 2 in areas with a potentially explosive atmosphere. Note that such areas are often, but not always, clearly marked.

Battery safety

Use only Inmarsat-supplied or approved batteries, and recharge your battery with Inmarsat-supplied or approved chargers for the phone. Use of batteries that are not Inmarsat-supplied or approved may pose increased safety risks.

Do not dispose of batteries in a fire, as they may explode. See Care and maintenance on [page 59](#), and for guidance on the disposal of batteries and electronic equipment, see [page 63](#).

Batteries may burn or explode if damaged. Do not dismantle, open, bend or cut cells or batteries. Do not attempt to modify or remanufacture the battery. Do not immerse or expose the battery to water or other liquids.

In the event of a battery leak, avoid contact of contents with skin or eyes. If this does happen, flush the affected areas with water and seek medical help as appropriate.

Children

Keep out of the reach of children. Do not allow children to play with your phone or accessories. They could hurt themselves or others. Products may contain small parts that could become detached and create a choking hazard.

2	Welcome
3	Safety
6	Quick reference
9	Getting started
14	Using your IsatPhone 2
35	Location services
41	Phonebook & Contacts
45	Data
46	Personal settings
53	Security
56	Troubleshooting
59	Care and maintenance
61	Regulatory and compliance
64	Disclaimer
65	Accessories
66	Export controls
67	Malware
68	Downloading content
69	Notices
70	Protection of personal information
71	Type and specification
72	Index

Driving

Only use IsatPhone 2 in a vehicle using an Inmarsat-approved vehicular docking unit. Check with the vehicle manufacturer to be sure that your phone or Bluetooth will not affect the electronic systems in the vehicle.

Full attention should be given to driving at all times and local laws and regulations restricting the use of electronic and wireless devices while driving must be observed.

Loudness warning

Avoid volume levels that may be harmful to your hearing.

Pinch hazard

Take care when opening and closing the antenna of your phone, as it may be possible to trap a fingertip.

Land use only

The IsatPhone 2 is approved for land use only.

























Click to navigate

- 2 Welcome**
- 3 Safety**
- 6 Quick reference**
 - 6 Your IsatPhone**
 - 6 Status icons**
 - 7 Menu
 - 8 Coverage map
- 9 Getting started**
- 14 Using your IsatPhone 2**
- 35 Location services**
- 41 Phonebook & Contacts**
- 45 Data**
- 46 Personal settings**
- 53 Security**
- 56 Troubleshooting**
- 59 Care and maintenance**
- 61 Regulatory and compliance**
- 64 Disclaimer**
- 65 Accessories**
- 66 Export controls**
- 67 Malware**
- 68 Downloading content**
- 69 Notices**
- 70 Protection of personal information**
- 71 Type and specification**
- 72 Index**

Your IsatPhone











Status icons

 Keypad locked	 GPS fix required
 Alarm set	 USB connection
 Call divert on	 Conference call activated
 Unread message	 Closed user group number
 Message sent	 New voicemail
 Microphone muted	 Missed call
 Loud profile active	 Loudspeaker activated
 Vibrate profile active	 Silent profile active
 Phone memory full	 Message memory full
 Bluetooth is paired	 SIM card memory full
 Bluetooth headset connected to your phone	 Bluetooth on
 Wired handsfree headset connected	 Assistance button activated

Click to navigate

2	Welcome
3	Safety
6	Quick reference
6	Your IsatPhone
6	Status icons
7	Menu
8	Coverage map
9	Getting started
14	Using your IsatPhone 2
35	Location services
41	Phonebook & Contacts
45	Data
46	Personal settings
53	Security
56	Troubleshooting
59	Care and maintenance
61	Regulatory and compliance
64	Disclaimer
65	Accessories
66	Export controls
67	Malware
68	Downloading content
69	Notices
70	Protection of personal information
71	Type and specification
72	Index

Menu

MESSAGING 	CONTACTS 	CALL LOG 
New message Inbox Outbox Drafts Sent Saved Templates SIM messages	Phonebook SIM contacts FND list My phone number Service provider Emergency numbers Voicemail number Groups	Missed calls Received calls Dialled calls Call duration
PROFILES 	LOCATION SERVICES 	ALARM 
General Silent Loud Vibrate only	Assistance button Tracking Send GPS Personal alert	Once alarm Recurrent alarm
SETTINGS 	GPS POSITION 	NETWORK 
Call settings Security Language Display Prepay Bluetooth	Date and time Docking mode About Reset settings	Satellite search Advanced options Network operator

User Guide instructions commence from the main screen.

The red key  will take you to the main screen.

Click to navigate

2	Welcome
3	Safety
6	Quick reference
6	Your IsatPhone
6	Status icons
7	Menu
8	Coverage map
9	Getting started
14	Using your IsatPhone 2
35	Location services
41	Phonebook & Contacts
45	Data
46	Personal settings
53	Security
56	Troubleshooting
59	Care and maintenance
61	Regulatory and compliance
64	Disclaimer
65	Accessories
66	Export controls
67	Malware
68	Downloading content
69	Notices
70	Protection of personal information
71	Type and specification
72	Index

Coverage map

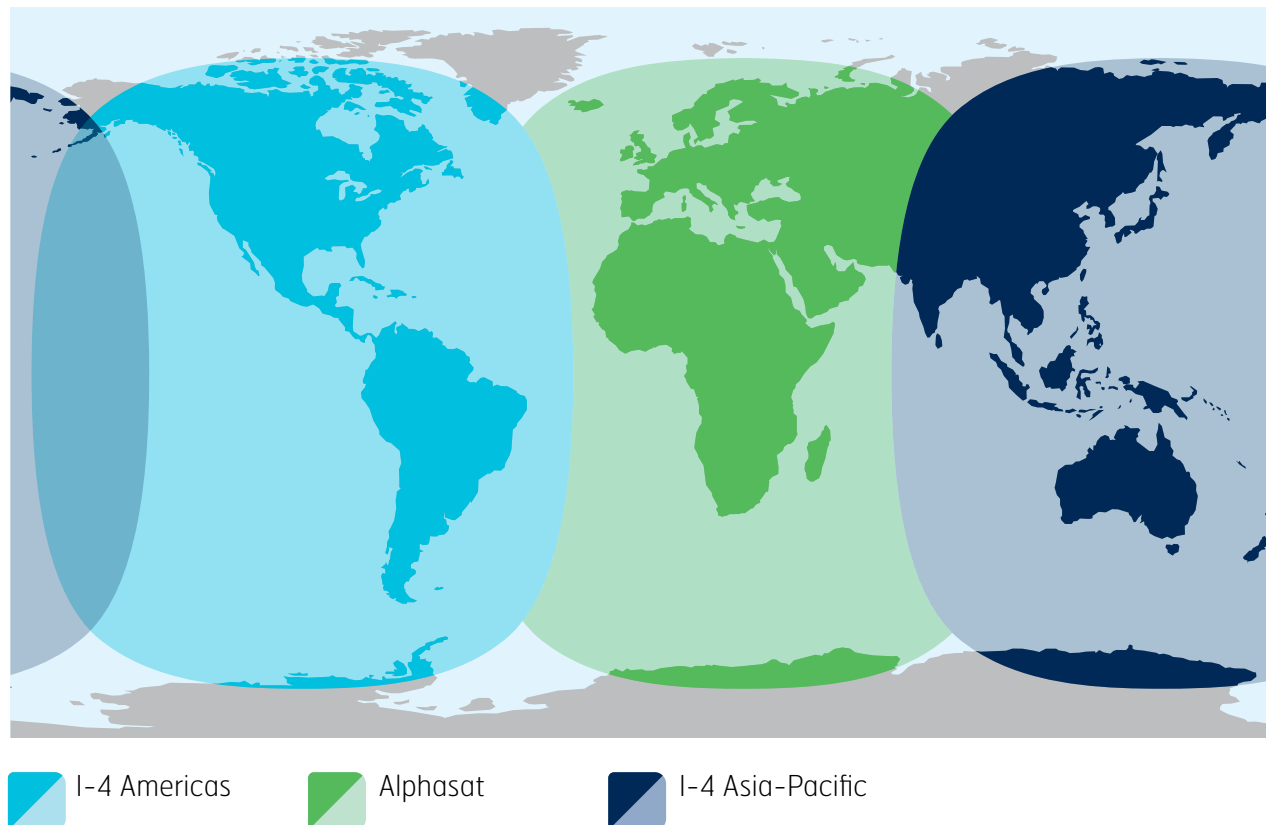

IsatPhone 2 operates globally over the Inmarsat-4 satellites and Alphasat.

This map is illustrative of IsatPhone 2 coverage. It does not provide a guarantee of the extent of service availability. From November 2013, Alphasat coverage prioritises the region north of 44°S, and service may degrade south of this latitude.

This coverage map applies to both IsatPhone Pro and IsatPhone 2.

2	Welcome
3	Safety
6	Quick reference
9	Getting started
9	Package contents
9	Setting up your IsatPhone
12	Attaching the wrist strap
12	Switching your phone on and off
12	Setting the phone language and time zone
12	Using info
12	Accessing important information about your phone
13	Upgrading your phone
14	Using your IsatPhone 2
35	Location services
41	Phonebook & Contacts
45	Data
46	Personal settings
53	Security
56	Troubleshooting
59	Care and maintenance
61	Regulatory and compliance
64	Disclaimer
65	Accessories
66	Export controls
67	Malware
68	Downloading content
69	Notices
70	Protection of personal information
71	Type and specification
72	Index

Package contents

Your IsatPhone 2 box contains:

- Phone
- Battery
- USB drive
- Quick Start Guide
- Warranty
- Mains charger and four universal plug adaptors
- Car charger
- Micro USB cable
- Wired handsfree headset
- Wrist strap
- Holster

The USB drive can be accessed by a PC running Windows 10, 8, 7 or XP and contains the following documents:

- Quick Start Guide
- User Guide
- Warranty

The USB drive also contains the following applications and related “How to” guides:

- USB Drivers: for charging your phone via a PC, setting up a software modem and for running Contact Synchronisation and Firmware Upgrade tools
- Contact Synchronisation Tool: for synchronising your phone with Microsoft Outlook and Microsoft Outlook Express contacts
- Firmware Upgrade Tool: for undertaking future upgrades

The above documents and applications are available in English, Spanish, French, Japanese, Portuguese, Russian, Chinese and Arabic. They can also be downloaded from inmarsat.com/isatphone

Setting up your IsatPhone

Subscriptions and SIM cards

To use your phone, you will need a SIM card and a subscription. The services available to you may depend on your choice of subscription. Contact your service provider for details.

2	Welcome
3	Safety
6	Quick reference
9	Getting started
9	Package contents
9	Setting up your IsatPhone
12	Attaching the wrist strap
12	Switching your phone on and off
12	Setting the phone language and time zone
12	Using info
12	Accessing important information about your phone
13	Upgrading your phone
14	Using your IsatPhone 2
35	Location services
41	Phonebook & Contacts
45	Data
46	Personal settings
53	Security
56	Troubleshooting
59	Care and maintenance
61	Regulatory and compliance
64	Disclaimer
65	Accessories
66	Export controls
67	Malware
68	Downloading content
69	Notices
70	Protection of personal information
71	Type and specification
72	Index

Inserting and removing the battery

Your phone is supplied with a rechargeable battery, which may not be fully charged when you take it out of the box.

⚠ Always switch the device off and disconnect the charger before removing the battery. See Care and maintenance on [page 59](#) for more information.

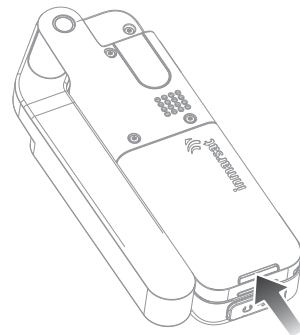

1 Remove the battery by pressing the catch and lifting the battery up and out of the phone

2 Insert the battery by pressing the battery forward and down. It will click into place

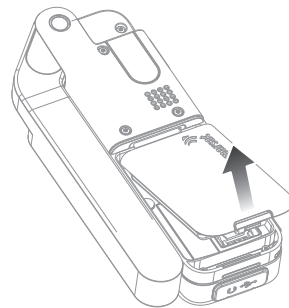

Inserting the SIM card

Your service provider may have inserted your SIM for you. If not, your phone will prompt you to **Insert SIM** and offer only a limited service until you do so.

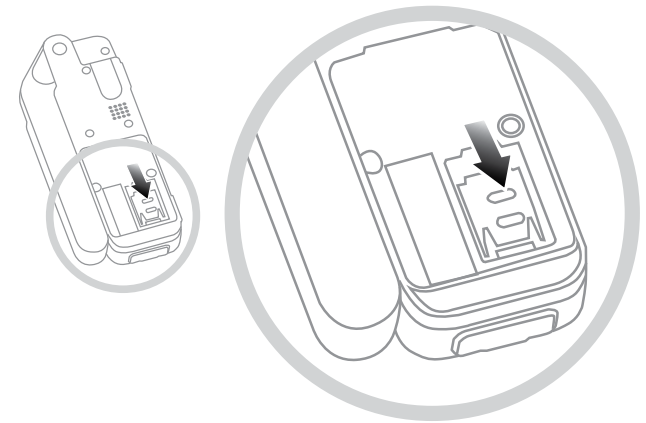

- 1 If the battery is in place, lift it out
- 2 Slide the catch down on the SIM holder and flip it outwards
- 3 Make sure the angled corner of your SIM card is on your left and slide it into the holder
- 4 Flip the holder back into place and slide the catch back up
- 5 Insert the battery

2	Welcome
3	Safety
6	Quick reference
9	Getting started
9	Package contents
9	Setting up your IsatPhone
12	Attaching the wrist strap
12	Switching your phone on and off
12	Setting the phone language and time zone
12	Using info
12	Accessing important information about your phone
13	Upgrading your phone
14	Using your IsatPhone 2
35	Location services
41	Phonebook & Contacts
45	Data
46	Personal settings
53	Security
56	Troubleshooting
59	Care and maintenance
61	Regulatory and compliance
64	Disclaimer
65	Accessories
66	Export controls
67	Malware
68	Downloading content
69	Notices
70	Protection of personal information
71	Type and specification
72	Index

Charging the phone battery

Your phone is powered by a rechargeable lithium-ion battery. To maximise its life and its charging capacity, the first time you charge the battery, charge it overnight. Use only Inmarsat-supplied or approved batteries, and recharge your battery with Inmarsat-supplied or approved chargers for the phone. Do not leave the battery charging for extended periods of time.

The battery can be charged by:

- Using the AC charger (connecting to a wall socket)
- Using the micro USB cable (connecting to a PC)
- Using the car charger (connecting to a vehicle cigarette lighter/power outlet)
- Using the docking station

You also have the option of using a solar charger. Contact your service provider for details.

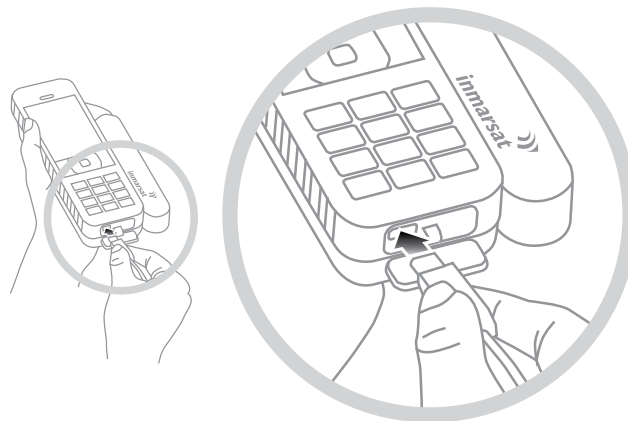

Connect the charger to a power source and the micro USB connector to the port at the base of the phone, under the USB/audio protective cover.

When the battery needs charging, the low battery alert sounds and a **Battery low** message is displayed. The phone will automatically switch off shortly afterwards. You might be able to switch the phone on again, but you cannot make or receive any calls until the battery has been recharged or replaced.

Use the **Docking Mode** option, on the **Settings** menu, to control battery recharging.

The default setting is **Off (full charge)** – this will continually charge your battery to 100% until your phone is removed from the charger or docking station.

Select **On (limited charge)** to select a level at which recharging will be triggered.

The **Frequent docking** option will start charging your battery when the charge drops to 80%

The **Permanent docking** option will start charging your battery when the charge drops to 20%



Note: If your phone is connected to a charger or docking station for long periods of time, you can use the docking mode settings to ensure that your phone only charges when necessary. This will prolong your battery life and conserve power.

2	Welcome
3	Safety
6	Quick reference
9	Getting started
9	Package contents
9	Setting up your IsatPhone
12	Attaching the wrist strap
12	Switching your phone on and off
12	Setting the phone language and time zone
12	Using info
12	Accessing important information about your phone
13	Upgrading your phone
14	Using your IsatPhone 2
35	Location services
41	Phonebook & Contacts
45	Data
46	Personal settings
53	Security
56	Troubleshooting
59	Care and maintenance
61	Regulatory and compliance
64	Disclaimer
65	Accessories
66	Export controls
67	Malware
68	Downloading content
69	Notices
70	Protection of personal information
71	Type and specification
72	Index

Attaching the wrist strap

Your phone is supplied with a wrist strap. To connect the strap, remove the battery cover. Thread the small loop through the entry point at the base of the phone. Loop it over the anchor point to secure it and replace the battery cover.

Switching your phone on and off

To switch on, hold down the red key  for a few seconds until the screen lights up. The Inmarsat logo will appear followed by the main screen. To switch off, press and hold the red key  for a few seconds.

Note: If you see the message **Insert SIM**, you must insert a SIM card to use your phone. You will also be prompted to enter the PIN code if one is set. The default setting for the PIN code is off. See Setting up SIM PIN code on [page 55](#) for more information. Until a SIM card is inserted, only a limited service is available. See Making an emergency call on [page 19](#) for more information.

Setting the phone language and time zone

The first time you turn on your phone, you will be prompted to select your language. This will be the display language. Select your language from a list using the navigation keys and the centre selection key. See Setting phone language on [page 46](#) for more information.

After you have selected your language, you will be prompted to select your time zone. Your phone automatically receives universal time (UTC) from GPS satellites. By selecting the time zone, the phone's clock will display your local time. If you move into another time zone, you will need to change this setting. See Setting the time and Setting the time zone on [page 49](#) for more information.

Using info

Important information about the status of your phone is displayed in the information shortcut **Info** on the main screen. These include missed calls, new messages, voicemails, today's organiser appointments, active profile status, your phone number and your service provider's number. **Info** will pop up on the main screen if you have missed a call or have new messages or voicemails waiting. To access **Info** at other times, press the centre selection key. When **Info** is open, use the navigation keys to highlight the information you wish to access and press the centre selection key to open.

Accessing important information about your phone

Important information about your phone is displayed under **Menu > Settings > About**. These include your model, firmware version, IMEI number and IMSI number. You may need to supply this information when contacting your service provider.

Click to navigate

2	Welcome
3	Safety
6	Quick reference
9	Getting started
9	Package contents
9	Setting up your IsatPhone
12	Attaching the wrist strap
12	Switching your phone on and off
12	Setting the phone language and time zone
12	Using info
12	Accessing important information about your phone
13	Upgrading your phone
14	Using your IsatPhone 2
35	Location services
41	Phonebook & Contacts
45	Data
46	Personal settings
53	Security
56	Troubleshooting
59	Care and maintenance
61	Regulatory and compliance
64	Disclaimer
65	Accessories
66	Export controls
67	Malware
68	Downloading content
69	Notices
70	Protection of personal information
71	Type and specification
72	Index

Upgrading your phone

From time to time it may be necessary to upgrade your phone's software in order to improve its functionality and operation. Inmarsat or your service provider will contact you if your phone needs upgrading. Run the USB drive supplied with your phone to download the Firmware Upgrade Tool. The guide "How to Upgrade your IsatPhone" is available on the USB drive, and can also be downloaded from inmarsat.com/support/isatphone-2-support/

2	Welcome
3	Safety
6	Quick reference
9	Getting started
14	Using your IsatPhone 2
14	Connecting to the satellite
15	Using the eCompass function
15	Obtaining a GPS fix
16	Making and Receiving calls
20	Incoming call alerting
21	Calling handsfree
22	Using voicemail
22	Additional call features
24	Advanced call features
27	Messaging
34	Prepay services
35	Location services
41	Phonebook & Contacts
45	Data
46	Personal settings
53	Security
56	Troubleshooting
59	Care and maintenance
61	Regulatory and compliance
64	Disclaimer
65	Accessories
66	Export controls
67	Malware
68	Downloading content
69	Notices
70	Protection of personal information
71	Type and specification
72	Index

Your IsatPhone makes and receives calls by communicating with Inmarsat satellites in orbit above the equator. Your phone antenna must be deployed and there must be a clear line of sight to an Inmarsat satellite for you to make and receive calls.

Connecting to the satellite

Switch your phone on, hold down the red key  for a few seconds until the screen lights up. The Inmarsat logo will appear followed by the main screen.

If prompted to enter a PIN, enter the PIN code. The PIN is originally set by your service provider which you can reset. See Setting up SIM PIN code on [page 55](#) for more information.



Stand outside with a clear view of the sky with the phone antenna pointing upwards. There must be a clear line of sight between the phone's antenna and the satellite.

The more sky you can see the stronger the signal should be from the satellite. If open sky makes up about 70% of your view when you look up, then the signal should be strong.

Searching satellite will appear on the screen. When your phone is connected to the satellite, the screen will display **Ready for service**. The top left of the screen will display **Inmarsat**.

The signal bars indicate the signal strength. At least two signal bars are required to make and receive calls.

2 Welcome**3 Safety****6 Quick reference****9 Getting started****14 Using your IsatPhone 2**

14 Connecting to the satellite

15 Using the eCompass function**15 Obtaining a GPS fix**

16 Making and Receiving calls

20 Incoming call alerting

21 Calling handsfree

22 Using voicemail

22 Additional call features

24 Advanced call features

27 Messaging

34 Prepay services

35 Location services**41 Phonebook & Contacts****45 Data****46 Personal settings****53 Security****56 Troubleshooting****59 Care and maintenance****61 Regulatory and compliance****64 Disclaimer****65 Accessories****66 Export controls****67 Malware****68 Downloading content****69 Notices****70 Protection of personal information****71 Type and specification****72 Index**

Using the eCompass function

In order to connect to the network, the handset needs to acquire a GPS fix. This happens automatically. If you are unable to obtain a GPS fix, or your fix is out of date, your search will fail and a red circular icon will be displayed in the status bar on screen. The handset will display information to assist you in acquiring a GPS fix. To maximise your chances of obtaining a GPS fix as quickly as possible, stand outside with a clear view of the sky.



Finding a satellite

If the handset is unable to register to the network, or if the received signal strength falls during a call, the eCompass function is automatically displayed on-screen. It helps by showing the direction towards the best Inmarsat satellite. In response, you must point the antenna until the on-screen satellite image turns green. You need to ensure that, in the direction indicated, there is clear line of sight to the sky and no obstructions. The **eCompass** is never displayed while the handset is correctly connected to the network. When it appears, turn towards the satellite in the direction indicated. The on-screen satellite image changes to green to show that you are pointing the handset in the correct direction. Then press **Search**.

Improving signal strength

If the received signal strength falls during a call, as shown by the signal strength indicator, ensure that the antenna is pointed towards the satellite and there are no obstacles between you and the sky. The eCompass is displayed to indicate the direction in which the antenna should be maintained. When you return the handset to your ear, ensure that you keep it pointed in the direction of the satellite.





Obtaining a GPS fix

Before you can make a call, your phone needs a GPS fix so it can be located by the satellite. This happens automatically but if a new GPS fix is needed, the GPS fix  icon will be displayed. Keep the phone in the open with a clear view of the sky until the  icon disappears. Your phone is now ready to make and receive calls. See Obtaining a GPS fix manually on [page 39](#) for more information.







- 2 Welcome
- 3 Safety
- 6 Quick reference
- 9 Getting started
- 14 Using your IsatPhone 2
 - 14 Connecting to the satellite
 - 15 Using the eCompass function
 - 15 Obtaining a GPS fix
- 16 Making and Receiving calls
 - 20 Incoming call alerting
 - 21 Calling handsfree
 - 22 Using voicemail
 - 22 Additional call features
 - 24 Advanced call features
 - 27 Messaging
 - 34 Prepay services
- 35 Location services
- 41 Phonebook & Contacts
- 45 Data
- 46 Personal settings
- 53 Security
- 56 Troubleshooting
- 59 Care and maintenance
- 61 Regulatory and compliance
- 64 Disclaimer
- 65 Accessories
- 66 Export controls
- 67 Malware
- 68 Downloading content
- 69 Notices
- 70 Protection of personal information
- 71 Type and specification
- 72 Index

Making and Receiving calls

- 1 Switch on your phone by holding down the red key  for several seconds.
- 2 Stand outside with a clear view of the sky and the antenna pointing upwards.
- 3 Check your phone is connected to the satellite network - **Inmarsat** is displayed at the top left of the screen.
- 4 Ensure you have at least two bars of signal strength.
- 5 Ensure there is sufficient battery power.
- 6 Ensure that your phone has a GPS fix – the GPS fix required  icon is not displayed.
- 7 Dial the full international number and press the green key, eg. +44 1621 123456 .
- 8 To end a call, press the red key .
- 9 Switch off your phone by holding down the red key  until the screen shuts down.

Making a call



Enter the full international number by dialling either + (hold down the **0** key for 3 seconds) or **00**, country code, area code (without the leading 0), telephone number and press the green key , eg. **00 44 1621 123456**  or **+ 44 1621 123456** . A **Calling** message and the name of the person being called (if listed in your Phonebook or SIM contacts) will display on the screen. When the call is answered, the screen will show the call time in minutes and seconds. To end the call press the red key .

Making a call from saved contacts

Select **Menu > Contacts > Phonebook**. Scroll to the desired name using the navigation keys, or enter the first letter of the name in the search field. The matching contacts will be listed. Highlight the name and press the green key . See Phonebook and Contacts on [page 41](#) for more information.

2	Welcome
3	Safety
6	Quick reference
9	Getting started
14	Using your IsatPhone 2
14	Connecting to the satellite
15	Using the eCompass function
15	Obtaining a GPS fix
16	Making and Receiving calls
20	Incoming call alerting
21	Calling handsfree
22	Using voicemail
22	Additional call features
24	Advanced call features
27	Messaging
34	Prepay services
35	Location services
41	Phonebook & Contacts
45	Data
46	Personal settings
53	Security
56	Troubleshooting
59	Care and maintenance
61	Regulatory and compliance
64	Disclaimer
65	Accessories
66	Export controls
67	Malware
68	Downloading content
69	Notices
70	Protection of personal information
71	Type and specification
72	Index

Re-dialling a number



Press the green key , select from the list of previously dialled numbers using the navigation keys and press the green key  to start the call. Your phone stores 30 dialled numbers. Alternatively, select **Menu > Call log > Dialled calls**, select the person you wish to call and press the green key .

Re-dialling automatically

To switch **Auto re-dial** on or off, select **Menu > Settings > Call settings > Auto re-dial** and make your selection. The default setting is off.

When activated, if your call did not complete, your phone displays **Retry?** and the reason why the connection was unsuccessful. Press **Select** to automatically re-dial the number three times until the call is answered. If you press any key or receive a call during this time, re-dialling is interrupted. If the re-dial is successful the phone beeps, then rings. Select **Close** if you do not want to retry.

Receiving a call

To receive a call, your antenna must be deployed and your phone connected to the satellite. Press the green key  to accept the call or press the red key  to reject it. You will see **Call from** followed by either the name of the caller (if listed in your Phonebook or SIM contacts), the calling number, or **Number unknown**.

If you do not wish your phone to play a ringtone, set your active profile to silent or vibrate only. See Sounds, ringtones and profiles on **page 46** for more information. To mute the ringing tone when a call comes in, press **Silence**.

Declining a call

Press the red key . The call is disconnected and the caller details are stored in **Missed calls** for later retrieval.

Returning a call

Your phone automatically stores the numbers of the last 20 phone calls you have answered or missed. To return a call, select **Menu > Call log**. Select the appropriate folder, eg. **Missed calls** or **Received calls**, highlight the contact and press the green key .

Making a call while on another call

You can put your current call on hold and make a second call at any time. Select the contact by selecting **Options > Contacts > Phonebook** or by dialling the full international number. When you press the green key , your current call will automatically be put on hold. By selecting **Swap** you can switch between calls at any time. You can end either call at any time by selecting **Options > End held call** or **End active call**.

2	Welcome
3	Safety
6	Quick reference
9	Getting started
14	Using your IsatPhone 2
14	Connecting to the satellite
15	Using the eCompass function
15	Obtaining a GPS fix
16	Making and Receiving calls
20	Incoming call alerting
21	Calling handsfree
22	Using voicemail
22	Additional call features
24	Advanced call features
27	Messaging
34	Prepay services
35	Location services
41	Phonebook & Contacts
45	Data
46	Personal settings
53	Security
56	Troubleshooting
59	Care and maintenance
61	Regulatory and compliance
64	Disclaimer
65	Accessories
66	Export controls
67	Malware
68	Downloading content
69	Notices
70	Protection of personal information
71	Type and specification
72	Index

Receiving a second call while on a call

The incoming call will be diverted to your voicemail unless you have set up **Call waiting**. See Setting up call waiting on [page 24](#) for more information.

Using call waiting

When **Call waiting** is activated, a pop-up and an audible alert will notify you if another caller is calling you when you are on another call. When you receive this alert you can press the green key  to accept the second call. The first call is placed on hold automatically while the second call is taken. By selecting **Options > Swap** you can switch between calls at any time.

You can end either call at anytime by selecting **Options > End held call** or **End active call**.



If you receive a third call while you have one active and one held call, the name or number of the caller will be displayed. Ending either the active or the held call will automatically answer the new call.

If you wish to disconnect the first call to accept the second, select **Options > End active call**.

If you do not wish to accept the second call, press the red key . The call is disconnected and the caller details are stored in **Missed calls** and **Info** for later retrieval. If you do nothing, the second caller will be diverted to your voicemail. If voicemail has not been activated, then the call will appear as a missed call. See Setting up call waiting on [page 24](#) for more information.

2	Welcome
3	Safety
6	Quick reference
9	Getting started
14	Using your IsatPhone 2
14	Connecting to the satellite
15	Using the eCompass function
15	Obtaining a GPS fix
16	Making and Receiving calls
20	Incoming call alerting
21	Calling handsfree
22	Using voicemail
22	Additional call features
24	Advanced call features
27	Messaging
34	Prepay services
35	Location services
41	Phonebook & Contacts
45	Data
46	Personal settings
53	Security
56	Troubleshooting
59	Care and maintenance
61	Regulatory and compliance
64	Disclaimer
65	Accessories
66	Export controls
67	Malware
68	Downloading content
69	Notices
70	Protection of personal information
71	Type and specification
72	Index

Making conference calls

Your phone can host conference calls with up to five participants. To initiate a conference call, call the first participant. When the first participant is connected, call the second participant by selecting **Options > Contacts > Phonebook**, select the second participant's name and press the green key . When the second participant is connected, select **Options > Conference**. You are now in a three-way conference call. Repeat for more participants. To end a conference call, select **End** or press the red key .

To answer a new inbound call, press the green key  or select **Options > Answer**. The conference call will be placed on hold. To place all participants into one call, select **Options > Conference**.

To place an inbound call into conference without answering it first, select **Options > Add waiting to conference**.

To disconnect individual conference callers, select **Options > Disconnect caller** and press **Select**, or the centre selection key. A list of the participants is displayed. Select by highlighting their name or number and press **Select**, or the centre selection key, to disconnect them from the call.

To speak privately to one participant during a conference call, select **Options > Private with a caller** and select from the list. To resume the call with all participants, select **Options > Conference**.

To put individual participants of a conference call on hold, select **Options > Hold conference party** and choose from the list of current callers displayed.

Making an emergency call

Wireless phones, including IsatPhone 2, operate using radio signals, wireless networks, landline networks, and user-programmed functions. Because of this, connections in all conditions cannot be guaranteed. You should never rely solely on any wireless device for essential communications like medical emergencies. Emergency calling requirements for satellite phones vary from country to country. Always check your emergency contact numbers and ensure they are stored on your phone before travelling. Please contact your service provider for specific country information.

To make an emergency call in the US, dial 911 or 112 and in Australia dial 000 or 112. Your call will be put through to a call centre which will connect you to the appropriate emergency service. Alternatively, select **Menu > Contacts > Emergency numbers**. An emergency call is free of charge. Prepay users do not need a positive balance to make an emergency call. Dialling 911 or 112 overrides all security locks and bars on your phone.

For details on emergency calling in the rest of the world, please contact your service provider.

2	Welcome
3	Safety
6	Quick reference
9	Getting started
14	Using your IsatPhone 2
14	Connecting to the satellite
15	Using the eCompass function
15	Obtaining a GPS fix
16	Making and Receiving calls
20	Incoming call alerting
21	Calling handsfree
22	Using voicemail
22	Additional call features
24	Advanced call features
27	Messaging
34	Prepay services
35	Location services
41	Phonebook & Contacts
45	Data
46	Personal settings
53	Security
56	Troubleshooting
59	Care and maintenance
61	Regulatory and compliance
64	Disclaimer
65	Accessories
66	Export controls
67	Malware
68	Downloading content
69	Notices
70	Protection of personal information
71	Type and specification
72	Index

Incoming call alerting

To make or receive calls and messages with any satellite handset, you must maintain a clear line of sight between the antenna of your handset and the satellite. The **Incoming call alerting** feature notifies you of calls and text messages when satellite signal reception is limited and/or when the antenna is not deployed. Access to the service is still affected by the location of the handset, and is not available when out of the line of sight of the satellite. See Connecting to the satellite on [page 14](#) for normal operation.

Using Incoming call alerting

Before using Incoming call alerting, each time you switch on the handset it must be successfully registered to the network. To do this, deploy the antenna in a location that has a clear line of sight to the satellite. When the handset is registered, the screen displays **Ready for service** and the two status LEDs change to green. See Connecting to the satellite on [page 14](#). You can now stow the antenna and place the handset in the holster provided or in another convenient location. Unless Incoming call alerting is disabled, the screen displays **Ready for service, Incoming call alerts only** and the status LEDs change to amber to indicate that the available signal strength is sufficient to notify you of incoming calls or messages.

If the received signal strength is too low, the status LEDs turn red and the screen displays the instruction **Point antenna towards satellite**. Move to a location with a clear line of sight to the satellite and the two status LEDs will change to amber. The handset will continue to search for the network until you reach a position where the signal strength is sufficient to receive incoming call alerts.

Receiving an Incoming call alert

When you receive an incoming call alert, you must action in order to obtain full connectivity to the network. This means that you must deploy the antenna if it is stowed, and move to a location with a clear line of sight to the satellite. On receiving an incoming call alert, the status LEDs flash amber and the alert tone sounds. See Sounds, ringtones and profiles on [page 46](#). The screen displays **Incoming call** and **Time remaining 15s**. The time counts down until you successfully connect to the network. Throughout this period, the incoming call can be rejected by pressing the red key.

Missed Incoming call alerts

If you reject an incoming call alert or do not successfully connect to the network within 15 seconds, the alert is terminated. The screen then informs you of a missed alert. You must connect to the network to receive more information about the missed call, voicemail or text. See Returning a call on [page 17](#). Missed calls are forwarded to your voicemail if configured to do so. See Using voicemail on [page 22](#).

2	Welcome
3	Safety
6	Quick reference
9	Getting started
14	Using your IsatPhone 2
14	Connecting to the satellite
15	Using the eCompass function
15	Obtaining a GPS fix
16	Making and Receiving calls
20	Incoming call alerting
21	Calling handsfree
22	Using voicemail
22	Additional call features
24	Advanced call features
27	Messaging
34	Prepay services
35	Location services
41	Phonebook & Contacts
45	Data
46	Personal settings
53	Security
56	Troubleshooting
59	Care and maintenance
61	Regulatory and compliance
64	Disclaimer
65	Accessories
66	Export controls
67	Malware
68	Downloading content
69	Notices
70	Protection of personal information
71	Type and specification
72	Index

Configuring the Incoming call alerting feature

By default, Incoming call alerting is set to On. To switch this feature off, go to the main menu and choose **Settings > Call settings > Incoming call alerting**. Set the status to **Off** and press **Select**. To switch the feature on again, at the main menu choose **Settings > Call settings > Incoming call alerting**, set the status to **On** and press **Select**.

By default, Incoming call alerting is set to provide notification of voice calls only, but you can configure the handset to notify you of text messages as well. Go to the main menu and choose **Settings > Call settings > Incoming call alerting**, then choose **Configure alerts**. The screen displays the options **Alert for calls only** and **Alert for calls & messages**. For notification of calls and messages, choose the latter option and press **Select**.

Using the volume control

The two volume keys on the side of the phone adjust the call volume.

Muting a call

Select Options > Mute while on a call. To cancel, select **Options > Unmute**.

Using loudspeaker

Select **Loudspeaker** at any time during a call.

Calling handsfree





You can also use your phone in handsfree mode. Place the phone on its side with the antenna pointing upwards and use loudspeaker or a handsfree headset.

Loudspeaker can be activated at any time during the call. To use the wired handsfree headset, connect it to the audio port at the base of the phone, under the protective cover. To use a Bluetooth headset, see [page 50](#) for more information.

2	Welcome
3	Safety
6	Quick reference
9	Getting started
14	Using your IsatPhone 2
14	Connecting to the satellite
15	Using the eCompass function
15	Obtaining a GPS fix
16	Making and Receiving calls
20	Incoming call alerting
21	Calling handsfree
22	Using voicemail
22	Additional call features
24	Advanced call features
27	Messaging
34	Prepay services
35	Location services
41	Phonebook & Contacts
45	Data
46	Personal settings
53	Security
56	Troubleshooting
59	Care and maintenance
61	Regulatory and compliance
64	Disclaimer
65	Accessories
66	Export controls
67	Malware
68	Downloading content
69	Notices
70	Protection of personal information
71	Type and specification
72	Index

Using voicemail

You will be able to receive voicemail messages if your service provider has enabled voicemail. Your phone automatically checks for voicemails shortly after it has been switched on and connected to the network. It will also send you voicemails that arrive while you are connected to the network.

If you have a new voicemail, the voicemail icon  will appear in the status bar at the top of the main screen and in **Info**. To listen to the message, hold down the  key on the keypad for a few seconds and your phone will automatically connect you to your Inmarsat voicemail. Alternatively, you can dial the short code **570** followed by the green key  or the full international number **00 870 772 001 899** or **+ 870 772 001 899** and the green key . Follow the spoken instructions. The default language for voicemail is English, but your service provider may have enabled your voicemail in your chosen language. If you wish to change the voicemail language, follow the spoken instructions or contact your service provider.

Additional call features

Viewing call length

Your phone logs the duration of outgoing and incoming calls. Press the green key  and **Dialled calls** appears, which lists the date, time and duration of each call. Use the navigation keys to access **Received calls** and **Missed calls**. Alternatively, select **Menu > Call log** and make your selection.

You may find the **Call duration** log useful for checking the **Last dialled** call duration, and the total time of **Dialled calls**.

To reset the counter, highlight the value you wish to reset, select **Options > Clear** and press the left navigation key labelled **Select**.

To reset all counters, select **Options > Clear timers**.

Setting the minute counter

Select **Menu > Settings > Call settings > Minute counter** and select your preferred setting. The default setting is off. When enabled, your phone will beep after every minute of your call.

2	Welcome
3	Safety
6	Quick reference
9	Getting started
14	Using your IsatPhone 2
14	Connecting to the satellite
15	Using the eCompass function
15	Obtaining a GPS fix
16	Making and Receiving calls
20	Incoming call alerting
21	Calling handsfree
22	Using voicemail
22	Additional call features
24	Advanced call features
27	Messaging
34	Prepay services
35	Location services
41	Phonebook & Contacts
45	Data
46	Personal settings
53	Security
56	Troubleshooting
59	Care and maintenance
61	Regulatory and compliance
64	Disclaimer
65	Accessories
66	Export controls
67	Malware
68	Downloading content
69	Notices
70	Protection of personal information
71	Type and specification
72	Index

Setting up call summary

Select **Menu > Settings > Call settings > Call summary** and then use the navigation and centre selection keys to make your selection. The default setting is on.

When **Call summary** is activated, the date, time and duration of the call is displayed.

Setting up and using speed dial

First, select **Menu > Settings > Call settings > Speed dialling** and then use the navigation and centre selection keys to make your selection. The default setting is on. Eight speed dial slots are available, from 2-9. Speed dial 1 is reserved for voicemail.

From the main screen, press and hold down for a few seconds the number key that you would like to associate with a contact. If the number is not yet assigned, a pop-up will ask if you wish to assign a contact to the key. Select **Yes** and a list of Phonebook contacts is displayed. Use the navigation keys to highlight the contact and then the contact's details. Press **OK** to save your selection.

Alternatively, select **Contacts > Phonebook**. Use the navigation keys to highlight the contact name, press the centre selection key to open or select **Options > Open**. Highlight the number to which you would like to assign the speed dial, eg. Mobile. Select **Options** and select **Assign speed dial**. Highlight a speed dial slot marked **Unassigned**, press the centre selection key to assign the phone number to that speed dial slot. To remove speed dial, follow the instructions above and select **Remove speed dial**.

To speed dial, hold down the appropriate number of the keypad for a few seconds and the phone will automatically dial the number.

Setting any key answer

Select **Menu > Settings > Call settings > Any key answer** and select **On**. The default setting is off. When activated, press any key to answer a call.

Deleting all call logs

Select **Menu > Call Log**. Select **Options > Clear all**. Press **Yes** to confirm.

2	Welcome
3	Safety
6	Quick reference
9	Getting started
14	Using your IsatPhone 2
14	Connecting to the satellite
15	Using the eCompass function
15	Obtaining a GPS fix
16	Making and Receiving calls
20	Incoming call alerting
21	Calling handsfree
22	Using voicemail
22	Additional call features
24	Advanced call features
27	Messaging
34	Prepay services
35	Location services
41	Phonebook & Contacts
45	Data
46	Personal settings
53	Security
56	Troubleshooting
59	Care and maintenance
61	Regulatory and compliance
64	Disclaimer
65	Accessories
66	Export controls
67	Malware
68	Downloading content
69	Notices
70	Protection of personal information
71	Type and specification
72	Index

Advanced call features

Advanced call features are controlled by the Inmarsat network. To check or change these features, the phone must be connected to the satellite with a signal strength of at least two bars.

Sending your caller ID

Select **Menu > Settings > Call settings > Send my caller ID**, then select **On**, **Off** or **Set by network** and press **OK**. Set by network leaves it to the network to select whether **Caller ID** is displayed. The default setting is **Set by Network**.

When **Send my caller ID** is on, your caller ID will be displayed on the recipient's phone. If this feature is switched off, your caller ID will be hidden and **Withheld** displayed in its place.

Setting up call waiting

Select **Menu > Settings > Call settings > Call waiting**, and select **Activate**. There may be a short delay before the network responds. **Call waiting activated** will appear when the setting has been enabled. The **Call waiting** default setting is off. From the **Call waiting** menu you can also select to **Check status** or **Deactivate**. To use call waiting, see Using call waiting on [page 18](#) for more information.

Call barring

An IsatPhone 2 SIM card always uses an international number format, + or 00, and the country code, 870. Call barring prevents the following call types from being made or received by your phone:

- **Outgoing calls:** bars all outgoing calls
- **International calls:** bars all outgoing calls except to other Inmarsat numbers
- **International except to home:** bars all outgoing calls except to other Inmarsat numbers
- **Incoming calls:** bars all incoming calls
- **Incoming outside home:** bars all incoming calls except from other Inmarsat numbers
Note: This feature is not supported in all countries.

If you are using a SIM card with local country numbering, the call barring is as described by the menu.

The first time you set up call barring, you will need to reset the barring password. Select **Menu > Settings > Call settings > Call barring**. Select **Options** and navigate to **Change barring pass code**. Enter the barring pass code and select **OK**. The default is 0000. Enter a new four-digit pass code and select **OK**. Then enter the new pass code again to confirm it.

You will need to enter this new pass code whenever you change your call barring settings.

2	Welcome
3	Safety
6	Quick reference
9	Getting started
14	Using your IsatPhone 2
14	Connecting to the satellite
15	Using the eCompass function
15	Obtaining a GPS fix
16	Making and Receiving calls
20	Incoming call alerting
21	Calling handsfree
22	Using voicemail
22	Additional call features
24	Advanced call features
27	Messaging
34	Prepay services
35	Location services
41	Phonebook & Contacts
45	Data
46	Personal settings
53	Security
56	Troubleshooting
59	Care and maintenance
61	Regulatory and compliance
64	Disclaimer
65	Accessories
66	Export controls
67	Malware
68	Downloading content
69	Notices
70	Protection of personal information
71	Type and specification
72	Index

To cancel a bar, highlight that type of call in the **Call barring** menu, select **Options** and select **Cancel**. To cancel all call barring, select **Options** and select **Cancel all barring**. To check the status of a call bar, highlight that type of call in the **Call barring** menu, select **Options** and select **Check status**.

The barring code can be entered incorrectly an unlimited number of times. If you have forgotten your code, please contact your service provider.

Note: Fixed number dialling, Call barring and Call divert does not prevent emergency calling. **Call barring** and **Call divert** cannot be active at the same time.

Diverting calls

Select **Menu > Settings > Call settings > Call divert**. **Call divert** allows you to forward incoming calls to your voicemail or another phone number:

- **Only voice calls** – diverts any voice call to your voicemail or another number
- **Only data calls** – diverts data calls to another phone number
- **Only fax calls** – diverts fax calls to another phone number
- **If busy** – when you are engaged on another call, this option diverts calls either to your voicemail or to another number
- **If no reply** – this option allows you to select how long

your phone should ring (up to 30 seconds) before the call is diverted to your voicemail or another number

- **If out of reach** – when you are out of reach of a satellite signal this option diverts calls either to your voicemail or to another number
- **If not available** – diverts all 'If busy', 'If no reply' and 'If out of reach' calls. If you subsequently assign a divert number for any of these calls, that number will override the 'If unavailable' divert number

After making your selection, you will be prompted to enter the phone number or voicemail to which calls are to be diverted. Select **Options** to select a number from your phonebook.

To cancel call divert, highlight that type of call in the **Call divert** menu, select **Options** and select **Cancel**. To cancel all call diverts, select **Options** and select **Cancel all forwarding**. To check the status of a call divert, highlight that type of call in the **Call divert menu**, select **Options** and select **Check status**.

Note: Fixed number dialling, Call barring and Call divert does not prevent emergency calling. **Call barring** and **Call divert** cannot be active at the same time.

2	Welcome
3	Safety
6	Quick reference
9	Getting started
14	Using your IsatPhone 2
14	Connecting to the satellite
15	Using the eCompass function
15	Obtaining a GPS fix
16	Making and Receiving calls
20	Incoming call alerting
21	Calling handsfree
22	Using voicemail
22	Additional call features
24	Advanced call features
27	Messaging
34	Prepay services
35	Location services
41	Phonebook & Contacts
45	Data
46	Personal settings
53	Security
56	Troubleshooting
59	Care and maintenance
61	Regulatory and compliance
64	Disclaimer
65	Accessories
66	Export controls
67	Malware
68	Downloading content
69	Notices
70	Protection of personal information
71	Type and specification
72	Index

Fixed number dialling (FND)

When **Fixed number dialling** is activated, the user is limited to dialling or texting only numbers stored in the FND list. The default setting is off.

Activating and de-activating fixed number dialling

Select **Menu > Settings > Security**, highlight **Fixed dialling** from the list and press the centre selection key. Select **On** to activate and press the centre selection key or **OK**. You will be prompted to enter your PIN 2 code. The default PIN 2 is 9999. See Setting up SIM PIN 2 code on [page 55](#) for more information. Contact your service provider if this code was not specified or was reset at purchase.

To add a number to your list, select **Menu > Contacts > FND list** and press the centre selection key. Press **Options** and select either **New FND contact** or **Copy from phonebook**. You will then be prompted for the PIN 2 code.

FND list entries are stored on your SIM card. Only one name and one contact number can be stored for each entry.

Fixed number dialling can restrict your phone to a certain prefix, as well as individual phone numbers. To limit outbound calls or text messages to a specific country or range of corporate numbers, create an FND list entry with the international prefix and local prefix you wish to allow, followed by the correct number of remaining digits replaced by question marks. Press the ***** key twice to enter a question mark.

Example: To limit calls to UK landlines, create an FND list entry: +44?????????. Substitute any number in place of the ? symbols while dialling or sending a message.

When fixed number dialling is activated, your phone still enables numbers stored in other areas of **Contacts** to be viewed.

2	Welcome
3	Safety
6	Quick reference
9	Getting started
14	Using your IsatPhone 2
14	Connecting to the satellite
15	Using the eCompass function
15	Obtaining a GPS fix
16	Making and Receiving calls
20	Incoming call alerting
21	Calling handsfree
22	Using voicemail
22	Additional call features
24	Advanced call features
27	Messaging
34	Prepay services
35	Location services
41	Phonebook & Contacts
45	Data
46	Personal settings
53	Security
56	Troubleshooting
59	Care and maintenance
61	Regulatory and compliance
64	Disclaimer
65	Accessories
66	Export controls
67	Malware
68	Downloading content
69	Notices
70	Protection of personal information
71	Type and specification
72	Index

Using fixed number dialling

Select **Menu > Contacts > FND list** and the contact. Select **Call** or **Send message** from **Options**.

To send email messages when fixed number dialling is activated, the message centre number should be added to the FND list. See Message settings on [page 33](#) for more information on finding your message centre number.

Note: Fixed number dialling, Call barring and Call divert does not prevent emergency calling.

Messaging

Using the message menu

Select **Menu > Messaging**. Select any one of the following options and press the centre selection key or select **Options > Open**. The functions are:

- **New message** - to create a new message
- **Inbox** - to store received messages
- **Outbox** - to temporarily store messages waiting to be sent. Messages are placed in **Outbox**, for example, when your phone is not connected to the network. If sent, messages will be stored in **Sent**. If unsent, messages will be stored in **Drafts**
- **Drafts** - when a message is written but not ready or able to be sent, the message is saved here
- **Sent** - to store the sent messages. If you want your sent messages to be saved, select **Menu > Messaging > Options > Settings > Text msg settings > Saving sent messages** and select **On**

2	Welcome
3	Safety
6	Quick reference
9	Getting started
14	Using your IsatPhone 2
14	Connecting to the satellite
15	Using the eCompass function
15	Obtaining a GPS fix
16	Making and Receiving calls
20	Incoming call alerting
21	Calling handsfree
22	Using voicemail
22	Additional call features
24	Advanced call features
27	Messaging
34	Prepay services
35	Location services
41	Phonebook & Contacts
45	Data
46	Personal settings
53	Security
56	Troubleshooting
59	Care and maintenance
61	Regulatory and compliance
64	Disclaimer
65	Accessories
66	Export controls
67	Malware
68	Downloading content
69	Notices
70	Protection of personal information
71	Type and specification
72	Index

- **Saved messages** - to store received messages
- **Templates** - If you regularly send similar messages, you can set up a template. To do this, compose a new message, select **Menu > Messaging > New message > Text message** and compose the parts of your message that will not change. Select **Options > Save as template**. To compose a new text message based on this template, select **Menu > Messaging > Options > Compose from template** and then select the template you would like to use. Edit the text, add recipient and then select **Options > Send**
- **SIM messages** - to store messages in SIM memory.

A total of 125 messages can be stored in the phone memory.

Entering text

You need to enter text when composing a message, adding a contact to your phonebook, adding an appointment to your organiser or searching. Your phone offers two types of text entry mode: predictive and standard.

Using predictive text entry

Predictive text mode allows you to use less keystrokes to type a word as it uses a built-in dictionary as a time-saving feature.

For example, to type the word **hello**, you would only use 5 keystrokes (one for each letter of the word). When you type **h** (number **4** on the keypad) a list appears on the screen. It is not necessary to select the letter **h** as when you type **e** (number **3**) the dictionary begins to narrow down the words that begin with **he**. Key number **5** twice to type **ll**, then number **6** for the letter **o**. This will result in the dictionary selecting the only known word with these sequential letters, ie. hello.

If the dictionary has a number of options for the same keystrokes it will present a list of words. Use the down arrow to scroll to the word you require and press the centre selection key. As always, press the **0** key to create a space between words.

If the word you are typing is not in the dictionary, **Word not in dictionary** appears. Press **OK** and select **Spell word**, type the word you want to enter and press **Select**. The new word is now saved in your dictionary for future use.

2	Welcome
3	Safety
6	Quick reference
9	Getting started
14	Using your IsatPhone 2
14	Connecting to the satellite
15	Using the eCompass function
15	Obtaining a GPS fix
16	Making and Receiving calls
20	Incoming call alerting
21	Calling handsfree
22	Using voicemail
22	Additional call features
24	Advanced call features
27	Messaging
34	Prepay services
35	Location services
41	Phonebook & Contacts
45	Data
46	Personal settings
53	Security
56	Troubleshooting
59	Care and maintenance
61	Regulatory and compliance
64	Disclaimer
65	Accessories
66	Export controls
67	Malware
68	Downloading content
69	Notices
70	Protection of personal information
71	Type and specification
72	Index

You can change the text entry settings whilst composing a message. Click and hold the **#** key. A pop-up menu offers options to change the language, text editing mode or to add a new word.

Note: To change the language of the dictionary used while composing a text message, select **Options > Writing language**.









Using standard (non-predictive) text entry

Standard text entry enables you to key text in manually, letter by letter, without the phone suggesting the word you are attempting to type.

To enter text, repeatedly press a number key, **2-9**, until the desired character appears. For numbers, hold the key down longer until the number appears. To insert a space, press the **0** key. For symbols such as punctuation marks, press the ***** key and then use the navigation keys to select from the menu. Press the **#** key to change text editing and capitalisation. To delete text, place the cursor to the right of the character you wish to delete and select **Clear**. Move the cursor around the message using the navigation keys to insert or delete text anywhere in the message.

Selecting text entry mode

The icon at the top right of your screen displays your choice of text entry mode and character case. The default setting is standard text. If you want to change the text entry mode press the **#** key repeatedly until your chosen mode icon is indicated. The modes are:

-  **Predictive mode** – all capitalised
-  **Predictive mode** – initial capital only
-  **Predictive mode** – no capitals
-  **Standard mode** – all capitalised
-  **Standard mode** – initial capital only
-  **Standard mode** – no capitals
-  **Standard mode** – numbers only
-  **Standard mode** – symbols only

Creating a text message

The character limit for a text sent from your phone is approximately 1600 Latin characters or 740 non-Latin characters, ie up to 10 concatenations, including the recipient's telephone number.

2	Welcome
3	Safety
6	Quick reference
9	Getting started
14	Using your IsatPhone 2
14	Connecting to the satellite
15	Using the eCompass function
15	Obtaining a GPS fix
16	Making and Receiving calls
20	Incoming call alerting
21	Calling handsfree
22	Using voicemail
22	Additional call features
24	Advanced call features
27	Messaging
34	Prepay services
35	Location services
41	Phonebook & Contacts
45	Data
46	Personal settings
53	Security
56	Troubleshooting
59	Care and maintenance
61	Regulatory and compliance
64	Disclaimer
65	Accessories
66	Export controls
67	Malware
68	Downloading content
69	Notices
70	Protection of personal information
71	Type and specification
72	Index

Select **Menu > Messaging > New message > Text message**. A blank screen will appear. Compose your message. See Entering text on [page 28](#) for more information. When you have finished, add the recipient(s). If their details are already stored in your **Contacts** select **Options > Add recipient** and select the name from the list. Use the left and right navigation keys to move between Phonebook and SIM contacts.

If the recipient's details are not stored, use the up navigation key to move the cursor to the **To:** line. Enter the recipient's full international number. If you make a mistake, use the left and right navigation keys to move the cursor and **Clear** to delete a number.

When you have finished adding recipients, select **Options > Send** or press the centre selection key.

If you want to save your message so you can edit or send it later, select **Options > Save**, or select **Options > Exit** and confirm that you want to save the text. The message will be saved in the **Drafts** folder. When you are ready to complete it, select **Menu > Messaging > Drafts**.

Creating a text message for sending to an email address

Your phone can also send text messages to email addresses. Instead of displaying your name to the recipient the message will display your details in the following format:

From: your phone number@message.inmarsat.com
eg. **From:** 8707764XXXXX@message.inmarsat.com

The character limit for a text sent from your phone to an email address is approximately 1600 Latin characters or 740 non-Latin characters, ie up to 10 concatenations, including the recipient's email address.

Select **Menu > Messaging > New message > Email message**. Compose your message. Recipients can be added from stored contacts by selecting **Options > Add recipient**. Only entries containing an email address will be displayed.

To send your message to an email address which is not stored, use the up navigation key to move the cursor into the **To:** field and type the address. For symbols such as the @ sign, press the * key and then use the navigation keys to select from the menu. After entering the address, wait for 5 seconds and the phone will place a ; after the entry, allowing you to enter another address. When you move the cursor away from the **To:** field or open **Options**, your phone will check the email addresses entered. If addresses do not follow the format of a valid email address, they will be deleted and an error message displayed.

Receiving text and email messages

Messages can be received when the antenna is deployed and your phone is connected to the network, even if you are on a call, or when incoming calls are forwarded to another phone number.

If your phone is switched off when a message is received, the message is stored by the network until your phone is switched on and registered with the network. Delivery will be attempted for the duration that your message

2	Welcome
3	Safety
6	Quick reference
9	Getting started
14	Using your IsatPhone 2
14	Connecting to the satellite
15	Using the eCompass function
15	Obtaining a GPS fix
16	Making and Receiving calls
20	Incoming call alerting
21	Calling handsfree
22	Using voicemail
22	Additional call features
24	Advanced call features
27	Messaging
34	Prepay services
35	Location services
41	Phonebook & Contacts
45	Data
46	Personal settings
53	Security
56	Troubleshooting
59	Care and maintenance
61	Regulatory and compliance
64	Disclaimer
65	Accessories
66	Export controls
67	Malware
68	Downloading content
69	Notices
70	Protection of personal information
71	Type and specification
72	Index

remains in the network. To check or change this setting, select **Menu > Messaging > Options > Settings > Text msg settings > Validity period**. When you receive a message on your phone, an unread message  icon will appear on the status bar. **Info** will pop-up and display a list of unread messages. If you wish to read the message later, press **Close**. To read the message, select **Menu > Messaging > Inbox**. Alternatively, with **Info** open, use the centre selection and navigation keys to highlight and open **Unread messages**.

Incoming text messages accommodate the full 10 concatenations. However, incoming messages from emails are restricted to approximately 160 Latin and 74 non-Latin characters. If the sender exceeds this limit, the message will be truncated upon receipt.

Viewing your received messages

Inbox lists the last 20 messages received, including message status (read or unread), the sender's name or number, the first words of the message and the date received. Use the up and down navigation keys to highlight a message and press the centre selection key or select **Options > Open**.

Replying to sender

Open the message and select **Options > Reply**. A new blank message will be displayed. Complete the fields as prompted.

Forwarding a message

Open the message and select **Options > Forward > Text message** or **Email message**. The message is displayed with the cursor flashing in the empty **To:** field. Enter the recipient's number or to add a contact from the phonebook, press **Options > Add recipient**. When the **To:** field is completed, select **Options > Send**. A pop-up confirms that the message has been sent. The sent message is stored in the **Sent** list.

Calling a number from a received message

Open the message and press the green key  or select **Options > Call**. After the number has been called, the message is considered read and remains in the inbox.

Saving details from a received message

Open the message and select **Options > Address clipboard**. The sender's number is displayed. Select **Options > Add to contacts**. You can either **Create new** or **Update existing**. Select which field to save the number in the contacts list, complete other fields as appropriate and select **Options > Save**. The contact will be stored in **Phonebook**. See [Creating a new contact on page 40](#) for more information.

Saving a received message

To save a received message, open the message you wish to save and select **Options > Copy to folder > Saved messages**.

2	Welcome
3	Safety
6	Quick reference
9	Getting started
14	Using your IsatPhone 2
14	Connecting to the satellite
15	Using the eCompass function
15	Obtaining a GPS fix
16	Making and Receiving calls
20	Incoming call alerting
21	Calling handsfree
22	Using voicemail
22	Additional call features
24	Advanced call features
27	Messaging
34	Prepay services
35	Location services
41	Phonebook & Contacts
45	Data
46	Personal settings
53	Security
56	Troubleshooting
59	Care and maintenance
61	Regulatory and compliance
64	Disclaimer
65	Accessories
66	Export controls
67	Malware
68	Downloading content
69	Notices
70	Protection of personal information
71	Type and specification
72	Index

Deleting messages

Select the message from the list displayed in any of the message folders and select **Options > Delete**. A pop-up will appear asking you to confirm the action. Press **Yes**. To delete all the messages in the folder, select **Options > Delete all messages**.

Setting up message groups

If you regularly send the same text or email message to the same group of people, you can set up a group. Select **Menu > Contacts > Groups**, then select **Options > Create new**. Enter a name for your group and select **OK**, followed by **Yes**. You can set up a maximum of 20 groups, and the same contact can be a member of more than one group.

To add members to a group, select **Menu > Contacts > Groups**, highlight the group to which you would like to add members and press the centre selection key. Now select **Options > Add member**. This will retrieve your phonebook. Highlight the name of the contact you would like to add to the group and press the left or centre selection key. A group can have any number of contacts.

By selecting **Options** when a member of the group is highlighted, you can also:

- **Open** the contact's details
- **Call** the contact
- Send a **Text message** to the contact
- **Remove from group** to remove the contact from this group
- **View group list** to view the members of each group

Assign group ringtone to give all members of this group the same ringtone, so that you will be able to recognise when a member of the group is calling you.

To send a text message to the whole group, select **Menu > Messaging > New message > Text message** or **Email message > Options > Add recipient** and then press the right navigation key three times to move between the tabs. Select the group from the list and compose your message.

You can also add members to groups directly from your phonebook. In your phonebook, simply highlight the contact, select **Options > Add to group**, then select which group to which you would like to assign the contact. You can also see which members belong to a group by selecting **Options > Belongs to group**.

2	Welcome
3	Safety
6	Quick reference
9	Getting started
14	Using your IsatPhone 2
14	Connecting to the satellite
15	Using the eCompass function
15	Obtaining a GPS fix
16	Making and Receiving calls
20	Incoming call alerting
21	Calling handsfree
22	Using voicemail
22	Additional call features
24	Advanced call features
27	Messaging
34	Prepay services
35	Location services
41	Phonebook & Contacts
45	Data
46	Personal settings
53	Security
56	Troubleshooting
59	Care and maintenance
61	Regulatory and compliance
64	Disclaimer
65	Accessories
66	Export controls
67	Malware
68	Downloading content
69	Notices
70	Protection of personal information
71	Type and specification
72	Index

Sending a text to a group of people

If you regularly send the same text to a group of people, you can create a group in your phonebook. To send the text to a group you have already set up, select **Options** > **Add recipient** and then press the right navigation key twice to display the list of groups.

Using message settings

Select **Menu** > **Messaging** > **Options** > **Settings** > **Text msg settings** or **Email settings**.

Text message settings:

Use same message centre: Always set to **Yes**.

SMSC management: Both specify the number to which your phone will despatch your messages for delivery.

Validity period: Specifies the length of time your message will remain in the network, should it be pending for delivery to the recipient.

Saving sent messages: The default setting is on. The setting can be changed if required.

Long message sending: The default setting is on. This allows approximately 1600 Latin or 740 non-Latin characters to be sent ie. up to 10 concatenations.

With original text / Without original text: The sender's original message is included/excluded as part of any reply that you compose. The default setting is **Without original text**.

Set defaults: This resets all message settings.

Entering your service centre number

It is unlikely that you would need to enter or change your service centre number unless advised to do so by your service provider.

The number of your service centre is required in order to send messages. In the unlikely event that this detail is not on your SIM card, you can enter the number yourself.

To enter a service centre number, select **Menu** > **Messaging** > **Options** > **Settings** > **Text msg settings** > **SMSC management**. If the phone number of your service centre is displayed, select **Options** > **Exit**. If there is no number in the display, select **Options** > **Edit** and enter the full international number of the service centre. You will be prompted to activate the number. Press **Yes**. Your phone is now ready to send and receive messages. Alternatively, select **Menu** > **Messaging** > **Options** > **Settings** > **Email settings** > **Options** > **Edit** and add the email centre number and select **Apply**.

Setting a message delivery expiry period

If your message cannot be delivered, you can change the length of time your message will remain in the network. To check or change the expiry period select **Menu** > **Messaging** > **Options** > **Settings** > **Text msg settings** > **Validity period**.

Click to navigate

2	Welcome
3	Safety
6	Quick reference
9	Getting started
14	Using your IsatPhone 2
14	Connecting to the satellite
15	Using the eCompass function
15	Obtaining a GPS fix
16	Making and Receiving calls
20	Incoming call alerting
21	Calling handsfree
22	Using voicemail
22	Additional call features
24	Advanced call features
27	Messaging
34	Prepay services
35	Location services
41	Phonebook & Contacts
45	Data
46	Personal settings
53	Security
56	Troubleshooting
59	Care and maintenance
61	Regulatory and compliance
64	Disclaimer
65	Accessories
66	Export controls
67	Malware
68	Downloading content
69	Notices
70	Protection of personal information
71	Type and specification
72	Index

Prepay services

If you have a prepay subscription, your service provider will have informed you of the services available to you. Your phone also enables you to make a balance enquiry and redeem prepay vouchers for Inmarsat's prepay service, free of charge. Select **Menu > Settings > Prepay**, then select either **Balance enquiry** or **Redeem voucher** and follow the on-screen instructions.

Making a balance enquiry

From the main screen enter your balance enquiry code, ***106#** and press the green key . Your current balance and expiry date will be shown on the screen.

Redeeming a prepay voucher

From the main screen enter the top-up code, ***101*VoucherNumber#**, eg. ***101*1234567890123456#** and press the green key . Your new balance and expiry date will be shown on the screen.

2	Welcome
3	Safety
6	Quick reference
9	Getting started
14	Using your IsatPhone 2
35	Location services
35	Using the Assistance button
37	Using the Tracking feature
38	Using your GPS location information
39	Personal alert
41	Phonebook & Contacts
45	Data
46	Personal settings
53	Security
56	Troubleshooting
59	Care and maintenance
61	Regulatory and compliance
64	Disclaimer
65	Accessories
66	Export controls
67	Malware
68	Downloading content
69	Notices
70	Protection of personal information
71	Type and specification
72	Index

Using the Assistance button

In a critical situation, the **Assistance button** allows you to rapidly make a call to a recipient, or send an alert text message or email to one or more recipients. **Note:** An assistance alert is not the same as an emergency call, see [page 19](#). You **cannot** set the feature to call a national emergency number (e.g. 911) or other numbers of less than four digits. However it is always good practice to save to your phonebook the contact details of related local services so that they can be alerted if necessary.

Enabling the Assistance feature

Before you can use the Assistance feature, you must enable it and configure the alert type and recipients. From the main menu select **Location services > Assistance button > Configure > Assistance feature**. Then press the centre selection key to enable the feature.

Configuring Assistance button calls

Go to **Location services > Assistance button > Configure > Alert type**, then select **Call only** or **Call & message**. Choose the intended recipient of your call by selecting **Location services > Assistance button > Configure > Call config. > Edit recipient**. You can choose a contact from the phonebook or add a new contact. To find contacts, edit contacts or add new contacts, see [Managing contacts in your phonebook on page 41](#). You can only select one recipient for an assistance call. If you want to use the handset loudspeaker when you make an assistance call, select **Location services > Assistance**

button > Configure > Call config. > Handsfree call > On. If you want the handset to automatically redial the recipient when the call setup fails, select **Location services > Assistance button > Configure > Call config. > Call retry > On**. If the first call is unsuccessful, the handset disconnects and shows the text **Call connection failed, retrying**. The contact is then automatically re-dialled after three minutes. The handset will make up to eight attempts to connect to the recipient, after which **Assistance alert** is de-activated.

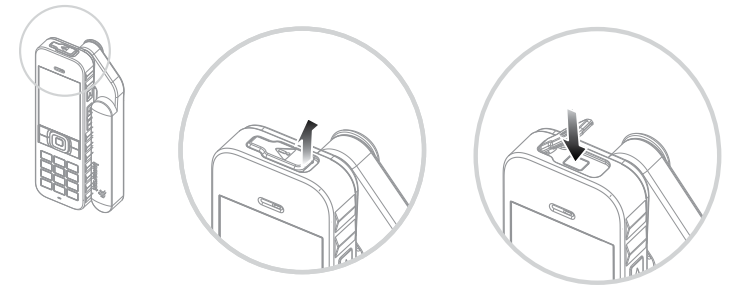

Configuring Assistance button messages

Go to **Location services > Assistance button > Configure > Alert type**, then highlight **Call & message** or **Message only** and press the centre selection key. Choose the intended recipient of your message by selecting **Location services > Assistance button > Configure > Message config. > Edit recipient**. See [Configuring assistance calls above](#). Then choose the type of message that you want to send to this recipient by selecting **Email message** or **Text message**. If you want to send a message to more than one recipient, select each contact from the

Click to navigate

2	Welcome
3	Safety
6	Quick reference
9	Getting started
14	Using your IsatPhone 2
35	Location services
35	Using the Assistance button
37	Using the Tracking feature
38	Using your GPS location information
39	Personal alert
41	Phonebook & Contacts
45	Data
46	Personal settings
53	Security
56	Troubleshooting
59	Care and maintenance
61	Regulatory and compliance
64	Disclaimer
65	Accessories
66	Export controls
67	Malware
68	Downloading content
69	Notices
70	Protection of personal information
71	Type and specification
72	Index

phonebook separately (adding new contacts if necessary) and choose the message type for each. A maximum of ten message recipients is permitted.

The content of assistance messages is automatically created by the handset. It always includes an up-to-date GPS fix, the time at which the fix was acquired and the time that the alert was triggered. An email cannot exceed 160 characters, including the recipient's email address, and users cannot personalise messages by entering additional text. Here is an example of an assistance message:

Assistance alert from:
+870776400465
52.123N,22.456W
20140202T125959Z
h:08m,v:32m accuracy
Created 20140202T132216Z

where:
+870776400465
is the sender's phone number

52.123N,22.456W
is the latitude and longitude of the sender's location

20140202T125959Z
is the date and time at which the GPS fix was acquired

h:08m,v:32m accuracy
is the horizontal and vertical accuracy of the GSP fix in meters

Created 20140202T132216Z

is the timestamp giving the date and time at which the alert was triggered

Activating an Assistance button alert

With your handset switched on and the antenna deployed, flip open the latch of the Assistance button at the top of the handset and press the button revealed. Alternatively, from the main menu, select **Location services > Assistance button > Configure assistance button > Send assistance alert**. The on-screen text informs you that the alert will be sent in 15 seconds and that you can select **Alert now** to send it immediately. You can cancel the alert during this time, by pressing **Cancel**. Respond as necessary. If alert messages have been configured, they are then sent to the recipient(s). If alert call has been configured, then the call is established. During the call, the screen displays the latitude and longitude of your current location.

Assistance button security

You can lock the Assistance button feature to prevent unauthorised use. If the lock is on, you must enter the admin code before the feature's settings can be changed. See Setting up the admin code on [page 54](#) for more information. The lock default setting is **Off**.

To switch on or off the Assistance button lock, select **Menu > Settings > Security** and select **Assistance button lock** from the list. Then select **On** or **Off**, enter the admin code and press **OK**.

2	Welcome
3	Safety
6	Quick reference
9	Getting started
14	Using your IsatPhone 2
35	Location services
35	Using the Assistance button
37	Using the Tracking feature
38	Using your GPS location information
39	Personal alert
41	Phonebook & Contacts
45	Data
46	Personal settings
53	Security
56	Troubleshooting
59	Care and maintenance
61	Regulatory and compliance
64	Disclaimer
65	Accessories
66	Export controls
67	Malware
68	Downloading content
69	Notices
70	Protection of personal information
71	Type and specification
72	Index

Using the Tracking feature

The **Tracking** feature allows you to send text messages or emails reporting the GPS coordinates of your current location to one or more recipients or, alternatively, to a tracking portal. The messages are automatically generated by the handset, with updated coordinates, at a default preset interval of 15 minutes. To send any message, your handset must be registered to the network. See Connecting to the satellite on [page 14](#).

Configuring Tracking

Tracking status

- The Tracking feature has three states - **Enabled**, **Disabled** and **Always-on** - that control access to the sending of tracking messages. To configure the status, go to the main menu and choose **Location services > Tracking > Configure tracking > Tracking status**. Then choose a state:
- **Enabled:** allows you to start and stop sending tracking messages, either by navigating the menu or by using the Tracking button [graphic] above the volume up/down keys on the side of the handset
- **Disabled:** removes the ability to start or stop the transmission of tracking messages
- **Always-on:** The handset continues to send messages whenever it is connected to the network

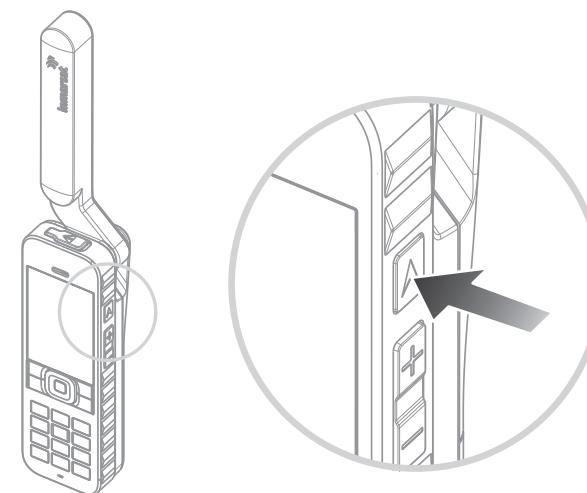

Choosing the message recipients and message type

Select **Location services > Tracking > Configure tracking > Edit recipient**. You can choose a contact from the phonebook or add a new contact. To find and edit contacts or to add new contacts, see Managing contacts in your phonebook on [page 41](#). If you want to send messages to more than one recipient, select each contact from the phonebook separately (adding new contacts if necessary). A maximum of ten recipients is permitted. When you have chosen a recipient, press **Select**. The message types available for that contact are displayed, highlight **Text message** or **Email message** and press **Select**. Note that a recipient's email addresses cannot exceed 40 characters.

2	Welcome
3	Safety
6	Quick reference
9	Getting started
14	Using your IsatPhone 2
35	Location services
35	Using the Assistance button
37	Using the Tracking feature
38	Using your GPS location information
39	Personal alert
41	Phonebook & Contacts
45	Data
46	Personal settings
53	Security
56	Troubleshooting
59	Care and maintenance
61	Regulatory and compliance
64	Disclaimer
65	Accessories
66	Export controls
67	Malware
68	Downloading content
69	Notices
70	Protection of personal information
71	Type and specification
72	Index

Choosing the message interval

When Tracking is set to **On**, messages are automatically sent every 15 minutes by default.

You can increase or decrease this interval to suit your requirements. Select **Configure tracking > Edit interval**. The screen displays preset time intervals. Highlight an interval value and press **Select**. You can also specify your own interval of up to 9999 minutes by choosing **Custom interval** from the list of intervals. A blank text box is displayed. Type the interval that you want to use and press **OK**.

Starting tracking

If the Tracking status is set to **Enabled**, you can start and stop sending tracking messages by using the **Tracking** button. Alternatively, from the main menu choose **Location services > Tracking > Start**. On-screen text confirms that tracking messages will be sent at the chosen interval. Press **OK**.

If you have chosen **Always-on override**, tracking messages are sent whenever the handset is registered to the network.

The tracking LED above the screen flashes when Tracking has started.

Stopping tracking

To stop sending tracking messages, press the **Tracking** button or choose **Location services > Tracking > Stop** and press **Select**. An on-screen prompt asks you to confirm, press **OK**. The tracking LED goes off.

To stop sending tracking messages when **Always-on** has been selected, change the status by choosing **Location services > Tracking > Configure Tracking > Tracking status > Disabled**.

Tracking security

You can lock the Tracking feature to prevent unauthorised use. If the lock is on, you must enter the admin code before you can change the Tracking feature's settings. See Setting up the admin code on [page 54](#) for more information. The lock default setting is **Off**.

To switch **Tracking lock** on or off, select **Menu > Settings > Security** and select **Tracking lock** from the list. Then select **On** or **Off**, enter the admin code and press **OK**.

Using your GPS location information

As well as locating your phone's position for the satellite, you can also view your GPS location and send it as a text message or email.

Note: You can view GPS information only after the phone has been registered to the network.

Viewing your GPS location information

Select **Menu > GPS position > Options > View location information** to view the date and time of when your last GPS fix was taken and your latitude and longitude at that time. Your exact location is indicated with a white dot on the world map.

2	Welcome
3	Safety
6	Quick reference
9	Getting started
14	Using your IsatPhone 2
35	Location services
35	Using the Assistance button
37	Using the Tracking feature
38	Using your GPS location information
39	Personal alert
41	Phonebook & Contacts
45	Data
46	Personal settings
53	Security
56	Troubleshooting
59	Care and maintenance
61	Regulatory and compliance
64	Disclaimer
65	Accessories
66	Export controls
67	Malware
68	Downloading content
69	Notices
70	Protection of personal information
71	Type and specification
72	Index

Displaying GPS in metric or imperial measures

Select **Menu > GPS position**. The **Valid GPS fix** screen appears. Select **Options > Set unit** and make your selection. The default setting is metric units.

Sending your GPS location

Select **Menu > GPS position** and select **Options > Send GPS location**. The elapsed time since the last GPS fix was obtained is displayed and you are presented with two options. Select **Send** to use the stored value or **New** to acquire a new GPS fix. Press the red key  to cancel. Make your decision on the basis of any significant distance travelled since the stored GPS fix was obtained. Note that requesting a new fix will temporarily delay the sending of your location.

When the GPS fix to be used has been acquired, select **Text message** or **Email message**. Only editing of the recipient field is permitted. Enter the destination number or email address directly into the **To:** field, or choose **Options > Add recipient** to select an existing entry from **Contacts**. You are presented with the list of **Phonebook Contacts**. Use the left and right navigation keys to select **SIM contacts** or **Groups**.

Obtaining a GPS fix manually

On rare occasions, your phone may continue to show the GPS fix required  icon, which means that a new GPS fix is needed in order for your phone to connect to the network. If this occurs, select **Menu > GPS position**. The new GPS fix is displayed. When this screen is open, your phone will attempt to refresh the GPS fix every 30 seconds.

National GPS policies

Some national GPS policies do not allow users to access their GPS information in particular locations. Your phone continues to access the GPS satellites as usual, so its performance is unaffected. However, your phone will not display its GPS location. For more information, please contact your service provider.

GPS Data

Inmarsat will collect, store and process GPS data in accordance with applicable data protection laws.

Personal alert

The personal alert feature enables a user to send their GPS position, along with a short pre-configured message, as an email or text message, to a maximum of 10 recipients.

Pre-configuration, use of a stored GPS fix and a short-dial code enable the personal alert to be sent quickly whilst maximising reliability. This is achieved by restricting the alert to one 160 character message, and mailing to each recipient separately. Each message sent is charged separately.

Note: Generally, email message routing is more reliable than text messages.

Setting up and activating a personal alert

To set up and activate a personal alert, select **Extras >**

2	Welcome
3	Safety
6	Quick reference
9	Getting started
14	Using your IsatPhone 2
35	Location services
34	Using the Assistance button
36	Using the Tracking feature
37	Using your GPS location information
38	Personal alert
41	Phonebook & Contacts
45	Data
46	Personal settings
53	Security
56	Troubleshooting
59	Care and maintenance
61	Regulatory and compliance
64	Disclaimer
65	Accessories
66	Export controls
67	Malware
68	Downloading content
69	Notices
70	Protection of personal information
71	Type and specification
72	Index

Personal alert > Edit personal alert. Select **Configure personal alert**, and edit the recipients and the message. See the Messaging section starting on [page 27](#) for more information.

The personal alert is made up of the following elements:

- Last GPS fix, time of GPS acquisition and fix accuracy
- Time that the personal alert was triggered on the phone
- Email address of the recipient if the alert is sent as an email
- A short message predefined by the user, written in Latin characters. This personalised text is limited in length; a descending counter indicates available characters when editing. The same message is sent to all recipients

You can restrict access to the **Edit personal alert** feature by switching on **Personal alert lock** in **Menu > Settings > Security** and entering the admin code. The default for **Personal alert lock** is off. See Setting up the admin code on [page 54](#) for more information.

Sending a personal alert

The quickest way to send a personal alert is to press ***** and **#** simultaneously for at least 2 seconds from the main screen. Alternatively, select **Menu > Extras > Personal alert > Send personal alert**. A pop-up will appear asking you to confirm the action.

The antenna must be deployed and your phone connected to the satellite to successfully send personal alert messages.

2	Welcome
3	Safety
6	Quick reference
9	Getting started
14	Using your IsatPhone 2
35	Location services
41	Phonebook & Contacts
41	Managing contacts in your phonebook
43	Managing contacts on your SIM card
43	Synchronising contacts with Outlook
43	Sending and receiving contact details
44	Your phone number
44	Your service provider number
44	Alarm
45	Data
46	Personal settings
53	Security
56	Troubleshooting
59	Care and maintenance
61	Regulatory and compliance
64	Disclaimer
65	Accessories
66	Export controls
67	Malware
68	Downloading content
69	Notices
70	Protection of personal information
71	Type and specification
72	Index

Managing contacts in your phonebook

Contacts can be stored in either your phone's memory via **Phonebook** or on your SIM card via **SIM contacts**. Up to 500 contacts can be stored in the phonebook and up to 250 on your IsatPhone 2 SIM card. To view the contacts in your phone's memory, select **Contacts** from the main screen.

Creating a new contact

There are several ways to create a contact. From the main screen type in the number to save, including the full international code. Select **Options > Add to contacts > Create new contact**. Define the number you are saving, eg. **Telephone, Office phone, Mobile phone, Fax** etc, then select **Options > Save**. The saved contact details are displayed.

Alternatively, open the contacts directory either by selecting **Menu > Contacts** or by selecting **Contacts**. Highlight the location where you wish to save the contact and press **Select**. The default setting is **Phonebook**. You are presented with a list of stored contacts, select **Options > New contact**. Enter the first name, last name and the telephone number. If you wish to save a contact detail other than phone number, select **Options > Add detail** and select from the list presented. After entering all relevant details, select **Options > Save** or press the centre selection key.

Finding a contact

You can find a contact in your phonebook either by using the navigation keys to scroll through the list of all contacts or by entering the first characters of a contact's name in the search field at the top of the list of contacts. See Entering text on [page 28](#) for more information.

Opening a contact

Highlight the contact's name in the phonebook and press the centre selection key or select **Options > Open**. Use the up and down navigation keys to select a number.

Ordering contacts by first or last name

Select **Phonebook > Options > Settings > Display name order** and then select either **First last** (to list them alphabetically by first name) or **Last first** (to list them alphabetically by last name).

2	Welcome
3	Safety
6	Quick reference
9	Getting started
14	Using your IsatPhone 2
35	Location services
41	Phonebook & Contacts
41	Managing contacts in your phonebook
43	Managing contacts on your SIM card
43	Synchronising contacts with Outlook
43	Sending and receiving contact details
44	Your phone number
44	Your service provider number
44	Alarm
45	Data
46	Personal settings
53	Security
56	Troubleshooting
59	Care and maintenance
61	Regulatory and compliance
64	Disclaimer
65	Accessories
66	Export controls
67	Malware
68	Downloading content
69	Notices
70	Protection of personal information
71	Type and specification
72	Index

Editing a contact

To change or add details for a contact already in your phonebook, use the up and down navigation keys to highlight the contact, then select **Options** and select **Edit**. Move between the details using the navigation keys. Edit the text or numbers. See Entering text on [page 28](#) for more information. To save the changes to the contact, press the centre selection key and then select **Yes**. Or select **Options > Save > Yes**.

To discard changes, press the centre selection key and when prompted to save changes, select **No**. Alternatively, select **Options > Save > No**. See Entering text on [page 28](#) for more information.

Calling a contact

Highlight the contact's name and press the green key . If there is more than one number stored for that contact (eg. office and mobile) select one of them using the centre selection key.

Texting or emailing a contact

Highlight the contact's name, select **Options > Send message**. Select **Text message** or **Email** as appropriate. Write your message and select **Options > Send**. If you are sending a text message and there is more than one number stored for that contact select one using the centre selection key.

Deleting a contact

Select **Menu > Contacts** or press **Contacts**. Select from the list. Use the navigation keys to highlight the stored contact that you would like to delete. Select **Option > Delete**. You will be prompted to confirm the deletion by pressing **Yes**.

Deleting all contacts

Open your phonebook, select **Options**, select **Delete all** and then select **Yes**.

Duplicating a contact

Duplicating a contact can be a quick way to add a new contact with similar details to an existing one.

Highlight the contact you wish to duplicate, select **Options > Duplicate** and then amend the new contact's details. When you have finished, save the new contact by pressing the centre selection key followed by **Yes**.

2	Welcome
3	Safety
6	Quick reference
9	Getting started
14	Using your IsatPhone 2
35	Location services
41	Phonebook & Contacts
41	Managing contacts in your phonebook
43	Managing contacts on your SIM card
43	Synchronising contacts with Outlook
43	Sending and receiving contact details
44	Your phone number
44	Your service provider number
44	Alarm
45	Data
46	Personal settings
53	Security
56	Troubleshooting
59	Care and maintenance
61	Regulatory and compliance
64	Disclaimer
65	Accessories
66	Export controls
67	Malware
68	Downloading content
69	Notices
70	Protection of personal information
71	Type and specification
72	Index

Managing contacts on your SIM card

Contacts can be stored on your SIM card as well as in **Phonebook**. Storing contacts on your SIM card allows you to move contacts from one phone to another. Storing contacts on both the SIM card and the phonebook allows you to back-up your contacts.

To view the contacts on your SIM card, select **Menu > Contacts > SIM contacts**. You can navigate, edit, delete, make calls or send texts in exactly the same way as **Phonebook**.

To copy a contact from your SIM card to your phonebook highlight the contact in **SIM contacts**, select **Options** and select **Copy to phonebook**.

To copy all SIM card contacts to Phonebook, this option arises when the SIM card is inserted. The first time **Contacts** is accessed after inserting the SIM card, you will be prompted to **Copy SIM contacts to Phonebook** and to confirm the action. Please note that this process may take a little time.

To copy a contact from your phone's memory to your SIM card, select **Phonebook** and highlight the contact. Select **Options > Copy to SIM**.

To delete all contacts from your SIM card, select **Menu > Contacts > SIM contacts > Options > Delete all**.

To find out how many contacts are stored on your SIM card and how many more you can add, select **Menu > Contacts > SIM Contacts > Options > SIM details**.

Synchronising contacts with Outlook

The Contact Synchronisation Tool, supplied with your phone, enables you to transfer contact information held in Microsoft Outlook or Outlook Express on your PC with that stored on your phone. Run the USB drive, supplied with your phone, to download the Contact Synchronisation Tool and to access the "How to Synchronise your Contacts" guide. These are also downloadable from inmarsat.com/isatphone.

Sending and receiving contact details

To send a business card, highlight the appropriate contact in your phonebook or SIM contacts folder and select **Options > Send business card**. Select either **Text message** or **Email message**. A text or email message is displayed including all details stored for this contact in the body of the message. Enter the full international phone number of the recipient in the **To:** field or select **Options > Add recipient** to specify a stored contact. Select **Options > Send**.

When you receive a business card, it will appear as a normal message in your **Inbox**, but the title of the message will be **Business card**. Highlight the message and press the centre selection key or select **Options > Open**. The contact details are presented like any other entry in the phonebook. To save **Business card** details, select **Options > Create new** or **Update existing**.

Click to navigate

2	Welcome
3	Safety
6	Quick reference
9	Getting started
14	Using your IsatPhone 2
35	Location services
41	Phonebook & Contacts
41	Managing contacts in your phonebook
43	Managing contacts on your SIM card
43	Synchronising contacts with Outlook
43	Sending and receiving contact details
44	Your phone number
44	Your service provider number
44	Alarm
45	Data
46	Personal settings
53	Security
56	Troubleshooting
59	Care and maintenance
61	Regulatory and compliance
64	Disclaimer
65	Accessories
66	Export controls
67	Malware
68	Downloading content
69	Notices
70	Protection of personal information
71	Type and specification
72	Index

Business card details are saved to your phonebook. Once the details have been saved, the original message is deleted from your **Inbox**.

Your phone number

From the main screen, open **Info** by pressing the centre selection key and selecting **My phone number**.

Your phone number is usually programmed onto your SIM card by your service provider. If not, the entry will be blank. You can enter the number yourself by selecting **Menu > Contacts > My phone number**. If a SIM card is subsequently inserted with a stored phone number, your entry will be overwritten.

Your service provider number

Open **Info** by pressing the centre selection key and selecting **Service provider** or for full details select **Menu > Contacts > Service provider**. These details are programmed onto your SIM card and are not editable.

Alarm

You can use your phone as an alarm clock. When set, the alarm  icon is displayed on the status bar. The alarm will sound for 60 seconds at the same volume as the phone is set to ring. If you do not press a key while the alarm is sounding it will snooze for 9 minutes before sounding again. This will continue until you switch the alarm off.

Setting an alarm

Select **Menu > Alarm** and select the type of alarm. **Once alarm** sounds the next time the clock shows the selected time. **Recurrent alarm** sounds regularly, on selected days of the week. Enter the alarm time and select **OK**. If this is a recurrent alarm, use the navigation and centre selection keys to tick which days of the week it should sound, then select **OK**.

Silencing a ringing alarm

When the alarm sounds, select **Stop** or the centre selection key. If you press the right selection key **Snooze**, it will sound again in 9 minutes.

Cancelling an alarm

Select **Menu > Alarm**, select which alarm you would like to remove, then select **Options > Remove** and confirm your choice.

2	Welcome
3	Safety
6	Quick reference
9	Getting started
14	Using your IsatPhone 2
35	Location services
41	Phonebook & Contacts
45	Data
46	Personal settings
53	Security
56	Troubleshooting
59	Care and maintenance
61	Regulatory and compliance
64	Disclaimer
65	Accessories
66	Export controls
67	Malware
68	Downloading content
69	Notices
70	Protection of personal information
71	Type and specification
72	Index

Your phone can be used as a modem to send and receive low rate data. Typical low rate data applications include plain text email and small file attachments. Some Inmarsat service providers offer proprietary applications which have been optimised to operate with your phone. Contact your service provider for details.

To enable your handset for the data service:

- 1 Install the USB Drivers on your PC. To do this, run the USB Drivers supplied with your phone. Download the USB Drivers and access the “How to Install USB Drivers” guide. These are also downloadable from inmarsat.com/isatphone.
- 2 Place your phone on its side, raise the antenna and ensure the handset is ready for service.
- 3 Connect the handset to your PC using the USB cable.

- 4 Identify the modem COM port to which your phone is connected for the data service. The COM port number will be needed when you are using your data application. To do this, on your PC go to **Control Panel > Phone and Modem options** and select the **Modem** tab. You will see **IsatPhone 2 Modem** and the COM port eg. COM6. Or, go to **Control Panel > System** and select the **Hardware** tab. Click on **Device Manager** and scroll down to **Modems**. If your USB Drivers are installed you will see **IsatPhone 2 Modem**. Right click on **IsatPhone 2 Modem** and select **Properties**. You will see the Com port eg. COM6.
- 5 If you have not already done so, install your chosen data application and follow the onscreen instructions.

You only need carry out the steps above once. For all subsequent connections, enter your data application and follow the onscreen instructions.

2	Welcome
3	Safety
6	Quick reference
9	Getting started
14	Using your IsatPhone 2
35	Location services
41	Phonebook & Contacts
45	Data
46	Personal settings
46	Sounds, Ringtones and Profiles
47	Setting phone language
48	Setting date and time
49	Setting the time zone
49	Customising display settings
50	Setting up keypad lock
50	Setting up phone lock
50	Bluetooth
51	Operating a Closed User Group (CUG)
52	Reset all settings
53	Security
56	Troubleshooting
59	Care and maintenance
61	Regulatory and compliance
64	Disclaimer
65	Accessories
66	Export controls
67	Malware
68	Downloading content
69	Notices
70	Protection of personal information
71	Type and specification
72	Index

Sounds, Ringtones and Profiles

Your current sound profile is always displayed in the status bar of the main screen, and can also be accessed via **Info**.

To change your phone's sound profile, select **Menu > Profiles**, and highlight the one you want and press the centre selection key. There are four sound profiles:

- **General** – for everyday use
- **Silent** – no vibration or sound
- **Loud** – for noisy environments
- **Vibrate only** – vibration and no sound

You can customise any of these profiles by highlighting it, selecting **Options** and selecting **Personalise**. This allows you to change the following aspects of the sound profile:

- **Vibrate mode** – on or off
- **Alert volume** – sound level
- **Keypad volume** – sound level when a key is pressed
- **Alert ring mode** – constant, ring once, beep, silent or increasing volume
- **Ringtone** – the sound your phone makes when it receives a call
- **Key sound** – the sound your phone makes when a key is pressed
- **Message alert** – the sound your phone makes when it receives a text message

Highlight the setting you would like to change, press the left or centre selection key, use the navigation keys to alter the setting and press **Select**.

To restore the default settings for a sound profile, highlight the profile, select **Options > Reset to default**.

Selecting a ringtone

Each profile can play one of 8 ringtones to notify you of an incoming call.

Select **Menu > Profiles** and highlight the appropriate profile. Select **Options > Personalise > Ringtone** from the list and press **Select** or the centre selection key. The current ringtone for the profile is played and highlighted in the list. Use the navigation keys to highlight and hear the other ringtone files available. Press **Select** or the centre selection key to specify the highlighted ringtone.

If no sound is heard when you highlight a ringtone, the **Alert volume** for your profile may be set to 0. This is the default for both **Silent** and **Vibrate only**. To change the ringtone volume, select **Back** to return to **Profiles**. Highlight **Alert volume** and press **Select**.

2	Welcome
3	Safety
6	Quick reference
9	Getting started
14	Using your IsatPhone 2
35	Location services
41	Phonebook & Contacts
45	Data
46	Personal settings
46	Sounds, Ringtones and Profiles
47	Setting phone language
48	Setting date and time
49	Setting the time zone
49	Customising display settings
50	Setting up keypad lock
50	Setting up phone lock
50	Bluetooth
51	Operating a Closed User Group (CUG)
52	Reset all settings
53	Security
56	Troubleshooting
59	Care and maintenance
61	Regulatory and compliance
64	Disclaimer
65	Accessories
66	Export controls
67	Malware
68	Downloading content
69	Notices
70	Protection of personal information
71	Type and specification
72	Index

Allocating a unique ringtone to callers

You can allocate a specific ringtone to a contact. Regardless of the active profile, the allocated ringtone will be used for the specified caller, but the alert volume of the active profile will be respected.

Highlight the desired contact entry in your **Phonebook** or **SIM contacts** and press the centre selection key or select **Options > Open**. Highlight the relevant contact detail and select **Options > Assign ringtone**. From the list of available ringtones, highlight your preference and press **Select**. The name of the ringtone will be displayed under the contact detail specified.

To remove an associated ringtone, open the contact entry, highlight the ringtone and select **Options > Remove ringtone**.

Setting phone and writing language



The display and writing language of the phone can be changed by selecting **Menu > Settings > Language**. Highlight any of the following options and press **Select**:

- **Phone language** — to set the display language of the phone
- **Writing language** — to set the texting language of the phone
- **Predictive text** — to set the text editing mode for composing messages

Setting phone language

The first time you switch on your phone, you will be prompted to select the display language. You can change this at any time. Select **Menu > Settings > Language > Phone language**, highlight the desired language and press the left or centre selection keys.

If you do not understand your phone's current language setting, follow these directions to navigate to the **Phone language** menu.

- Press the red key  to return to the main screen
- Press the left selection key to go to the menu screen
- Press the down navigation key twice to highlight the **Settings**  icon
- Press the centre selection key to open **Settings**
- Press the down navigation key twice to highlight the **Language**  icon and press the centre selection key
- Press the centre selection key and use the navigation keys to highlight the correct language and press the centre selection key again to change the phone's language

Click to navigate

2	Welcome
3	Safety
6	Quick reference
9	Getting started
14	Using your IsatPhone 2
35	Location services
41	Phonebook & Contacts
45	Data
46	Personal settings
46	Sounds, Ringtones and Profiles
47	Setting phone language
48	Setting date and time
49	Setting the time zone
49	Customising display settings
50	Setting up keypad lock
50	Setting up phone lock
50	Bluetooth
51	Operating a Closed User Group (CUG)
52	Reset all settings
53	Security
56	Troubleshooting
59	Care and maintenance
61	Regulatory and compliance
64	Disclaimer
65	Accessories
66	Export controls
67	Malware
68	Downloading content
69	Notices
70	Protection of personal information
71	Type and specification
72	Index

Setting writing language

Select **Menu > Settings > Language > Writing language**. Select the desired language and press **OK**.

Setting predictive text

The predictive text setting is used to set the text editing mode for composing messages. Select **Menu > Settings > Language > Predictive text**. Select **Available** or **Hidden**. The default setting is available. See Using predictive text entry on [page 28](#) for more details.

Changing keypad

Your phone is supplied with a Latin keypad as standard. Dual-alphabet keypads are available in Latin with Arabic, Japanese or Russian characters. If your phone does not have your preferred keypad, contact your service provider.

Setting date and time

Your phone automatically receives UTC time from GPS satellites. The first time you use your phone, you will be prompted to select a language from the list, followed by the option to select your local time. When completed, local time will be displayed on the status bar.

You will need to reset the time when you travel to different time zones. The **Date and time** menu lets you change the date and time format.

Setting the time

Select **Menu > Extras > Date and time > Time settings**.

Setting the date

Select **Menu > Extras > Date and time > Date settings**.

2	Welcome
3	Safety
6	Quick reference
9	Getting started
14	Using your IsatPhone 2
35	Location services
41	Phonebook & Contacts
45	Data
46	Personal settings
46	Sounds, Ringtones and Profiles
47	Setting phone language
48	Setting date and time
49	Setting the time zone
49	Customising display settings
50	Setting up keypad lock
50	Setting up phone lock
50	Bluetooth
51	Operating a Closed User Group (CUG)
52	Reset all settings
53	Security
56	Troubleshooting
59	Care and maintenance
61	Regulatory and compliance
64	Disclaimer
65	Accessories
66	Export controls
67	Malware
68	Downloading content
69	Notices
70	Protection of personal information
71	Type and specification
72	Index

Setting the time zone

You may wish to change the local time zone on your phone if you move to a new location or if your new phone is not displaying the correct time zone. You may also wish to know the time in another location, eg. your head office.

Setting the local time zone

Select **Menu > Extras > World time**. The world time map appears. Select **Options > Select > Local time zone**. Use the navigation keys to highlight the required time zone and press **Select**.

Setting the remote time zone

Select **Menu > Extras > World time**. Select **Options > Select remote time zone**. Use the navigation keys to highlight the required time zone and press **Select**.

Setting daylight saving time (DST)

Select **Menu > Extras > World time**. Select **Options** and select from a list to enable/disable local/remote DST. DST is displayed as **0** or **+1** on the world map.

Customising display settings



Lighting the keypad and screen

The backlights for the screen and keypad can be controlled by going to select **Menu > Settings > Display**. Select any one of the following options and press **Select** to save your changes.

- **Brightness** – to set the brightness of the screen
- **Screen light** – to set the duration for screen backlights
- **Keypad light** – to set the duration for keypad backlight
- **Screen standby** – to set the duration for the screen backlights after the last keystroke

2	Welcome
3	Safety
6	Quick reference
9	Getting started
14	Using your IsatPhone 2
35	Location services
41	Phonebook & Contacts
45	Data
46	Personal settings
46	Sounds, Ringtones and Profiles
47	Setting phone language
48	Setting date and time
49	Setting the time zone
49	Customising display settings
50	Setting up keypad lock
50	Setting up phone lock
50	Bluetooth
51	Operating a Closed User Group (CUG)
52	Reset all settings
53	Security
56	Troubleshooting
59	Care and maintenance
61	Regulatory and compliance
64	Disclaimer
65	Accessories
66	Export controls
67	Malware
68	Downloading content
69	Notices
70	Protection of personal information
71	Type and specification
72	Index

Setting up keypad lock

The keypad lock disables the keypad and prevents accidental dialling. When activated, the phone will respond to the green  and red keys  to answer or reject call.

Select **Menu > Settings > Security**, select **Automatic keypad lock**, and then select the duration before the keypad is locked. Deactivate the automatic keypad lock using the same menu.

To lock the keypad, ensure the main screen is displayed, press the centre selection key followed by the * key within 3 seconds. The keypad locked  icon is displayed on the status bar.

To unlock the keypad, press the centre selection key followed by the * key on the keypad within 3 seconds.

Setting up phone lock

Phone lock protects your phone against unauthorised use.

Select **Menu > Settings > Security** and select **Phone lock**. Specify the idle period, from 30 seconds to 30 minutes, after which time the phone will automatically lock. You will be prompted to **Enter phone lock code**. To unlock the phone, enter the code when prompted. The default admin code is 123456. See Setting up the admin code on [page 54](#). The new setting will be accepted when the code is accepted.

Bluetooth

The Bluetooth connection on your phone allows you to connect wirelessly to a Bluetooth headset enabling you to use the phone in handsfree mode.

To activate Bluetooth connectivity select **Menu > Settings > Bluetooth**. Select **Settings > Bluetooth** and select **On**. The Bluetooth  icon indicator appears in the status bar.

Connecting a new Bluetooth device

The first time you use a particular Bluetooth headset with your phone, you will need to pair the phone and the headset. Ensure the Bluetooth headset is switched on before you begin.

Select **Menu > Settings > Bluetooth > Paired devices**. A list of Bluetooth devices in range of your phone will appear on the screen. If the device does not appear, select **Options** and select **Search for devices** from the new menu that appears. **Searching...** will be displayed at the top of the screen, followed by the names of all the devices in range. A blue tick will be displayed next to any devices already paired with your phone.

Select the device you want to pair and enter its pass code. Bluetooth devices such as headsets generally have their pass code set in the factory and printed either on the device or its packaging. Some devices allow you to set the pass code yourself.

2	Welcome
3	Safety
6	Quick reference
9	Getting started
14	Using your IsatPhone 2
35	Location services
41	Phonebook & Contacts
45	Data
46	Personal settings
46	Sounds, Ringtones and Profiles
47	Setting phone language
48	Setting date and time
49	Setting the time zone
49	Customising display settings
50	Setting up keypad lock
50	Setting up phone lock
50	Bluetooth
51	Operating a Closed User Group (CUG)
52	Reset all settings
53	Security
56	Troubleshooting
59	Care and maintenance
61	Regulatory and compliance
64	Disclaimer
65	Accessories
66	Export controls
67	Malware
68	Downloading content
69	Notices
70	Protection of personal information
71	Type and specification
72	Index

The device should now be listed in the **Paired devices** menu. Highlight it and press the left selection key, then select **Connect** from the menu. The device should now be listed on the **Connected devices** menu accessed from the **Bluetooth** menu. This  icon indicates that your phone is connected with a Bluetooth headset.

Whenever the device attempts to make a connection with your phone, you will be prompted whether you want to accept the connection. To automatically accept connection requests from a particular device, highlight it in the **Paired devices** menu, select **Options** and select **Set as authorised**. You should only authorise devices that belong to you, or that you trust. If you no longer want a device to be authorised, select **Set as unauthorised**.

To connect a different headset, you must disconnect the current headset. Highlight the device on the **Connected devices** menu, select **Options** and select **Disconnect**.

If you no longer want a headset to be paired with your phone, highlight it on the **Paired devices** menu, select **Options** and then select **Delete**.

Other choices in the **Options** menu are **Rename**, which allows you to select a more descriptive name for your headset, and **Device attribute**, which displays the headset's name, and the time and date at which it was connected.

When you are not using Bluetooth connectivity, select **Bluetooth > Off** or **My phone's visibility > Invisible**. This prevents unauthorised connection. Do not pair with an unknown device.

Setting up Bluetooth lock

If Bluetooth lock is enabled, the phone will require the admin code to be entered before Bluetooth settings can be changed. See Setting up the admin code on [page 54](#) for more information. The default setting is off.

To enable or disable this feature, select **Menu > Settings > Security** and select **Bluetooth lock** from the list. Select **On** or **Off** and then enter **Admin code**.

Operating a Closed User Group (CUG)

The Closed User Group (CUG) service allows you to form closed user groups from which access is restricted. A user may be a member of one or more CUGs. Members of a specific CUG can communicate amongst themselves but not, in general, with users outside the group. This feature is operated by your service provider who will provide further instructions on its use. The default setting is off.

To enable, select **Menu > Settings > Security > Closed user group**, select **On**, enter your **CUG number** and press **OK**.

Group numbers range from 0-9. If the CUG is on, the CUG index  icon appears on the status bar.

Click to navigate

2	Welcome
3	Safety
6	Quick reference
9	Getting started
14	Using your IsatPhone 2
35	Location services
41	Phonebook & Contacts
45	Data
46	Personal settings
46	Sounds, Ringtones and Profiles
47	Setting phone language
48	Setting date and time
49	Setting the time zone
49	Customising display settings
50	Setting up keypad lock
50	Setting up phone lock
50	Bluetooth
51	Operating a Closed User Group (CUG)
52	Reset all settings
53	Security
56	Troubleshooting
59	Care and maintenance
61	Regulatory and compliance
64	Disclaimer
65	Accessories
66	Export controls
67	Malware
68	Downloading content
69	Notices
70	Protection of personal information
71	Type and specification
72	Index

Reset all settings

Select **Menu > Settings > Reset settings**. You will be prompted for the **Admin code** in order to make this change. See Setting up admin code on [page 54](#) for more information. Returning to default settings will not affect your admin or user codes, PINs, organiser entries, contacts, messages or call logs. To return these to default setting or to delete these entries see:

- Setting up SIM PIN code on [page 55](#)
- Setting up SIM PIN 2 code on [page 55](#)
- Deleting a contact on [page 42](#)
- Deleting SIM contacts on [page 43](#)
- Deleting messages on [page 32](#)
- Deleting all call logs on [page 23](#)

Click to navigate

2	Welcome
3	Safety
6	Quick reference
9	Getting started
14	Using your IsatPhone 2
35	Location services
41	Phonebook & Contacts
45	Data
46	Personal settings
53	Security
53	Security locks and codes
54	Security features controlled by the phone
55	Security features controlled by the SIM card
55	Security features controlled by the network
56	Troubleshooting
59	Care and maintenance
61	Regulatory and compliance
64	Disclaimer
65	Accessories
66	Export controls
67	Malware
68	Downloading content
69	Notices
70	Protection of personal information
71	Type and specification
72	Index

Security locks and codes

SECURITY FEATURES CONTROLLED BY	ACTION	DEFAULT SETTING	DEFAULT CODE	CODE LENGTH
The Phone				
Keypad lock	Only the green and red keys are active		Centre selection key and *	
Admin code	Creates Phone lock Restricts access to Bluetooth Restricts access to Reset settings Restricts access to Personal alert Creates User code	Off	123456	6 digits
<hr/>				
The SIM card				
PIN	Restricts access to SIM card	Off	8888	4-8 digits
PIN 2	Rest Restricts access to Fixed number dialling	Off	9999	4-8 digits
<hr/>				
The network				
Barring password	Restricts access to Call barring	Off	0000	4 digits

Click to navigate

2	Welcome
3	Safety
6	Quick reference
9	Getting started
14	Using your IsatPhone 2
35	Location services
41	Phonebook & Contacts
45	Data
46	Personal settings
53	Security
53	Security locks and codes
54	Security features controlled by the phone
55	Security features controlled by the SIM card
55	Security features controlled by the network
56	Troubleshooting
59	Care and maintenance
61	Regulatory and compliance
64	Disclaimer
65	Accessories
66	Export controls
67	Malware
68	Downloading content
69	Notices
70	Protection of personal information
71	Type and specification
72	Index

Security can be controlled by the phone, the SIM card or the Inmarsat network. This enables you to match security requirements to your needs. The keypad lock prevents accidental dialling; the phone lock prevents an unauthorised user from using your phone even if they replace the SIM card. The SIM PIN prevents an unauthorised user from using your SIM even if they place it in another phone. The admin code restricts access to particular features on the phone. For example, an individual might only wish to activate the keypad lock. A corporate organisation might choose to restrict functions available to their employees by activating the admin code and issuing a user code.

Security features controlled by the phone

Access to your phone can be restricted by the keypad lock to prevent accidental dialling (see Setting up keypad lock on [page 50](#) for more information) or by activation of the admin code.

The admin code can be activated: to create a **Phone lock**; restrict access to **Bluetooth lock**, **Personal alert lock** and **Reset settings**; and to create a **User code** so that a third party can use the phone but not have access to the restricted features. See Setting up Bluetooth lock on [page 50](#) and Reset all settings on [page 52](#) for more information.

Setting up the admin code

Select **Menu > Settings > Security** and select **Admin code**. You will be prompted for the current code. The default setting is 123456. When this is accepted, you will be prompted to enter your new code and then confirm it. The code must be 6 digits long. If you lose your admin code, contact your service provider. The default setting is off.

The admin code can be entered incorrectly an unlimited number of times. If you have forgotten your code, contact your service provider.

Setting up the user code

Select **Menu > Settings > Security** and select **User code**. You will be prompted to enter the 6-digit **Admin code**. Once this is accepted, you will be prompted to create a new user code and to confirm it. The code can be 4–6 digits in length. The default setting is off. The user code can be entered incorrectly an unlimited number of times. If you have forgotten your code, contact your phone's administrator.

2	Welcome
3	Safety
6	Quick reference
9	Getting started
14	Using your IsatPhone 2
35	Location services
41	Phonebook & Contacts
45	Data
46	Personal settings
53	Security
53	Security locks and codes
54	Security features controlled by the phone
55	Security features controlled by the SIM card
55	Security features controlled by the network
56	Troubleshooting
59	Care and maintenance
61	Regulatory and compliance
64	Disclaimer
65	Accessories
66	Export controls
67	Malware
68	Downloading content
69	Notices
70	Protection of personal information
71	Type and specification
72	Index

Security features controlled by the SIM card

Access to your SIM card can be restricted by activating its PIN code. The advanced call feature, **Fixed number dialling**, can be protected by your SIM PIN 2 code. See **Fixed number dialling** on [page 26](#) for more information.

Setting up SIM PIN code

Select **Menu > Settings > Security > PIN request** and select **On**. You will be asked to enter your SIM's PIN code. If you make an error entering the number, press **Cancel** to clear the digits and re-enter. Press the centre selection key or **OK**. The default 4-8 digit code for SIM PIN is **8888**. The default setting is off.

To change the PIN code stored on your SIM card, select **Menu > Settings > Security > Set PIN**. Enter the existing PIN code, then the new PIN. Repeat the new PIN to confirm it.

If the PIN code is entered incorrectly three times, your SIM card can only be unlocked using the PUK code. Contact your service provider if you do not have a record of your PUK code. If the PUK code is entered 10 times incorrectly the SIM will lock and you should contact your service provider. The default setting for PIN is off.

Setting up SIM PIN 2 code

The default 4-8 digit code for PIN 2 is **9999**. The default setting is off.

If the PIN 2 code is entered incorrectly three times, your SIM card can only be unlocked using the PUK 2 code. Contact your service provider if you do not have a record of your PUK 2. If the PUK 2 code is entered 10 times incorrectly the SIM will lock and you should contact your service provider. To change the PIN 2 code, select **Menu > Settings > Security > Set PIN 2**. Enter the existing PIN 2 code, then the new PIN 2 code. Repeat the new PIN 2 code to confirm it.



Security features controlled by the network

When enabled, the advanced call feature, **Call barring**, is protected by a code. The default setting is off. See **Call barring** on [page 24](#) for more information.

- 2 Welcome
- 3 Safety
- 6 Quick reference
- 9 Getting started
- 14 Using your IsatPhone 2
- 35 Location services
- 41 Phonebook & Contacts
- 45 Data
- 46 Personal settings
- 53 Security
- 56 Troubleshooting
- 59 Care and maintenance
- 61 Regulatory and compliance
- 64 Disclaimer
- 65 Accessories
- 66 Export controls
- 67 Malware
- 68 Downloading content
- 69 Notices
- 70 Protection of personal information
- 71 Type and specification
- 72 Index

PROBLEM	SOLUTION
My phone will not switch on	<ul style="list-style-type: none"> Check if the battery is inserted correctly Check if the battery needs charging. Charging for 20 minutes should provide enough power to switch the phone on If the battery does not charge it has probably exceeded its usage period and you will need to replace it with a new one
My phone cannot make or receive calls	<ul style="list-style-type: none"> Ensure the SIM card is inserted in the phone and is fully provisioned by your service provider Check you have a valid GPS fix (See Using your GPS location information on page 38 for more information) Ensure the phone’s antenna is fully extended and you have a clear line of sight to the satellite. See Connecting to the satellite on page 14 for more information. A least two signal bars are required to make and receive calls If you have less than two bars signal strength, rotate the phone and angle the antenna until the signal strength increases and you are able to make and receive calls If the phone has sufficient signal strength and cannot make or receive calls, check if Call barring (page 24), Diverting calls (page 25) or Fixed number dialling (page 26) have been activated If you have a prepay subscription, check your prepay balance to ensure you have sufficient credit to make a call. See Making a balance enquiry on page 34 for more information Contact your service provider if you are unable to resolve the problem

2	Welcome
3	Safety
6	Quick reference
9	Getting started
14	Using your IsatPhone 2
35	Location services
41	Phonebook & Contacts
45	Data
46	Personal settings
53	Security
56	Troubleshooting
59	Care and maintenance
61	Regulatory and compliance
64	Disclaimer
65	Accessories
66	Export controls
67	Malware
68	Downloading content
69	Notices
70	Protection of personal information
71	Type and specification
72	Index

PROBLEM	SOLUTION
My phone cannot receive a text message	<ul style="list-style-type: none"> The phone can store a maximum of 20 messages in its memory. If the memory is full, delete a few texts to free up memory for new messages. See Deleting messages on page 32 for more information If you still cannot receive a text, your service centre number may not be correct. See Entering your service centre number on page 33 for more information or contact your service provider
My phone continues to display Searching satellite...	<ul style="list-style-type: none"> Ensure your phone's antenna is fully extended Ensure your phone's antenna is pointed towards the satellite. Press Help for onscreen guidance. Consult the Coverage map on page 9 to ensure you are within coverage Ensure there is a clear line of sight to the satellite with no obstacles which could block the signal. See Connecting to the satellite on page 14 for more information Contact your service provider if you are unable to resolve the problem
My phone displays a language I do not understand	<ul style="list-style-type: none"> Press the red key  to return to the main screen Press the left selection key to go to the menu screen Press the down navigation key twice to highlight the Settings  icon Press the centre selection key to open Settings Press the down navigation key twice to highlight the Language  icon and press the centre selection key Press the centre selection key and use the navigation keys to highlight the correct language and press the centre selection key again to change the phone's language

- 2 Welcome
- 3 Safety
- 6 Quick reference
- 9 Getting started
- 14 Using your IsatPhone 2
- 35 Location services
- 41 Phonebook & Contacts
- 45 Data
- 46 Personal settings
- 53 Security
- 56 Troubleshooting
- 59 Care and maintenance
- 61 Regulatory and compliance
- 64 Disclaimer
- 65 Accessories
- 66 Export controls
- 67 Malware
- 68 Downloading content
- 69 Notices
- 70 Protection of personal information
- 71 Type and specification
- 72 Index

PROBLEM	SOLUTION
My phone does not display a GPS position	<ul style="list-style-type: none">Some national policies do not allow users to access their GPS information in particular locations. Your phone continues to access the GPS satellites as usual, but your phone will not display its GPS location
My phone does not seem to receive voicemails	<ul style="list-style-type: none">Ensure your service provider has enabled voicemail
My phone and/or SIM has been lost or stolen	<ul style="list-style-type: none">Contact your service provider as soon as possible so your phone and/or SIM can be barred
How do I contact my service provider?	<ul style="list-style-type: none">Your service provider number is stored on your SIM card. To view your service provider open Info by pressing the centre selection key and selecting Service provider

2	Welcome
3	Safety
6	Quick reference
9	Getting started
14	Using your IsatPhone 2
35	Location services
41	Phonebook & Contacts
45	Data
46	Personal settings
53	Security
56	Troubleshooting
59	Care and maintenance
59	Caring for your IsatPhone 2
60	Certifications
61	Regulatory and compliance
64	Disclaimer
65	Accessories
66	Export controls
67	Malware
68	Downloading content
69	Notices
70	Protection of personal information
71	Type and specification
72	Index

Caring for your IsatPhone 2

Your IsatPhone is a highly sophisticated electronic device. Complying with the following recommendations will help you to protect your warranty coverage and extend your phone's life:

- Keep your phone dry. Liquids or moisture can contain minerals that will damage electronic circuits. If your phone does get wet, dry it with a soft absorbent cloth as soon as possible, remove the battery and allow your phone and battery to dry completely before replacing it
- The connector covers are intended to protect your phone. When the connectors are not in use, keep these covers firmly closed at all times. Ensure that the connectors are free from dust or dirt before connecting any accessory. When closing the connector cover, ensure the area around the connectors, and the rubber sealing surfaces of the cover are clean and free from dirt. Ensure that the cover is fully closed to give maximum protection to your phone
- Do not store your phone in dusty, dirty or damp areas as this may shorten its life
- Do not store your phone in direct sunlight, or in places where the sun's heat can be focused, like on the dashboard of a vehicle
- Do not store your phone and battery in extreme cold and hot areas exceeding a temperature range of -20°C to $+70^{\circ}\text{C}$ (-4°F to $+158^{\circ}\text{F}$). Extreme temperatures can shorten the life of your phone and damage the battery
- Your phone's operating temperature range is -20°C to $+55^{\circ}\text{C}$ (-4°F to $+131^{\circ}\text{F}$). The charging temperature range is 0°C to $+45^{\circ}\text{C}$ ($+32^{\circ}\text{F}$ to $+113^{\circ}\text{F}$)
- If you are carrying a separate battery, keep it inside the plastic bag supplied. Always keep batteries separated from other metallic objects and keep it dry to prevent damage
- If your phone displays **Battery overheating**, switch it off and place in a cool area
- Do not use harsh chemicals, cleaning solvents or strong detergents to clean your phone
- Do not paint your phone
- Do not attempt to disassemble your phone or undertake repairs yourself
- Use only the Inmarsat-supplied or an approved replacement antenna. Unauthorised antennas, modifications or attachments could damage the device and may violate regulations governing radio devices

2	Welcome
3	Safety
6	Quick reference
9	Getting started
14	Using your IsatPhone 2
35	Location services
41	Phonebook & Contacts
45	Data
46	Personal settings
53	Security
56	Troubleshooting
59	Care and maintenance
59	Caring for your IsatPhone 2
60	Certifications
61	Regulatory and compliance
64	Disclaimer
65	Accessories
66	Export controls
67	Malware
68	Downloading content
69	Notices
70	Protection of personal information
71	Type and specification
72	Index

- Use only Inmarsat-supplied or approved batteries, and recharge your battery with Inmarsat-supplied or approved chargers for the phone
- Do not store fully charged or low charge batteries for long periods of time without use. 80% charge is optimal for storage. The battery should be stored in dry conditions, not assembled into the handset, with the contacts protected. Ideal conditions are between -20 and +20 °C. Please check the remaining power levels in the battery and test the handset every three months. Recharge if the power has dropped below 40%. More frequent checking and recharging may be necessary depending on storage conditions. When the battery charge is very low, it may take some time for the charging indicator to show on the screen after connecting the charger. To view the battery % charge remaining, please look in **Settings > About**.
- Unplug the charger from the power socket and your phone when not in use. Do not leave a fully-charged battery connected to a charger, as overcharging may shorten its life. The battery can be charged and discharged hundreds of times, but it will eventually wear out. Batteries gradually lose their charge even when the phone is completely switched off. When the talk and standby times are noticeably shorter than normal, replace the battery

- When using any cable connections with your phone, ensure that it cannot be stepped on, tripped over or otherwise subjected to damage or stress
- Upgrade your phone's firmware when advised to do so by Inmarsat or your service provider

These suggestions apply equally to your phone, battery, chargers, and any accessory. If your phone is not working properly, contact your service provider.

Certifications

Your IsatPhone 2 is certified with an Ingress Protection rating of IP65, which means that your phone is resistant to dust and splashing.

- [2 Welcome](#)
- [3 Safety](#)
- [6 Quick reference](#)
- [9 Getting started](#)
- [14 Using your IsatPhone 2](#)
- [35 Location services](#)
- [41 Phonebook & Contacts](#)
- [45 Data](#)
- [46 Personal settings](#)
- [53 Security](#)
- [56 Troubleshooting](#)
- [59 Care and maintenance](#)
- [61 Regulatory and compliance](#)
 - [61 European declaration of conformity and CE marking](#)
 - [62 FCC Part 15 declaration](#)
 - [62 GMPCS](#)
 - [62 Industry Canada](#)
 - [63 Disposal of electrical and electronic equipment and batteries within the European Economic Area](#)
 - [63 RoHS compliance](#)
 - [63 REACH Regulations](#)
- [64 Disclaimer](#)
- [65 Accessories](#)
- [66 Export controls](#)
- [67 Malware](#)
- [68 Downloading content](#)
- [69 Notices](#)
- [70 Protection of personal information](#)
- [71 Type and specification](#)
- [72 Index](#)

European declaration of conformity and CE marking



Inmarsat Global Limited hereby declares that IsatPhone 2 is in conformity with the essential requirements and other relevant provisions of the Radio Equipment Directive (2014/53/EU) and the Recast Restriction on Hazardous Substances Directive (2011/65/EU).

A copy of the original Declaration of Conformity can be found at: inmarsat.com/service/isatphone2/ under 'Specifications'.

IsatPhone 2 is in conformity with the following standards and/or normative documents:

Health and Safety: IEC 60950-1:2005 + AMD1:2009 + AMD2:2013, IEC 62368-1:2014, EN 50360:2017.

EMC: EN 301 489-1 V2.1.1 (2016-11), EN 301 489-17 V3.1.1 (2017-02), EN 301 489-19 V2.1.0 (2017-03), EN 301 489-20 V1.2.1 (2002-11), EN 55032:2015.

Spectrum: EN 301 681 V2.1.2 (2016-11), EN 303 413 V1.1.1 (2017-06), EN 300 328 V2.1.1 (2016-11).

The technical files relevant to the above declaration are held at Inmarsat Global Limited, 99 City Road, London EC1Y 1AX, United Kingdom.

Inmarsat IsatPhone 2 is capable of operating in frequency range of 1626.5-1660.5MHz - 1668-1675MHz, which has geographical and region-based restrictions in the countries mentioned in table on the right. The terminal's frequency assignment is controlled by the network. Where restrictions apply, the network will not assign restricted frequencies to the terminal. The user is not required to take any action regarding restricted frequencies.



BE	FI	FR
DE	HU	IT
LT	SK	UK

2	Welcome
3	Safety
6	Quick reference
9	Getting started
14	Using your IsatPhone 2
35	Location services
41	Phonebook & Contacts
45	Data
46	Personal settings
53	Security
56	Troubleshooting
59	Care and maintenance
61	Regulatory and compliance
61	European declaration of conformity and CE marking
62	FCC Part 15 declaration
62	GMPCS
62	Industry Canada
63	Disposal of electrical and electronic equipment and batteries within the European Economic Area
63	RoHS compliance
63	REACH Regulations
64	Disclaimer
65	Accessories
66	Export controls
67	Malware
68	Downloading content
69	Notices
70	Protection of personal information
71	Type and specification
72	Index

FCC Part 15 declaration

IsatPhone 2 complies with Part 15 of the FCC Rules and, as such, operation is subject to the following two conditions:

- 1 This device may not cause harmful interference, and
- 2 This device must accept any interference received, including interference that may cause undesired operation

Note: This equipment has been tested and found to comply with the limits of a Class B digital device, pursuant to Part 15 of the FCC Rules. These limits are designed to provide reasonable protection against harmful interference when the equipment is operated in a residential environment. This equipment generates, uses, and radiates radio frequency energy, and if not installed and used in accordance with the instructions, may cause harmful interference.

If this equipment does cause interference to radio or television reception, which can be determined by turning the equipment off and on, the user is encouraged to try to correct the interference as follows:

- Reorient or relocate the receiving antenna
- Increase the separation between the equipment and the receiver

- Connect the equipment into an outlet on a circuit different from that to which the receiver is connected
- Consult the dealer or an experienced radio/TV technician for help

FCC caution: Under 47 CFR §15.21, changes or modifications not expressly approved by the manufacturer could void the user's authority to operate the equipment.

GMPCS

IsatPhone 2 carries the International Telecommunication Union (ITU) Global Mobile Personal Communications by Satellite (GMPCS)-MoU mark.

Industry Canada

This Class B digital apparatus complies with Canadian ICES-003, CAN ICES-3 (B)/NMB-3(B).

2	Welcome
3	Safety
6	Quick reference
9	Getting started
14	Using your IsatPhone 2
35	Location services
41	Phonebook & Contacts
45	Data
46	Personal settings
53	Security
56	Troubleshooting
59	Care and maintenance
61	Regulatory and compliance
61	European declaration of conformity and CE marking
62	FCC Part 15 declaration
62	GMPCS
62	Industry Canada
63	Disposal of electrical and electronic equipment and batteries within the European Economic Area
63	RoHS compliance
63	REACH Regulations
64	Disclaimer
65	Accessories
66	Export controls
67	Malware
68	Downloading content
69	Notices
70	Protection of personal information
71	Type and specification
72	Index

Disposal of electrical and electronic equipment and batteries within the European Economic Area

Directive 2012/19/EU regulates the disposal of electrical and electronic equipment in the EU and Directive 2006/66/EC regulates the manufacture and disposal of batteries in the EU. Inmarsat intends to join an EU certified Producer Compliance Scheme (PCS) to meet its obligations as a producer under these Directives.

Electronic equipment and batteries should not be included as household waste but should be left at an appropriate collection point for recycling. This helps prevent potential negative consequences for the environment and human health. Check local regulations by contacting your local city office, your household waste disposal service, the vendor of your phone or calling Inmarsat's or your local service provider's call centre. Do not attempt to remove internal batteries. Internal batteries shall be removed only by a waste treatment facility or trained service professional.



The crossed out wheeled-bin symbol on IsatPhone 2 and its rechargeable battery reminds you that all electrical and electronic products and batteries must be taken to separate collections at the end of their working life. This applies to the EU and other locations where separate collection systems are available.

Please note that lithium ion batteries meet the definition of dangerous goods in international transport legislation and therefore customers must check with the relevant postal operator before posting any batteries.

RoHS compliance

IsatPhone 2 complies with the EC Directive on the restriction of the use of certain hazardous substances in electrical and electronic equipment 2011/65/EU (RoHS Recast).

REACH Regulations

IsatPhone 2 complies with the EC Regulation on Registration, Evaluation, Authorisation and Restriction of Chemicals No. 1907/2006 (REACH).

Click to navigate

2	Welcome
3	Safety
6	Quick reference
9	Getting started
14	Using your IsatPhone 2
35	Location services
41	Phonebook & Contacts
45	Data
46	Personal settings
53	Security
56	Troubleshooting
59	Care and maintenance
61	Regulatory and compliance
64	Disclaimer
65	Accessories
66	Export controls
67	Malware
68	Downloading content
69	Notices
70	Protection of personal information
71	Type and specification
72	Index

This User Guide is published by Inmarsat without any warranty. Except as provided by applicable law and in the IsatPhone 2 end-user Warranty, no warranties of any kind, either express or implied, including, without limitation, the implied warranties of satisfactory quality, merchantability and fitness for a particular purpose, are made in relation to the accuracy, reliability or completeness of this User Guide. Inmarsat reserves the right to make changes to this User Guide at any time and without prior notice.

All illustrations are for illustration only and are not an accurate depiction of an actual IsatPhone 2.

All rights are reserved.

Click to navigate

2	Welcome
3	Safety
6	Quick reference
9	Getting started
14	Using your IsatPhone 2
35	Location services
41	Phonebook & Contacts
45	Data
46	Personal settings
53	Security
56	Troubleshooting
59	Care and maintenance
61	Regulatory and compliance
64	Disclaimer
65	Accessories
66	Export controls
67	Malware
68	Downloading content
69	Notices
70	Protection of personal information
71	Type and specification
72	Index

Inmarsat provides the following in-box accessories with the IsatPhone 2:

- Battery
- USB drive
- Mains charger and four universal plug adaptors
- Car charger
- Micro USB cable
- Wired handsfree headset
- Wrist strap
- Holster

Inmarsat reserves the right to add or delete accessories from this list at our absolute discretion.

Click to navigate

2	Welcome
3	Safety
6	Quick reference
9	Getting started
14	Using your IsatPhone 2
35	Location services
41	Phonebook & Contacts
45	Data
46	Personal settings
53	Security
56	Troubleshooting
59	Care and maintenance
61	Regulatory and compliance
64	Disclaimer
65	Accessories
66	Export controls
67	Malware
68	Downloading content
69	Notices
70	Protection of personal information
71	Type and specification
72	Index

IsatPhone 2 and in-box accessories may contain commodities, technology and/or software subject to export controls and regulations imposed by the US and other countries. Diversion contrary to law is prohibited.

Click to navigate

2	Welcome
3	Safety
6	Quick reference
9	Getting started
14	Using your IsatPhone 2
35	Location services
41	Phonebook & Contacts
45	Data
46	Personal settings
53	Security
56	Troubleshooting
59	Care and maintenance
61	Regulatory and compliance
64	Disclaimer
65	Accessories
66	Export controls
67	Malware
68	Downloading content
69	Notices
70	Protection of personal information
71	Type and specification
72	Index

Malicious software (also commonly referred to as malware) is software that can harm the phone or other computers. Malware or harmful applications can include viruses, worms, spyware, and other unwanted programmes.

While the phone does employ security measures to resist such efforts, Inmarsat does not warrant or represent that the phone will be impervious to the introduction of malware. You can, however, reduce the risk of malware attacks by exercising care when downloading content or accepting applications, refraining from opening or responding to messages from unknown sources, using trustworthy services to access the Internet, and only downloading content to IsatPhone 2 from known, reliable sources.

Click to navigate

2	Welcome
3	Safety
6	Quick reference
9	Getting started
14	Using your IsatPhone 2
35	Location services
41	Phonebook & Contacts
45	Data
46	Personal settings
53	Security
56	Troubleshooting
59	Care and maintenance
61	Regulatory and compliance
64	Disclaimer
65	Accessories
66	Export controls
67	Malware
68	Downloading content
69	Notices
70	Protection of personal information
71	Type and specification
72	Index

IsatPhone 2 has the capability to download, store and forward additional content. The use of such content may be restricted or prohibited by rights of third parties, including but not limited to restriction under applicable copyright laws. You, and not Inmarsat, are entirely responsible for additional content that you download to or forward from your phone.

Prior to your use of any additional content, please verify that your intended use is properly licensed or is otherwise authorised. Inmarsat does not guarantee the accuracy, integrity or quality of any additional content or any other third party content.

Under no circumstances will Inmarsat be liable in any way for your improper use of additional content or other third party content.

Click to navigate

2	Welcome
3	Safety
6	Quick reference
9	Getting started
14	Using your IsatPhone 2
35	Location services
41	Phonebook & Contacts
45	Data
46	Personal settings
53	Security
56	Troubleshooting
59	Care and maintenance
61	Regulatory and compliance
64	Disclaimer
65	Accessories
66	Export controls
67	Malware
68	Downloading content
69	Notices
70	Protection of personal information
71	Type and specification
72	Index

INMARSAT is a registered trademark of the International Mobile Satellite Organisation; the Inmarsat LOGO is a registered trademark of Inmarsat (IP) Company Limited. Both trademarks are licensed to Inmarsat Global Limited.

Bluetooth is a trademark or a registered trademark of Bluetooth SIG Inc. and any use of such mark by Inmarsat is under licence.

Microsoft Outlook, Microsoft Outlook Express, Microsoft Windows 10, Microsoft Windows 8, Microsoft Windows 7, Microsoft Windows XP Pro SP3 are trademarks or registered trademarks of Microsoft Corporation in the United States and other countries.

Other product and company names mentioned herein may be the trademarks of their respective owners.

Copyright © Inmarsat Global Limited 2018.

Click to navigate

2	Welcome
3	Safety
6	Quick reference
9	Getting started
14	Using your IsatPhone 2
35	Location services
41	Phonebook & Contacts
45	Data
46	Personal settings
53	Security
56	Troubleshooting
59	Care and maintenance
61	Regulatory and compliance
64	Disclaimer
65	Accessories
66	Export controls
67	Malware
68	Downloading content
69	Notices
70	Protection of personal information
71	Type and specification
72	Index

The user is advised to erase personal data before disposing of the phone. Deleting data from the phone memory does not ensure that it cannot be recovered. Accordingly, Inmarsat does not warrant against recovery of information.

Click to navigate

2	Welcome
3	Safety
6	Quick reference
9	Getting started
14	Using your IsatPhone 2
35	Location services
41	Phonebook & Contacts
45	Data
46	Personal settings
53	Security
56	Troubleshooting
59	Care and maintenance
61	Regulatory and compliance
64	Disclaimer
65	Accessories
66	Export controls
67	Malware
68	Downloading content
69	Notices
70	Protection of personal information
71	Type and specification
71	71 Specification for product
71	71 Specification for unit
72	Index

Specification for product

PRODUCT	MANUFACTURER	TYPE/MODEL	SPECIFICATION
Battery	Inmarsat	56426 702 098	3.7 V, 3180 mAh, 12 Wh, Li-ion
Charger	Phihong	PSM10R-050	Input = 100~240 V, 50/60 Hz, ~0.5A Output = 5 Vdc, 2 A MAX
	Shenzen Honor Electronic Co Ltd	ADS-6AE-06 05060E	Input = 100~240 V, 50/60 Hz, ≤ 0.3Arms Output = 5 Vdc, 1.2 A MAX
Car charger	Tenwei Electronics	Car adaptor	Input = 10-30 Vdc Output = 5 Vdc, 1.2 A

Specification for unit

UNIT	SPECIFICATION
Voltage	• Nominal battery voltage 3.7 V/900 mA
Current	• 900 mA
Operating temperature	• -20°C to +55°C (-4°F to +131°F)
Charging temperature	• 0°C to +45°C (+32°F to +113°F)
Transmitter output power GMR2+	• +33.5dBm 1626.5-1660.5MHz (normal band) • +31.0dBm 1668-1675MHz (extended band)
Transmitter output power Bluetooth	• +6.2dBm 2400-2480MHz

Click to navigate

2	Welcome
3	Safety
6	Quick reference
9	Getting started
14	Using your IsatPhone 2
35	Location services
41	Phonebook & Contacts
45	Data
46	Personal settings
53	Security
56	Troubleshooting
59	Care and maintenance
61	Regulatory and compliance
64	Disclaimer
65	Accessories
66	Export controls
67	Malware
68	Downloading content
69	Notices
70	Protection of personal information
71	Type and specification
72	Index
72	A B C
73	C D E F G
74	H I J K L M N O
75	P Q R S
76	S T U V W X Y Z

A

Accessories	65
Admin code	54
Alarm	
Cancelling	44
Setting	44
Silencing	44
Any key answer	23
Assistance button	
Activating an assistance button alert	36
Assistance button security	36
Configuring assistance button calls	35
Configuring assistance button messages	35
Enabling assistance button calling	35

B

Balance enquiry	34
Barring calls	24
Battery	
Charging	11
Inserting	10
Low battery alert	11
Removing	10
Bluetooth	
Connecting	50
Lock	51
Security	51
Business card	43

C

Caller ID	
Sending	24
Calls	
Barring	24
Conference	19
Declining	17
Delete call logs	23
Diverting	25
Emergency	19
From contacts	16
From received message	31
Handsfree	21
Length	22
Muting a call	21
Receiving a call	17
Receiving a second call	18
Returning	17
Summary	23
Volume control	21
While on another call	17
Call waiting	
Setting	24
Using	18
Charger	
Car	11
Mains	11
Solar	11
USB	11

Click to navigate

2	Welcome
3	Safety
6	Quick reference
9	Getting started
14	Using your IsatPhone 2
35	Location services
41	Phonebook & Contacts
45	Data
46	Personal settings
53	Security
56	Troubleshooting
59	Care and maintenance
61	Regulatory and compliance
64	Disclaimer
65	Accessories
66	Export controls
67	Malware
68	Downloading content
69	Notices
70	Protection of personal information
71	Type and specification
72	Index

- 72 A B C
- 73 C D E F G
- 74 H I J K L M N O
- 75 P Q R S
- 76 S T U V W X Y Z

Closed user group	
Operating	51
Code	
Admin	54
PUK	55
PUK 2	55
SIM PIN	55
SIM PIN 2	55
User	54
Conference calling	19
Contact	
Calling a contact	42
Creating	41
Deleting	42
Deleting all	42
Duplicating	42
Editing	42
Emailing	42
Finding	41
Opening	41
Ordering by first or last name	41
Texting	42
Copy SIM contacts to Phonebook	43
CUG	51
D	
Data	45
Date and time settings	48
Daylight saving time (DST)	49
Disclaimer	64
Display	
Customise settings	49
Diverting	
Calls	25

E	
eCompass function	
Finding a satellite	15
Improving signal strength	15
Emergency calling	19
Export controls	66
F	
Firmware version	13
Fixed number dialling	
Activating	26
De-activating	26
Using	26
G	
GPS	
Displaying in imperial	39
Displaying in metric	39
Fix	15
National policies	39
Obtaining a manual fix	39
Satellite	14
Sending your location	39
Viewing your location	38
Groups	
Add	32
Assign ringtone	32
Belongs to	32
Members	32
Remove	32
Sending texts to	32
View	32

Click to navigate

2	Welcome
3	Safety
6	Quick reference
9	Getting started
14	Using your IsatPhone 2
35	Location services
41	Phonebook & Contacts
45	Data
46	Personal settings
53	Security
56	Troubleshooting
59	Care and maintenance
61	Regulatory and compliance
64	Disclaimer
65	Accessories
66	Export controls
67	Malware
68	Downloading content
69	Notices
70	Protection of personal information
71	Type and specification
72	Index

- 72 A B C
- 73 C D E F G
- 74 H I J K L M N O**
- 75 P Q R S
- 76 S T U V W X Y Z

H

Handsfree calling	21
-------------------	----

I

IMEI number	12
IMSI number	12
Incoming call alerting	
Configuring the incoming call alerting feature	21
Missed incoming call alerts	20
Receiving an incoming call alert	20
Using incoming call alerting	20
Info	
Important information	12
IsatPhone	
Caring for	59

K

Keypad	
Changing	48
Light	49
Locking	50
Volume	46

L

Language	
Phone	47
Writing	48
Local time zone setting	49
Lock	
Bluetooth	51
Keypad	50
Phone	50
Loud profile	46
Loudspeaker	21

M

Mains charger	11
Map	8
Members	
Groups	32
Messages	
Concatenation	33
Create new	29
Creating text for sending to email	30
Delete	32
Expiry period	33
Forward	31
Groups	32
Receive	30
Reply	31
Service centre number	33
Setting	33
Validity	33
Viewing received messages	31
Message service centre number	33
Microsoft Outlook	9
Microsoft Outlook Express	9
Minute counter	22
Model	12
My phone number	44

N

Number	
Re-dial	17
Service provider	44
Your phone number	44

Click to navigate

2	Welcome
3	Safety
6	Quick reference
9	Getting started
14	Using your IsatPhone 2
35	Location services
41	Phonebook & Contacts
45	Data
46	Personal settings
53	Security
56	Troubleshooting
59	Care and maintenance
61	Regulatory and compliance
64	Disclaimer
65	Accessories
66	Export controls
67	Malware
68	Downloading content
69	Notices
70	Protection of personal information
71	Type and specification
72	Index
72	A B C
73	C D E F G
74	H I J K L M N O
75	P Q R S
76	S T U V W X Y Z

P

Pass code	
Call barring	24
Personal alert	
Sending a personal alert	40
Setting up and activating a personal alert	39
Personalising settings	46
Phone	
Language	12
Lock	50
Off	12
On	12
Upgrade	13
Phonebook	
Managing contacts	41
Phone language	
Setting	47
Predictive text	
Setting	48
Prepay	
Balance enquiry	34
Voucher redemption	34
Profiles	
General	46
Loud	46
Silent	46
Vibrate only	46
PUK 2 code	55
PUK code	55

R

Received messages	
Save details	31
Save message	31

Re-dial	
Auto	17
Remote time zone setting	49
Reset all settings	52
Ring mode	46
Ringtones	
Assign to groups	32
Unique	47

S

Satellite	14
Screen	
Brightness	49
Light	49
Lighting	49
Standby	49
Security	
Admin code	54
Network-controlled	55
Phone-controlled	54
SIM card-controlled	55
SIM PIN 2 code	55
SIM PIN code	55
User code	54
Service provider	44
SIM card	
Copying	43
Inserting	10
Subscription	9
SIM contacts	
Copying	43
SIM PIN 2 code	55
SIM PIN code	55

Click to navigate

2	Welcome
3	Safety
6	Quick reference
9	Getting started
14	Using your IsatPhone 2
35	Location services
41	Phonebook & Contacts
45	Data
46	Personal settings
53	Security
56	Troubleshooting
59	Care and maintenance
61	Regulatory and compliance
64	Disclaimer
65	Accessories
66	Export controls
67	Malware
68	Downloading content
69	Notices
70	Protection of personal information
71	Type and specification
72	Index
72	A B C
73	C D E F G
74	H I J K L M N O
75	P Q R S
76	S T U V W X Y Z

Solar charger	11
Sounds	
Ringtones	46
Specification and type	71
Speed dialling	
Removing	23
Setting up	23
Using	23
T	
Texts	
Entering	28
Predictive text	28
Selecting standard or predictive mode	29
Sending to group	32
Standard text	29
Time	
Daylight saving	49
Time zone	
Local	49
Remote	49
Setting	49
Tracking	
Choosing the message interval	38
Choosing the message recipients and message type	37
Configuring tracking	37
Starting tracking	38
Stopping tracking	38
Tracking feature	37
Tracking security	38
Troubleshooting	56
Type and specification	71

U

User code	54
-----------	----

V

Vibrate only	46
Voicemail	22
Voucher redemption	34

W

World time	49
Wrist strap	12
Writing language	48

Click to navigate

2	Welcome
3	Safety
6	Quick reference
9	Getting started
14	Using your IsatPhone 2
35	Location services
41	Phonebook & Contacts
45	Data
46	Personal settings
53	Security
56	Troubleshooting
59	Care and maintenance
61	Regulatory and compliance
64	Disclaimer
65	Accessories
66	Export controls
67	Malware
68	Downloading content
69	Notices
70	Protection of personal information
71	Type and specification
72	Index

inmarsat.com/isatphone

While the information in this document has been prepared in good faith, no representation, warranty, assurance or undertaking (express or implied) is or will be made, nor will responsibility or liability (howsoever arising) be accepted by the Inmarsat group or any of its officers, employees or agents in relation to the adequacy, accuracy, completeness, reasonableness or fitness for purpose of the information in this document. All and any such responsibility and liability is expressly disclaimed and excluded to the maximum extent permitted by applicable law. INMARSAT is a trademark owned by the International Mobile Satellite Organisation licensed to Inmarsat Global Limited. All other Inmarsat trademarks in this document, including the Inmarsat LOGO, are owned by Inmarsat Global Limited. In the event of any conflict between the words of the disclaimer and the English version from which it is translated, the English version shall prevail. © Inmarsat Global Limited 2018. All rights reserved. IsatPhone 2 User Guide (Model 2.1) May 2018.