

Full SAR Test Report

Applicant Name: LENOVO MOBILE COMMUNICATION TECHNOLOGY LTD.
Applicant Address: No.999,Qishan North 2nd Road,Information&Optoelectronics Park,
Torch Hi-tech Industry Development Zone,Xiamen,P.R.China
P.C:361006

The following samples were submitted and identified on behalf of the client as:

Sample Description	GSM Mobile
SGS Ref	KL007
Model Number	W10
Final Hardware Version Tested	X17D
Final Software Version Tested	X17DV1.0.0B01
FCC ID	YCNW10
Date Initial Sample Received	05-24,2010
Testing Start Date	05-26,2010
Testing End Date	06-01,2010

According to:

FCC 47CFR § 2.1093, IEEE Std C95.1-2005

IEEE1528-2003, OET Bulletin 65 Supplement C

Comments/ Conclusion:

The configuration tested complied to the certification requirements specified in this report.

Signed for on behalf of SGS

Tina Gong

Project Manager

Peter Au

Technical Manager

This document is issued by the Company subject to its General Conditions of Service printed overleaf, available on request or accessible at http://www.sgs.com/terms_and_conditions.htm. and, for electronic format documents to Terms and Conditions for Electronic Documents at www.sgs.com/terms_e-document.htm. Attention is drawn to the limitation of liability, indemnification and jurisdiction issues defined therein. Any holder of this document is advised that information contained hereon reflects the company's findings at the time of its intervention only and within the limits of Client's instructions, if any. The Company's sole responsibility is to its Client and this document does not exonerate parties to a transaction from exercising all their rights and obligation under the transaction documents. This document cannot be reproduced except in full, without prior written approval of the Company. Any unauthorised alteration, forgery or falsification of the content or appearance of this document is unlawful and offenders may be prosecuted to the fullest extent of the law. Unless otherwise stated the results shown in this test report refer only to the sample(s) tested and such sample(s) are retained for 30 days only

SHGSM

Table of Contents

Change History	3
1. Report Overview	4
2. Test Lab Declaration or Comments.....	4
3. Applicant Declaration or Comments.....	4
4. Full Test Report	4
5. Partial Test Report.....	4
6. Measurement Uncertainty.....	4
7. Testing Environment	6
8. Primary Test Laboratory	6
9. Details of Applicant	6
10. Details of Manufacturer.....	6
11. Other testing Locations	6
12. Referenced Documents.....	7
13. Primary Laboratory Accreditation Details	8
14. SGS Shanghai Wireless Telecommunications lab, Personnel	9
15. Test Equipment Information.....	10
15.1 SPEAG DASY4	10
15.2 The SAR Measurement System.....	11
15.3 Isotropic E-field Probe ES3DV3.....	12
15.4 SAM Twin Phantom	13
15.5 Device Holder for Transmitters	14
16. Detailed Test Results.....	15
16.1 Summary of Results	15
16.2 Maximum Results	16
16.3 Operation Configurations	16
16.4 Measurement procedure	17
16.5 Detailed Test Results	18
17. Identification of Samples	45
18. Photographs of EUT.....	46
Annex A Photographs of Test Setup	48
Annex B Tissue Simulant Liquid.....	51
Annex C SAR System Validation.....	52
Annex D Description of Test Position	58
Annex E Calibration certificate	61
Annex E.1 Probe Calibration certificate	61
Annex E.2 DAE Calibration certificate.....	72
Annex E.3 Dipole Calibration certification	77
END OF REPORT	86

Change History

Version	Change Contents	Author	Date
V1.0	First edition	Tina Gong	06-11, 2010

1. Report Overview

This report details the results of testing carried out on the samples listed in section 17, the results contained in this test report do not relate to other samples of the same product. The manufacturer should ensure that all products in series production are in conformity with the product sample detailed in this report.

This report may only be reproduced and distributed in full. If the product in this test report is used in any configuration other than that detailed in the test report, the manufacturer must ensure the new configuration complies with all relevant standards and certification requirements. Any mention of SGS Shanghai Wireless Telecommunications lab or testing done by SGS Shanghai Wireless Telecommunications lab made in connection with the distribution or use of the tested product must be approved in writing by SGS Shanghai Wireless Telecommunications lab.

2. Test Lab Declaration or Comments

None

3. Applicant Declaration or Comments

None

4. Full Test Report

A full test report contains, within the results section, all the applicable test cases from the certification requirements of the permanent reference documents of the listed certification bodies.

5. Partial Test Report

A partial test report contains within the results section a sub-set of all the applicable test cases from the certification requirements of the permanent reference documents of the listed certification bodies.

6. Measurement Uncertainty

Measurements and results are all in compliance with the standards listed in section 12 of this report. All measurements and results are recorded and maintained at the laboratory performing the tests and measurement uncertainties are taken into account when comparing measurements to pass/ fail criteria.

a	b1	c	d	e = f(d,k)	g	i = cxg/e	k
Uncertainty Component	Section in P1528	Tol (%)	Prob . Dist.	Div.	Ci (1g)	1g ui (%)	Vi (Veff)
Probe calibration	E.2.1	6.3	N	1	1	6.3	∞
Axial isotropy	E.2.2	0.5	R	$\sqrt{3}$	$(1-c_p)^{1/2}$	0.20	∞
hemispherical isotropy	E.2.2	2.6	R	$\sqrt{3}$	$\sqrt{c_p}$	1.06	∞
Boundary effect	E.2.3	0.8	R	$\sqrt{3}$	1	0.46	∞
Linearity	E.2.4	0.6	R	$\sqrt{3}$	1	0.35	∞
System detection limit	E.2.5	0.25	R	$\sqrt{3}$	1	0.15	∞
Readout electronics	E.2.6	0.3	N	1	1	0.3	∞
Response time	E.2.7	0	R	$\sqrt{3}$	1	0	∞
Integration time	E.2.8	2.6	R	$\sqrt{3}$	1	1.5	∞
RF ambient Condition -Noise	E.6.1	3	R	$\sqrt{3}$	1	1.73	∞
RF ambient Condition - reflections	E.6.1	3	R	$\sqrt{3}$	1	1.73	∞
Probe positioning- mechanical tolerance	E.6.2	1.5	R	$\sqrt{3}$	1	0.87	∞
Probe positioning- with respect to phantom	E.6.3	2.9	R	$\sqrt{3}$	1	1.67	∞
Max. SAR evaluation	E.5.2	1	R	$\sqrt{3}$	1	0.58	∞
Test sample positioning	E.4.2	4	N	1	1	3.7	9
Device holder uncertainty	E.4.1	3.6	N	1	1	3.6	∞
Output power variation -SAR drift measurement	6.62	5	R	$\sqrt{3}$	1	2.89	∞
Phantom uncertainty (shape and thickness tolerances)	E.3.1	4	R	$\sqrt{3}$	1	2.31	∞
Liquid conductivity - deviation from target values	E.3.2	5	R	$\sqrt{3}$	0.64	1.85	∞
Liquid conductivity - measurement uncertainty	E.3.2	4	N	1	0.64	2.56	5
Liquid permittivity - deviation from target values	E.3.3	5	R	$\sqrt{3}$	0.6	1.73	∞
Liquid permittivity - measurement uncertainty	E.3.3	4	N	1	0.6	2.40	5
Combined standard uncertainty				RSS		10.71	430
Expanded uncertainty (95% CONFIDENCE INTERVAL)				K=2		21.43	

7. Testing Environment

Normal Temperature	+20 to +24 °C
Relative Humidity	35 to 60 %

8. Primary Test Laboratory

Name:	Wireless Telecommunications Laboratory SGS-CSTC Standards Technical Services(Shanghai) Co., Ltd
Address:	9F, 3rd Building, No.889, Yishan Rd, Xuhui District, Shanghai, China 200233
Telephone:	+86 (0) 21 6140 2666
Fax:	+86 (0) 21 5450 0149
Internet:	http://www.cn.sgs.com
Contact:	Mr. Peter Xue
Email:	peter.xue@sgs.com

9. Details of Applicant

Name:	LENOVO MOBILE COMMUNICATION TECHNOLOGY LTD.
Address:	No.999,Qishan North 2nd Road,Information&Optoelectronics Park,Torch Hi-tech Industry Development Zone,Xiamen,P.R.China P.C:361006
Telephone:	+86 592-216 6651
Contact:	Qiushou yu
Fax	+86 592-216 6651
Email:	qiusya@lenovomobile.com

10. Details of Manufacturer

Name:	LENOVO MOBILE COMMUNICATION TECHNOLOGY LTD.
Address:	No.999,Qishan North 2nd Road,Information&Optoelectronics Park,Torch Hi-tech Industry Development Zone,Xiamen,P.R.China P.C:361006
Telephone:	+86 592-216 6651
Contact:	Qiushou yu
Fax	+86 592-216 6651
Email:	qiusya@lenovomobile.com

11. Other testing Locations

Name:	Not Required
Address:	--
Telephone:	--
Contact:	--
Fax	--
Email:	--

12. Referenced Documents

The Equipment under Test (EUT) has been tested at SGS's (own or subcontracted) laboratories according to FCC 47CFR § 2.1093, IEEE Std C95.1-2005, IEEE1528-2003, OET Bulletin 65 Supplement C

The following table summarizes the specific reference documents such as harmonized standards or test specifications which were used for testing as SGS's (own or subcontracted) laboratories.

Identity	Document Title	Version
FCC 47CFR § 2.1093	Radiofrequency radiation exposure evaluation:portable devices	2001
IEEE Std C95.1-2005	IEEE Standard for Safety Levels with Respect to Human Exposure to Radio Frequency Electromagnetic Fields, 3 kHz to 300 GHz.	2005
IEEE1528-2003	IEEE Recommended Practice for Determining the Peak Spatial-Average Specific Absorption Rate (SAR) in the Human Head from Wireless Communications Devices: Measurement Techniques	2003
OET Bulletin 65 Supplement C	Additional Information for Evaluating Compliance of Mobile and Portable Devices with FCC Limits for Human Exposure to Radiofrequency Emissions	2001
KDB 648474 D01	SAR Evaluation Considerations for Handsets with Multiple Transmitters and Antennas	-
KDB 941225 D03	Recommended SAR Test Reduction Procedures for GSM/GPRS/EDGE	-

Human Exposure	Uncontrolled Environment General Population
Spatial Peak SAR	1.60 W/kg (averaged over a mass of 1g)

Table 12-1 RF Exposure Limits

Notes:

1. Uncontrolled environments are defined as locations where there is potential exposure of individuals who have no knowledge or control of their potential exposure.

13. Primary Laboratory Accreditation Details



SHGSM

14. SGS Shanghai Wireless Telecommunications lab, Personnel

SGS Wireless Shanghai Project Management Team and list of approved Testers for SGS Wireless Shanghai.

Surname	Forename	Initials
CAI	CAI	CAICAI
Xue	Peter	PETERXUE
Xu	Anya	ANYA
Ni	Lemon	LEMONNI
Tao	Kevin	KEVINTAO
Wang	Lawrence	LAWRENCE
Zhang	Sean	SEANZH
Ruan	Roger	ROGER
Zhang	Zenger	ZENGER
Tang	Eva	EVATANG
Ho	James	JAMESHO
Tang	Kenny	KENNY
Hailiang	Cai	HAILIANG
Chan	Hik Kwong	HKC
Nie	Neo	Neo
Gong	Tina	TINA
Nie	Marina	MARINA
Xu	Jesse	JESSE
Wang	Willam	WILLAM

Version 2010-05-18

15. Test Equipment Information

15.1 SPEAG DASY4

Test Platform	SPEAG DASY4 Professional			
Location	SGS SH Lab #8			
Manufacture	SPEAG			
Description	SAR Test System (Frequency range 300MHz-3GHz) 835, 900, 1800, 1900, 2000, 2450 frequency band HAC Extension			
Software Reference	DASY4: V4.7 Build 80 SEMCAD: V1.8 Build 186			
Hardware Reference				
Equipment	Model	Serial Number	Calibration Date	Due date of calibration
Robot	RX90L	F03/5V32A1/A01	n/a	n/a
Phantom	SAM 12	TP-1283	n/a	n/a
DAE	DAE3	569	2009-11-18	2010-11-17
E-Field Probe	ES3DV3	3088	2009-11-19	2010-11-18
Validation Kits	D835V2	4d070	2008-12-15	2010-12-14
Validation Kits	D1900V2	5d028	2009-11-24	2011-11-23
Agilent Network Analyzer	E5071B	MY42100549	2009-11-25	2010-11-24
RF Bi-Directional Coupler	ZABDC20-252H	n/a	2010-05-21	2011-05-20
Agilent Signal Generator	E4438C	14438CATO-19719	2009-11-30	2010-11-29
Mini-Circuits Preamplifier	ZHL-42	D041905	2009-11-30	2010-11-29
Agilent Power Meter	E4416A	GB41292095	2009-11-25	2010-11-24
Agilent Power Sensor	8481H	MY41091234	2009-11-25	2010-11-24
R&S Power Sensor	NRP-Z92	100025	2010-04-12	2011-04-11
R&S Universal Radio Communication Tester	CMU200	103633	2009-11-26	2010-11-25

15.2 The SAR Measurement System

A photograph of the SAR measurement System is given in Fig. 15-1.

This SAR Measurement System uses a Computer-controlled 3-D stepper motor system (Speag Dasy 4 professional system). A Model ES3DV3 3088 E-field probe is used to determine the internal electric fields. The SAR can be obtained from the equation $SAR = \sigma (|E|^2) / \rho$ where σ and ρ are the conductivity and mass density of the tissue-simulant.

The DASY4 system for performing compliance tests consists of the following items:

A standard high precision 6-axis robot (Stabile RX family) with controller, teach pendant and software. An arm extension is for accommodation the data acquisition electronics (DAE).

A dosimetric probe, i.e., an isotropic E-field probe optimized and calibrated for usage in tissue simulating liquid. The probe is equipped with an optical surface detector system.

Data acquisition electronics (DAE) which performs the signal amplification signal multiplexing, AD-conversion, offset measurements, mechanical surface detection, collision detection, etc. The unit is battery powered with standard or rechargeable batteries. The signal is optically transmitted to the EOC.

The Electro-optical converter (EOC) performs the conversion between optical and electrical of the signals for the digital communication to DAE and for the analog signal from the optical surface detection. The EOC is connected to the measurement server.

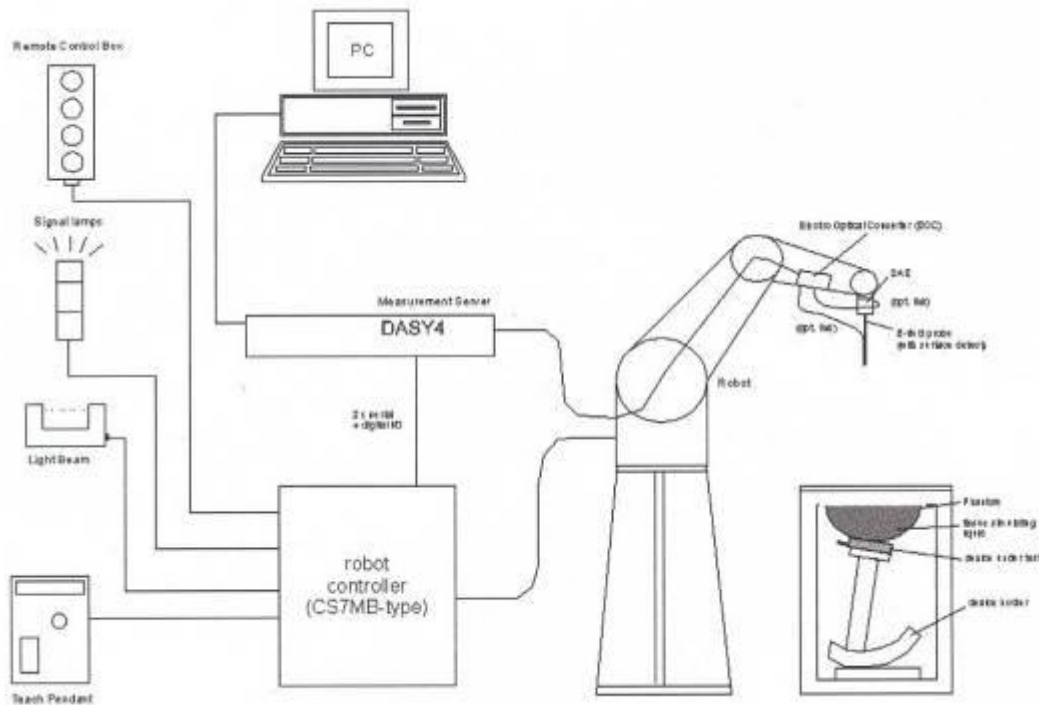

Fig. 15-1 SAR System Configuration

- Y The function of the measurement server is to perform the time critical tasks such as signal filtering, control of the robot operation and fast movement interrupts.
- Y A probe alignment unit which improves the (absolute) accuracy of the probe positioning.
- Y A computer operating Windows 2000.

- ÿ DASY4 software.
- ÿ Remote control with teach pendant and additional circuitry for robot safety such as warning lamps, etc.
- ÿ The SAM twin phantom enabling testing left-hand, right-hand and BodyWorn usage.
- ÿ The device holder for handheld mobile phones.
- ÿ Tissue simulating liquid mixed according to the given recipes.
- ÿ Validation dipole kits allowing to validating the proper functioning of the system

15.3 Isotropic E-field Probe ES3DV3

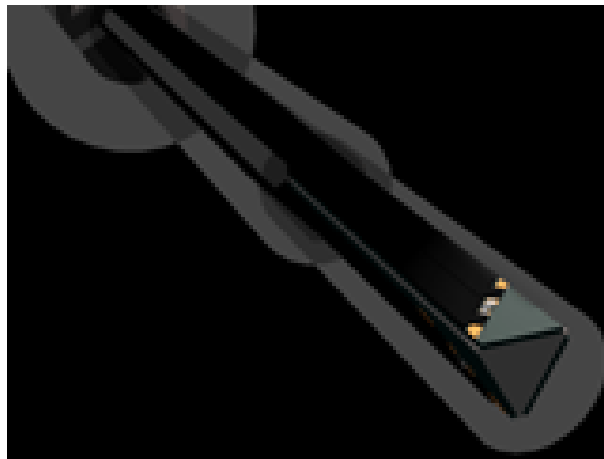

Fig. 15-2 E-field Probe

Construction	Symmetrical design with triangular core Interleaved sensors Built-in shielding against static charges PEEK enclosure material (resistant to organic solvents, e.g., DGBE)
Calibration	Basic Broad Band Calibration in air Conversion Factors (CF) for HSL 900 and HSL 1810 Additional CF for other liquids and frequencies upon request
Frequency	10 MHz to 4 GHz; Linearity: ± 0.2 dB (30 MHz to 4 GHz)
Directivity	± 0.2 dB in HSL (rotation around probe axis) ± 0.3 dB in tissue material (rotation normal to probe axis)
Dynamic Range	5 μ W/g to > 100 mW/g; Linearity: ± 0.2 dB
Dimensions	Overall length: 330 mm (Tip: 20 mm) Tip diameter: 3.9 mm (Body: 12 mm) Distance from probe tip to dipole centers: 2.0 mm
Application	General dosimetry up to 4 GHz Dosimetry in strong gradient fields Compliance tests of mobile phones

15.4 SAM Twin Phantom



Fig. 15-3 SAM Twin Phantom

The SAM twin phantom is a fiberglass shell phantom with 2mm shell thickness (except the ear region where shell thickness increases to 6mm). It has three measurement areas:

- Left hand
- Right hand
- Flat phantom

A white cover is provided to tap the phantom during off-periods to prevent water evaporation and changes in the liquid parameters. Free space scans of devices on the cover are possible.

On the phantom top, three reference markers are provided to identify the phantom position with respect to the robot.

Phantom specification:

Description	The shell corresponds to the specifications of the Specific Anthropomorphic Mannequin (SAM) phantom defined in IEEE 1528-2003, CENELEC 50361 and IEC 62209. It enables the dosimetric evaluation of left and right hand phone usage as well as body mounted usage at the flat phantom region. A cover prevents evaporation of the liquid. Reference markings on the phantom allow the complete setup of all predefined phantom positions and measurement grids by teaching three points with the robot.
Shell Thickness	2+0.2mm, Center ear point: 6+0.2mm
Filling Volume	Approx.25 liters
Dimensions	Length: 1000mm, Width: 500mm, Height: 850mm

15.5 Device Holder for Transmitters



Fig. 15-4 Device Holder for Transmitters

The SAR in the phantom is approximately inversely proportional to the square of the distance between the source and the liquid surface. For a source in 5mm distance, a positioning uncertainty of $\pm 0.5\text{mm}$ would produce a SAR uncertainty of $\pm 20\%$. An accurate device positioning is therefore crucial for accurate and repeatable measurements. The positions, in which the devices must be measured, are defined by the standards.

The DASY device holder is designed to cope with different positions given in the standard. It has two scales for the device rotation (with respect to the body axis) and the device inclination (with respect to the line between the ear reference points). The rotation centers for both scales are the ear reference point (ERP). Thus the device needs no repositioning when changing the angles.

The DASY device holder has been made out of low-loss POM material having the following dielectric parameters: relative permittivity $\epsilon = 3$ and loss tangent $\tan \delta = 0.02$. The amount of dielectric material has been reduced in the closest vicinity of the device, since measurements have suggested that the influence of the clamp on the test results could thus be lowered.

16. Detailed Test Results

16.1 Summary of Results

16.1.1 Measurement of RF conducted Power

Unit: dBm

Mode		GPRS				GSM
Slot (Uplink)		1	2	3	4	-
Band	Channel	GMSK				-
850	128	--	--	--	--	32.1
	190	--	--	--	--	32.1
	251	--	--	--	--	32.0
1900	512	--	--	--	--	30.1
	661	--	--	--	--	29.7
	810	--	--	--	--	29.3

16.1.2 Measurement of SAR average value

GSM 850

Band	EUT Position	Mode	Test Configuration	Averaged SAR over 1g (W/kg)			SAR limit 1g (W/kg)	Verdict
				CH128	CH190	CH251		
				824.2MHz	836.6MHz	848.8MHz		
GSM850	Left	GSM	Cheek	1.42	1.05	0.779	1.6	Passed
			Tilt	--	0.712	--	1.6	Passed
	Right		Cheek	1.19	0.827	0.639	1.6	Passed
			Tilt	--	0.494	--	1.6	Passed
	Body Worn	GSM	Front of EUT facing phantom	--	0.333	--	1.6	Passed
			Rear of EUT facing phantom	0.484	0.367	0.256	1.6	Passed
		GSM	Rear of EUT facing phantom With headset	0.475	--	--	1.6	Passed

PCS1900

Band	EUT Position	Mode	Test Configuration	Averaged SAR over 1g / 10g (W/kg)			SAR limit 1g (W/kg)	Verdict
				CH512	CH661	CH810		
				1850.2MHz	1880MHz	1909.8MHz		

SHGSM

PCS1900	Left	GSM	Cheek	--	0.411	--	1.6	Passed
			Tilt	0.673	0.688	0.727	1.6	Passed
	Right		Cheek	--	0.401	--	1.6	Passed
			Tilt	0.475	0.461	0.476	1.6	Passed
	Body Worn	GSM	Rear of EUT facing phantom	0.183	0.175	0.173	1.6	Passed
			Front of EUT facing phantom	--	0.083	--	1.6	Passed
			Rear of EUT facing phantom With headset	0.191	--	--	1.6	Passed

16.2 Maximum Results

The maximum measured SAR values for Head configuration and BodyWorn configuration are given in section 16.2.1 and 16.2.2 respectively.

16.2.1 Head Configuration

Frequency Band	EUT Position	Conducted Power (dBm)	SAR, Averaged over 1g (W/kg)	Power Drift (dB)	SAR limit (W/kg)	Verdict
GSM850	Left/Cheek/Low	32.1	1.42	0.0384	1.6	Passed
PCS1900	Left/Tilt/High	29.3	0.727	0.072	1.6	Passed

16.2.2 BodyWorn Configuration

Frequency Band	EUT Position	Conducted Power (dBm)	SAR, Averaged over 1g (W/kg)	Power Drift (dB)	SAR limit (W/kg)	Verdict
GSM850	GSM/Rear/Low	32.1	0.484	0.0674	1.6	Passed
PCS1900	GSM/Rear/Low With headset	29.3	0.191	0.104	1.6	Passed

16.2.3 Maximum Drift

Maximum Drift during measurement	-0.386
----------------------------------	--------

16.2.4 Measurement Uncertainty

Extended Uncertainty (k=2) 95%	21.43%
--------------------------------	--------

16.3 Operation Configurations

The EUT is controlled by using a radio communication tester (CMU200) with air link, and the EUT is set to maximum output power by CMU200 during all tests.

SHGSM

The tests in the band of GSM850, PCS1900 are performed in the GSM/GPRS mode.

1. Testing Head SAR at GSM mode for all bands with Left Cheek/Tilt and Right Cheek/Tilt conditions.
2. Testing Body SAR at GSM mode for all bands by separating 1.5cm from the EUT (both front and rear) to flat phantom.
3. Head and Body SAR with accessories should be done at worstcase to identify maximum SAR value.
4. Test reduction has been adopted according to conducted output power and produced SAR level:

Low and High channel SAR are optional if SAR value produced in the middle channel is 3dB lower than the applicable SAR limit;

In GPRS mode, the multislot configuration which produces highest SAR value is regard as the worst case to be measured, other multislot configurations are selectively confirmed;

5. The (max.cube) labeling indicates that during the grid scanning an additional peak was found which within 2dB of the highest peak
6. Head SAR for GSM should be tested in GPRS/EGPRS modes, if EUT support DTM.

16.4 Measurement procedure

Step 1: Power reference measurement

The SAR measurement was taken at a selected spatial reference point to monitor power variations during testing. This fixed location point was measured and used as a reference value.

Step 2: Area scan

The SAR distribution at the exposed side of the head was measured at a distance of 4mm from the inner surface of the shell. The area covered the entire dimension of the head and the horizontal grid spacing was 15mm*15mm or 10mm*10mm. Based on the area scan data, the area of the maximum absorption was determined by spline interpolation.

Step 3: Zoom scan

Around this point, a volume of 30mm*30mm*30mm (fine resolution volume scan, zoom scan) was assessed by measuring 7*7*7 points. On this basis of this data set, the spatial peak SAR value was evaluated with the following procedure:

The data at the surface was extrapolated, since the center of the dipoles is 2.0mm away from the tip of the probe and the distance between the surface and the lowest measuring point is 1.2mm. (This can be variable. Refer to the probe specification). The extrapolation was based on a least square algorithm. A polynomial of the fourth order was calculated through the points in z-axes. This polynomial was then used to evaluate the points between the surface and the probe tip. The maximum interpolated value was searched with a straight-forward algorithm. Around this maximum the SAR values averaged over the spatial volumes (1g or 10g) were computed using the 3D-Spline interpolation algorithm. The volume was integrated with the trapezoidal algorithm. One thousand points (10*10*10) were interpolated to calculate the average. All neighboring volumes were evaluated until no neighboring volume with a higher average value was found.

Step 4: Power reference measurement (drift)

The SAR value at the same location as in step 1 was again measured. (If the value changed by more than 5%, the evaluation should be done repeatedly)

16.5 Detailed Test Results

16.5.1 GSM850-LeftHandSide-Tilt-Middle

Date/Time: 2010-5-26 13:40:19

Test Laboratory: SGS-GSM

GSM850-LeftHandSide-Tilt-Mid

DUT: KL007; Type: Head&Body; Serial: 354460009000066

Communication System: GSM850-GSM Mode; Frequency: 836.6 MHz; Duty Cycle: 1:8.3

Medium: HSL835_Head Medium parameters used: $f = 836.6$ MHz; $\sigma = 0.897$ mho/m; $\epsilon_r = 42.9$; $\rho = 1000$ kg/m³

Phantom section: Left Section

DASY4 Configuration:

- Probe: ES3DV3 - SN3088; ConvF(5.84, 5.84, 5.84); Calibrated: 2009-11-19
- Sensor-Surface: 4mm (Mechanical Surface Detection)
- Electronics: DAE3 Sn569; Calibrated: 2009-11-18
- Phantom: SAM 12; Type: SAM V4.0; Serial: TP-1283
- Measurement SW: DASY4, V4.7 Build 80; Postprocessing SW: SEMCAD, V1.8 Build 186

Tilt position - Mid/Area Scan (41x71x1): Measurement grid: dx=15mm, dy=15mm

Maximum value of SAR (interpolated) = 0.772 mW/g

Tilt position - Mid/Zoom Scan (7x7x7) (7x7x7)/Cube 0: Measurement grid: dx=5mm, dy=5mm, dz=5mm

Reference Value = 22.5 V/m; Power Drift = 0.020 dB

Peak SAR (extrapolated) = 1.28 W/kg

SAR(1 g) = 0.712 mW/g; SAR(10 g) = 0.423 mW/g

Maximum value of SAR (measured) = 0.770 mW/g

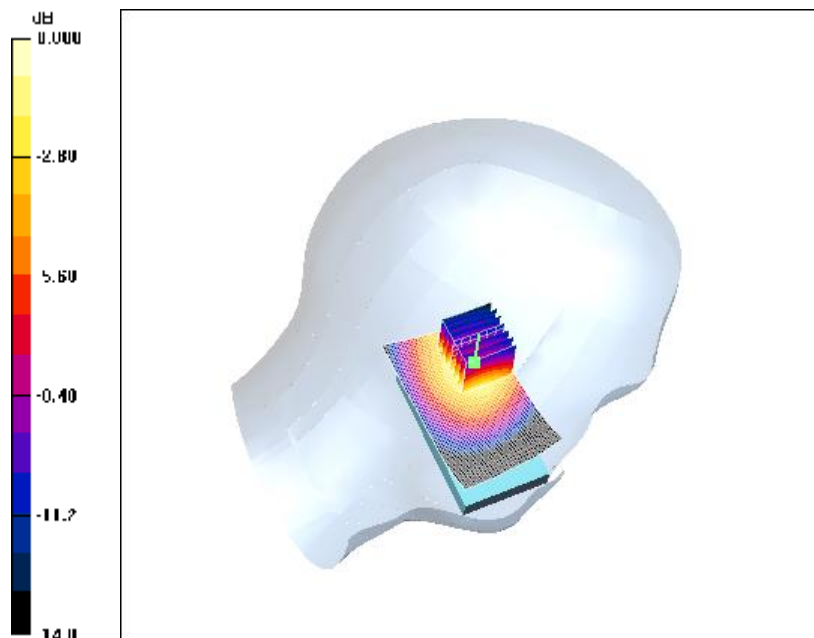

0 dB = 0.770mW/g

SHGSM

16.5.2 GSM850-LeftHandSide-Cheek-Middle

Date/Time: 2010-5-26 14:01:44

Test Laboratory: SGS-GSM

GSM850-LeftHandSide-Touch-Mid

DUT: KL007; Type: Head&Body; Serial: 354460009000066

Communication System: GSM850-GSM Mode; Frequency: 836.6 MHz;Duty Cycle: 1:8.3

Medium: HSL835_Head Medium parameters used: f = 836.6 MHz; σ = 0.897 mho/m; ϵ_r = 42.9; ρ = 1000 kg/m³

Phantom section: Left Section

DASY4 Configuration:

- Probe: ES3DV3 - SN3088; ConvF(5.84, 5.84, 5.84); Calibrated: 2009-11-19
- Sensor-Surface: 4mm (Mechanical Surface Detection)
- Electronics: DAE3 Sn569; Calibrated: 2009-11-18
- Phantom: SAM 12; Type: SAM V4.0; Serial: TP-1283
- Measurement SW: DASY4, V4.7 Build 80; Postprocessing SW: SEMCAD, V1.8 Build 186

Cheek position - Mid/Area Scan (41x71x1): **Measurement grid: dx=15mm, dy=15mm**

Maximum value of SAR (interpolated) = 1.15 mW/g

Cheek position - Mid/Zoom Scan (7x7x7) (7x7x7)/Cube 0: **Measurement grid: dx=5mm, dy=5mm, dz=5mm**

Reference Value = 26.3 V/m; Power Drift = 0.042 dB

Peak SAR (extrapolated) = 1.80 W/kg

SAR(1 g) = 1.05 mW/g; SAR(10 g) = 0.642 mW/g

Maximum value of SAR (measured) = 1.14 mW/g

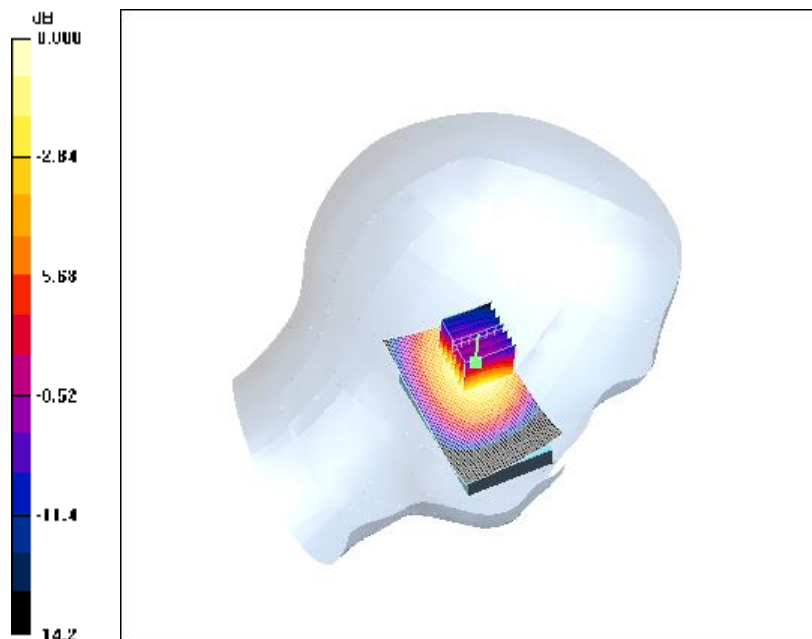

0 dB = 1.14mW/g

SHGSM

16.5.3 GSM850-LeftHandSide-Cheek-Low

Date/Time: 2010-5-26 14:22:45

Test Laboratory: SGS-GSM

GSM850-LeftHandSide-Touch-Low

DUT: KL007; Type: Head&Body; Serial: 354460009000066

Communication System: GSM850-GSM Mode; Frequency: 824.2 MHz; Duty Cycle: 1:8.3

Medium: HSL835_Head Medium parameters used: f = 824.2 MHz; $\sigma = 0.885$ mho/m; $\epsilon_r = 43.1$; $\rho = 1000$ kg/m³

Phantom section: Left Section

DASY4 Configuration:

- Probe: ES3DV3 - SN3088; ConvF(5.84, 5.84, 5.84); Calibrated: 2009-11-19
- Sensor-Surface: 4mm (Mechanical Surface Detection)
- Electronics: DAE3 Sn569; Calibrated: 2009-11-18
- Phantom: SAM 12; Type: SAM V4.0; Serial: TP-1283
- Measurement SW: DASY4, V4.7 Build 80; Postprocessing SW: SEMCAD, V1.8 Build 186

Cheek position - Low/Area Scan (41x71x1): **Measurement grid: dx=15mm, dy=15mm**

Maximum value of SAR (interpolated) = 1.53 mW/g

Cheek position - Low/Zoom Scan (7x7x7) (7x7x7)/Cube 0: **Measurement grid: dx=5mm, dy=5mm, dz=5mm**

Reference Value = 30.8 V/m; Power Drift = 0.038 dB

Peak SAR (extrapolated) = 2.47 W/kg

SAR(1 g) = 1.42 mW/g; SAR(10 g) = 0.868 mW/g

Maximum value of SAR (measured) = 1.54 mW/g

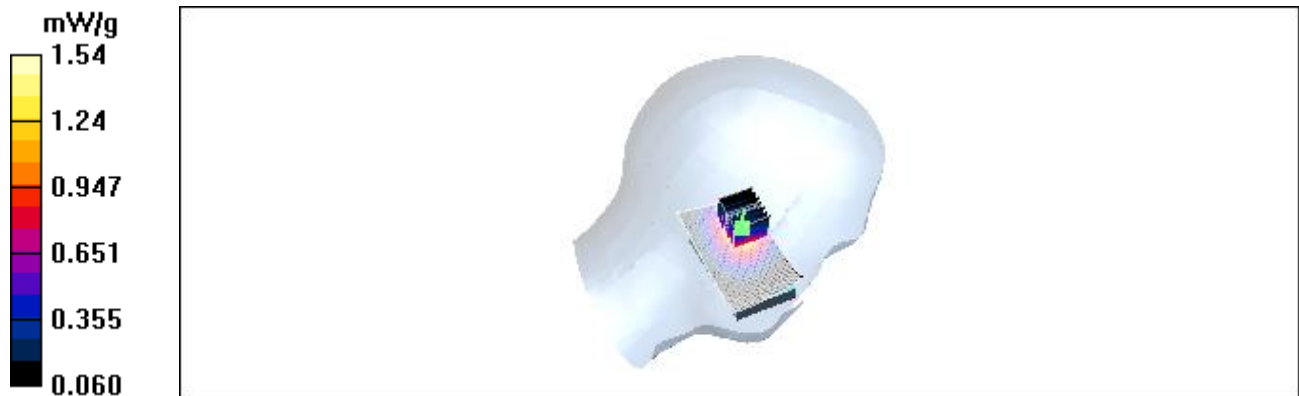

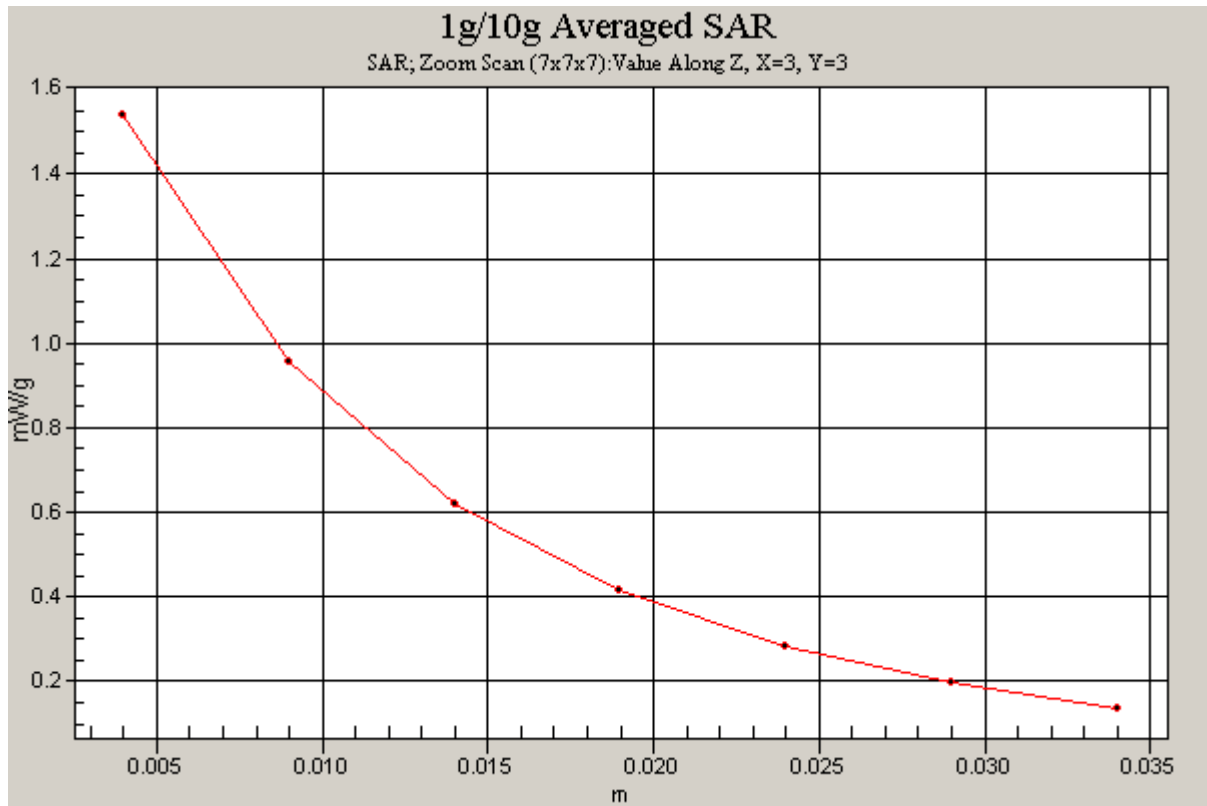

16.5.4 GSM850-LeftHandSide-Cheek-High

Date/Time: 2010-5-26 14:44:30

Test Laboratory: SGS-GSM

GSM850-LeftHandSide-Touch-High

DUT: KL007; Type: Head&Body; Serial: 354460009000066

Communication System: GSM850-GSM Mode; Frequency: 848.8 MHz;Duty Cycle: 1:8.3

Medium: HSL835_Head Medium parameters used: f = 848.8 MHz; $\sigma = 0.911$ mho/m; $\epsilon_r = 42.7$; $\rho = 1000$ kg/m³

Phantom section: Left Section

DASY4 Configuration:

- Probe: ES3DV3 - SN3088; ConvF(5.84, 5.84, 5.84); Calibrated: 2009-11-19
- Sensor-Surface: 4mm (Mechanical Surface Detection)
- Electronics: DAE3 Sn569; Calibrated: 2009-11-18
- Phantom: SAM 12; Type: SAM V4.0; Serial: TP-1283
- Measurement SW: DASY4, V4.7 Build 80; Postprocessing SW: SEMCAD, V1.8 Build 186

Cheek position -High/Area Scan (41x71x1): **Measurement grid: dx=15mm, dy=15mm**

Maximum value of SAR (interpolated) = 0.864 mW/g

Cheek position -High/Zoom Scan (7x7x7) (7x7x7)/Cube 0: **Measurement grid: dx=5mm, dy=5mm, dz=5mm**

Reference Value = 22.6 V/m; Power Drift = 0.159 dB

Peak SAR (extrapolated) = 1.42 W/kg

SAR(1 g) = 0.779 mW/g; SAR(10 g) = 0.472 mW/g

Maximum value of SAR (measured) = 0.844 mW/g

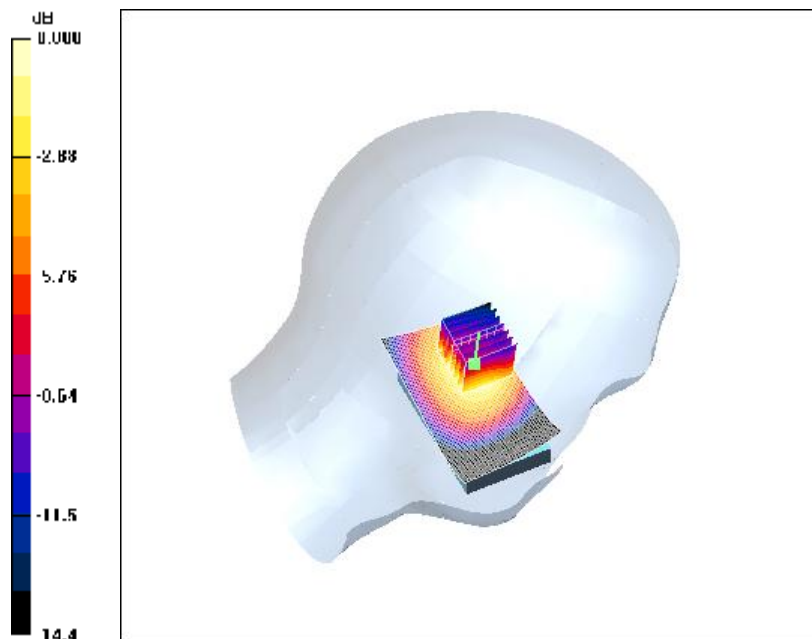

0 dB = 0.844mW/g

16.5.5 GSM850-RightHandSide-Cheek-Middle

Date/Time: 2010-5-26 15:38:56

Test Laboratory: SGS-GSM

GSM850-RightHandSide-Touch-Mid

DUT: KL007; Type: Head&Body; Serial: 354460009000066

Communication System: GSM850-GSM Mode; Frequency: 836.6 MHz;Duty Cycle: 1:8.3

Medium: HSL835_Head Medium parameters used: f = 836.6 MHz; $\sigma = 0.897$ mho/m; $\epsilon_r = 42.9$; $\rho = 1000$ kg/m³

Phantom section: Right Section

DASY4 Configuration:

- Probe: ES3DV3 - SN3088; ConvF(5.84, 5.84, 5.84); Calibrated: 2009-11-19
- Sensor-Surface: 4mm (Mechanical Surface Detection)
- Electronics: DAE3 Sn569; Calibrated: 2009-11-18
- Phantom: SAM 12; Type: SAM V4.0; Serial: TP-1283
- Measurement SW: DASY4, V4.7 Build 80; Postprocessing SW: SEMCAD, V1.8 Build 186

Cheek position - Middle/Area Scan (41x71x1): **Measurement grid: dx=15mm, dy=15mm**

Maximum value of SAR (interpolated) = 0.895 mW/g

Cheek position - Middle/Zoom Scan (7x7x7)/Cube 0: **Measurement grid: dx=5mm, dy=5mm, dz=5mm**

Reference Value = 26.6 V/m; Power Drift = -0.011 dB

Peak SAR (extrapolated) = 1.25 W/kg

SAR(1 g) = 0.827 mW/g; SAR(10 g) = 0.536 mW/g

Maximum value of SAR (measured) = 0.884 mW/g

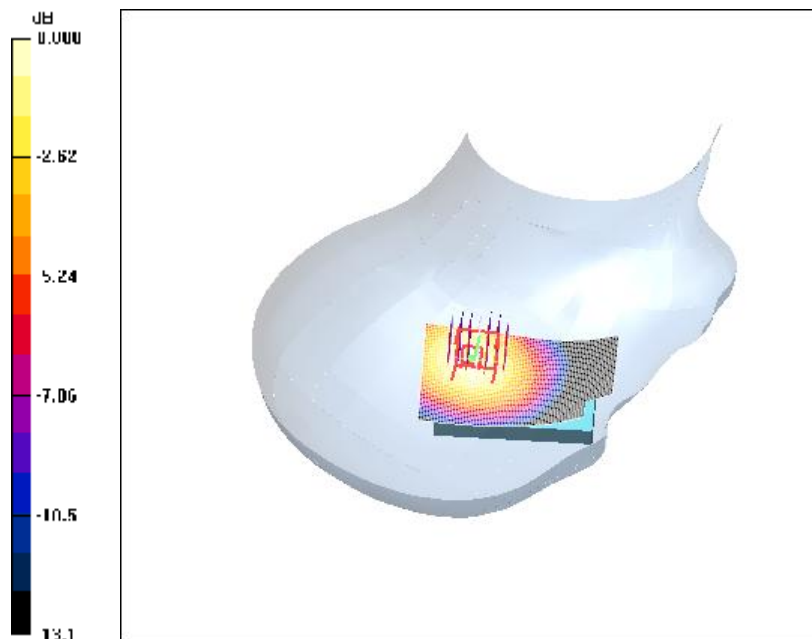

0 dB = 0.884mW/g

SHGSM

16.5.6 GSM850-RightHandSide-Tilt-Middle

Date/Time: 2010-5-26 15:16:51

Test Laboratory: SGS-GSM

GSM850-RightHandSide-Tilt-Mid

DUT: KL007; Type: Head&Body; Serial: 354460009000066

Communication System: GSM850-GSM Mode; Frequency: 836.6 MHz;Duty Cycle: 1:8.3

Medium: HSL835_Head Medium parameters used: f = 836.6 MHz; $\sigma = 0.897$ mho/m; $\epsilon_r = 42.9$; $\rho = 1000$ kg/m³

Phantom section: Right Section

DASY4 Configuration:

- Probe: ES3DV3 - SN3088; ConvF(5.84, 5.84, 5.84); Calibrated: 2009-11-19
- Sensor-Surface: 4mm (Mechanical Surface Detection)
- Electronics: DAE3 Sn569; Calibrated: 2009-11-18
- Phantom: SAM 12; Type: SAM V4.0; Serial: TP-1283
- Measurement SW: DASY4, V4.7 Build 80; Postprocessing SW: SEMCAD, V1.8 Build 186

Tilt position - Middle/Area Scan (41x71x1): **Measurement grid: dx=15mm, dy=15mm**

Maximum value of SAR (interpolated) = 0.521 mW/g

Tilt position - Middle/Zoom Scan (7x7x7)/Cube 0: **Measurement grid: dx=5mm, dy=5mm, dz=5mm**

Reference Value = 20.2 V/m; Power Drift = -0.068 dB

Peak SAR (extrapolated) = 0.790 W/kg

SAR(1 g) = 0.494 mW/g; SAR(10 g) = 0.312 mW/g

Maximum value of SAR (measured) = 0.534 mW/g

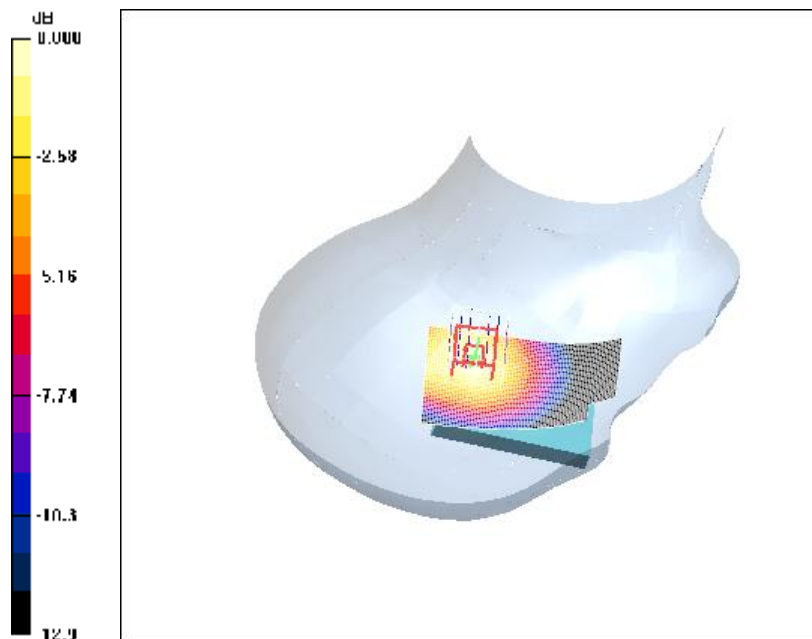

0 dB = 0.534mW/g

SHGSM

16.5.7 GSM850-RightHandSide-Cheek-Low

Date/Time: 2010-5-26 16:21:46

Test Laboratory: SGS-GSM

GSM850-RightHandSide-Touch-Low

DUT: KL007; Type: Head&Body; Serial: 354460009000066

Communication System: GSM850-GSM Mode; Frequency: 824.2 MHz;Duty Cycle: 1:8.3

Medium: HSL835_Head Medium parameters used: f = 824.2 MHz; $\sigma = 0.885$ mho/m; $\epsilon_r = 43.1$; $\rho = 1000$ kg/m³

Phantom section: Right Section

DASY4 Configuration:

- Probe: ES3DV3 - SN3088; ConvF(5.84, 5.84, 5.84); Calibrated: 2009-11-19
- Sensor-Surface: 4mm (Mechanical Surface Detection)
- Electronics: DAE3 Sn569; Calibrated: 2009-11-18
- Phantom: SAM 12; Type: SAM V4.0; Serial: TP-1283
- Measurement SW: DASY4, V4.7 Build 80; Postprocessing SW: SEMCAD, V1.8 Build 186

Cheek position - Low/Area Scan (41x71x1): **Measurement grid: dx=15mm, dy=15mm**

Maximum value of SAR (interpolated) = 1.28 mW/g

Cheek position - Low/Zoom Scan (7x7x7) (7x7x7)/Cube 0: **Measurement grid: dx=5mm, dy=5mm, dz=5mm**

Reference Value = 32.2 V/m; Power Drift = -0.060 dB

Peak SAR (extrapolated) = 1.82 W/kg

SAR(1 g) = 1.19 mW/g; SAR(10 g) = 0.775 mW/g

Maximum value of SAR (measured) = 1.28 mW/g

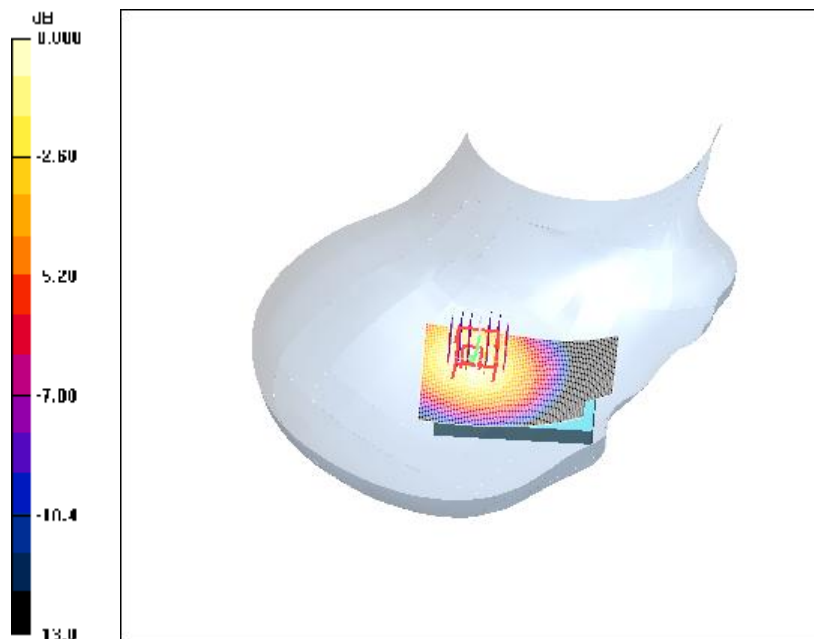

0 dB = 1.28mW/g

SHGSM

16.5.8 GSM850-RightHandSide-Cheek-High

Date/Time: 2010-5-26 16:42:15

Test Laboratory: SGS-GSM

GSM850-RightHandSide-Touch-High

DUT: KL007; Type: Head&Body; Serial: 354460009000066

Communication System: GSM850-GSM Mode; Frequency: 848.8 MHz;Duty Cycle: 1:8.3

Medium: HSL835_Head Medium parameters used: f = 848.8 MHz; $\sigma = 0.911$ mho/m; $\epsilon_r = 42.7$; $\rho = 1000$ kg/m³

Phantom section: Right Section

DASY4 Configuration:

- Probe: ES3DV3 - SN3088; ConvF(5.84, 5.84, 5.84); Calibrated: 2009-11-19
- Sensor-Surface: 4mm (Mechanical Surface Detection)
- Electronics: DAE3 Sn569; Calibrated: 2009-11-18
- Phantom: SAM 12; Type: SAM V4.0; Serial: TP-1283
- Measurement SW: DASY4, V4.7 Build 80; Postprocessing SW: SEMCAD, V1.8 Build 186

Cheek position - High/Area Scan (41x71x1): **Measurement grid: dx=15mm, dy=15mm**

Maximum value of SAR (interpolated) = 0.683 mW/g

Cheek position - High/Zoom Scan (7x7x7) (7x7x7)/Cube 0: **Measurement grid: dx=5mm, dy=5mm, dz=5mm**

Reference Value = 22.8 V/m; Power Drift = 0.028 dB

Peak SAR (extrapolated) = 1.01 W/kg

SAR(1 g) = 0.639 mW/g; SAR(10 g) = 0.411 mW/g

Maximum value of SAR (measured) = 0.686 mW/g

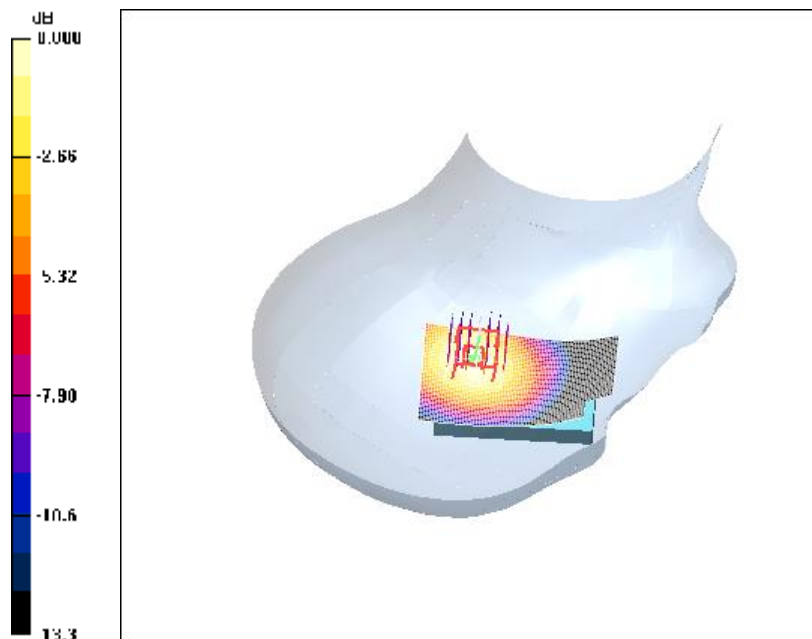

0 dB = 0.686mW/g

16.5.9 GSM850-BodyWorn-GSM-Front-Middle

Date/Time: 2010-5-26 10:09:55

Test Laboratory: SGS-GSM

GSM850-Body-Worn-Front-Mid

DUT: KL007; Type: Head&Body; Serial: 354460009000066

Communication System: GSM850-GSM Mode; Frequency: 836.4 MHz;Duty Cycle: 1:8.3

Medium: HSL835 Body Medium parameters used: $f = 836.4$ MHz; $\sigma = 0.953$ mho/m; $\epsilon_r = 55.1$; $\rho = 1000$ kg/m³

Phantom section: Flat Section

DASY4 Configuration:

- Probe: ES3DV3 - SN3088; ConvF(5.68, 5.68, 5.68); Calibrated: 2009-11-19
- Sensor-Surface: 4mm (Mechanical Surface Detection)
- Electronics: DAE3 Sn569; Calibrated: 2009-11-18
- Phantom: SAM 12; Type: SAM V4.0; Serial: TP-1283
- Measurement SW: DASY4, V4.7 Build 80; Postprocessing SW: SEMCAD, V1.8 Build 186

Body Worn - Middle-Front/Area Scan (41x71x1): **Measurement grid: dx=15mm, dy=15mm**

Maximum value of SAR (interpolated) = 0.356 mW/g

Body Worn - Middle-Front/Zoom Scan (7x7x7)/Cube 0: **Measurement grid: dx=5mm, dy=5mm, dz=5mm**

Reference Value = 15.5 V/m; Power Drift = -0.097 dB

Peak SAR (extrapolated) = 0.488 W/kg

SAR(1 g) = 0.333 mW/g; SAR(10 g) = 0.220 mW/g

Maximum value of SAR (measured) = 0.360 mW/g



0 dB = 0.360mW/g

SHGSM

16.5.10 GSM850-BodyWorn-GSM-Rear-Middle

Date/Time: 2010-5-26 10:29:49

Test Laboratory: SGS-GSM

GSM850-Body-Worn-Rear-Mid

DUT: KL007; Type: Head&Body; Serial: 354460009000066

Communication System: GSM850-GSM Mode; Frequency: 836.4 MHz;Duty Cycle: 1:8.3

Medium: HSL835 Body Medium parameters used: $f = 836.4$ MHz; $\sigma = 0.953$ mho/m; $\epsilon_r = 55.1$; $\rho = 1000$ kg/m³

Phantom section: Flat Section

DASY4 Configuration:

- Probe: ES3DV3 - SN3088; ConvF(5.68, 5.68, 5.68); Calibrated: 2009-11-19
- Sensor-Surface: 4mm (Mechanical Surface Detection)
- Electronics: DAE3 Sn569; Calibrated: 2009-11-18
- Phantom: SAM 12; Type: SAM V4.0; Serial: TP-1283
- Measurement SW: DASY4, V4.7 Build 80; Postprocessing SW: SEMCAD, V1.8 Build 186

Body Worn - Middle-Rear/Area Scan (41x71x1): **Measurement grid: dx=15mm, dy=15mm**

Maximum value of SAR (interpolated) = 0.395 mW/g

Body Worn - Middle-Rear/Zoom Scan (7x7x7)/Cube 0: **Measurement grid: dx=5mm, dy=5mm, dz=5mm**

Reference Value = 14.5 V/m; Power Drift = 0.075 dB

Peak SAR (extrapolated) = 0.538 W/kg

SAR(1 g) = 0.367 mW/g; SAR(10 g) = 0.245 mW/g

Maximum value of SAR (measured) = 0.394 mW/g

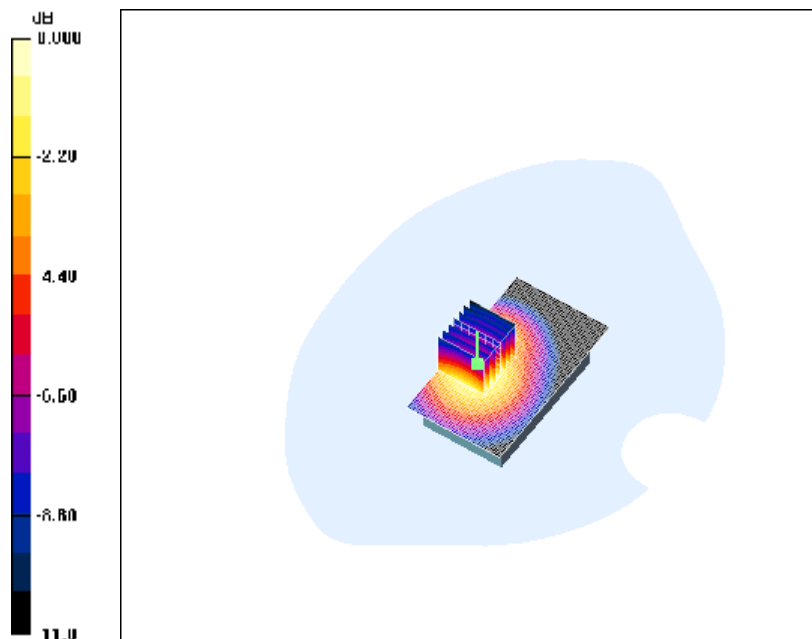

0 dB = 0.394mW/g

SHGSM

16.5.11 GSM850-BodyWorn-GSM-Rear-Low

Date/Time: 2010-5-26 10:50:06

Test Laboratory: SGS-GSM

GSM850-Body-Worn-Rear-Low

DUT: KL007; Type: Head&Body; Serial: 354460009000066

Communication System: GSM850-GSM Mode; Frequency: 824.2 MHz;Duty Cycle: 1:8.3

Medium: HSL835 Body Medium parameters used: $f = 824.2 \text{ MHz}$; $\sigma = 0.941 \text{ mho/m}$; $\epsilon_r = 55.3$; $\rho = 1000 \text{ kg/m}^3$

Phantom section: Flat Section

DASY4 Configuration:

- Probe: ES3DV3 - SN3088; ConvF(5.68, 5.68, 5.68); Calibrated: 2009-11-19
- Sensor-Surface: 4mm (Mechanical Surface Detection)
- Electronics: DAE3 Sn569; Calibrated: 2009-11-18
- Phantom: SAM 12; Type: SAM V4.0; Serial: TP-1283
- Measurement SW: DASY4, V4.7 Build 80; Postprocessing SW: SEMCAD, V1.8 Build 186

Body Worn - Low-Rear/Area Scan (41x71x1): **Measurement grid: $dx=15\text{mm}$, $dy=15\text{mm}$**

Maximum value of SAR (interpolated) = 0.521 mW/g

Body Worn - Low-Rear/Zoom Scan (7x7x7)/Cube 0: **Measurement grid: $dx=5\text{mm}$, $dy=5\text{mm}$, $dz=5\text{mm}$**

Reference Value = 16.7 V/m; Power Drift = 0.067 dB

Peak SAR (extrapolated) = 0.719 W/kg

SAR(1 g) = 0.484 mW/g; SAR(10 g) = 0.321 mW/g

Maximum value of SAR (measured) = 0.520 mW/g

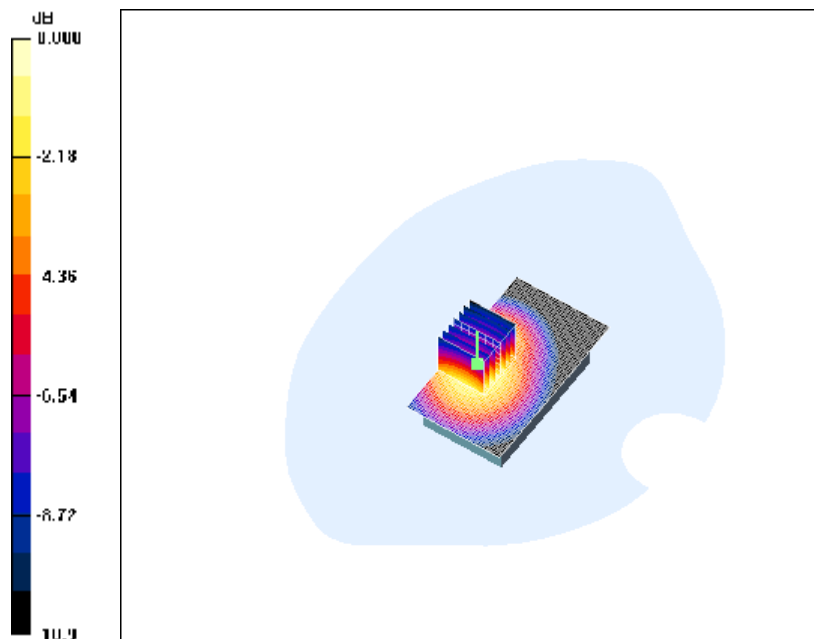

0 dB = 0.520mW/g

SHGSM

16.5.12 GSM850-BodyWorn-GSM-Rear-High

Date/Time: 2010-5-26 11:09:49

Test Laboratory: SGS-GSM

GSM850-Body-Worn-Rear-High

DUT: KL007; Type: Head&Body; Serial: 354460009000066

Communication System: GSM850-GSM Mode; Frequency: 848.8 MHz; Duty Cycle: 1:8.3

Medium: HSL835 Body Medium parameters used: $f = 848.8 \text{ MHz}$; $\sigma = 0.966 \text{ mho/m}$; $\epsilon_r = 55$; $\rho = 1000 \text{ kg/m}^3$

Phantom section: Flat Section

DASY4 Configuration:

- Probe: ES3DV3 - SN3088; ConvF(5.68, 5.68, 5.68); Calibrated: 2009-11-19
- Sensor-Surface: 4mm (Mechanical Surface Detection)
- Electronics: DAE3 Sn569; Calibrated: 2009-11-18
- Phantom: SAM 12; Type: SAM V4.0; Serial: TP-1283
- Measurement SW: DASY4, V4.7 Build 80; Postprocessing SW: SEMCAD, V1.8 Build 186

Body Worn - High-Rear/Area Scan (41x71x1): **Measurement grid: $dx=15\text{mm}$, $dy=15\text{mm}$**

Maximum value of SAR (interpolated) = 0.276 mW/g

Body Worn - High-Rear/Zoom Scan (7x7x7)/Cube 0: **Measurement grid: $dx=5\text{mm}$, $dy=5\text{mm}$, $dz=5\text{mm}$**

Reference Value = 12.1 V/m; Power Drift = 0.050 dB

Peak SAR (extrapolated) = 0.374 W/kg

SAR(1 g) = 0.256 mW/g; SAR(10 g) = 0.170 mW/g

Maximum value of SAR (measured) = 0.275 mW/g

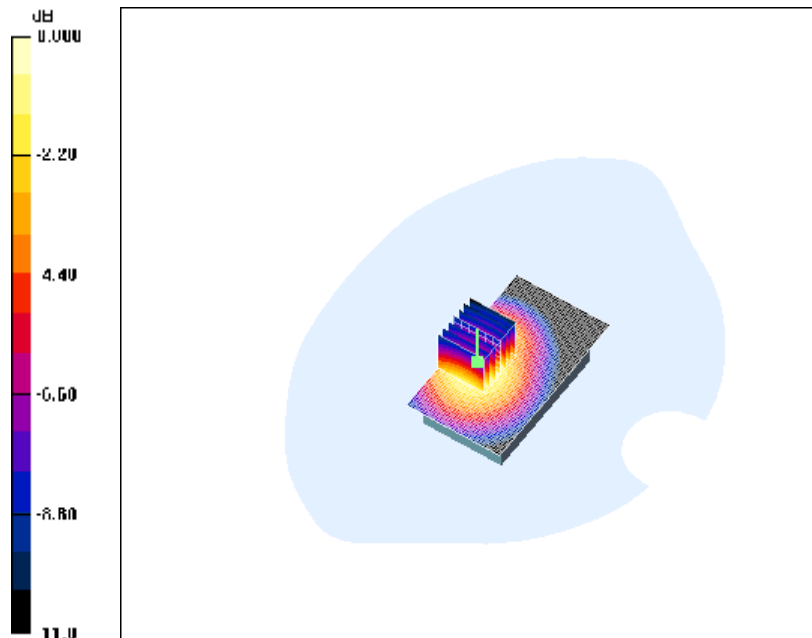

0 dB = 0.275mW/g

16.5.13 GSM850-BodyWorn-GSM-Worstcase With Headset

Date/Time: 2010-5-26 11:30:27

Test Laboratory: SGS-GSM

GSM850-Body-Worn-Rear-Low With Headset

DUT: KL007; Type: Head&Body; Serial: 354460009000066

Communication System: GSM850-GSM Mode; Frequency: 824.2 MHz;Duty Cycle: 1:8.3

Medium: HSL835 Body Medium parameters used: $f = 824.2 \text{ MHz}$; $\sigma = 0.941 \text{ mho/m}$; $\epsilon_r = 55.3$; $\rho = 1000 \text{ kg/m}^3$

Phantom section: Flat Section

DASY4 Configuration:

- Probe: ES3DV3 - SN3088; ConvF(5.68, 5.68, 5.68); Calibrated: 2009-11-19
- Sensor-Surface: 4mm (Mechanical Surface Detection)
- Electronics: DAE3 Sn569; Calibrated: 2009-11-18
- Phantom: SAM 12; Type: SAM V4.0; Serial: TP-1283
- Measurement SW: DASY4, V4.7 Build 80; Postprocessing SW: SEMCAD, V1.8 Build 186

Body Worn - Low-Rear With Headset/Area Scan (41x71x1): **Measurement grid: dx=15mm, dy=15mm**

Maximum value of SAR (interpolated) = 0.507 mW/g

Body Worn - Low-Rear With Headset/Zoom Scan (7x7x7)/Cube 0: **Measurement grid: dx=5mm, dy=5mm, dz=5mm**

Reference Value = 16.0 V/m; Power Drift = -0.067 dB

Peak SAR (extrapolated) = 0.723 W/kg

SAR(1 g) = 0.475 mW/g; SAR(10 g) = 0.311 mW/g

Maximum value of SAR (measured) = 0.511 mW/g

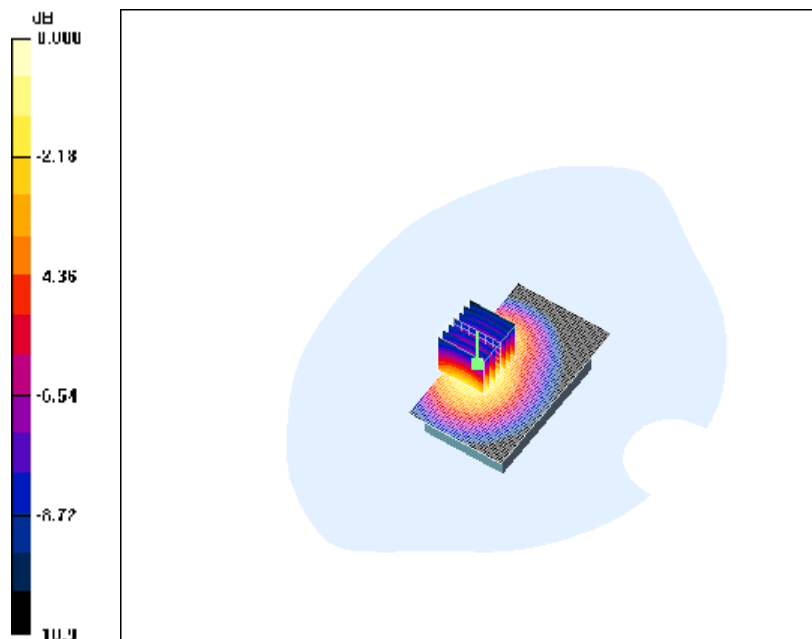

0 dB = 0.511mW/g

SHGSM

16.5.14 PCS1900-LeftHandSide-Cheek-Middle

Date/Time: 2010-5-27 9:51:38

Test Laboratory: SGS-GSM

pcs1900-LeftHandSide-Touch-Mid

DUT: KL007; Type: Head&Body; Serial: 354460009000066

Communication System: PCS1900-GSM Mode; Frequency: 1880 MHz;Duty Cycle: 1:8.3

Medium: HSL1900_Head Medium parameters used: $f = 1880$ MHz; $\sigma = 1.4$ mho/m; $\epsilon_r = 38.9$; $\rho = 1000$ kg/m³

Phantom section: Left Section

DASY4 Configuration:

- Probe: ES3DV3 - SN3088; ConvF(4.97, 4.97, 4.97); Calibrated: 2009-11-19
- Sensor-Surface: 4mm (Mechanical Surface Detection)
- Electronics: DAE3 Sn569; Calibrated: 2009-11-18
- Phantom: SAM 12; Type: SAM V4.0; Serial: TP-1283
- Measurement SW: DASY4, V4.7 Build 80; Postprocessing SW: SEMCAD, V1.8 Build 186

Cheek position - Mid/Area Scan (41x81x1): **Measurement grid: dx=15mm, dy=15mm**

Maximum value of SAR (interpolated) = 0.439 mW/g

Cheek position - Mid/Zoom Scan (7x7x7) (7x7x7)/Cube 0: **Measurement grid: dx=5mm, dy=5mm, dz=5mm**

Reference Value = 7.89 V/m; Power Drift = -0.268 dB

Peak SAR (extrapolated) = 0.799 W/kg

SAR(1 g) = 0.411 mW/g; SAR(10 g) = 0.209 mW/g

Maximum value of SAR (measured) = 0.455 mW/g

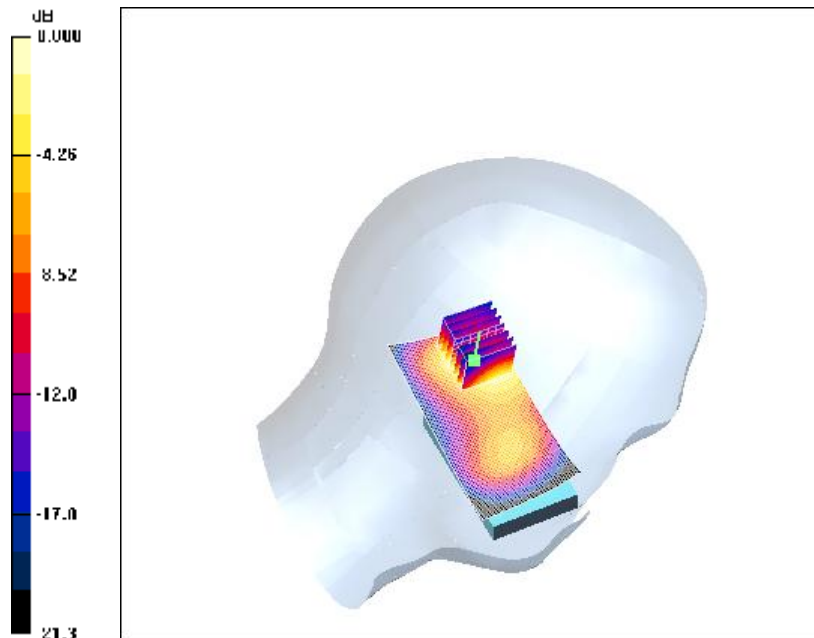

0 dB = 0.455mW/g

16.5.15 PCS1900-LeftHandSide-Tilt-Middle

Date/Time: 2010-5-27 9:20:16

Test Laboratory: SGS-GSM

pcs1900-LeftHandSide-Tilt-Mid

DUT: KL007; Type: Head&Body; Serial: 354460009000066

Communication System: PCS1900-GSM Mode; Frequency: 1880 MHz;Duty Cycle: 1:8.3

Medium: HSL1900_Head Medium parameters used: f = 1880 MHz; $\sigma = 1.4$ mho/m; $\epsilon_r = 38.9$; $\rho = 1000$ kg/m³

Phantom section: Left Section

DASY4 Configuration:

- Probe: ES3DV3 - SN3088; ConvF(4.97, 4.97, 4.97); Calibrated: 2009-11-19
- Sensor-Surface: 4mm (Mechanical Surface Detection)
- Electronics: DAE3 Sn569; Calibrated: 2009-11-18
- Phantom: SAM 12; Type: SAM V4.0; Serial: TP-1283
- Measurement SW: DASY4, V4.7 Build 80; Postprocessing SW: SEMCAD, V1.8 Build 186

Tilt position - Mid/Area Scan (41x81x1): **Measurement grid: dx=15mm, dy=15mm**

Maximum value of SAR (interpolated) = 0.775 mW/g

Tilt position - Mid/Zoom Scan (7x7x7) (7x7x7)/Cube 0: **Measurement grid: dx=5mm, dy=5mm, dz=5mm**

Reference Value = 8.40 V/m; Power Drift = 0.044 dB

Peak SAR (extrapolated) = 1.40 W/kg

SAR(1 g) = 0.688 mW/g; SAR(10 g) = 0.322 mW/g

Maximum value of SAR (measured) = 0.785 mW/g

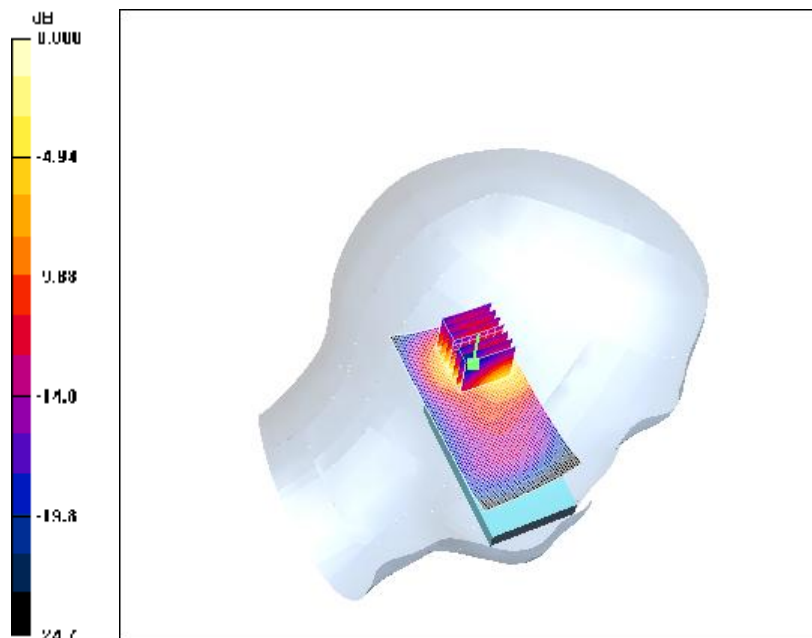

0 dB = 0.785mW/g

16.5.16 PCS1900-LeftHandSide-Tilt-Low

Date/Time: 2010-5-27 10:22:04

Test Laboratory: SGS-GSM

pcs1900-LeftHandSide-Tilt-Low

DUT: KL007; Type: Head&Body; Serial: 354460009000066

Communication System: PCS1900-GSM Mode; Frequency: 1850.2 MHz; Duty Cycle: 1:8.3

Medium: HSL1900_Head Medium parameters used: $f = 1850.2$ MHz; $\sigma = 1.36$ mho/m; $\epsilon_r = 39$; $\rho = 1000$ kg/m³

Phantom section: Left Section

DASY4 Configuration:

- Probe: ES3DV3 - SN3088; ConvF(4.97, 4.97, 4.97); Calibrated: 2009-11-19
- Sensor-Surface: 4mm (Mechanical Surface Detection)
- Electronics: DAE3 Sn569; Calibrated: 2009-11-18
- Phantom: SAM 12; Type: SAM V4.0; Serial: TP-1283
- Measurement SW: DASY4, V4.7 Build 80; Postprocessing SW: SEMCAD, V1.8 Build 186

Tilt position - Low/Area Scan (41x81x1): **Measurement grid: dx=15mm, dy=15mm**

Maximum value of SAR (interpolated) = 0.680 mW/g

Tilt position - Low/Zoom Scan (7x7x7) (7x7x7)/Cube 0: **Measurement grid: dx=5mm, dy=5mm, dz=5mm**

Reference Value = 6.94 V/m; Power Drift = -0.265 dB

Peak SAR (extrapolated) = 1.38 W/kg

SAR(1 g) = 0.673 mW/g; SAR(10 g) = 0.315 mW/g

Maximum value of SAR (measured) = 0.756 mW/g

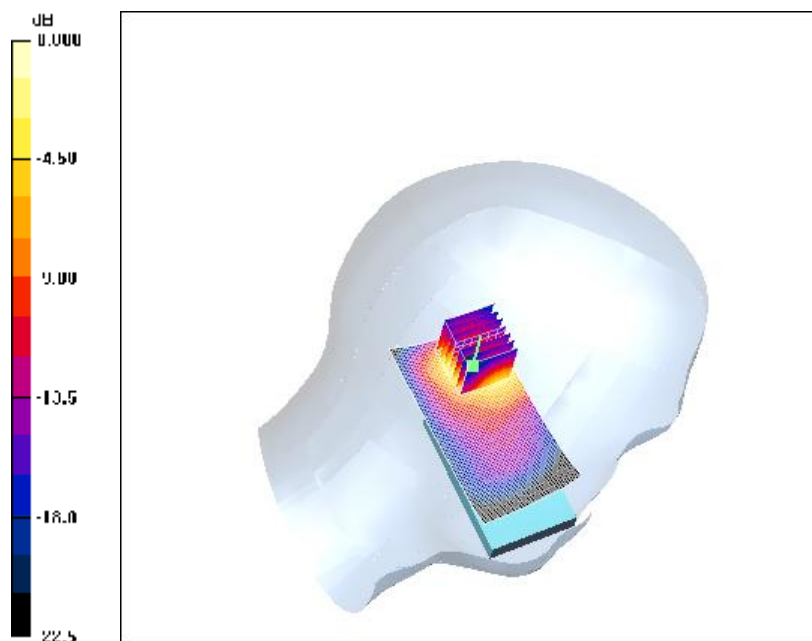

0 dB = 0.756mW/g

16.5.17 PCS1900-LeftHandSide-Tilt-High

Date/Time: 2010-5-27 10:54:24

Test Laboratory: SGS-GSM

pcs1900-LeftHandSide-Tilt-High

DUT: KL007; Type: Head&Body; Serial: 354460009000066

Communication System: PCS1900-GSM Mode; Frequency: 1909.8 MHz; Duty Cycle: 1:8.3

Medium: HSL1900_Head Medium parameters used: $f = 1909.8 \text{ MHz}$; $\sigma = 1.44 \text{ mho/m}$; $\epsilon_r = 38.8$; $\rho = 1000 \text{ kg/m}^3$

Phantom section: Left Section

DASY4 Configuration:

- Probe: ES3DV3 - SN3088; ConvF(4.97, 4.97, 4.97); Calibrated: 2009-11-19
- Sensor-Surface: 4mm (Mechanical Surface Detection)
- Electronics: DAE3 Sn569; Calibrated: 2009-11-18
- Phantom: SAM 12; Type: SAM V4.0; Serial: TP-1283
- Measurement SW: DASY4, V4.7 Build 80; Postprocessing SW: SEMCAD, V1.8 Build 186

Tilt position - High/Area Scan (41x81x1): **Measurement grid: $dx=15\text{mm}$, $dy=15\text{mm}$**

Maximum value of SAR (interpolated) = 0.777 mW/g

Tilt position - High/Zoom Scan (7x7x7) (7x7x7)/Cube 0: **Measurement grid: $dx=5\text{mm}$, $dy=5\text{mm}$, $dz=5\text{mm}$**

Reference Value = 7.65 V/m; Power Drift = 0.072 dB

Peak SAR (extrapolated) = 1.49 W/kg

SAR(1 g) = 0.727 mW/g; SAR(10 g) = 0.338 mW/g

Maximum value of SAR (measured) = 0.837 mW/g

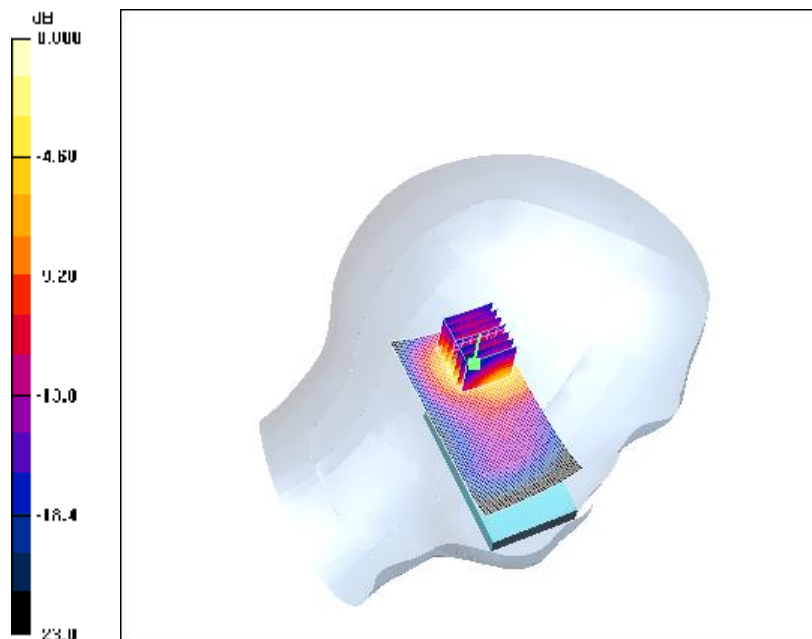

0 dB = 0.837mW/g

SHGSM

16.5.18 PCS1900-RightHandSide-Cheek-Middle

Date/Time: 2010-5-27 11:43:25

Test Laboratory: SGS-GSM

pcs1900-RightHandSide-Touch-Mid

DUT: KL007; Type: Head&Body; Serial: 354460009000066

Communication System: PCS1900-GSM Mode; Frequency: 1880 MHz;Duty Cycle: 1:8.3

Medium: HSL1900_Head Medium parameters used: f = 1880 MHz; $\sigma = 1.4$ mho/m; $\epsilon_r = 38.9$; $\rho = 1000$ kg/m³

Phantom section: Right Section

DASY4 Configuration:

- Probe: ES3DV3 - SN3088; ConvF(4.97, 4.97, 4.97); Calibrated: 2009-11-19
- Sensor-Surface: 4mm (Mechanical Surface Detection)
- Electronics: DAE3 Sn569; Calibrated: 2009-11-18
- Phantom: SAM 12; Type: SAM V4.0; Serial: TP-1283
- Measurement SW: DASY4, V4.7 Build 80; Postprocessing SW: SEMCAD, V1.8 Build 186

Cheek position - Middle/Area Scan (41x81x1): **Measurement grid: dx=15mm, dy=15mm**

Maximum value of SAR (interpolated) = 0.415 mW/g

Cheek position - Middle/Zoom Scan (7x7x7)/Cube 0: **Measurement grid: dx=5mm, dy=5mm, dz=5mm**

Reference Value = 6.78 V/m; Power Drift = 0.055 dB

Peak SAR (extrapolated) = 0.782 W/kg

SAR(1 g) = 0.401 mW/g; SAR(10 g) = 0.201 mW/g

Maximum value of SAR (measured) = 0.448 mW/g



0 dB = 0.448mW/g

16.5.19 PCS1900-RightHandSide-Tilt-Middle

Date/Time: 2010-5-27 11:20:18

Test Laboratory: SGS-GSM

pcs1900-RightHandSide-Tilt-Mid

DUT: KL007; Type: Head&Body; Serial: 354460009000066

Communication System: PCS1900-GSM Mode; Frequency: 1880 MHz;Duty Cycle: 1:8.3

Medium: HSL1900_Head Medium parameters used: f = 1880 MHz; $\sigma = 1.4$ mho/m; $\epsilon_r = 38.9$; $\rho = 1000$ kg/m³

Phantom section: Right Section

DASY4 Configuration:

- Probe: ES3DV3 - SN3088; ConvF(4.97, 4.97, 4.97); Calibrated: 2009-11-19
- Sensor-Surface: 4mm (Mechanical Surface Detection)
- Electronics: DAE3 Sn569; Calibrated: 2009-11-18
- Phantom: SAM 12; Type: SAM V4.0; Serial: TP-1283
- Measurement SW: DASY4, V4.7 Build 80; Postprocessing SW: SEMCAD, V1.8 Build 186

Tilt position - Middle/Area Scan (41x81x1): **Measurement grid: dx=15mm, dy=15mm**

Maximum value of SAR (interpolated) = 0.488 mW/g

Tilt position - Middle/Zoom Scan (7x7x7)/Cube 0: **Measurement grid: dx=5mm, dy=5mm, dz=5mm**

Reference Value = 5.38 V/m; Power Drift = 0.190 dB

Peak SAR (extrapolated) = 0.914 W/kg

SAR(1 g) = 0.461 mW/g; SAR(10 g) = 0.224 mW/g

Maximum value of SAR (measured) = 0.529 mW/g



0 dB = 0.529mW/g

16.5.20 PCS1900-RightHandSide-Tilt-Low

Date/Time: 2010-5-27 12:06:27

Test Laboratory: SGS-GSM

pcs1900-RightHandSide-Tilt-Low

DUT: KL007; Type: Head&Body; Serial: 354460009000066

Communication System: PCS1900-GSM Mode; Frequency: 1850.2 MHz; Duty Cycle: 1:8.3

Medium: HSL1900_Head Medium parameters used: $f = 1850.2$ MHz; $\sigma = 1.36$ mho/m; $\epsilon_r = 39$; $\rho = 1000$ kg/m³

Phantom section: Right Section

DASY4 Configuration:

- Probe: ES3DV3 - SN3088; ConvF(4.97, 4.97, 4.97); Calibrated: 2009-11-19
- Sensor-Surface: 4mm (Mechanical Surface Detection)
- Electronics: DAE3 Sn569; Calibrated: 2009-11-18
- Phantom: SAM 12; Type: SAM V4.0; Serial: TP-1283
- Measurement SW: DASY4, V4.7 Build 80; Postprocessing SW: SEMCAD, V1.8 Build 186

Tilt position - Low/Area Scan (41x81x1): **Measurement grid: dx=15mm, dy=15mm**

Maximum value of SAR (interpolated) = 0.509 mW/g

Tilt position - Low/Zoom Scan (7x7x7)/Cube 0: **Measurement grid: dx=5mm, dy=5mm, dz=5mm**

Reference Value = 5.79 V/m; Power Drift = -0.181 dB

Peak SAR (extrapolated) = 0.932 W/kg

SAR(1 g) = 0.475 mW/g; SAR(10 g) = 0.231 mW/g

Maximum value of SAR (measured) = 0.548 mW/g

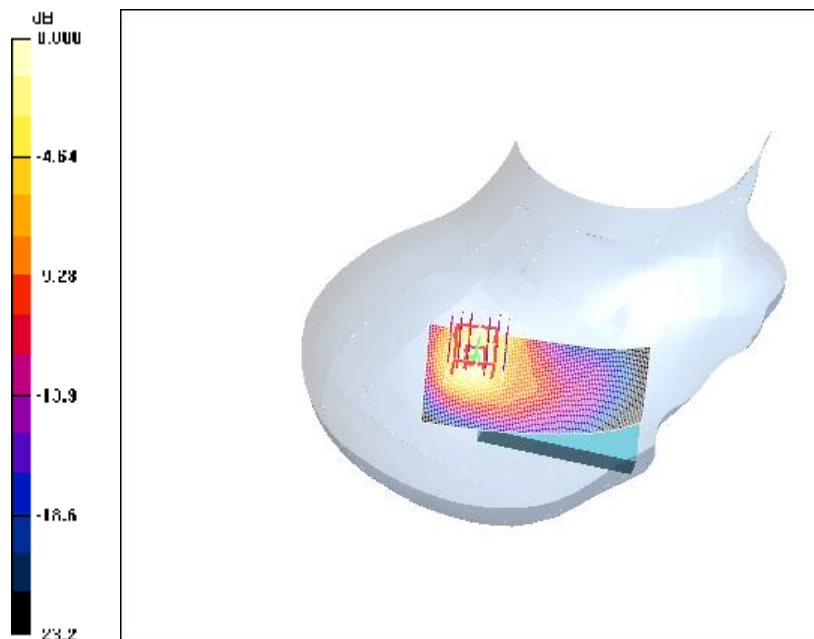

0 dB = 0.548mW/g

SHGSM

16.5.21 PCS1900-RightHandSide-Tilt-High

Date/Time: 2010-5-27 12:28:19

Test Laboratory: SGS-GSM

pcs1900-RightHandSide-Tilt-High

DUT: KL007; Type: Head&Body; Serial: 354460009000066

Communication System: PCS1900-GSM Mode; Frequency: 1909.8 MHz; Duty Cycle: 1:8.3

Medium: HSL1900_Head Medium parameters used: $f = 1909.8 \text{ MHz}$; $\sigma = 1.44 \text{ mho/m}$; $\epsilon_r = 38.8$; $\rho = 1000 \text{ kg/m}^3$

Phantom section: Right Section

DASY4 Configuration:

- Probe: ES3DV3 - SN3088; ConvF(4.97, 4.97, 4.97); Calibrated: 2009-11-19
- Sensor-Surface: 4mm (Mechanical Surface Detection)
- Electronics: DAE3 Sn569; Calibrated: 2009-11-18
- Phantom: SAM 12; Type: SAM V4.0; Serial: TP-1283
- Measurement SW: DASY4, V4.7 Build 80; Postprocessing SW: SEMCAD, V1.8 Build 186

Tilt position - High/Area Scan (41x81x1): **Measurement grid: $dx=15\text{mm}$, $dy=15\text{mm}$**

Maximum value of SAR (interpolated) = 0.501 mW/g

Tilt position - High/Zoom Scan (7x7x7)/Cube 0: **Measurement grid: $dx=5\text{mm}$, $dy=5\text{mm}$, $dz=5\text{mm}$**

Reference Value = 6.30 V/m; Power Drift = 0.070 dB

Peak SAR (extrapolated) = 0.954 W/kg

SAR(1 g) = 0.476 mW/g; SAR(10 g) = 0.230 mW/g

Maximum value of SAR (measured) = 0.532 mW/g

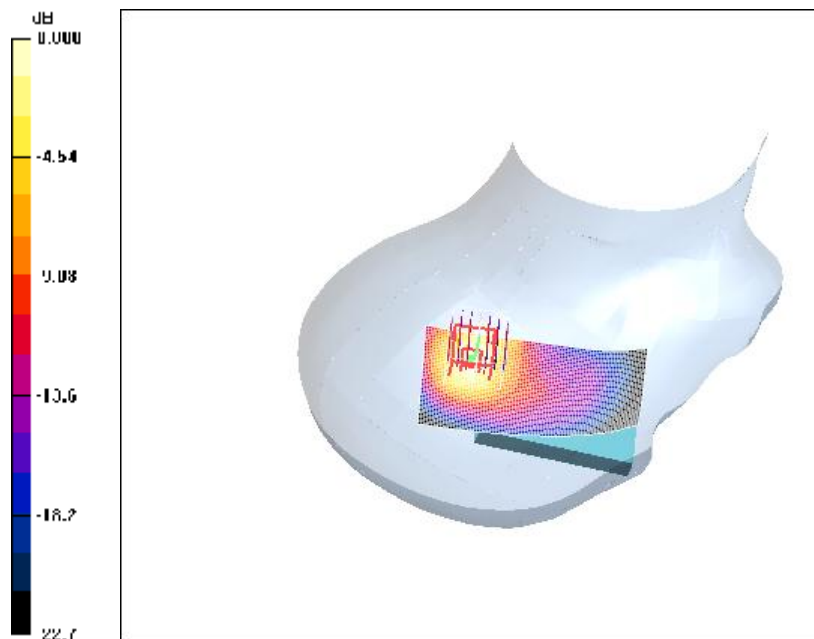

0 dB = 0.532mW/g

SHGSM

16.5.22 PCS1900-BodyWorn-GSM-Rear-Middle

Date/Time: 2010-5-27 14:10:44

Test Laboratory: SGS-GSM

PCS1900-Body-Worn-Rear-Mid

DUT: KL007; Type: Head&Body; Serial: 354460009000066

Communication System: PCS1900-GSM Mode; Frequency: 1880 MHz;Duty Cycle: 1:8.3

Medium: HSL 1900 Body Medium parameters used: f = 1880 MHz; $\sigma = 1.55$ mho/m; $\epsilon_r = 52.2$; $\rho = 1000$ kg/m³

Phantom section: Flat Section

DASY4 Configuration:

- Probe: ES3DV3 - SN3088; ConvF(4.58, 4.58, 4.58); Calibrated: 2009-11-19
- Sensor-Surface: 4mm (Mechanical Surface Detection)
- Electronics: DAE3 Sn569; Calibrated: 2009-11-18
- Phantom: SAM 12; Type: SAM V4.0; Serial: TP-1283
- Measurement SW: DASY4, V4.7 Build 80; Postprocessing SW: SEMCAD, V1.8 Build 186

Body Worn - Middle Rear/Area Scan (41x71x1): **Measurement grid: dx=15mm, dy=15mm**

Maximum value of SAR (interpolated) = 0.234 mW/g

Body Worn - Middle Rear/Zoom Scan (7x7x7)/Cube 0: **Measurement grid: dx=5mm, dy=5mm, dz=5mm**

Reference Value = 0.580 V/m; Power Drift = -0.386 dB

Peak SAR (extrapolated) = 0.441 W/kg

SAR(1 g) = 0.175 mW/g; SAR(10 g) = 0.092 mW/g

Maximum value of SAR (measured) = 0.190 mW/g

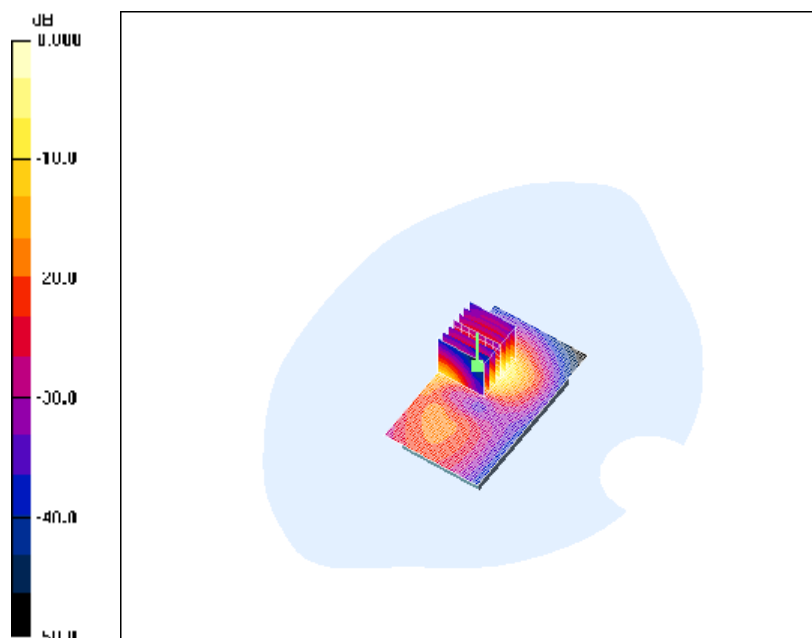

0 dB = 0.190mW/g

SHGSM

16.5.23 PCS1900-BodyWorn-GSM-Front-Middle

Date/Time: 2010-5-27 13:50:33

Test Laboratory: SGS-GSM

PCS1900-Body-Worn-Front-Mid

DUT: KL007; Type: Head&Body; Serial: 354460009000066

Communication System: PCS1900-GSM Mode; Frequency: 1880 MHz;Duty Cycle: 1:8.3

Medium: HSL 1900 Body Medium parameters used: $f = 1880 \text{ MHz}$; $\sigma = 1.55 \text{ mho/m}$; $\epsilon_r = 52.2$; $\rho = 1000 \text{ kg/m}^3$

Phantom section: Flat Section

DASY4 Configuration:

- Probe: ES3DV3 - SN3088; ConvF(4.58, 4.58, 4.58); Calibrated: 2009-11-19
- Sensor-Surface: 4mm (Mechanical Surface Detection)
- Electronics: DAE3 Sn569; Calibrated: 2009-11-18
- Phantom: SAM 12; Type: SAM V4.0; Serial: TP-1283
- Measurement SW: DASY4, V4.7 Build 80; Postprocessing SW: SEMCAD, V1.8 Build 186

Body Worn - Middle Front/Area Scan (41x71x1): **Measurement grid: $dx=15\text{mm}$, $dy=15\text{mm}$**

Maximum value of SAR (interpolated) = 0.091 mW/g

Body Worn - Middle Front/Zoom Scan (7x7x7)/Cube 0: **Measurement grid: $dx=5\text{mm}$, $dy=5\text{mm}$, $dz=5\text{mm}$**

Reference Value = 1.78 V/m; Power Drift = 0.151 dB

Peak SAR (extrapolated) = 0.134 W/kg

SAR(1 g) = 0.083 mW/g; SAR(10 g) = 0.048 mW/g

Maximum value of SAR (measured) = 0.093 mW/g

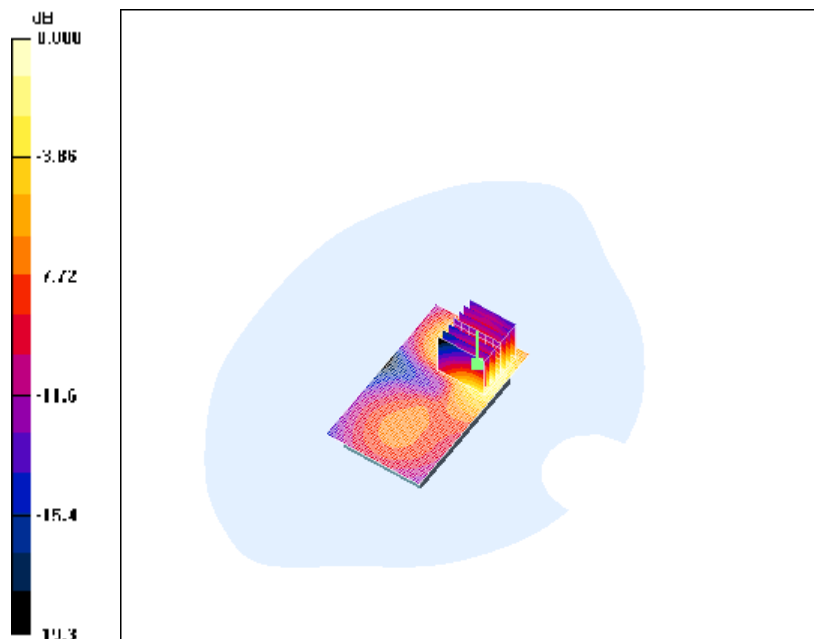

0 dB = 0.093mW/g

SHGSM

16.5.24 PCS1900-BodyWorn-GSM-Rear-Low

Date/Time: 2010-5-27 14:33:50

Test Laboratory: SGS-GSM

PCS1900-Body-Worn-Rear-Low

DUT: KL007; Type: Head&Body; Serial: 354460009000066

Communication System: PCS1900-GSM Mode; Frequency: 1850.2 MHz; Duty Cycle: 1:8.3

Medium: HSL 1900 Body Medium parameters used: $f = 1850.2 \text{ MHz}$; $\sigma = 1.51 \text{ mho/m}$; $\epsilon_r = 52.5$; $\rho = 1000 \text{ kg/m}^3$

Phantom section: Flat Section

DASY4 Configuration:

- Probe: ES3DV3 - SN3088; ConvF(4.58, 4.58, 4.58); Calibrated: 2009-11-19
- Sensor-Surface: 4mm (Mechanical Surface Detection)
- Electronics: DAE3 Sn569; Calibrated: 2009-11-18
- Phantom: SAM 12; Type: SAM V4.0; Serial: TP-1283
- Measurement SW: DASY4, V4.7 Build 80; Postprocessing SW: SEMCAD, V1.8 Build 186

Body Worn - Low Rear/Area Scan (41x71x1): **Measurement grid: $dx=15\text{mm}$, $dy=15\text{mm}$**

Maximum value of SAR (interpolated) = 0.196 mW/g

Body Worn - Low Rear/Zoom Scan (7x7x7)/Cube 0: **Measurement grid: $dx=5\text{mm}$, $dy=5\text{mm}$, $dz=5\text{mm}$**

Reference Value = 2.35 V/m; Power Drift = -0.009 dB

Peak SAR (extrapolated) = 0.307 W/kg

SAR(1 g) = 0.183 mW/g; SAR(10 g) = 0.100 mW/g

Maximum value of SAR (measured) = 0.205 mW/g

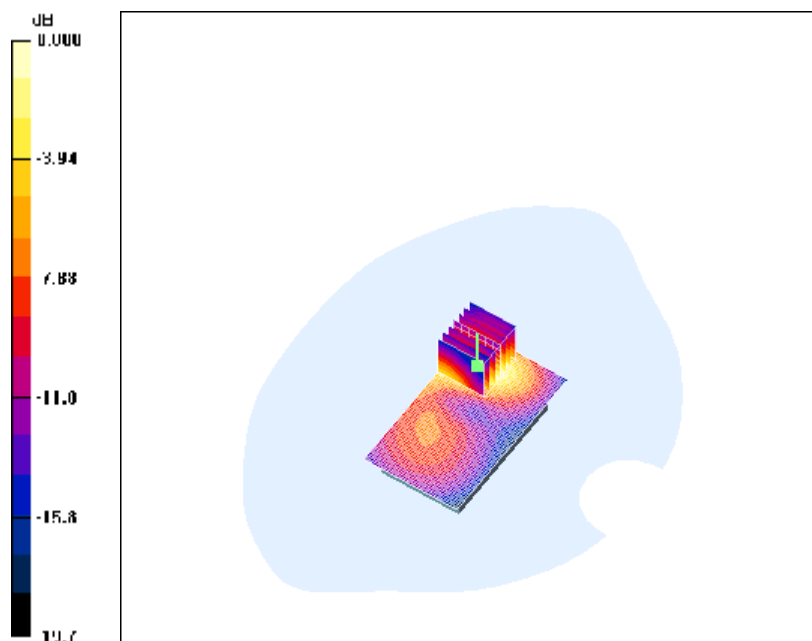

0 dB = 0.205mW/g

SHGSM

16.5.25 PCS1900-BodyWorn-GSM-Rear-High

Date/Time: 2010-5-27 14:53:33

Test Laboratory: SGS-GSM

PCS1900-Body-Worn-Rear-High

DUT: KL007; Type: Head&Body; Serial: 354460009000066

Communication System: PCS1900-GSM Mode; Frequency: 1909.8 MHz; Duty Cycle: 1:8.3

Medium: HSL 1900 Body Medium parameters used: $f = 1909.8 \text{ MHz}$; $\sigma = 1.58 \text{ mho/m}$; $\epsilon_r = 52$; $\rho = 1000 \text{ kg/m}^3$

Phantom section: Flat Section

DASY4 Configuration:

- Probe: ES3DV3 - SN3088; ConvF(4.58, 4.58, 4.58); Calibrated: 2009-11-19
- Sensor-Surface: 4mm (Mechanical Surface Detection)
- Electronics: DAE3 Sn569; Calibrated: 2009-11-18
- Phantom: SAM 12; Type: SAM V4.0; Serial: TP-1283
- Measurement SW: DASY4, V4.7 Build 80; Postprocessing SW: SEMCAD, V1.8 Build 186

Body Worn - High Rear/Area Scan (41x71x1): **Measurement grid: $dx=15\text{mm}$, $dy=15\text{mm}$**

Maximum value of SAR (interpolated) = 0.190 mW/g

Body Worn - High Rear/Zoom Scan (7x7x7)/Cube 0: **Measurement grid: $dx=5\text{mm}$, $dy=5\text{mm}$, $dz=5\text{mm}$**

Reference Value = 0.941 V/m; Power Drift = 0.363 dB

Peak SAR (extrapolated) = 0.289 W/kg

SAR(1 g) = 0.173 mW/g; SAR(10 g) = 0.093 mW/g

Maximum value of SAR (measured) = 0.193 mW/g

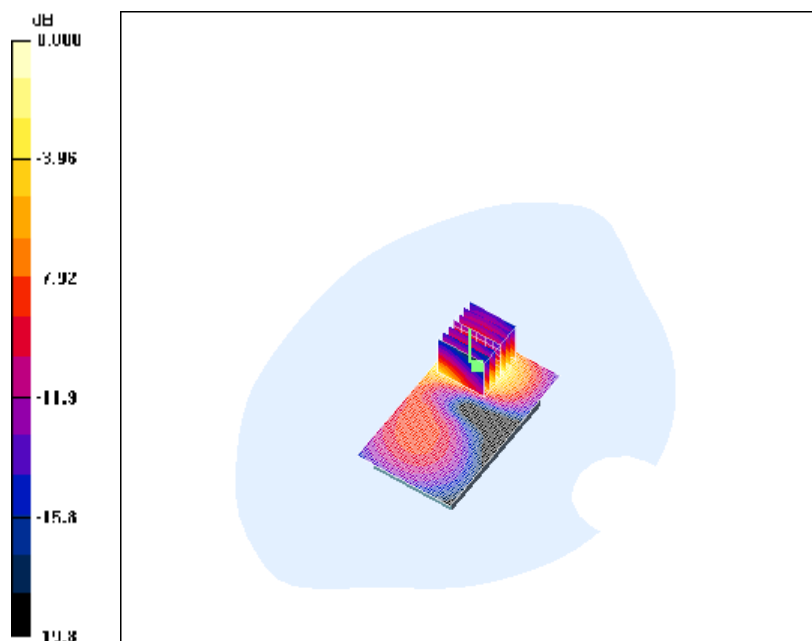

0 dB = 0.193mW/g

SHGSM

16.5.26 PCS1900-BodyWorn-GSM-Worstcase With Headset

Date/Time: 2010-5-27 15:19:30

Test Laboratory: SGS-GSM

PCS1900-Body-Worn-Rear-Low With Headset

DUT: KL007; Type: Head&Body; Serial: 354460009000066

Communication System: PCS1900-GSM Mode; Frequency: 1850.2 MHz;Duty Cycle: 1:8.3

Medium: HSL 1900 Body Medium parameters used: f =1850.2 MHz; σ =1.51 mho/m; ϵ_r =52.5; ρ =1000 kg/m³

Phantom section: Flat Section

DASY4 Configuration:

- Probe: ES3DV3 - SN3088; ConvF(4.58, 4.58, 4.58); Calibrated: 2009-11-19
- Sensor-Surface: 4mm (Mechanical Surface Detection)
- Electronics: DAE3 Sn569; Calibrated: 2009-11-18
- Phantom: SAM 12; Type: SAM V4.0; Serial: TP-1283
- Measurement SW: DASY4, V4.7 Build 80; Postprocessing SW: SEMCAD, V1.8 Build 186

Body Worn - Low Rear With Headset/Area Scan (41x71x1): **Measurement grid: dx=15mm, dy=15mm**

Maximum value of SAR (interpolated) = 0.222 mW/g

Body Worn - Low Rear With Headset/Zoom Scan (7x7x7)/Cube 0: **Measurement grid: dx=5mm, dy=5mm, dz=5mm**

Reference Value = 8.01 V/m; Power Drift = 0.027 dB

Peak SAR (extrapolated) = 0.314 W/kg

SAR(1 g) = 0.191 mW/g; SAR(10 g) = 0.104 mW/g

Maximum value of SAR (measured) = 0.216 mW/g

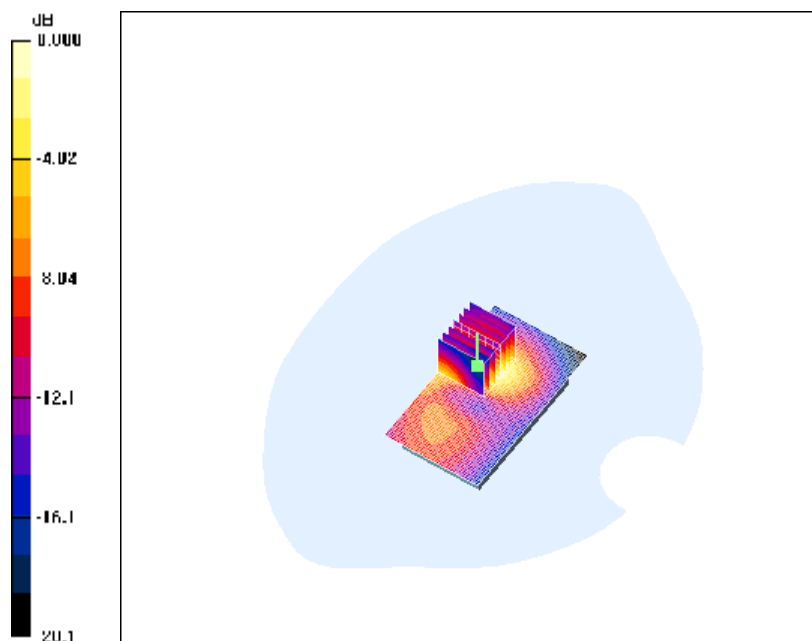

0 dB = 0.216mW/g

SHGSM

17. Identification of Samples

Product Name	GSM Mobile	
Brand Name	Lanix	
Marketing Name	W10	
Final Hardware Version	X17D	
Final Software Version	X17DV1.0.0B01	
Normal Voltage	3.7V	
Low Voltage	3.5V	
High Voltage	4.2V	
Battery Type	Lanix W10-BAT	
	400mAh, 3.7V	
Antenna Type	Inner antenna	
GSM Frequency Bands	GSM850	Tx: 824~849MHz
		Rx: 869~894MHz
	PCS1900	Tx:1850~1910MHz
		Rx:1930~1990MHz
Modulation Mode	GMSK	
GSM Power Class	GSM850	4
	PCS1900	1
Reference Number	KL007AG01	
IMEI	35446000900006618	
Date of receipt	05-24,2010	
Date of Testing Start	05-26,2010	
Date of Testing End	05-27,2010	

18. Photographs of EUT



Fig.18-1 Front View

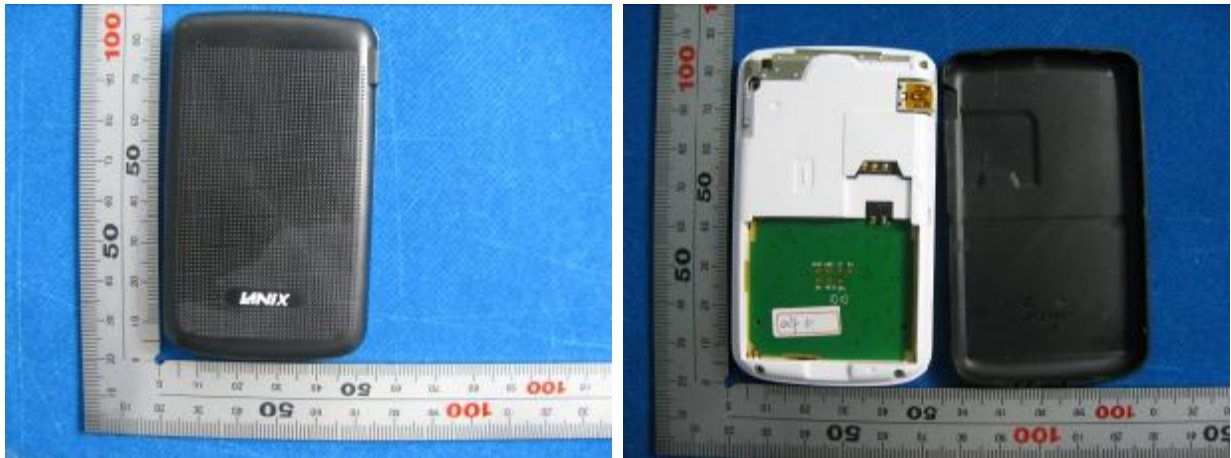

Fig.18-2 Back View

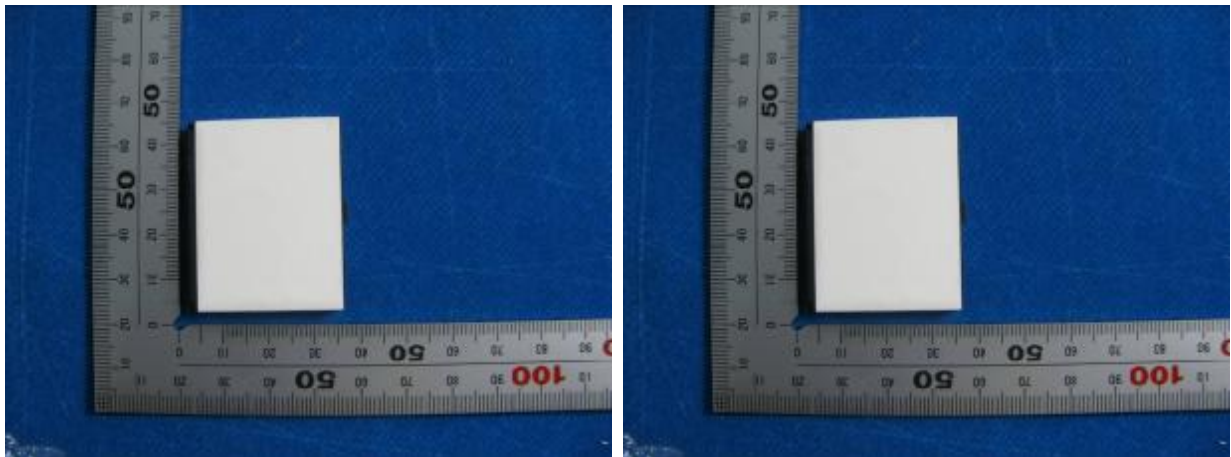

Fig.18-3 Battery



Fig.18-4 label of battery



Fig.18-5 Headset

Annex A Photographs of Test Setup

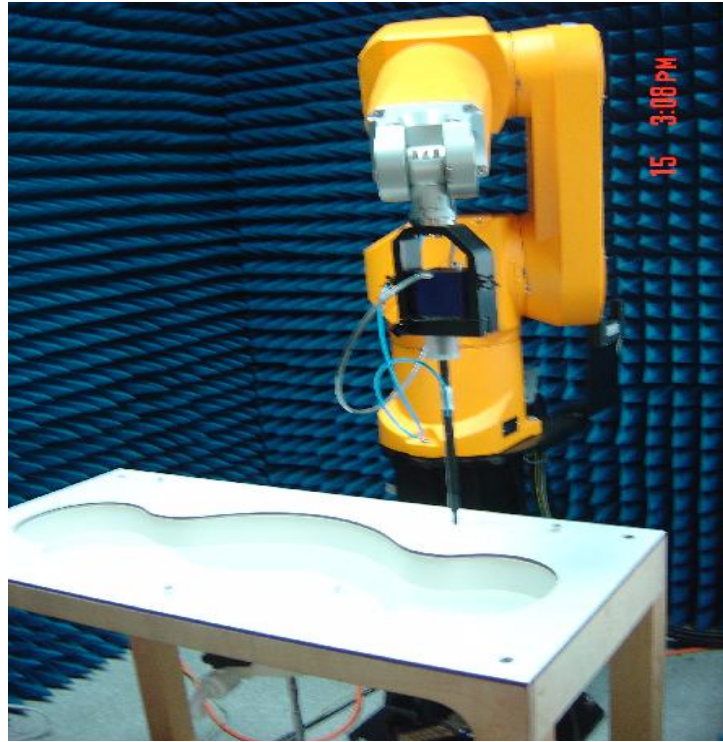

Fig.A-1 Photograph of the SAR measurement System

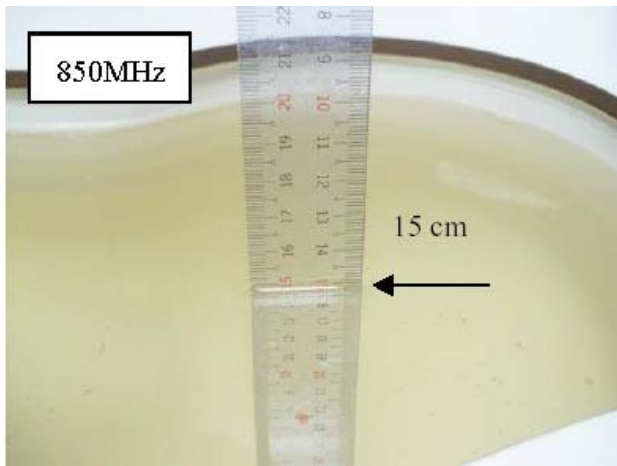

Fig.A-2a Photograph of the Tissue Simulant Liquid depth 15cm for Head

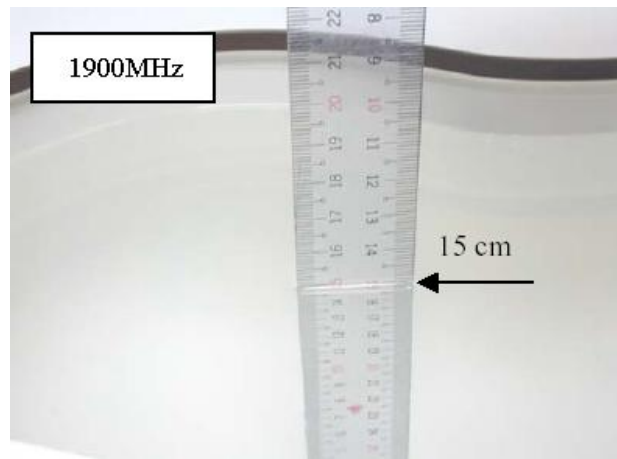

Fig.A-2b Photograph of the Tissue Simulant Liquid depth 15cm for Head

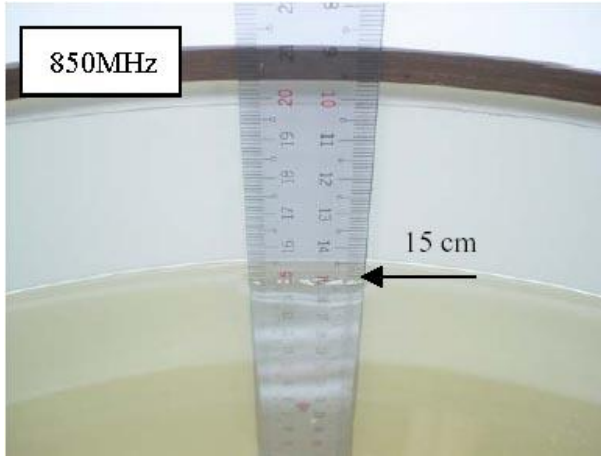

Fig.A-3a Photograph of the Tissue Simulant Liquid depth 15cm for Body Worn

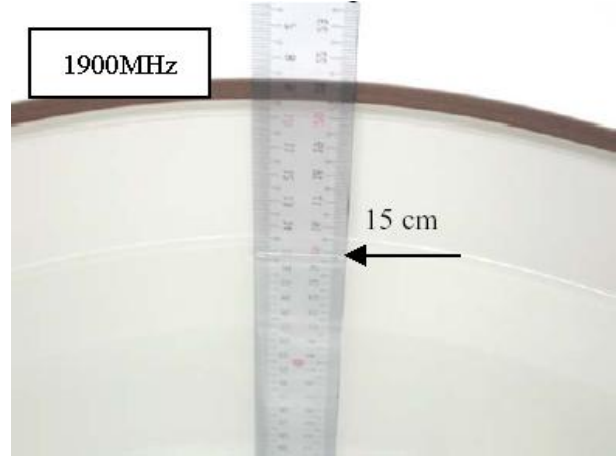

Fig.A-3b Photograph of the Tissue Simulant Liquid depth 15cm for Body Worn

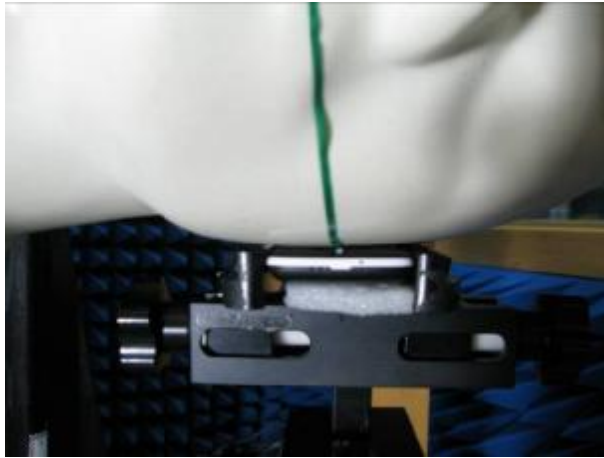

Fig.A-4a Photograph of the Left Hand Side Cheek status

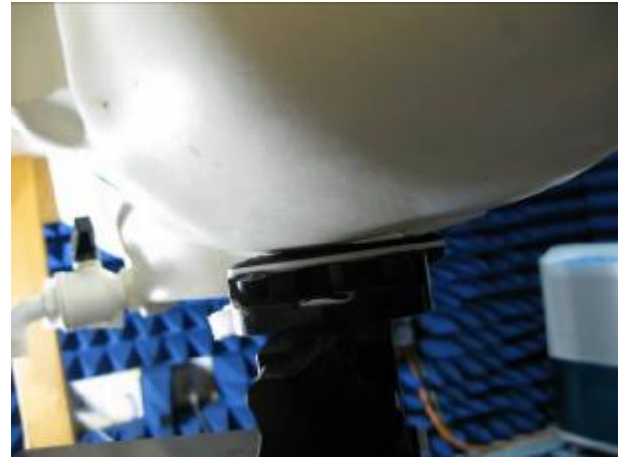
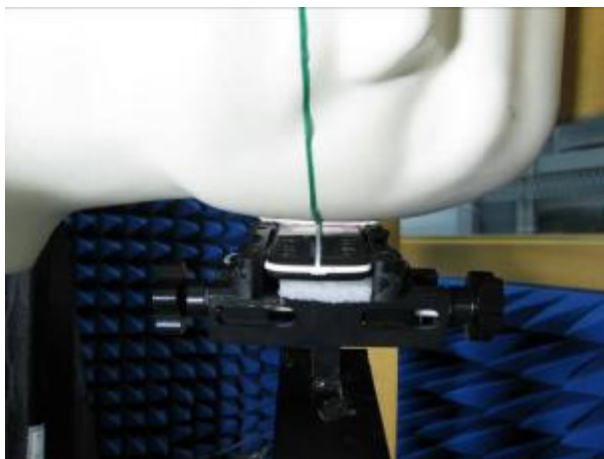

Fig.A-4b Photograph of the Left Hand Side Tilted status



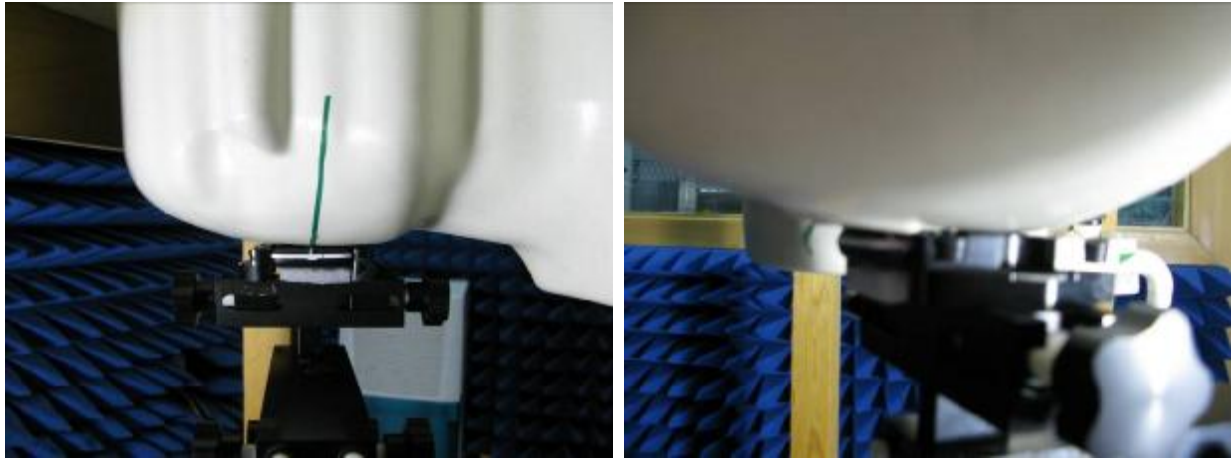

Fig.A-4c Photograph of the Right Hand Side Cheek status



Fig.A-4d Photograph of the Right Hand Side Tilted status



Fig.A-4e Photograph of the Body Worn status

Annex B Tissue Simulant Liquid

Annex B.1 Recipes for Tissue Simulant Liquid

The following tables give the recipes for tissue simulating liquids to be used in different frequency bands.

Frequency (MHz)	835		900		1800-2000	
Tissue Type	Head	Body	Head	Body	Head	Body
Ingredient (% by weight)						
Water	40.30	50.75	40.30	50.75	55.24	70.17
Salt (NaCl)	1.38	0.94	1.38	0.94	0.31	0.39
Sucrose	57.90	48.21	57.90	48.21	0	0
HEC	0.24	0	0.24	0	0	0
Bactericide	0.18	0.10	0.10	0.10	0	0
DGBE	0	0	0	0	44.45	29.44
Measurement dielectric parameters						
Dielectric Constant	41.9	55.0	41.1	54.5	39.2	53.2
Conductivity (S/m)	0.93	0.97	1.04	1.06	1.45	1.59
Target values						
Dielectric Constant	41.5	55.2	41.5	55.0	40.0	53.3
Conductivity (S/m)	0.90	0.97	0.97	1.05	1.40	1.52
Salt: 99+% Pure Sodium Chloride			Sucrose: 98+% Pure Sucrose			
Water: De-ionized, 16 MΩ ⁺ resistivity			HEC: Hydroxyethyl Cellulose			
DGBE: 99+% Di(ethylene glycol) butyl ether, [2-(2-butoxyethoxy)ethanol]						

Table B-1 Recipe of Tissue Simulant Liquid

Annex B.2 Measurement for Tissue Simulant Liquid

The dielectric properties for this Tissue Simulant Liquids were measured by using the Agilent Model 85070D Dielectric Probe (rates frequency band 200 MHz to 20 GHz) in conjunction with Agilent E5071B Network Analyzer (300 KHz-8500 MHz). The Conductivity (σ) and Permittivity (ρ) are listed in Table 1. For the SAR measurement given in this report. The temperature variation of the Tissue Simulant Liquids was 22±2°C.

Frequency (MHz)	Tissue Type	Limit/Measured	Permittivity (ρ)	Conductivity (σ)	Temp (°C)
835	Head	Recommended Limit	41.5±5% (39.43~43.57)	0.90±5% (0.86~0.94)	22±2
		Measured, 05-26,2010	42.70	0.90	22.3
	Body	Recommended Limit	55.2±5% (52.44~57.96)	0.97±5% (0.92~1.01)	22±2
		Measured, 05-26,2010	55.14	0.95	21.9

SHGSM

1900	Head	Recommended Limit	40±5% (38-42)	1.40±5% (1.33~1.47)	22±2
		Measured, 05-27,2010	38.9	1.42	22.3
	Body	Recommended Limit	53.3±5% (50.64~55.96)	1.52±5% (1.45~1.59)	22±2
		Measured, 05-27,2010	52.1	1.57	22.7

Table B-2 Measurement result of Tissue electric parameters

Annex C SAR System Validation

The microwave circuit arrangement for system verification is sketched in Fig. C-1. The daily system accuracy verification occurs within the flat section of the SAM phantom. A SAR measurement was performed to see if the measured SAR was within +/- 10% from the target SAR values. These tests were done at 835&1900MHz. The tests were conducted on the same days as the measurement of the EUT. The obtained results from the system accuracy verification are displayed in the table C-1 (A power level of 250mw was input to the dipole antenna). During the tests, the ambient temperature of the laboratory was in the range 22°C, the relative humidity was in the range 60% and the liquid depth above the ear reference points was above 15 cm in all the cases. It is seen that the system is operating within its specification, as the results are within acceptable tolerance of the reference values.

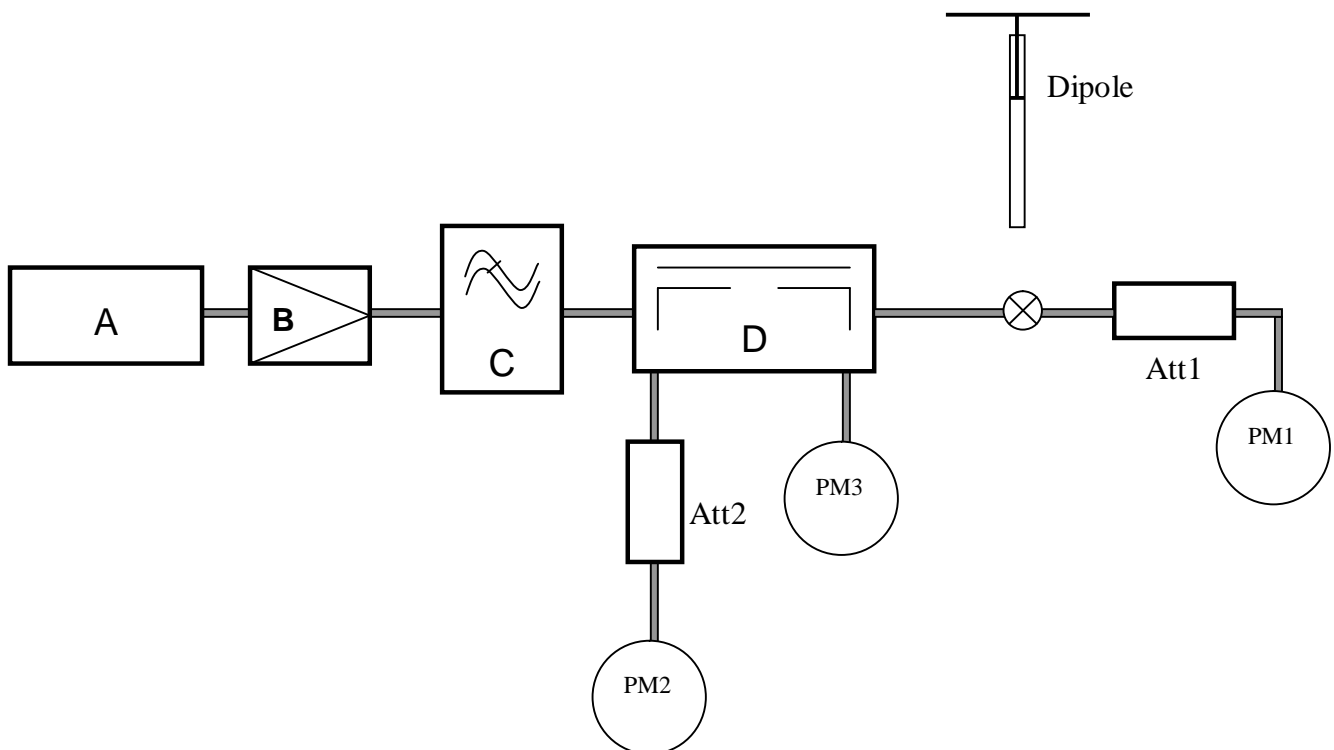

Fig. C-1 the microwave circuit arrangement used for SAR system verification

A. Agilent E4438C Signal Generator

- B. Mini-Circuit ZHL-42 Preamplifier
- C. Mini-Circuit VLF-2500+ Low Pass Filter
- D. Mini-Circuits ZABDC20-252H-N+ Bi-DIR Coupling
- PM1. Power Sensor NRP-Z92
- PM2. Agilent Model E4416A Power Meter
- PM3. Power Sensor NRP-Z92

Validation Kit	Frequency (MHz)	Tissue Type	Limit/Measurement		
			Condition	Recommended/Measured	1g
D835V2	835	Head	Normalized to 1mW(for nominal Head TSL parameters)	Recommended Limit	9.62±10% (8.66-10.58)
			Normalized to 1W(for nominal Head TSL parameters)	-	9.94
			250mW input power	Measured, 05-26, 2010	2.47
		Body	Normalized to 1mW(for nominal Head TSL parameters)	Recommended Limit	9.89±10% (8.90-10.87)
			Normalized to 1W(for nominal Head TSL parameters)	-	10.07
			250mW input power	Measured, 05-26, 2010	2.48
D1900V2	1900	Head	Normalized to 1W(for nominal Head TSL parameters)	Recommended Limit	39.3±10% (35.37-43.23)
			Normalized to 1W(for nominal Head TSL parameters)	-	41.39
			250mW input power	Measured, 05-27, 2010	10.6
		Body	Normalized to 1mW(for nominal Head TSL parameters)	Recommended Limit	40.4±10% (36.36-44.44)
			Normalized to 1W(for nominal Head TSL parameters)	-	41.77
			250mW input power	Measured, 05-27, 2010	10.7

Table C-1 SAR System Validation Result

System Validation for 835MHz-Head

Date/Time: 2010-5-26 13:11:03

Test Laboratory: SGS-GSM

System-Validation-D835-Head

DUT: Dipole 835MHz; Type: D835V2; Serial: D835V2 - SN:4d070

Communication System: CW; Frequency: 835 MHz; Duty Cycle: 1:1

Medium: HSL835_Head Medium parameters used: $f = 835 \text{ MHz}$; $\sigma = 0.896 \text{ mho/m}$; $\epsilon_r = 42.9$; $\rho = 1000 \text{ kg/m}^3$

Phantom section: Flat Section

DASY4 Configuration:

- Probe: ES3DV3 - SN3088; ConvF(5.84, 5.84, 5.84); Calibrated: 2009-11-19
- Sensor-Surface: 4mm (Mechanical Surface Detection)
- Electronics: DAE3 Sn569; Calibrated: 2009-11-18
- Phantom: SAM 12; Type: SAM V4.0; Serial: TP-1283
- Measurement SW: DASY4, V4.7 Build 80; Postprocessing SW: SEMCAD, V1.8 Build 186

$d=15\text{mm}$, $P_{in}=250\text{mW}$ /Area Scan (61x121x1): **Measurement grid: $dx=15\text{mm}$, $dy=15\text{mm}$**

Maximum value of SAR (interpolated) = 2.63 mW/g

$d=15\text{mm}$, $P_{in}=250\text{mW}$ /Zoom Scan (7x7x7) (7x7x7)/Cube 0: **Measurement grid: $dx=5\text{mm}$, $dy=5\text{mm}$, $dz=5\text{mm}$**

Reference Value = 55.2 V/m; Power Drift = -0.168 dB

Peak SAR (extrapolated) = 3.76 W/kg

SAR(1 g) = 2.47 mW/g; SAR(10 g) = 1.6 mW/g

Maximum value of SAR (measured) = 2.66 mW/g

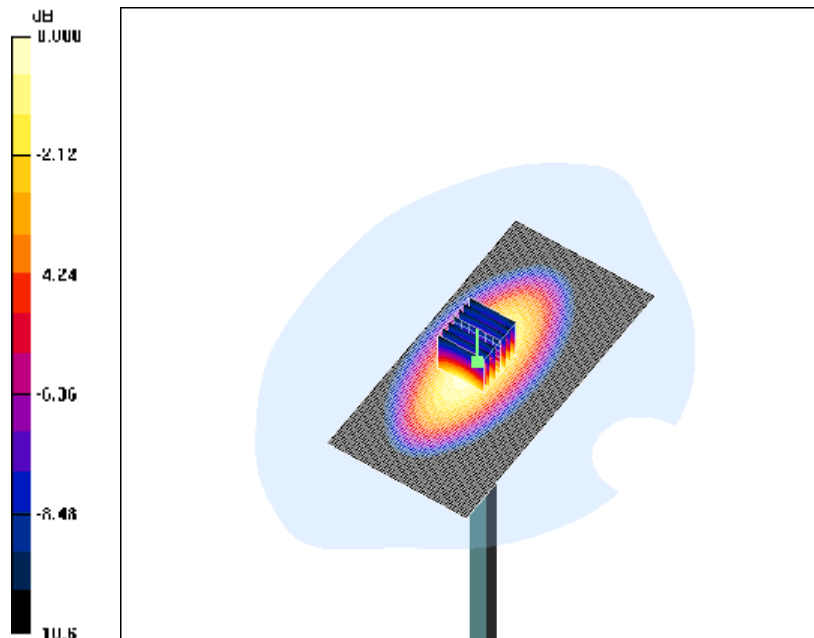

0 dB = 2.66mW/g

SHGSM

System Validation for 835MHz-Body

Date/Time: 2010-5-26 9:38:52

Test Laboratory: SGS-GSM

System-Validation-D835-Body

DUT: Dipole 835MHz; Type: D835V2; Serial: D835V2 - SN:4d070

Communication System: CW; Frequency: 835 MHz; Duty Cycle: 1:1

Medium: HSL835 Body Medium parameters used: $f = 835 \text{ MHz}$; $\sigma = 0.952 \text{ mho/m}$; $\epsilon_r = 55.1$; $\rho = 1000 \text{ kg/m}^3$

Phantom section: Flat Section

DASY4 Configuration:

- Probe: ES3DV3 - SN3088; ConvF(5.68, 5.68, 5.68); Calibrated: 2009-11-19
- Sensor-Surface: 4mm (Mechanical Surface Detection)
- Electronics: DAE3 Sn569; Calibrated: 2009-11-18
- Phantom: SAM 12; Type: SAM V4.0; Serial: TP-1283
- Measurement SW: DASY4, V4.7 Build 80; Postprocessing SW: SEMCAD, V1.8 Build 186

$d=15\text{mm}$, $P_{in}=250\text{mW}$ /Area Scan (61x121x1): **Measurement grid: $dx=15\text{mm}$, $dy=15\text{mm}$**

Maximum value of SAR (interpolated) = 2.65 mW/g

$d=15\text{mm}$, $P_{in}=250\text{mW}$ /Zoom Scan (7x7x7) (7x7x7)/Cube 0: **Measurement grid: $dx=5\text{mm}$, $dy=5\text{mm}$, $dz=5\text{mm}$**

Reference Value = 52.5 V/m; Power Drift = -0.027 dB

Peak SAR (extrapolated) = 3.70 W/kg

SAR(1 g) = 2.48 mW/g; SAR(10 g) = 1.63 mW/g

Maximum value of SAR (measured) = 2.69 mW/g

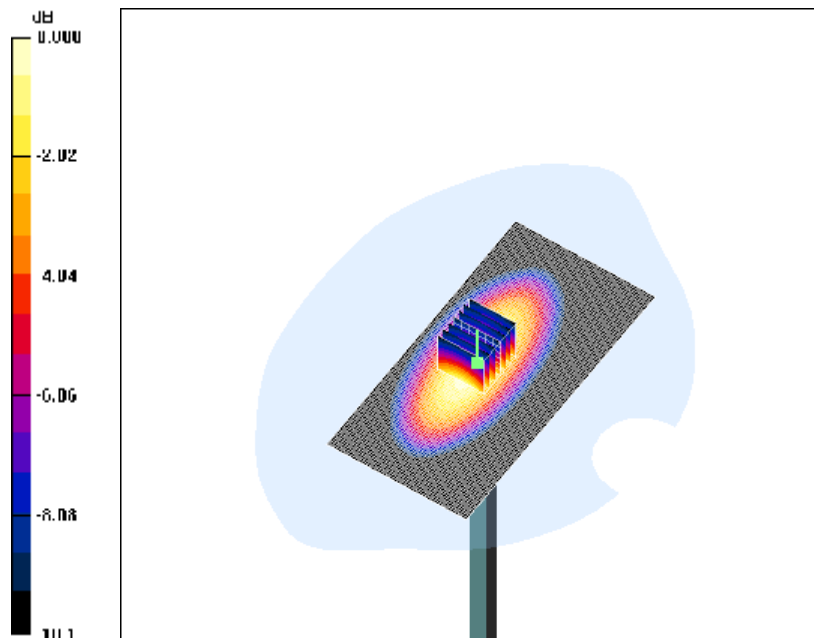

0 dB = 2.69mW/g

System Validation for 1900MHz-Head

Date/Time: 2010-5-27 8:38:46

Test Laboratory: SGS-GSM

System-Validation-D1900-Head

DUT: Dipole 1900 MHz; Type: D1900V2; Serial: D1900V2 - SN:5d028

Communication System: CW; Frequency: 1900 MHz; Duty Cycle: 1:1

Medium: HSL1900_Head Medium parameters used: $f = 1900$ MHz; $\sigma = 1.43$ mho/m; $\epsilon_r = 38.8$; $\rho = 1000$ kg/m³

Phantom section: Flat Section

DASY4 Configuration:

- Probe: ES3DV3 - SN3088; ConvF(4.97, 4.97, 4.97); Calibrated: 2009-11-19
- Sensor-Surface: 4mm (Mechanical Surface Detection)
- Electronics: DAE3 Sn569; Calibrated: 2009-11-18
- Phantom: SAM 12; Type: SAM V4.0; Serial: TP-1283
- Measurement SW: DASY4, V4.7 Build 80; Postprocessing SW: SEMCAD, V1.8 Build 186

d=10mm, Pin=250mW/Area Scan (61x101x1): **Measurement grid: dx=15mm, dy=15mm**

Maximum value of SAR (interpolated) = 12.5 mW/g

d=10mm, Pin=250mW/Zoom Scan (7x7x7) (7x7x7)/Cube 0: **Measurement grid: dx=5mm, dy=5mm, dz=5mm**

Reference Value = 90.8 V/m; Power Drift = -0.149 dB

Peak SAR (extrapolated) = 20.0 W/kg

SAR(1 g) = 10.6 mW/g; SAR(10 g) = 5.47 mW/g

Maximum value of SAR (measured) = 11.9 mW/g

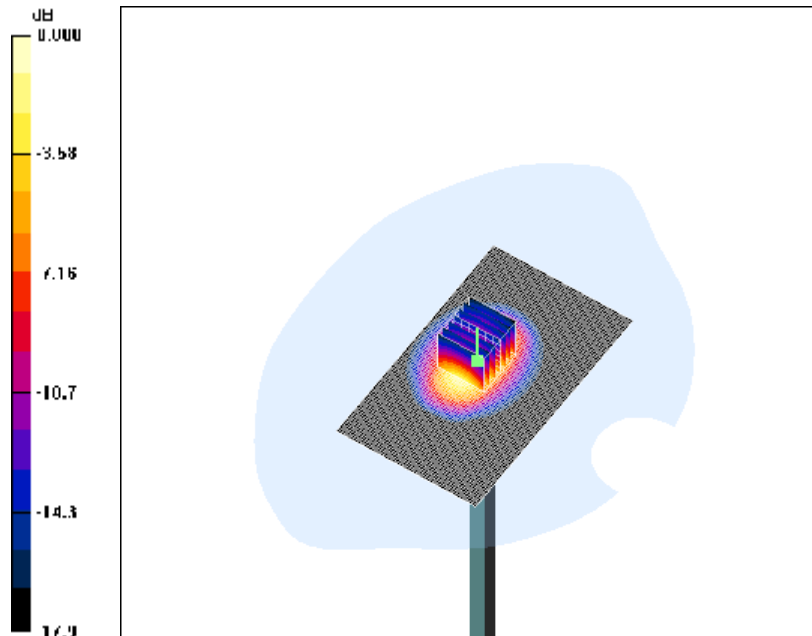

0 dB = 11.9mW/g

System Validation for 1900MHz-Body

Date/Time: 2010-5-27 13:23:11

Test Laboratory: SGS-GSM

System-Validation-D1900-Body

DUT: Dipole 1900 MHz; Type: D1900V2; Serial: D1900V2 - SN:5d028

Communication System: CW; Frequency: 1900 MHz; Duty Cycle: 1:1

Medium: HSL 1900 Body Medium parameters used: $f = 1900 \text{ MHz}$; $\sigma = 1.57 \text{ mho/m}$; $\epsilon_r = 52.1$; $\rho = 1000 \text{ kg/m}^3$

Phantom section: Flat Section

DASY4 Configuration:

- Probe: ES3DV3 - SN3088; ConvF(4.58, 4.58, 4.58); Calibrated: 2009-11-19
- Sensor-Surface: 4mm (Mechanical Surface Detection)
- Electronics: DAE3 Sn569; Calibrated: 2009-11-18
- Phantom: SAM 12; Type: SAM V4.0; Serial: TP-1283
- Measurement SW: DASY4, V4.7 Build 80; Postprocessing SW: SEMCAD, V1.8 Build 186

$d=10\text{mm}$, $P_{in}=250\text{mW}$ /Area Scan (61x101x1): **Measurement grid: $dx=15\text{mm}$, $dy=15\text{mm}$**

Maximum value of SAR (interpolated) = 12.8 mW/g

$d=10\text{mm}$, $P_{in}=250\text{mW}$ /Zoom Scan (7x7x7) (7x7x7)/Cube 0: **Measurement grid: $dx=5\text{mm}$, $dy=5\text{mm}$, $dz=5\text{mm}$**

Reference Value = 90.9 V/m; Power Drift = -0.012 dB

Peak SAR (extrapolated) = 19.1 W/kg

SAR(1 g) = 10.7 mW/g; SAR(10 g) = 5.56 mW/g

Maximum value of SAR (measured) = 12.2 mW/g

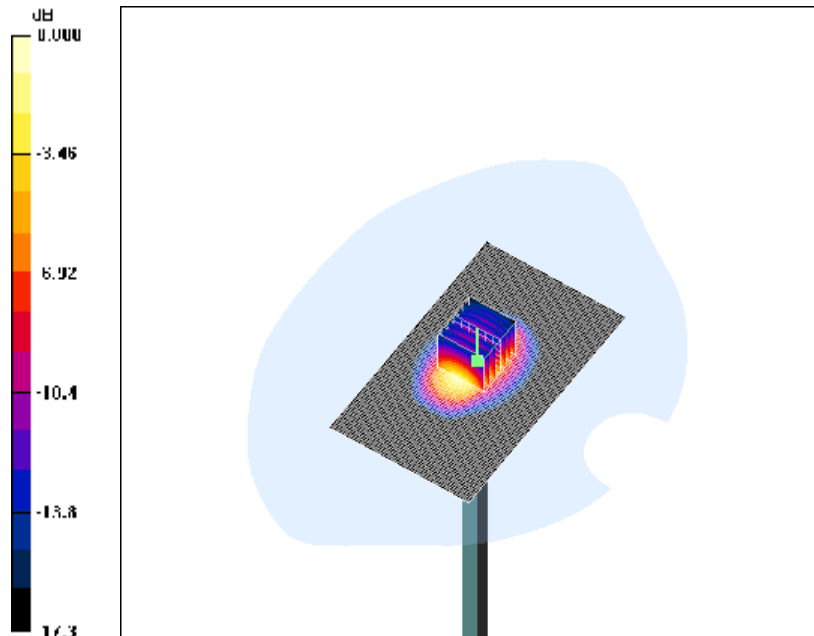

0 dB = 12.2mW/g

SHGSM

Annex D Description of Test Position

Annex D.1 SAM Phantom Shape

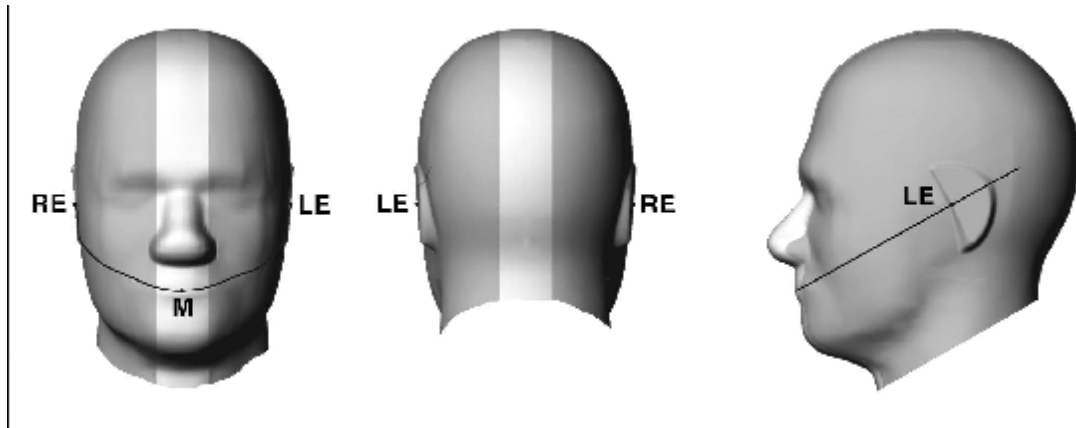

Figure D-1 front, back, and side views of SAM (model for the phantom shell). Full-head model is for illustration purposes only-procedures in this recommended practice are intended primarily for the phantom setup of Figure D-2. Note: The center strip including the nose region has a different thickness tolerance.

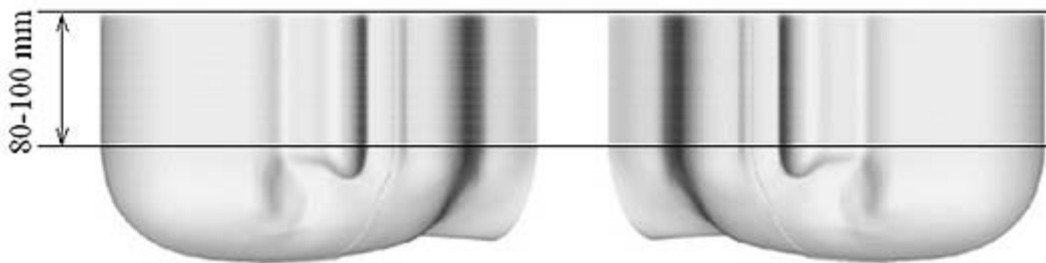

Figure D-2 Sagittally bisected phantom with extended perimeter (shown placed on its side as used for SAR measurements)

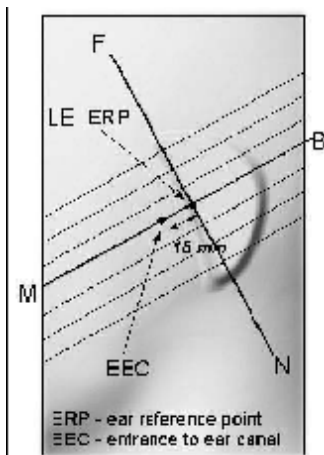

Figure D-3 Close-up side view of phantom showing the ear region, N-F and B-M lines, and seven cross-sectional plane locations

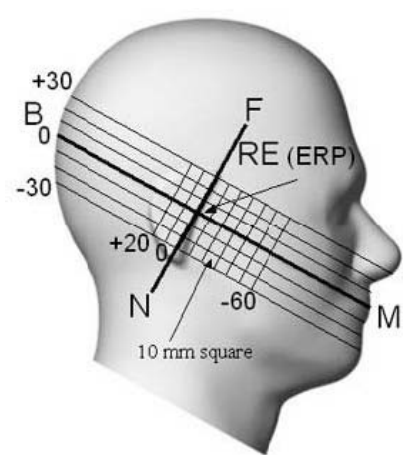

Figure D-4 Side view of the phantom showing relevant markings and seven cross-sectional plane locations

Annex D.2 EUT constructions

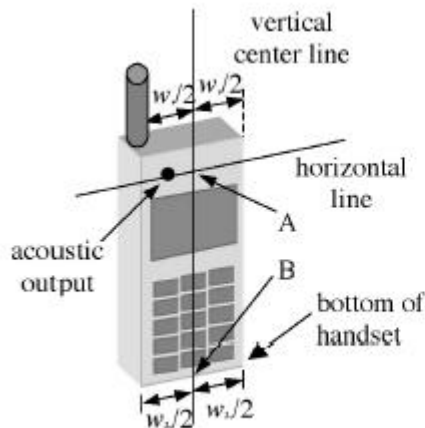

Figure D-5a Handset vertical and horizontal reference lines-“fixed case”

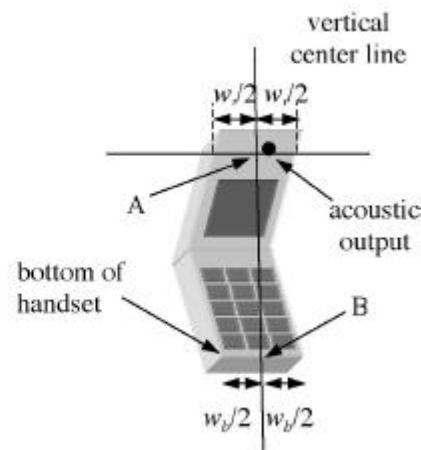

Figure D-5b Handset vertical and horizontal reference lines-“clam-shell case”

Annex D.3 Definition of the “cheek” position

- Position the device with the vertical centre line of the body of the device and the horizontal line crossing the centre of the ear piece in a plane parallel to the sagittal plane of the phantom ("initial position" see Figure 1-7). While maintaining the device in this plane, align the vertical centre line with the reference plane containing the three ear and mouth reference points (M, RE and LE) and align the centre of the ear piece with the line RE-LE;
- Translate the mobile phone box towards the phantom with the ear piece aligned with the line LE-RE until the phone touches the ear. While maintaining the device in the reference plane and maintaining the phone contact with the ear, move the bottom of the box until any point on the front side is in contact with the cheek of the phantom or until contact with the ear is lost.

Annex D.4 Definition of the “tilted” position

- Position the device in the “cheek” position described above;
- While maintaining the device in the reference plane described above and pivoting against the ear, move it outward away from the mouth by an angle of 15 degrees or until contact with the ear is lost.

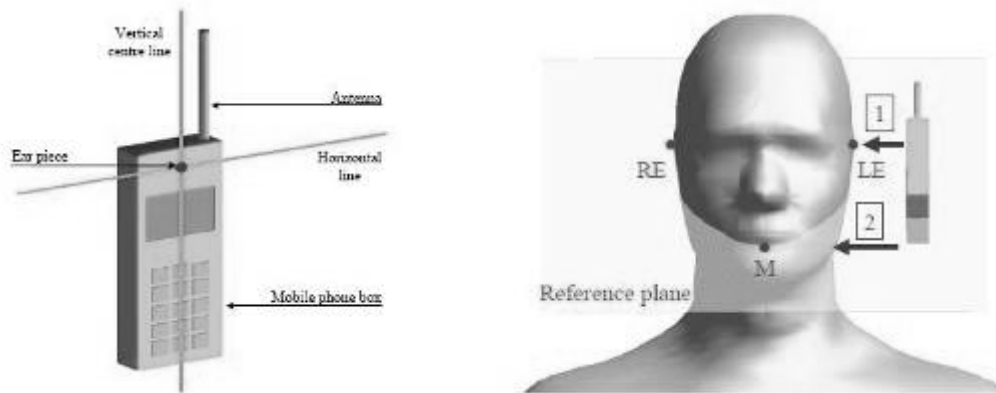

Figure D-6 Definition of the reference lines and points, on the phone and on the phantom and initial position

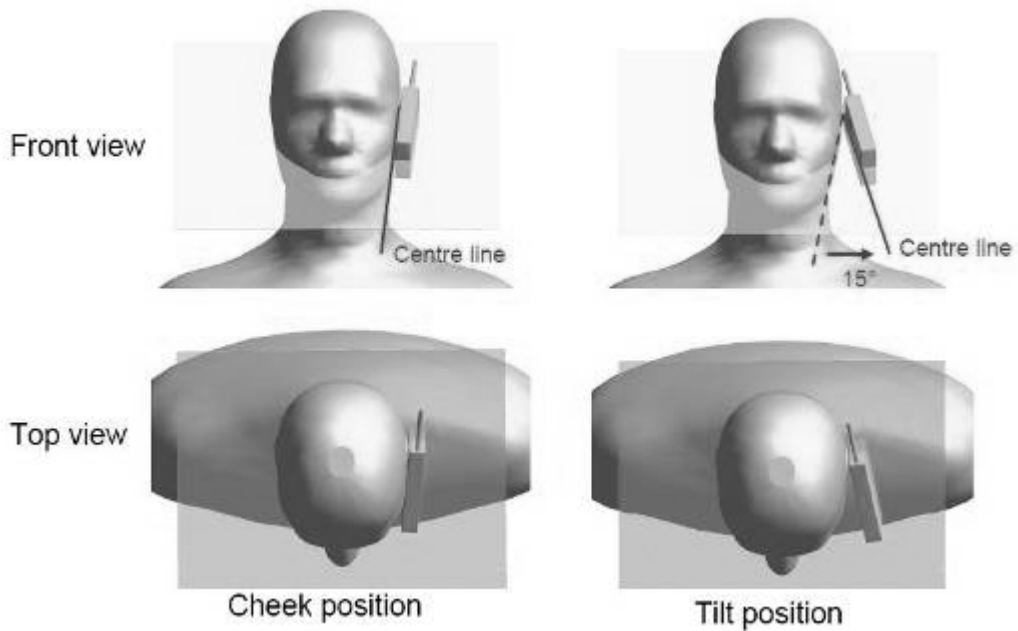

Figure D-7 “Cheek” and “tilt” positions of the mobile phone on the left side

Annex E Calibration certificate
Annex E.1 Probe Calibration certificate

Calibration Laboratory of
 Schmid & Partner
 Engineering AG
 Zeughausstrasse 43, 8004 Zurich, Switzerland



S Schweizerischer Kalibrierdienst
 S Service suisse d'étalonnage
 S Servizio svizzero di taratura
 S Swiss Calibration Service

Accredited by the Swiss Accreditation Service (SAS)
 The Swiss Accreditation Service is one of the signatories to the EA
 Multilateral Agreement for the recognition of calibration certificates

Accreditation No.: SCS 108

Client: **SGS SH (Auden)**

Certificate No.: **ES3-3088_Nov09**

CALIBRATION CERTIFICATE

Object: **ES3DV3 - SN:3088**

Calibration procedure(s): **QA CAL-01 v6, QA CAL-23.v3 and QA CAL-25.v2
 Calibration procedure for dosimetric E-field probes**

Calibration date: **November 19, 2009**

This calibration certificate documents the traceability to national standards, which realize the physical units of measurements (SI).
 The measurements and the uncertainties with confidence probability are given on the following pages and are part of the certificate.

All calibrations have been conducted in the closed laboratory facility; environment temperature (22 ± 3)°C and humidity < 70%.

Calibration Equipment used (M&PE critical for calibration):

Primary Standards	ID #	Cal Date (Certificate No.)	Scheduled Calibration
Power meter E44198	GB41293874	1-Apr-09 (No. 217-01C30)	Apr-10
Power sensor E4412A	MY41495277	1-Apr-09 (No. 217-01C30)	Apr-10
Power sensor E4412A	MY41495037	1-Apr-09 (No. 217-01C30)	Apr-10
Reference 3 dB Attenuator	SN: 85054 (3c)	31-Mar-09 (No. 217-01026)	Mar-10
Reference 20 dB Attenuator	SN: 85086 (20c)	31-Mar-09 (No. 217-01028)	Mar-10
Reference 30 dB Attenuator	SN: 85129 (30c)	31-Mar-09 (No. 217-01027)	Mar-10
Reference Probe ES3DV2	SN: 3013	2-Jan-09 (No. ES3-3013_Jan09)	Jan-10
DAE4	SN: 660	29-Sep-06 (No. DAE4-660_Sep06)	Sep-10

Secondary Standards	ID #	Check Date (In house)	Scheduled Check
RF generator HP 8648C	US3642U01700	4-Aug-99 (in house check Oct-08)	In house check: Oct-11
Network Analyzer HP 8753E	US37390565	15-Oct-01 (in house check Oct-09)	In house check: Oct-10

Calibrated by:	Name	Function	Signature
	Jeton Kastner	Laboratory Technician	
Approved by:	Katja Fukovic	Technical Manager	

Issued: November 24, 2009

This calibration certificate shall not be reproduced except in full without written approval of the laboratory.

**Calibration Laboratory of
 Schmid & Partner
 Engineering AG**
 Zeughausstrasse 43, 8004 Zurich, Switzerland



S Schweizerischer Kalibrierdienst
C Service suisse d'étalonnage
S Servizio svizzero di taratura
S Swiss Calibration Service

Accredited by the Swiss Accreditation Service (SAS)
 The Swiss Accreditation Service is one of the signatories to the EA
 Multilateral Agreement for the recognition of calibration certificates

Accreditation No.: SCS 108

Glossary:

TSL	tissue simulating liquid
NORM _{x,y,z}	sensitivity in free space
ConvF	sensitivity in TEL / NORM _{x,y,z}
DCP	diode compression point
CF	crest factor (1/duty_cycle) of the RF signal
A, B, C	modulation dependent linearization parameters
Polarization φ	φ rotation around probe axis
Polarization θ	θ rotation around an axis that is in the plane normal to probe axis (at measurement center), i.e., $\theta = 0$ is normal to probe axis

Calibration is Performed According to the Following Standards:

- a) IEEE Std 1528-2003, "IEEE Recommended Practice for Determining the Peak Spatial-Averaged Specific Absorption Rate (SAR) in the Human Head from Wireless Communications Devices: Measurement Techniques", December 2003
- b) IEC 62209-1, "Procedure to measure the Specific Absorption Rate (SAR) for hand-held devices used in close proximity to the ear (frequency range of 300 MHz to 3 GHz)", February 2005

Methods Applied and Interpretation of Parameters:

- **NORM_{x,y,z}:** Assessed for E-field polarization $\theta = 0$ ($f \leq 900$ MHz in TEM-cell; $f > 1800$ MHz: R22 waveguide). NORM_{x,y,z} are only intermediate values, i.e., the uncertainties of NORM_{x,y,z} does not effect the E²-field uncertainty inside TSL (see below ConvF).
- **NORM(f)_{x,y,z} = NORM_{x,y,z} * frequency_response** (see Frequency Response Chart). This linearization is implemented in DASY4 software versions later than 4.2. The uncertainty of the frequency response is included in the stated uncertainty of ConvF.
- **DCPx_{y,z}:** DCP are numerical linearization parameters assessed based on the data of power sweep with CW signal (no uncertainty required). DCP does not depend on frequency nor media.
- **A_{x,y,z}; B_{x,y,z}; C_{x,y,z}; VR_{x,y,z}:** A, B, C are numerical linearization parameters assessed based on the data of power sweep for specific modulation signal. The parameters do not depend on frequency nor media. VR is the maximum calibration range expressed in RMS voltage across the diode.
- **ConvF and Boundary Effect Parameters:** Assessed in flat phantom using E-field (or Temperature Transfer Standard for $f \leq 800$ MHz) and inside waveguide using analytical field distributions based on power measurements for $f > 800$ MHz. The same setups are used for assessment of the parameters applied for boundary compensation (alpha, depth) of which typical uncertainty values are given. These parameters are used in DASY4 software to improve probe accuracy close to the boundary. The sensitivity in TSL corresponds to NORM_{x,y,z} * ConvF whereby the uncertainty corresponds to that given for ConvF. A frequency dependent ConvF is used in DASY version 4.4 and higher which allows extending the validity from ± 50 MHz to ± 100 MHz.
- **Spherical isotropy (3D deviation from isotropy):** in a field of low gradients realized using a flat phantom exposed by a patch antenna.
- **Sensor Offset:** The sensor offset corresponds to the offset of virtual measurement center from the probe tip (on probe axis). No tolerance required.

ES3DV3 SN:3088

November 19, 2009

Probe ES3DV3

SN:3088

Manufactured:	July 20, 2005
Last calibrated:	December 22, 2008
Recalibrated:	November 19, 2009

Calibrated for DASY Systems

(Note: non-compatible with DASY2 system!)

Certificate No. ES3-3088_Nov09

Page 3 of 11

ES3DV3 SN:3088

November 19, 2009

DASY - Parameters of Probe: ES3DV3 SN:3088

Basic Calibration Parameters

	Sensor X	Sensor Y	Sensor Z	Unc (k=2)
Norm ($\mu V/(V/m)^2$) ^A	1.32	1.27	1.26	± 10.1%
DCP (mV) ^B	94.2	94.4	94.3	

Modulation Calibration Parameters

UID	Communication System Name	PAR		A dB	B dBuV	C	VR mV	Unc ^F [k=2]
10000	CW	0.00	X	0.00	0.00	1.00	300.0	± 1.5%
			Y	0.00	0.00	1.00	300.0	
			Z	0.00	0.00	1.00	300.0	

The reported uncertainty of measurement is stated as the standard uncertainty of measurement multiplied by the coverage factor k=2, which for a normal distribution corresponds to a coverage probability of approximately 95%.

^A The uncertainties of Norm X, Y, Z do not affect the E²-field uncertainty inside TSL (see Pages 5 and 6).

^B Numerical linearization parameter: uncertainty not required.

^F Uncertainty is determined using the maximum deviation from linear response applying rectangular distribution and is expressed for the square of the field value.

ES3DV3 SN:3088

November 19, 2009

DASY - Parameters of Probe: ES3DV3 SN:3088

Calibration Parameter Determined in Head Tissue Simulating Media

f [MHz]	Validity [MHz] ^c	Permittivity	Conductivity	ConvF X	ConvF Y	ConvF Z	Alpha	Depth Unc (k=2)
900	± 50 / ± 100	41.5 ± 5%	0.97 ± 5%	5.84	5.84	5.84	0.90	1.06 ± 11.0%
1810	± 50 / ± 100	40.0 ± 5%	1.40 ± 5%	5.00	5.00	5.00	0.38	1.75 ± 11.0%
1900	± 50 / ± 100	40.0 ± 5%	1.40 ± 5%	4.97	4.97	4.97	0.48	1.53 ± 11.0%
2450	± 50 / ± 100	39.2 ± 5%	1.80 ± 5%	4.40	4.40	4.40	0.43	1.79 ± 11.0%

^c The validity of ± 100 MHz only applies for DASY v4.4 and higher (see Page 2). The uncertainty is the RSS of the ConvF uncertainty at calibration frequency and the uncertainty for the indicated frequency band.

ES3DV3 SN:3088

November 19, 2009

DASY - Parameters of Probe: ES3DV3 SN:3088

Calibration Parameter Determined in Body Tissue Simulating Media

f [MHz]	Validity [MHz] ²	Permittivity	Conductivity	ConvF X	ConvF Y	ConvF Z	Alpha	Depth Unc (k=2)
900	± 50 / ± 100	55.0 ± 5%	1.05 ± 5%	5.68	5.68	5.68	0.57	1.07 ± 11.0%
1810	± 50 / ± 100	53.3 ± 5%	1.52 ± 5%	4.76	4.76	4.76	0.41	1.88 ± 11.0%
1900	± 50 / ± 100	53.3 ± 5%	1.52 ± 5%	4.58	4.58	4.58	0.36	2.13 ± 11.0%
2450	± 50 / ± 100	52.7 ± 5%	1.95 ± 5%	4.20	4.20	4.20	0.69	1.04 ± 11.0%

² The validity of ± 100 MHz only applies for DASY v4.4 and higher (see Page 2). The uncertainty is the RSS of the ConvF uncertainty at calibration frequency and the uncertainty for the indicated frequency band.

ES3DV3 SN:3088

November 19, 2009

Frequency Response of E-Field

(TEM-Cell:if1110 EXX, Waveguide: R22)

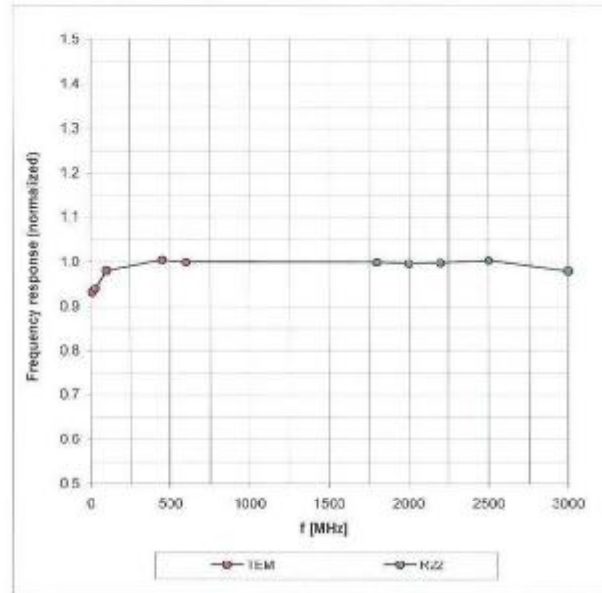

Uncertainty of Frequency Response of E-field: $\pm 5.3\%$ (k=2)

ES3DV3 SN:3088

November 19, 2009

Receiving Pattern (θ), $\vartheta = 0^\circ$

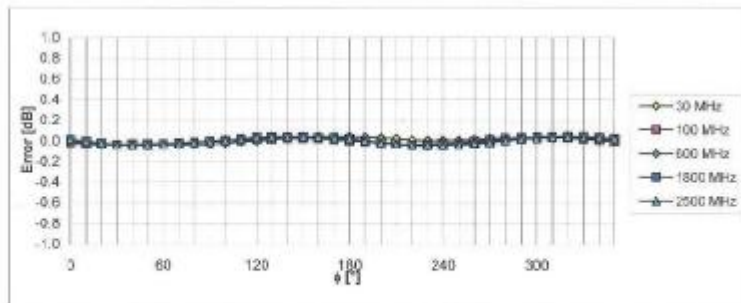
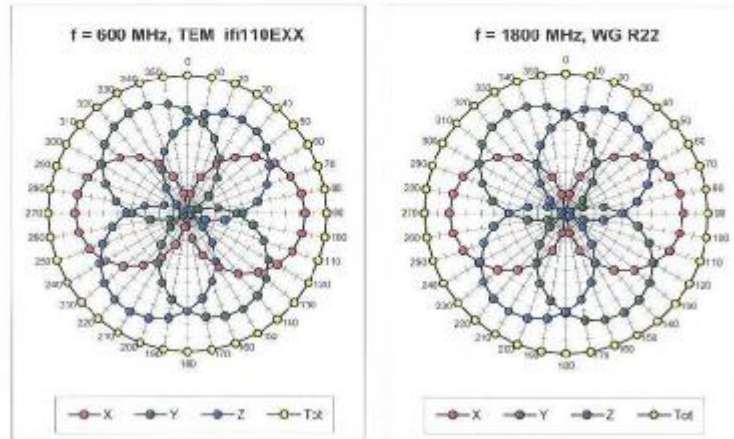

Uncertainty of Axial Isotropy Assessment: $\pm 0.5\%$ (k=2)

Certificate No. ES3-3088_Nov09

Page 8 of 11

ES3DV3 SN:3088

November 19, 2009

Dynamic Range f(SAR_{head}) (Waveguide R22, f = 1800 MHz)

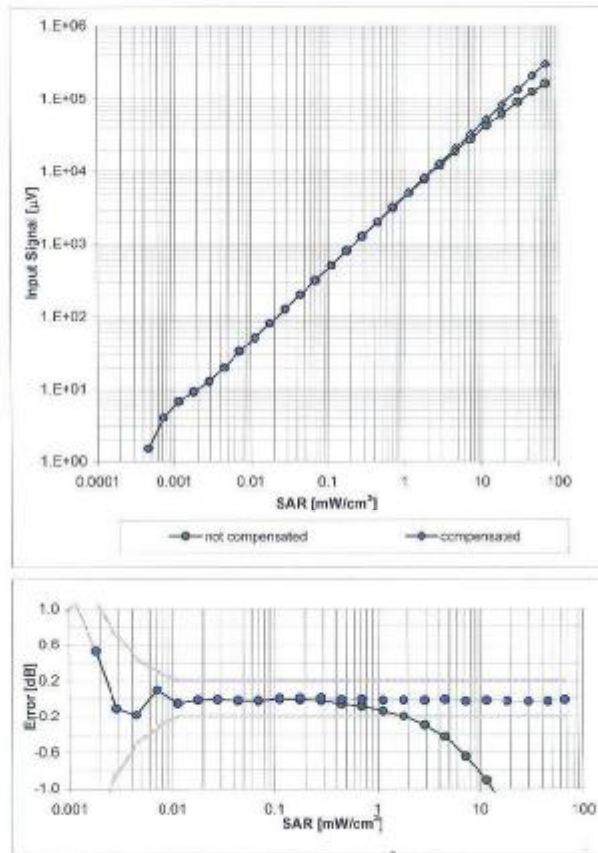

Uncertainty of Linearity Assessment: ± 0.6% (k=2)

ES3DV3 SN:3088

November 19, 2009

Conversion Factor Assessment

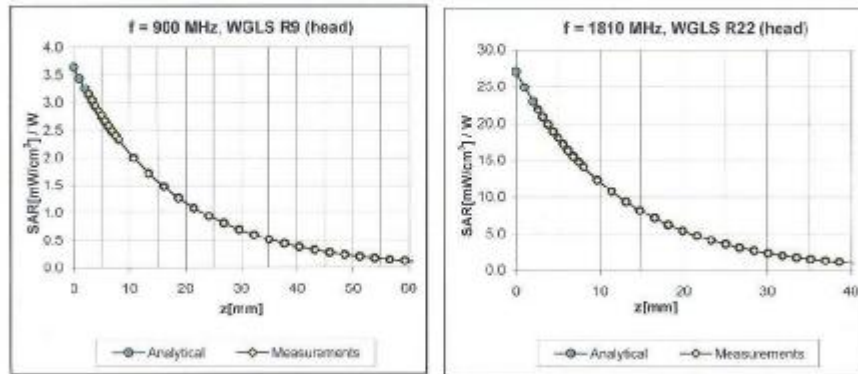

Deviation from Isotropy in HSL

Error (ϕ , θ), f = 900 MHz

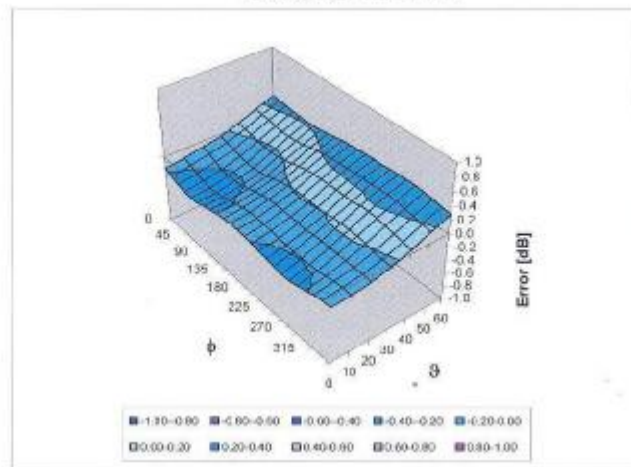

Uncertainty of Spherical Isotropy Assessment: $\pm 2.6\%$ (k=2)

ES3DV3 SN:3088

November 19, 2009

Other Probe Parameters

Sensor Arrangement	Triangular
Connector Angle (°)	Not applicable
Mechanical Surface Detection Mode	enabled
Optical Surface Detection Mode	disabled
Probe Overall Length	337 mm
Probe Body Diameter	10 mm
Tip Length	10 mm
Tip Diameter	4.0 mm
Probe Tip to Sensor X Calibration Point	2 mm
Probe Tip to Sensor Y Calibration Point	2 mm
Probe Tip to Sensor Z Calibration Point	2 mm
Recommended Measurement Distance from Surface	3 mm

Annex E.2 DAE Calibration certificate

**Calibration Laboratory of
 Schmid & Partner
 Engineering AG**
 Zeughausstrasse 43, 8004 Zurich, Switzerland



S Schweizerischer Kalibrierdienst
C Service suisse d'étalonnage
S Servizio svizzero di taratura
S Swiss Calibration Service

Accredited by the Swiss Accreditation Service (SAS)
 The Swiss Accreditation Service is one of the signatories to the EA
 Multilateral Agreement for the recognition of calibration certificates

Accreditation No.: **SCS 108**

Client **SGS – SH (Auden)**

Certificate No: **DAE3-569_Nov09**

CALIBRATION CERTIFICATE

Object **DAE3 - SD 000 D03 AA - SN: 569**

Calibration procedure(s) **QA CAL-06.v12
 Calibration procedure for the data acquisition electronics (DAE)**

Calibration date: **November 18, 2009**

This calibration certificate documents the traceability to national standards, which realize the physical units of measurements (SI).
 The measurements and the uncertainties with confidence probability are given on the following pages and are part of the certificate.

All calibrations have been conducted in the closed laboratory facility: environment temperature (22 ± 3°C and humidity < 70%).

Calibration Equipment used (M&TE critical for calibration)

Primary Standards	ID #	Cal Date (Certificate No.)	Scheduled Calibration
Keithley Multimeter Type 2001	SN: 0610278	1-Oct-09 (No: 8005)	Oct-10
Secondary Standards	ID #	Check Date (in house)	Scheduled Check
Calibrator Box V1.1	SE UMS 006 AB 1004	05-Jun-09 (in house check)	In house check: Jun-10

Calibrated by:	Name Dominique Stellen	Function Technicien	Signature
Approved by:	Fn Bombot	R&D Director	

Issued: November 18, 2009

This calibration certificate shall not be reproduced except in full without written approval of the laboratory.

**Calibration Laboratory of
 Schmid & Partner
 Engineering AG**
 Zeughausstrasse 43, 8004 Zurich, Switzerland



S Schweizerischer Kalibrierdienst
C Service suisse d'étalonnage
S Servizio svizzero di taratura
S Swiss Calibration Service

Accredited by the Swiss Accreditation Service (SAS)
 The Swiss Accreditation Service is one of the signatories to the EA
 Multilateral Agreement for the recognition of calibration certificates

Accreditation No.: **SCS 108**

Glossary

DAE data acquisition electronics
Connector angle information used in DASY system to align probe sensor X to the robot coordinate system.

Methods Applied and Interpretation of Parameters

- **DC Voltage Measurement:** Calibration Factor assessed for use in DASY system by comparison with a calibrated instrument traceable to national standards. The figure given corresponds to the full scale range of the voltmeter in the respective range.
- **Connector angle:** The angle of the connector is assessed measuring the angle mechanically by a tool inserted. Uncertainty is not required.
- The following parameters as documented in the Appendix contain technical information as a result from the performance test and require no uncertainty.
 - **DC Voltage Measurement Linearity:** Verification of the Linearity at +10% and -10% of the nominal calibration voltage. Influence of offset voltage is included in this measurement.
 - **Common mode sensitivity:** Influence of a positive or negative common mode voltage on the differential measurement.
 - **Channel separation:** Influence of a voltage on the neighbor channels not subject to an input voltage.
 - **AD Converter Values with inputs shorted:** Values on the internal AD converter corresponding to zero input voltage
 - **Input Offset Measurement:** Output voltage and statistical results over a large number of zero voltage measurements.
 - **Input Offset Current:** Typical value for information; Maximum channel input offset current, not considering the input resistance.
 - **Input resistance:** DAE input resistance at the connector, during internal auto-zeroing and during measurement.
 - **Low Battery Alarm Voltage:** Typical value for information. Below this voltage, a battery alarm signal is generated.
 - **Power consumption:** Typical value for information. Supply currents in various operating modes.

DC Voltage Measurement

A/D - Converter Resolution nominal

High Range: 1LSB = 6.1 μ V ; full range = -100...+300 mV
 Low Range: 1LSB = 61nV ; full range = -1.....+3mV

DASY measurement parameters: Auto Zero Time: 3 sec; Measuring time: 3 sec

Calibration Factors	X	Y	Z
High Range	404.786 \pm 0.1% (k=2)	404.382 \pm 0.1% (k=2)	404.129 \pm 0.1% (k=2)
Low Range	3.94150 \pm 0.7% (k=2)	3.90629 \pm 0.7% (k=2)	3.95193 \pm 0.7% (k=2)

Connector Angle

Connector Angle to be used in DASY system	264.0 \pm 1 °
---	-----------------

Appendix

1. DC Voltage Linearity

High Range	Reading (μV)	Difference (μV)	Error (%)
Channel X + Input	20000.4	3.78	0.00
Channel X + Input	20001.03	0.33	0.00
Channel X - Input	-19995.39	5.31	-0.03
Channel Y + Input	200010.9	3.93	0.00
Channel Y + Input	19997.76	-2.84	-0.01
Channel Y - Input	-20002.85	-3.05	0.02
Channel Z + Input	200008.6	4.33	0.00
Channel Z + Input	19999.62	-3.88	-0.00
Channel Z - Input	-20001.79	0.01	0.01

Low Range	Reading (μV)	Difference (μV)	Error (%)
Channel X + Input	1999.7	-0.28	-0.01
Channel X + Input	199.60	-0.40	-0.20
Channel X - Input	-201.13	-1.23	0.62
Channel Y + Input	2000.0	0.02	0.00
Channel Y + Input	199.28	-0.82	-0.41
Channel Y - Input	-201.40	-1.50	0.75
Channel Z + Input	1999.9	-0.17	-0.01
Channel Z + Input	198.61	-1.39	-0.70
Channel Z - Input	-201.65	-1.75	0.88

2. Common mode sensitivity

DASY measurement parameters: Auto Zero Time: 3 sec; Measuring time: 3 sec

	Common mode Input Voltage (mV)	High Range Average Reading (μV)	Low Range Average Reading (μV)
Channel X	200	-3.14	-5.24
	-200	6.52	4.85
Channel Y	200	7.98	7.35
	-200	-8.52	-8.62
Channel Z	200	-5.05	-5.64
	-200	3.96	4.09

3. Channel separation

DASY measurement parameters: Auto Zero Time: 3 sec; Measuring time: 3 sec

	Input Voltage (mV)	Channel X (μV)	Channel Y (μV)	Channel Z (μV)
Channel X	200	-	2.19	0.12
Channel Y	200	2.65	-	3.55
Channel Z	200	1.86	-0.43	-

4. AD-Converter Values with inputs shorted

DASY measurement parameters: Auto Zero Time: 3 sec; Measuring time: 3 sec

	High Range (LSB)	Low Range (LSB)
Channel X	16392	14986
Channel Y	15762	16421
Channel Z	16298	16514

5. Input Offset Measurement

DASY measurement parameters: Auto Zero Time: 3 sec; Measuring time: 3 sec

Input 10MΩ

	Average (μV)	min. Offset (μV)	max. Offset (μV)	Std. Deviation (μV)
Channel X	-0.18	-1.21	0.79	0.33
Channel Y	-0.61	-1.80	0.79	0.30
Channel Z	-0.97	-2.37	-0.10	0.36

6. Input Offset Current

Nominal Input circuitry offset current on all channels: <25fA

7. Input Resistance

	Zeroing (MΩ)	Measuring (MΩ)
Channel X	0.2000	199.8
Channel Y	0.2000	204.0
Channel Z	0.2001	204.9

8. Low Battery Alarm Voltage (verified during pre test)

Typical values	Alarm Level (VDC)
Supply (+ Vcc)	+7.9
Supply (- Vcc)	-7.6

9. Power Consumption (verified during pre test)

Typical values	Switched off (mA)	Stand by (mA)	Transmitting (mA)
Supply (+ Vcc)	+0.0	+6	+14
Supply (- Vcc)	-0.01	-8	-9

Annex E.3 Dipole Calibration certification D835V2

Calibration Laboratory of
 Schmid & Partner
 Engineering AG
 Zeughausstrasse 43, 8004 Zurich, Switzerland



S Schweizerischer Kalibrierdienst
 C Service suisse d'étalonnage
 S Servizio svizzero di taratura
 S Swiss Calibration Service

Accredited by the Swiss Accreditation Service (SAS)
 The Swiss Accreditation Service is one of the signatories to the EA
 Multilateral Agreement for the recognition of calibration certificates

Accreditation No.: SCS 108

Client **SGS SH (Auden)**

Certificate No: **D835V2-4d070_Dec08**

CALIBRATION CERTIFICATE

Object: **D835V2 - SN: 4d070**

Calibration procedure(s): **QA CAL-05.v7
 Calibration procedure for dipole validation kits**

Calibration date: **December 15, 2008**

Condition of the calibrated item: **In Tolerance**

This calibration certificate documents the traceability to national standards, which realize the physical units of measurements (SI).
 The measurements and the uncertainties with confidence probability are given on the following pages and are part of the certificate.

All calibrations have been conducted in the closed laboratory facility: environment temperature (22 ± 3)°C and humidity < 70%.

Calibration Equipment used (M&TE critical for calibration)

Primary Standards	ID #	Cal Date (Certificate No.)	Scheduled Calibration
Power meter EPM-442A	GB37460704	08-Oct-08 (No. 217-00898)	Oct-09
Power sensor HP 8481A	US37282783	08-Oct-08 (No. 217-00898)	Oct-09
Reference 20 dB Attenuator	SN: 5086 (20g)	01-Jul-08 (No. 217-00864)	Jul-09
Type-N mismatch combination	SN: 5047.2 / 06327	01-Jul-08 (No. 217-00867)	Jul-09
Reference Probe ES3DV2	SN: 3025	29-Apr-08 (No. ES3-3025_Apr08)	Apr-09
DAE4	SN: 601	14-Mar-08 (No. DAE4-601 Mar08)	Mar-09

Secondary Standards	ID #	Check Date (in house)	Scheduled Check
Power sensor HP 8481A	MY41062317	18-Oct-02 (in house check Oct-07)	In house check: Oct-09
RF generator R&S SMT-06	100005	4-Aug-99 (in house check Oct-07)	In house check: Oct-09
Network Analyzer HP 8753E	US37390585 S4206	18-Oct-01 (in house check Oct-08)	In house check: Oct-09

	Name	Function	Signature
Calibrated by:	Jeton Kastrati	Laboratory Technician	
Approved by:	Katja Pokovic	Technical Manager	

Issued: December 15, 2008

This calibration certificate shall not be reproduced except in full without written approval of the laboratory.

Measurement Conditions

DASY system configuration, as far as not given on page 1.

DASY Version	DASY5	V5.0
Extrapolation	Advanced Extrapolation	
Phantom	Modular Flat Phantom V4.9	
Distance Dipole Center - TSL	15 mm	with Spacer
Zoom Scan Resolution	dx, dy, dz = 5 mm	
Frequency	835 MHz ± 1 MHz	

Head TSL parameters

The following parameters and calculations were applied.

	Temperature	Permittivity	Conductivity
Nominal Head TSL parameters	22.0 °C	41.5	0.90 mho/m
Measured Head TSL parameters	(22.0 ± 0.2) °C	40.3 ± 6 %	0.89 mho/m ± 6 %
Head TSL temperature during test	(22.5 ± 0.2) °C	---	---

SAR result with Head TSL

SAR averaged over 1 cm ³ (1 g) of Head TSL	Condition	
SAR measured	250 mW input power	2.43 mW / g
SAR normalized	normalized to 1W	9.72 mW / g
SAR for nominal Head TSL parameters ¹	normalized to 1W	9.62 mW / g ± 17.0 % (k=2)

SAR averaged over 10 cm ³ (10 g) of Head TSL	condition	
SAR measured	250 mW input power	1.60 mW / g
SAR normalized	normalized to 1W	6.40 mW / g
SAR for nominal Head TSL parameters ¹	normalized to 1W	6.34 mW / g ± 16.5 % (k=2)

¹ Correction to nominal TSL parameters according to d), chapter "SAR Sensitivities"

Body TSL parameters

The following parameters and calculations were applied.

	Temperature	Permittivity	Conductivity
Nominal Body TSL parameters	22.0 °C	55.2	0.97 mho/m
Measured Body TSL parameters	(22.0 ± 0.2) °C	54.7 ± 6 %	1.01 mho/m ± 6 %
Body TSL temperature during test	(21.8 ± 0.2) °C	---	---

SAR result with Body TSL

SAR averaged over 1 cm ³ (1 g) of Body TSL	Condition	
SAR measured	250 mW input power	2.55 mW / g
SAR normalized	normalized to 1W	10.2 mW / g
SAR for nominal Body TSL parameters ²	normalized to 1W	9.69 mW / g ± 17.0 % (k=2)

SAR averaged over 10 cm ³ (10 g) of Body TSL	condition	
SAR measured	250 mW input power	1.68 mW / g
SAR normalized	normalized to 1W	6.72 mW / g
SAR for nominal Body TSL parameters ²	normalized to 1W	6.58 mW / g ± 16.5 % (k=2)

² Correction to nominal TSL parameters according to d), chapter "SAR Sensitivities"

DASY5 Validation Report for Head TSL

Date/Time: 08.12.2008 10:31:04

Test Laboratory: SPEAG, Zurich, Switzerland

DUT: Dipole 835 MHz; Type: D835V2; Serial: D835V2 - SN:4d070

Communication System: CW-835; Frequency: 835 MHz; Duty Cycle: 1:1
 Medium: HSL 900 MHz
 Medium parameters used: $f = 835$ MHz; $\sigma = 0.89$ mho/m; $\epsilon_r = 40.3$; $\rho = 1000$ kg/m³
 Phantom section: Flat Section
 Measurement Standard: DASY5 (IEEE/IEC)

DASY5 Configuration:

- Probe: ES3DV2 - SN3025; ConvF(5.97, 5.97, 5.97); Calibrated: 28.04.2008
- Sensor-Surface: 3.4mm (Mechanical Surface Detection)
- Electronics: DAE4 Sn601; Calibrated: 14.03.2008
- Phantom: Flat Phantom 4.9L; Type: QD000P49AA; Serial: 1001
- Measurement SW: DASY5, V3.0 Build 120; SEMCAD X Version 13.4 Build 45

Pin=250mW; dip=15mm; dist=3.4mm/Zoom Scan (7x7x7)/Cube 0: Measurement grid: dx=5mm, dy=5mm, dz=5mm
 Reference Value = 56.7 V/m; Power Drift = -0.000938 dB
 Peak SAR (extrapolated) = 3.56 W/kg
SAR(1 g) = 2.43 mW/g; SAR(10 g) = 1.6 mW/g
 Maximum value of SAR (measured) = 2.73 mW/g

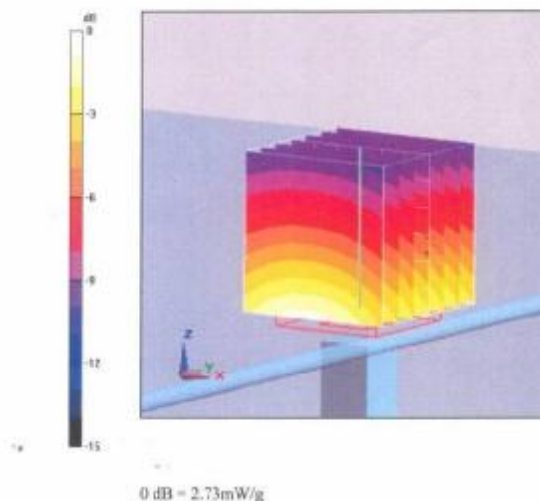

DASY5 Validation Report for Body TSL

Date/Time: 15.12.2008 11:58:06

Test Laboratory: SPEAG, Zurich, Switzerland

DUT: Dipole 835 MHz; Type: D835V2; Serial: D835V2 - SN:4d070

Communication System: CW; Frequency: 835 MHz; Duty Cycle: 1:1
 Medium: MSL900
 Medium parameters used: $f = 835 \text{ MHz}$; $\sigma = 1.01 \text{ mho/m}$; $\epsilon_r = 54.7$; $\rho = 1000 \text{ kg/m}^3$
 Phantom section: Flat Section
 Measurement Standard: DASY5 (IEEE/IEC)

DASY5 Configuration:

- Probe: ES3DV2 - SN3025; ConvF[5.9, 5.9, 5.9]; Calibrated: 28.04.2008
- Sensor-Surface: 3.4mm (Mechanical Surface Detection)
- Electronics: DAE4 Sn601; Calibrated: 14.03.2008
- Phantom: Flat Phantom 4.9L; Type: QD00P49AA; Serial: 1001
- Measurement SW: DASY5, V5.0 Build 120; SEMCAD X Version 13.4 Build 45

Pin = 250mW, d = 15mm/Zoom Scan (7x7x7)/Cube 0: Measurement grid: dx=5mm, dy=5mm, dz=5mm

Reference Value = 54.7 V/m; Power Drift = 0.00608 dB
 Peak SAR (extrapolated) = 3.69 W/kg
SAR(1 g) = 2.55 mW/g; SAR(10 g) = 1.68 mW/g
 Maximum value of SAR (measured) = 2.87 mW/g

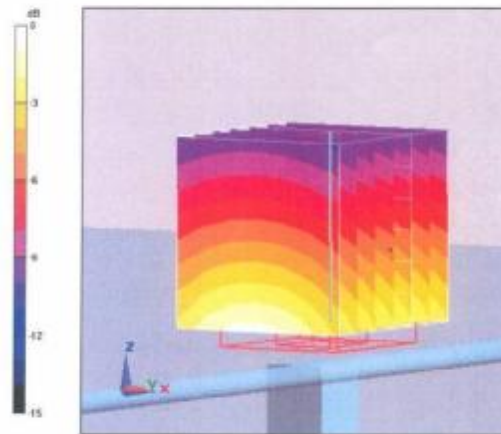

0 dB = 2.87mW/g

**Calibration Laboratory of
 Schmid & Partner
 Engineering AG**
 Zeughausstrasse 43, 8004 Zurich, Switzerland



S Schweizerischer Kalibrierdienst
C Service suisse d'étalonnage
S Servizio svizzero di taratura
S Swiss Calibration Service

Accredited by the Swiss Accreditation Service (SAS)
 The Swiss Accreditation Service is one of the signatories to the EA
 Multilateral Agreement for the recognition of calibration certificates

Accreditation No.: **SCS 108**

Client **SGS-SH (Auden)**

Certificate No: **D1900V2-5d028_Nov09**

CALIBRATION CERTIFICATE

Object: **D1900V2 - SN: 5d028**

Calibration procedure(s): **QA CAL-05.v7
 Calibration procedure for dipole validation kits**

Calibration date: **November 24, 2009**

This calibration certificate documents the traceability to national standards, which realize the physical units of measurements (SI).
 The measurements and the uncertainties with confidence probability are given on the following pages and are part of the certificate.

All calibrations have been conducted in the closed laboratory facility: environment temperature (22 ± 3)°C and humidity < 70%.

Calibration Equipment used (M&TE critical for calibration)

Primary Standards	ID #	Cal Date (Certificate No.)	Scheduled Calibration
Power meter EPM-442A	GB37480704	06-Oct-09 (No. 217-01086)	Oct-10
Power sensor HP 8481A	US37282763	06-Oct-09 (No. 217-01086)	Oct-10
Reference 20 dB Attenuator	SN: 5086 (20g)	31-Mar-09 (No. 217-01025)	Mar-10
Type-N mismatch combination	SN: 5047.2 / 06327	31-Mar-09 (No. 217-01029)	Mar-10
Reference Probe ES3Dv3	SN: 3205	26-Jun-09 (No. ES3-3205_Jun09)	Jun-10
DAE4	SN: 601	07-Mar-09 (No. DAE4-601_Mar09)	Mar-10
Secondary Standards	ID #	Check Date (in house)	Scheduled Check
Power sensor HP 8481A	MY41092317	18-Oct-02 (in house check Oct-09)	In house check: Oct-11
RF generator R&S SMT-06	100035	4-Aug-99 (in house check Oct-06)	In house check: Oct-11
Network Analyzer HP 8753E	US37390585 34206	18-Oct-01 (in house check Oct-09)	In house check: Oct-10

Calibrated by: **Jeton Kastrioti** (Name) / **Laboratory Technician** (Function) / *[Signature]* (Signature)

Approved by: **Koljo Pokovic** (Name) / **Technical Manager** (Function) / *[Signature]* (Signature)

Issued: November 25, 2009

This calibration certificate shall not be reproduced except in full without written approval of the laboratory.

Measurement Conditions

DASY system configuration, as far as not given on page 1

DASY Version	DASY5	V5.2
Extrapolation	Advanced Extrapolation	
Phantom	Modular Flat Phantom V5.C	
Distance Dipole Center - TSL	10 mm	with Spacer
Zoom Scan Resolution	dx, dy, dz = 5 mm	
Frequency	1900 MHz ± 1 MHz	

Head TSL parameters

The following parameters and calculations were applied.

	Temperature	Permittivity	Conductivity
Nominal Head TSL parameters	22.0 °C	40.0	1.40 mho/m
Measured Head TSL parameters	(22.0 ± 0.2) °C	39.8 ± 6 %	1.44 mho/m ± 6 %
Head TSL temperature during test	(21.5 ± 0.2) °C	---	---

SAR result with Head TSL

SAR averaged over 1 cm ³ (1 g) of Head TSL	Condition	
SAR measured	250 mW input power	10.0 mW / g
SAR normalized	normalized to 1W	40.0 mW / g
SAR for nominal Head TSL parameters	normalized to 1W	39.3 mW / g ± 17.0 % (k=2)

SAR averaged over 10 cm ³ (10 g) of Head TSL	condition	
SAR measured	250 mW input power	5.22 mW / g
SAR normalized	normalized to 1W	20.9 mW / g
SAR for nominal Head TSL parameters	normalized to 1W	20.7 mW / g ± 16.5 % (k=2)

Body TSL parameters

The following parameters and calculations were applied:

	Temperature	Permittivity	Conductivity
Nominal Body TSL parameters	22.0 °C	53.3	1.52 mho/m
Measured Body TSL parameters	(22.0 ± 0.2) °C	53.5 ± 6 %	1.58 mho/m ± 6 %
Body TSL temperature during test	(21.2 ± 0.2) °C	---	---

SAR result with Body TSL

SAR averaged over 1 cm ³ (1 g) of Body TSL	Condition	
SAR measured	250 mW input power	10.3 mW / g
SAR normalized	normalized to 1W	41.2 mW / g
SAR for nominal Body TSL parameters	normalized to 1W	40.4 mW / g ± 17.0 % (k=2)

SAR averaged over 10 cm ³ (10 g) of Body TSL	condition	
SAR measured	250 mW input power	5.44 mW / g
SAR normalized	normalized to 1W	21.8 mW / g
SAR for nominal Body TSL parameters	normalized to 1W	21.5 mW / g ± 16.5 % (k=2)

DASY5 Validation Report for Head TSL

Date/Time: 24.11.2009 13:29:02

Test Laboratory: SPEAG, Zurich, Switzerland

DUT: Dipole 1900 MHz; Type: D1900V2; Serial: D1900V2 - SN:5d028

Communication System: CW; Frequency: 1900 MHz; Duty Cycle: 1:1

Medium: HSL U11 BB

Medium parameters used: $f = 1900$ MHz; $\sigma = 1.44$ mho/m; $\epsilon_r = 39.9$; $\rho = 1000$ kg/m³

Phantom section: Flat Section

Measurement Standard: DASY5 (IEEE/IEC/ANSI C63.19-2007)

DASY5 Configuration:

- Probe: ES3DV3 - SN3205; CoaxF(5.09, 5.09, 5.09); Calibrated: 26.06.2009
- Sensor-Surface: 3mm (Mechanical Surface Detection)
- Electronics: DAE4 Sn601; Calibrated: 07.03.2009
- Phantom: Flat Phantom: 5.0 (front); Type: QD000P50AA; Serial: 1001
- Measurement SW: DASY5, V5.2 Build 157; SEMCAD X Version 14.0 Build 57

Pin=250 mW /d=10mm, dist=3.0mm (ES-Probe)/Zoom Scan (7x7x7)/Cube 0: Measurement

grid: dx=5mm, dy=5mm, dz=5mm

Reference Value = 96,4 V/m; Power Drift = 0.037 dB

Peak SAR (extrapolated) = 18.2 W/kg

SAR(1 g) = 10 mW/g; SAR(10 g) = 5.22 mW/g

Maximum value of SAR (measured) = 12.5 mW/g



0 dB = 12.5mW/g

DASY5 Validation Report for Body

Date/Time: 17.11.2009 13:08:34

Test Laboratory: SPEAG, Zurich, Switzerland

DUT: Dipole 1900 MHz; Type: D1900V2; Serial: D1900V2 - SN:5d028

Communication System: CW; Frequency: 1900 MHz; Duty Cycle: 1:1

Medium: MSL U10 BB

Medium parameters used: $f = 1900$ MHz; $\sigma = 1.58$ mho/m; $\epsilon_r = 53.6$; $\rho = 1000$ kg/m³

Phantom section: Flat Section

Measurement Standard: DASY5 (IEEE/IEC/ANSI C63.19-2007)

DASY5 Configuration:

- Probe: ES2DV3 - SN3205; ConvF(4.59, 4.59, 4.59); Calibrated: 26.06.2009
- Sensor-Surface: 3mm (Mechanical Surface Detection)
- Electronics: DAE4 Sn601; Calibrated: 07.03.2009
- Phantom: Flat Phantom 5.0 (back); Type: QD000P50AA; Serial: 1002
- Measurement SW: DASY5, V5.2 Build 157; SEMCAD-X Version 14.0 Build 57

Pin250 mW /d=10mm, dist=3.0mm (ES-Probe)/Zoom Scan (7x7x7)/Cube 0: Measurement

grid: dx=5mm, dy=5mm, dz=5mm

Reference Value = 95.9 V/m; Power Drift = 0.00895 dB

Peak SAR (extrapolated) = 17.7 W/kg

SAR(1 g) = 10.3 mW/g; SAR(10 g) = 5.44 mW/g

Maximum value of SAR (measured) = 13 mW/g

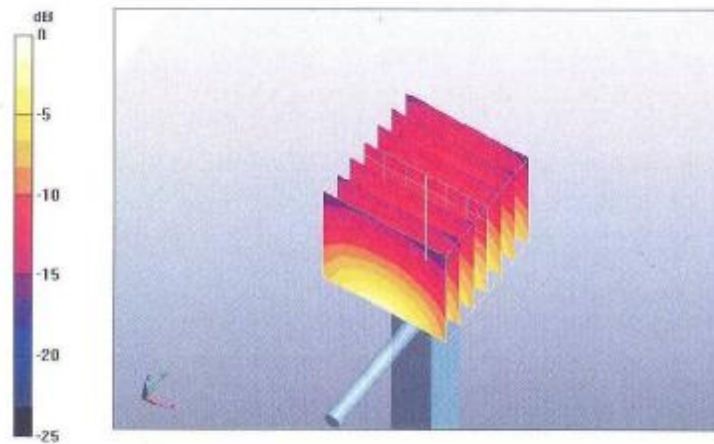

0 dB - 13mW/g

END OF REPORT