

FCC RF Test Report

APPLICANT : Lenovo Mobile Communication
Technology Ltd.
EQUIPMENT : Lenovo Mobile Phone
BRAND NAME : lenovo
MODEL NAME : Lenovo S960
MID : 96000011
FCC ID : YCNS960
STANDARD : FCC Part 15 Subpart C §15.247
CLASSIFICATION : (DSS) Spread Spectrum Transmitter

The product was received on Sep. 11, 2013 and testing was completed on Sep. 25, 2013. We, SPORTON INTERNATIONAL (SHENZHEN) INC., would like to declare that the tested sample has been evaluated in accordance with the procedures and shown to be compliant with the applicable technical standards.

The test results in this report apply exclusively to the tested model / sample. Without written approval of SPORTON INTERNATIONAL (SHENZHEN) INC., the test report shall not be reproduced except in full.



Reviewed by: Joseph Lin / Supervisor

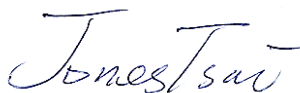

Approved by: Jones Tsai / Manager



SPORTON INTERNATIONAL (SHENZHEN) INC.

No. 3 Building, the third floor of south, Shahe River west, Fengzeyuan warehouse, Nanshan District, Shenzhen, Guangdong, P.R.C.



TABLE OF CONTENTS

REVISION HISTORY..... 3

SUMMARY OF TEST RESULT 4

1 GENERAL DESCRIPTION..... 5

 1.1 Applicant..... 5

 1.2 Manufacturer..... 5

 1.3 Feature of Equipment Under Test..... 5

 1.4 Product Specification of Equipment Under Test..... 6

 1.5 Modification of EUT 6

 1.6 Testing Site..... 6

 1.7 Applied Standards 7

2 TEST CONFIGURATION OF EQUIPMENT UNDER TEST..... 8

 2.1 Descriptions of Test Mode..... 8

 2.2 Test Mode..... 9

 2.3 Connection Diagram of Test System..... 10

 2.4 Support Unit used in test configuration and system..... 11

 2.5 Description of RF Function Operation Test Setup..... 11

 2.6 Measurement Results Explanation Example..... 11

3 TEST RESULT 12

 3.1 Number of Channel Measurement 12

 3.2 Hopping Channel Separation Measurement 14

 3.3 Dwell Time Measurement..... 21

 3.4 20dB Bandwidth Measurement 23

 3.5 Peak Output Power Measurement 30

 3.6 Conducted Band Edges Measurement 32

 3.7 Conducted Spurious Emission Measurement 39

 3.8 Radiated Band Edges and Spurious Emission Measurement 49

 3.9 AC Conducted Emission Measurement..... 60

 3.10 Antenna Requirements..... 64

4 LIST OF MEASURING EQUIPMENT..... 65

5 UNCERTAINTY OF EVALUATION..... 66

APPENDIX A. SETUP PHOTOGRAPHS

SUMMARY OF TEST RESULT

Report Section	FCC Rule	Description	Limit	Result	Remark
3.1	15.247(a)(1)	Number of Channels	≥ 15Chs	Pass	-
3.2	15.247(a)(1)	Hopping Channel Separation	≥ 2/3 of 20dB BW	Pass	-
3.3	15.247(a)(1)	Dwell Time of Each Channel	≤ 0.4sec in 31.6sec period	Pass	-
3.4	15.247(a)(1)	20dB Bandwidth	NA	Pass	-
3.5	15.247(b)(1)	Peak Output Power	≤ 125 mW	Pass	-
3.6	15.247(d)	Conducted Band Edges	≤ 20dBc	Pass	-
3.7	15.247(d)	Conducted Spurious Emission	≤ 20dBc	Pass	-
3.8	15.247(d)	Radiated Band Edges and Radiated Spurious Emission	15.209(a) & 15.247(d)	Pass	Under limit 14.96 dB at 2483.600 MHz
3.9	15.207	AC Conducted Emission	15.207(a)	Pass	Under limit 5.64 dB at 0.470 MHz
3.10	15.203 & 15.247(b)	Antenna Requirement	N/A	Pass	-

1 General Description

1.1 Applicant

Lenovo Mobile Communication Technology Ltd.

No.999, Qishan North 2nd Road, Information & Optoelectronics Park, Torch Hi-tech Industry Development Zone, Xiamen, P.R.China

1.2 Manufacturer

Lenovo PC HK Limited

23/F, Lincoln House, Taikoo Place 979 King's Road, Quarry Bay, Hong Kong

1.3 Feature of Equipment Under Test

Product Feature	
Equipment	Lenovo Mobile Phone
Brand Name	lenovo
Model Name	Lenovo S960
MID	96000011
FCC ID	YCNS960
EUT supports Radios application	GSM/GPRS/EGPRS/WCDMA/HSPA/DC-HSDPA/HSPA+ /WLAN 2.4GHz 802.11bgn/Bluetooth v3.0 + EDR/ Bluetooth v4.0
HW Version	S960_MB_H302
SW Version	S960_ROW_S105_130828
EUT Stage	Pre-Production

Remark: The above EUT's information was declared by manufacturer. Please refer to the specifications or user's manual for more detailed description.

1.4 Product Specification of Equipment Under Test

Product Specification subjective to this standard	
Tx/Rx Frequency Range	2402 MHz ~ 2480 MHz
Number of Channels	79
Carrier Frequency of Each Channel	2402+n*1 MHz; n=0~78
Maximum Output Power to Antenna	Bluetooth BR(1Mbps) : 9.12 dBm (0.00817 W) Bluetooth EDR (2Mbps) : 8.89 dBm (0.00774 W) Bluetooth EDR (3Mbps) : 9.15 dBm (0.00822 W)
Antenna Type	Monopole Antenna with gain 0.12 dBi
Type of Modulation	Bluetooth BR (1Mbps) : GFSK Bluetooth EDR (2Mbps) : $\pi/4$ -DQPSK Bluetooth EDR (3Mbps) : 8-DPSK

1.5 Modification of EUT

No modifications are made to the EUT during all test items.

1.6 Testing Site

Test Site	SPORTON INTERNATIONAL (SHENZHEN) INC.			
Test Site Location	No. 3 Building, the third floor of south, Shahe River west, Fengzeyuan warehouse, Nanshan District, Shenzhen, Guangdong, P.R.C. TEL: +86-755- 3320-2398			
Test Site No.	Sporton Site No.			FCC Registration No.
	TH01-SZ	CO01-SZ	03CH01-SZ	831040

Note: The test site complies with ANSI C63.4 2003 requirement.

1.7 Applied Standards

According to the specifications of the manufacturer, the EUT must comply with the requirements of the following standards:

- ♦ FCC Part 15 Subpart C §15.247
- ♦ FCC Public Notice DA 00-705
- ♦ ANSI C63.4-2003

Remark:

1. All test items were verified and recorded according to the standards and without any deviation during the test.
2. This EUT has also been tested and complied with the requirements of FCC Part 15, Subpart B, recorded in a separate test report.

2 Test Configuration of Equipment Under Test

2.1 Descriptions of Test Mode

Preliminary tests were performed in different data rates and recorded the RF output power in the following table:

Channel	Frequency	Bluetooth RF Output Power		
		Data Rate / Modulation		
		GFSK	$\pi/4$ -DQPSK	8-DPSK
		1Mbps	2Mbps	3Mbps
Ch00	2402MHz	9.12 dBm	8.89 dBm	9.15 dBm
Ch39	2441MHz	8.67 dBm	8.39 dBm	8.71 dBm
Ch78	2480MHz	8.50 dBm	8.23 dBm	8.49 dBm

Remark:

1. All the test data for each data rate were verified, but only the worst case was reported.
 2. The data rate was set in 3Mbps for all the test items due to the highest RF output power.
- a. The EUT has been associated with peripherals and configuration operated in a manner tended to maximize its emission characteristics in a typical application. Frequency range investigated: conduction (150 kHz to 30 MHz), radiation (9 kHz to the 10th harmonic of the highest fundamental frequency or to 40 GHz, whichever is lower). Pre-scanned tests, X, Y, Z in three orthogonal panels, and different data rates were conducted to determine the final configuration (X plane as worst plane) from all possible combinations, and the worst mode of radiated spurious emissions is Bluetooth 3Mbps mode, and recorded in this report.
 - b. AC power line Conducted Emission was tested under maximum output power.

2.2 Test Mode

The following summary table is showing all test modes to demonstrate in compliance with the standard.

Summary table of Test Cases			
Test Item	Data Rate / Modulation		
	Bluetooth BR 1Mbps GFSK	Bluetooth EDR 2Mbps $\pi/4$ -DQPSK	Bluetooth EDR 3Mbps 8-DPSK
Conducted Test Cases	Mode 1: CH00_2402 MHz	Mode 4: CH00_2402 MHz	Mode 7: CH00_2402 MHz
	Mode 2: CH39_2441 MHz	Mode 5: CH39_2441 MHz	Mode 8: CH39_2441 MHz
	Mode 3: CH78_2480 MHz	Mode 6: CH78_2480 MHz	Mode 9: CH78_2480 MHz
Radiated Test Cases	Bluetooth EDR 3Mbps 8-DPSK		
	Mode 1: CH00_2402 MHz		
	Mode 2: CH39_2441 MHz		
	Mode 3: CH78_2480 MHz		
AC Conducted Emission	Mode 1 :GSM850 Idle + Bluetooth Link + WLAN Link + Earphone + USB Cable (Charging from Adapter)		
Remark: For radiated test cases, the worst mode data rate 3Mbps was reported only, because this data rate has the highest RF output power at preliminary tests, and no other significantly frequencies found in conducted spurious emission.			

2.3 Connection Diagram of Test System

<Bluetooth Tx Mode>

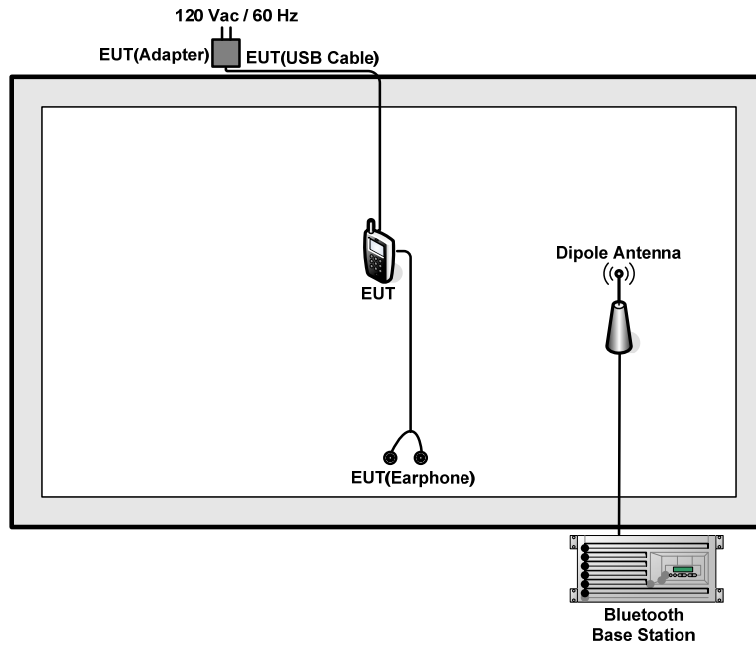

<AC Conducted Emission Mode>

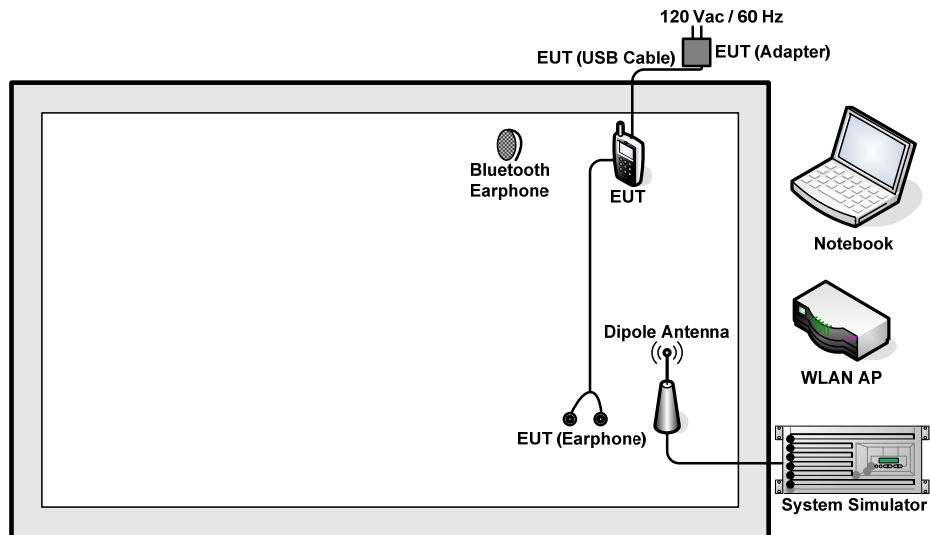

2.4 Support Unit used in test configuration and system

Item	Equipment	Trade Name	Model Name	FCC ID	Data Cable	Power Cord
1.	System Simulator	Agilent	E5515C	N/A	N/A	Unshielded, 1.8 m
2.	Bluetooth Base Station	Anritsu	MT8852B	FCC DoC	N/A	Unshielded, 1.8 m
3.	WLAN AP	D-Link	DIR-612	FCC DoC	N/A	Unshielded, 1.8 m
4.	DC Power Supply	TOPWORD	3303DR	N/A	N/A	Unshielded, 1.8 m
5.	Notebook	DELL	P08S	FCC DoC	N/A	AC I/P: Unshielded, 1.8 m DC O/P: Shielded, 1.8 m
6.	Bluetooth Earphone	Nokia	BH-108	FCC DoC	N/A	N/A

2.5 Description of RF Function Operation Test Setup

For Bluetooth function, the engineering test program was provided and enabled to make EUT connect with Bluetooth base station to continuous transmit/receive.

For AC power line conducted emissions, the EUT was set to connect with the WLAN AP under large package sizes transmission.

2.6 Measurement Results Explanation Example

For all conducted test items:

The offset level is set in the spectrum analyzer to compensate the RF cable loss and attenuator factor between EUT conducted output port and spectrum analyzer. With the offset compensation, the spectrum analyzer reading level is exactly the EUT RF output level.

Example:

The spectrum analyzer offset is derived from RF cable loss and attenuator factor.

Offset = RF cable loss + attenuator factor.

Following shows an offset computation example with cable loss 7.5 dB and 10dB attenuator.

$$\begin{aligned}
 \text{Offset(dB)} &= \text{RF cable loss(dB)} + \text{attenuator factor(dB)}. \\
 &= 7.5 + 10 = 17.5 \text{ (dB)}
 \end{aligned}$$

3 Test Result

3.1 Number of Channel Measurement

3.1.1 Limits of Number of Hopping Frequency

Frequency hopping systems in the 2400-2483.5 MHz band shall use at least 15 channels.

3.1.2 Measuring Instruments

See list of measuring instruments of this test report.

3.1.3 Test Procedure

1. The testing follows FCC Public Notice DA 00-705 Measurement Guidelines.
2. The RF output of EUT was connected to the spectrum analyzer by RF cable and attenuator. The path loss was compensated to the results for each measurement.
3. Set to the maximum power setting and enable the EUT transmit continuously.
4. Enable the EUT hopping function.
5. Use the following spectrum analyzer settings: Span = the frequency band of operation; RBW \geq 1% of the span; VBW \geq RBW; Sweep = auto; Detector function = peak; Trace = max hold.
6. The number of hopping frequency used is defined as the number of total channel.
7. Record the measurement data derived from spectrum analyzer.

3.1.4 Test Setup

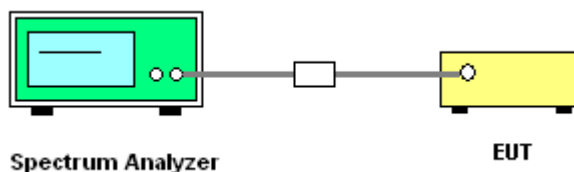

3.1.5 Test Result of Number of Hopping Frequency

Test Mode :	3Mbps	Temperature :	24~26°C
Test Engineer :	Blithe Li	Relative Humidity :	50~53%
Number of Hopping (Channel)	Adaptive Frequency Hopping (Channel)	Limits (Channel)	Pass/Fail
79	20	> 15	Pass



Number of Hopping Channel Plot on Channel 00 - 78

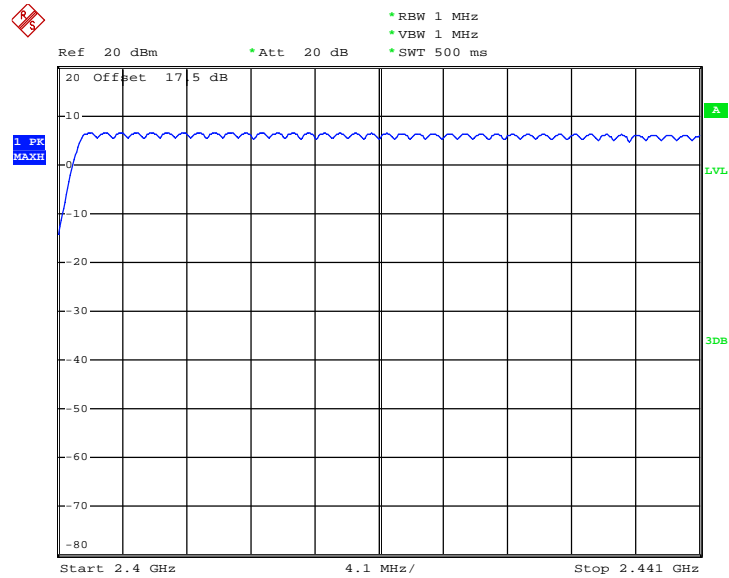

Date: 13.SEP.2013 16:42:19

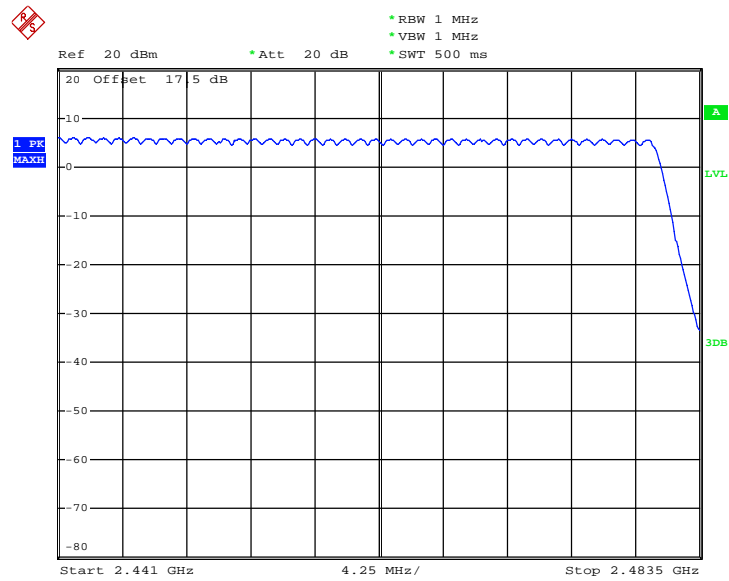

Date: 13.SEP.2013 16:47:09

3.2 Hopping Channel Separation Measurement

3.2.1 Limit of Hopping Channel Separation

Frequency hopping systems operating in the 2400-2483.5 MHz band may have hopping channel carrier frequencies that are separated by 25 kHz or two-thirds of the 20 dB bandwidth of the hopping channel, whichever is greater.

3.2.2 Measuring Instruments

See list of measuring instruments of this test report.

3.2.3 Test Procedures

1. The testing follows FCC Public Notice DA 00-705 Measurement Guidelines.
2. The RF output of EUT was connected to the spectrum analyzer by RF cable and attenuator. The path loss was compensated to the results for each measurement.
3. Set to the maximum power setting and enable the EUT transmit continuously.
4. Enable the EUT hopping function.
5. Use the following spectrum analyzer settings:
Span = wide enough to capture the peaks of two adjacent channels; $RBW \geq 1\%$ of the span;
 $VBW \geq RBW$; Sweep = auto; Detector function = peak; Trace = max hold.
6. Measure and record the results in the test report.

3.2.4 Test Setup

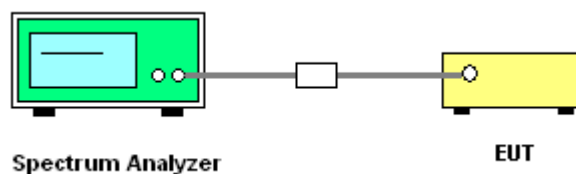



3.2.5 Test Result of Hopping Channel Separation

Test Mode :	1Mbps	Temperature :	24~26°C
Test Engineer :	Blithe Li	Relative Humidity :	50~53%

Channel	Frequency (MHz)	Frequency Separation (MHz)	(2/3 of 20dB BW) Limits (MHz)	Pass/Fail
00	2402	1.002	0.6080	Pass
39	2441	1.002	0.6053	Pass
78	2480	1.002	0.5653	Pass

Channel Separation Plot on Channel 00 - 01

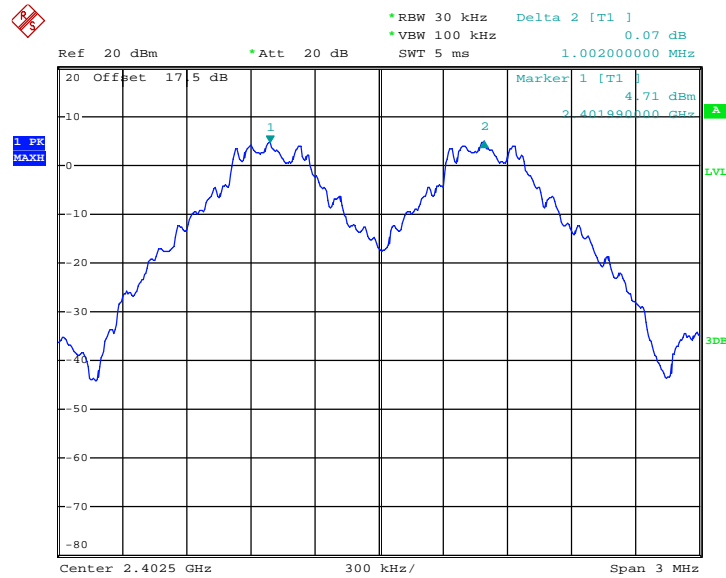

Date: 13.SEP.2013 16:02:16



Channel Separation Plot on Channel 39 - 40

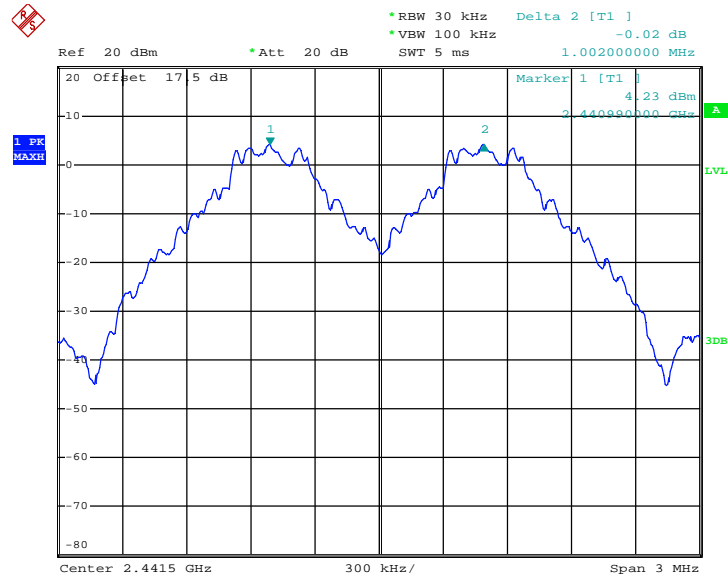

Date: 13.SEP.2013 16:03:04

Channel Separation Plot on Channel 77 - 78

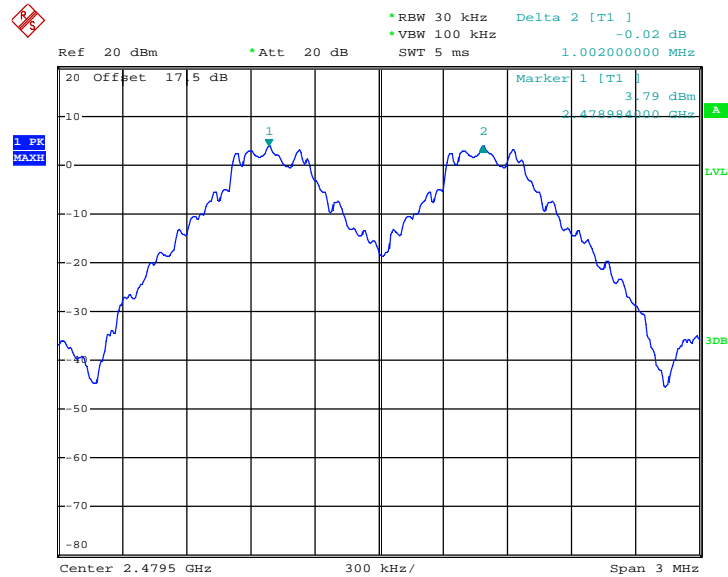

Date: 13.SEP.2013 16:03:46



Test Mode :	2Mbps	Temperature :	24~26°C
Test Engineer :	Blithe Li	Relative Humidity :	50~53%

Channel	Frequency (MHz)	Frequency Separation (MHz)	(2/3 of 20dB BW) Limits (MHz)	Pass/Fail
00	2402	0.996	0.8440	Pass
39	2441	1.008	0.8440	Pass
78	2480	0.996	0.8120	Pass

Channel Separation Plot on Channel 00 - 01

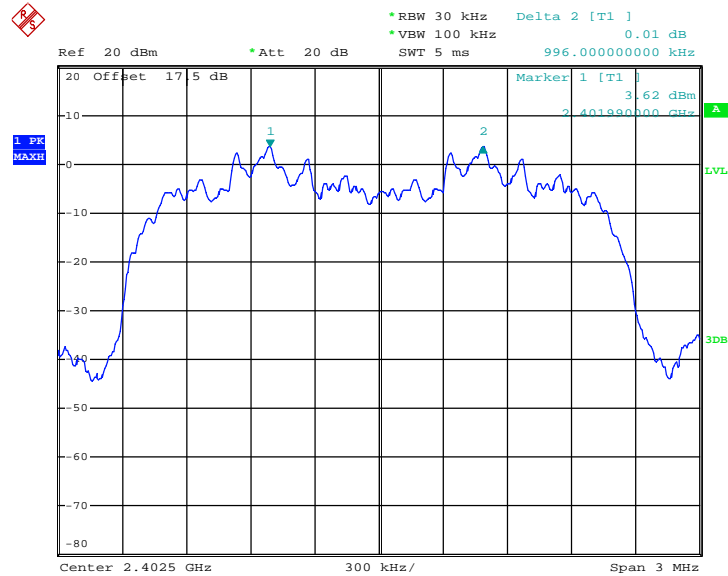

Date: 13.SEP.2013 16:50:14



Channel Separation Plot on Channel 39 - 40

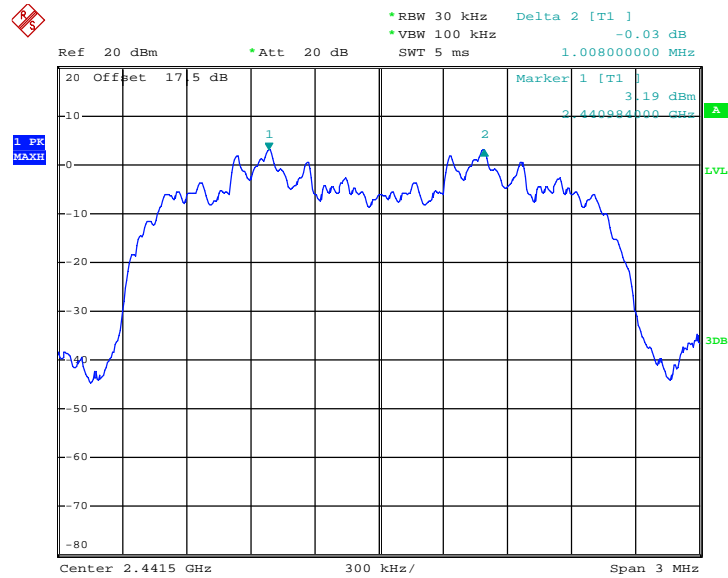

Date: 13.SEP.2013 16:05:16

Channel Separation Plot on Channel 77 - 78

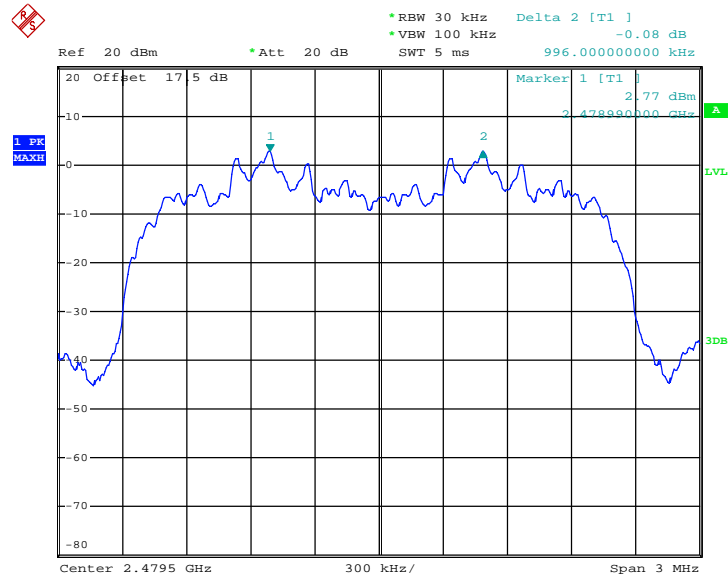

Date: 13.SEP.2013 16:05:57



Test Mode :	3Mbps	Temperature :	24~26°C
Test Engineer :	Blithe Li	Relative Humidity :	50~53%

Channel	Frequency (MHz)	Frequency Separation (MHz)	(2/3 of 20dB BW) Limits (MHz)	Pass/Fail
00	2402	1.002	0.8200	Pass
39	2441	1.002	0.8200	Pass
78	2480	1.002	0.8200	Pass

Channel Separation Plot on Channel 00 - 01

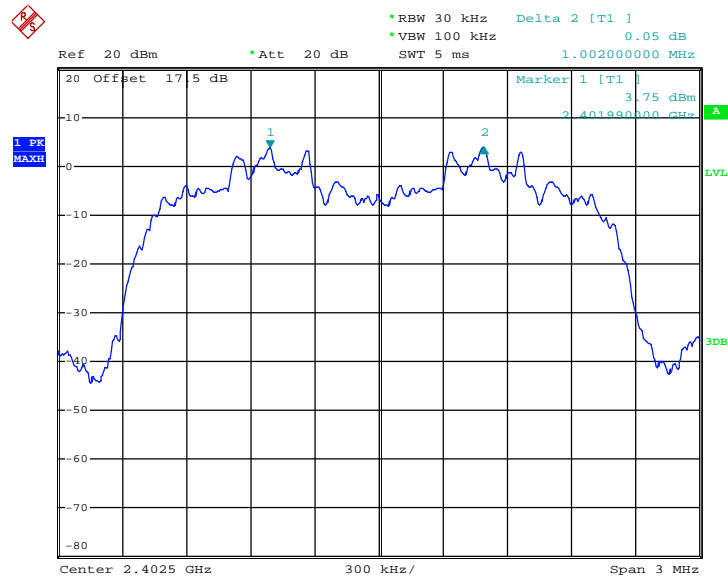

Date: 13.SEP.2013 16:07:00



Channel Separation Plot on Channel 39 - 40

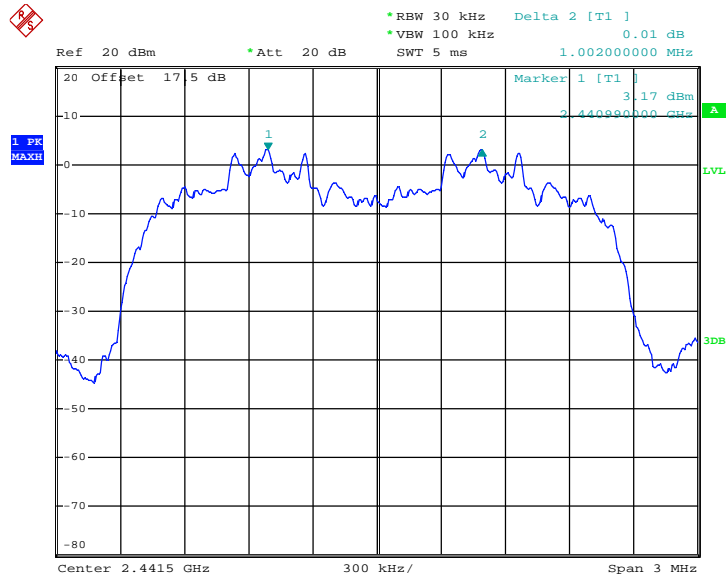

Date: 13.SEP.2013 16:07:49

Channel Separation Plot on Channel 77 - 78

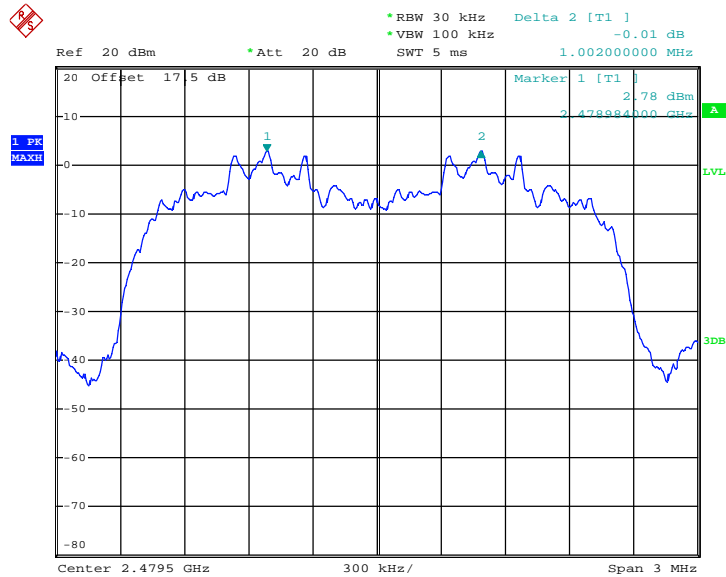

Date: 13.SEP.2013 16:08:33

3.3 Dwell Time Measurement

3.3.1 Limit of Dwell Time

The average time of occupancy on any channel shall not be greater than 0.4 seconds within a period of 0.4 seconds multiplied by the number of hopping channels employed.

3.3.2 Measuring Instruments

See list of measuring instruments of this test report.

3.3.3 Test Procedures

1. The testing follows FCC Public Notice DA 00-705 Measurement Guidelines.
2. The RF output of EUT was connected to the spectrum analyzer by RF cable and attenuator. The path loss was compensated to the results for each measurement.
3. Set to the maximum power setting and enable the EUT transmit continuously.
4. Enable the EUT hopping function.
5. Use the following spectrum analyzer settings: Span = zero span, centered on a hopping channel; RBW = 1 MHz; VBW \geq RBW; Sweep = as necessary to capture the entire dwell time per hopping channel; Detector function = peak; Trace = max hold.
6. Measure and record the results in the test report.

3.3.4 Test Setup

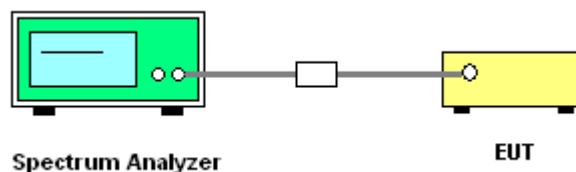

3.3.5 Test Result of Dwell Time

Test Mode :	3DH5	Temperature :	24~26°C
Test Engineer :	Blithe Li	Relative Humidity :	50~53%

Mode	Hopping Channel Number	Hops Over Occupancy Time(hops)	Package Transfer Time (msec)	Dwell Time (sec)	Limits (sec)	Pass/Fail
Normal	79	106.67	2.874	0.31	0.4	Pass
AFH	20	53.33	2.874	0.15	0.4	Pass

Remark:

- In normal mode, hopping rate is 1600hops/s with 6 slots in 79 hopping channels.
With channel hopping rate (1600 / 6 / 79) in Occupancy Time Limit (0.4 x 79) (s),
Hops Over Occupancy Time comes to (1600 / 6 / 79) x (0.4 x 79) = 106.67 hops.
- In AFH mode, hopping rate is 800hops/s with 6 slots in 20 hopping channels.
With channel hopping rate (800 / 6 / 20) in Occupancy Time Limit (0.4 x 20) (s),
Hops Over Occupancy Time comes to (800 / 6 / 20) x (0.4 x 20) = 53.33 hops.
- Dwell Time(s) = Hops Over Occupancy Time (hops) x Package Transfer Time

Package Transfer Time Plot

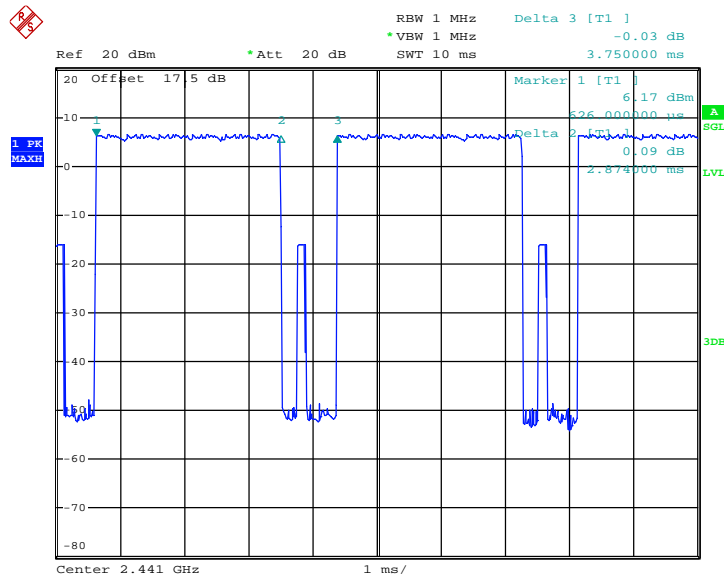

Date: 12.SEP.2013 22:55:22

3.4 20dB Bandwidth Measurement

3.4.1 Limit of 20dB Bandwidth

Reporting only

3.4.2 Measuring Instruments

See list of measuring instruments of this test report.

3.4.3 Test Procedures

1. The testing follows FCC Public Notice DA 00-705 Measurement Guidelines.
2. The RF output of EUT was connected to the spectrum analyzer by RF cable and attenuator. The path loss was compensated to the results for each measurement.
3. Set to the maximum power setting and enable the EUT transmit continuously.
4. Use the following spectrum analyzer settings for 20dB Bandwidth measurement.
Span = approximately 2 to 3 times the 20 dB bandwidth, centered on a hopping channel;
RBW \geq 1% of the 20 dB bandwidth; VBW \geq RBW; Sweep = auto; Detector function = peak;
Trace = max hold.
5. Measure and record the results in the test report.

3.4.4 Test Setup

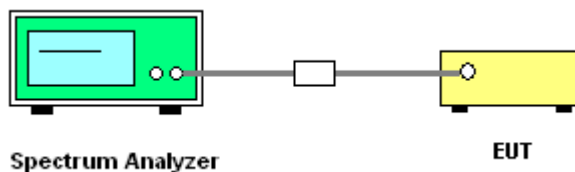



20 dB Bandwidth Plot on Channel 39

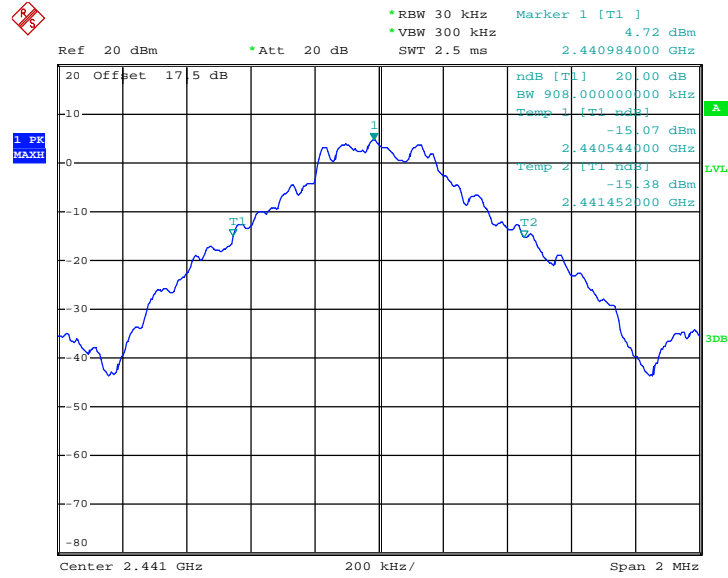

Date: 13.SEP.2013 16:17:27

20 dB Bandwidth Plot on Channel 78

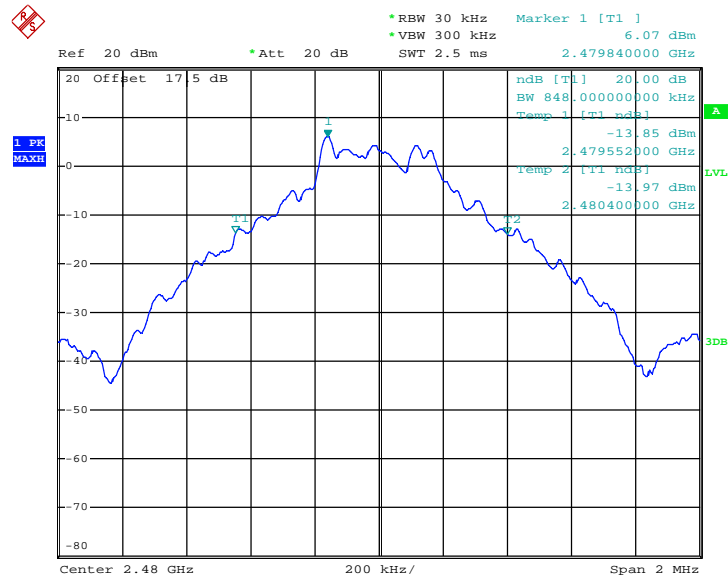

Date: 13.SEP.2013 16:18:44



Test Mode :	2Mbps	Temperature :	24~26°C
Test Engineer :	Blithe Li	Relative Humidity :	50~53%

Channel	Frequency (MHz)	20dB Bandwidth (MHz)
00	2402	1.266
39	2441	1.266
78	2480	1.218

20 dB Bandwidth Plot on Channel 00

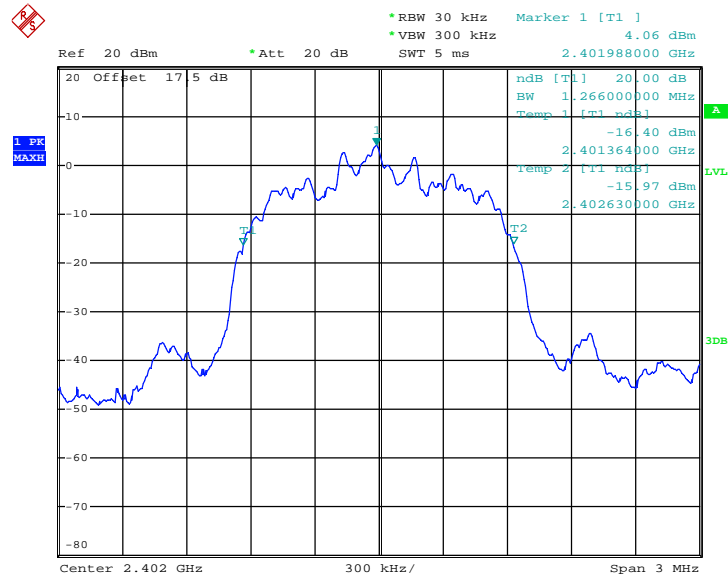

Date: 13.SEP.2013 16:21:27



20 dB Bandwidth Plot on Channel 39

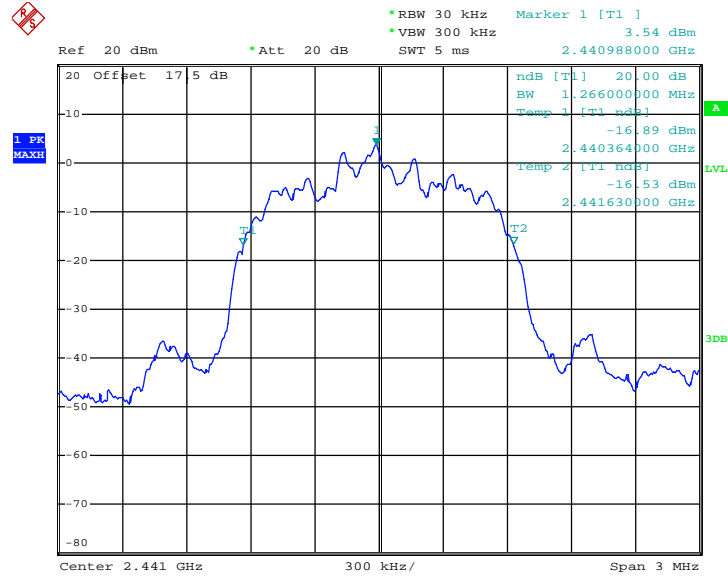

Date: 13.SEP.2013 16:23:06

20 dB Bandwidth Plot on Channel 78

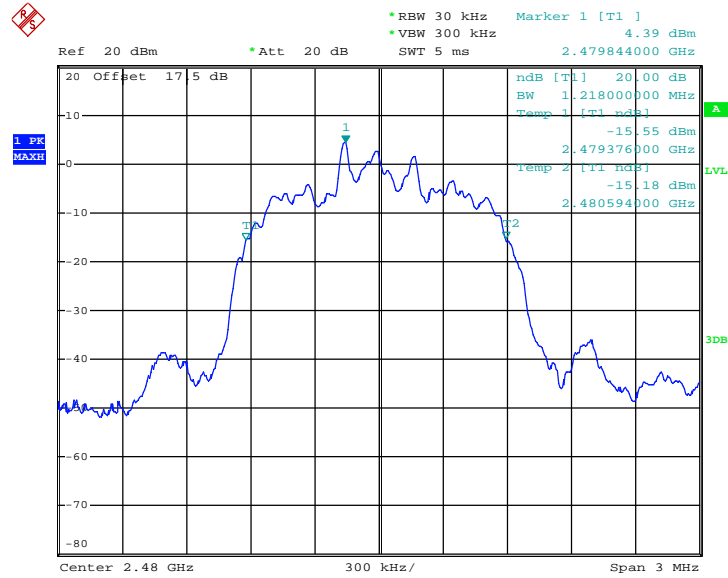

Date: 13.SEP.2013 16:23:24



Test Mode :	3Mbps	Temperature :	24~26°C
Test Engineer :	Blithe Li	Relative Humidity :	50~53%

Channel	Frequency (MHz)	20dB Bandwidth (MHz)
00	2402	1.230
39	2441	1.230
78	2480	1.230

20 dB Bandwidth Plot on Channel 00

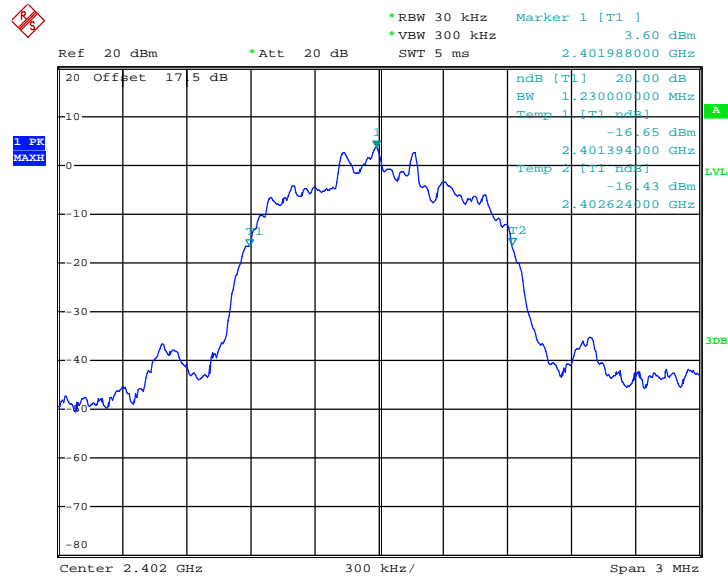

Date: 13.SEP.2013 16:24:19



20 dB Bandwidth Plot on Channel 39

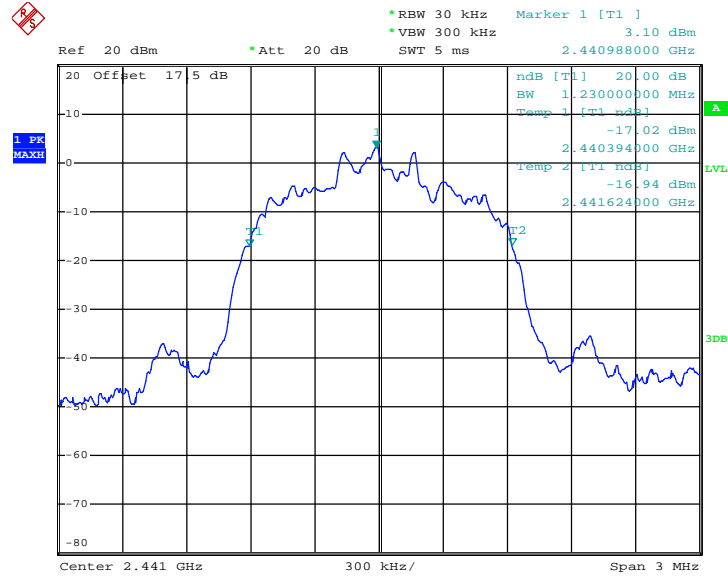

Date: 13.SEP.2013 16:25:34

20 dB Bandwidth Plot on Channel 78

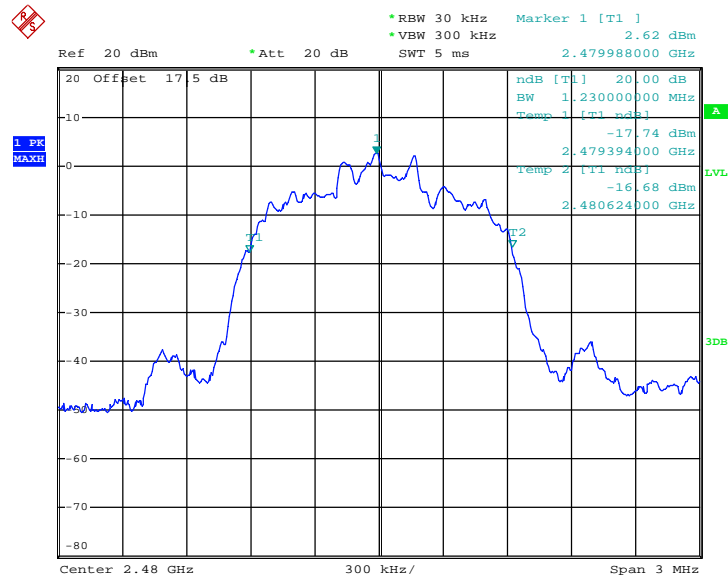

Date: 13.SEP.2013 16:26:12

3.5 Peak Output Power Measurement

3.5.1 Limit of Peak Output Power

Section 15.247 (b) The maximum peak conducted output power of the intentional radiator shall not exceed the following: (1) For frequency hopping systems operating in the 2400-2483.5 MHz band employing at least 75 non-overlapping hopping channels, and all frequency hopping systems in the 5725-5850 MHz band: 1 watt. For all other frequency hopping systems in the 2400-2483.5 MHz band 0.125 watts.

3.5.2 Measuring Instruments

See list of measuring instruments of this test report.

3.5.3 Test Procedures

1. The testing follows FCC Public Notice DA 00-705 Measurement Guidelines.
2. The RF output of EUT was connected to the power meter by RF cable and attenuator. The path loss was compensated to the results for each measurement.
3. Set to the maximum power setting and enable the EUT transmit continuously.
4. Measure the conducted output power with cable loss and record the results in the test report.
5. Measure and record the results in the test report.

3.5.4 Test Setup

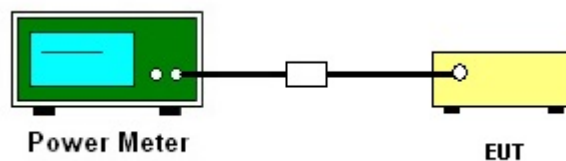



3.5.5 Test Result of Peak Output Power

Test Mode :	1Mbps	Temperature :	24~26°C
Test Engineer :	Blithe Li	Relative Humidity :	50~53%

Channel	Frequency (MHz)	RF Power (dBm)		
		GFSK	Max. Limits (dBm)	Pass/Fail
		1 Mbps		
00	2402	9.12	20.97	Pass
39	2441	8.67	20.97	Pass
78	2480	8.50	20.97	Pass

Test Mode :	2Mbps	Temperature :	24~26°C
Test Engineer :	Blithe Li	Relative Humidity :	50~53%

Channel	Frequency (MHz)	RF Power (dBm)		
		$\pi/4$ -DQPSK	Max. Limits (dBm)	Pass/Fail
		2 Mbps		
00	2402	8.89	20.97	Pass
39	2441	8.39	20.97	Pass
78	2480	8.23	20.97	Pass

Test Mode :	3Mbps	Temperature :	24~26°C
Test Engineer :	Blithe Li	Relative Humidity :	50~53%

Channel	Frequency (MHz)	RF Power (dBm)		
		8-DPSK	Max. Limits (dBm)	Pass/Fail
		3 Mbps		
00	2402	9.15	20.97	Pass
39	2441	8.71	20.97	Pass
78	2480	8.49	20.97	Pass

3.6 Conducted Band Edges Measurement

3.6.1 Limit of Band Edges

In any 100 kHz bandwidth outside the intentional radiation frequency band, the radio frequency power shall be at least 20 dB below the highest level of the radiated power. In addition, radiated emissions which fall in the restricted bands must also comply with the radiated emission limits.

3.6.2 Measuring Instruments

See list of measuring instruments of this test report.

3.6.3 Test Procedures

1. The testing follows the guidelines in Band-edge Compliance of RF Conducted Emissions of FCC Public Notice DA 00-705 Measurement Guidelines.
2. Set to the maximum power setting and enable the EUT transmit continuously.
3. Set RBW = 100kHz ($\geq 1\%$ span=10MHz), VBW = 300kHz (\geq RBW). Band edge emissions must be at least 20 dB down from the highest emission level within the authorized band as measured with a 100kHz RBW. The attenuation shall be 30 dB instead of 20 dB when RMS conducted output power procedure is used.
4. Enable hopping function of the EUT and then repeat step 2. and 3.
5. Measure and record the results in the test report.

3.6.4 Test Setup

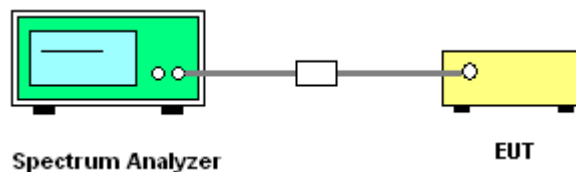



3.6.5 Test Result of Conducted Band Edges

Test Mode :	1Mbps	Temperature :	24~26°C
Test Channel :	00 and 78	Relative Humidity :	50~53%
		Test Engineer :	Blithe Li

Low Band Edge Plot on Channel 00

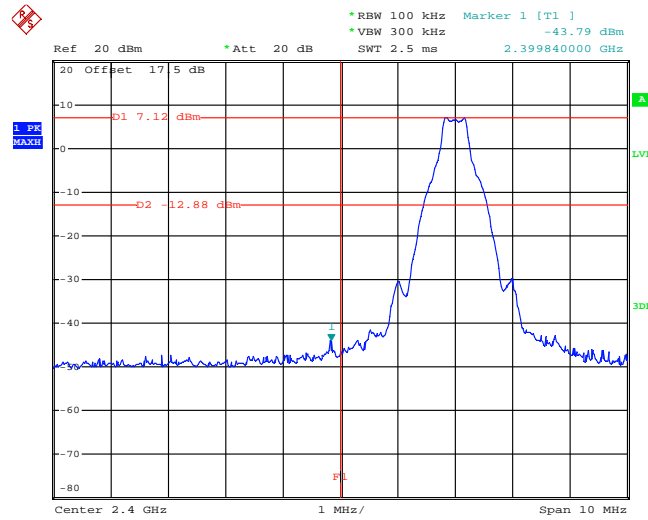

Date: 13.SEP.2013 18:14:50

High Band Edge Plot on Channel 78

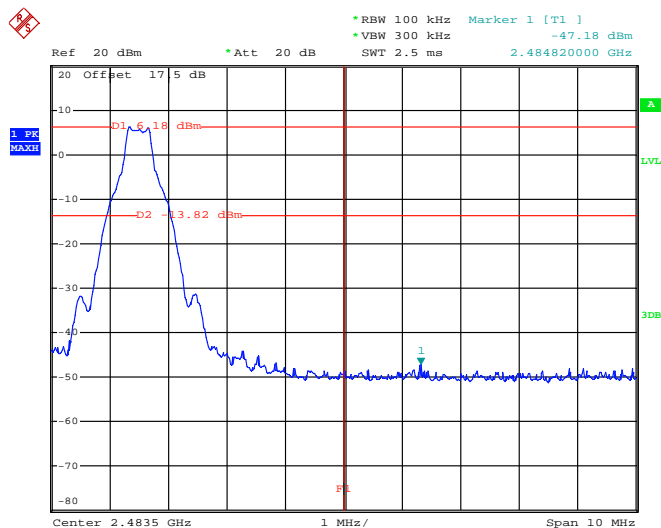

Date: 13.SEP.2013 18:33:32



Test Mode :	2Mbps	Temperature :	24~26°C
Test Channel :	00 and 78	Relative Humidity :	50~53%
		Test Engineer :	Blithe Li

Low Band Edge Plot on Channel 00

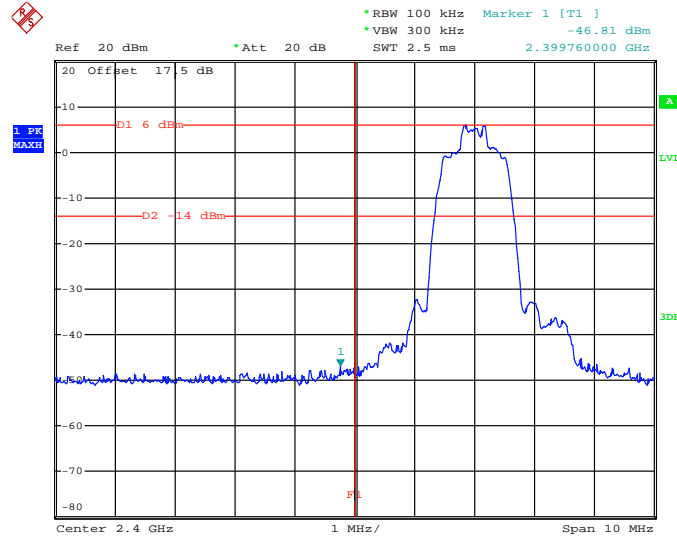

Date: 13.SEP.2013 18:15:42

High Band Edge Plot on Channel 78

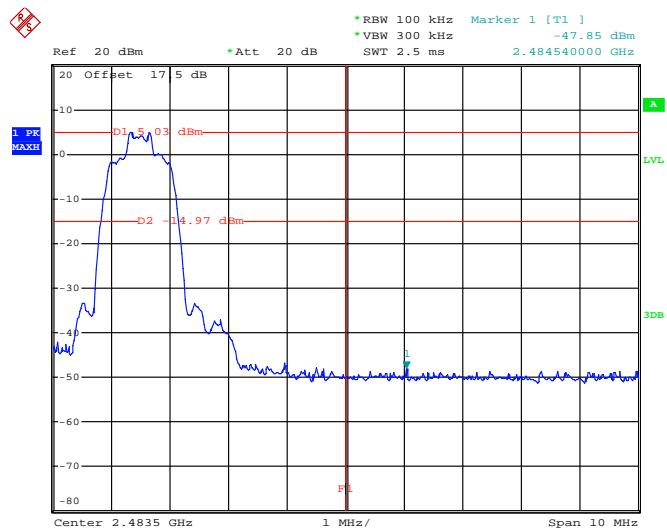

Date: 13.SEP.2013 18:32:42



Test Mode :	3Mbps	Temperature :	24~26°C
Test Channel :	00 and 78	Relative Humidity :	50~53%
		Test Engineer :	Blithe Li

Low Band Edge Plot on Channel 00

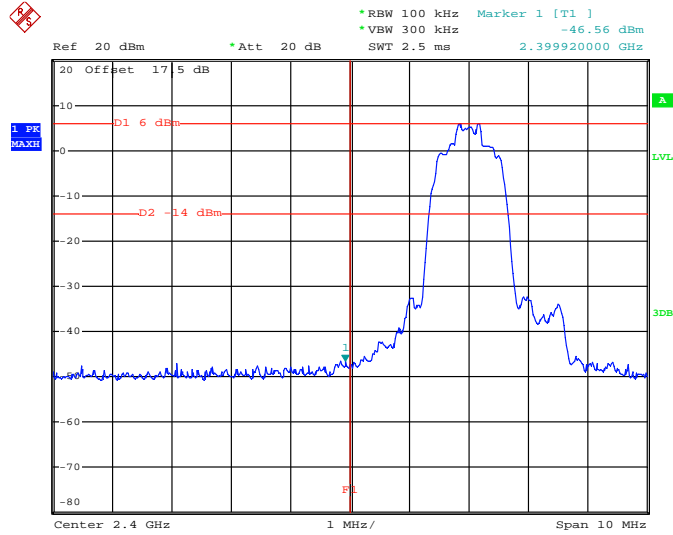

Date: 13.SEP.2013 18:30:22

High Band Edge Plot on Channel 78

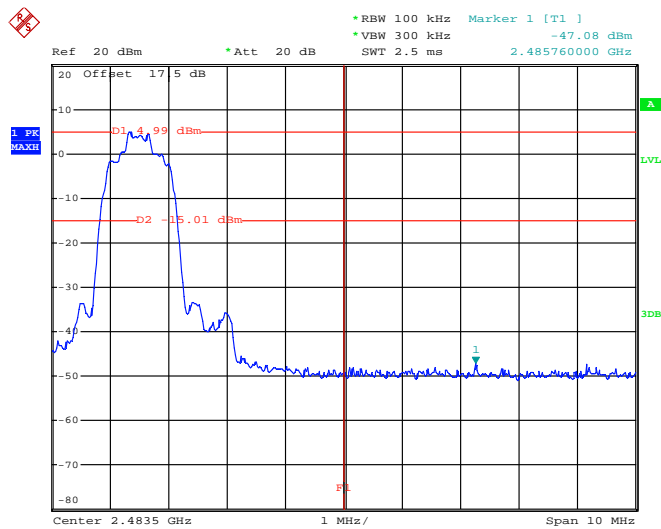

Date: 13.SEP.2013 18:31:55

3.6.6 Test Result of Conducted Hopping Mode Band Edges

Test Mode :	1Mbps	Temperature :	24~26°C
Test Channel :	00 and 78	Relative Humidity :	50~53%
		Test Engineer :	Blithe Li

1Mbps Hopping Mode Low Band Edge Plot

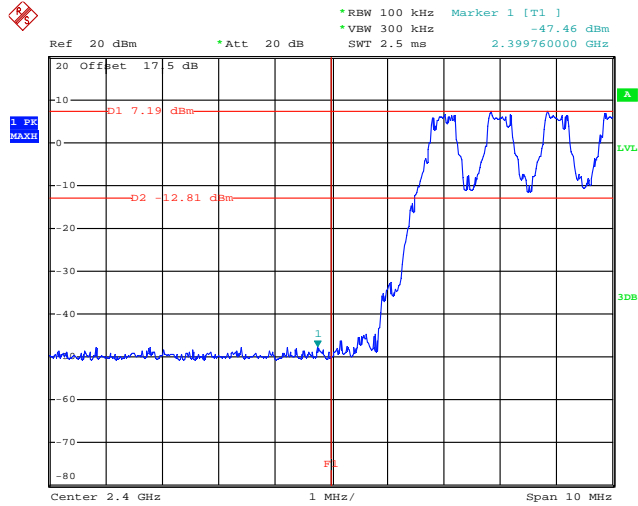

Date: 13.SEP.2013 18:46:04

1Mbps Hopping Mode High Band Edge Plot

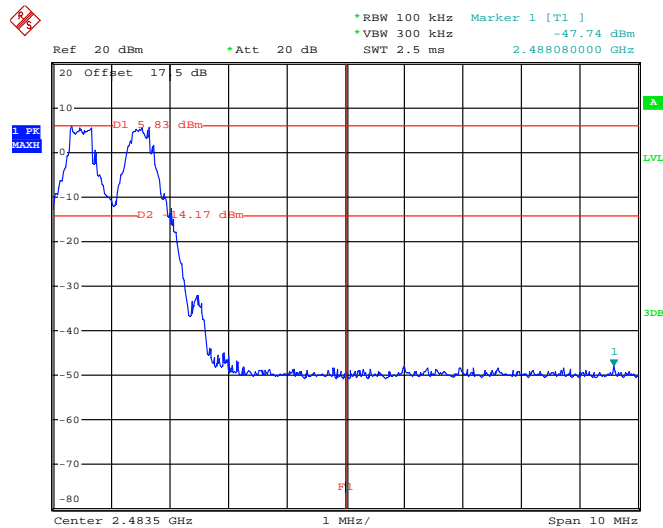

Date: 13.SEP.2013 18:35:02



Test Mode :	2Mbps	Temperature :	24~26°C
Test Channel :	00 and 78	Relative Humidity :	50~53%
		Test Engineer :	Blithe Li

2Mbps Hopping Mode Low Band Edge Plot

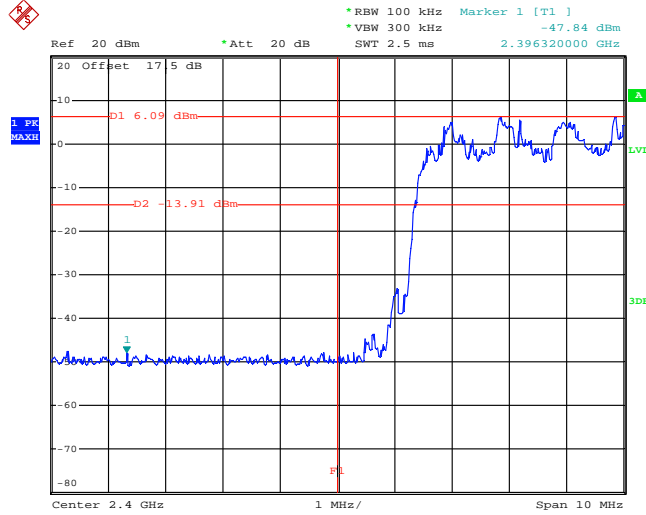

Date: 13.SEP.2013 18:47:43

2Mbps Hopping Mode High Band Edge Plot

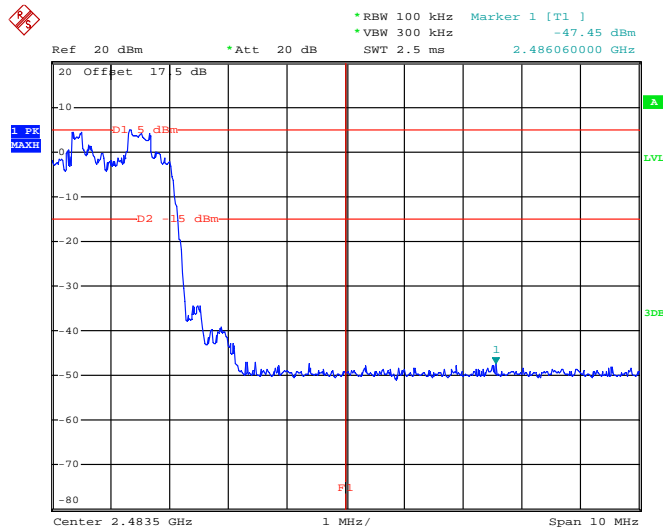

Date: 13.SEP.2013 18:36:47



Test Mode :	3Mbps	Temperature :	24~26°C
Test Channel :	00 and 78	Relative Humidity :	50~53%
		Test Engineer :	Blithe Li

3Mbps Hopping Mode Low Band Edge Plot

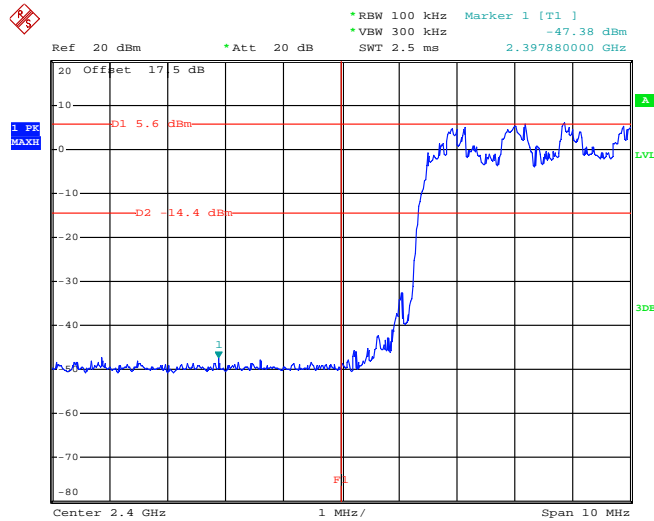

Date: 13.SEP.2013 18:42:05

3Mbps Hopping Mode High Band Edge Plot

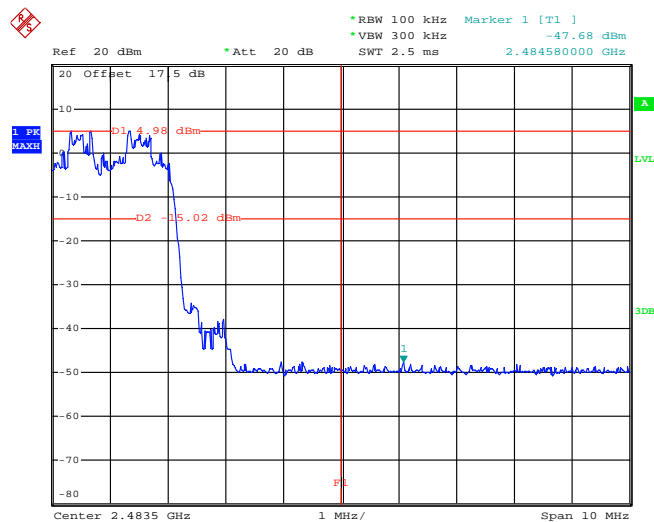

Date: 13.SEP.2013 18:38:23

3.7 Conducted Spurious Emission Measurement

3.7.1 Limit of Spurious Emission Measurement

In any 100 kHz bandwidth outside the intentional radiation frequency band, the radio frequency power shall be at least 20 dB below the highest level of the radiated power. In addition, radiated emissions which fall in the restricted bands must also comply with the radiated emission limits.

3.7.2 Measuring Instruments

See list of measuring instruments of this test report.

3.7.3 Test Procedure

1. The testing follows the guidelines in Spurious RF Conducted Emissions of FCC Public Notice DA 00-705 Measurement Guidelines
2. The RF output of EUT was connected to the spectrum analyzer by RF cable and attenuator. The path loss was compensated to the results for each measurement.
3. Set to the maximum power setting and enable the EUT transmit continuously.
4. Set RBW = 100 kHz, VBW = 300kHz, scan up through 10th harmonic. All harmonics / spurs must be at least 20 dB down from the highest emission level within the authorized band as measured with a 100 kHz RBW.
5. Measure and record the results in the test report.
6. The RF fundamental frequency should be excluded against the limit line in the operating frequency band.

3.7.4 Test Setup

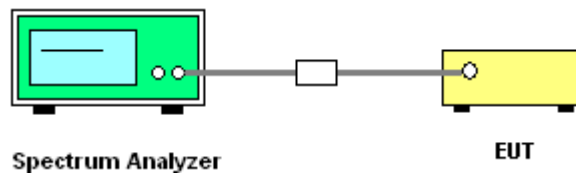



3.7.5 Test Result of Conducted Spurious Emission

Test Mode :	1Mbps	Temperature :	24~26°C
Test Channel :	00	Relative Humidity :	50~53%
		Test Engineer :	Blithe Li

1Mbps CSE Plot on Ch 00 between 30MHz ~ 3 GHz

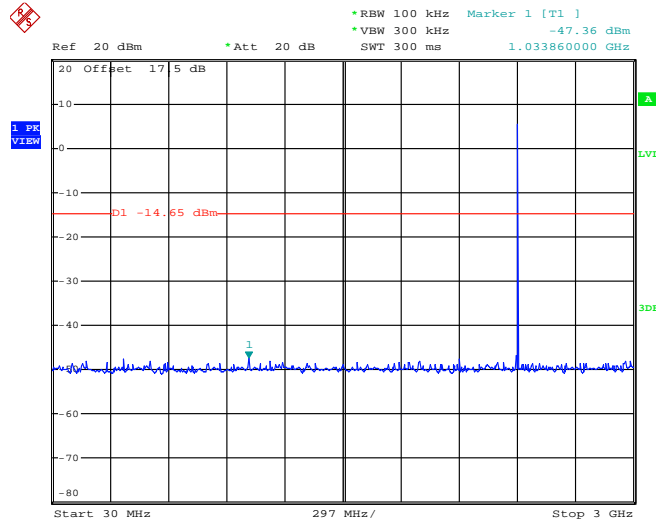

Date: 25.SEP.2013 15:24:40

1Mbps CSE Plot on Ch 00 between 2 GHz ~ 25 GHz

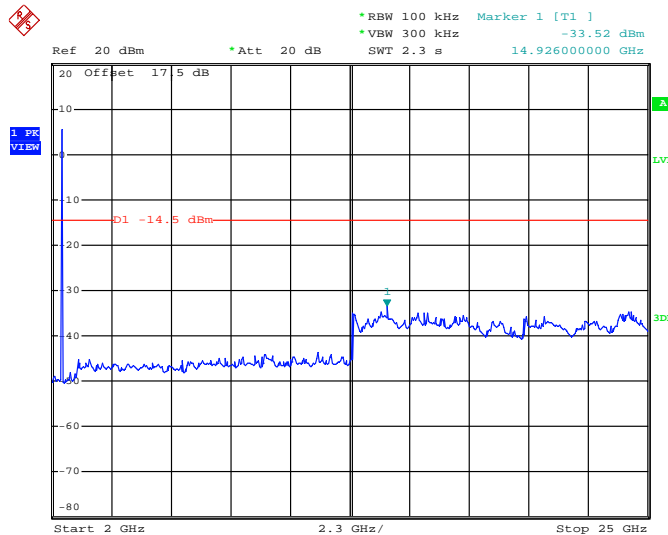

Date: 25.SEP.2013 15:25:02



Test Mode :	1Mbps	Temperature :	24~26°C
Test Channel :	39	Relative Humidity :	50~53%
		Test Engineer :	Blithe Li

1Mbps CSE Plot on Ch 39 between 30MHz ~ 3 GHz

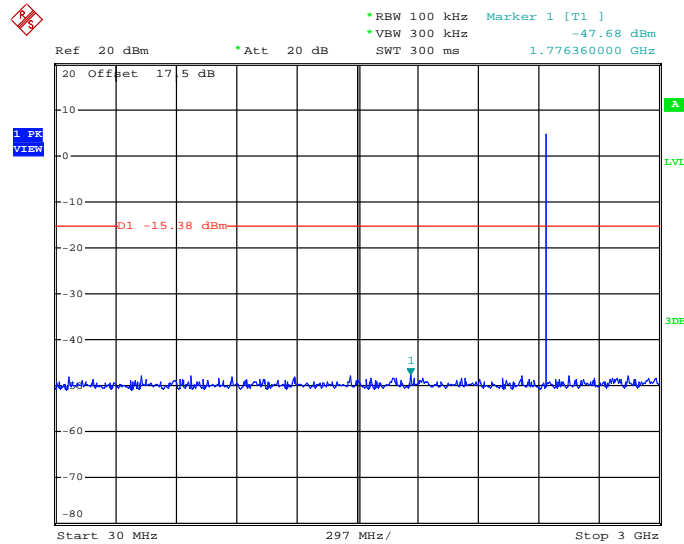

Date: 25.SEP.2013 15:26:46

1Mbps CSE Plot on Ch 39 between 2 GHz ~ 25 GHz

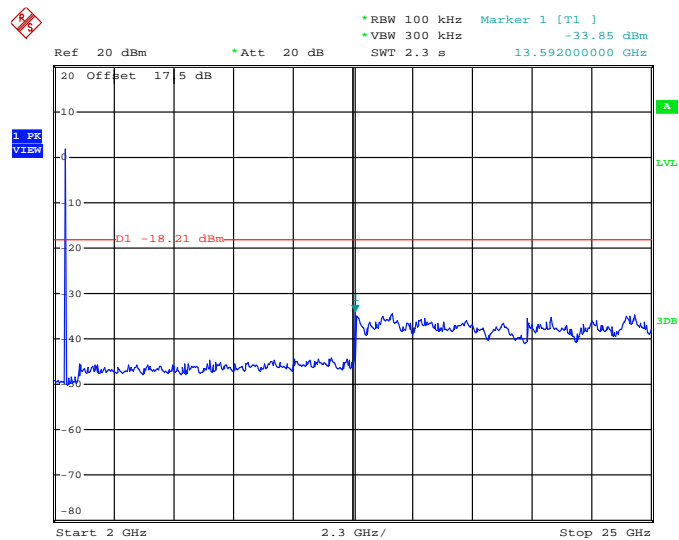

Date: 25.SEP.2013 15:27:08



Test Mode :	1Mbps	Temperature :	24~26°C
Test Channel :	78	Relative Humidity :	50~53%
		Test Engineer :	Blithe Li

1Mbps CSE Plot on Ch 78 between 30MHz ~ 3 GHz

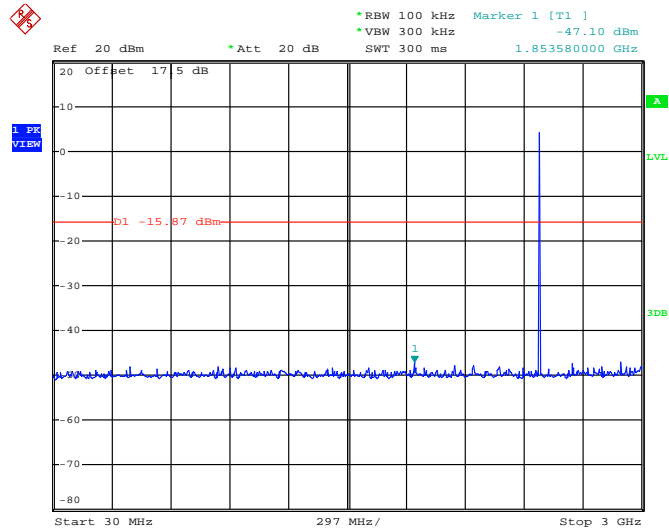

Date: 25.SEP.2013 15:27:40

1Mbps CSE Plot on Ch 78 between 2 GHz ~ 25 GHz

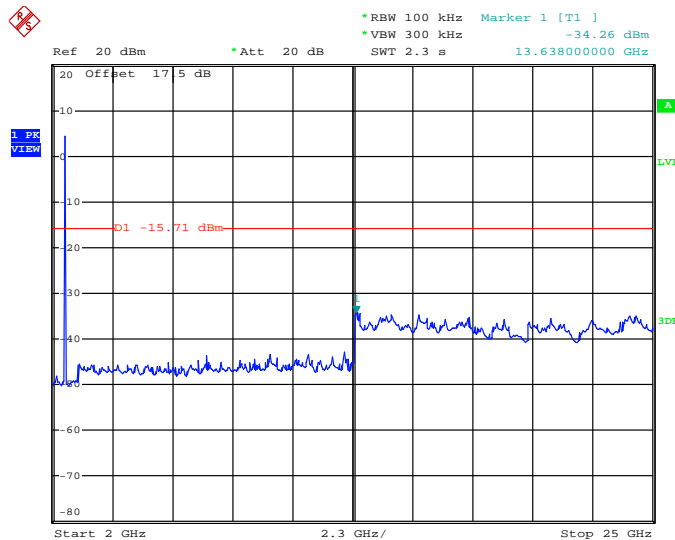

Date: 25.SEP.2013 15:28:02



Test Mode :	2Mbps	Temperature :	24~26°C
Test Channel :	00	Relative Humidity :	50~53%
		Test Engineer :	Blithe Li

2Mbps CSE Plot on Ch 00 between 30MHz ~ 3 GHz

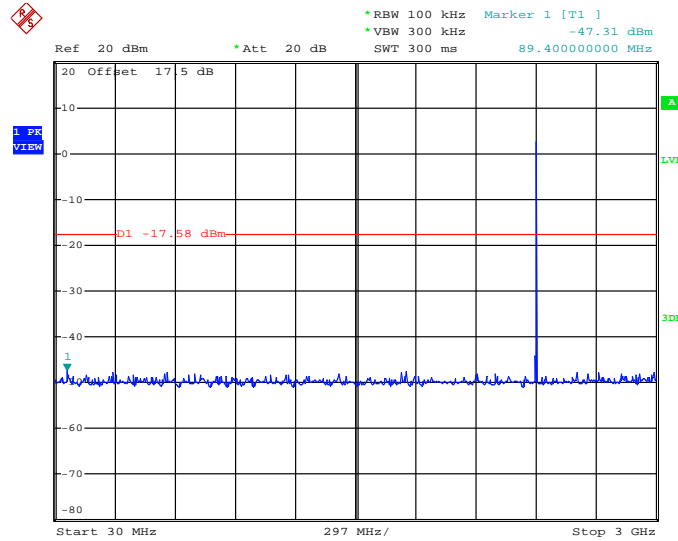

Date: 25.SEP.2013 15:30:34

2Mbps CSE Plot on Ch 00 between 2 GHz ~ 25 GHz

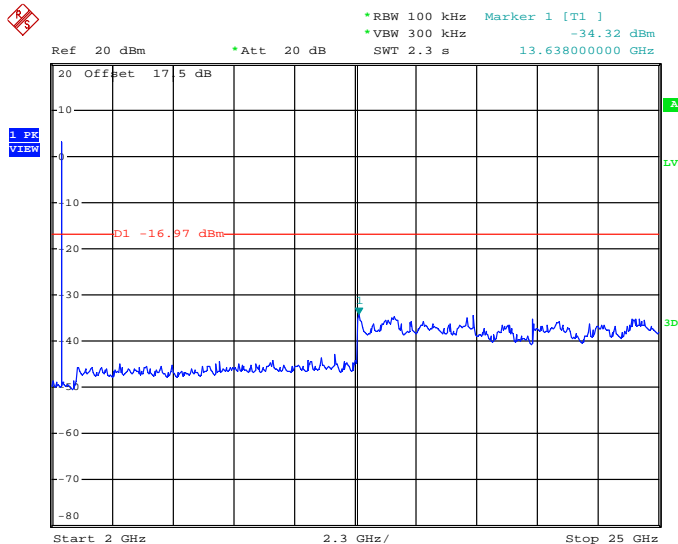

Date: 25.SEP.2013 15:30:56



Test Mode :	2Mbps	Temperature :	24~26°C
Test Channel :	39	Relative Humidity :	50~53%
		Test Engineer :	Blithe Li

2Mbps CSE Plot on Ch 39 between 30MHz ~ 3 GHz

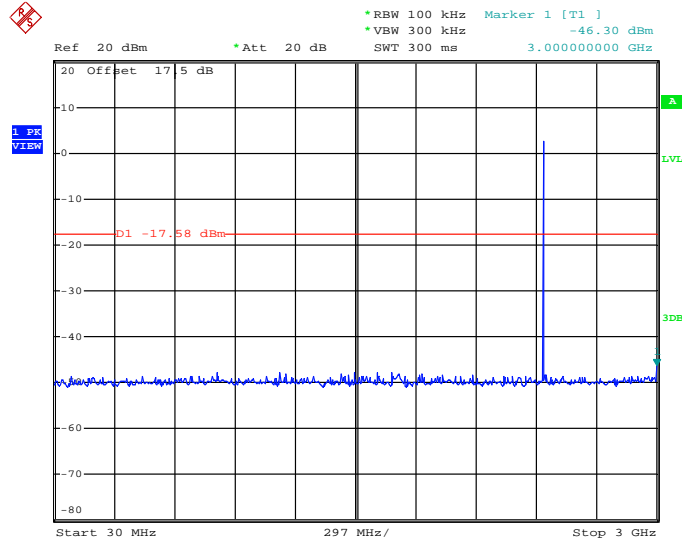

Date: 25.SEP.2013 15:29:32

2Mbps CSE Plot on Ch 39 between 2 GHz ~ 25 GHz

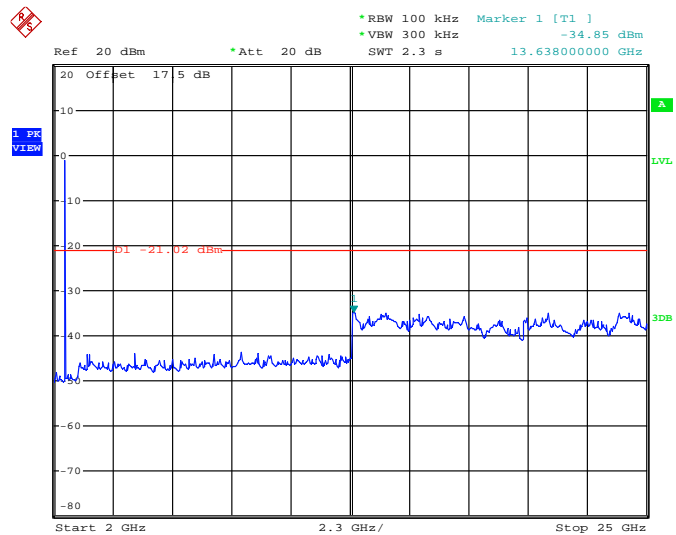

Date: 25.SEP.2013 15:29:54



Test Mode :	2Mbps	Temperature :	24~26°C
Test Channel :	78	Relative Humidity :	50~53%
		Test Engineer :	Blithe Li

2Mbps CSE Plot on Ch 78 between 30MHz ~ 3 GHz

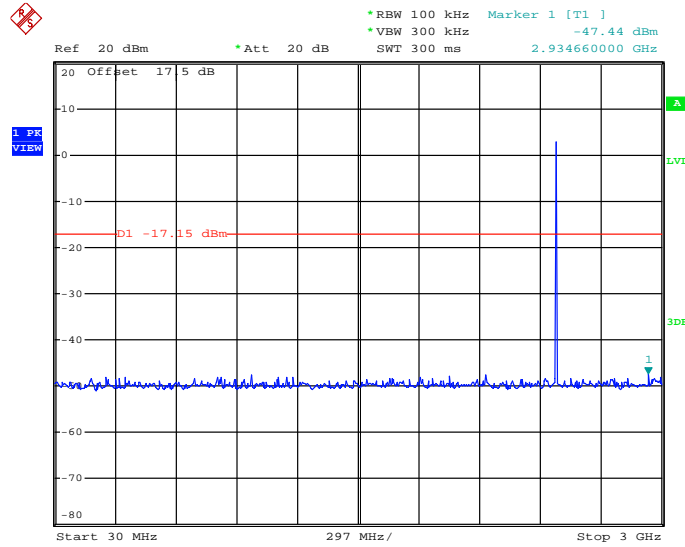

Date: 25.SEP.2013 15:28:34

2Mbps CSE Plot on Ch 78 between 2 GHz ~ 25 GHz

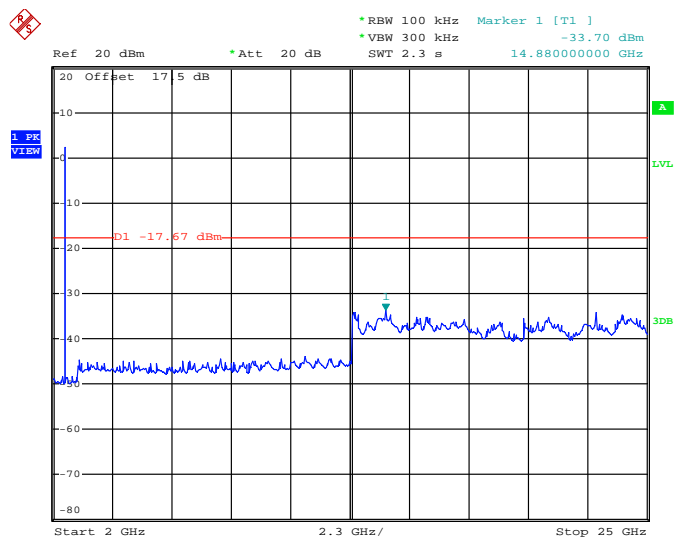

Date: 25.SEP.2013 15:28:56



Test Mode :	3Mbps	Temperature :	24~26°C
Test Channel :	00	Relative Humidity :	50~53%
		Test Engineer :	Blithe Li

3Mbps CSE Plot on Ch 00 between 30MHz ~ 3 GHz

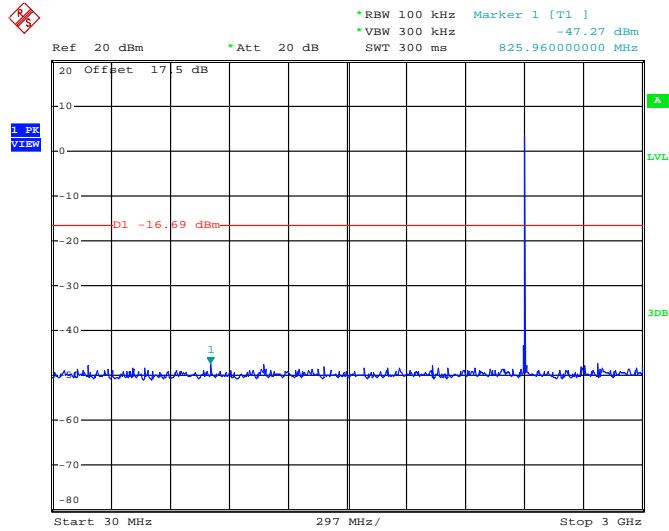

Date: 25.SEP.2013 15:31:47

3Mbps CSE Plot on Ch 00 between 2 GHz ~ 25 GHz

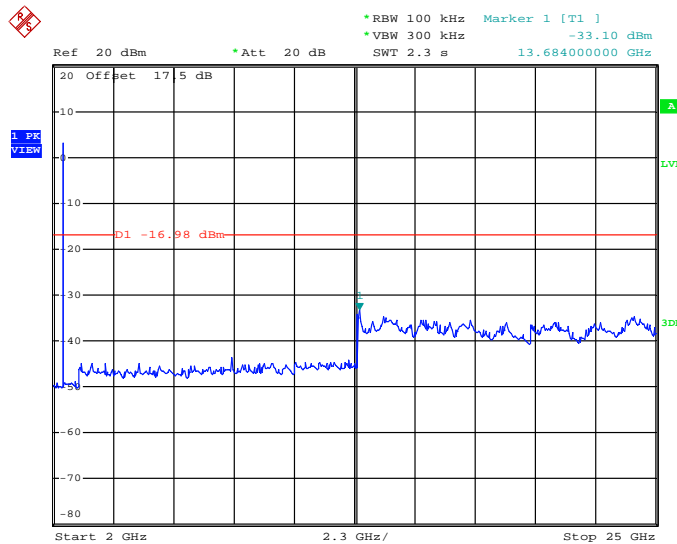

Date: 25.SEP.2013 15:32:09



Test Mode :	3Mbps	Temperature :	24~26°C
Test Channel :	39	Relative Humidity :	50~53%
		Test Engineer :	Blithe Li

3Mbps CSE Plot on Ch 39 between 30MHz ~ 3 GHz

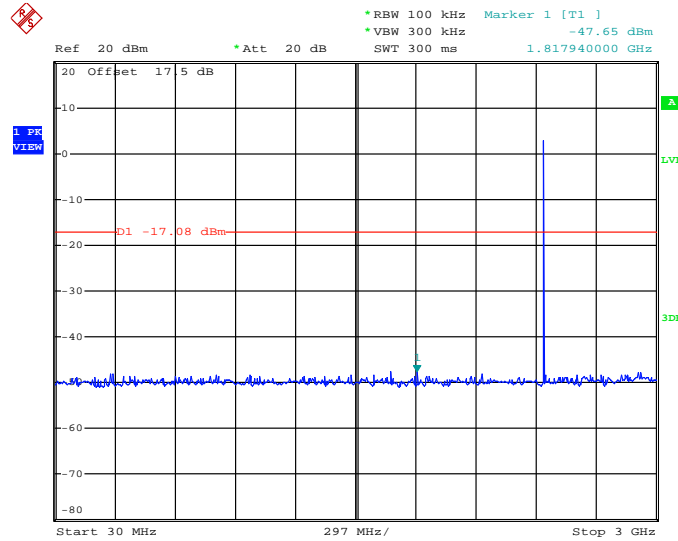

Date: 25.SEP.2013 15:32:45

3Mbps CSE Plot on Ch 39 between 2 GHz ~ 25 GHz

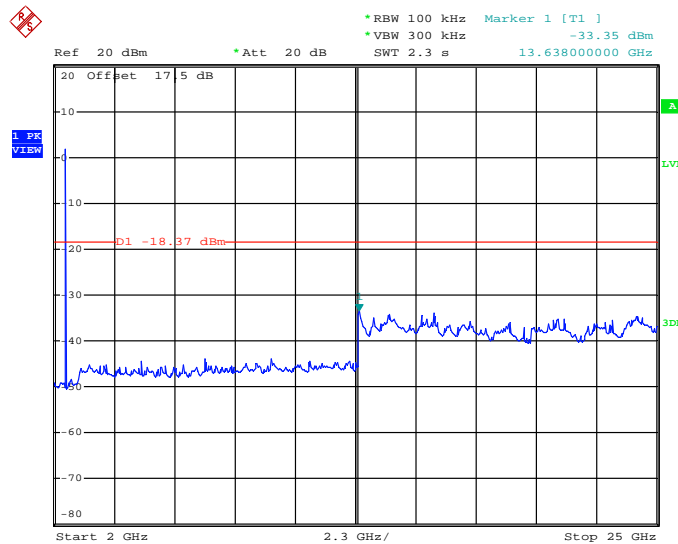

Date: 25.SEP.2013 15:33:07



Test Mode :	3Mbps	Temperature :	24~26°C
Test Channel :	78	Relative Humidity :	50~53%
		Test Engineer :	Blithe Li

3Mbps CSE Plot on Ch 78 between 30MHz ~ 3 GHz

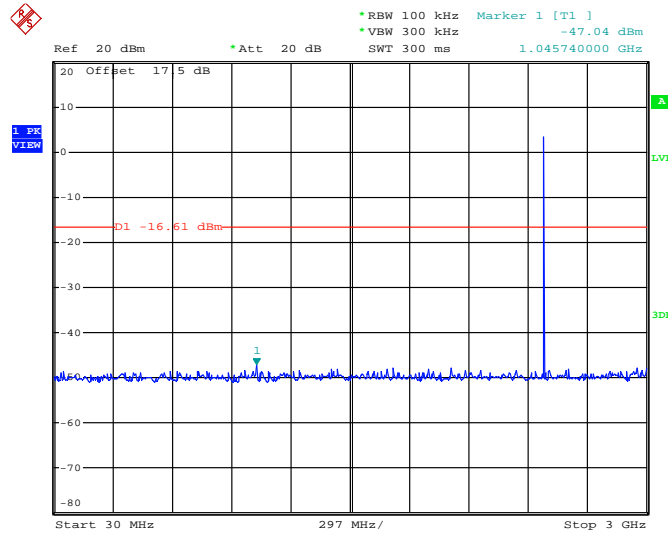

Date: 25.SEP.2013 15:33:50

3Mbps CSE Plot on Ch 78 between 2 GHz ~ 25 GHz

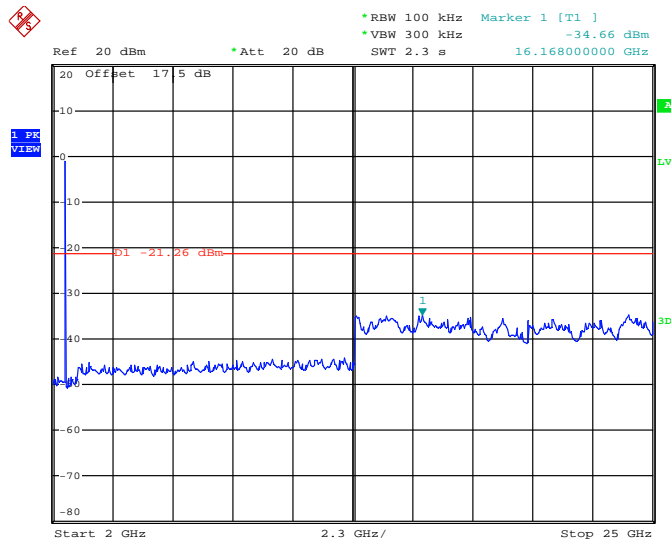

Date: 25.SEP.2013 15:34:11

3.8 Radiated Band Edges and Spurious Emission Measurement

3.8.1 Limit of Radiated Band Edges and Spurious Emission

In any 100 kHz bandwidth outside the intentional radiator frequency band, all harmonics/spurious must be at least 20 dB below the highest emission level within the authorized band. In addition, radiated emissions which fall in the restricted bands must also comply with the FCC section 15.209 limits as below.

Frequency (MHz)	Field Strength (microvolts/meter)	Measurement Distance (meters)
0.009 – 0.490	2400/F(kHz)	300
0.490 – 1.705	24000/F(kHz)	30
1.705 – 30.0	30	30
30 – 88	100	3
88 – 216	150	3
216 - 960	200	3
Above 960	500	3

3.8.2 Measuring Instruments

See list of measuring instruments of this test report.

3.8.3 Test Procedures

1. The testing follows the guidelines in Spurious Radiated Emissions of FCC Public Notice DA 00-705 Measurement Guidelines.
2. The EUT was placed on a turntable with 0.8 meter above ground.
3. The EUT was set 3 meters from the interference receiving antenna, which was mounted on the top of a variable height antenna tower.
4. For each suspected emission, the EUT was arranged to its worst case and then tune the Antenna tower (from 1 m to 4 m) and turntable (from 0 degree to 360 degrees) to find the maximum reading. A pre-amp and a high pass filter are used for the test in order to get better signal level to comply with the guidelines.
5. Set to the maximum power setting and enable the EUT transmit continuously.
6. Use the following spectrum analyzer settings:
 - (1) Span shall wide enough to fully capture the emission being measured;
 - (2) Set RBW=100 kHz for $f < 1$ GHz, RBW=1MHz for $f > 1$ GHz ; VBW \geq RBW; Sweep = auto; Detector function = peak; Trace = max hold for peak
 - (3) For average measurement: use duty cycle correction factor method per 15.35(c).
Duty cycle = On time/100 milliseconds
On time = $N_1 * L_1 + N_2 * L_2 + \dots + N_{n-1} * L_{n-1} + N_n * L_n$
Where N_1 is number of type 1 pulses, L_1 is length of type 1 pulses, etc.
Average Emission Level = Peak Emission Level + $20 * \log(\text{Duty cycle})$
7. Corrected Reading: Antenna Factor + Cable Loss + Read Level - Preamp Factor = Level

Note: The average levels were calculated from the peak level corrected with duty cycle correction factor (24.79dB) derived from $20 \log(\text{dwell time}/100\text{ms})$. This correction is only for signals that hop with the fundamental signal, such as band-edge and harmonic. Other spurious signals that are independent of the hopping signal would not use this correction.

3.8.4 Test Setup

For radiated emissions below 30MHz

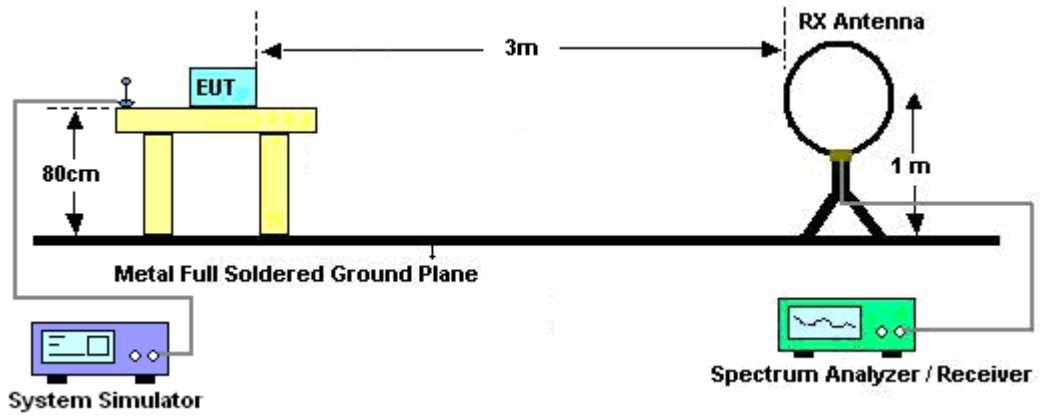

For radiated emissions from 30MHz to 1GHz

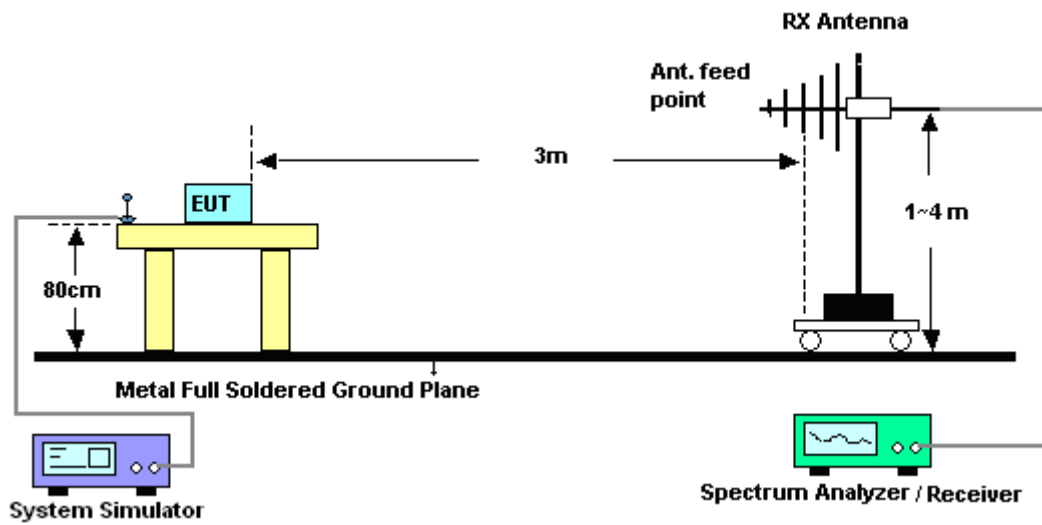

For radiated emissions above 1GHz

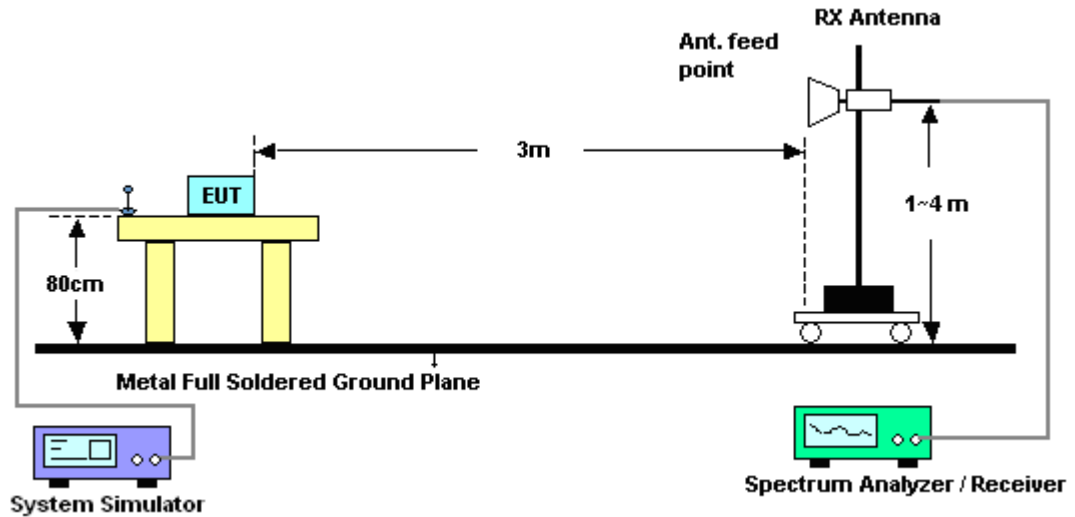

3.8.5 Test Results of Radiated Spurious Emissions (9 kHz ~ 30 MHz)

The low frequency, which started from 9 kHz to 30MHz, was pre-scanned and the result which was 20dB lower than the limit line per 15.31(o) was not reported.

3.8.6 Duty cycle correction factor for average measurement

3DH5 on time (One Pulse) Plot on Channel 39

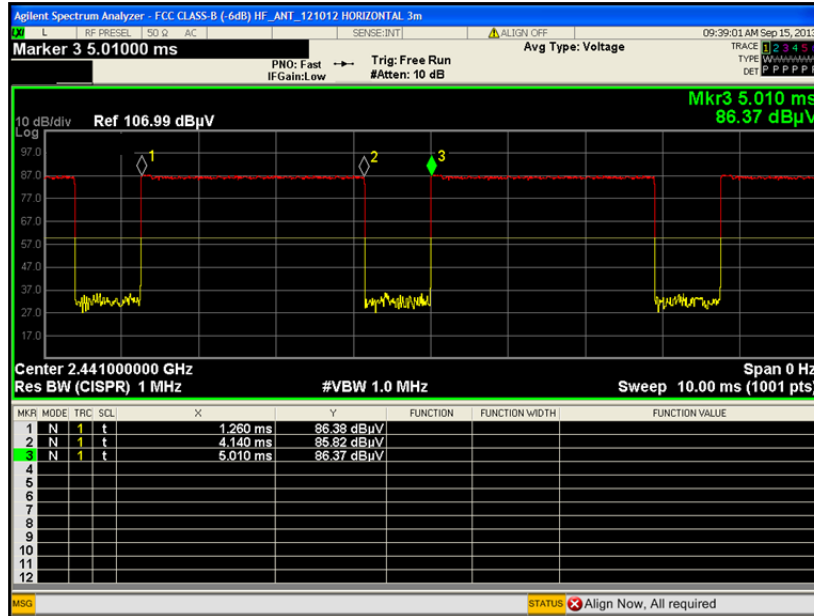

3DH5 on time (Count Pulses) Plot on Channel 39

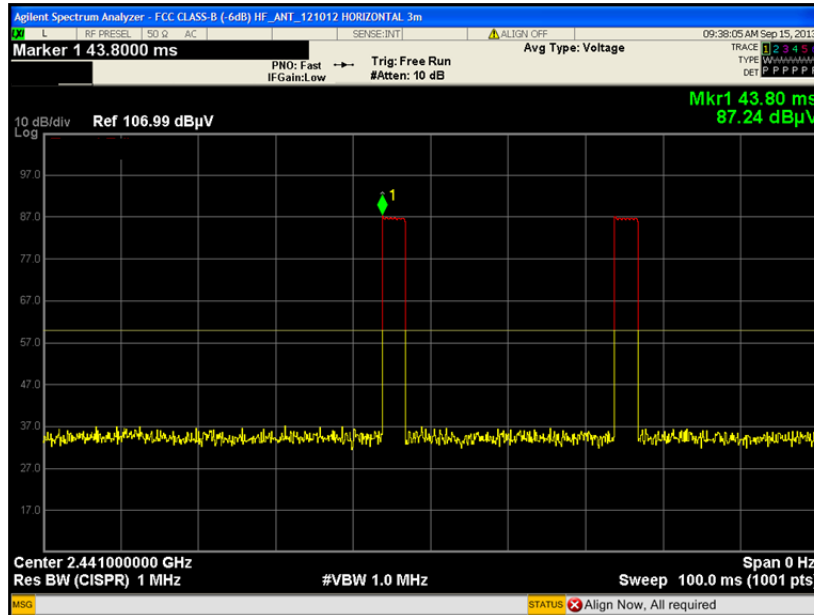

Note:

1. Worst case Duty cycle = on time/100 milliseconds = $2 * 2.88 / 100 = 5.76 \%$
2. Worst case Duty cycle correction factor = $20 * \log(\text{Duty cycle}) = -24.79 \text{ dB}$
3. 3DH5 has the highest duty cycle worst case and is reported.

Duty Cycle Correction Factor Consideration for AFH mode:

Bluetooth normal hopping rate is 1600Hz and reduced to 800Hz in AFH mode; due to the reduced number of hopping frequencies, with the same packet configuration the dwell time in each channel frequency within 100msec period is longer in AFH mode than normal mode.

In AFH mode, the minimum hopping frequencies are 20, to get the longest dwell time DH5 packet is observed; the period to have DH5 packet completing one hopping sequence is

$$2.88 \text{ ms} \times 20 \text{ channels} = 57.6 \text{ ms}$$

There cannot be 2 complete hopping sequences within 100ms period, considering the random hopping behavior, maximum 2 hops can be possibly observed within the period. $[100\text{ms} / 57.6\text{ms}] = 2$ hops

Thus, the maximum possible ON time:

$$2.88 \text{ ms} \times 2 = 5.76 \text{ ms}$$

Worst case Duty Cycle Correction factor, which is derived from the maximum possible ON time,

$$20 \times \log(5.76 \text{ ms}/100\text{ms}) = -24.79 \text{ dB}$$



3.8.7 Test Result of Radiated Spurious at Band Edges

Test Mode :	3Mbps	Temperature :	23~25°C
Test Channel :	00	Relative Humidity :	48~52%
		Test Engineer :	Gavin Zhang

ANTENNA POLARITY : HORIZONTAL										
Frequency (MHz)	Level (dBμV/m)	Over Limit (dB)	Limit Line (dBμV/m)	Read Level (dBμV)	Antenna Factor (dB)	Cable Loss (dB)	Preamp Factor (dB)	Ant Pos (cm)	Table Pos (deg)	Remark
2385.78	47.15	-26.85	74	39.21	32.14	5.59	29.79	100	314	Peak
2385.78	22.36	-31.64	54	-	-	-	-	-	-	Average

ANTENNA POLARITY : VERTICAL										
Frequency (MHz)	Level (dBμV/m)	Over Limit (dB)	Limit Line (dBμV/m)	Read Level (dBμV)	Antenna Factor (dB)	Cable Loss (dB)	Preamp Factor (dB)	Ant Pos (cm)	Table Pos (deg)	Remark
2386.41	46.1	-27.9	74	38.16	32.14	5.59	29.79	100	71	Peak
2386.41	21.31	-32.69	54	-	-	-	-	-	-	Average

Test Mode :	3Mbps	Temperature :	23~25°C
Test Channel :	78	Relative Humidity :	48~52%
		Test Engineer :	Gavin Zhang

ANTENNA POLARITY : HORIZONTAL										
Frequency (MHz)	Level (dBμV/m)	Over Limit (dB)	Limit Line (dBμV/m)	Read Level (dBμV)	Antenna Factor (dB)	Cable Loss (dB)	Preamp Factor (dB)	Ant Pos (cm)	Table Pos (deg)	Remark
2483.6	59.04	-14.96	74	50.82	32.27	5.71	29.76	104	23	Peak
2483.6	34.25	-19.75	54	-	-	-	-	-	-	Average

ANTENNA POLARITY : VERTICAL										
Frequency (MHz)	Level (dBμV/m)	Over Limit (dB)	Limit Line (dBμV/m)	Read Level (dBμV)	Antenna Factor (dB)	Cable Loss (dB)	Preamp Factor (dB)	Ant Pos (cm)	Table Pos (deg)	Remark
2483.9	51.88	-22.12	74	43.66	32.27	5.71	29.76	100	72	Peak
2483.9	27.09	-26.91	54	-	-	-	-	-	-	Average

3.8.8 Test Result of Radiated Spurious Emission (30MHz ~ 10th Harmonic)

Note: Pre-scanned all test modes and only choose the worst case mode recorded in the test report for radiated spurious emission below 1GHz.

Test Mode :	3Mbps	Temperature :	23~25°C
Test Channel :	00	Relative Humidity :	48~52%
Test Engineer :	Gavin Zhang	Polarization :	Horizontal
Remark :	1. 2402 MHz is fundamental signal which can be ignored. 2. 7206 MHz is not within a restricted band, and its limit line is 20dB below the highest emission level. For example, 102.07dBuV/m - 20dB = 82.07dBuV/m.		

Frequency (MHz)	Level (dBμV/m)	Over Limit (dB)	Limit Line (dBμV/m)	Read Level (dBμV)	Antenna Factor (dB)	Cable Loss (dB)	Preamp Factor (dB)	Ant Pos (cm)	Table Pos (deg)	Remark
2402	102.07	-	-	94.09	32.14	5.62	29.78	100	314	Peak
2402	77.28	-	-	-	-	-	-	100	314	Average
4804	38.53	-35.47	74	53.86	33.63	8.33	57.29	151	219	Peak
4804	13.74	-40.26	54	-	-	-	-	151	219	Average
7206	39.97	-42.1	82.07	52.04	35.27	9.95	57.29	156	302	Peak

Note: Other harmonics are lower than background noise.

Test Mode :	3Mbps	Temperature :	23~25°C
Test Channel :	00	Relative Humidity :	48~52%
Test Engineer :	Gavin Zhang	Polarization :	Vertical
Remark :	1. 2402 MHz is fundamental signal which can be ignored. 2. 7206 MHz is not within a restricted band, and its limit line is 20dB below the highest emission level.		

Frequency (MHz)	Level (dBμV/m)	Over Limit (dB)	Limit Line (dBμV/m)	Read Level (dBμV)	Antenna Factor (dB)	Cable Loss (dB)	Preamp Factor (dB)	Ant Pos (cm)	Table Pos (deg)	Remark
2402	96.92	-	-	88.94	32.14	5.62	29.78	100	71	Peak
2402	72.13	-	-	-	-	-	-	100	71	Average
4804	37.08	-36.92	74	52.41	33.63	8.33	57.29	151	219	Peak
4804	12.29	-41.71	54	-	-	-	-	151	219	Average
7206	38.94	-37.98	76.92	51.01	35.27	9.95	57.29	156	302	Peak

Note: Other harmonics are lower than background noise.



Test Mode :	3Mbps	Temperature :	23~25°C
Test Channel :	39	Relative Humidity :	48~52%
Test Engineer :	Gavin Zhang	Polarization :	Horizontal
Remark :	2441 MHz is fundamental signal which can be ignored.		

Frequency (MHz)	Level (dBμV/m)	Over Limit (dB)	Limit Line (dBμV/m)	Read Level (dBμV)	Antenna Factor (dB)	Cable Loss (dB)	Preamp Factor (dB)	Ant Pos (cm)	Table Pos (deg)	Remark
2441	105.89	-	-	97.75	32.22	5.68	29.76	106	26	Peak
2441	81.1	-	-	-	-	-	-	106	26	Average
4882	38.57	-35.43	74	53.53	33.8	8.41	57.17	115	258	Peak
4882	13.78	-40.22	54	-	-	-	-	115	258	Average
7323	40.75	-33.25	74	52.57	35.32	10	57.14	152	309	Peak
7323	15.96	-38.04	54	-	-	-	-	152	309	Average

Note: Other harmonics are lower than background noise.

Test Mode :	3Mbps	Temperature :	23~25°C
Test Channel :	39	Relative Humidity :	48~52%
Test Engineer :	Gavin Zhang	Polarization :	Vertical
Remark :	2441 MHz is fundamental signal which can be ignored.		

Frequency (MHz)	Level (dBμV/m)	Over Limit (dB)	Limit Line (dBμV/m)	Read Level (dBμV)	Antenna Factor (dB)	Cable Loss (dB)	Preamp Factor (dB)	Ant Pos (cm)	Table Pos (deg)	Remark
2441	100.13	-	-	91.99	32.22	5.68	29.76	155	72	Peak
2441	75.34	-	-	-	-	-	-	155	72	Average
4882	38.25	-35.75	74	53.21	33.8	8.41	57.17	115	258	Peak
4882	13.46	-40.54	54	-	-	-	-	115	258	Average
7323	38.85	-35.15	74	50.67	35.32	10	57.14	152	309	Peak
7323	14.06	-39.94	54	-	-	-	-	152	309	Average

Note: Other harmonics are lower than background noise.



Test Mode :	3Mbps	Temperature :	23~25°C
Test Channel :	78	Relative Humidity :	48~52%
Test Engineer :	Gavin Zhang	Polarization :	Horizontal
Remark :	2480 MHz is fundamental signal which can be ignored.		

Frequency (MHz)	Level (dBμV/m)	Over Limit (dB)	Limit Line (dBμV/m)	Read Level (dBμV)	Antenna Factor (dB)	Cable Loss (dB)	Preamp Factor (dB)	Ant Pos (cm)	Table Pos (deg)	Remark
117.3	17.03	-26.47	43.5	34.17	12.13	1.34	30.61	-	-	Peak
265.71	17.56	-28.44	46	32.74	13.03	1.9	30.11	-	-	Peak
411.21	20.62	-25.38	46	31.06	16.86	2.33	29.63	-	-	Peak
609.09	23.32	-22.68	46	30.53	19.2	2.78	29.19	-	-	Peak
744.89	25.32	-20.68	46	30.6	20.68	3.05	29.01	-	-	Peak
848.1	26.47	-19.53	46	30.8	21.3	3.24	28.87	178	245	Peak
2480	106.5	-	-	98.28	32.27	5.71	29.76	104	23	Peak
2480	81.71	-	-	-	-	-	-	104	23	Average
4960	38.8	-35.2	74	53.32	34.01	8.49	57.02	118	289	Peak
4960	14.01	-39.99	54	-	-	-	-	118	289	Average
7440	40.82	-33.18	74	52.4	35.37	10.04	56.99	158	273	Peak
7440	16.03	-37.97	54	-	-	-	-	158	273	Average

Note: Other harmonics are lower than background noise.



Test Mode :	3Mbps	Temperature :	23~25°C
Test Channel :	78	Relative Humidity :	48~52%
Test Engineer :	Gavin Zhang	Polarization :	Vertical
Remark :	2480 MHz is fundamental signal which can be ignored.		

Frequency (MHz)	Level (dBμV/m)	Over Limit (dB)	Limit Line (dBμV/m)	Read Level (dBμV)	Antenna Factor (dB)	Cable Loss (dB)	Preamp Factor (dB)	Ant Pos (cm)	Table Pos (deg)	Remark
133.79	19.12	-24.38	43.5	36.16	12.1	1.41	30.55	-	-	Peak
445.16	22.59	-23.41	46	32.81	16.9	2.4	29.52	-	-	Peak
581.93	24.54	-21.46	46	32.42	18.62	2.72	29.22	-	-	Peak
716.76	25.39	-20.61	46	31.5	19.94	2.99	29.04	-	-	Peak
822.49	25.99	-20.01	46	30.35	21.32	3.22	28.9	-	-	Peak
908.82	26.27	-19.73	46	30.17	21.54	3.35	28.79	145	356	Peak
2480	99.37	-	-	91.15	32.27	5.71	29.76	100	72	Peak
2480	74.58	-	-	-	-	-	-	100	72	Average
4960	37.5	-36.5	74	52.02	34.01	8.49	57.02	118	289	Peak
4960	12.71	-41.29	54	-	-	-	-	118	289	Average
7440	39.89	-34.11	74	51.47	35.37	10.04	56.99	158	273	Peak
7440	15.1	-38.9	54	-	-	-	-	158	273	Average

Note: Other harmonics are lower than background noise.

3.9 AC Conducted Emission Measurement

3.9.1 Limit of AC Conducted Emission

For equipment that is designed to be connected to the public utility (AC) power line, the radio frequency voltage that is conducted back onto the AC power line on any frequency or frequencies within the band 150 kHz to 30 MHz shall not exceed the limits in the following table.

Frequency of emission (MHz)	Conducted limit (dB μ V)	
	Quasi-peak	Average
0.15-0.5	66 to 56*	56 to 46*
0.5-5	56	46
5-30	60	50

*Decreases with the logarithm of the frequency.

3.9.2 Measuring Instruments

See list of measuring instruments of this test report.

3.9.3 Test Procedures

1. The EUT was placed 0.4 meter from the conducting wall of the shielding room was kept at least 80 centimeters from any other grounded conducting surface.
2. Connect EUT to the power mains through a line impedance stabilization network (LISN).
3. All the support units are connecting to the other LISN.
4. The LISN provides 50 ohm coupling impedance for the measuring instrument.
5. The FCC states that a 50 ohm, 50 microhenry LISN should be used.
6. Both sides of AC line were checked for maximum conducted interference.
7. The frequency range from 150 kHz to 30 MHz was searched.
8. Set the test-receiver system to Peak Detect Function and specified bandwidth with Maximum Hold Mode.

3.9.4 Test Setup

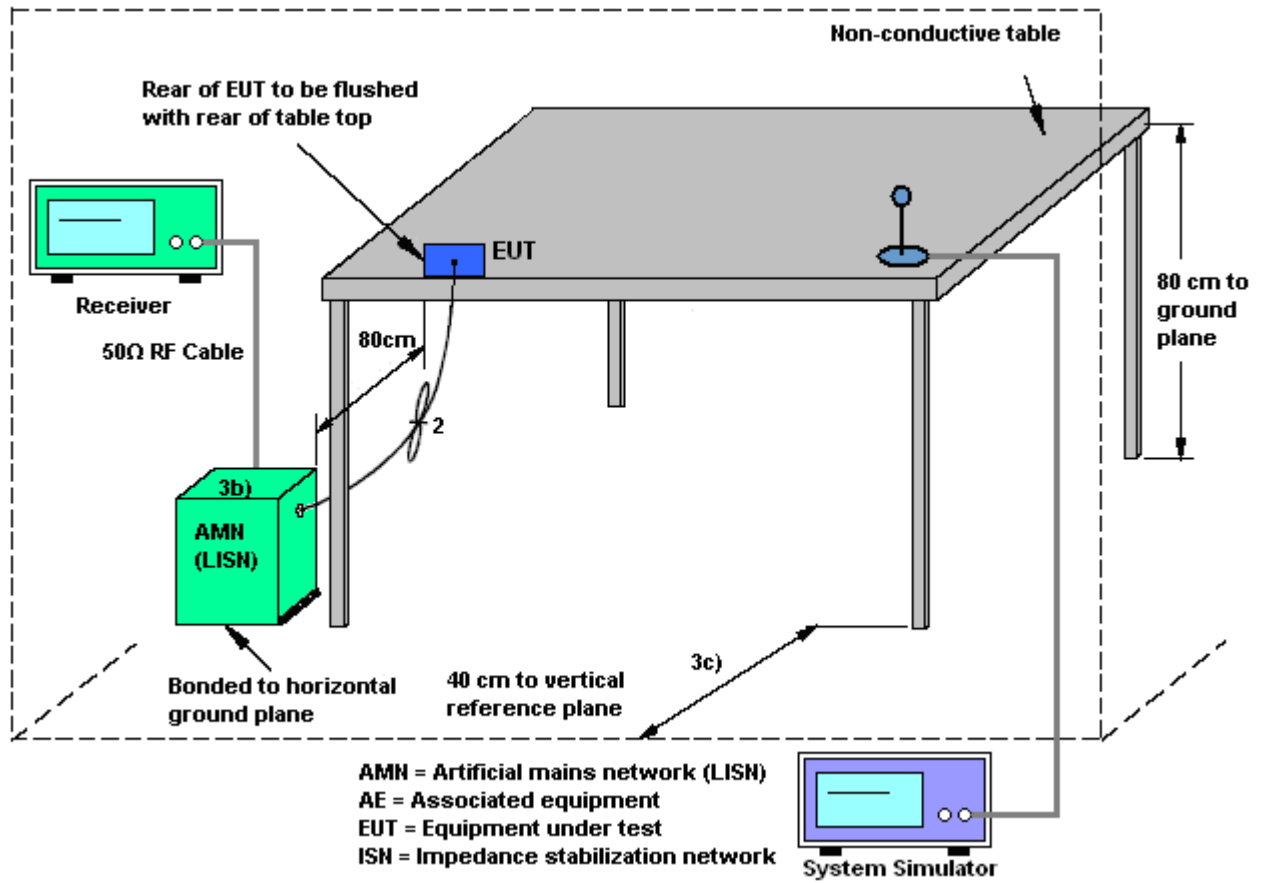



3.9.5 Test Result of AC Conducted Emission

Test Mode :	Mode 1	Temperature :	23~24°C
Test Engineer :	Henry Chen	Relative Humidity :	49~50%
Test Voltage :	120Vac / 60Hz	Phase :	Line
Function Type :	GSM850 Idle + Bluetooth Link + WLAN Link + Earphone + USB Cable (Charging from Adapter)		

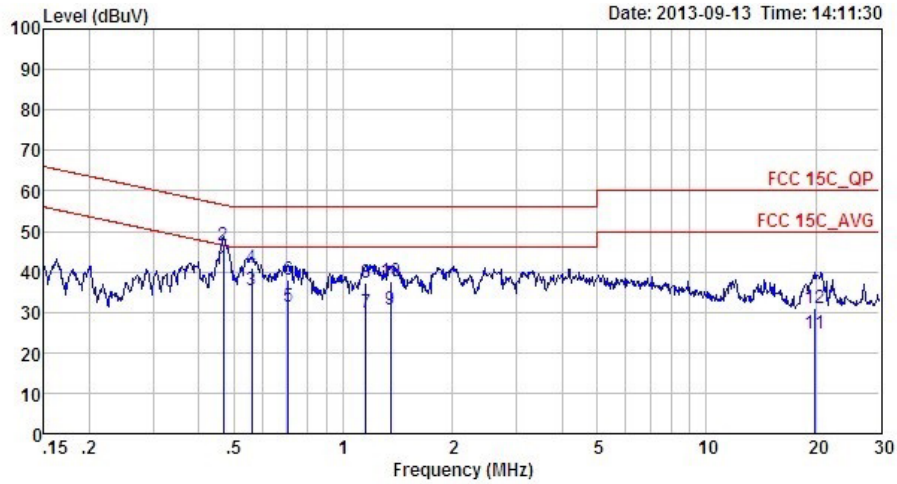

Site : CO01-SZ
 Condition: FCC 15C_QP LISN_L_20130328 LINE

	Freq	Level	Over Limit	Limit Line	Read Level	LISN Factor	Cable Loss	Remark
	MHz	dBuV	dB	dBuV	dBuV	dB	dB	
1 *	0.47	40.90	-5.64	46.54	30.60	0.14	10.16	Average
2	0.47	46.50	-10.04	56.54	36.20	0.14	10.16	QP
3	0.56	35.30	-10.70	46.00	25.00	0.15	10.15	Average
4	0.56	41.00	-15.00	56.00	30.70	0.15	10.15	QP
5	0.70	31.41	-14.59	46.00	21.10	0.16	10.15	Average
6	0.70	38.11	-17.89	56.00	27.80	0.16	10.15	QP
7	1.15	30.06	-15.94	46.00	19.69	0.21	10.16	Average
8	1.15	37.36	-18.64	56.00	26.99	0.21	10.16	QP
9	1.35	30.58	-15.42	46.00	20.20	0.21	10.17	Average
10	1.35	37.58	-18.42	56.00	27.20	0.21	10.17	QP
11	19.84	24.64	-25.36	50.00	12.70	1.29	10.65	Average
12	19.84	31.04	-28.96	60.00	19.10	1.29	10.65	QP



Test Mode :	Mode 1	Temperature :	23~24°C
Test Engineer :	Henry Chen	Relative Humidity :	49~50%
Test Voltage :	120Vac / 60Hz	Phase :	Neutral
Function Type :	GSM850 Idle + Bluetooth Link + WLAN Link + Earphone + USB Cable (Charging from Adapter)		

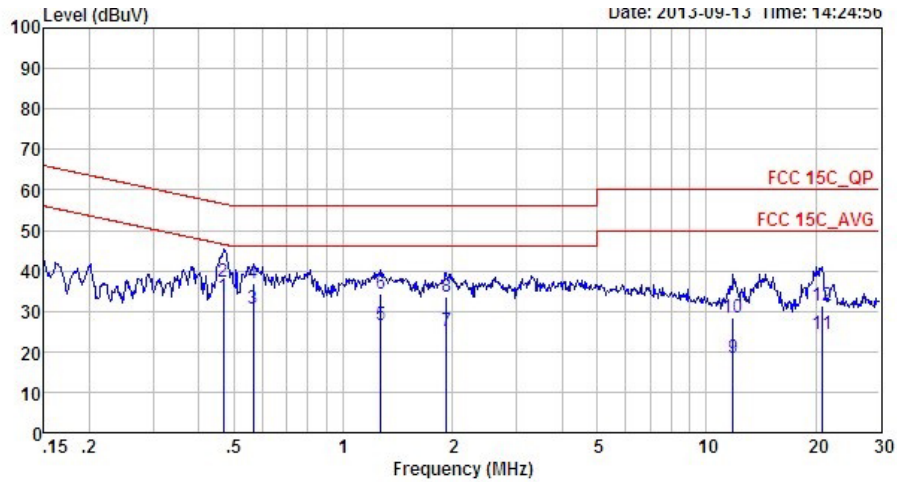

Site : CO01-SZ
 Condition: FCC 15C_QP LISN_N_20130328 NEUTRAL

	Freq	Level	Over	Limit	Read	LISN	Cable	
	MHz	dBuV	Limit	Line	Level	Factor	Loss	Remark
			dB	dBuV	dBuV	dB	dB	
1 *	0.47	33.60	-12.94	46.54	23.40	0.04	10.16	Average
2	0.47	37.20	-19.34	56.54	27.00	0.04	10.16	QP
3	0.56	30.79	-15.21	46.00	20.60	0.04	10.15	Average
4	0.56	36.89	-19.11	56.00	26.70	0.04	10.15	QP
5	1.27	26.51	-19.49	46.00	16.30	0.05	10.16	Average
6	1.27	34.21	-21.79	56.00	24.00	0.05	10.16	QP
7	1.93	25.24	-20.76	46.00	15.00	0.06	10.18	Average
8	1.93	33.74	-22.26	56.00	23.50	0.06	10.18	QP
9	11.87	18.49	-31.51	50.00	7.70	0.43	10.36	Average
10	11.87	28.39	-31.61	60.00	17.60	0.43	10.36	QP
11	20.92	24.51	-25.49	50.00	13.00	0.90	10.61	Average
12	20.92	31.31	-28.69	60.00	19.80	0.90	10.61	QP



3.10 Antenna Requirements

3.10.1 Standard Applicable

If directional gain of transmitting antennas is greater than 6dBi, the power shall be reduced by the same level in dB comparing to gain minus 6dBi. The use of a permanently attached antenna or of an antenna that uses a unique coupling to the intentional radiator shall be considered sufficient to comply with the FCC rule.

3.10.2 Antenna Anti-Replacement Construction

An embedded-in antenna design is used.

3.10.3 Antenna Gain

The antenna peak gain of EUT is less than 6 dBi. Therefore, it is not necessary to reduce maximum peak output power limit.

4 List of Measuring Equipment

Instrument	Manufacturer	Model No.	Serial No.	Characteristics	Calibration Date	Test Date	Due Date	Remark
Spectrum Analyzer	R&S	FSP30	101400	9kHz~30GHz	Mar. 28, 2013	Sep. 12, 2013~ Sep. 25, 2013	Mar. 27, 2014	Conducted (TH01-SZ)
Power Meter	Anritsu	ML2495A	1218010	N/A	Mar. 28, 2013	Sep. 12, 2013~ Sep. 25, 2013	Mar. 27, 2014	Conducted (TH01-SZ)
Power Sensor	Anritsu	MA2411B	1207253	N/A	Mar. 28, 2013	Sep. 12, 2013~ Sep. 25, 2013	Mar. 27, 2014	Conducted (TH01-SZ)
Spectrum Analyzer	Agilent Technologies	N9038A	MY522601 85	20Hz~26.5GHz	Apr. 04, 2013	Sep. 15, 2013	Apr. 03, 2014	Radiation (03CH01-SZ)
Double Ridge Horn Antenna	ETS Lindgren	3117	00119436	1GHz~18GHz	Oct. 12, 2012	Sep. 15, 2013	Oct. 11, 2013	Radiation (03CH01-SZ)
Bilog Antenna	SCHAFFNER	CBL6112B	2614	30MHz ~2GHz	Nov. 03, 2012	Sep. 15, 2013	Nov. 02, 2013	Radiation (03CH01-SZ)
Amplifier	ADVANTEST	BB525C	E9007003	9kHz-3000MHz GAIN 30db	Mar. 28, 2013	Sep. 15, 2013	Mar. 27, 2014	Radiation (03CH01-SZ)
Amplifier	Yiai	AV3860B	04030	2GHz~26.5GHz	Mar. 28, 2013	Sep. 15, 2013	Mar. 27, 2014	Radiation (03CH01-SZ)
SHF-EHF-Horn	Schwarzbeck	BBHA9170	BBHA9170 249	14GHz~40GHz	Nov. 23, 2012	Sep. 15, 2013	Nov. 22, 2013	Radiation (03CH01-SZ)
Loop Antenna	R&S	HFH2-Z2	100321	9kHz-30MHz	Oct. 22, 2012	Sep. 15, 2013	Oct. 21, 2013	Radiation (03CH01-SZ)
Turn Table	EM Electronic	EM 1000	N/A	0 ~ 360 degree	N/A	Sep. 15, 2013	N/A	Radiation (03CH01-SZ)
Antenna Mast	EM Electronic	EM 1000	N/A	1 m - 4 m	N/A	Sep. 15, 2013	N/A	Radiation (03CH01-SZ)
ESCIO TEST Receiver	R&S	1142.8007.03	100724	9kHz-3GHz	Mar. 08, 2013	Sep. 13, 2013	Mar. 07, 2014	Conduction (CO01-SZ)
AC LISN	ETS-LINDGRE N	3816/2SH	00103912	0.1MHz~108MH z	Feb. 28, 2013	Sep. 13, 2013	Feb. 27, 2014	Conduction (CO01-SZ)
AC LISN (for auxiliary equipment)	ETS-LINDGRE N	3816/2SH	00103892	0.1MHz~108MH z	Feb. 28, 2013	Sep. 13, 2013	Feb. 27, 2014	Conduction (CO01-SZ)
AC Power Source	Chroma	61602	616020000 891N/A	N/A	Oct. 12, 2012	Sep. 13, 2013	Oct. 11, 2013	Conduction (CO01-SZ)



5 Uncertainty of Evaluation

Uncertainty of Conducted Emission Measurement (150 kHz ~ 30 MHz)

Measuring Uncertainty for a Level of Confidence of 95% ($U = 2Uc(y)$)	2.26
---	------

Uncertainty of Radiated Emission Measurement (30 MHz ~ 1000 MHz)

Measuring Uncertainty for a Level of Confidence of 95% ($U = 2Uc(y)$)	2.54
---	------

Uncertainty of Radiated Emission Measurement (1 GHz ~ 40 GHz)

Measuring Uncertainty for a Level of Confidence of 95% ($U = 2Uc(y)$)	4.72
---	------