



FCC RF Test Report

APPLICANT : Lenovo Mobile Communication Technology Ltd.
EQUIPMENT : Lenovo Mobile Phone
BRAND NAME : lenovo
MODEL NAME : Lenovo S856
MID : 85600011
FCC ID : YCNS856
STANDARD : 47 CFR Part 2, 24(E), 27(L), 27(M), 27(H)
CLASSIFICATION : PCS Licensed Transmitter Held to Ear (PCE)

The product was received on Sep. 17, 2014 and testing was completed on Oct. 10, 2014. We, SPORTON INTERNATIONAL (KUNSHAN) INC., would like to declare that the tested sample has been evaluated in accordance with the test procedures given in ANSI / TIA / EIA-603-C-2004 and the testing has shown the tested sample to be in compliance with the applicable technical standards.

The test results in this report apply exclusively to the tested model / sample. Without written approval of SPORTON INTERNATIONAL (KUNSHAN) INC., the test report shall not be reproduced except in full.

Reviewed by: Joseph Lin / Supervisor

Approved by: Jones Tsai / Manager



SPORTON INTERNATIONAL (KUNSHAN) INC.
No. 3-2, PingXiang Road, Kunshan, Jiangsu Province, P. R. C.



TABLE OF CONTENTS

REVISION HISTORY..... 3

SUMMARY OF TEST RESULT 4

1 GENERAL DESCRIPTION 6

 1.1 Applicant 6

 1.2 Manufacturer 6

 1.3 Product Feature of Equipment Under Test..... 6

 1.4 Product Specification subjective to this standard 7

 1.5 Modification of EUT 7

 1.6 Maximum ERP/EIRP Power, Frequency Tolerance, and Emission Designator 8

 1.7 Testing Location 10

 1.8 Applicable Standards..... 10

2 TEST CONFIGURATION OF EQUIPMENT UNDER TEST 11

 2.1 Test Mode 11

 2.2 Connection Diagram of Test System..... 13

 2.3 Support Unit used in test configuration and system 14

 2.4 Measurement Results Explanation Example..... 14

3 TEST RESULT..... 15

 3.1 Conducted Output Power Measurement 15

 3.2 Peak-to-Average Ratio 25

 3.3 Effective Radiated Power and Equivalent Isotropic Radiated Power Measurement..... 51

 3.4 99% Occupied Bandwidth and 26dB Bandwidth Measurement..... 57

 3.5 Conducted Band Edge Measurement 96

 3.6 Conducted Spurious Emission Measurement 171

 3.7 Radiated Spurious Emission Measurement 227

 3.8 Frequency Stability Measurement..... 248

4 LIST OF MEASURING EQUIPMENT 252

5 UNCERTAINTY OF EVALUATION 254

APPENDIX A. SETUP PHOTOGRAPHS



SUMMARY OF TEST RESULT

Report Section	FCC Rule	Description	Limit	Result	Remark
3.1	§2.1046	Conducted Output Power	Reporting Only	PASS	-
3.2	§24.232(d)	Peak-to-Average Ratio	<13 dB	PASS	-
3.3	§27.50(c)(10)	Effective Radiated Power (Band 17)	ERP < 3 Watt	PASS	-
	§24.232(c) §27.50(h)(2)	Equivalent Isotropic Radiated Power (Band 2) (Band 7)	EIRP < 2Watt		
	§27.50(d)(4)	Equivalent Isotropic Radiated Power (Band 4)	EIRP < 1Watt		
3.4	§2.1049 §24.238(b) §27.53(h)(3) §27.53(m)(6)	Occupied Bandwidth & 26dB Bandwidth	Reporting Only	PASS	-
3.5	§2.1051 §24.238(a) §27.53(g) §27.53(h)	Conducted Band Edge Measurement (Band 2) (Band 4) (Band 17)	< 43+10log ₁₀ (P[Watt])	PASS	-
	§2.1051 §27.53(m)(4)	Conducted Band Edge Measurement (Band 7)	< 5MHz: -10 dBm 5 MHz~6MHz or 26dB(BW): -13 dBm ≥6MHz or 26dB(BW): -25 dBm		



Report Section	FCC Rule	Description	Limit	Result	Remark
3.6	§2.1051 §24.238(a) §27.53(g) §27.53(h)	Conducted Spurious Emission (Band 2) (Band 4) (Band 17)	$< 43+10\log_{10}(P[\text{Watts}])$	PASS	-
	§2.1051 §27.53(m)(4)	Conducted Spurious Emission (Band 7)	$< 55+10\log_{10}(P[\text{Watts}])$	PASS	
3.7	§2.1053 §24.238(a) §27.53(g) §27.53(h)	Radiated Spurious Emission (Band 2) (Band 4) (Band 17)	$< 43+10\log_{10}(P[\text{Watts}])$	PASS	Under limit 13.83 dB at 5645.000 MHz
	§2.1053 §27.53(m)(4)	Radiated Spurious Emission (Band 7)	$< 55+10\log_{10}(P[\text{Watts}])$	PASS	
3.8	§2.1055 §24.235 §27.54	Frequency Stability Temperature & Voltage	within authorized band	PASS	



1 General Description

1.1 Applicant

Lenovo Mobile Communication Technology Ltd.

No.999, Qishan North 2nd Road, Information & Optoelectronics Park, Torch Hi-tech Industry Development Zone, Xiamen, P.R.China

1.2 Manufacturer

Lenovo PC HK Limited

23/F, Lincoln House, Taikoo Place 979 King's Road, Quarry Bay, Hong Kong

1.3 Product Feature of Equipment Under Test

Product Feature	
Equipment	Lenovo Mobile Phone
Brand Name	lenovo
Model Name	Lenovo S856
MID	85600011
FCC ID	YCNS856
EUT supports Radios application	GSM/GPRS/EGPRS/WCDMA/HSPA/HSPA+/ DC-HSDPA/LTE/WLAN 2.4GHz 802.11b/g/n HT20/HT40 Bluetooth v3.0 + EDR/Bluetooth v4.0 LE
HW Version	H301
SW Version	S856_AMX_ROW_S017_141013
EUT Stage	Identical Prototype

Remark: The above EUT's information was declared by manufacturer. Please refer to the specifications or user's manual for more detailed description.



1.4 Product Specification subjective to this standard

Product Specification subjective to this standard	
Tx Frequency	LTE Band 2 : 1850.7 MHz ~ 1909.3 MHz LTE Band 4 : 1710.7 MHz ~ 1754.3 MHz LTE Band 7 : 2502.5 MHz ~ 2567.5 MHz LTE Band 17 : 706.5 MHz ~ 713.5 MHz
Rx Frequency	LTE Band 2 : 1930.7 MHz ~ 1989.3 MHz LTE Band 4 : 2110.7 MHz ~ 2154.3 MHz LTE Band 7 : 2622.5MHz ~ 2687.5 MHz LTE Band 17 : 736.5 MHz ~ 743.5 MHz
Bandwidth	LTE Band 2 : 1.4MHz / 3MHz / 5MHz / 10MHz / 15MHz / 20MHz LTE Band 4 : 1.4MHz / 3MHz / 5MHz / 10MHz / 15MHz / 20MHz LTE Band 7 : 5MHz/ 10MHz / 15MHz / 20MHz LTE Band 17 : 5MHz / 10MHz
Maximum Output Power to Antenna	LTE Band 2 : 22.75 dBm LTE Band 4 : 23.05 dBm LTE Band 7 : 21.37 dBm LTE Band 17 : 23.47 dBm
Antenna Type	IFA Antenna
Type of Modulation	QPSK / 16QAM

1.5 Modification of EUT

No modifications are made to the EUT during all test items.



1.6 Maximum ERP/EIRP Power, Frequency Tolerance, and Emission Designator

FCC Rule	System	Type of Modulation	BW	Emission Designator	Frequency Tolerance (ppm)	Maximum ERP/EIRP
Part 24E	LTE Band 2	QPSK	1.4 MHz	1M10G7D	-	0.2553 W
Part 24E	LTE Band 2	16QAM	1.4 MHz	1M10W7D	-	0.2009 W
Part 24E	LTE Band 2	QPSK	3 MHz	2M72G7D	-	-
Part 24E	LTE Band 2	16QAM	3 MHz	2M73W7D	-	-
Part 24E	LTE Band 2	QPSK	5 MHz	4M49G7D	-	-
Part 24E	LTE Band 2	16QAM	5 MHz	4M50W7D	-	-
Part 24E	LTE Band 2	QPSK	10 MHz	9M03G7D	0.0128 ppm	-
Part 24E	LTE Band 2	16QAM	10 MHz	9M01W7D	-	-
Part 24E	LTE Band 2	QPSK	15 MHz	13M5G7D	-	-
Part 24E	LTE Band 2	16QAM	15 MHz	13M4W7D	-	-
Part 24E	LTE Band 2	QPSK	20 MHz	18M3G7D	-	0.2355 W
Part 24E	LTE Band 2	16QAM	20 MHz	18M4W7D	-	0.1897 W
Part 27L	LTE Band 4	QPSK	1.4 MHz	1M10G7D	-	0.2014 W
Part 27L	LTE Band 4	16QAM	1.4 MHz	1M10W7D	-	0.1574 W
Part 27L	LTE Band 4	QPSK	3 MHz	2M73G7D	-	-
Part 27L	LTE Band 4	16QAM	3 MHz	2M73W7D	-	-
Part 27L	LTE Band 4	QPSK	5MHz	4M50G7D	-	-
Part 27L	LTE Band 4	16QAM	5MHz	4M50W7D	-	-
Part 27L	LTE Band 4	QPSK	10MHz	9M07G7D	0.0111 ppm	-
Part 27L	LTE Band 4	16QAM	10MHz	8M99W7D	-	-
Part 27L	LTE Band 4	QPSK	15MHz	13M5G7D	-	-
Part 27L	LTE Band 4	16QAM	15MHz	13M5W7D	-	-
Part 27L	LTE Band 4	QPSK	20MHz	18M4G7D	-	0.1932 W
Part 27L	LTE Band 4	16QAM	20MHz	18M3W7D	-	0.1560 W



FCC Rule	System	Type of Modulation	BW	Emission Designator	Frequency Tolerance	Maximum ERP/EIRP
Part 27M	LTE Band 7	QPSK	5MHz	4M49G7D	-	0.4519 W
Part 27M	LTE Band 7	16QAM	5MHz	4M50W7D	-	0.3508 W
Part 27M	LTE Band 7	QPSK	10MHz	9M09G7D	0.0085 ppm	-
Part 27M	LTE Band 7	16QAM	10MHz	8M99W7D	-	-
Part 27M	LTE Band 7	QPSK	15MHz	13M5G7D	-	-
Part 27M	LTE Band 7	16QAM	15MHz	13M4W7D	-	-
Part 27M	LTE Band 7	QPSK	20MHz	18M3G7D	-	0.4375 W
Part 27M	LTE Band 7	16QAM	20MHz	18M3W7D	-	0.3412 W
Part 27H	LTE Band 17	QPSK	5MHz	4M49G7D	-	0.0560 W
Part 27H	LTE Band 17	16QAM	5MHz	4M49W7D	-	0.0470 W
Part 27H	LTE Band 17	QPSK	10MHz	9M03G7D	0.0286 ppm	0.0556 W
Part 27H	LTE Band 17	16QAM	10MHz	9M03W7D	-	0.0462 W



1.7 Testing Location

Test Site	SPORTON INTERNATIONAL (KUNSHAN) INC.			
Test Site Location	No. 3-2, PingXiang Road, Kunshan, Jiangsu Province, P.R.C. TEL: +86-0512-5790-0158 FAX: +86-0512-5790-0958			
Test Site No.	Sporton Site No.			FCC Registration No.
	TH01-KS	03CH01-KS	OTA01-KS	149928

1.8 Applicable Standards

According to the specifications of the manufacturer, the EUT must comply with the requirements of the following standards:

- ♦ 47 CFR Part 2, 24(E), 27(L), 27(M), 27(H)
- ♦ ANSI / TIA / EIA-603-C-2004
- ♦ FCC KDB 971168 D01 Power Meas. License Digital Systems v02r01

Remark:

1. All test items were verified and recorded according to the standards and without any deviation during the test.
2. This EUT has also been tested and complied with the requirements of FCC Part 15, Subpart B, recorded in a separate test report.



2 Test Configuration of Equipment Under Test

2.1 Test Mode

Antenna port conducted and radiated test items listed below are performed according to KDB 971168 D01 Power Meas. License Digital Systems v02r01 with maximum output power.

Radiated measurements are performed by rotating the EUT in three different orthogonal test planes to find the maximum emission.

Test Items	Band	Bandwidth (MHz)						Modulation		RB #			Test Channel		
		1.4	3	5	10	15	20	QPSK	16QAM	1	Half	Full	L	M	H
Max. Output Power	2	v	v	v	v	v	v	v	v	v	v	v	v	v	v
	4	v	v	v	v	v	v	v	v	v	v	v	v	v	v
	7	-	-	v	v	v	v	v	v	v	v	v	v	v	v
	17	-	-	v	v	-	-	v	v	v	v	v	v	v	v
Peak-to-Average Ratio	2						v	v	v	v		v	v	v	v
	4						v	v	v	v		v	v	v	v
	7	-	-				v	v	v	v		v	v	v	v
	17	-	-		v	-	-	v	v	v		v	v	v	v
26dB and 99% Bandwidth	2	v	v	v	v	v	v	v	v			v		v	
	4	v	v	v	v	v	v	v	v			v		v	
	7	-	-	v	v	v	v	v	v			v		v	
	17	-	-	v	v	-	-	v	v			v		v	
Conducted Band Edge	2	v	v	v	v	v	v	v	v	v		v	v		v
	4	v	v	v	v	v	v	v	v	v		v	v		v
	7	-	-	v	v	v	v	v	v	v		v	v		v
	17	-	-	v	v	-	-	v	v	v		v	v		v



Test Items	Band	Bandwidth (MHz)						Modulation		RB #			Test Channel		
		1.4	3	5	10	15	20	QPSK	16QAM	1	Half	Full	L	M	H
Conducted Spurious Emission	2	v	v	v	v	v	v	v	v	v			v	v	v
	4	v	v	v	v	v	v	v	v	v			v	v	v
	7	-	-	v	v	v	v	v	v	v			v	v	v
	17	-	-	v	v	-	-	v	v	v			v	v	v
Frequency Stability	2				v			v				v		v	
	4				v			v				v		v	
	7	-	-		v			v				v		v	
	17	-	-		v	-	-	v				v		v	
E.R.P/ E.I.R.P.	2	v					v	v	v	v			v	v	v
	4	v					v	v	v	v			v	v	v
	7	-	-	v			v	v	v	v			v	v	v
	17	-	-	v	v	-	-	v	v	v			v	v	v
Radiated Spurious Emission	2	v	v	v	v	v	v	v		v				v	
	4	v	v	v	v	v	v	v		v				v	
	7	-	-	v	v	v	v	v		v				v	
	17	-	-	v	v	-	-	v		v				v	
Note	<ol style="list-style-type: none"> The mark "v" means that this configuration is chosen for testing The mark "-" means that this bandwidth is not supported. For E.R.P/E.I.R.P. measurement, the widest bandwidth of each band is chosen for testing due to highest conducted power. Besides, the lowest bandwidth of each band is also measured for reporting only. The device is investigated from 30MHz to 10 times of fundamental signal for radiated spurious emission test under different RB size/offset and modulations in exploratory test. Subsequently, only the worst case emissions are reported. 														

2.2 Connection Diagram of Test System

For 27(L)

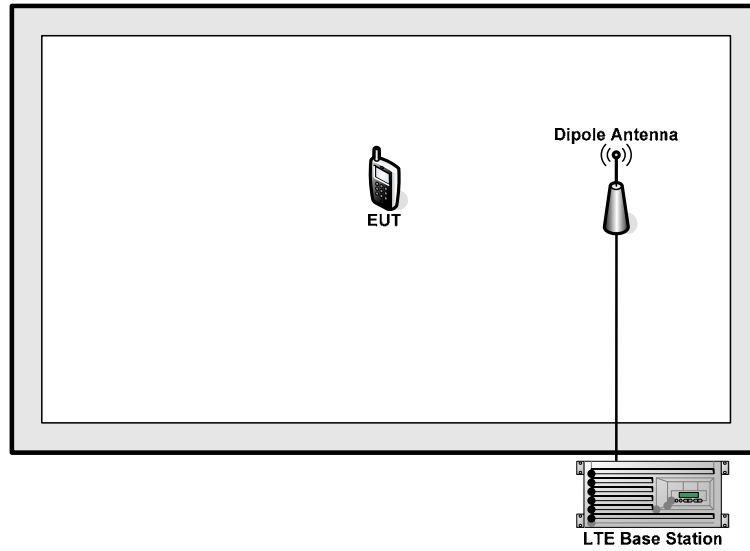

For 24(E)/27(M)/27(H)

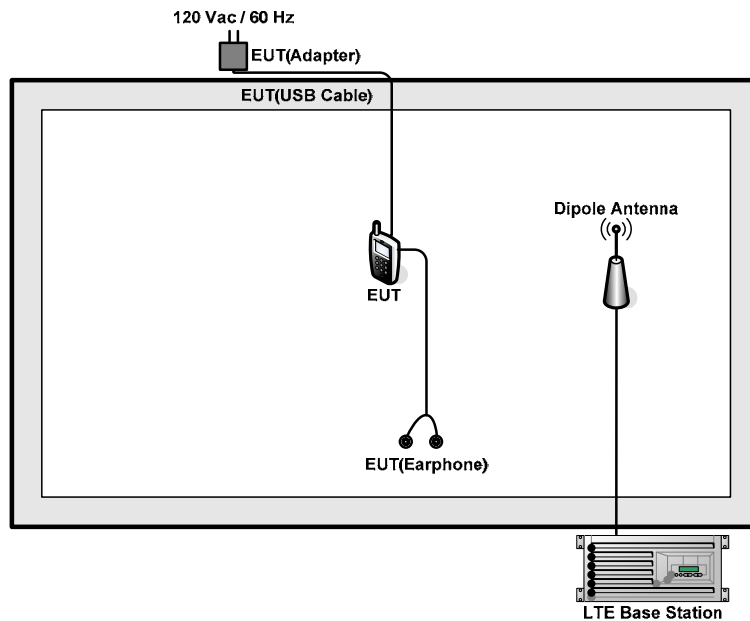



2.3 Support Unit used in test configuration and system

Item	Equipment	Trade Name	Model No.	FCC ID	Data Cable	Power Cord
1.	LTE Base Station	Anritsu	MT8820C	N/A	N/A	Unshielded, 1.8 m
2.	DC Power Supply	GWINSTEK	GPS-3030D	N/A	N/A	Unshielded, 1.8 m

2.4 Measurement Results Explanation Example

For all conducted test items:

The offset level is set in the spectrum analyzer to compensate the RF cable loss between EUT conducted output port and spectrum analyzer. With the offset compensation, the spectrum analyzer reading level is exactly the EUT RF output level.

The spectrum analyzer offset is derived from RF cable loss.

Offset = RF cable loss.

Following shows an offset computation example with cable loss 6 dB.

Example :

Offset(dB) = RF cable loss(dB) = 6 (dB)

3 Test Result

3.1 Conducted Output Power Measurement

3.1.1 Description of the Conducted Output Power Measurement

A system simulator was used to establish communication with the EUT. Its parameters were set to force the EUT transmitting at maximum output power. The measured power in the radio frequency on the transmitter output terminals shall be reported.

3.1.2 Measuring Instruments

The measuring equipment is listed in the section 4 of this test report.

3.1.3 Test Procedures

1. The transmitter output port was connected to the system simulator.
2. Set EUT at maximum power through the system simulator.
3. Select lowest, middle, and highest channels for each band and different modulation.
4. Measure and record the power level from the system simulator.

3.1.4 Test Setup

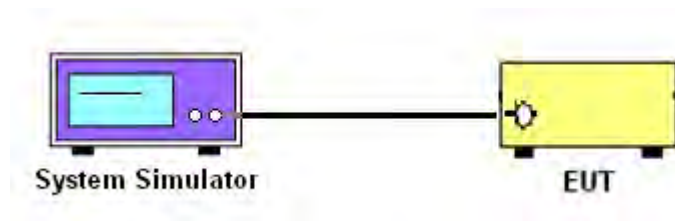



3.1.5 Test Result of Conducted Output Power

<LTE Band 7 Conducted Power>

BW [MHz]	Modulation	RB Size	RB Offset	Power (dBm) Low Ch. / Freq.	Power (dBm) Middle Ch. / Freq.	Power (dBm) High Ch. / Freq.
Channel				20850	21100	21350
Frequency (MHz)				2510	2535	2560
20	QPSK	1	0	20.91	20.83	20.67
20	QPSK	1	49	20.99	21.00	20.80
20	QPSK	1	99	20.93	20.73	20.79
20	QPSK	50	0	20.00	19.96	19.84
20	QPSK	50	24	19.98	19.94	19.95
20	QPSK	50	49	20.02	20.05	19.98
20	QPSK	100	0	20.09	20.10	20.03
20	16QAM	1	0	20.02	19.65	19.83
20	16QAM	1	49	20.08	19.93	20.15
20	16QAM	1	99	19.82	19.87	19.91
20	16QAM	50	0	19.25	19.25	19.05
20	16QAM	50	24	19.23	19.26	19.12
20	16QAM	50	49	19.21	19.20	19.04
20	16QAM	100	0	19.18	19.15	19.10
Channel				20825	21100	21375
Frequency (MHz)				2507.5	2535	2562.5
15	QPSK	1	0	20.83	20.75	20.65
15	QPSK	1	37	20.85	20.83	20.77
15	QPSK	1	74	20.95	20.94	20.93
15	QPSK	36	0	20.18	20.10	20.09
15	QPSK	36	18	20.14	20.11	20.25
15	QPSK	36	37	20.26	20.27	20.13
15	QPSK	75	0	20.22	19.98	20.07
15	16QAM	1	0	20.19	20.10	19.66
15	16QAM	1	37	20.24	20.22	20.20
15	16QAM	1	74	19.69	19.89	20.19
15	16QAM	36	0	19.25	19.09	19.24
15	16QAM	36	18	19.32	19.13	19.16
15	16QAM	36	37	19.12	19.17	19.12
15	16QAM	75	0	19.06	19.19	19.01



BW [MHz]	Modulation	RB Size	RB Offset	Power (dBm) Low Ch. / Freq.	Power (dBm) Middle Ch. / Freq.	Power (dBm) High Ch. / Freq.
Channel				20800	21100	21400
Frequency (MHz)				2505	2535	2565
10	QPSK	1	0	20.85	20.68	20.81
10	QPSK	1	24	20.93	20.88	20.76
10	QPSK	1	49	20.97	20.91	20.86
10	QPSK	25	0	20.29	19.97	20.06
10	QPSK	25	12	20.17	19.92	20.04
10	QPSK	25	24	20.11	19.97	20.06
10	QPSK	50	0	20.11	20.06	20.02
10	16QAM	1	0	20.42	19.88	20.04
10	16QAM	1	24	20.41	19.73	19.99
10	16QAM	1	49	20.01	19.75	19.89
10	16QAM	25	0	19.10	18.91	19.08
10	16QAM	25	12	19.22	19.22	19.22
10	16QAM	25	24	19.26	19.16	19.06
10	16QAM	50	0	19.11	19.12	19.14
Channel				20775	21100	21425
Frequency (MHz)				2502.5	2535	2567.5
5	QPSK	1	0	20.93	20.77	20.77
5	QPSK	1	12	20.85	20.58	20.67
5	QPSK	1	24	20.92	20.88	20.96
5	QPSK	12	0	20.15	20.23	20.01
5	QPSK	12	6	20.07	20.14	20.04
5	QPSK	12	11	20.17	20.13	20.06
5	QPSK	25	0	20.13	20.11	20.05
5	16QAM	1	0	20.08	20.00	20.31
5	16QAM	1	12	20.02	19.99	20.13
5	16QAM	1	24	20.01	19.75	20.28
5	16QAM	12	0	19.40	19.13	19.19
5	16QAM	12	6	19.28	19.20	19.31
5	16QAM	12	11	19.29	19.19	18.82
5	16QAM	25	0	19.38	19.18	18.94



<LTE Band 2 Conducted Power>

BW [MHz]	Modulation	RB Size	RB Offset	Power (dBm) Low Ch. / Freq.	Power (dBm) Middle Ch. / Freq.	Power (dBm) High Ch. / Freq.
Channel				18700	18900	19100
Frequency (MHz)				1860	1880	1900
20	QPSK	1	0	22.59	22.75	22.61
20	QPSK	1	49	22.37	22.62	22.46
20	QPSK	1	99	22.52	22.59	22.01
20	QPSK	50	0	21.47	21.74	21.41
20	QPSK	50	24	21.44	21.59	21.38
20	QPSK	50	49	21.46	21.68	21.21
20	QPSK	100	0	21.45	21.70	21.29
20	16QAM	1	0	21.41	21.91	21.16
20	16QAM	1	49	21.44	21.66	21.34
20	16QAM	1	99	21.03	21.82	21.27
20	16QAM	50	0	20.39	20.66	20.62
20	16QAM	50	24	20.47	20.58	20.54
20	16QAM	50	49	20.43	20.66	20.46
20	16QAM	100	0	20.39	20.68	20.46
Channel				18675	18900	19125
Frequency (MHz)				1857.5	1880	1902.5
15	QPSK	1	0	22.65	22.70	22.50
15	QPSK	1	37	22.48	22.63	22.39
15	QPSK	1	74	22.53	22.57	22.21
15	QPSK	36	0	21.54	21.79	21.40
15	QPSK	36	18	21.55	21.81	21.22
15	QPSK	36	37	21.36	21.63	21.21
15	QPSK	75	0	21.46	21.69	21.24
15	16QAM	1	0	21.30	21.48	21.22
15	16QAM	1	37	21.52	21.90	21.24
15	16QAM	1	74	21.32	21.50	21.21
15	16QAM	36	0	20.54	20.72	20.61
15	16QAM	36	18	20.49	20.69	20.39
15	16QAM	36	37	20.32	20.71	20.34
15	16QAM	75	0	20.42	20.69	20.58



BW [MHz]	Modulation	RB Size	RB Offset	Power (dBm) Low Ch. / Freq.	Power (dBm) Middle Ch. / Freq.	Power (dBm) High Ch. / Freq.
Channel				18650	18900	19150
Frequency (MHz)				1855	1880	1905
10	QPSK	1	0	22.49	22.64	22.35
10	QPSK	1	24	22.51	22.72	22.20
10	QPSK	1	49	22.43	22.59	22.19
10	QPSK	25	0	21.42	21.79	21.35
10	QPSK	25	12	21.40	21.81	21.25
10	QPSK	25	24	21.53	21.67	21.33
10	QPSK	50	0	21.40	21.63	21.36
10	16QAM	1	0	21.65	21.93	21.19
10	16QAM	1	24	21.41	21.58	21.45
10	16QAM	1	49	21.02	21.24	21.07
10	16QAM	25	0	20.33	20.66	20.35
10	16QAM	25	12	20.52	20.77	20.31
10	16QAM	25	24	20.50	20.63	20.30
10	16QAM	50	0	20.35	20.53	20.46
Channel				18625	18900	19175
Frequency (MHz)				1852.5	1880	1907.5
5	QPSK	1	0	22.42	22.59	22.15
5	QPSK	1	12	22.47	22.51	22.16
5	QPSK	1	24	22.50	22.62	22.19
5	QPSK	12	0	21.48	21.85	21.40
5	QPSK	12	6	21.46	21.71	21.36
5	QPSK	12	11	21.44	21.77	21.27
5	QPSK	25	0	21.43	21.76	21.33
5	16QAM	1	0	21.67	21.74	21.57
5	16QAM	1	12	21.61	21.63	21.50
5	16QAM	1	24	21.64	21.60	21.44
5	16QAM	12	0	20.40	20.71	20.35
5	16QAM	12	6	20.37	20.72	20.46
5	16QAM	12	11	20.34	20.66	20.47
5	16QAM	25	0	20.33	20.58	20.54



BW [MHz]	Modulation	RB Size	RB Offset	Power (dBm) Low Ch. / Freq.	Power (dBm) Middle Ch. / Freq.	Power (dBm) High Ch. / Freq.
Channel				18615	18900	19185
Frequency (MHz)				1851.5	1880	1908.5
3	QPSK	1	0	22.50	22.68	22.27
3	QPSK	1	7	22.42	22.66	22.15
3	QPSK	1	14	22.31	22.65	22.12
3	QPSK	8	0	21.50	21.75	21.23
3	QPSK	8	4	21.47	21.75	21.27
3	QPSK	8	7	21.36	21.79	21.26
3	QPSK	15	0	21.46	21.69	21.35
3	16QAM	1	0	21.67	21.77	21.29
3	16QAM	1	7	21.28	21.74	21.07
3	16QAM	1	14	21.00	21.47	21.06
3	16QAM	8	0	20.31	20.64	20.18
3	16QAM	8	4	20.37	20.61	20.29
3	16QAM	8	7	20.48	20.57	20.25
3	16QAM	15	0	20.59	20.60	20.50
Channel				18607	18900	19193
Frequency (MHz)				1850.7	1880	1909.3
1.4	QPSK	1	0	22.57	22.72	22.27
1.4	QPSK	1	2	22.54	22.64	22.19
1.4	QPSK	1	5	22.50	22.69	22.14
1.4	QPSK	3	0	22.40	22.67	22.22
1.4	QPSK	3	1	22.49	22.62	22.19
1.4	QPSK	3	2	22.47	22.70	22.20
1.4	QPSK	6	0	21.43	21.77	21.20
1.4	16QAM	1	0	21.58	21.81	21.29
1.4	16QAM	1	2	21.39	21.64	21.02
1.4	16QAM	1	5	21.55	21.63	20.94
1.4	16QAM	3	0	21.55	21.65	21.21
1.4	16QAM	3	1	21.44	21.78	21.25
1.4	16QAM	3	2	21.54	21.74	21.24
1.4	16QAM	6	0	20.35	20.91	20.58



<LTE Band 4 Conducted Power>

BW [MHz]	Modulation	RB Size	RB Offset	Power (dBm) Low Ch. / Freq.	Power (dBm) Middle Ch. / Freq.	Power (dBm) High Ch. / Freq.
Channel				20050	20175	20300
Frequency (MHz)				1720	1732.5	1745
20	QPSK	1	0	23.05	22.80	22.50
20	QPSK	1	49	22.83	22.57	22.43
20	QPSK	1	99	22.52	22.33	22.36
20	QPSK	50	0	21.99	21.71	21.54
20	QPSK	50	24	21.97	21.53	21.44
20	QPSK	50	49	21.82	21.49	21.53
20	QPSK	100	0	21.81	21.70	21.52
20	16QAM	1	0	21.73	21.83	21.18
20	16QAM	1	49	22.19	21.87	21.79
20	16QAM	1	99	21.92	21.12	21.31
20	16QAM	50	0	20.98	20.57	20.41
20	16QAM	50	24	21.07	20.56	20.49
20	16QAM	50	49	20.82	20.40	20.48
20	16QAM	100	0	20.82	20.62	20.45
Channel				20025	20175	20325
Frequency (MHz)				1717.5	1732.5	1747.5
15	QPSK	1	0	22.93	22.86	22.58
15	QPSK	1	37	22.80	22.64	22.54
15	QPSK	1	74	22.73	22.42	22.52
15	QPSK	36	0	21.95	21.82	21.49
15	QPSK	36	18	21.92	21.69	21.50
15	QPSK	36	37	21.92	21.44	21.52
15	QPSK	75	0	21.92	21.64	21.50
15	16QAM	1	0	22.00	22.08	21.82
15	16QAM	1	37	21.89	21.52	21.51
15	16QAM	1	74	21.40	21.67	21.43
15	16QAM	36	0	20.87	20.80	20.46
15	16QAM	36	18	20.74	20.61	20.45
15	16QAM	36	37	20.82	20.45	20.49
15	16QAM	75	0	20.85	20.53	20.42



BW [MHz]	Modulation	RB Size	RB Offset	Power (dBm) Low Ch. / Freq.	Power (dBm) Middle Ch. / Freq.	Power (dBm) High Ch. / Freq.
Channel				20000	20175	20350
Frequency (MHz)				1715	1732.5	1750
10	QPSK	1	0	22.92	22.77	22.61
10	QPSK	1	24	22.99	22.78	22.66
10	QPSK	1	49	22.81	22.39	22.47
10	QPSK	25	0	22.04	21.89	21.56
10	QPSK	25	12	21.81	21.66	21.61
10	QPSK	25	24	21.85	21.51	21.54
10	QPSK	50	0	21.85	21.52	21.55
10	16QAM	1	0	21.78	21.95	21.66
10	16QAM	1	24	21.96	21.41	21.75
10	16QAM	1	49	22.04	21.96	21.79
10	16QAM	25	0	21.09	20.64	20.55
10	16QAM	25	12	21.15	20.60	20.49
10	16QAM	25	24	20.72	20.53	20.47
10	16QAM	50	0	20.81	20.51	20.56
Channel				19975	20175	20375
Frequency (MHz)				1712.5	1732.5	1752.5
5	QPSK	1	0	22.81	22.56	22.53
5	QPSK	1	12	22.95	22.46	22.36
5	QPSK	1	24	23.01	22.62	22.59
5	QPSK	12	0	21.97	21.76	21.77
5	QPSK	12	6	21.98	21.68	21.58
5	QPSK	12	11	21.99	21.57	21.57
5	QPSK	25	0	21.95	21.67	21.58
5	16QAM	1	0	22.43	21.66	21.74
5	16QAM	1	12	22.27	21.62	21.41
5	16QAM	1	24	21.97	21.53	21.58
5	16QAM	12	0	21.03	20.59	20.62
5	16QAM	12	6	21.01	20.50	20.62
5	16QAM	12	11	20.99	20.46	20.58
5	16QAM	25	0	20.98	20.58	20.56



BW [MHz]	Modulation	RB Size	RB Offset	Power (dBm) Low Ch. / Freq.	Power (dBm) Middle Ch. / Freq.	Power (dBm) High Ch. / Freq.
Channel				19965	20175	20385
Frequency (MHz)				1711.5	1732.5	1753.5
3	QPSK	1	0	23.03	22.72	22.57
3	QPSK	1	7	22.89	22.55	22.49
3	QPSK	1	14	22.89	22.54	22.52
3	QPSK	8	0	21.89	21.68	21.52
3	QPSK	8	4	22.00	21.58	21.65
3	QPSK	8	7	21.97	21.57	21.64
3	QPSK	15	0	21.89	21.71	21.69
3	16QAM	1	0	21.88	21.57	21.62
3	16QAM	1	7	21.86	21.61	21.50
3	16QAM	1	14	22.45	21.62	21.71
3	16QAM	8	0	20.95	20.64	20.46
3	16QAM	8	4	21.06	20.65	20.55
3	16QAM	8	7	21.06	20.54	20.55
3	16QAM	15	0	20.93	20.60	20.52
Channel				19957	20175	20393
Frequency (MHz)				1710.7	1732.5	1754.3
1.4	QPSK	1	0	22.70	22.59	22.55
1.4	QPSK	1	2	22.86	22.60	22.67
1.4	QPSK	1	5	22.77	22.57	22.56
1.4	QPSK	3	0	22.77	22.59	22.59
1.4	QPSK	3	1	22.80	22.57	22.59
1.4	QPSK	3	2	22.81	22.59	22.54
1.4	QPSK	6	0	21.87	21.62	21.71
1.4	16QAM	1	0	21.77	21.51	21.22
1.4	16QAM	1	2	22.04	21.72	21.76
1.4	16QAM	1	5	21.73	21.64	21.37
1.4	16QAM	3	0	21.73	21.71	21.59
1.4	16QAM	3	1	21.87	21.69	21.52
1.4	16QAM	3	2	21.90	21.56	21.60
1.4	16QAM	6	0	21.01	20.57	20.41



<LTE Band 17 Conducted Power>

BW [MHz]	Modulation	RB Size	RB Offset	Power (dBm) Low Ch. / Freq.	Power (dBm) Middle Ch. / Freq.	Power (dBm) High Ch. / Freq.
Channel				23780	23790	23800
Frequency (MHz)				709	710	711
10	QPSK	1	0	22.82	22.88	22.91
10	QPSK	1	24	23.35	23.47	23.42
10	QPSK	1	49	23.34	23.26	23.00
10	QPSK	25	0	21.96	22.08	22.25
10	QPSK	25	12	22.27	22.31	22.23
10	QPSK	25	24	22.32	22.37	22.34
10	QPSK	50	0	22.15	22.18	22.20
10	16QAM	1	0	21.94	22.00	21.96
10	16QAM	1	24	22.87	22.53	22.29
10	16QAM	1	49	22.86	22.43	22.16
10	16QAM	25	0	20.99	21.04	21.16
10	16QAM	25	12	21.22	21.34	21.38
10	16QAM	25	24	21.44	21.25	21.22
10	16QAM	50	0	21.19	21.17	21.14
Channel				23755	23790	23825
Frequency (MHz)				706.5	710	713.5
5	QPSK	1	0	23.20	23.30	23.38
5	QPSK	1	12	22.64	23.20	23.10
5	QPSK	1	24	22.68	23.29	22.83
5	QPSK	12	0	21.66	22.24	22.19
5	QPSK	12	6	21.84	22.35	22.11
5	QPSK	12	11	22.02	22.39	22.05
5	QPSK	25	0	21.82	22.29	22.12
5	16QAM	1	0	22.35	22.63	22.61
5	16QAM	1	12	21.86	22.52	22.00
5	16QAM	1	24	22.30	22.49	22.03
5	16QAM	12	0	20.74	21.25	21.30
5	16QAM	12	6	20.81	21.30	21.20
5	16QAM	12	11	21.01	21.38	21.05
5	16QAM	25	0	20.85	21.23	21.14

Note: maximum average power for LTE.

3.2 Peak-to-Average Ratio

3.2.1 Description of the PAR Measurement

Power Complementary Cumulative Distribution Function (CCDF) curves provide a means for characterizing the power peaks of a digitally modulated signal on a statistical basis. A CCDF curve depicts the probability of the peak signal amplitude exceeding the average power level. Most contemporary measurement instrumentation include the capability to produce CCDF curves for an input signal provided that the instrument's resolution bandwidth can be set wide enough to accommodate the entire input signal bandwidth. In measuring transmissions in this band using an average power technique, the peak-to-average ratio (PAR) of the transmission may not exceed 13 dB.

3.2.2 Measuring Instruments

The measuring equipment is listed in the section 4 of this test report.

3.2.3 Test Procedures

1. The EUT was connected to spectrum and system simulator via a power divider.
2. Set the CCDF (Complementary Cumulative Distribution Function) option in spectrum analyzer.
3. The highest RF powers were measured and recorded the maximum PAPR level associated with a probability of 0.1 %.
4. Record the deviation as Peak to Average Ratio.

3.2.4 Test Setup

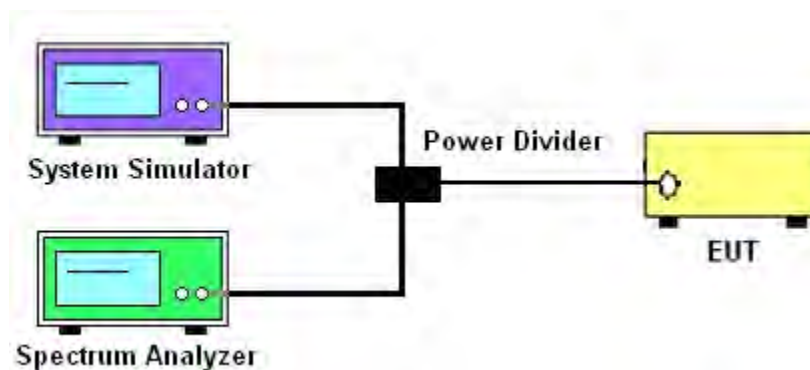



3.2.5 Test Result of Peak-to-Average Ratio

LTE Band 2						
BW [MHz]	Modulation	RB Size	RB Offset	Power (dBm) Low Ch. / Freq.	Power (dBm) Middle Ch. / Freq.	Power (dBm) High Ch. / Freq.
Channel				18700	18900	19100
Frequency (MHz)				1860	1880	1900
20	QPSK	1	0	4.41	4.00	4.17
20	QPSK	100	0	4.58	4.64	4.72
20	16QAM	1	0	5.04	4.72	4.67
20	16QAM	100	0	5.77	5.65	5.86

LTE Band 4						
BW [MHz]	Modulation	RB Size	RB Offset	Power (dBm) Low Ch. / Freq.	Power (dBm) Middle Ch. / Freq.	Power (dBm) High Ch. / Freq.
Channel				20050	20175	20300
Frequency (MHz)				1720	1732.5	1745
20	QPSK	1	0	4.26	4.17	4.70
20	QPSK	100	0	4.41	4.58	4.52
20	16QAM	1	0	5.25	5.13	5.86
20	16QAM	100	0	5.65	5.80	5.68

LTE Band 7						
BW [MHz]	Modulation	RB Size	RB Offset	Power (dBm) Low Ch. / Freq.	Power (dBm) Middle Ch. / Freq.	Power (dBm) High Ch. / Freq.
Channel				20850	21100	21350
Frequency (MHz)				2510	2535	2560
20	QPSK	1	0	4.26	4.70	4.78
20	QPSK	100	0	4.90	4.93	5.04
20	16QAM	1	0	5.48	6.12	5.80
20	16QAM	100	0	5.94	5.83	5.94

LTE Band 17						
BW [MHz]	Modulation	RB Size	RB Offset	Power (dBm) Low Ch. / Freq.	Power (dBm) Middle Ch. / Freq.	Power (dBm) High Ch. / Freq.
Channel				23780	23790	23800
Frequency (MHz)				709	710	711
10	QPSK	1	0	3.83	3.83	4.12
10	QPSK	50	0	4.81	4.81	4.87
10	16QAM	1	0	4.41	5.10	5.33
10	16QAM	50	0	6.00	6.12	5.97



3.2.6 Peak to Average Power Ratio

Peak-to-Average Ratio on LTE Band 2
20MHz / QPSK in Ch. 18700 (1RB Size)

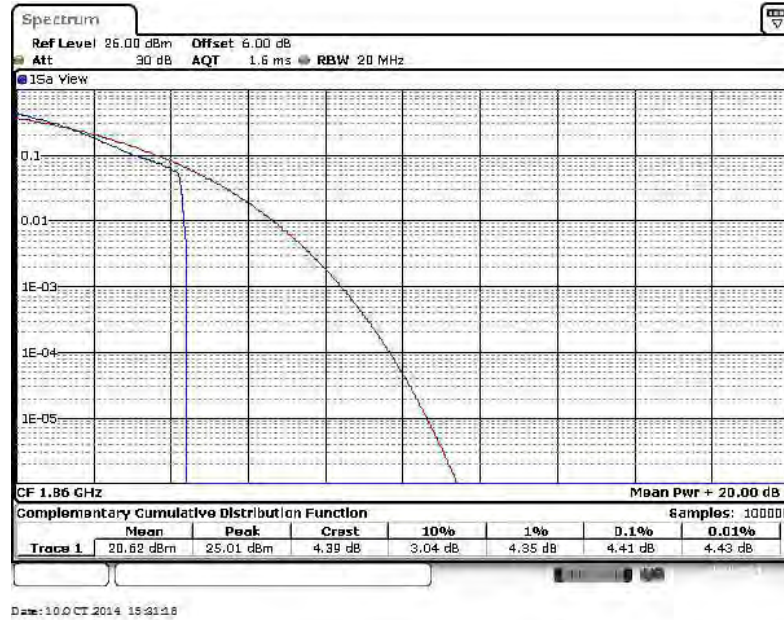

Peak-to-Average Ratio on LTE Band 2
20MHz / QPSK in Ch. 18900 (1RB Size)

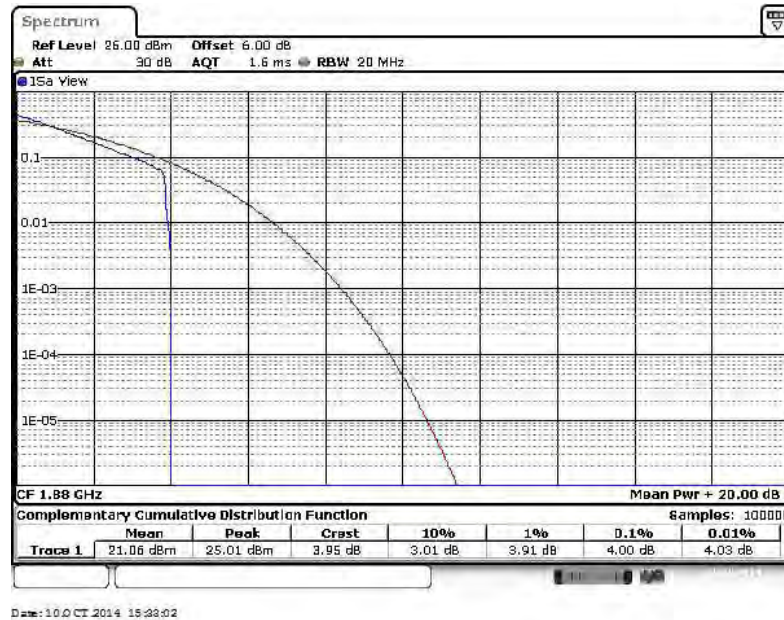



Peak-to-Average Ratio on LTE Band 2
20MHz / QPSK in Ch. 19100 (1RB Size)

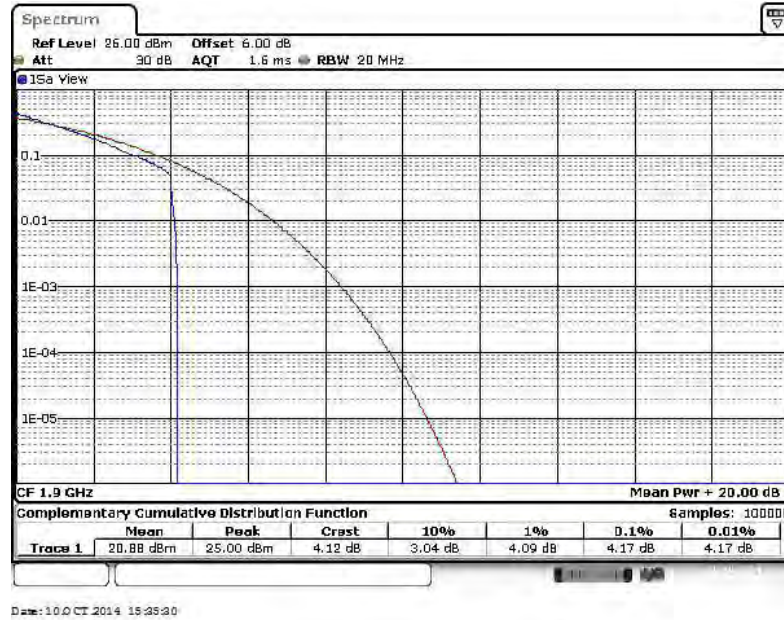

Peak-to-Average Ratio on LTE Band 2
20MHz / QPSK in Ch. 18700 (100RB Size)

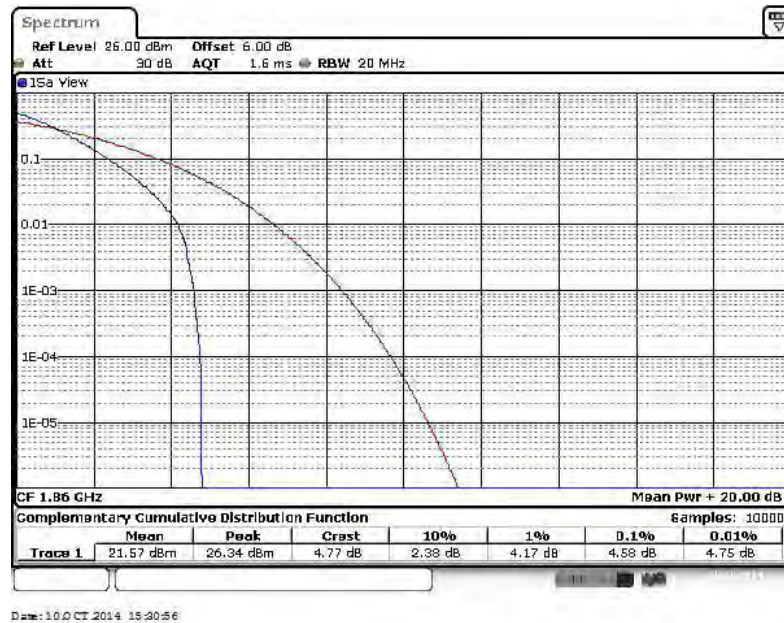



Peak-to-Average Ratio on LTE Band 2
20MHz / QPSK in Ch. 18900 (100RB Size)

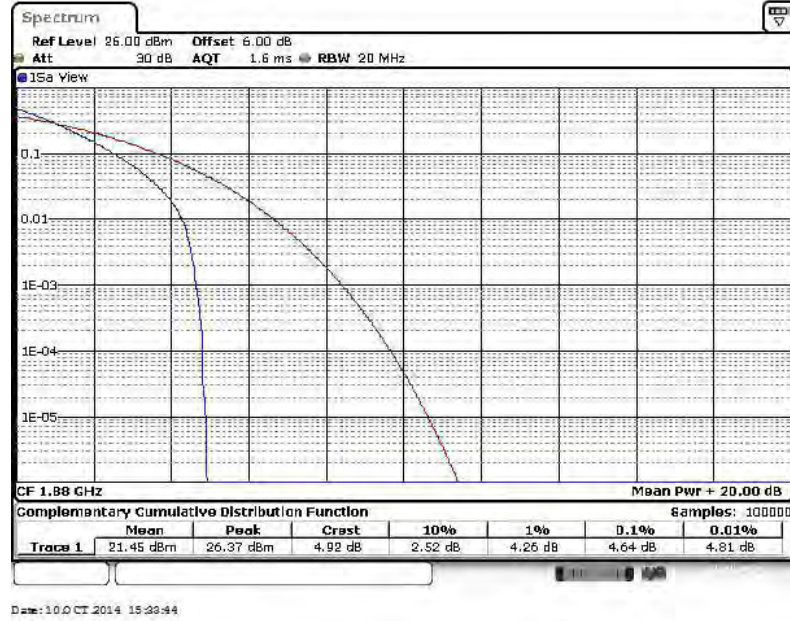

Peak-to-Average Ratio on LTE Band 2
20MHz / QPSK in Ch. 19100 (100RB Size)

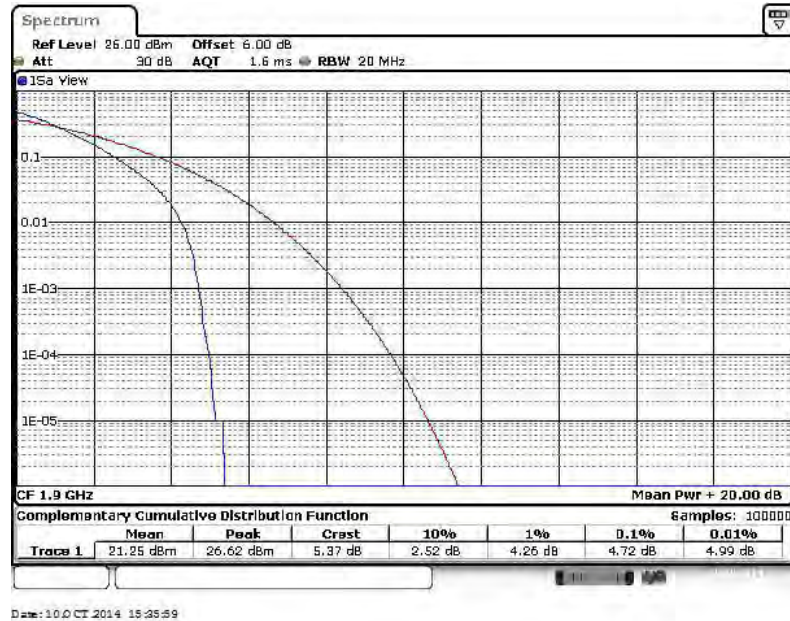



Peak-to-Average Ratio on LTE Band 2
20MHz / 16QAM in Ch. 18700 (1RB Size)

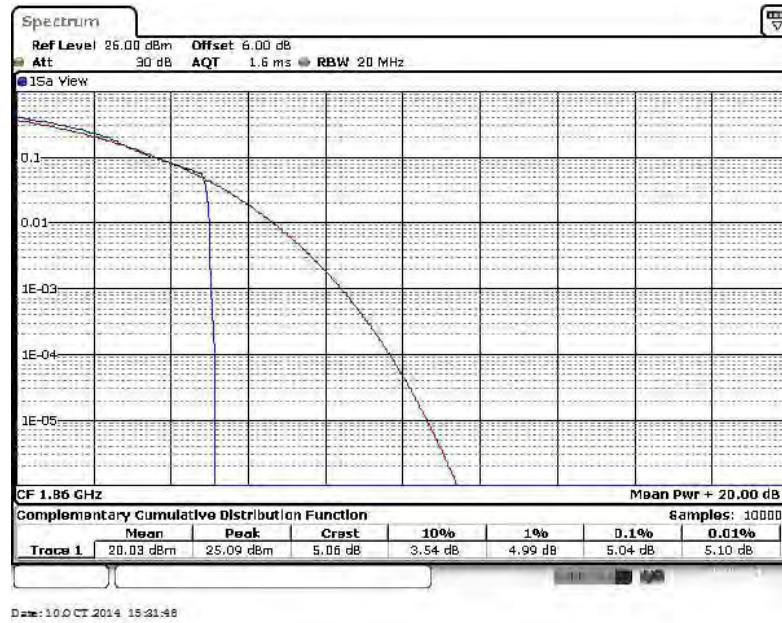

Peak-to-Average Ratio on LTE Band 2
20MHz / 16QAM in Ch. 18900 (1RB Size)

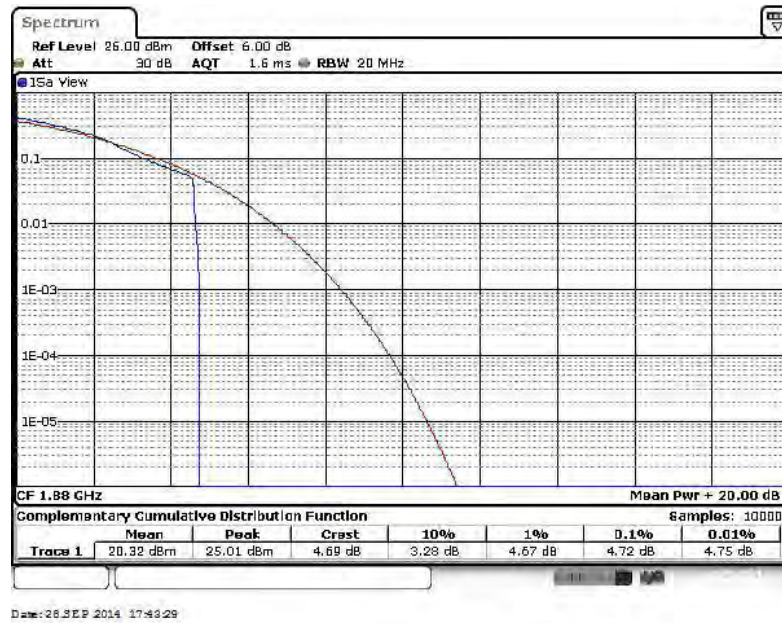



Peak-to-Average Ratio on LTE Band 2
20MHz / 16QAM in Ch. 19100 (1RB Size)

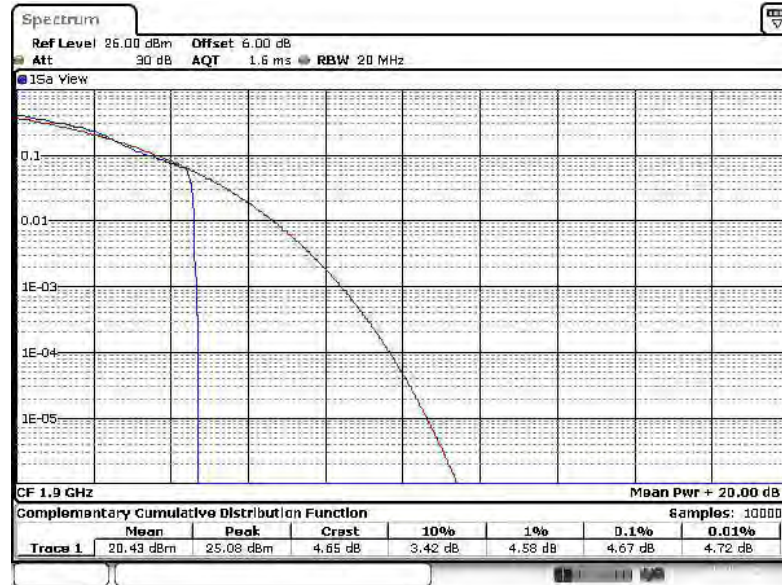

Date: 10 OCT 2014 15:26:24

Peak-to-Average Ratio on LTE Band 2
20MHz / 16QAM in Ch. 18700 (100RB Size)

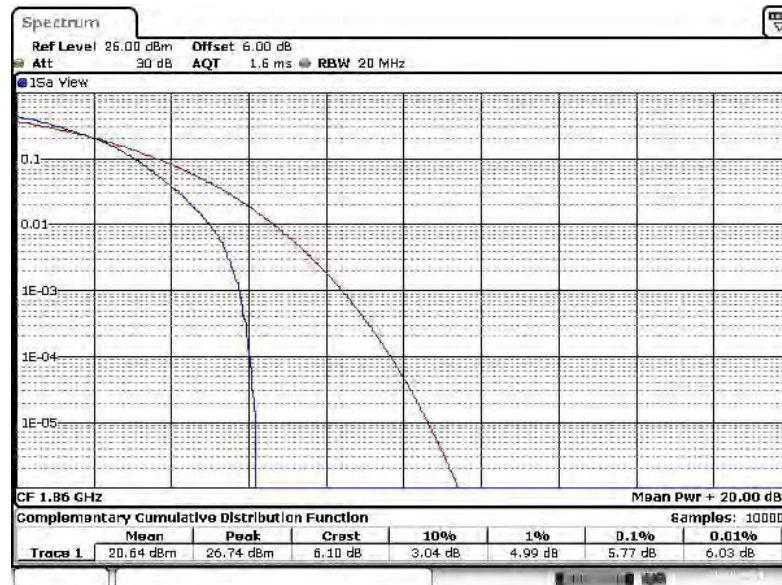

Date: 10 OCT 2014 15:22:18



Peak-to-Average Ratio on LTE Band 2
20MHz / 16QAM in Ch. 18900 (100RB Size)

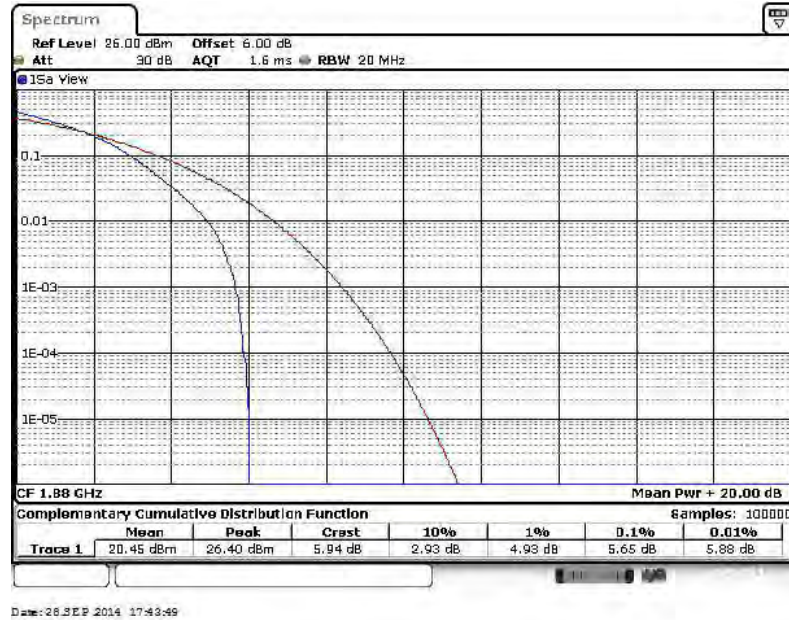

Peak-to-Average Ratio on LTE Band 2
20MHz / 16QAM in Ch. 19100 (100RB Size)

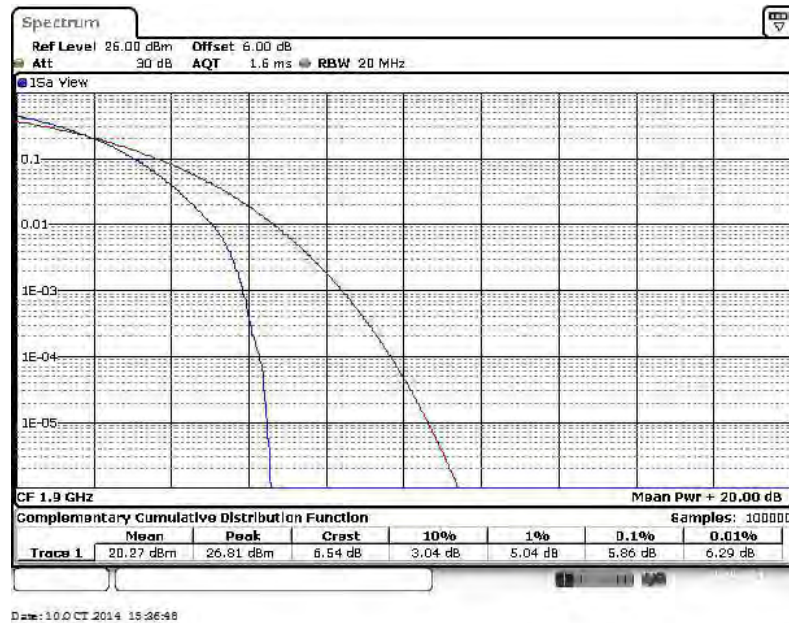



Peak-to-Average Ratio on LTE Band 4
20MHz / QPSK in Ch. 20050 (1RB Size)

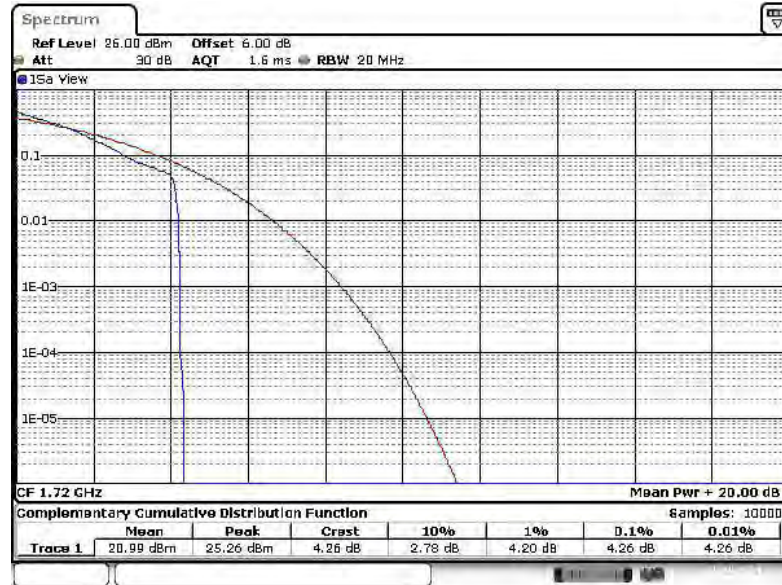

Date: 10 OCT 2014 15:50:17

Peak-to-Average Ratio on LTE Band 4
20MHz / QPSK in Ch. 20175 (1RB Size)

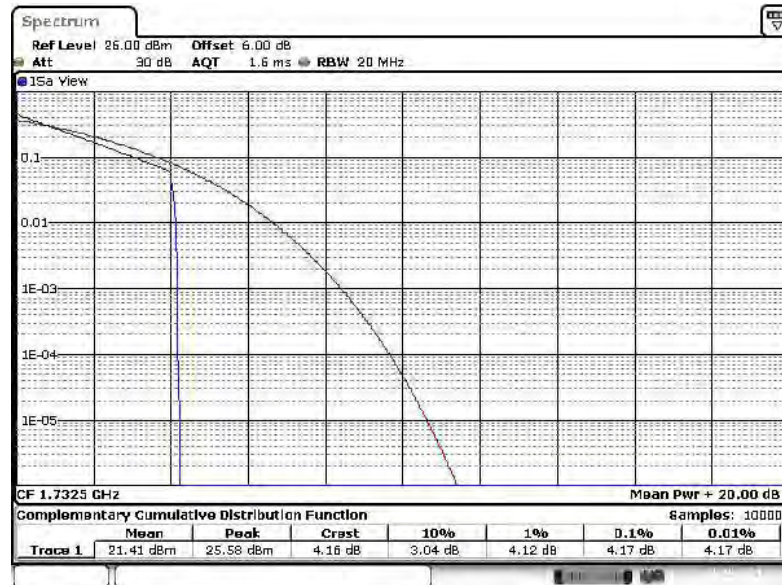

Date: 10 OCT 2014 15:52:20



Peak-to-Average Ratio on LTE Band 4
20MHz / QPSK in Ch. 20300 (1RB Size)

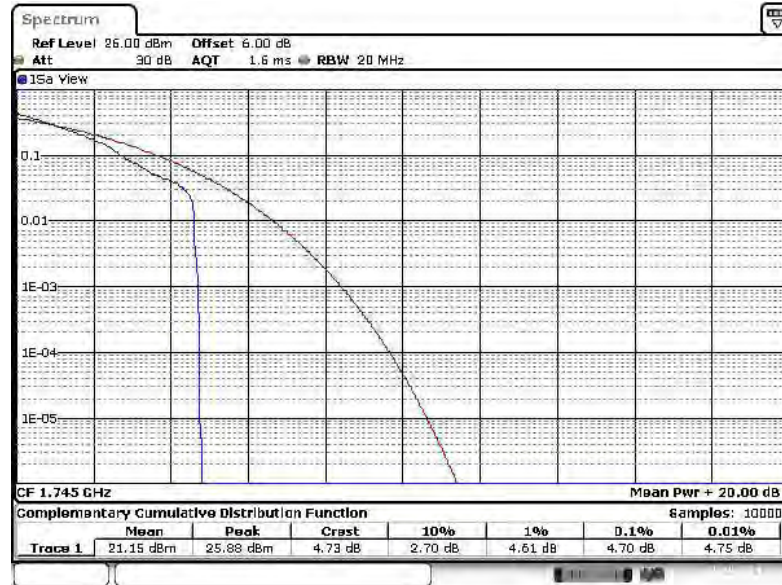

Date: 10 OCT 2014 15:55:20

Peak-to-Average Ratio on LTE Band 4
20MHz / QPSK in Ch. 20500 (100RB Size)

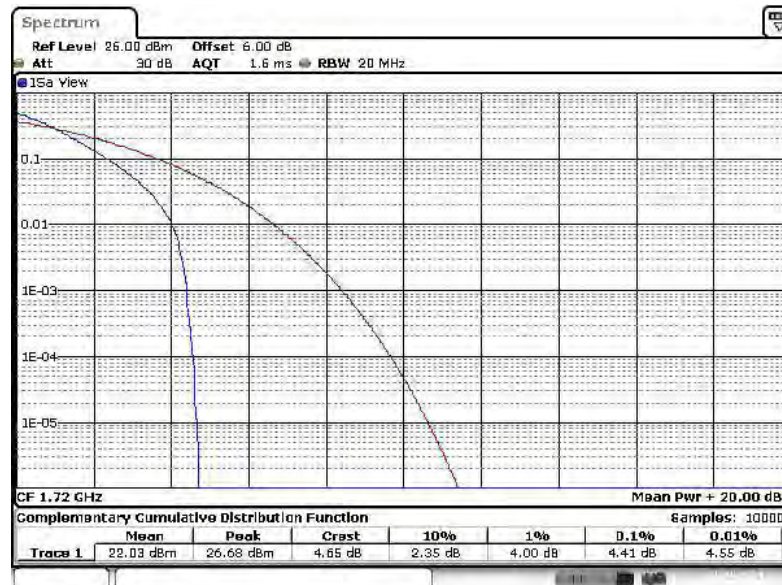

Date: 10 OCT 2014 15:50:29



Peak-to-Average Ratio on LTE Band 4
20MHz / QPSK in Ch. 20175 (100RB Size)

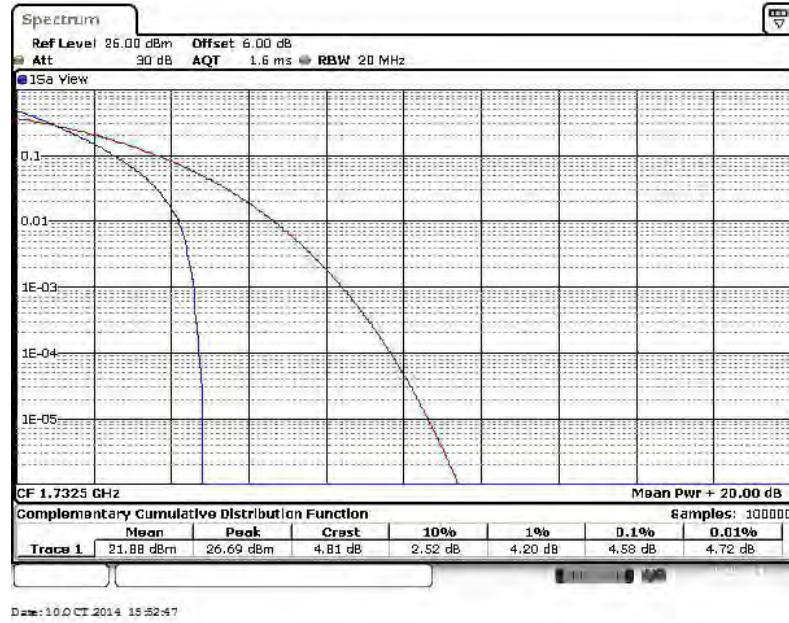

Peak-to-Average Ratio on LTE Band 4
20MHz / QPSK in Ch. 20300 (100RB Size)

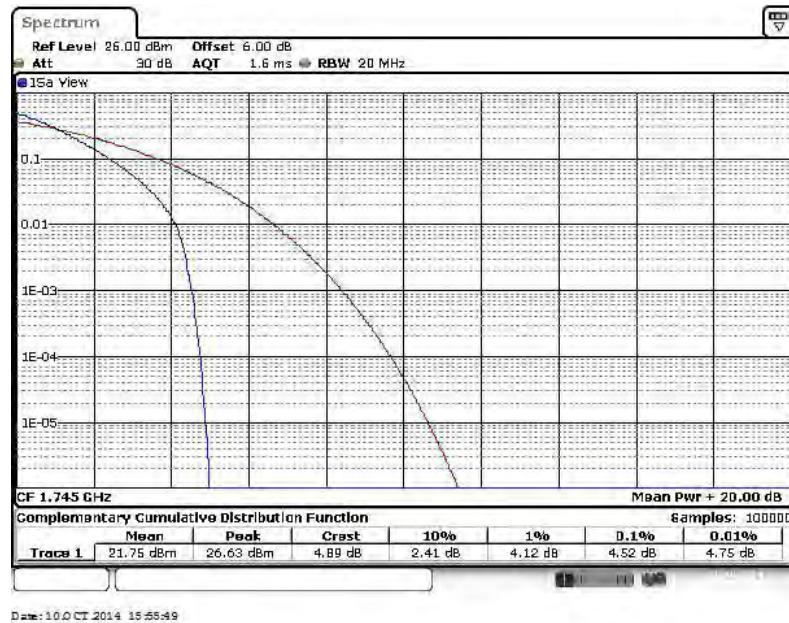



Peak-to-Average Ratio on LTE Band 4
20MHz / 16QAM in Ch. 20050 (1RB Size)

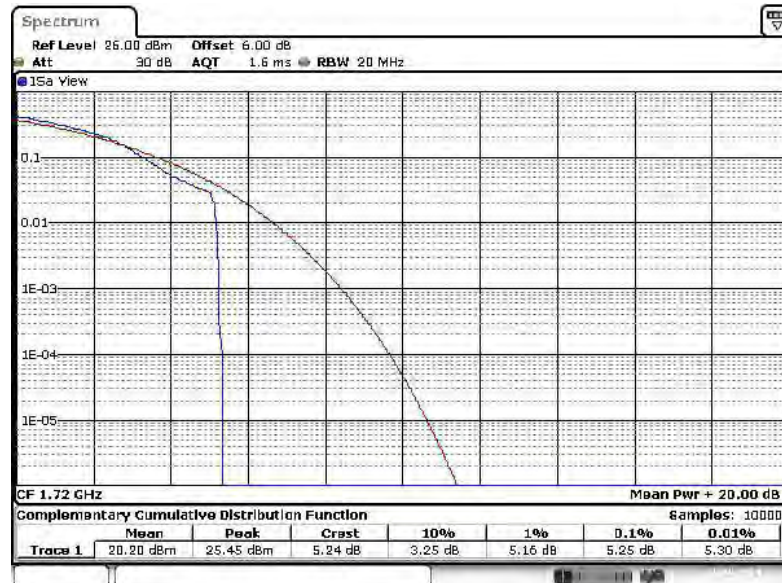

Date: 10 OCT 2014 15:51:22

Peak-to-Average Ratio on LTE Band 4
20MHz / 16QAM in Ch. 20175 (1RB Size)

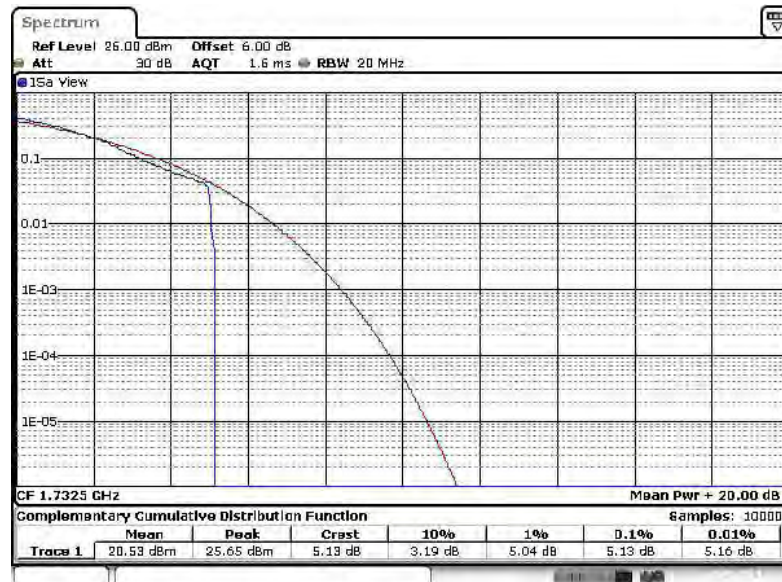

Date: 26 SEP 2014 20:35:49



Peak-to-Average Ratio on LTE Band 4
20MHz / 16QAM in Ch. 20300 (1RB Size)

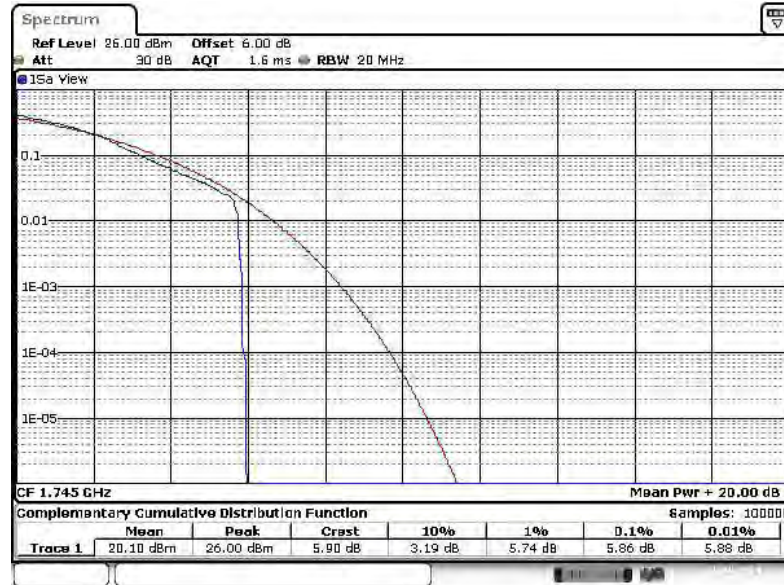

Date: 10 OCT 2014 15:56:41

Peak-to-Average Ratio on LTE Band 4
20MHz / 16QAM in Ch. 20500 (100RB Size)

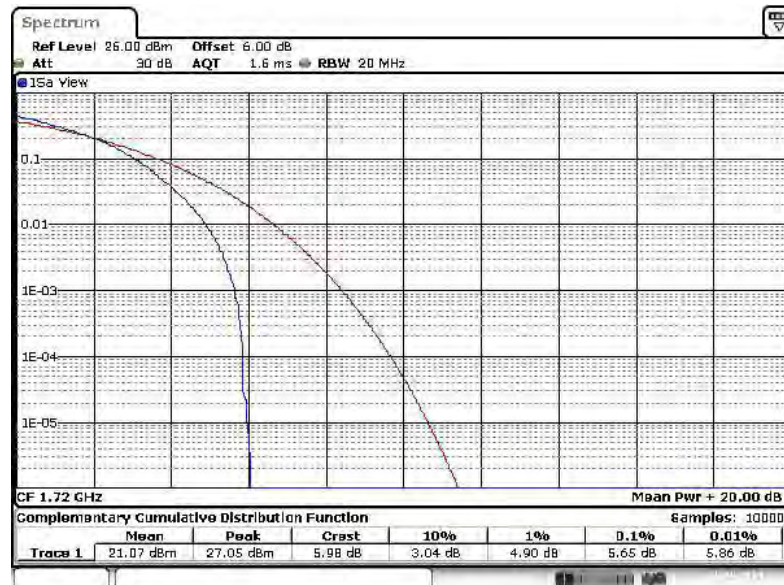

Date: 10 OCT 2014 15:51:01



Peak-to-Average Ratio on LTE Band 4
20MHz / 16QAM in Ch. 201750 (100RB Size)

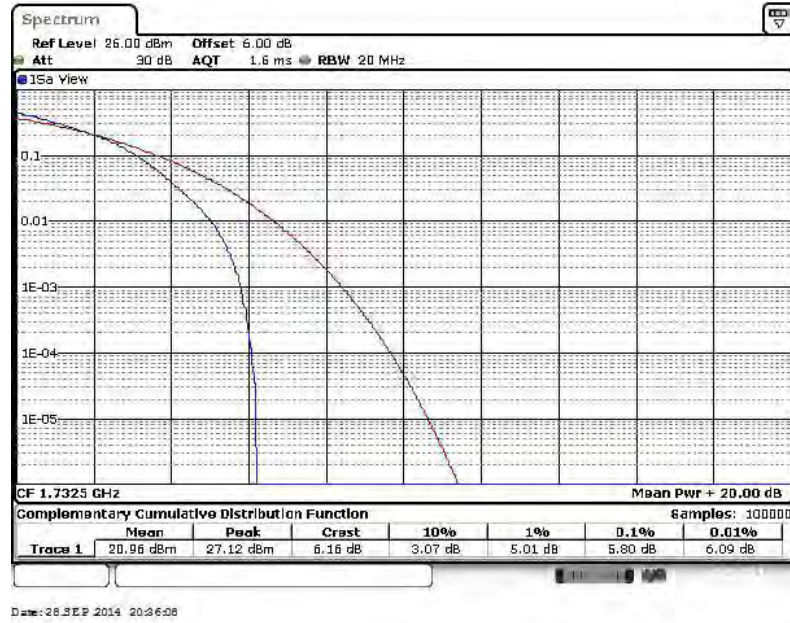

Peak-to-Average Ratio on LTE Band 4
20MHz / 16QAM in Ch. 20300 (100RB Size)

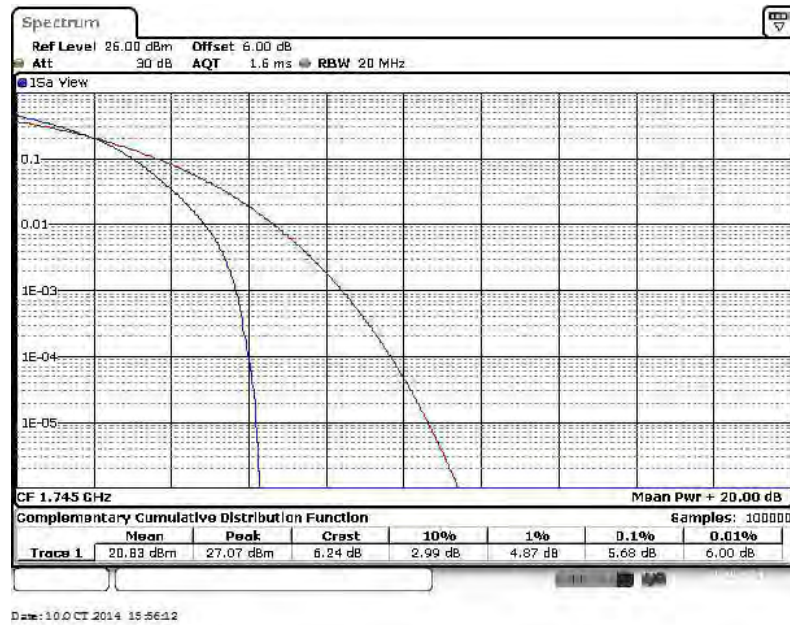



Peak-to-Average Ratio on LTE Band 7
20MHz / QPSK in Ch. 20850 (1RB Size)

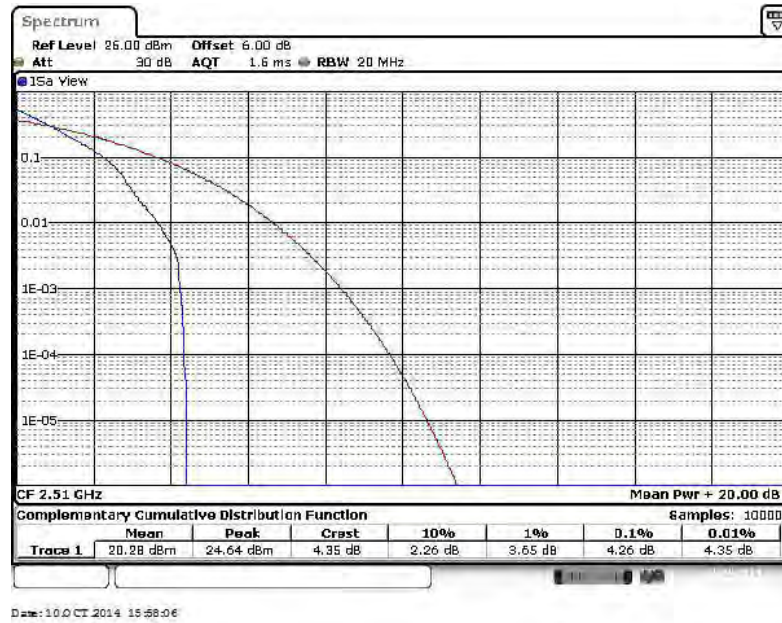

Peak-to-Average Ratio on LTE Band 7
20MHz / QPSK in Ch. 21100 (1RB Size)

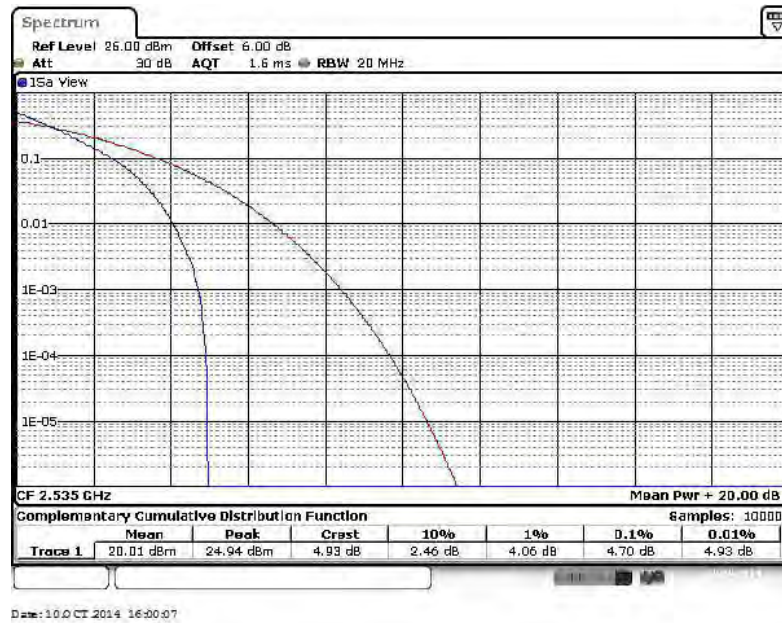



Peak-to-Average Ratio on LTE Band 7
20MHz / QPSK in Ch. 21350 (1RB Size)

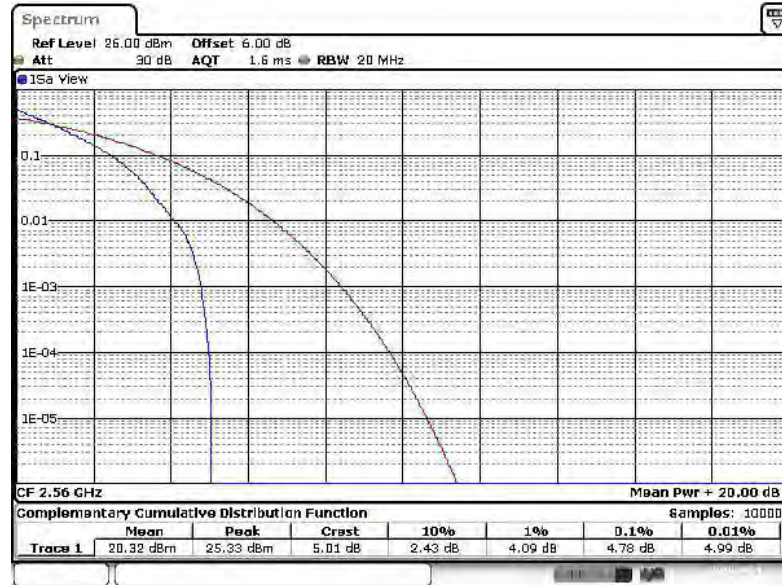

Date: 10 OCT 2014 16:02:29

Peak-to-Average Ratio on LTE Band 7
20MHz / QPSK in Ch. 20850 (100RB Size)

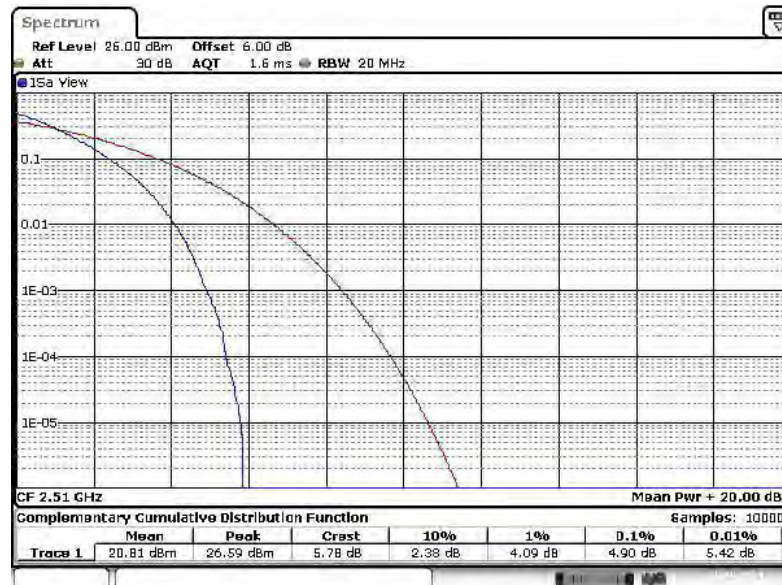

Date: 10 OCT 2014 15:58:29



Peak-to-Average Ratio on LTE Band 7
20MHz / QPSK in Ch. 21100 (100RB Size)

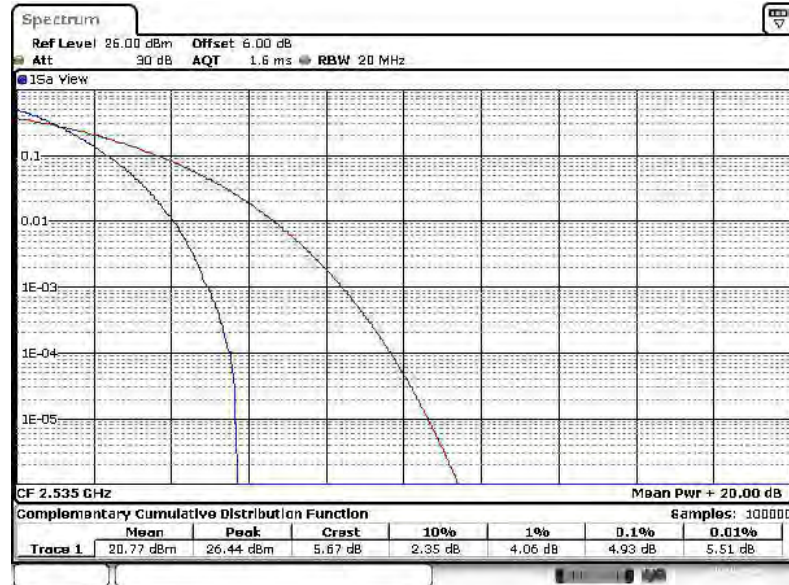

Date: 10 OCT 2014 16:00:24

Peak-to-Average Ratio on LTE Band 7
20MHz / QPSK in Ch. 21350 (100RB Size)

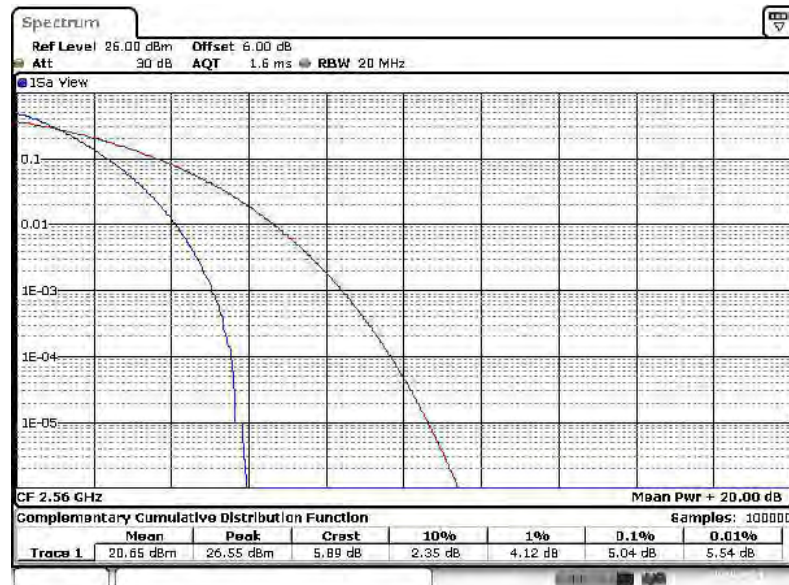

Date: 10 OCT 2014 16:00:16



Peak-to-Average Ratio on LTE Band 7
20MHz / 16QAM in Ch. 20850 (1RB Size)

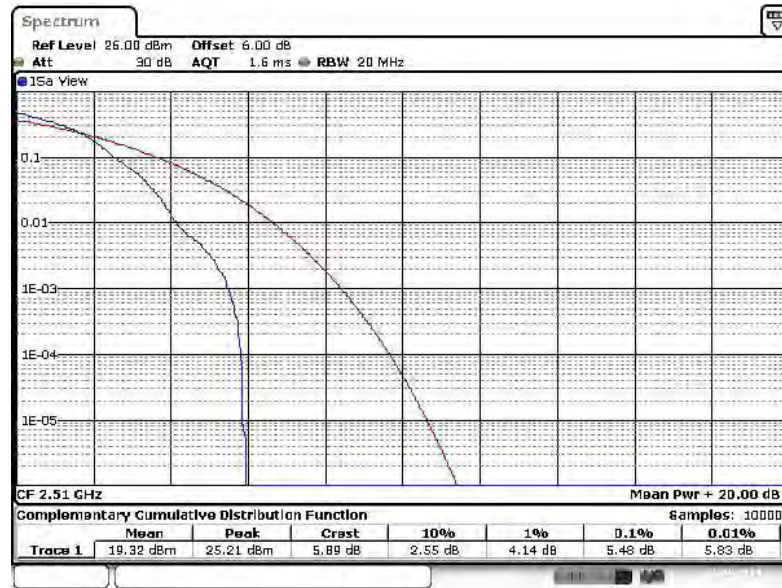

Date: 10 OCT 2014 15:58:59

Peak-to-Average Ratio on LTE Band 7
20MHz / 16QAM in Ch. 21100 (1RB Size)

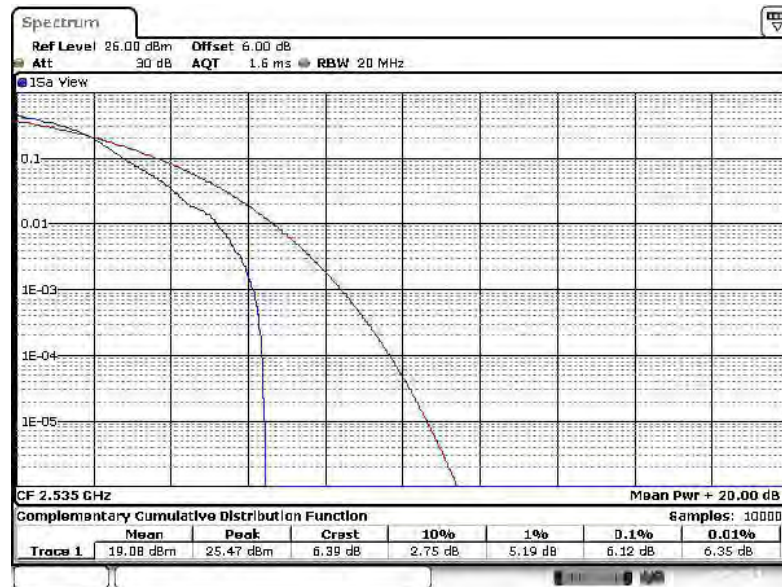

Date: 26 SEP 2014 12:48:57



Peak-to-Average Ratio on LTE Band 7
20MHz / 16QAM in Ch. 21350 (1RB Size)

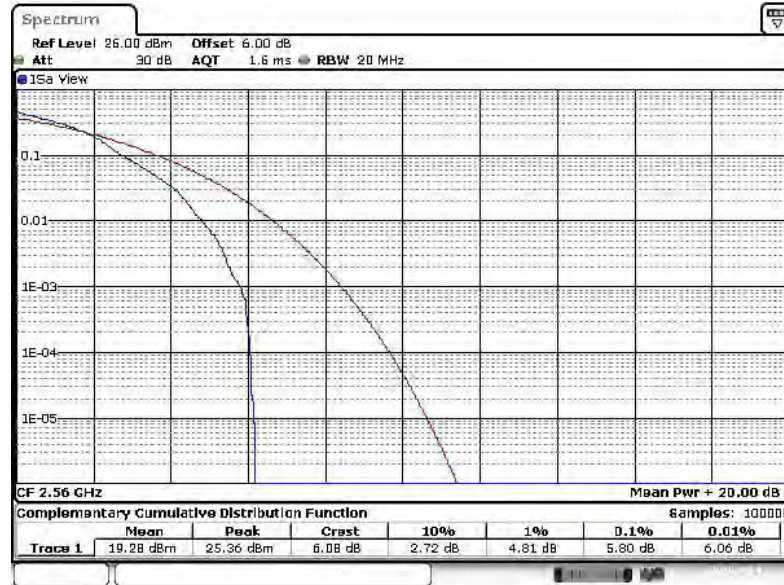

Date: 10 OCT 2014 16:03:42

Peak-to-Average Ratio on LTE Band 7
20MHz / 16QAM in Ch. 20850 (100RB Size)

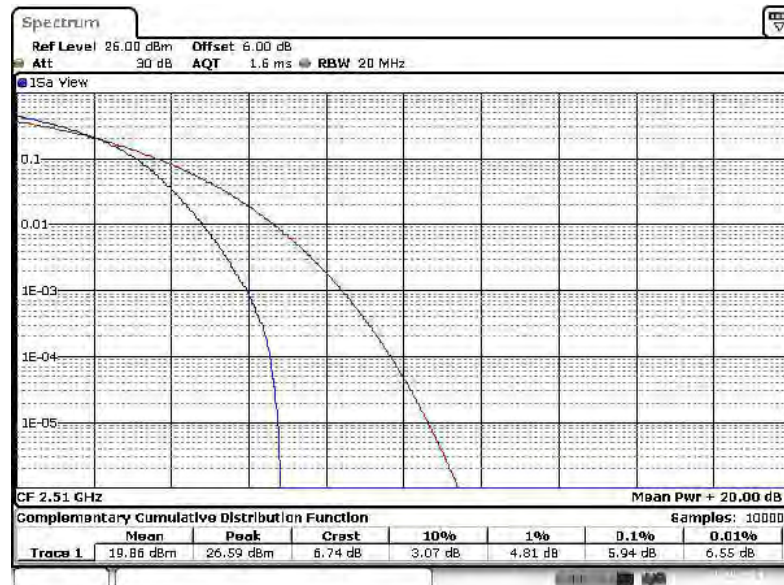

Date: 10 OCT 2014 15:59:23



Peak-to-Average Ratio on LTE Band 7
20MHz / 16QAM in Ch. 21100 (100RB Size)

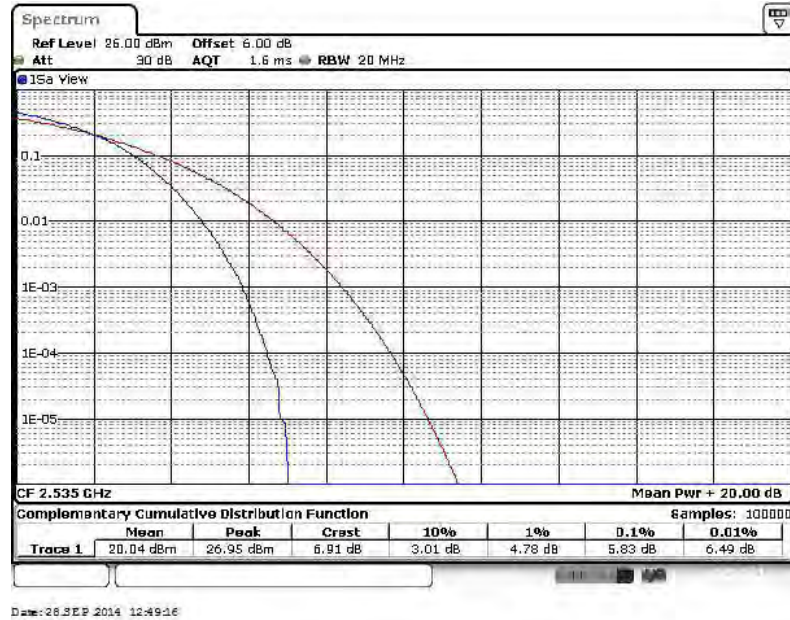

Peak-to-Average Ratio on LTE Band 7
20MHz / 16QAM in Ch. 21350 (100RB Size)

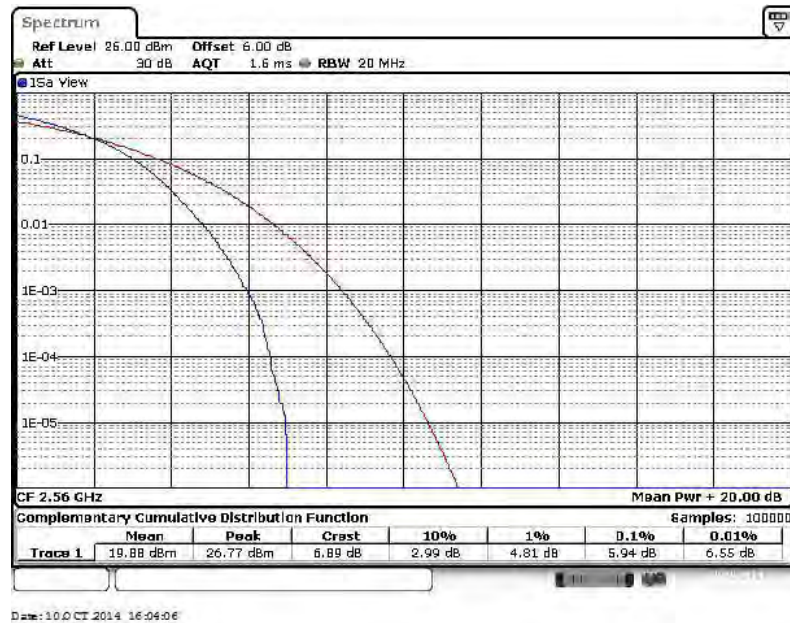



Peak-to-Average Ratio on LTE Band 17
10MHz / QPSK in Ch. 23780 (1RB Size)

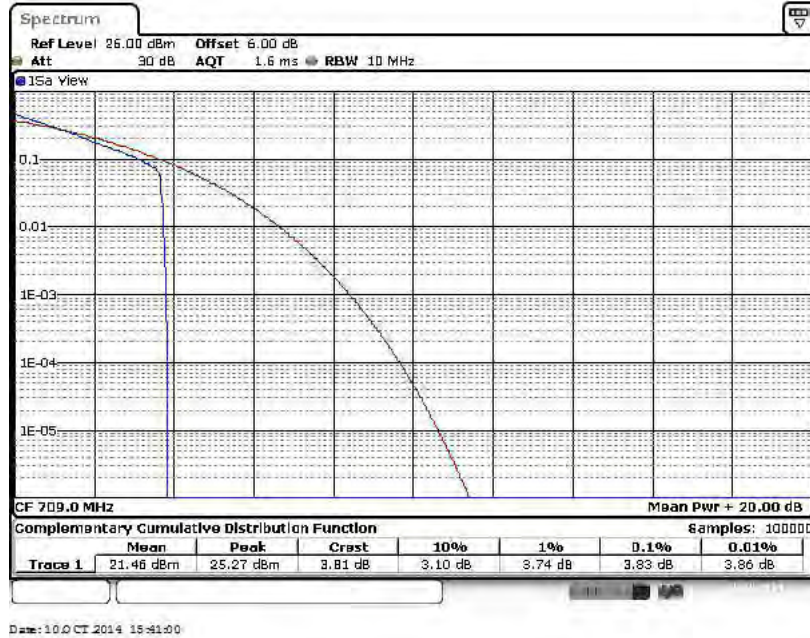

Peak-to-Average Ratio on LTE Band 17
10MHz / QPSK in Ch. 23790 (1RB Size)

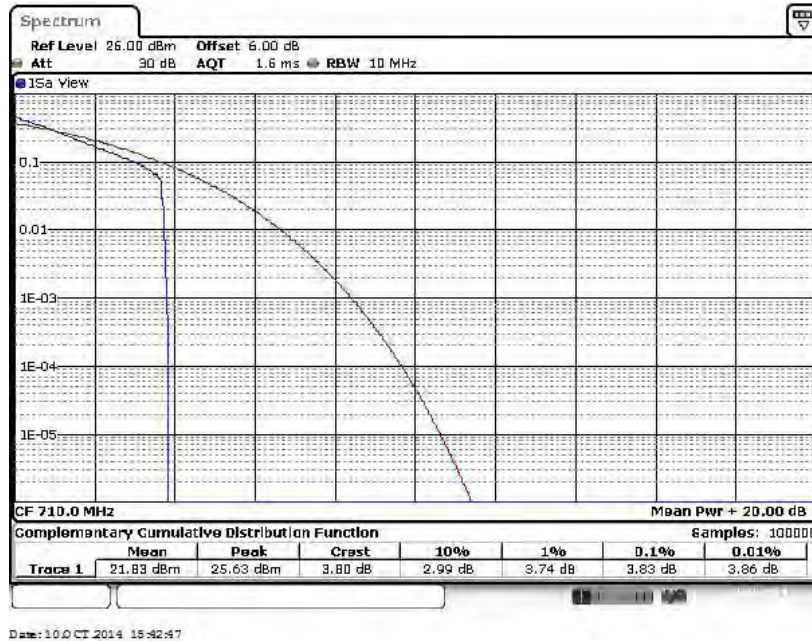



Peak-to-Average Ratio on LTE Band 17

10MHz / QPSK in Ch. 23800 (1RB Size)

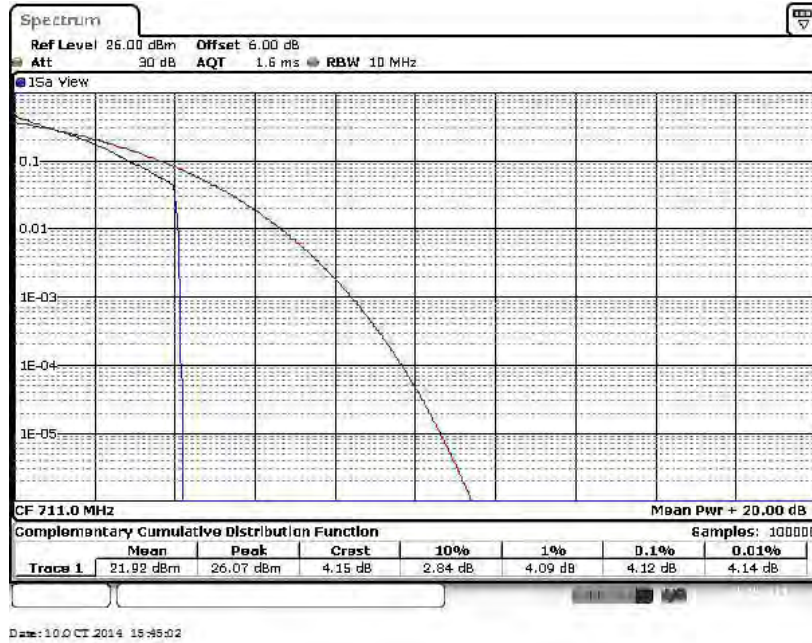

Peak-to-Average Ratio on LTE Band 17

10MHz / QPSK in Ch. 23780 (50RB Size)

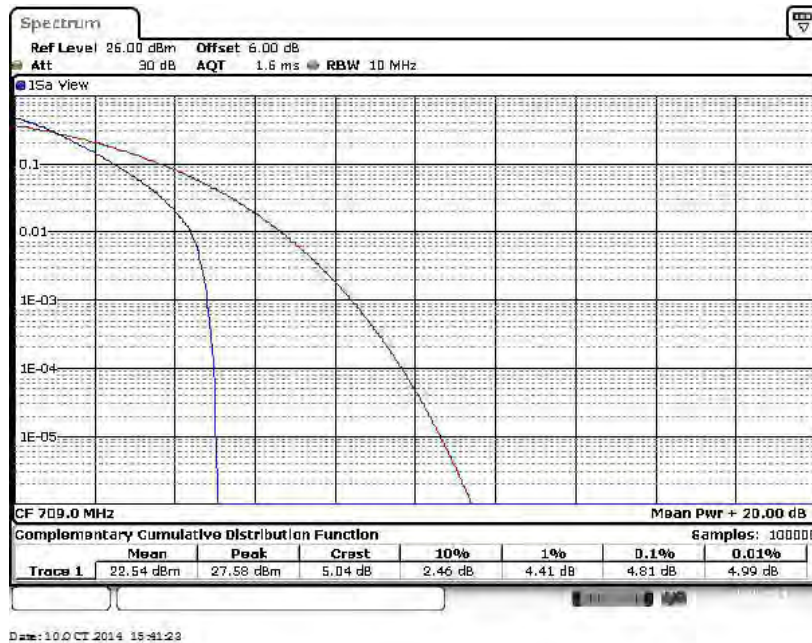



Peak-to-Average Ratio on LTE Band 17
10MHz / QPSK in Ch. 23790 (50RB Size)

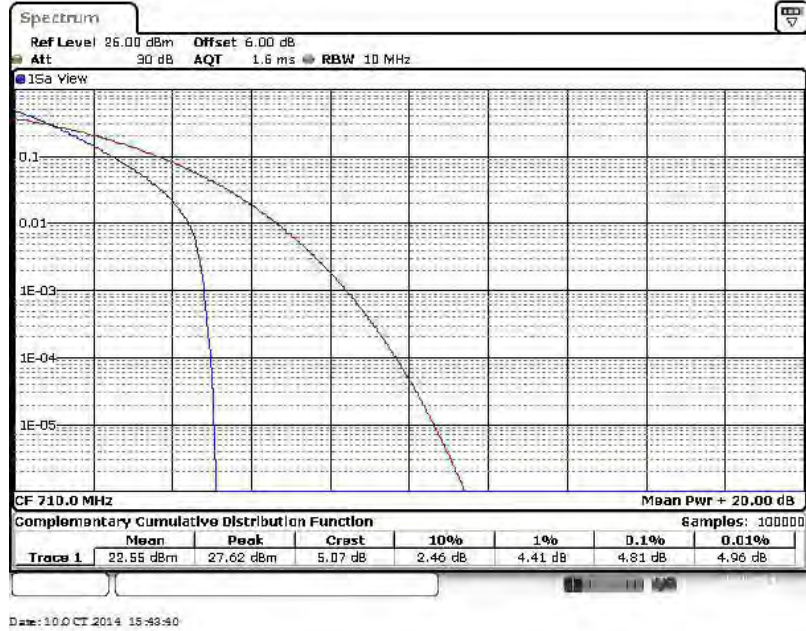

Peak-to-Average Ratio on LTE Band 17
10MHz / QPSK in Ch. 23800 (50RB Size)

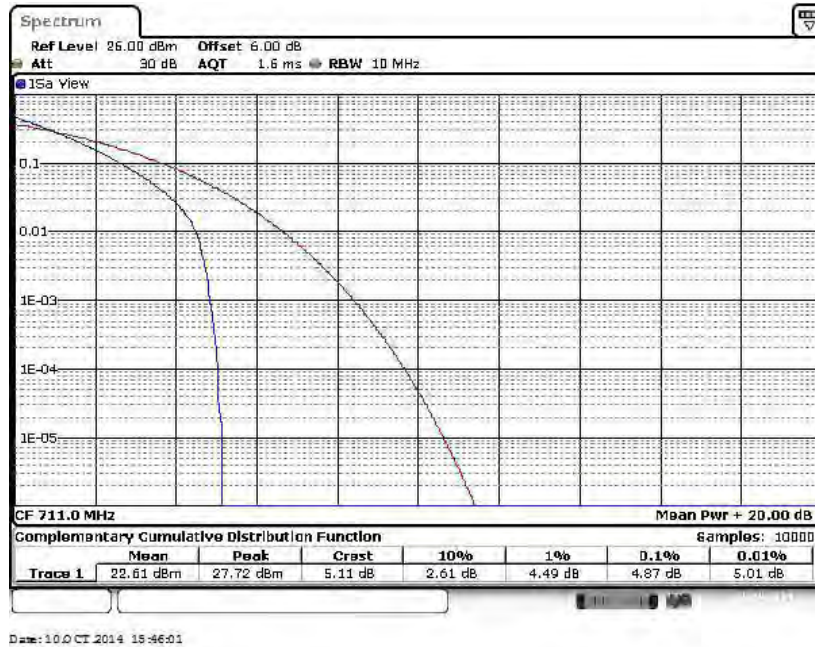



Peak-to-Average Ratio on LTE Band 17

10MHz / 16QAM in Ch. 23780 (1RB Size)

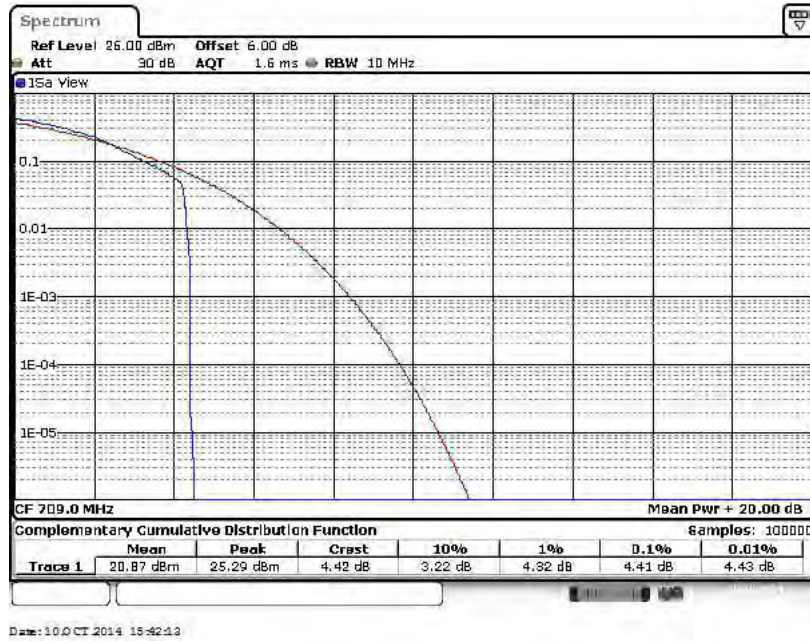

Peak-to-Average Ratio on LTE Band 17

10MHz / 16QAM in Ch. 23790 (1RB Size)

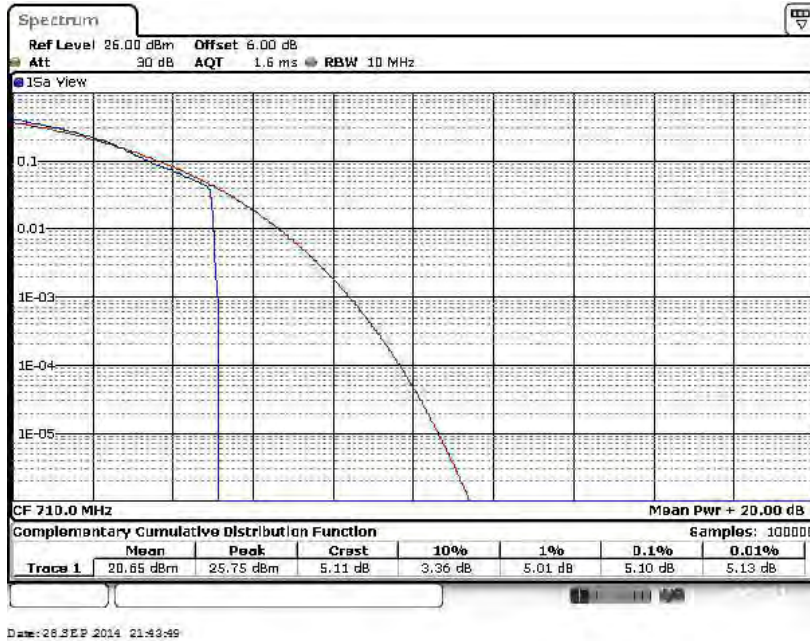



Peak-to-Average Ratio on LTE Band 17

10MHz / 16QAM in Ch. 23800 (1RB Size)

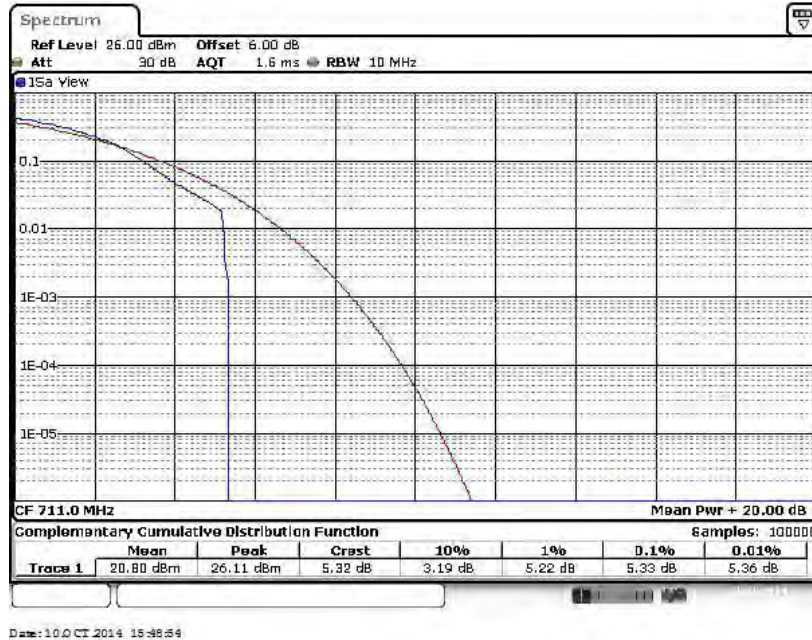

Peak-to-Average Ratio on LTE Band 17

10MHz / 16QAM in Ch. 23780 (50RB Size)

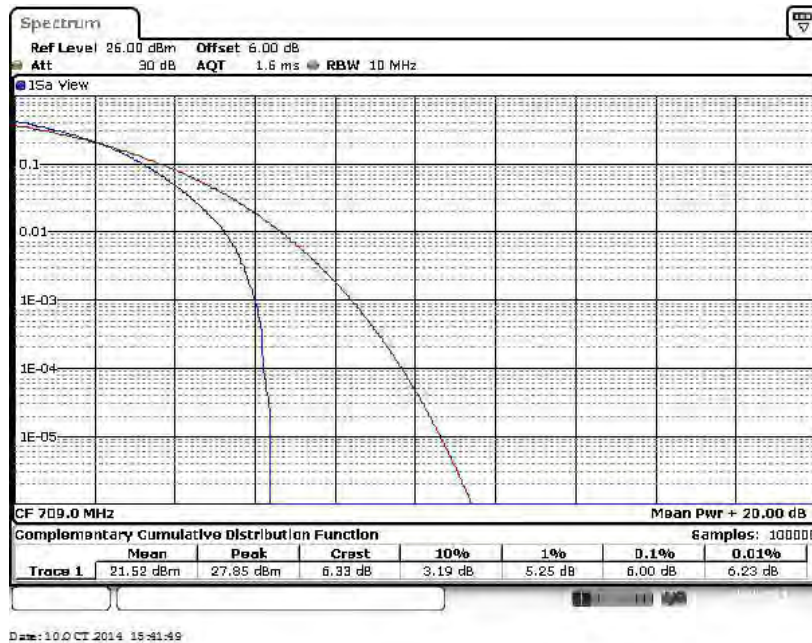



Peak-to-Average Ratio on LTE Band 17
10MHz / 16QAM in Ch. 23790 (50RB Size)

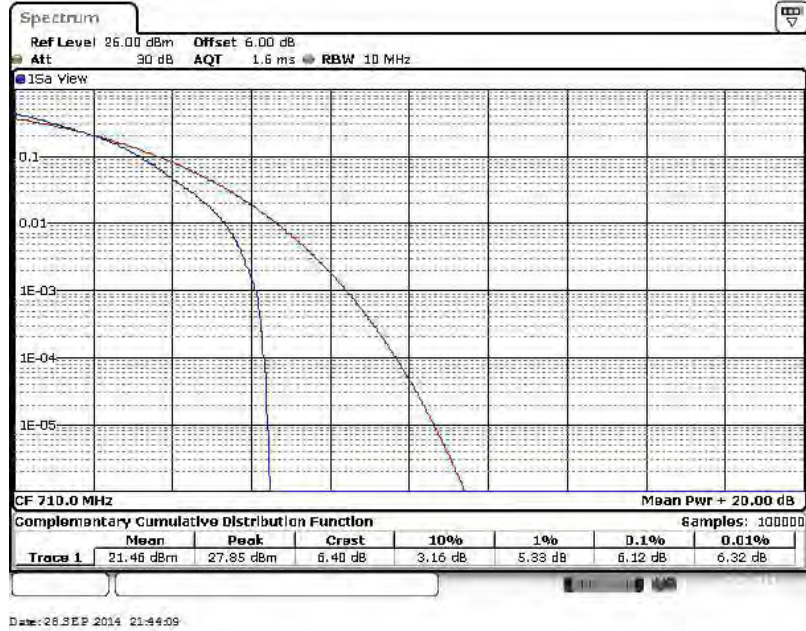

Peak-to-Average Ratio on LTE Band 17
10MHz / 16QAM in Ch. 23800 (50RB Size)

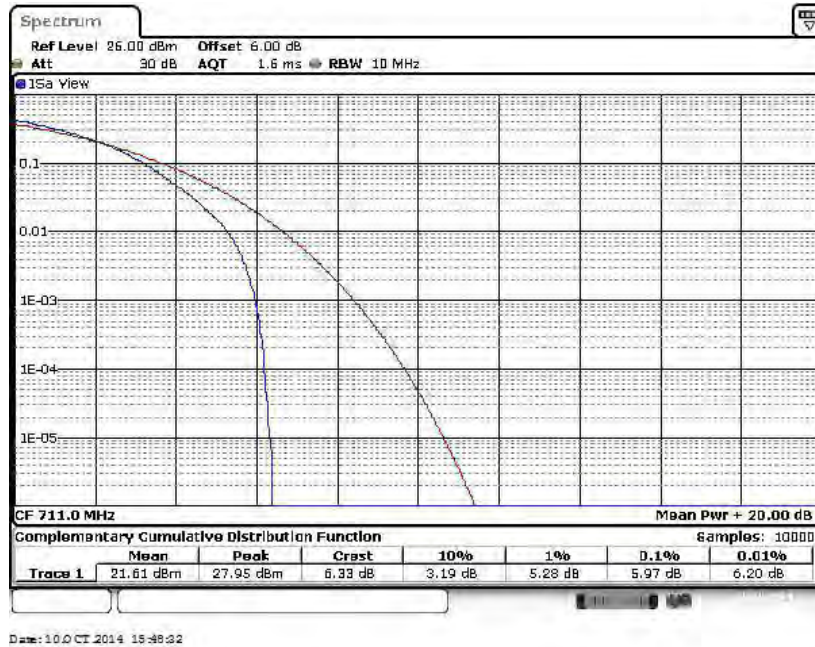



3.3 Effective Radiated Power and Equivalent Isotropic Radiated Power Measurement

3.3.1 Description of the ERP/EIRP Measurement

Effective radiated power output measurements by substitution method according to ANSI / TIA / EIA-603-C-2004, and the spectrum analyzer configuration follows KDB 971168 D01 Power Meas. License Digital Systems v02r01. Mobile and portable (hand-held) stations operating are limited to average ERP of 3 watts with LTE band 17.

Equivalent isotropic radiated power output measurements by substitution method according to ANSI / TIA / EIA-603-C-2004, and the spectrum analyzer configuration follows KDB 971168 D01 Power Meas. License Digital Systems v02r01. Mobile and portable (hand-held) stations operating are limited to average EIRP of 2 watts with LTE band 2 / 7 and 1 watt with LTE band 4.

3.3.2 Measuring Instruments

The measuring equipment is listed in the section 4 of this test report.

3.3.3 Test Procedures

1. The EUT was placed on a turntable with 1.5 meter height in a fully anechoic chamber.
2. The EUT was set at 3 meters from the receiving antenna, which was mounted on the antenna tower.
3. The radiated emission at the fundamental frequency was measured at 3 m with a test antenna and a spectrum analyzer which used a channel power option across EUT's signal bandwidth per section 4.0 of KDB 971168 D01.
4. The table was rotated 360 degrees to determine the position of the highest radiated power.
5. The height of the receiving antenna is adjusted to look for the maximum ERP/EIRP.
6. Taking the record of maximum ERP/EIRP.
7. A dipole antenna was substituted in place of the EUT and was driven by a signal generator.
8. The conducted power at the terminal of the dipole antenna is measured.
9. Repeat step 3 to step 5 to get the maximum ERP/EIRP of the substitution antenna.
10. $ERP/EIRP = P_s + E_t - E_s + G_s = P_s + R_t - R_s + G_s$

P_s (dBm) : Input power to substitution antenna.

G_s (dBi or dBd) : Substitution antenna Gain.

$E_t = R_t + AF$

$E_s = R_s + AF$

AF (dB/m) : Receive antenna factor

R_t : The highest received signal in spectrum analyzer for EUT.

R_s : The highest received signal in spectrum analyzer for substitution antenna.

3.3.4 Test Setup

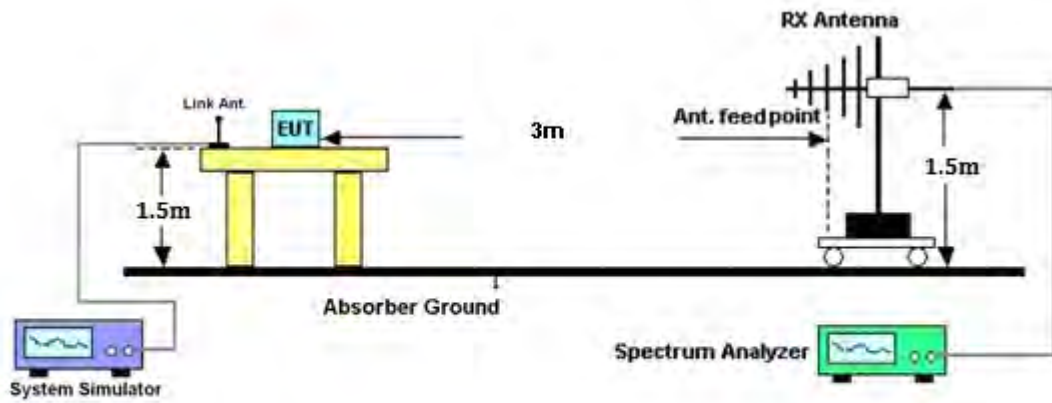



3.3.5 Test Result of ERP/EIRP

LTE Band 2 Radiated Power EIRP								
LTE Band	Channel BW (MHz)	Modulation	RB Configuration		Freq. (MHz)	EIRP (dBm)	EIRP (W)	H/V
			RB Size	RB Offset				
2	1.4	QPSK	1	0	1850.7	23.86	0.2432	H
2	1.4	QPSK	1	0	1880	23.44	0.2208	H
2	1.4	QPSK	1	0	1909.3	22.01	0.1589	H
2	1.4	QPSK	1	0	1850.7	24.07	0.2553	V
2	1.4	QPSK	1	0	1880	23.40	0.2188	V
2	1.4	QPSK	1	0	1909.3	22.08	0.1614	V
2	1.4	16QAM	1	0	1850.7	22.90	0.1950	H
2	1.4	16QAM	1	0	1880	22.58	0.1811	H
2	1.4	16QAM	1	0	1909.3	20.91	0.1233	H
2	1.4	16QAM	1	0	1850.7	23.03	0.2009	V
2	1.4	16QAM	1	0	1880	22.43	0.1750	V
2	1.4	16QAM	1	0	1909.3	21.11	0.1291	V
2	20	QPSK	1	0	1860	23.59	0.2286	H
2	20	QPSK	1	0	1880	23.59	0.2286	H
2	20	QPSK	1	0	1900	22.83	0.1919	H
2	20	QPSK	1	0	1860	23.68	0.2333	V
2	20	QPSK	1	0	1880	23.72	0.2355	V
2	20	QPSK	1	0	1900	23.02	0.2004	V
2	20	16QAM	1	49	1860	22.77	0.1892	H
2	20	16QAM	1	0	1880	22.68	0.1854	H
2	20	16QAM	1	49	1900	21.43	0.1390	H
2	20	16QAM	1	49	1860	22.78	0.1897	V
2	20	16QAM	1	0	1880	22.73	0.1875	V
2	20	16QAM	1	49	1900	21.47	0.1403	V



LTE Band 4 Radiated Power EIRP								
LTE Band	Channel BW (MHz)	Modulation	RB Configuration		Freq. (MHz)	EIRP (dBm)	EIRP (W)	H/V
			RB Size	RB Offset				
4	1.4	QPSK	1	2	1710.7	22.83	0.1919	H
4	1.4	QPSK	1	2	1732.5	22.77	0.1892	H
4	1.4	QPSK	1	2	1754.3	22.86	0.1932	H
4	1.4	QPSK	1	2	1710.7	22.53	0.1791	V
4	1.4	QPSK	1	2	1732.5	22.68	0.1854	V
4	1.4	QPSK	1	2	1754.3	23.04	0.2014	V
4	1.4	16QAM	1	2	1710.7	21.80	0.1514	H
4	1.4	16QAM	1	2	1732.5	21.74	0.1493	H
4	1.4	16QAM	1	2	1754.3	21.81	0.1517	H
4	1.4	16QAM	1	2	1710.7	21.87	0.1538	V
4	1.4	16QAM	1	2	1732.5	21.61	0.1449	V
4	1.4	16QAM	1	2	1754.3	21.97	0.1574	V
4	20	QPSK	1	0	1720	22.65	0.1841	H
4	20	QPSK	1	0	1732.5	22.83	0.1919	H
4	20	QPSK	1	0	1745	22.71	0.1866	H
4	20	QPSK	1	0	1720	22.18	0.1652	V
4	20	QPSK	1	0	1732.5	22.63	0.1832	V
4	20	QPSK	1	0	1745	22.86	0.1932	V
4	20	16QAM	1	49	1720	21.74	0.1493	H
4	20	16QAM	1	49	1732.5	21.77	0.1503	H
4	20	16QAM	1	49	1745	21.41	0.1384	H
4	20	16QAM	1	49	1720	21.73	0.1489	V
4	20	16QAM	1	49	1732.5	21.64	0.1459	V
4	20	16QAM	1	49	1745	21.93	0.1560	V



LTE Band 7 Radiated Power EIRP								
LTE Band	Channel BW (MHz)	Modulation	RB Configuration		Freq. (MHz)	EIRP (dBm)	EIRP (W)	H/V
			RB Size	RB Offset				
7	5	QPSK	1	0	2502.5	26.55	0.4519	H
7	5	QPSK	1	24	2535	25.73	0.3741	H
7	5	QPSK	1	24	2567.5	24.04	0.2535	H
7	5	QPSK	1	0	2502.5	26.54	0.4508	V
7	5	QPSK	1	24	2535	25.73	0.3741	V
7	5	QPSK	1	24	2567.5	23.94	0.2477	V
7	5	16QAM	1	0	2502.5	25.42	0.3483	H
7	5	16QAM	1	0	2535	24.68	0.2938	H
7	5	16QAM	1	0	2567.5	23.20	0.2089	H
7	5	16QAM	1	0	2502.5	25.45	0.3508	V
7	5	16QAM	1	0	2535	24.69	0.2944	V
7	5	16QAM	1	0	2567.5	23.12	0.2051	V
7	20	QPSK	1	49	2510	26.41	0.4375	H
7	20	QPSK	1	49	2535	25.69	0.3707	H
7	20	QPSK	1	49	2560	24.79	0.3013	H
7	20	QPSK	1	49	2510	26.37	0.4335	V
7	20	QPSK	1	49	2535	25.65	0.3673	V
7	20	QPSK	1	49	2560	24.79	0.3013	V
7	20	16QAM	1	49	2510	25.28	0.3373	H
7	20	16QAM	1	49	2535	25.03	0.3184	H
7	20	16QAM	1	49	2560	23.76	0.2377	H
7	20	16QAM	1	49	2510	25.33	0.3412	V
7	20	16QAM	1	49	2535	25.08	0.3221	V
7	20	16QAM	1	49	2560	23.72	0.2355	V



LTE Band 17 Radiated Power ERP								
LTE Band	Channel BW (MHz)	Modulation	RB Configuration		Freq. (MHz)	ERP (dBm)	ERP (W)	H/V
			RB Size	RB Offset				
17	5	QPSK	1	0	706.5	17.46	0.0557	H
17	5	QPSK	1	0	710	16.74	0.0472	H
17	5	QPSK	1	0	713.5	17.48	0.0560	H
17	5	QPSK	1	0	706.5	4.96	0.0031	V
17	5	QPSK	1	0	710	5.19	0.0033	V
17	5	QPSK	1	0	713.5	5.31	0.0034	V
17	5	16QAM	1	0	706.5	16.70	0.0468	H
17	5	16QAM	1	0	710	15.97	0.0395	H
17	5	16QAM	1	0	713.5	16.72	0.0470	H
17	5	16QAM	1	0	706.5	4.22	0.0026	V
17	5	16QAM	1	0	710	4.41	0.0028	V
17	5	16QAM	1	0	713.5	4.49	0.0028	V
17	10	QPSK	1	24	709	17.11	0.0514	H
17	10	QPSK	1	24	710	17.21	0.0526	H
17	10	QPSK	1	24	711	17.45	0.0556	H
17	10	QPSK	1	24	709	5.52	0.0036	V
17	10	QPSK	1	24	710	5.39	0.0035	V
17	10	QPSK	1	24	711	5.42	0.0035	V
17	10	16QAM	1	24	709	16.35	0.0432	H
17	10	16QAM	1	24	710	16.38	0.0435	H
17	10	16QAM	1	24	711	16.65	0.0462	H
17	10	16QAM	1	24	709	4.77	0.0030	V
17	10	16QAM	1	24	710	4.63	0.0029	V
17	10	16QAM	1	24	711	4.59	0.0029	V

3.4 99% Occupied Bandwidth and 26dB Bandwidth Measurement

3.4.1 Description of 99% Occupied Bandwidth and 26dB Bandwidth Measurement

The occupied bandwidth is the width of a frequency band such that, below the lower and above the upper frequency limits, the mean powers emitted are each equal to a specified percentage 0.5% of the total mean transmitted power.

The 26 dB emission bandwidth is defined as the frequency range between two points, one above and one below the carrier frequency, at which the spectral density of the emission is attenuated 26 dB below the maximum in-band spectral density of the modulated signal. Spectral density (power per unit bandwidth) is to be measured with a detector of resolution bandwidth equal to approximately 1.0% of the emission bandwidth.

3.4.2 Measuring Instruments

The measuring equipment is listed in the section 4 of this test report.

3.4.3 Test Procedures

1. The EUT was connected to spectrum analyzer and system simulator via a power divider.
2. The 26dB and 99% occupied bandwidth (BW) of the middle channel for the highest RF power with full RB sizes were measured.

3.4.4 Test Setup

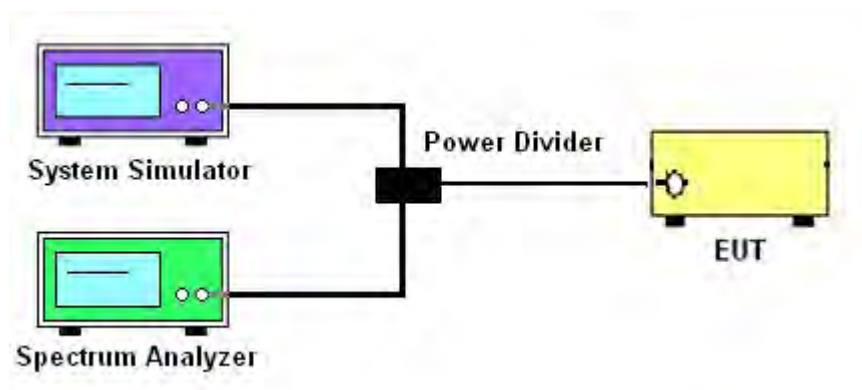



3.4.5 Test Result of 99% Occupied Bandwidth and 26dB Bandwidth

Modes	LTE Band 7			
BW / Mod.	5MHz / QPSK	5MHz / 16QAM	10MHz / QPSK	10MHz / 16QAM
99% OBW (MHz)	4.486	4.496	9.091	8.991
26dB BW (MHz)	5.015	5.015	9.990	9.950
BW / Mod.	15MHz / QPSK	15MHz / 16QAM	20MHz / QPSK	20MHz / 16QAM
99% OBW (MHz)	13.457	13.427	18.302	18.262
26dB BW (MHz)	14.685	14.655	20.340	20.140

Modes	LTE Band 2			
BW / Mod.	1.4MHz / QPSK	1.4MHz / 16QAM	3MHz / QPSK	3MHz / 16QAM
99% OBW (MHz)	1.097	1.097	2.715	2.727
26dB BW (MHz)	1.290	1.290	3.045	3.045
BW / Mod.	5MHz / QPSK	5MHz / 16QAM	10MHz / QPSK	10MHz / 16QAM
99% OBW (MHz)	4.486	4.496	9.031	9.011
26dB BW (MHz)	5.015	5.025	10.110	10.090
BW / Mod.	15MHz / QPSK	15MHz / 16QAM	20MHz / QPSK	20MHz / 16QAM
99% OBW (MHz)	13.457	13.427	18.342	18.382
26dB BW (MHz)	14.745	14.655	20.300	20.380

Modes	LTE Band 4			
BW / Mod.	1.4MHz / QPSK	1.4MHz / 16QAM	3MHz / QPSK	3MHz / 16QAM
99% OBW (MHz)	1.099	1.099	2.727	2.727
26dB BW (MHz)	1.304	1.292	3.051	3.051
BW / Mod.	5MHz / QPSK	5MHz / 16QAM	10MHz / QPSK	10MHz / 16QAM
99% OBW (MHz)	4.496	4.496	9.071	8.991
26dB BW (MHz)	5.035	5.025	9.950	9.970
BW / Mod.	15MHz / QPSK	15MHz / 16QAM	20MHz / QPSK	20MHz / 16QAM
99% OBW (MHz)	13.487	13.487	18.422	18.302
26dB BW (MHz)	14.685	14.685	20.380	20.460



Modes	LTE Band 17				
	BW / Mod.	5MHz / QPSK	5MHz / 16QAM	10MHz / QPSK	10MHz / 16QAM
99% OBW (MHz)		4.486	4.486	9.031	9.031
26dB BW (MHz)		5.025	5.015	9.970	10.070

Note:

The maximum RB configurations of the 99% Occupied Bandwidth and 26dB Bandwidth summary as below:

- BW1.4MHz RB setting : RB Size 6, RB offset 0
- BW3.0MHz RB setting : RB Size 15, RB offset 0
- BW5.0MHz RB setting : RB Size 25, RB offset 0
- BW10MHz RB setting : RB Size 50, RB offset 0
- BW15MHz RB setting : RB Size 75, RB offset 0
- BW20MHz RB setting : RB Size 100, RB offset 0



3.4.6 Test Result (Plots) of 99% Occupied Bandwidth and 26dB Bandwidth

Band :	LTE Band 7	BW / Mod. :	5MHz / QPSK
--------	------------	-------------	-------------

99% Occupied Bandwidth Plot on Channel 21100

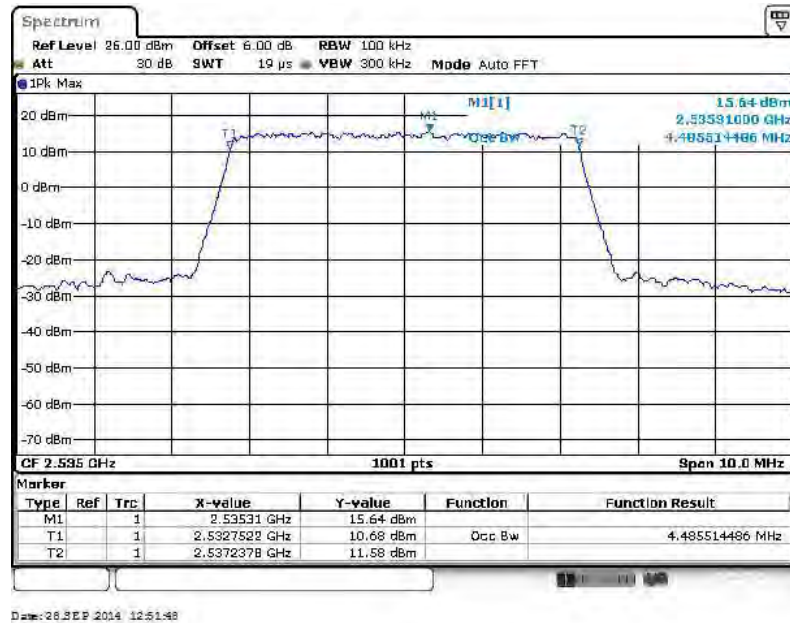

26dB Bandwidth Plot on Channel 21100

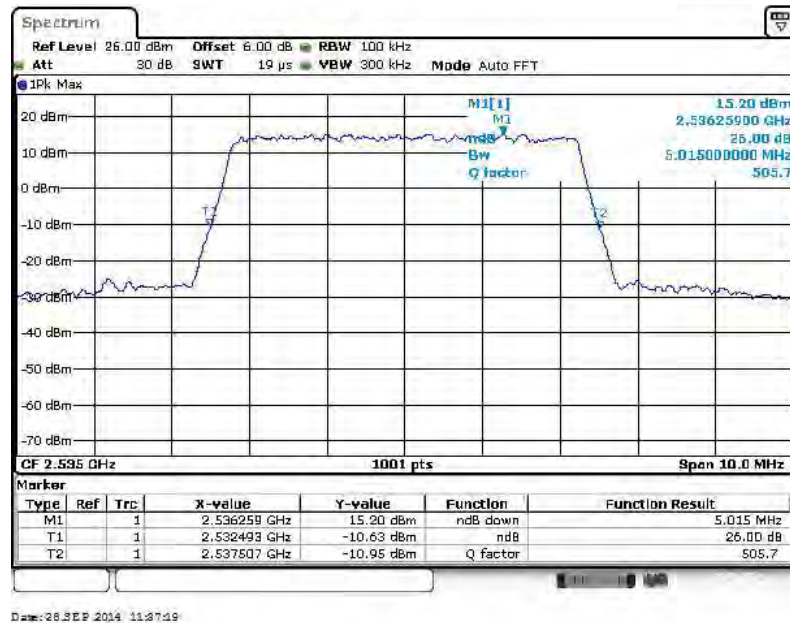



Band :	LTE Band 7	BW / Mod. :	5MHz / 16QAM
--------	------------	-------------	--------------

99% Occupied Bandwidth Plot on Channel 21100

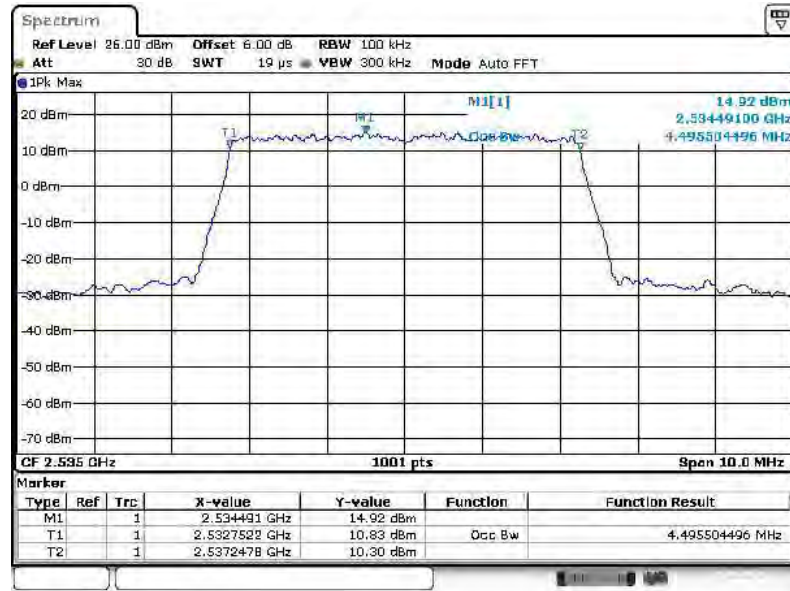

Date: 28 SEP 2014 12:52:29

26dB Bandwidth Plot on Channel 21100

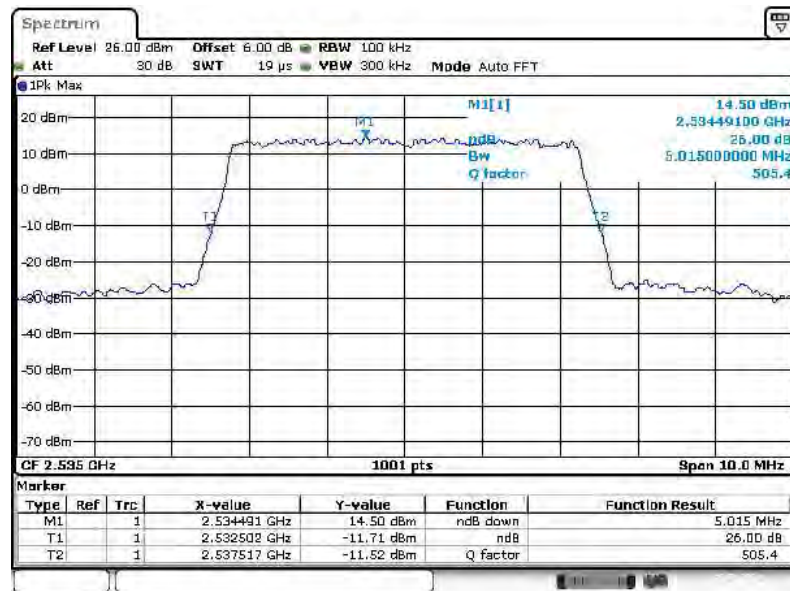

Date: 28 SEP 2014 11:27:43



Band :	LTE Band 7	BW / Mod. :	10MHz / QPSK
--------	------------	-------------	--------------

99% Occupied Bandwidth Plot on Channel 21100

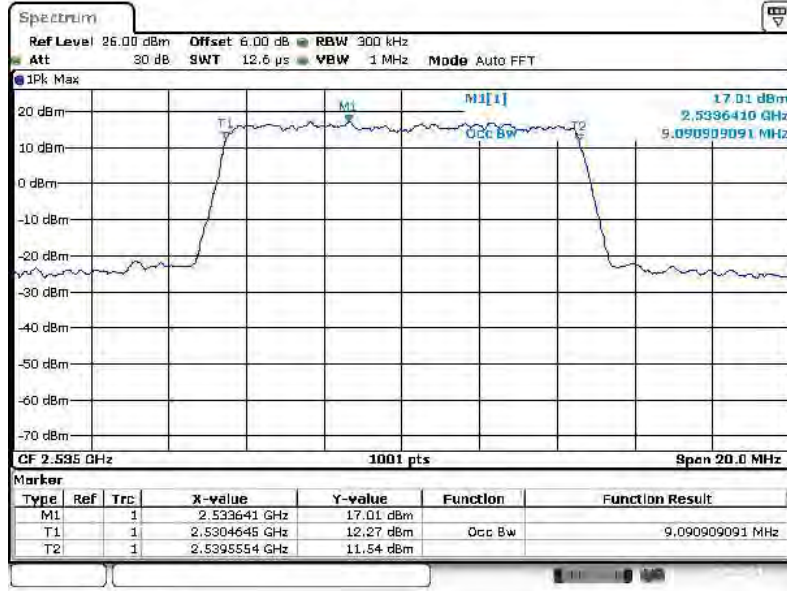

Date: 28 SEP 2014 12:53:26

26dB Bandwidth Plot on Channel 21100

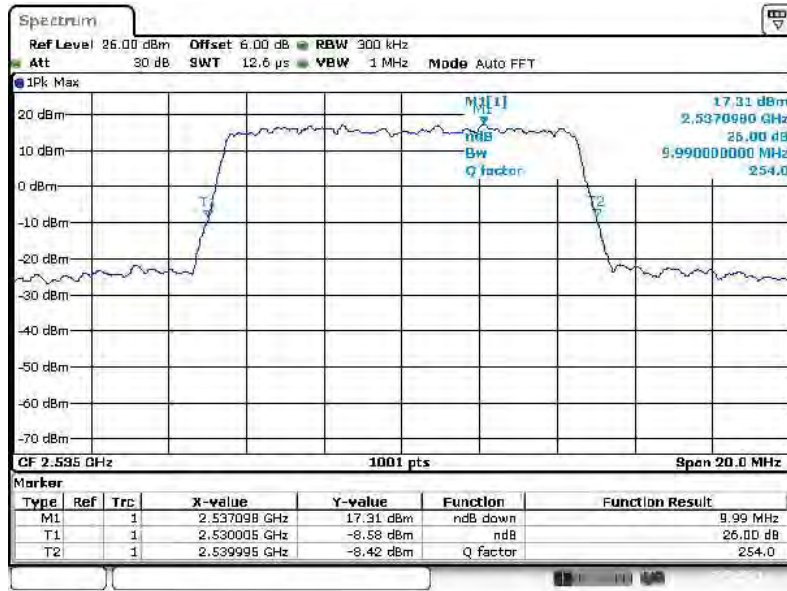

Date: 28 SEP 2014 11:54:27



Band :	LTE Band 7	BW / Mod. :	10MHz / 16QAM
--------	------------	-------------	---------------

99% Occupied Bandwidth Plot on Channel 21100

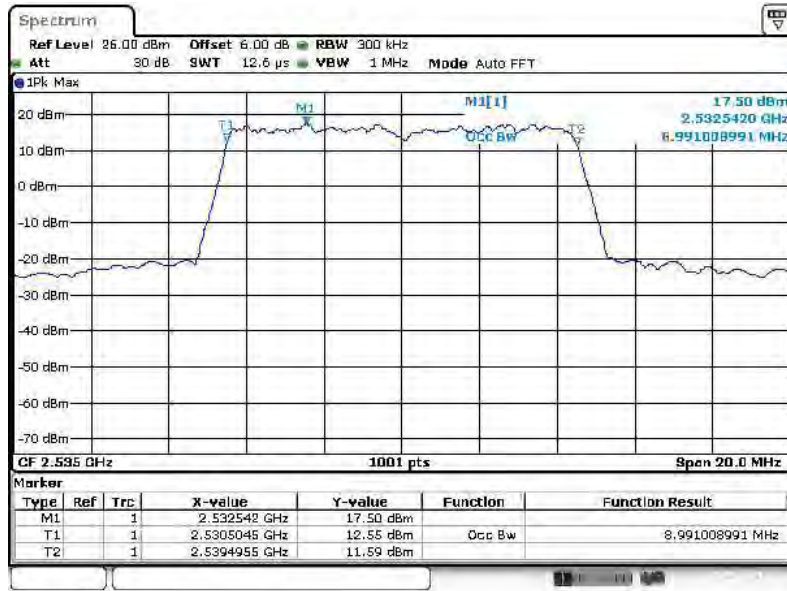

Date: 28 SEP 2014 12:55:46

26dB Bandwidth Plot on Channel 21100

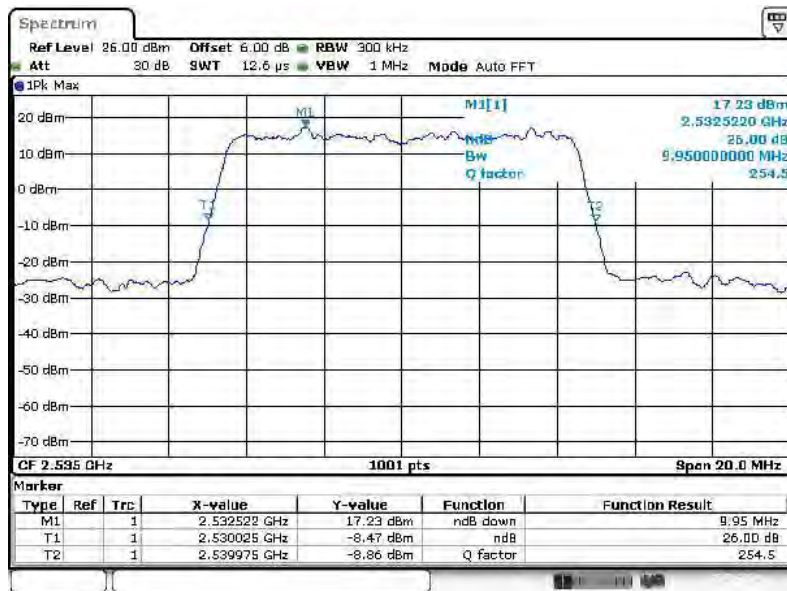

Date: 28 SEP 2014 11:55:01



Band :	LTE Band 7	BW / Mod. :	15MHz / QPSK
--------	------------	-------------	--------------

99% Occupied Bandwidth Plot on Channel 21100

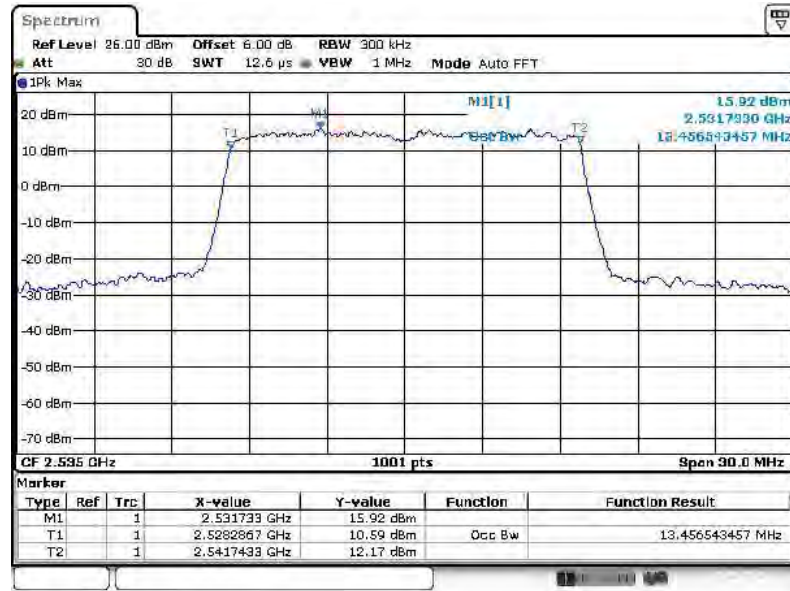

Date: 28 SEP 2014 12:56:26

26dB Bandwidth Plot on Channel 21100

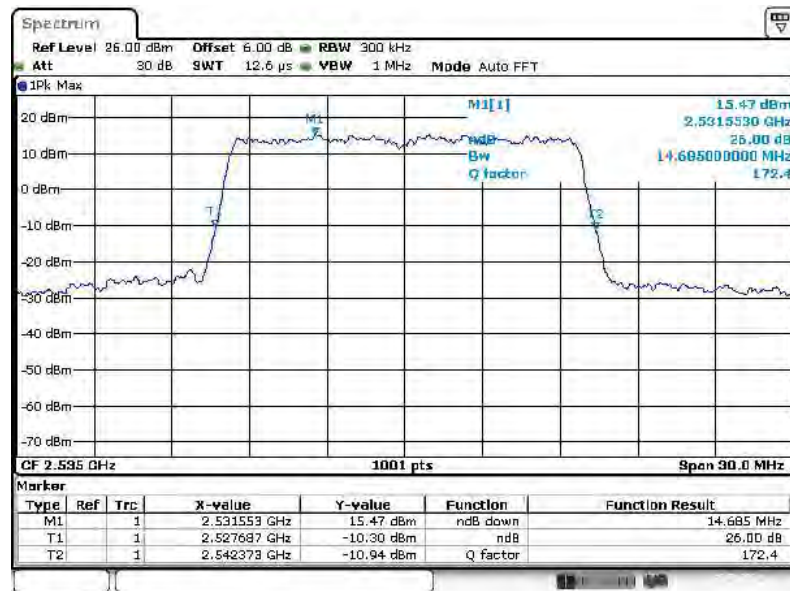

Date: 28 SEP 2014 12:51:55



Band :	LTE Band 7	BW / Mod. :	15MHz / 16QAM
--------	------------	-------------	---------------

99% Occupied Bandwidth Plot on Channel 21100

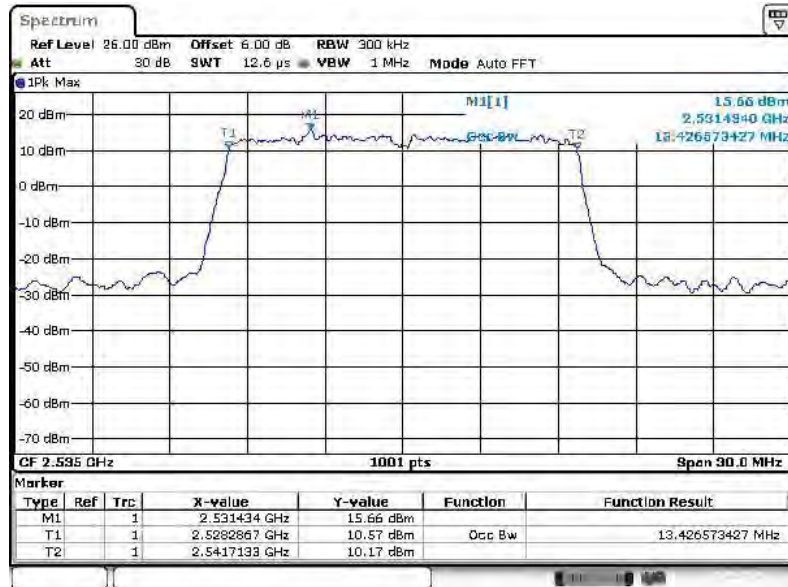

Date: 28 SEP 2014 12:57:26

26dB Bandwidth Plot on Channel 21100

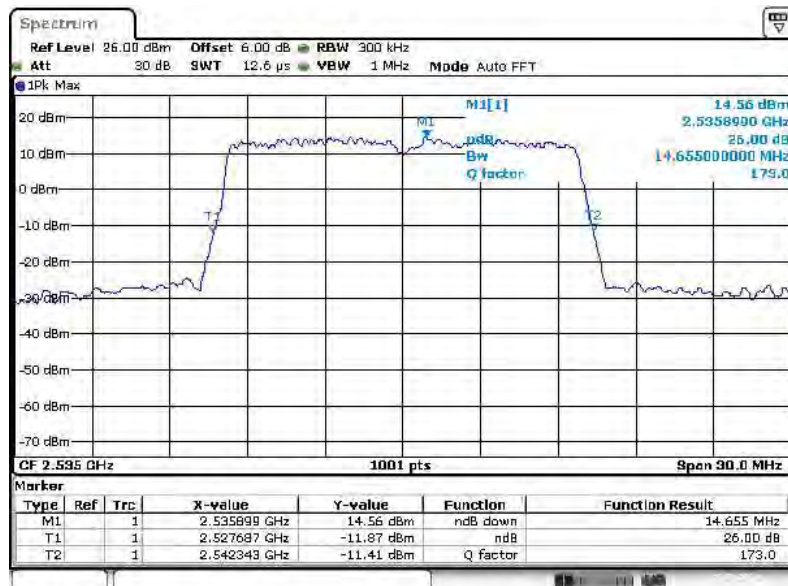

Date: 28 SEP 2014 12:12:19



Band :	LTE Band 7	BW / Mod. :	20MHz / QPSK
--------	------------	-------------	--------------

99% Occupied Bandwidth Plot on Channel 21100

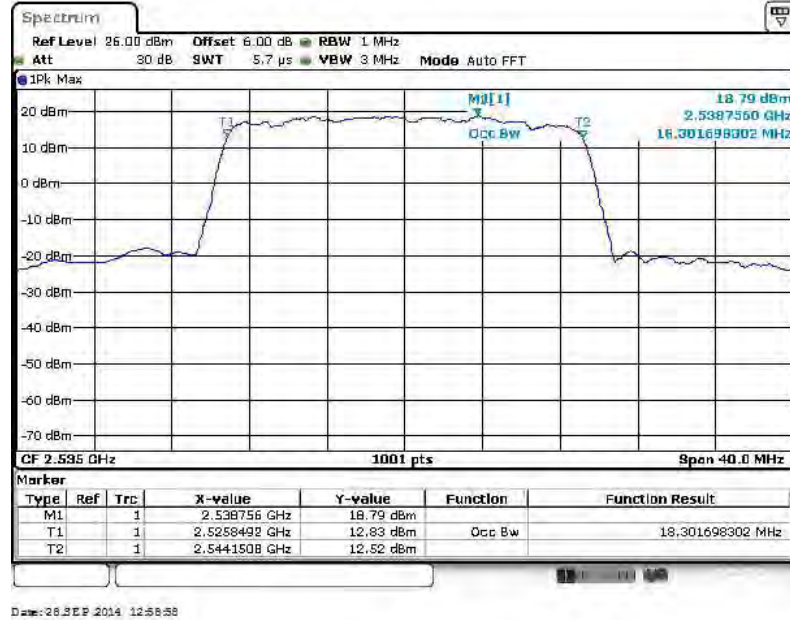

26dB Bandwidth Plot on Channel 21100

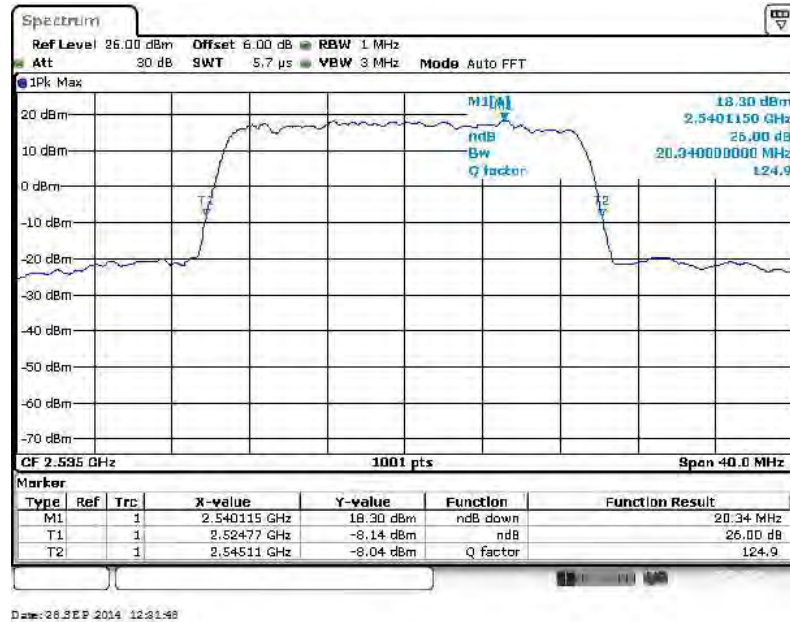



Band :	LTE Band 7	BW / Mod. :	20MHz / 16QAM
--------	------------	-------------	---------------

99% Occupied Bandwidth Plot on Channel 21100

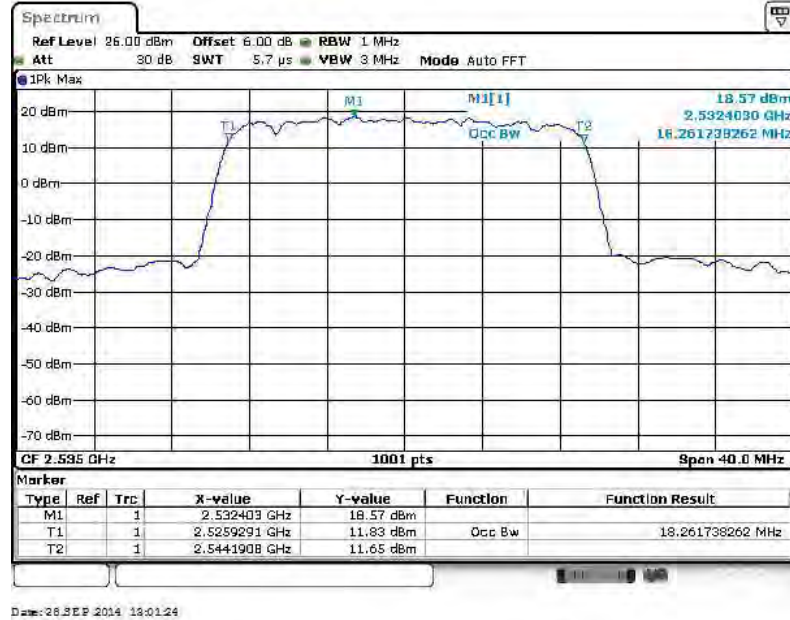

26dB Bandwidth Plot on Channel 21100

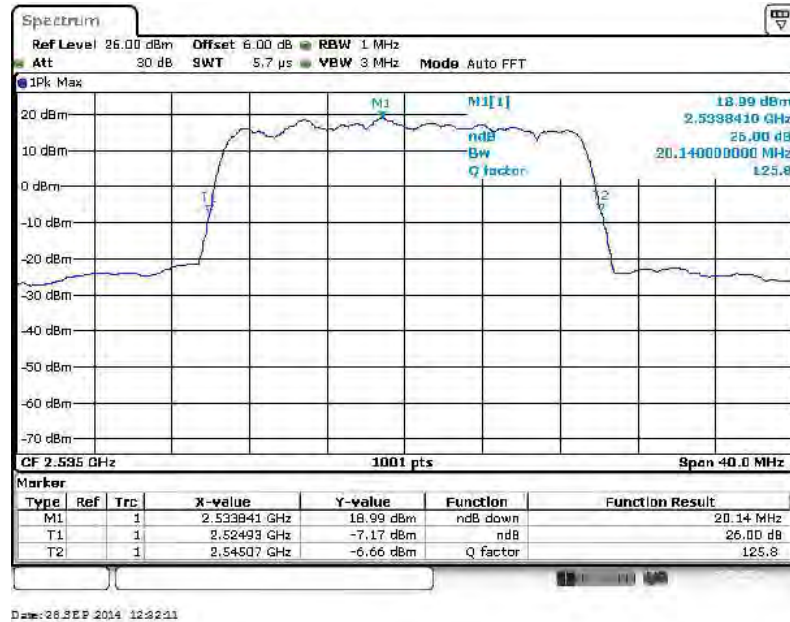



Band :	LTE Band 2	BW / Mod. :	1.4MHz / QPSK
--------	------------	-------------	---------------

99% Occupied Bandwidth Plot on Channel 18900

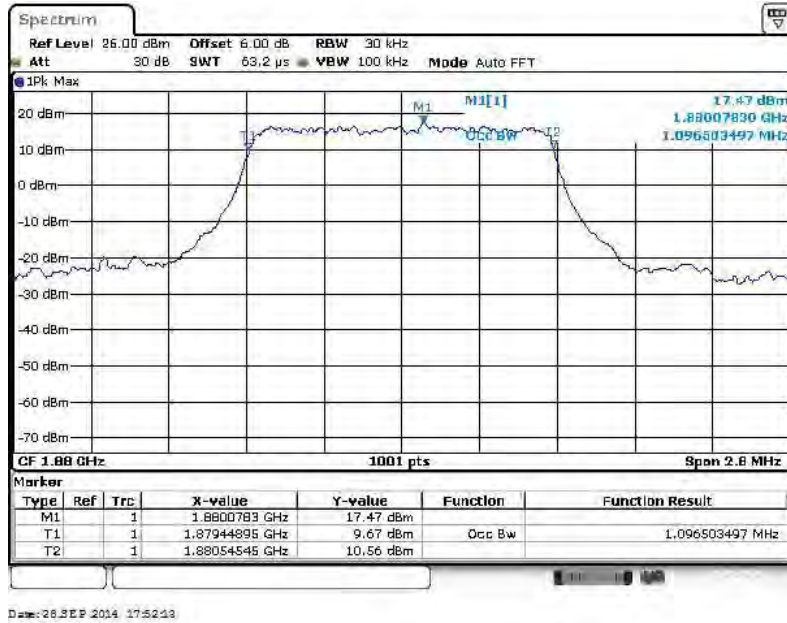

26dB Bandwidth Plot on Channel 18900

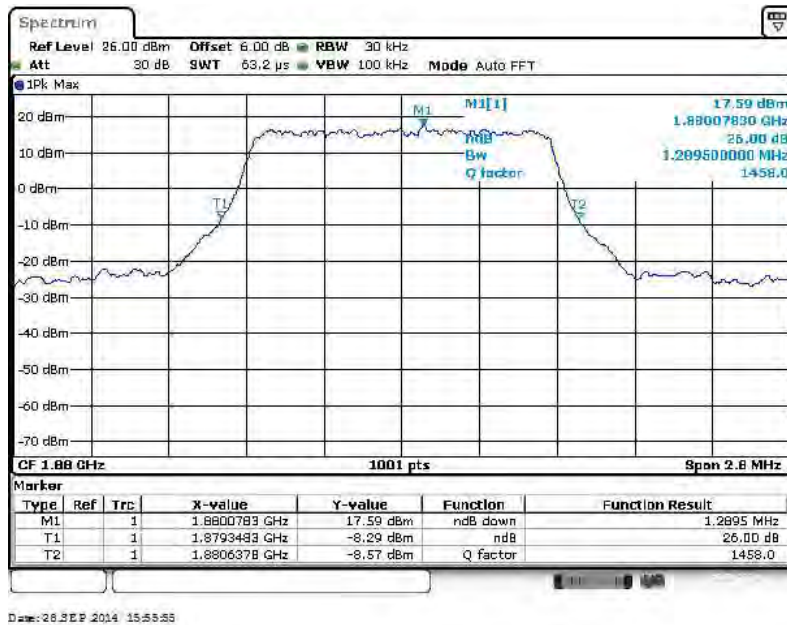



Band :	LTE Band 2	BW / Mod. :	1.4MHz / 16QAM
--------	------------	-------------	----------------

99% Occupied Bandwidth Plot on Channel 18900

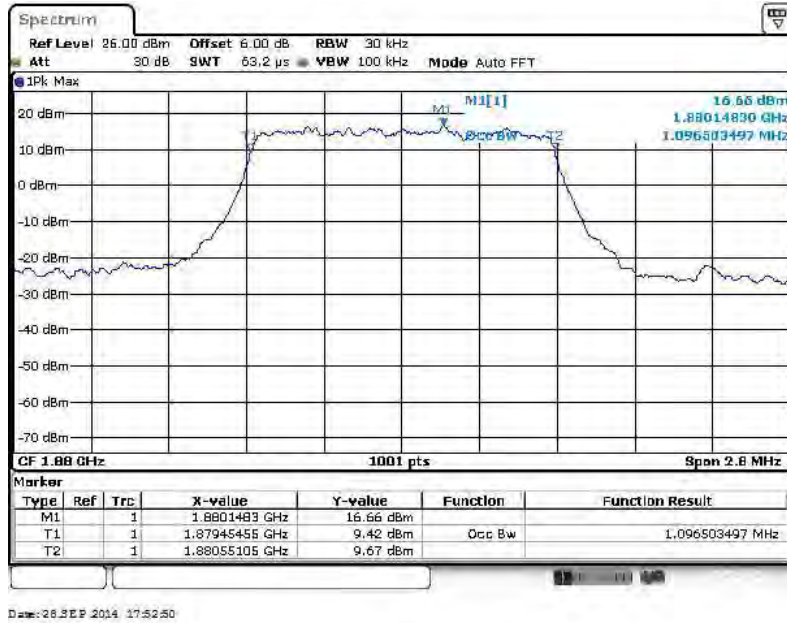

26dB Bandwidth Plot on Channel 18900

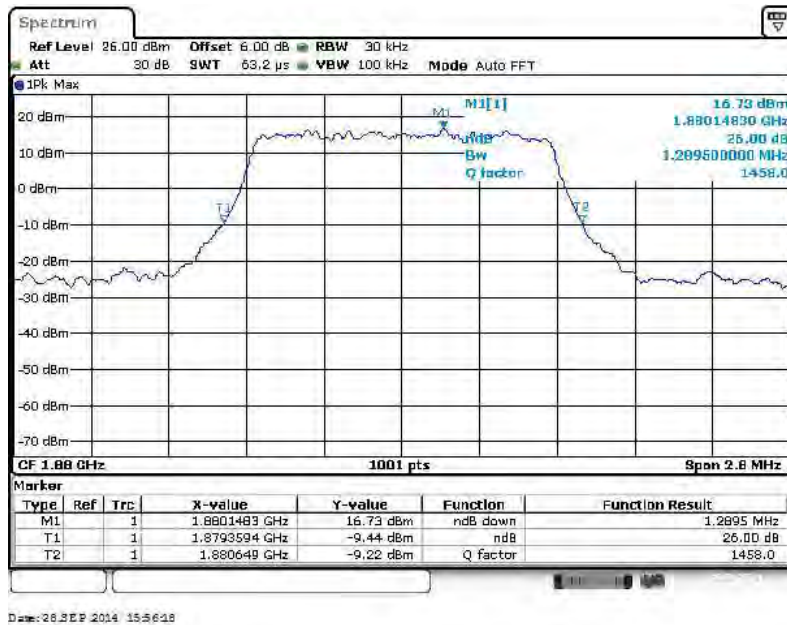



Band :	LTE Band 2	BW / Mod. :	3MHz / QPSK
--------	------------	-------------	-------------

99% Occupied Bandwidth Plot on Channel 18900

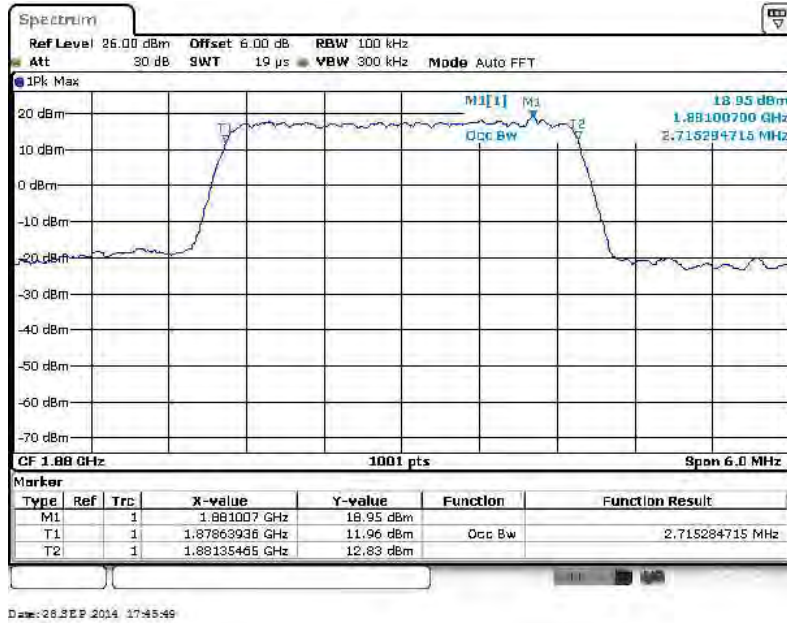

26dB Bandwidth Plot on Channel 18900

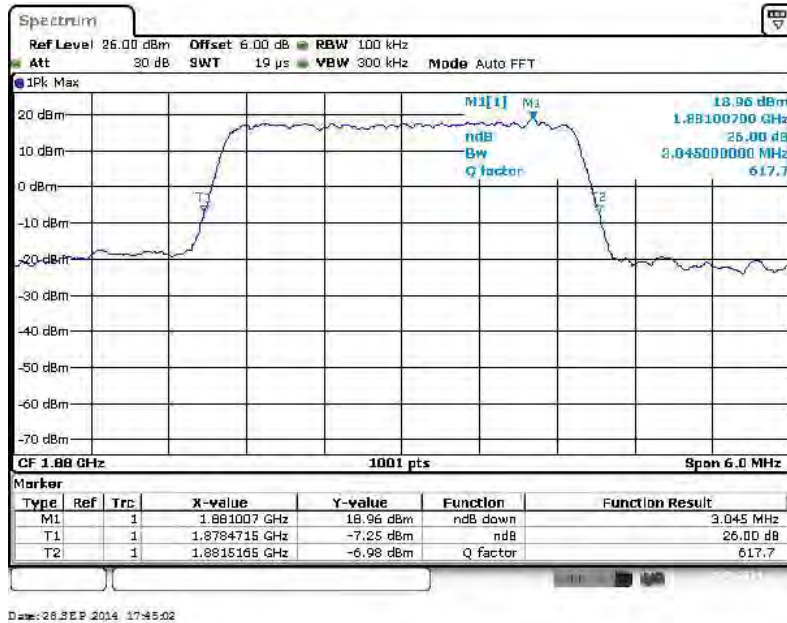



Band :	LTE Band 2	BW / Mod. :	3MHz / 16QAM
--------	------------	-------------	--------------

99% Occupied Bandwidth Plot on Channel 18900

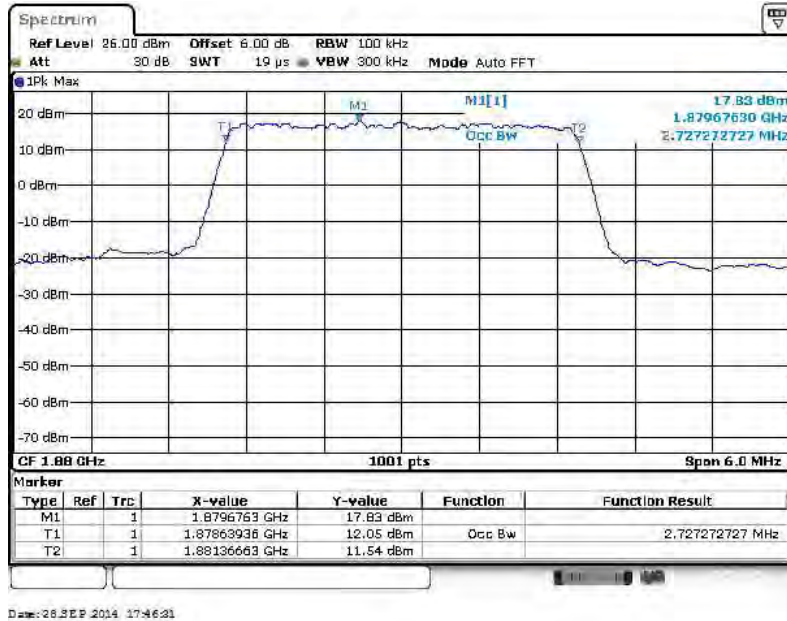

26dB Bandwidth Plot on Channel 18900

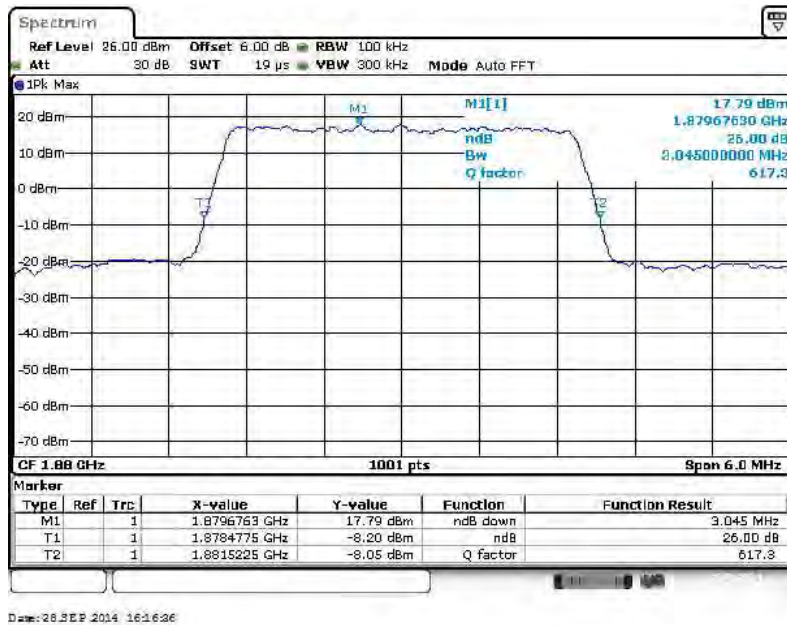



Band :	LTE Band 2	BW / Mod. :	5MHz / QPSK
--------	------------	-------------	-------------

99% Occupied Bandwidth Plot on Channel 18900

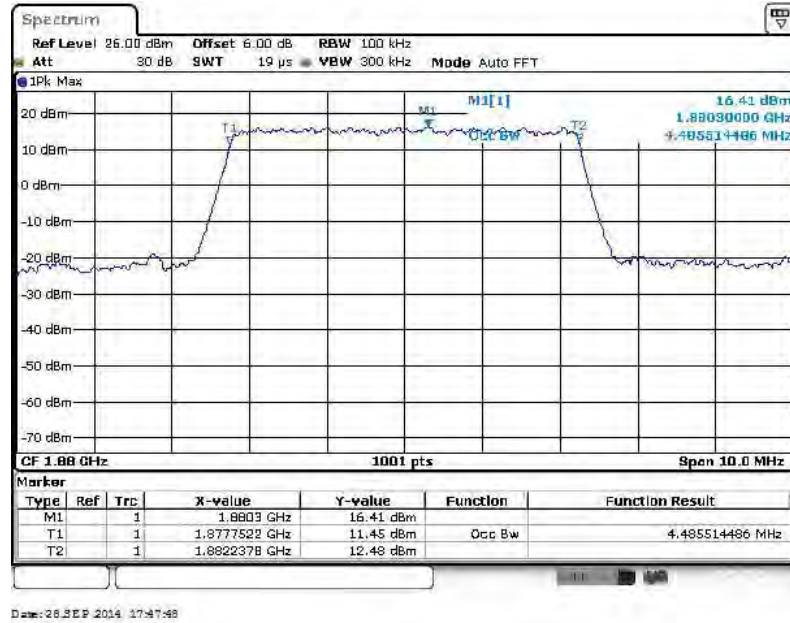

26dB Bandwidth Plot on Channel 18900

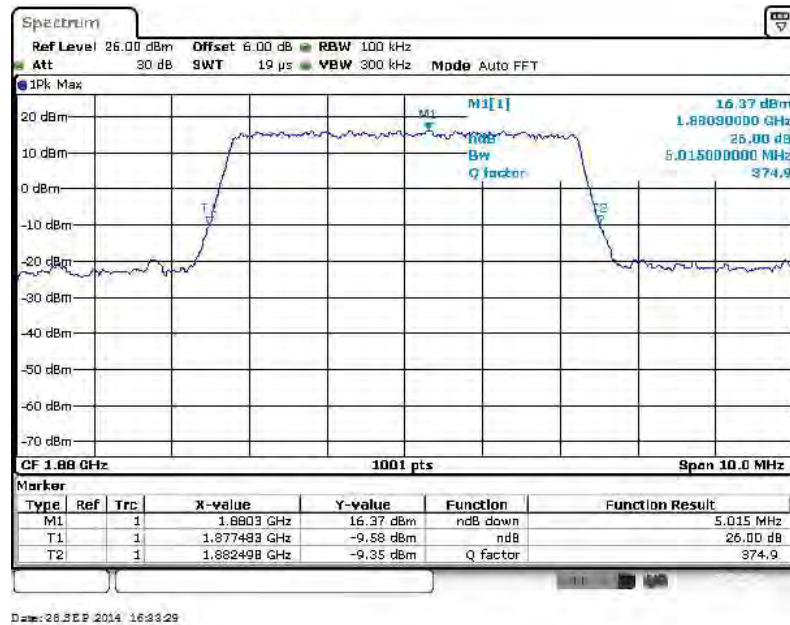



Band :	LTE Band 2	BW / Mod. :	5MHz / 16QAM
--------	------------	-------------	--------------

99% Occupied Bandwidth Plot on Channel 18900

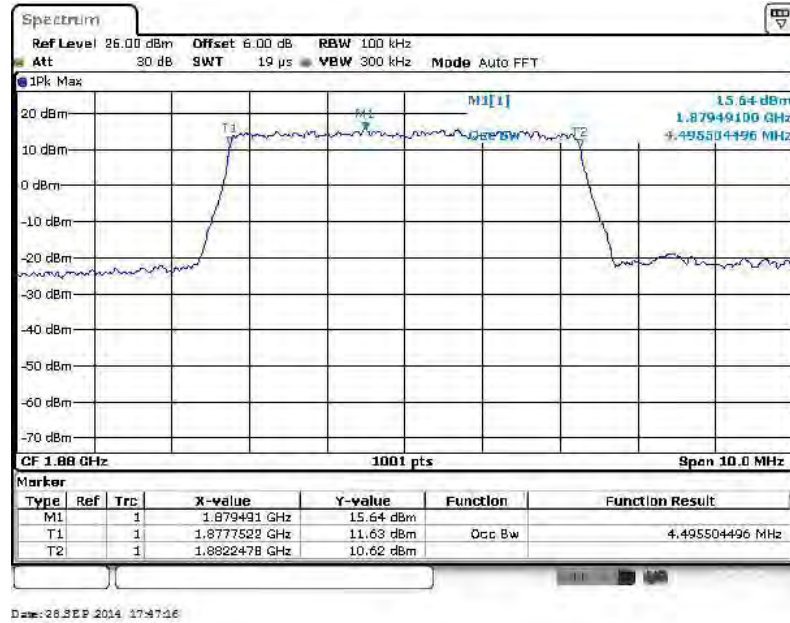

26dB Bandwidth Plot on Channel 18900

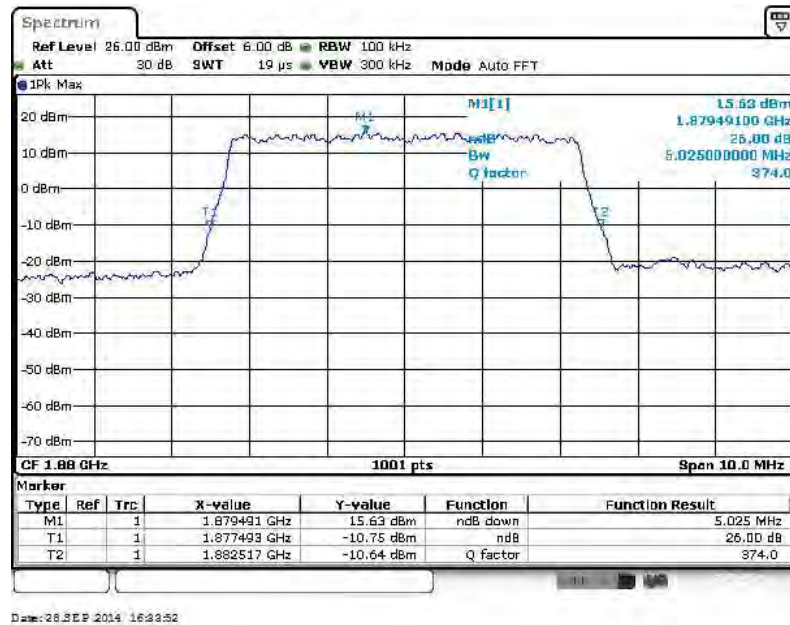



Band :	LTE Band 2	BW / Mod. :	10MHz / QPSK
--------	------------	-------------	--------------

99% Occupied Bandwidth Plot on Channel 18900

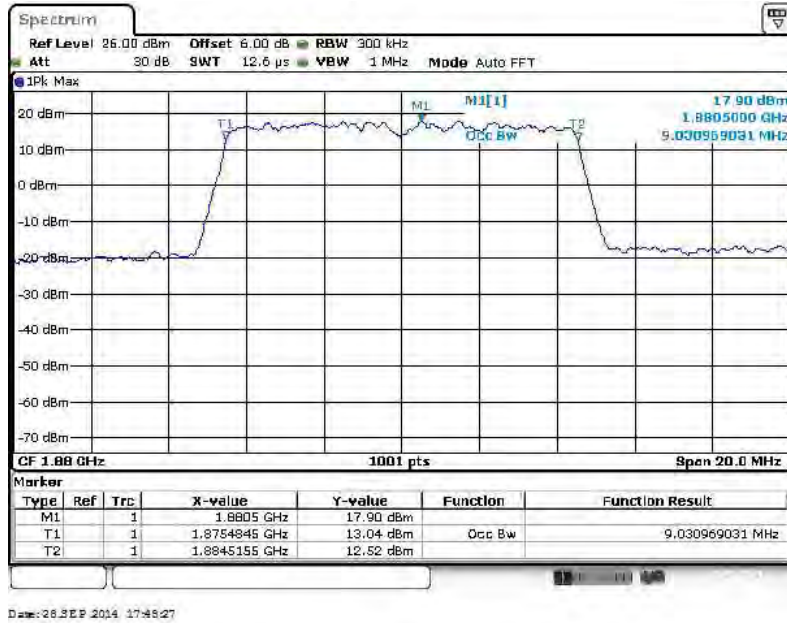

26dB Bandwidth Plot on Channel 18900

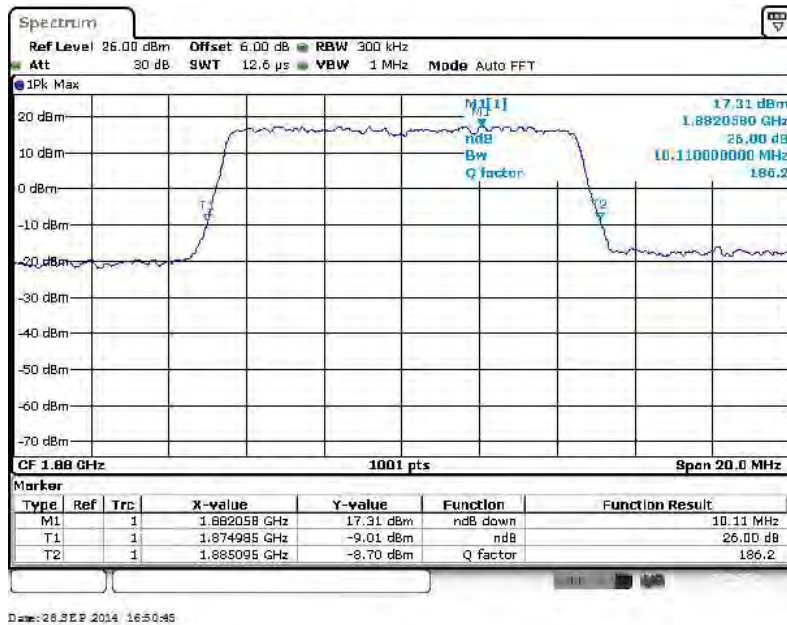



Band :	LTE Band 2	BW / Mod. :	10MHz / 16QAM
--------	------------	-------------	---------------

99% Occupied Bandwidth Plot on Channel 18900

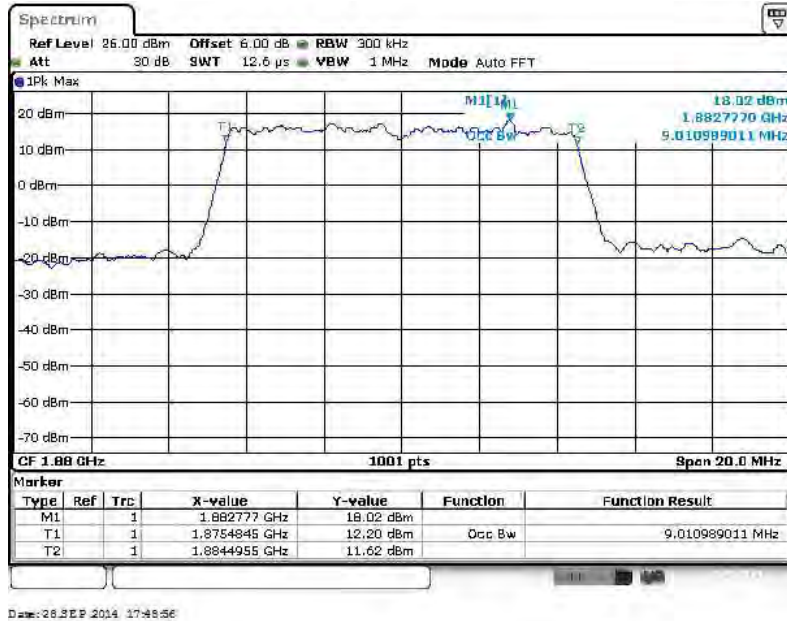

26dB Bandwidth Plot on Channel 18900

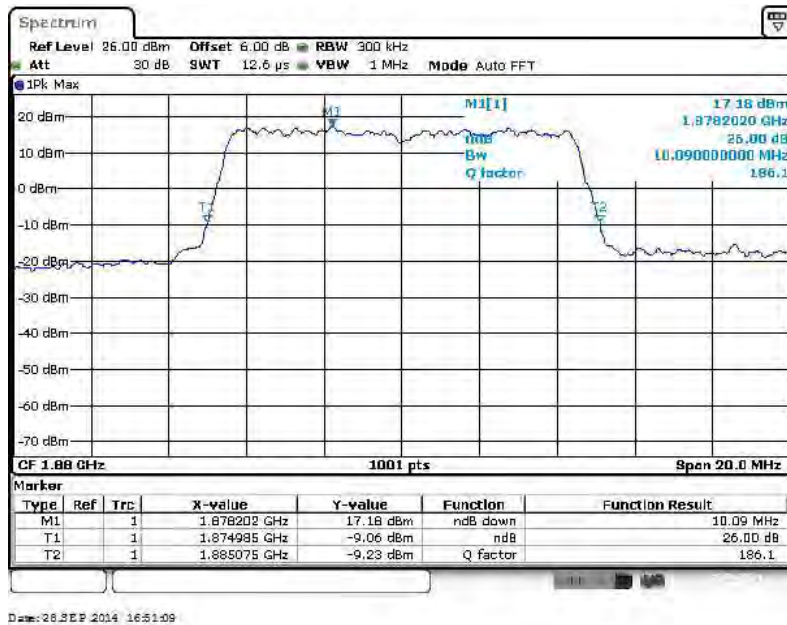



Band :	LTE Band 2	BW / Mod. :	15MHz / QPSK
--------	------------	-------------	--------------

99% Occupied Bandwidth Plot on Channel 18900

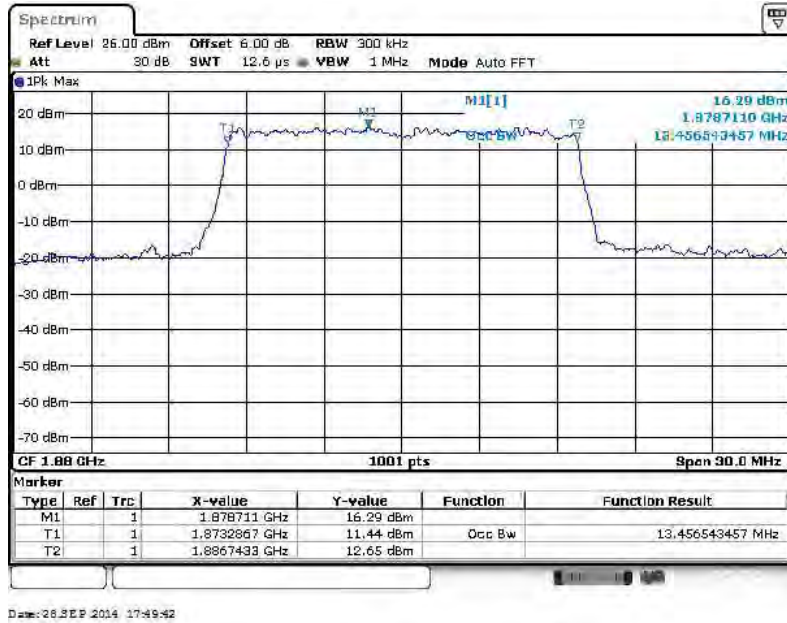

26dB Bandwidth Plot on Channel 18900

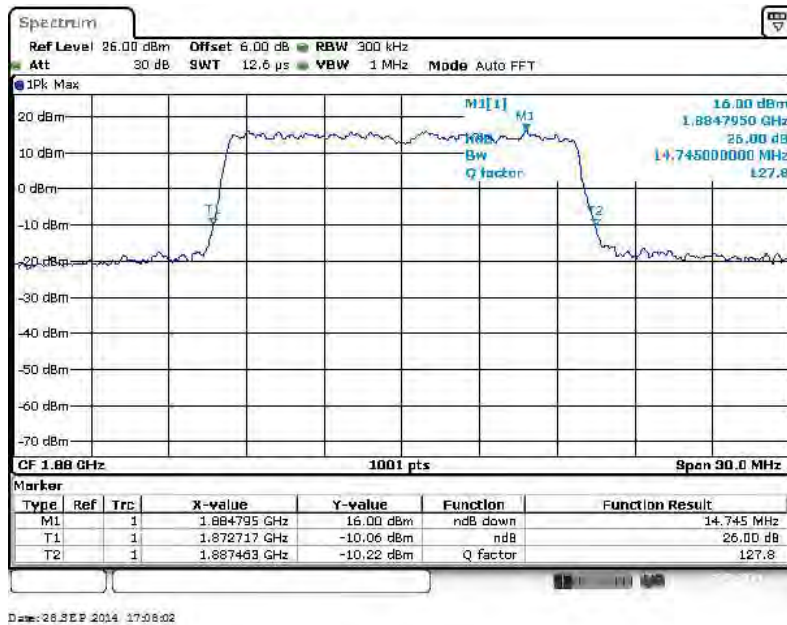



Band :	LTE Band 2	BW / Mod. :	15MHz / 16QAM
--------	------------	-------------	---------------

99% Occupied Bandwidth Plot on Channel 18900

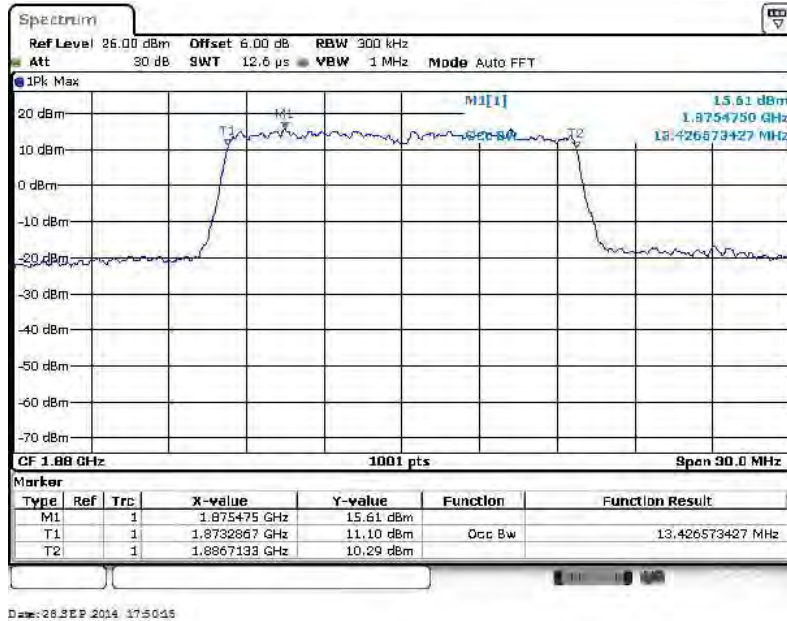

26dB Bandwidth Plot on Channel 18900

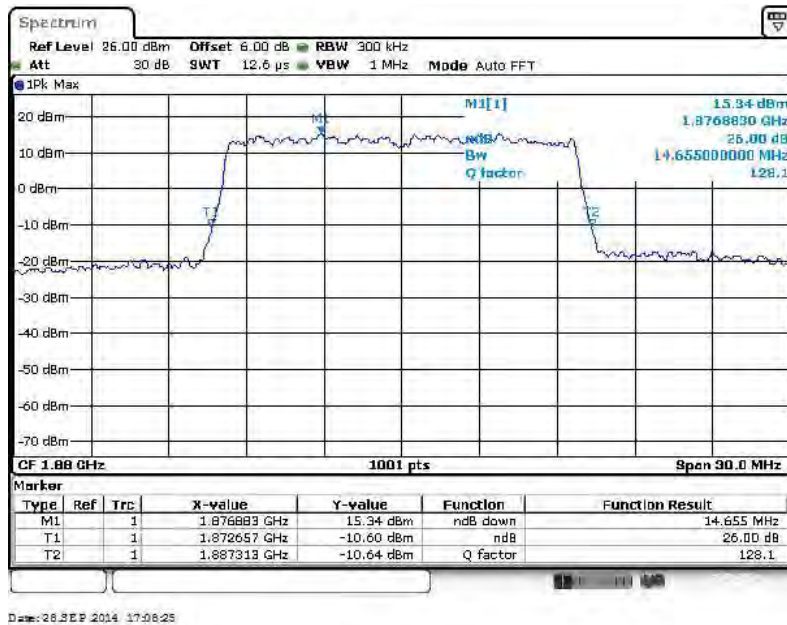



Band :	LTE Band 2	BW / Mod. :	20MHz / QPSK
---------------	------------	--------------------	--------------

99% Occupied Bandwidth Plot on Channel 18900

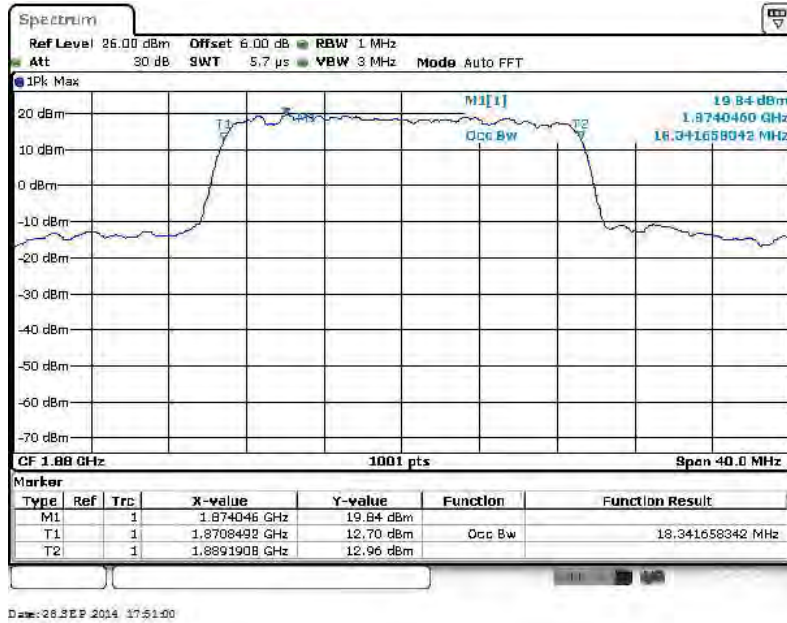

26dB Bandwidth Plot on Channel 18900

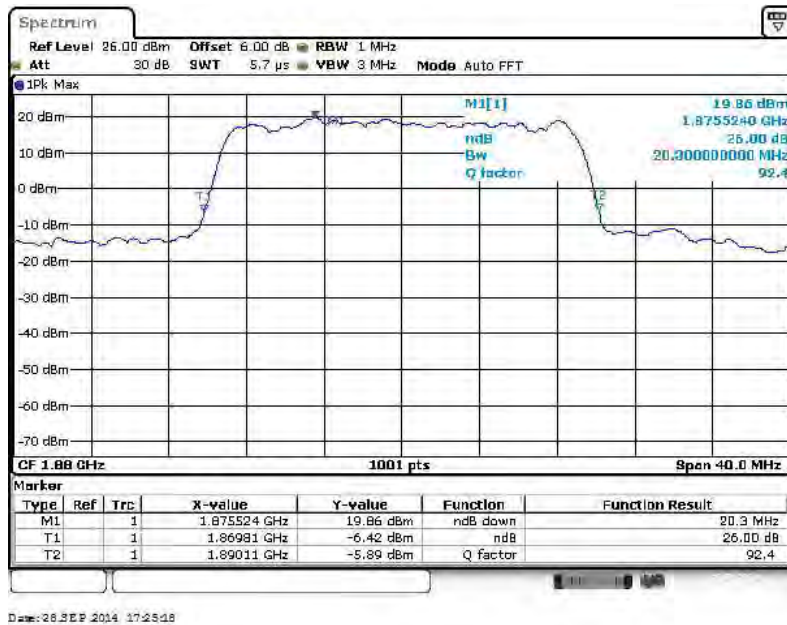



Band :	LTE Band 2	BW / Mod. :	20MHz / 16QAM
--------	------------	-------------	---------------

99% Occupied Bandwidth Plot on Channel 18900

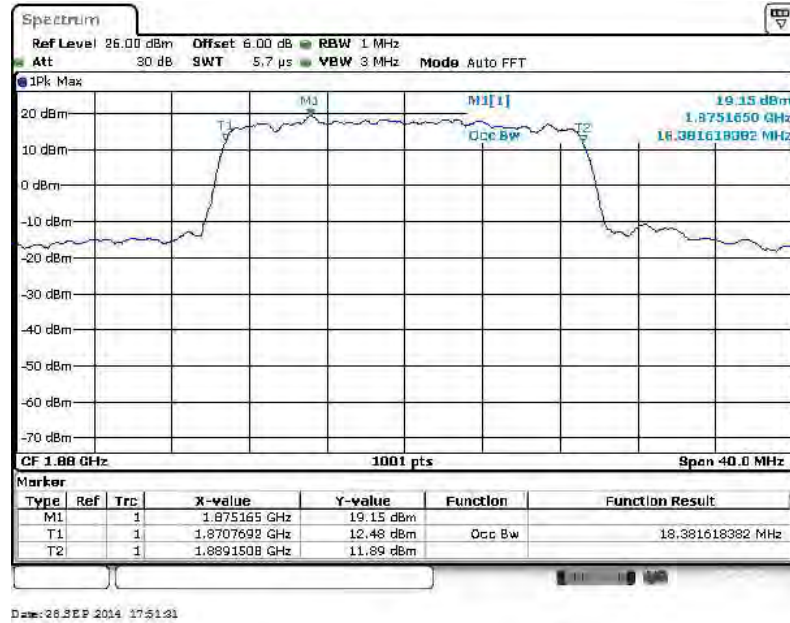

26dB Bandwidth Plot on Channel 18900

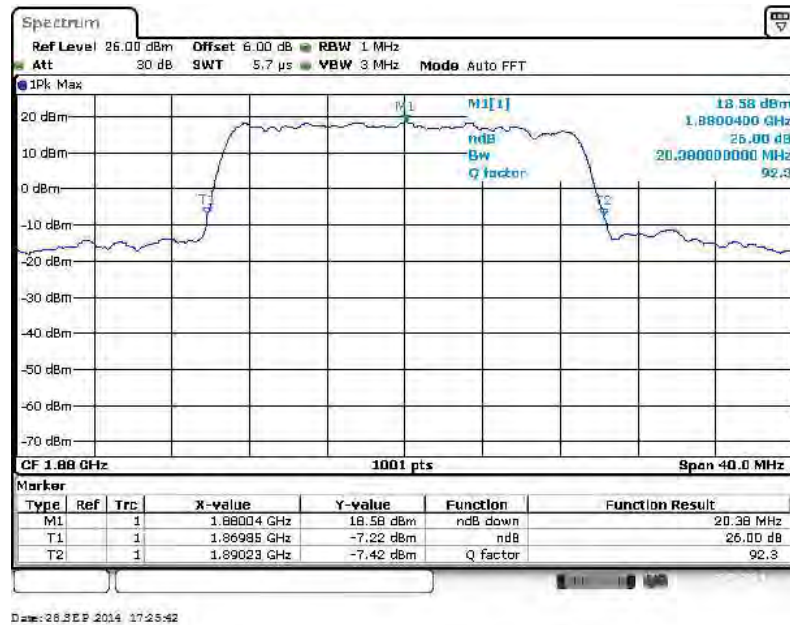



Band :	LTE Band 4	BW / Mod. :	1.4MHz / QPSK
---------------	------------	--------------------	---------------

99% Occupied Bandwidth Plot on Channel 20175

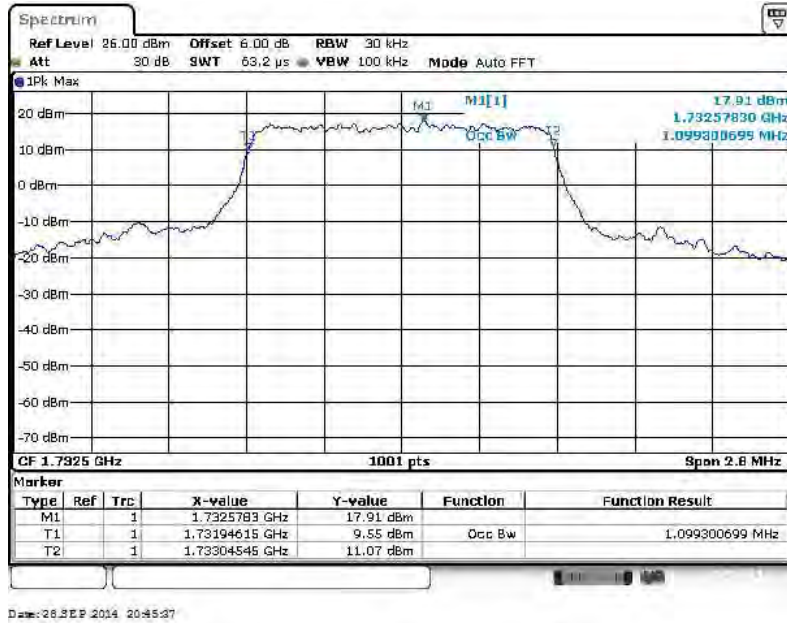

26dB Bandwidth Plot on Channel 20175

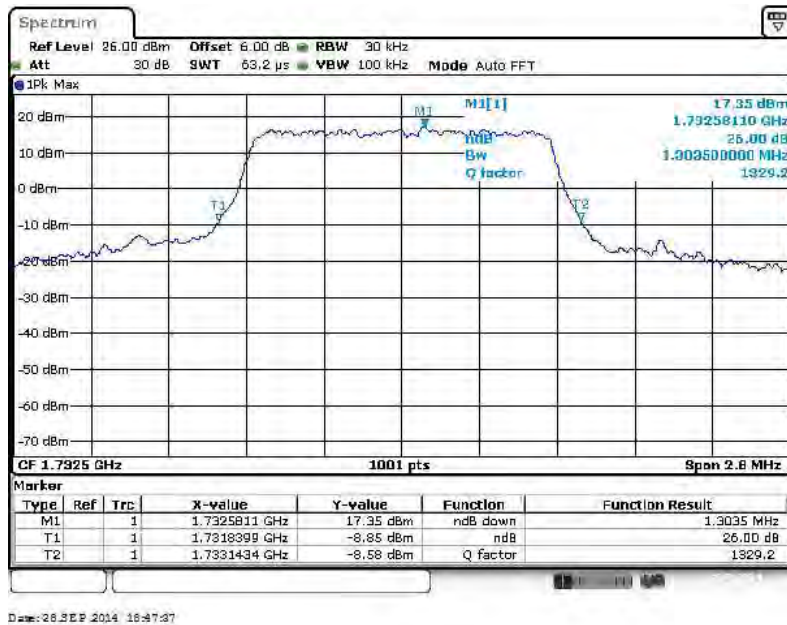



Band :	LTE Band 4	BW / Mod. :	1.4MHz / 16QAM
---------------	------------	--------------------	----------------

99% Occupied Bandwidth Plot on Channel 20175

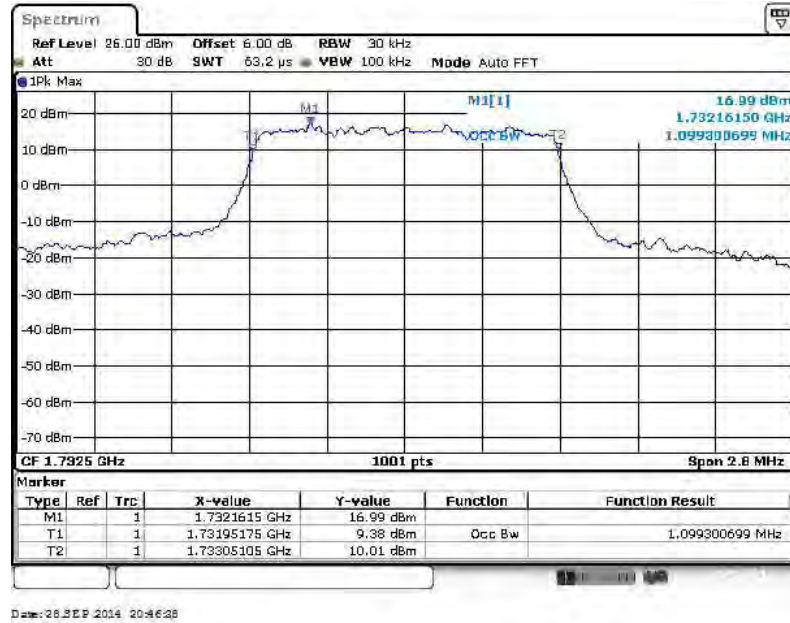

26dB Bandwidth Plot on Channel 20175

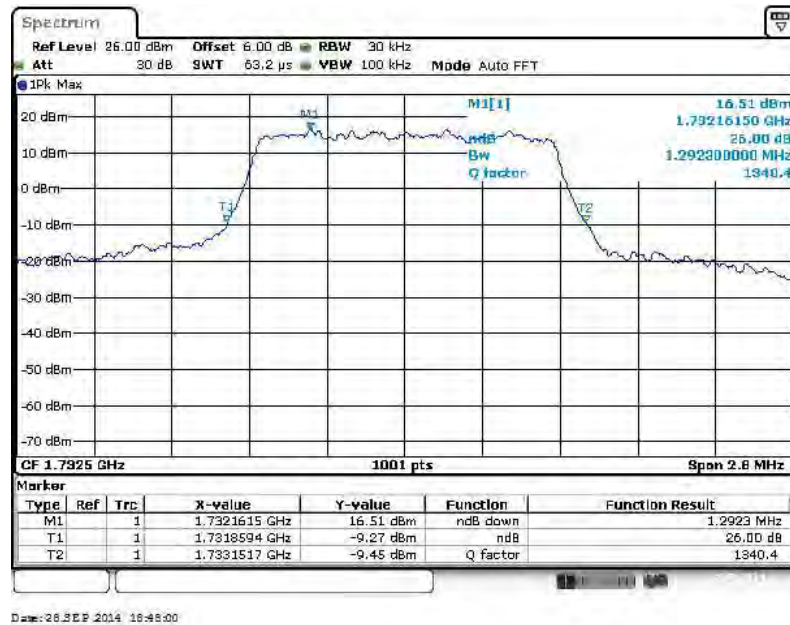



Band :	LTE Band 4	BW / Mod. :	3MHz / QPSK
--------	------------	-------------	-------------

99% Occupied Bandwidth Plot on Channel 20175

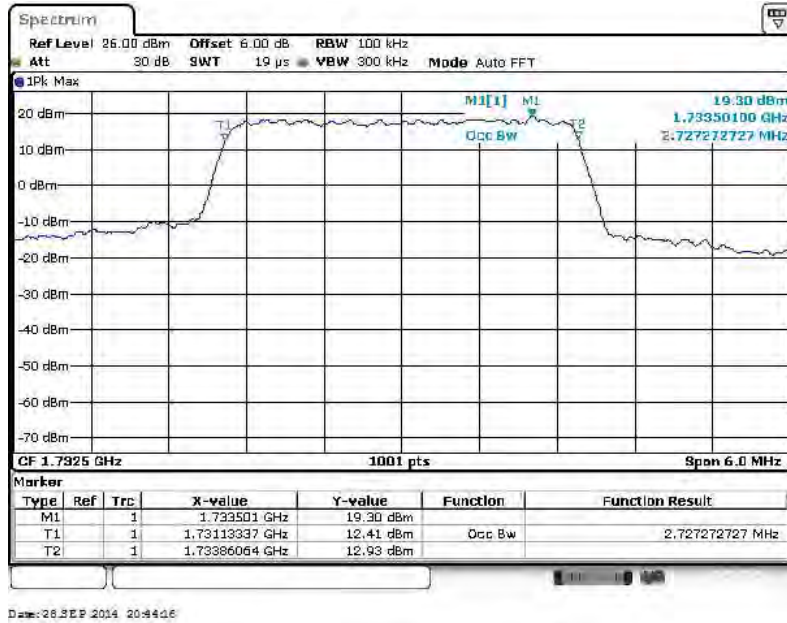

26dB Bandwidth Plot on Channel 20175

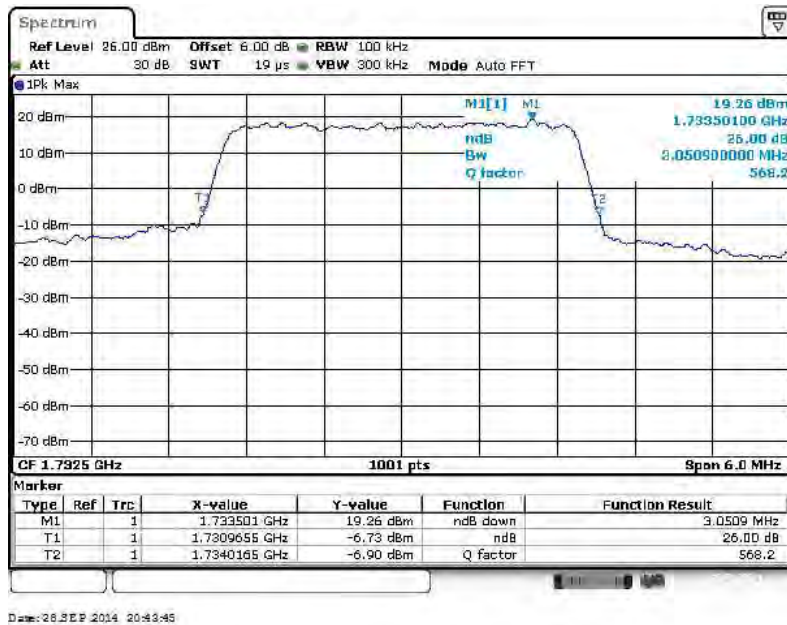



Band :	LTE Band 4	BW / Mod. :	3MHz / 16QAM
--------	------------	-------------	--------------

99% Occupied Bandwidth Plot on Channel 20175

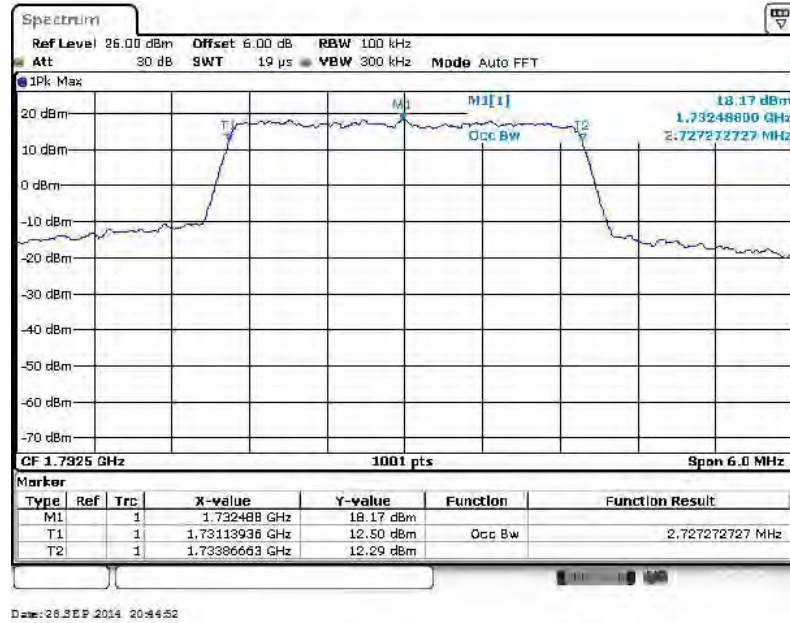

26dB Bandwidth Plot on Channel 20175

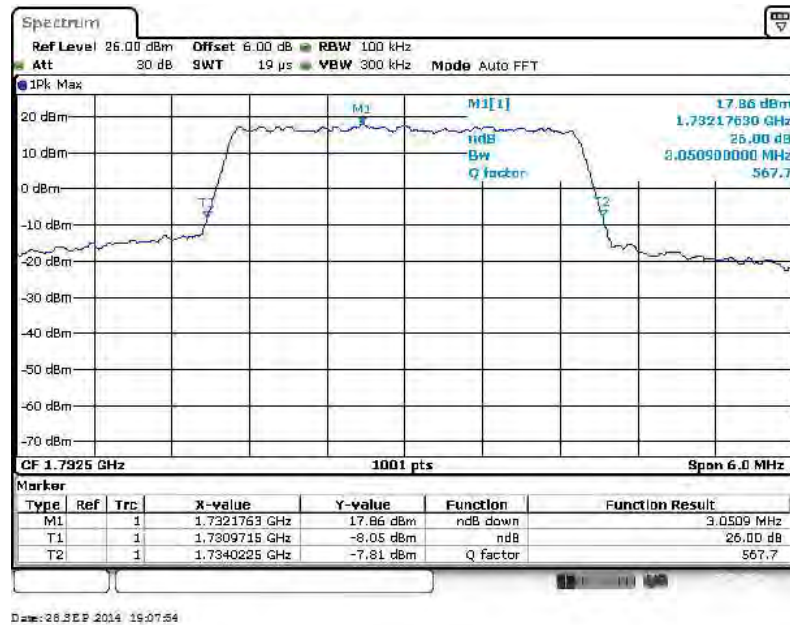



Band :	LTE Band 4	BW / Mod. :	5MHz / QPSK
---------------	------------	--------------------	-------------

99% Occupied Bandwidth Plot on Channel 20175

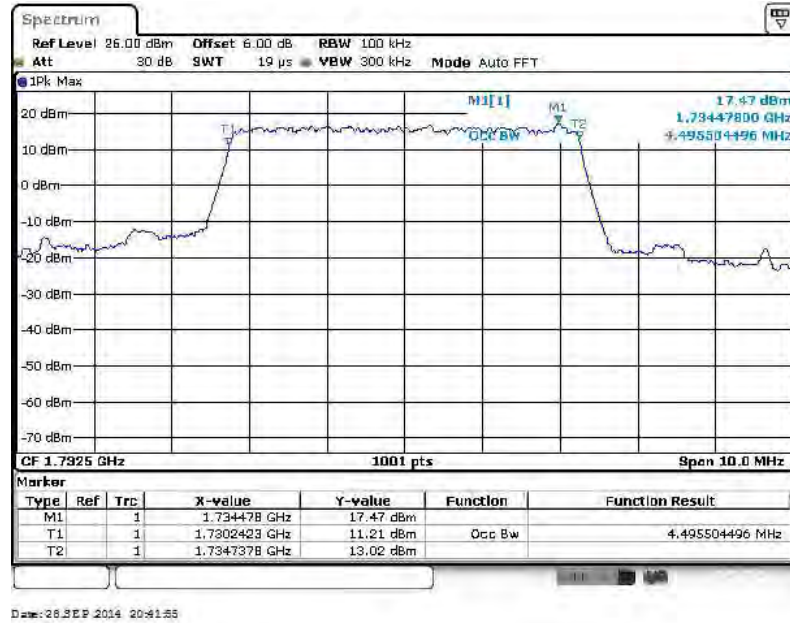

26dB Bandwidth Plot on Channel 20175

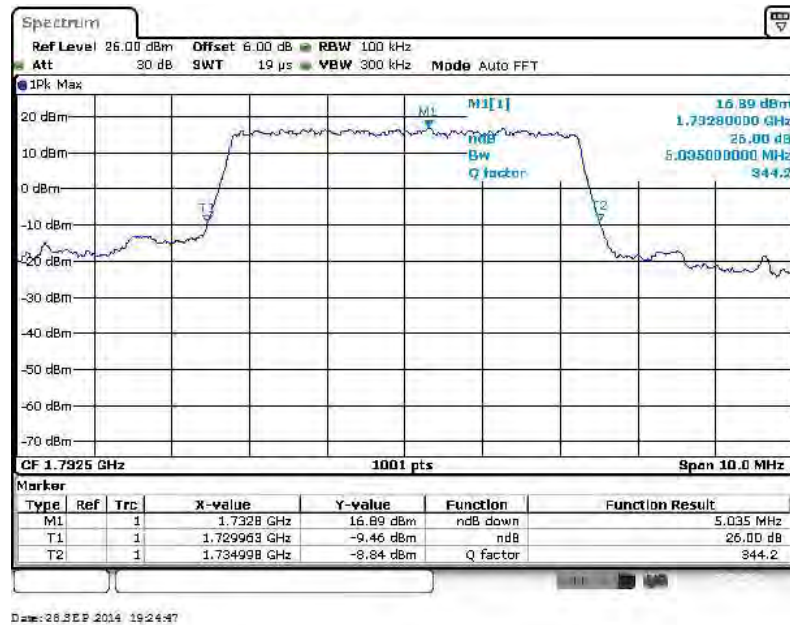



Band :	LTE Band 4	BW / Mod. :	5MHz / 16QAM
---------------	------------	--------------------	--------------

99% Occupied Bandwidth Plot on Channel 20175

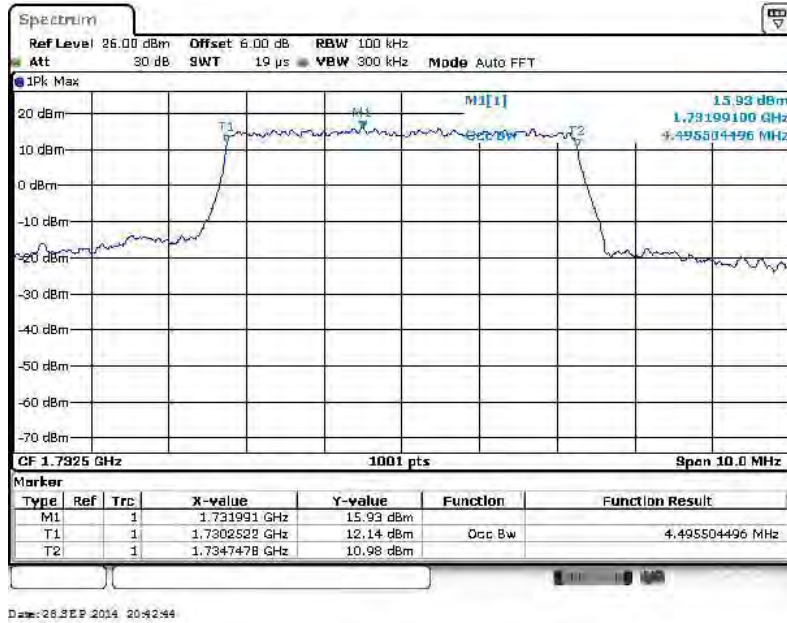

26dB Bandwidth Plot on Channel 20175

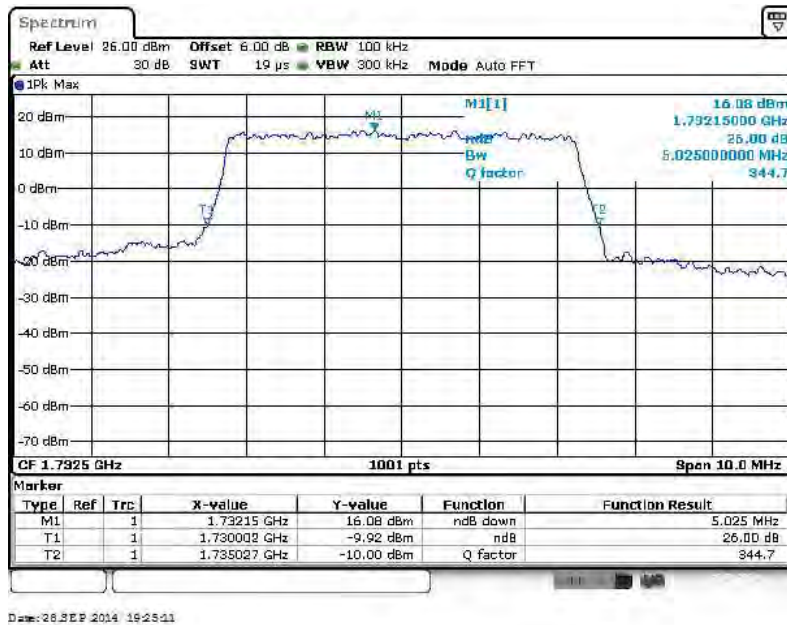



Band :	LTE Band 4	BW / Mod. :	10MHz / QPSK
--------	------------	-------------	--------------

99% Occupied Bandwidth Plot on Channel 20175

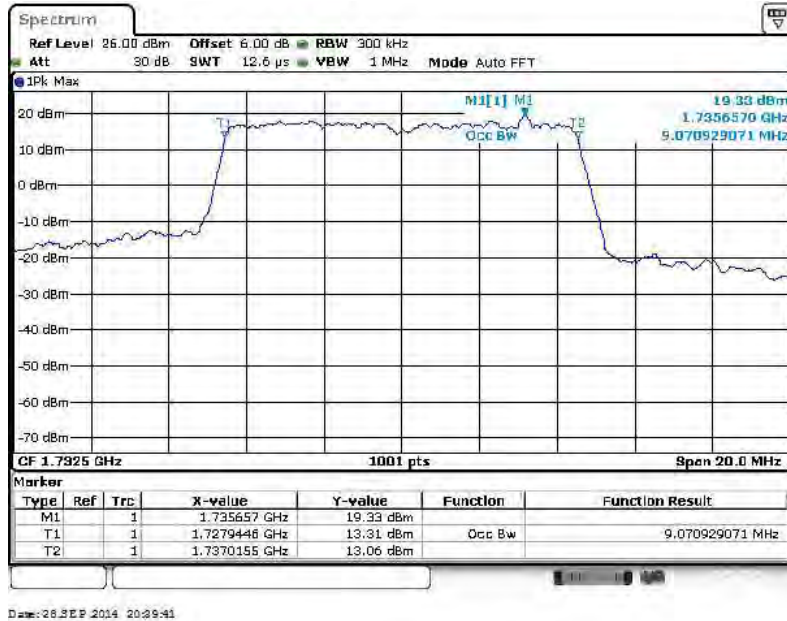

26dB Bandwidth Plot on Channel 20175

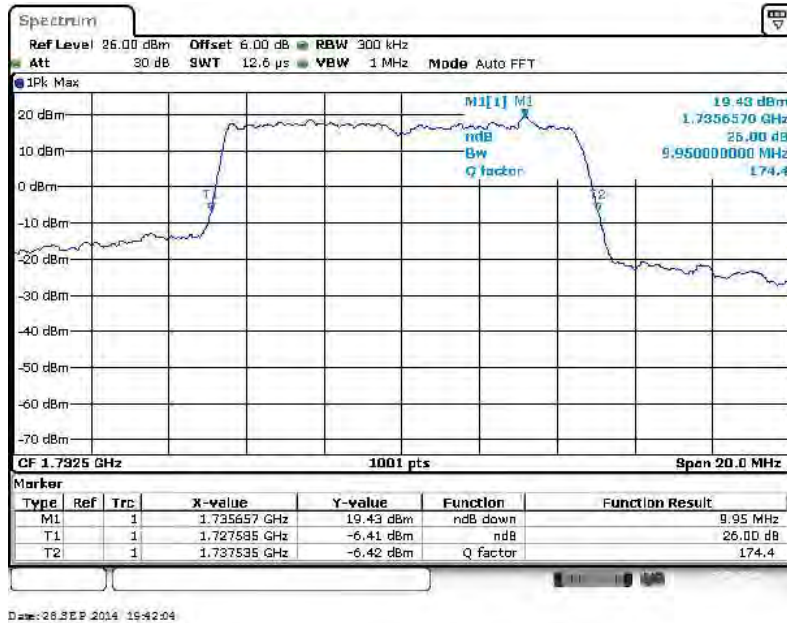



Band :	LTE Band 4	BW / Mod. :	10MHz / 16QAM
--------	------------	-------------	---------------

99% Occupied Bandwidth Plot on Channel 20175

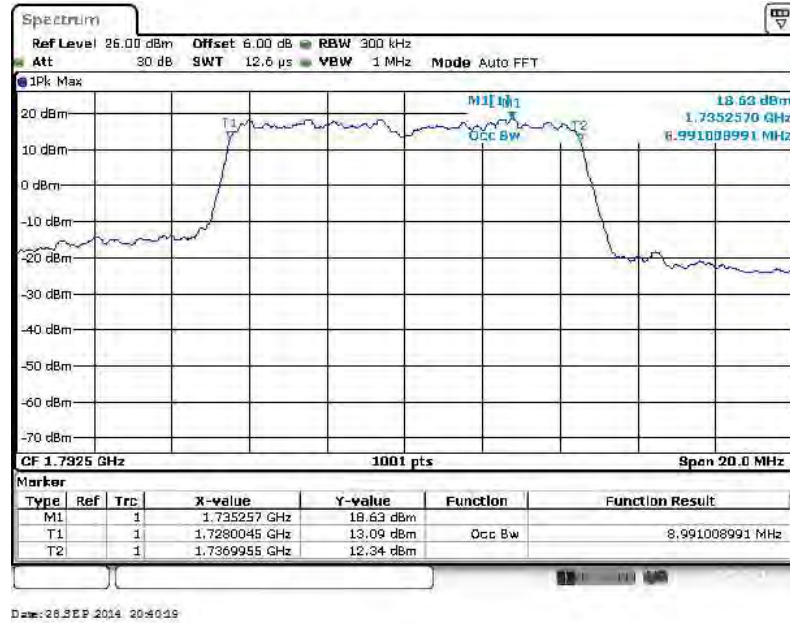

26dB Bandwidth Plot on Channel 20175

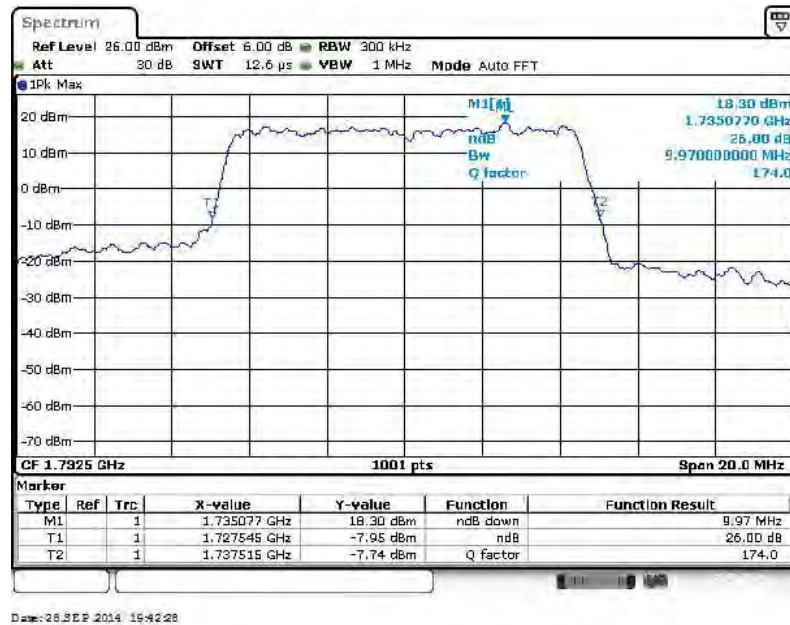



Band :	LTE Band 4	BW / Mod. :	15MHz / QPSK
--------	------------	-------------	--------------

99% Occupied Bandwidth Plot on Channel 20175

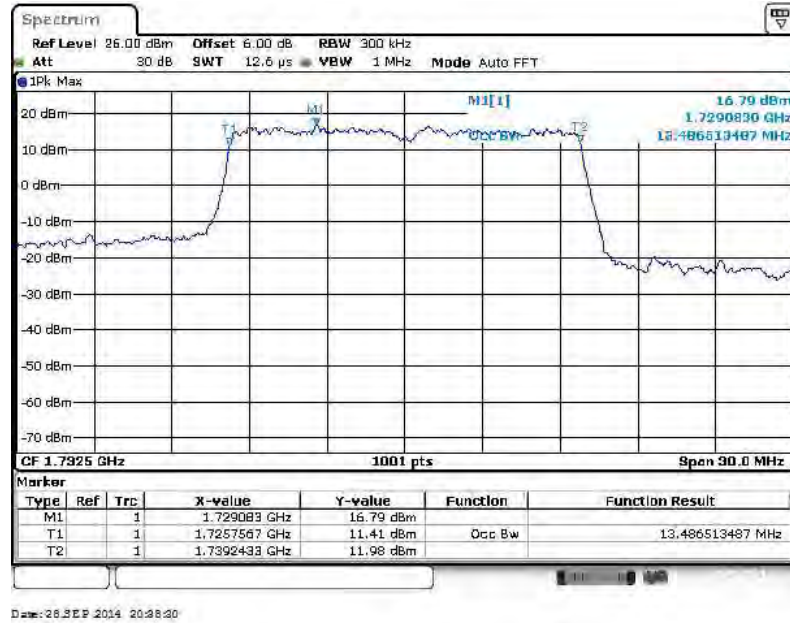

26dB Bandwidth Plot on Channel 20175

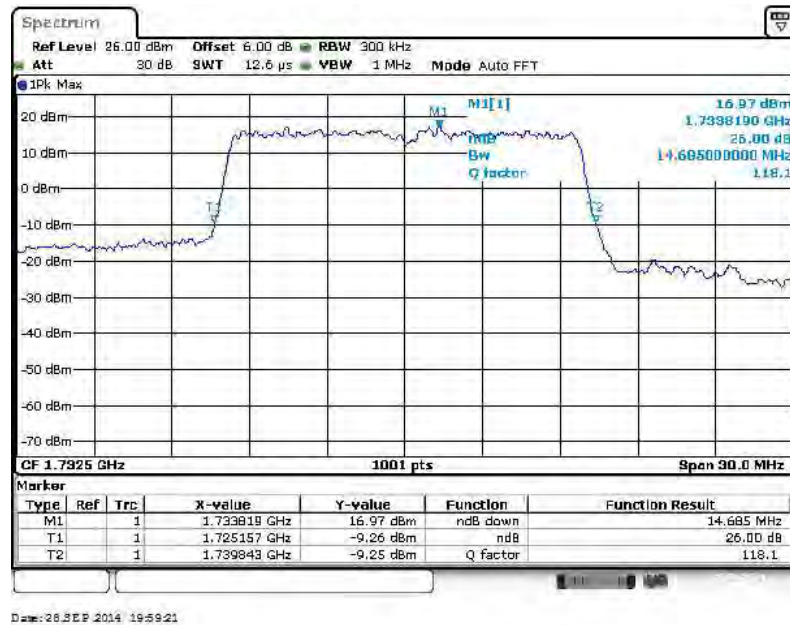



Band :	LTE Band 4	BW / Mod. :	15MHz / 16QAM
--------	------------	-------------	---------------

99% Occupied Bandwidth Plot on Channel 20175

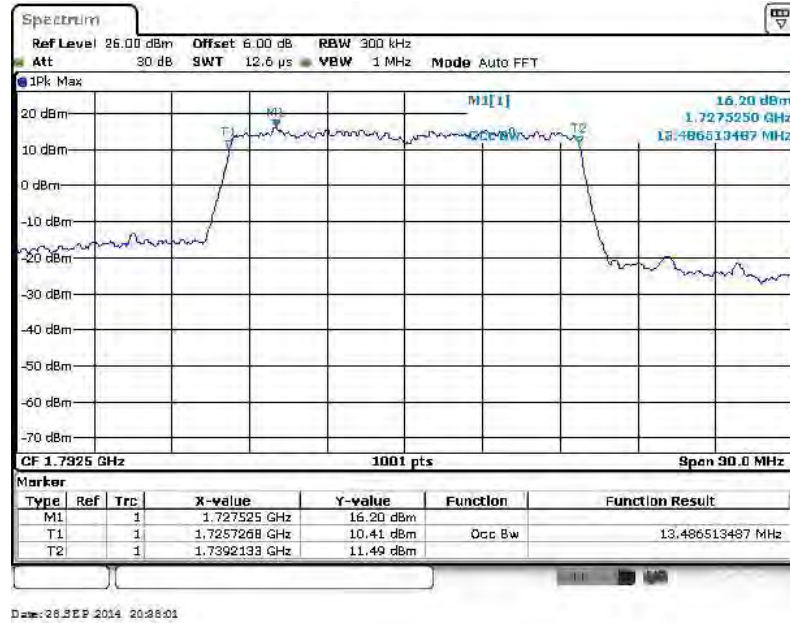

26dB Bandwidth Plot on Channel 20175

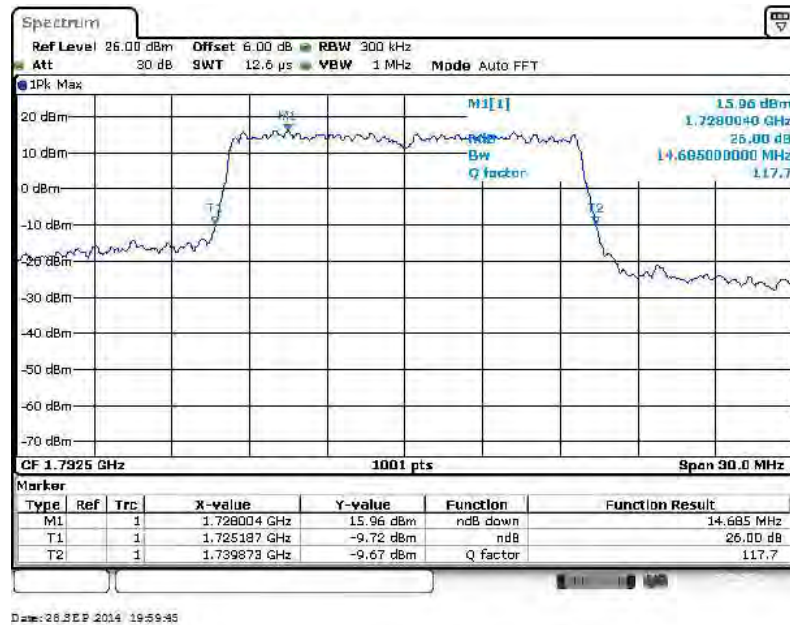



Band :	LTE Band 4	BW / Mod. :	20MHz / QPSK
--------	------------	-------------	--------------

99% Occupied Bandwidth Plot on Channel 20175

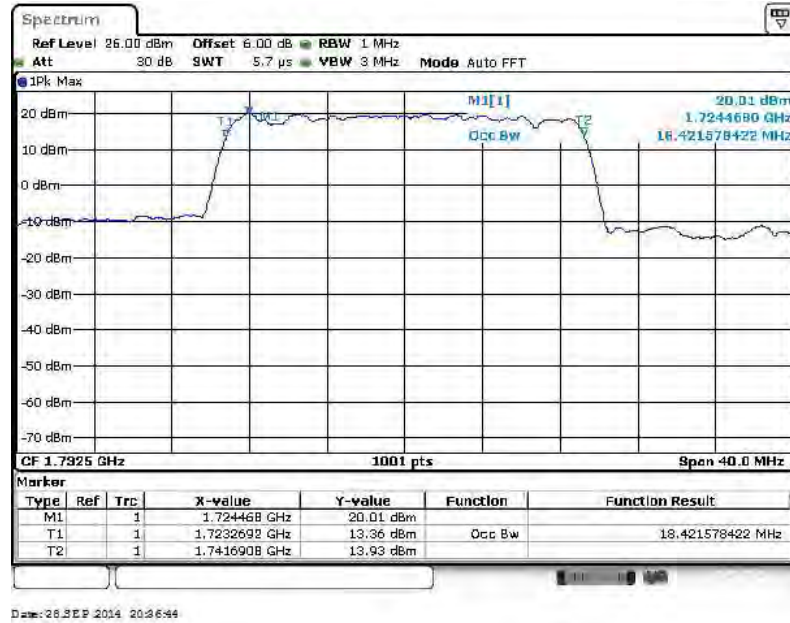

26dB Bandwidth Plot on Channel 20175

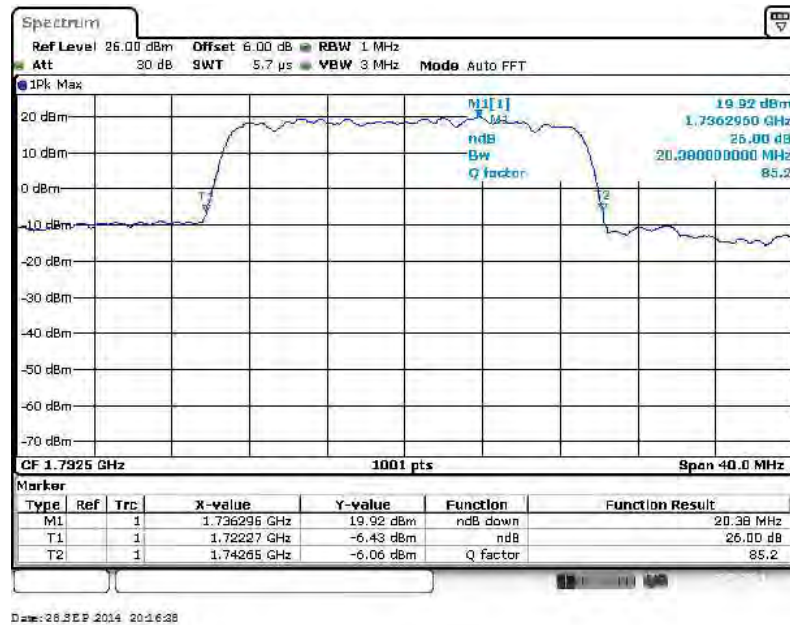



Band :	LTE Band 4	BW / Mod. :	20MHz / 16QAM
---------------	------------	--------------------	---------------

99% Occupied Bandwidth Plot on Channel 20175

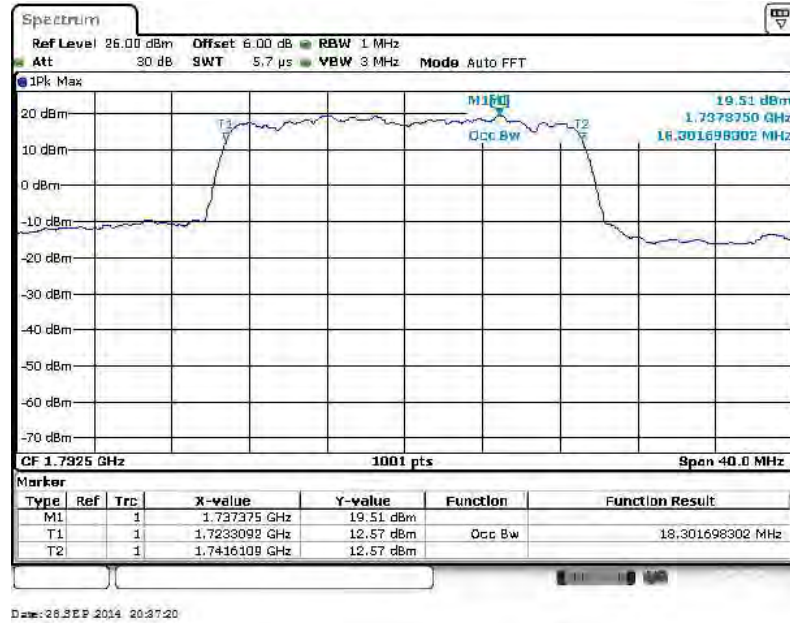

26dB Bandwidth Plot on Channel 20175

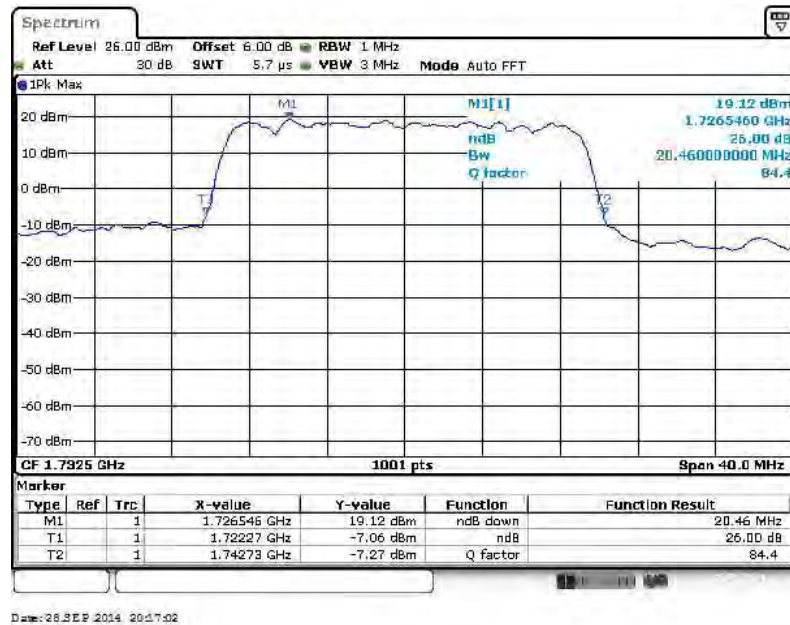



Band :	LTE Band 17	BW / Mod. :	5MHz / QPSK
--------	-------------	-------------	-------------

99% Occupied Bandwidth Plot on Channel 23790

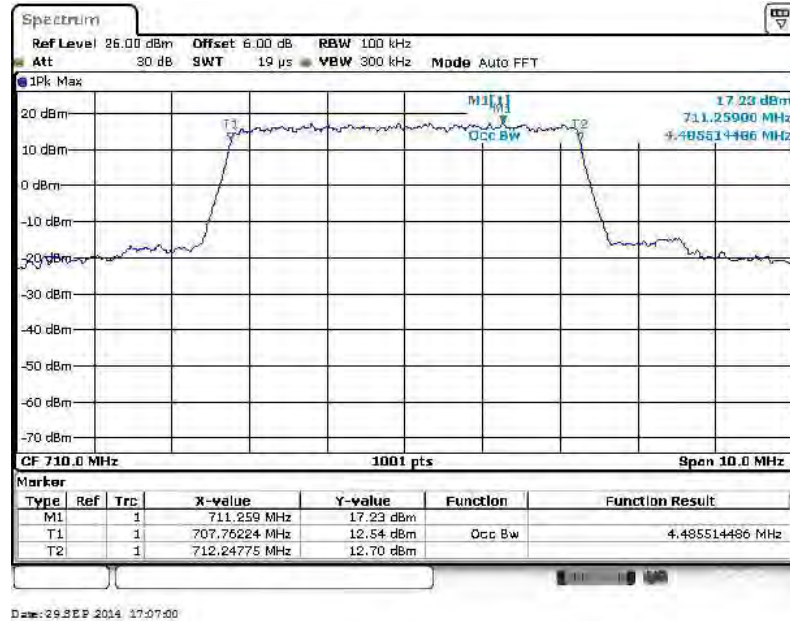

26dB Bandwidth Plot on Channel 23790

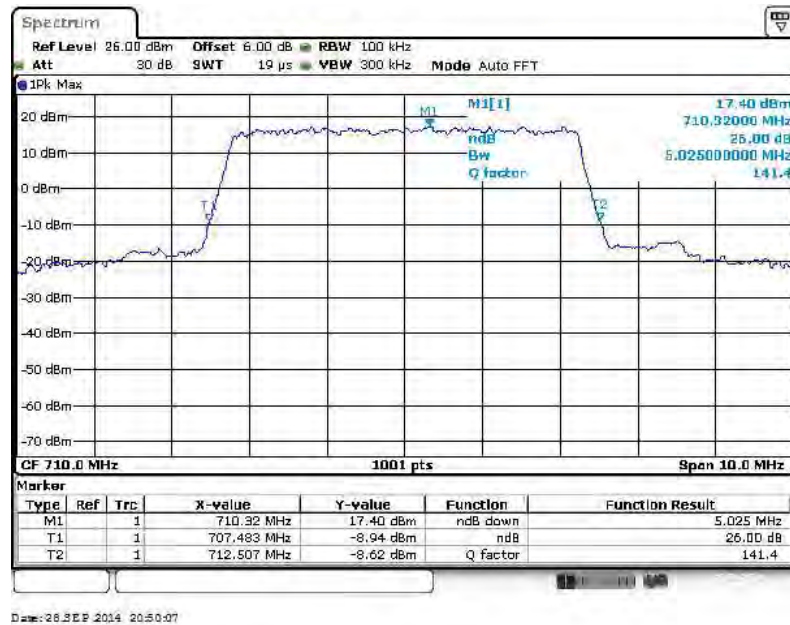



Band :	LTE Band 17	BW / Mod. :	5MHz / 16QAM
--------	-------------	-------------	--------------

99% Occupied Bandwidth Plot on Channel 23790

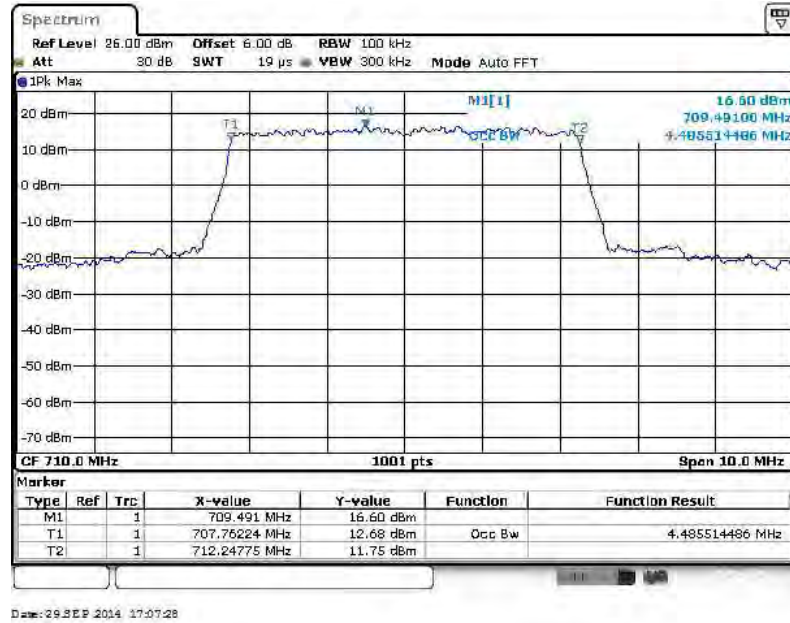

26dB Bandwidth Plot on Channel 23790

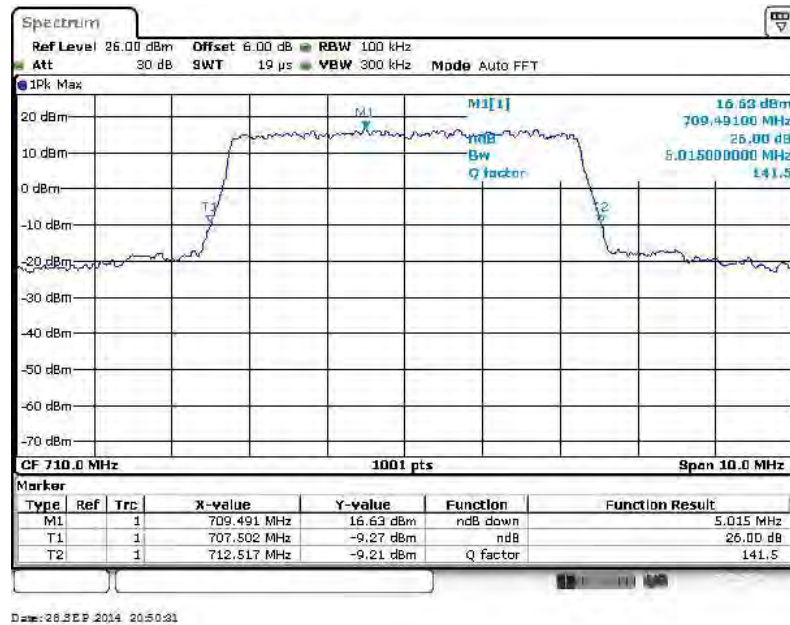



Band :	LTE Band 17	BW / Mod. :	10MHz / QPSK
--------	-------------	-------------	--------------

99% Occupied Bandwidth Plot on Channel 23790

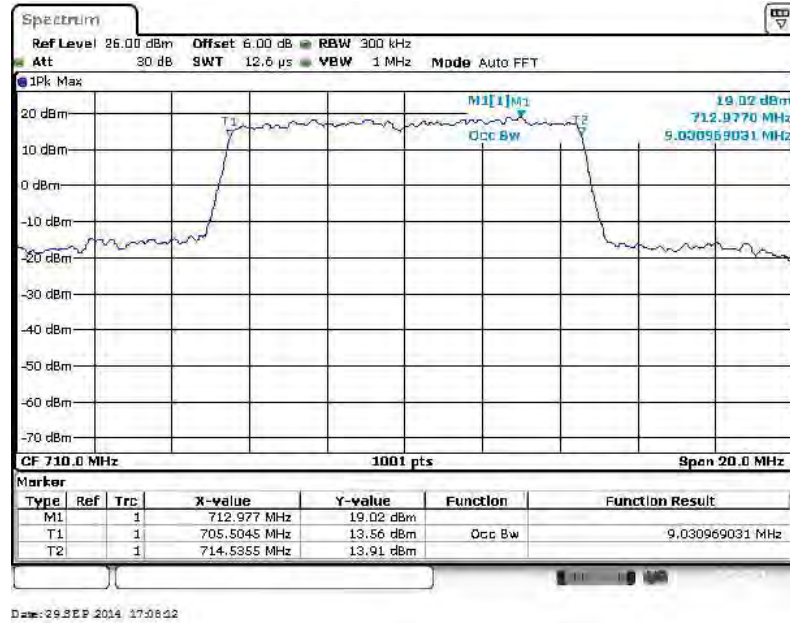

26dB Bandwidth Plot on Channel 23790

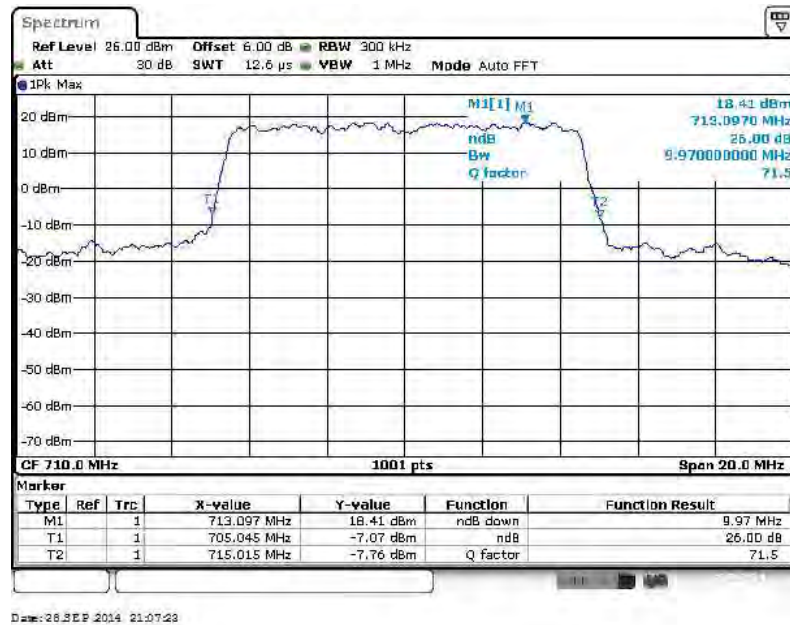



Band :	LTE Band 17	BW / Mod. :	10MHz / 16QAM
--------	-------------	-------------	---------------

99% Occupied Bandwidth Plot on Channel 23790

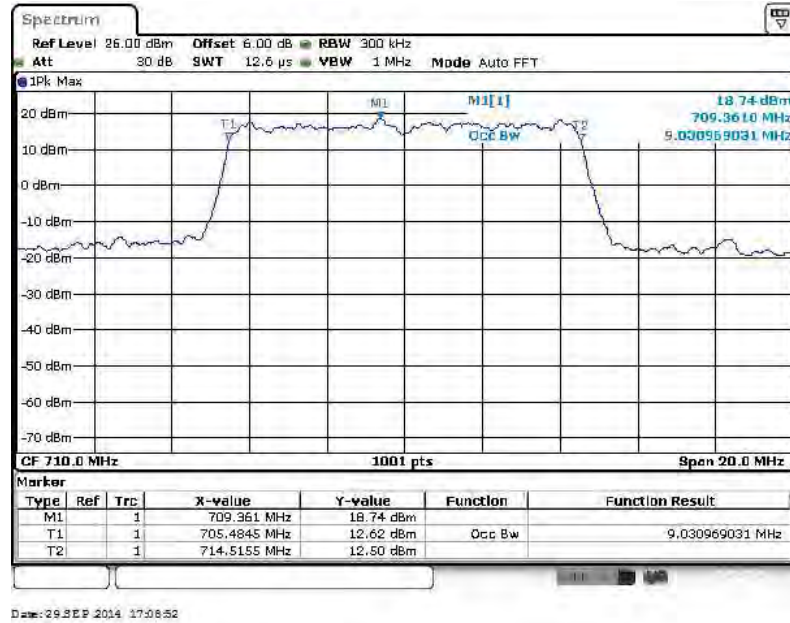

26dB Bandwidth Plot on Channel 23790

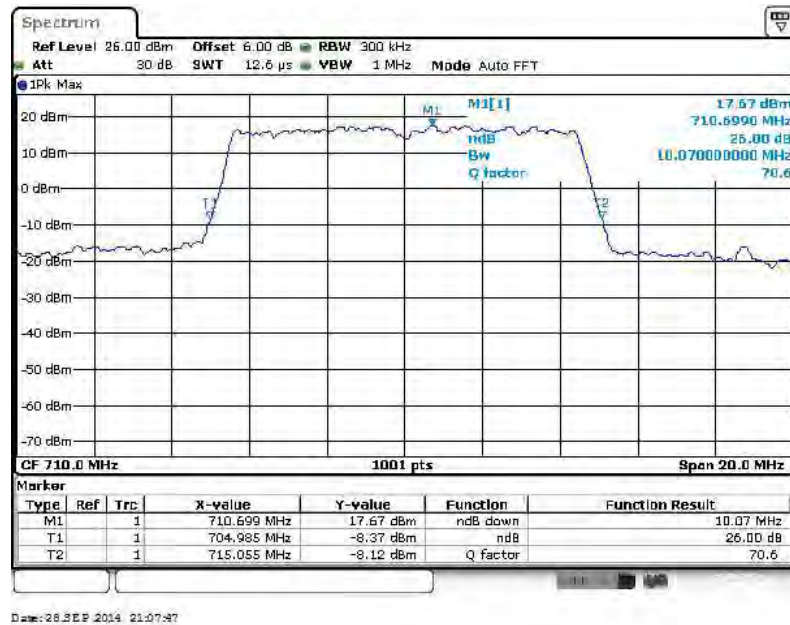



3.5 Conducted Band Edge Measurement

3.5.1 Description of Conducted Band Edge Measurement

24.238 (a)

For operations in the 1850-1910 and 1930-1990 MHz band, the FCC limit is $43 + 10\log_{10}(P[\text{Watts}])$ dB below the transmitter power $P(\text{Watts})$ in a 1MHz bandwidth. However, in the 1 MHz bands immediately outside and adjacent to the frequency block a resolution bandwidth of at least one percent of the emission bandwidth of the fundamental emission of the transmitter may be employed.

27.53 (g)

For operations in the 698 -746 MHz band, the FCC limit is $43 + 10\log_{10}(P[\text{Watts}])$ dB below the transmitter power $P(\text{Watts})$ in a 100 kHz bandwidth. However, in the 100 kilohertz bands immediately outside and adjacent to a licensee's frequency block, a resolution bandwidth of at least 30 kHz may be employed.

27.53 (h)

For operations in the 1710 – 1755 MHz band, the FCC limit is $43 + 10\log_{10}(P[\text{Watts}])$ dB below the transmitter power $P(\text{Watts})$ in a 1 MHz bandwidth. However, in the 1MHz bands immediately outside and adjacent to the licensee's frequency block, a resolution bandwidth of at least one percent of the emission bandwidth of the fundamental emission of the transmitter may be employed.



27.53 (m)(4)

For mobile digital stations, the attenuation factor shall be not less than $40 + 10 \log (P)$ dB on all frequencies between the channel edge and 5 megahertz from the channel edge, $43 + 10 \log (P)$ dB on all frequencies between 5 megahertz and X megahertz from the channel edge, and $55 + 10 \log (P)$ dB on all frequencies more than X megahertz from the channel edge, where X is the greater of 6 megahertz or the actual emission bandwidth as defined in paragraph (m)(6) of this section. In addition, the attenuation factor shall not be less that $43 + 10 \log (P)$ dB on all frequencies between 2490.5 MHz and 2496 MHz and $55 + 10 \log (P)$ dB at or below 2490.5 MHz. Mobile Satellite Service licensees operating on frequencies below 2495 MHz may also submit a documented interference complaint against BRS licensees operating on channel BRS Channel 1 on the same terms and conditions as adjacent channel BRS or EBS licensees.

RSS-199:

The emissions be operated in the 2496-2690 MHz band, the attenuation factor shall be not less than $43 + 10 \log (P)$ dB at the channel edge and $55 + 10 \log (P)$ dB at 5.5 megahertz from the channel edges.

3.5.2 Measuring Instruments

The measuring equipment is listed in the section 4 of this test report.

3.5.3 Test Procedures

1. The EUT was connected to spectrum analyzer and system simulator via a power divider.
2. The band edges of low and high channels for the highest RF powers were measured. Set RBW \geq 1% EBW in the 1MHz band immediately outside and adjacent to the band edge.
3. Set spectrum analyzer with RMS detector.
4. The RF fundamental frequency should be excluded against the limit line in the operating frequency band.
5. The limit line is derived from $43 + 10\log(P)$ dB below the transmitter power P(Watts)

$$= P(W) - [43 + 10\log(P)] \text{ (dB)}$$

$$= [30 + 10\log(P)] \text{ (dBm)} - [43 + 10\log(P)] \text{ (dB)}$$

$$= -13\text{dBm.}$$
 <For Band 7>

The limit line is derived from $55 + 10\log(P)$ dB below the transmitter power P(Watts)

$$= P(W) - [55 + 10\log(P)] \text{ (dB)}$$

$$= [30 + 10\log(P)] \text{ (dBm)} - [55 + 10\log(P)] \text{ (dB)}$$

$$= -25\text{dBm.}$$

3.5.4 Test Setup

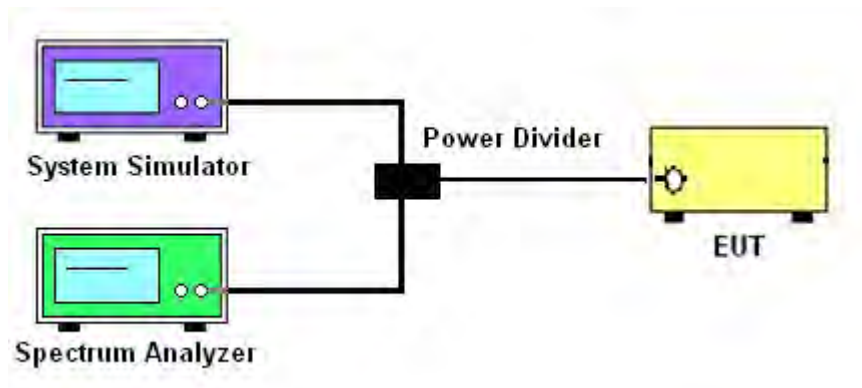



3.5.5 Test Result (Plots) of Conducted Band Edge

Band :	LTE Band 7	Band Width :	5MHz / QPSK
--------	------------	--------------	-------------

Lower Band Edge Plot for QPSK-RB Size 1, RB Offset 0

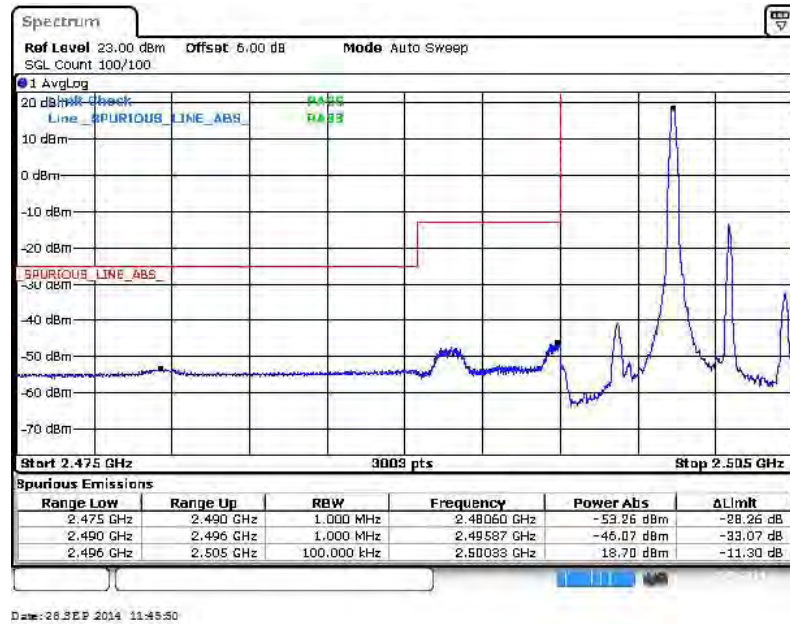

Lower Band Edge Plot for QPSK-RB Size 25, RB Offset 0

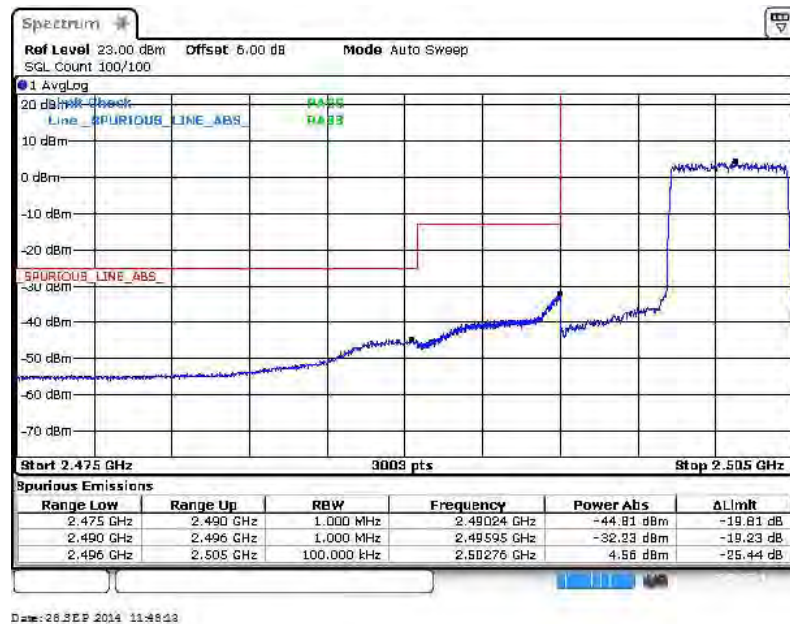



Higher Band Edge Plot for QPSK-RB Size 1, RB Offset 24

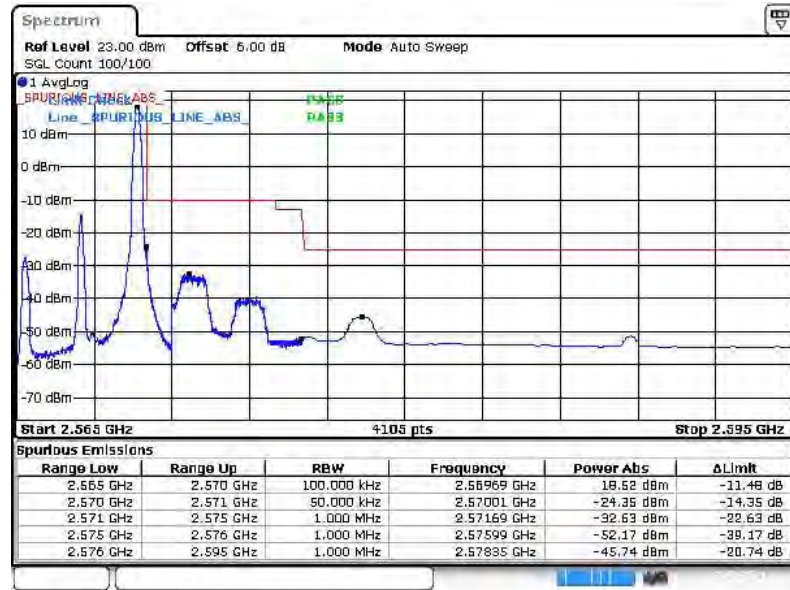

Date: 26 SEP 2014 11:50:26

Higher Band Edge Plot for QPSK-RB Size 25, RB Offset 0

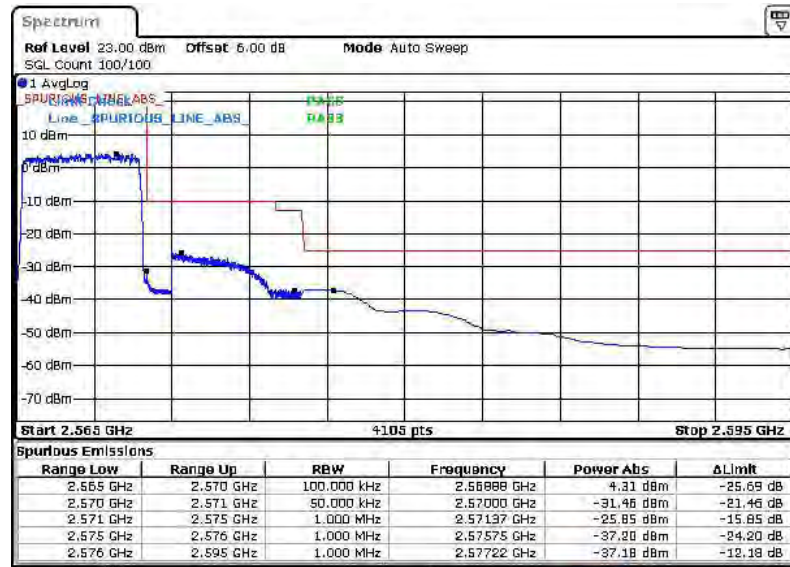

Date: 26 SEP 2014 11:52:58



Band :	LTE Band 7	Band Width :	5MHz / 16QAM
--------	------------	--------------	--------------

Lower Band Edge Plot for 16QAM-RB Size 1, RB Offset 0

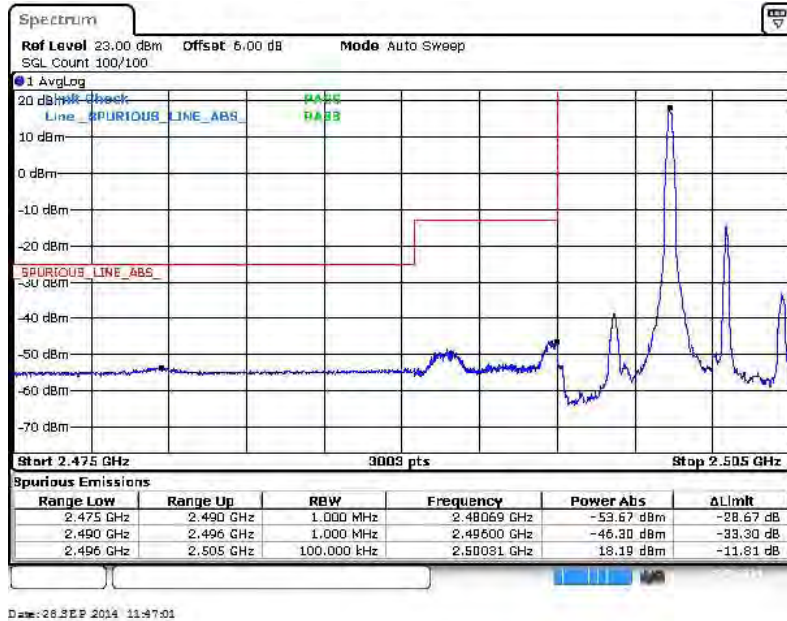

Lower Band Edge Plot for 16QAM-RB Size 25, RB Offset 0

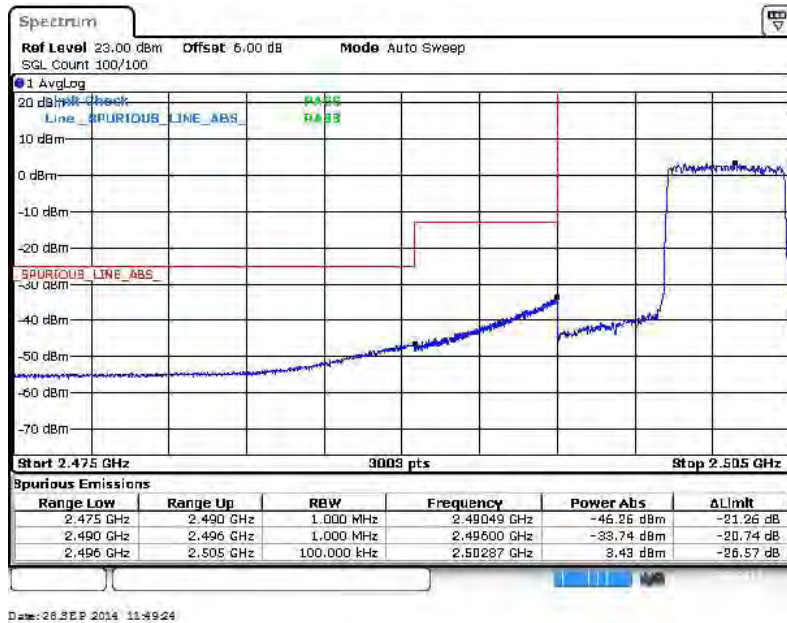



Higher Band Edge Plot for 16QAM-RB Size 1, RB Offset 24

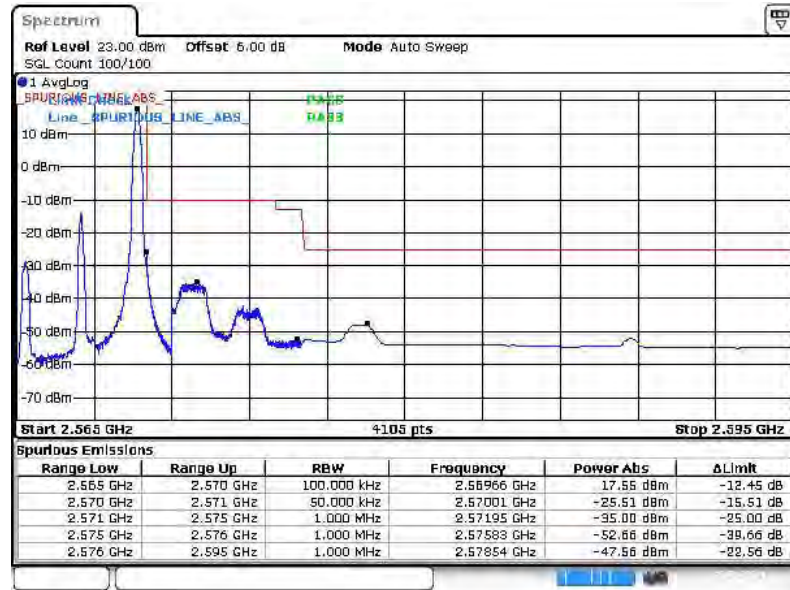

Date: 26 SEP 2014 11:51:47

Higher Band Edge Plot for 16QAM-RB Size 25, RB Offset 0

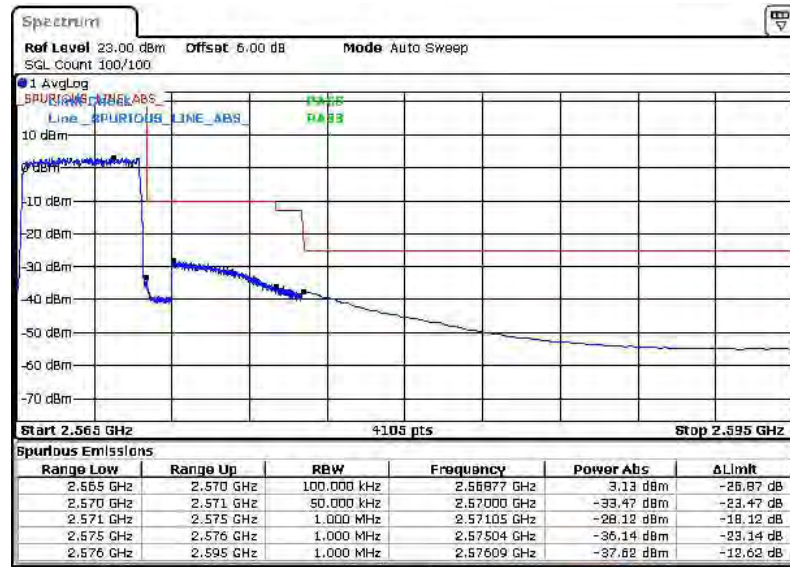

Date: 26 SEP 2014 11:54:00



Band :	LTE Band 7	Band Width :	10MHz / QPSK
--------	------------	--------------	--------------

Lower Band Edge Plot for QPSK-RB Size 1, RB Offset 0

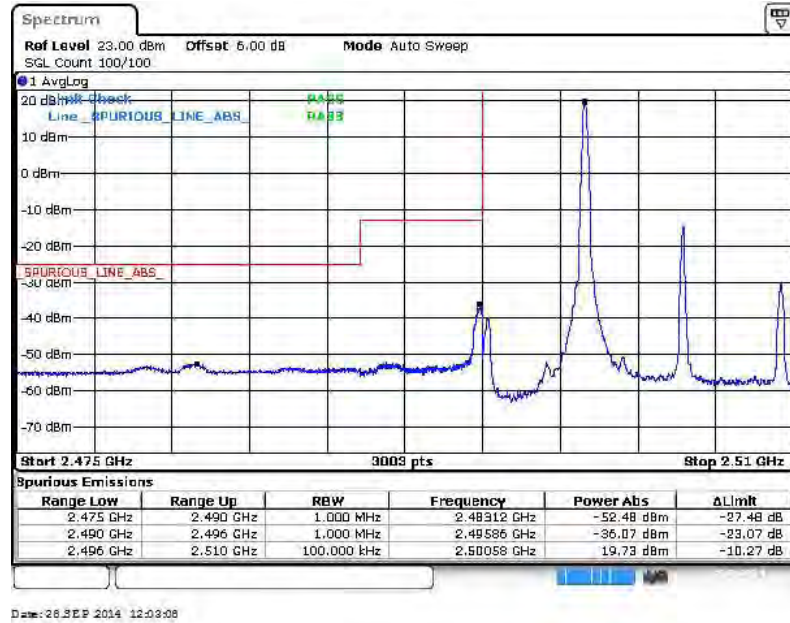

Lower Band Edge Plot for QPSK-RB Size 50, RB Offset 0

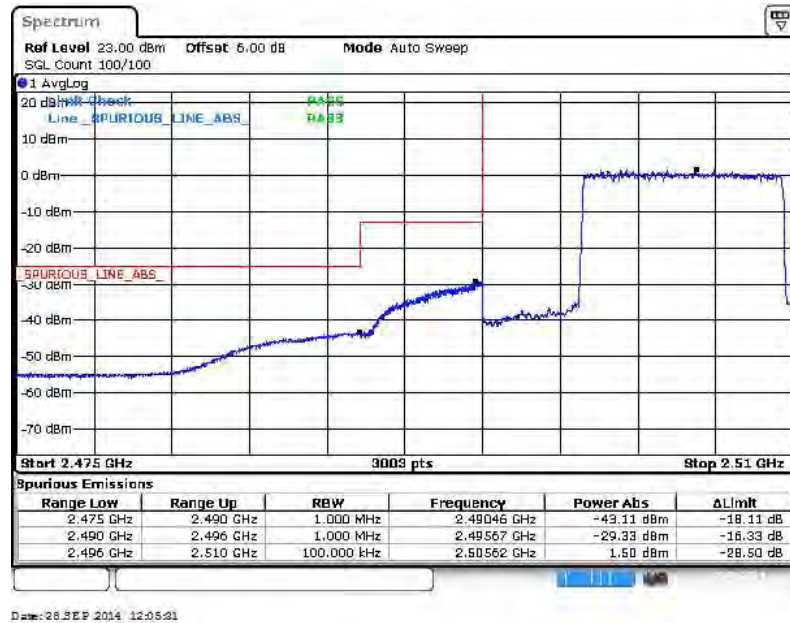



Higher Band Edge Plot for QPSK-RB Size 1, RB Offset 49

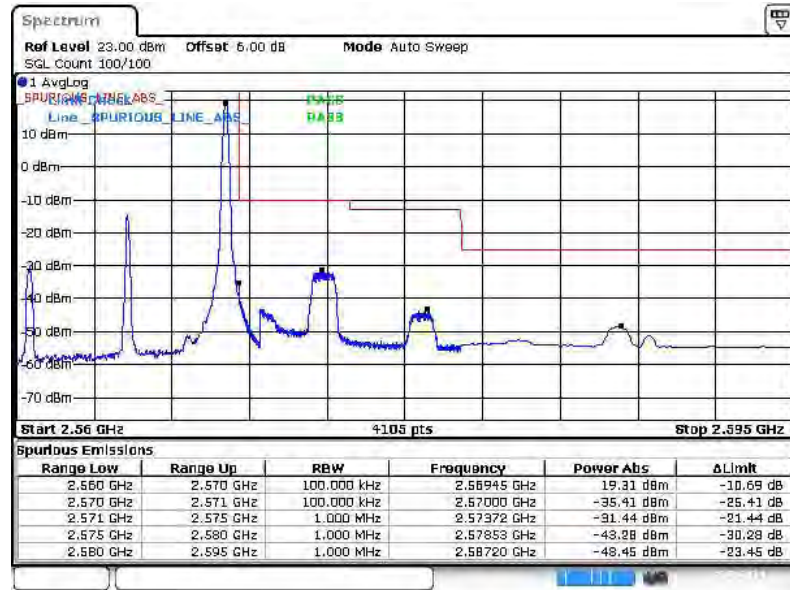

Date: 26 SEP 2014 12:07:53

Higher Band Edge Plot for QPSK-RB Size 50, RB Offset 0

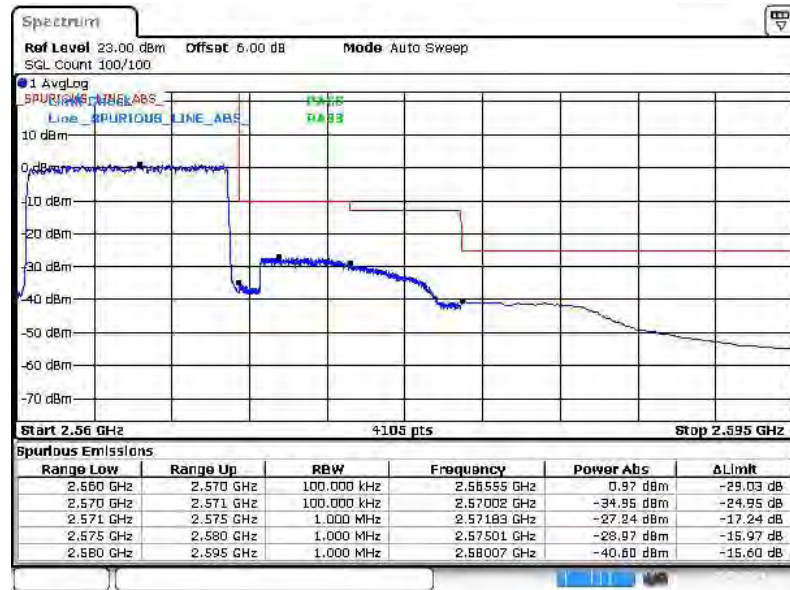

Date: 26 SEP 2014 12:10:16



Band :	LTE Band 7	Band Width :	10MHz / 16QAM
---------------	------------	---------------------	---------------

Lower Band Edge Plot for 16QAM-RB Size 1, RB Offset 0

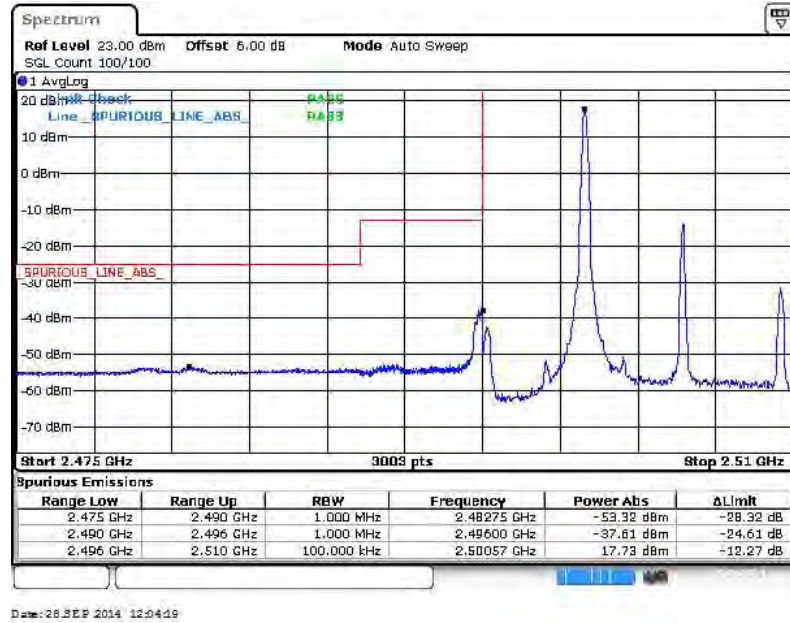

Lower Band Edge Plot for 16QAM-RB Size 50, RB Offset 0

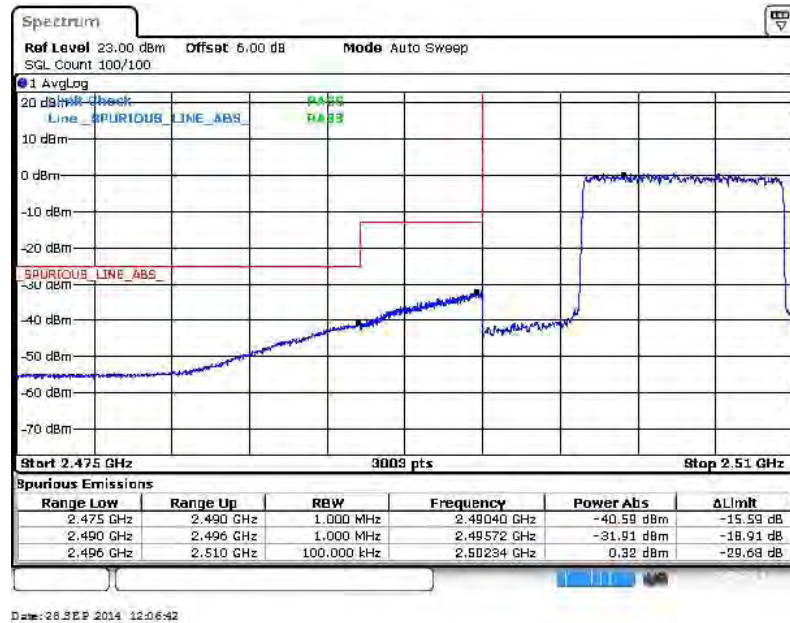



Higher Band Edge Plot for 16QAM-RB Size 1, RB Offset 49

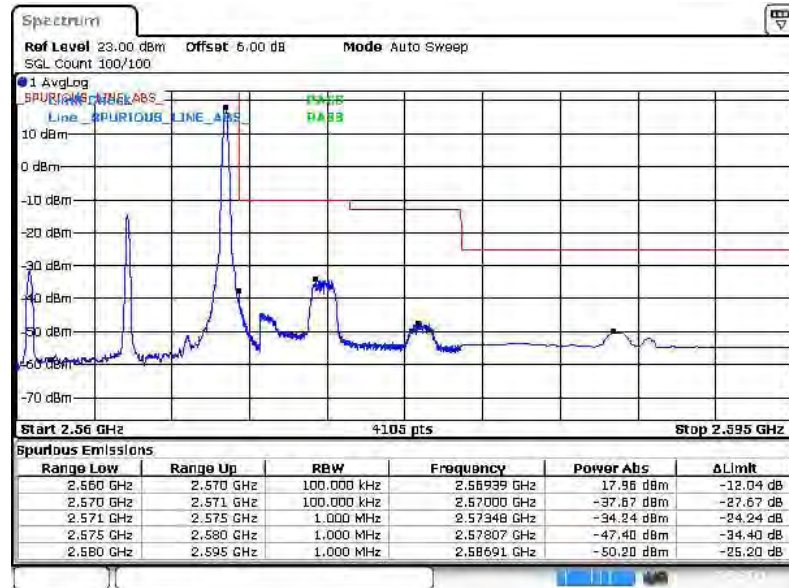

Date: 26 SEP 2014 12:09:05

Higher Band Edge Plot for 16QAM-RB Size 50, RB Offset 0

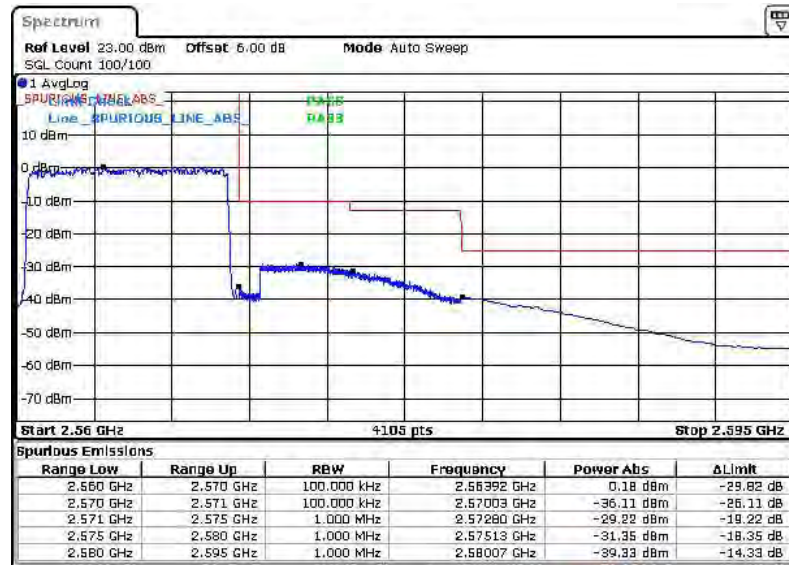

Date: 26 SEP 2014 12:11:27



Band :	LTE Band 7	Band Width :	15MHz / QPSK
--------	------------	--------------	--------------

Lower Band Edge Plot for QPSK-RB Size 1, RB Offset 0

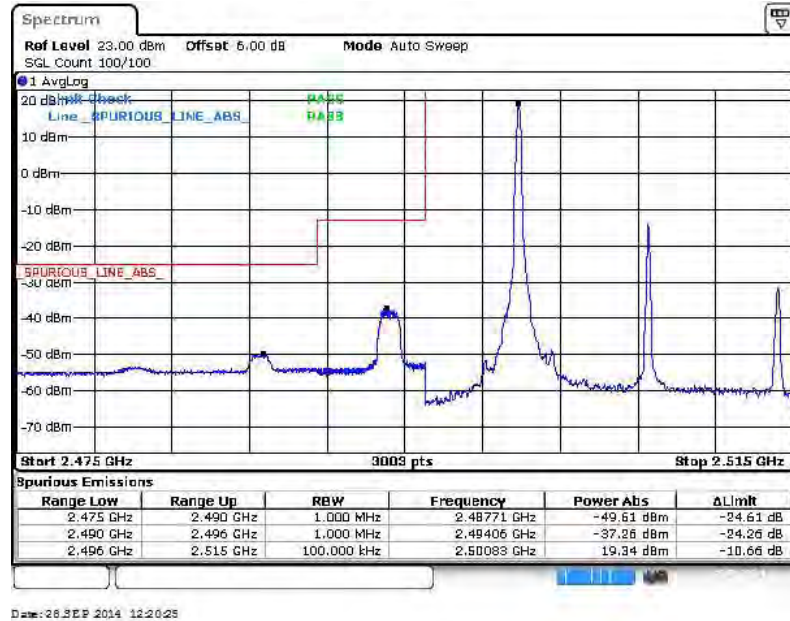

Lower Band Edge Plot for QPSK-RB Size 75, RB Offset 0

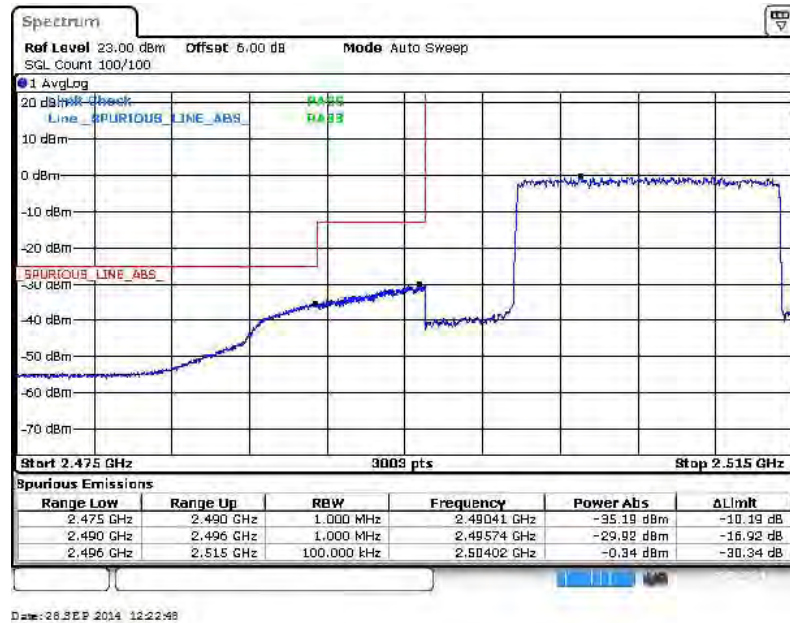



Higher Band Edge Plot for QPSK-RB Size 1, RB Offset 74

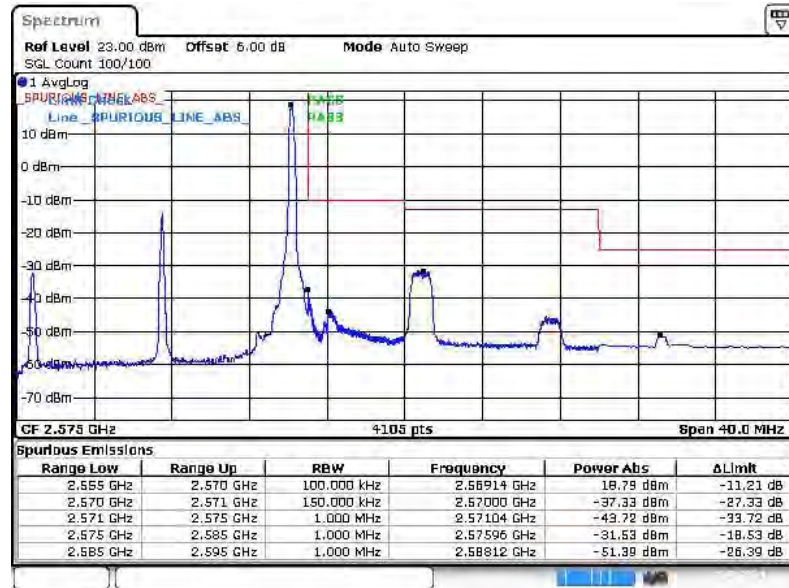

Date: 26 SEP 2014 12:25:11

Higher Band Edge Plot for QPSK-RB Size 75, RB Offset 0

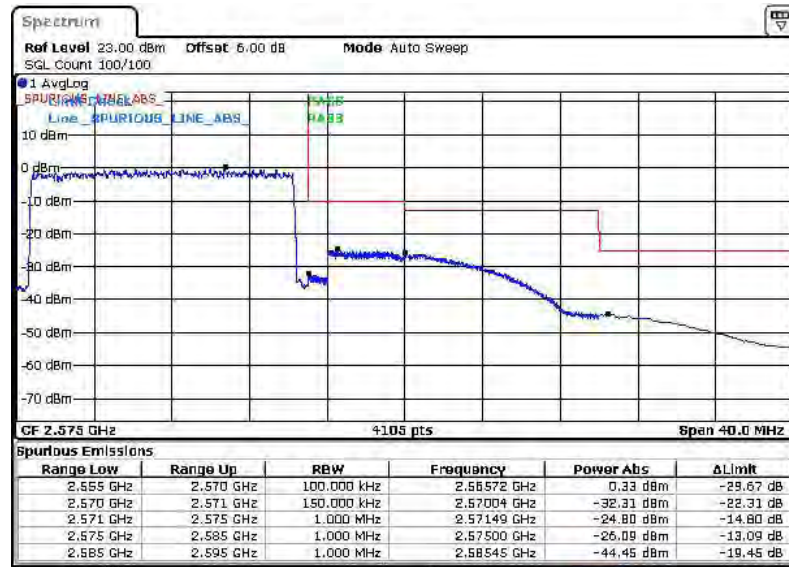

Date: 26 SEP 2014 12:27:03



Band :	LTE Band 7	Band Width :	15MHz / 16QAM
---------------	------------	---------------------	---------------

Lower Band Edge Plot for 16QAM-RB Size 1, RB Offset 0

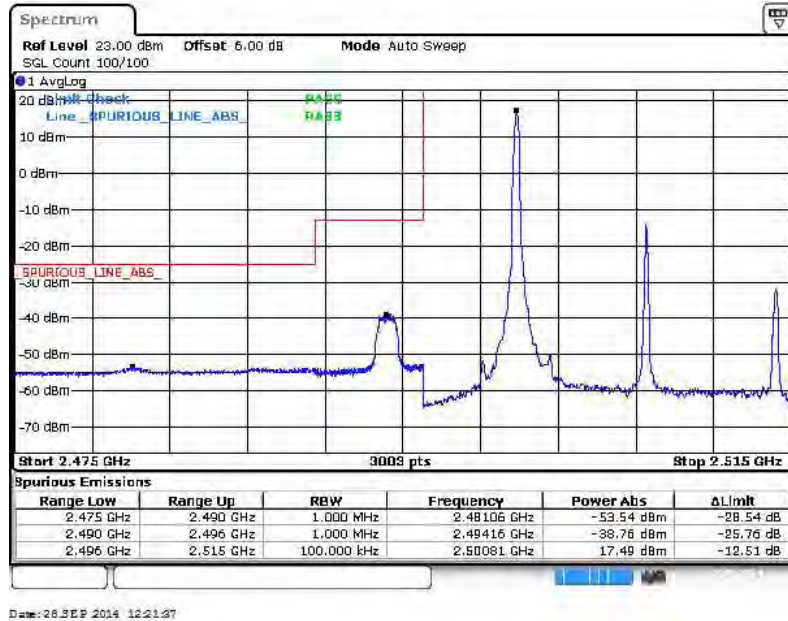

Lower Band Edge Plot for 16QAM-RB Size 75, RB Offset 0

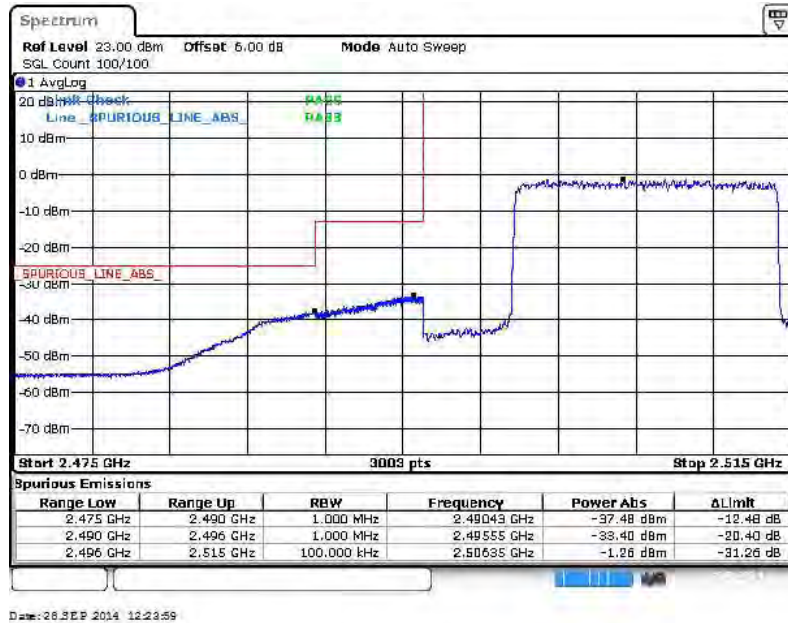



Higher Band Edge Plot for 16QAM-RB Size 1, RB Offset 74

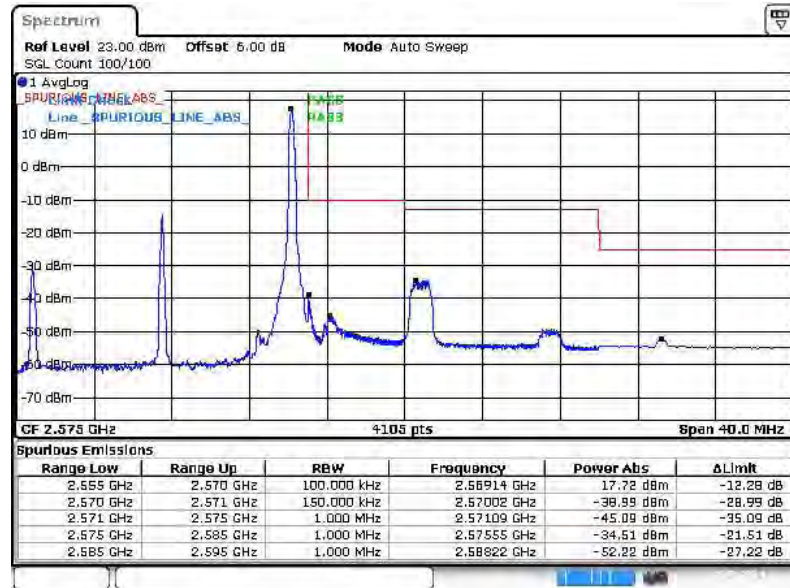

Date: 26 SEP 2014 12:26:22

Higher Band Edge Plot for 16QAM-RB Size 75, RB Offset 0

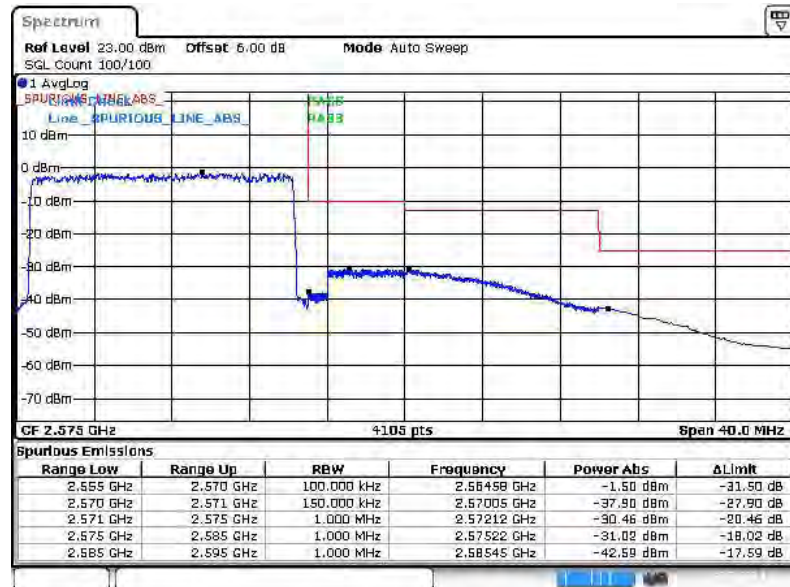

Date: 26 SEP 2014 12:26:45



Band :	LTE Band 7	Band Width :	20MHz / QPSK
--------	------------	--------------	--------------

Lower Band Edge Plot for QPSK-RB Size 1, RB Offset 0

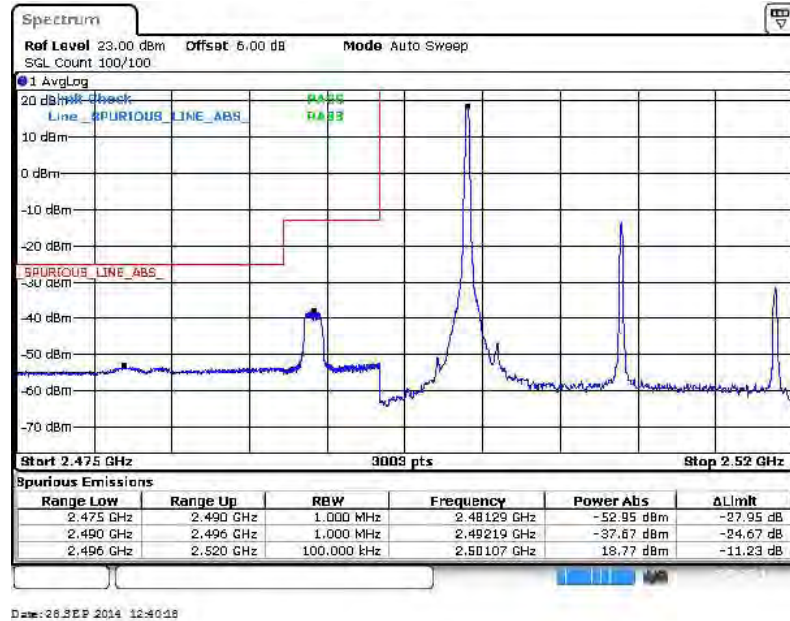

Lower Band Edge Plot for QPSK-RB Size 100, RB Offset 0

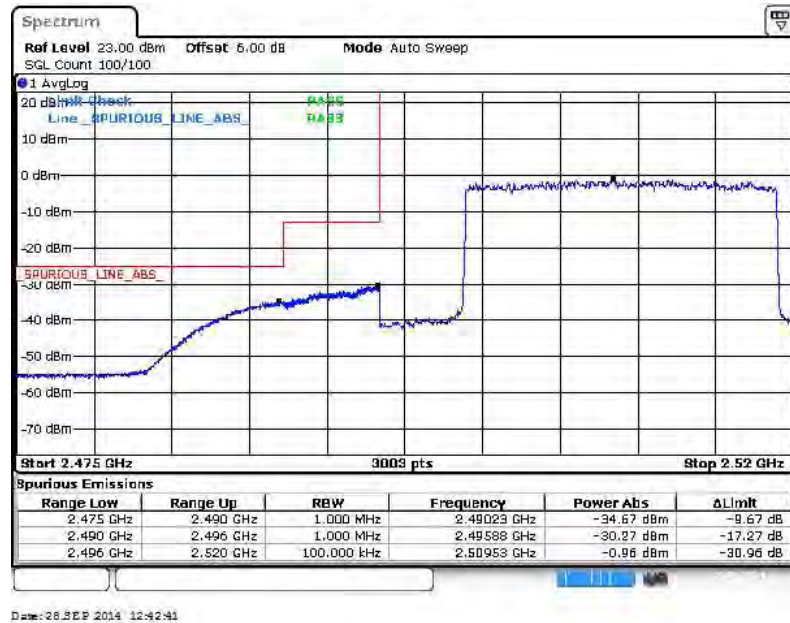



Higher Band Edge Plot for QPSK-RB Size 1, RB Offset 99

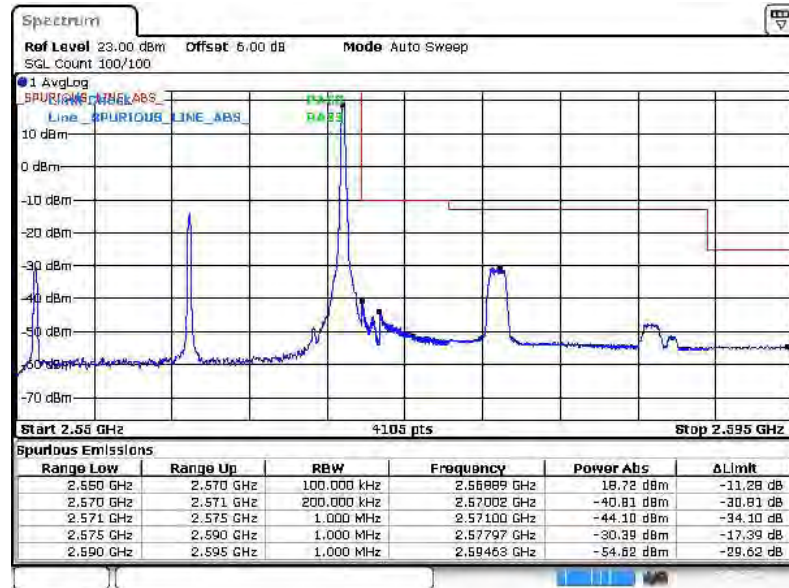

Date: 26 SEP 2014 12:45:03

Higher Band Edge Plot for QPSK-RB Size 100, RB Offset 0

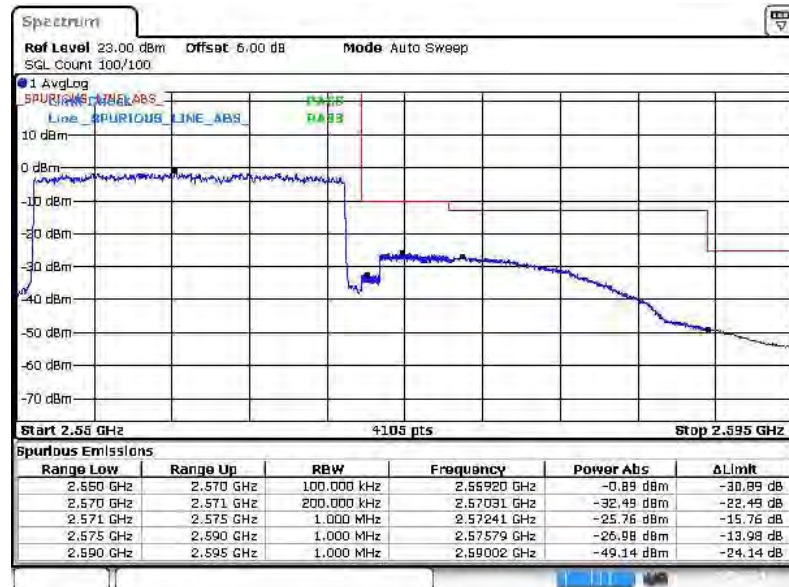

Date: 26 SEP 2014 12:47:26



Band :	LTE Band 7	Band Width :	20MHz / 16QAM
---------------	------------	---------------------	---------------

Lower Band Edge Plot for 16QAM-RB Size 1, RB Offset 0

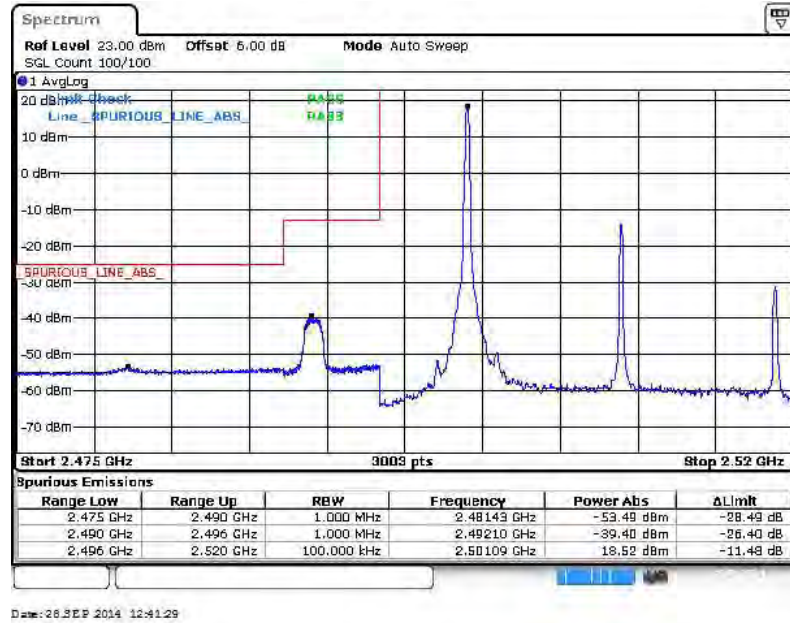

Lower Band Edge Plot for 16QAM-RB Size 100, RB Offset 0

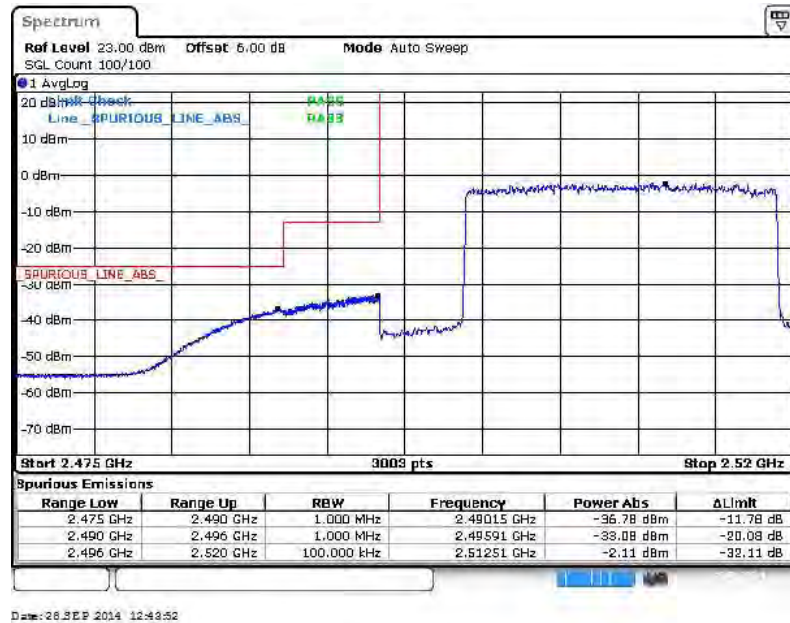



Higher Band Edge Plot for 16QAM-RB Size 1, RB Offset 99

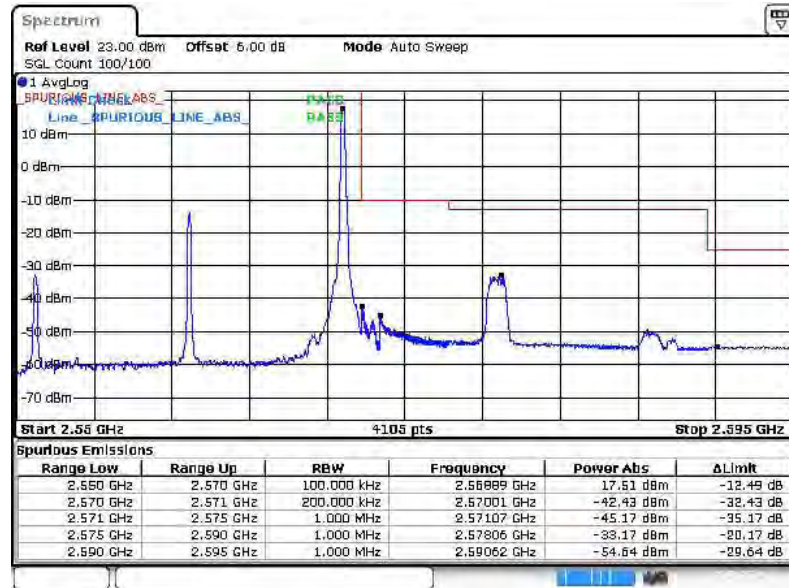

Date: 26 SEP 2014 12:46:15

Higher Band Edge Plot for 16QAM-RB Size 100, RB Offset 0

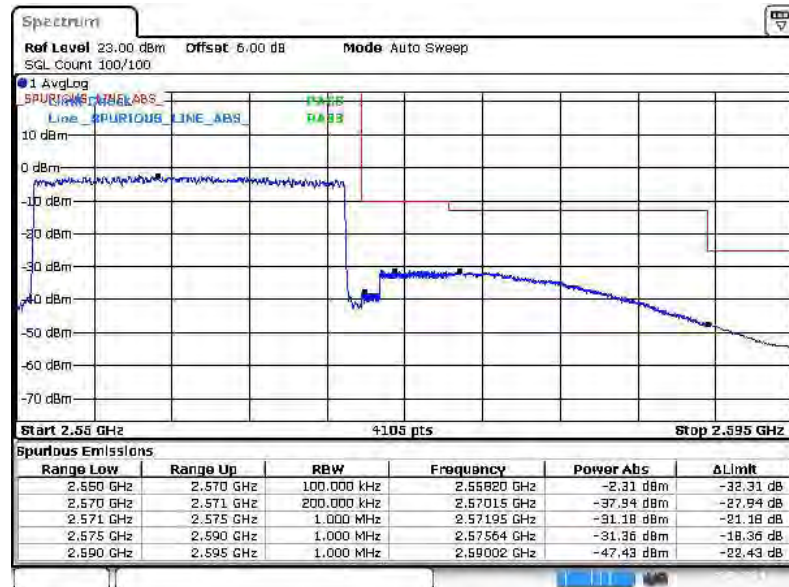

Date: 26 SEP 2014 12:48:27



Band :	LTE Band 2	Band Width :	1.4MHz / QPSK
--------	------------	--------------	---------------

Lower Band Edge Plot for QPSK-RB Size 1, RB Offset 0

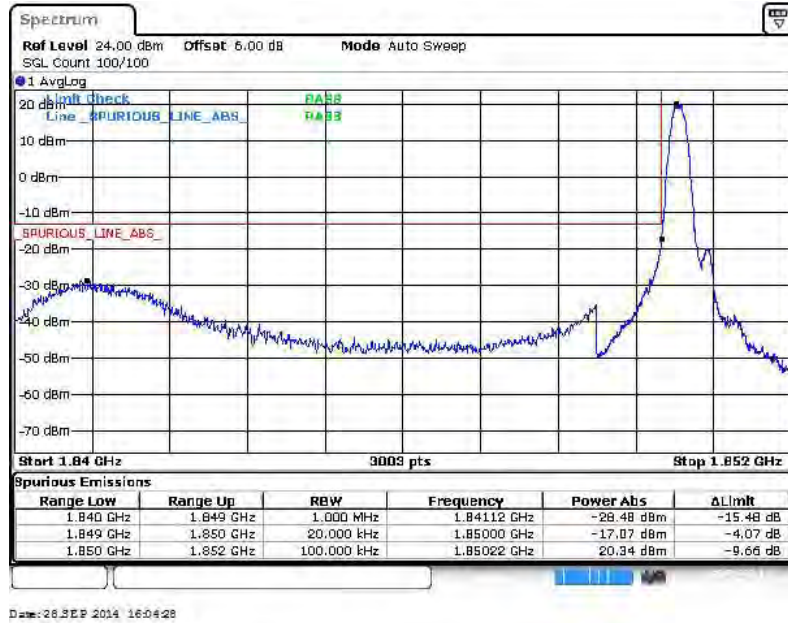

Lower Band Edge Plot for QPSK-RB Size 6, RB Offset 0

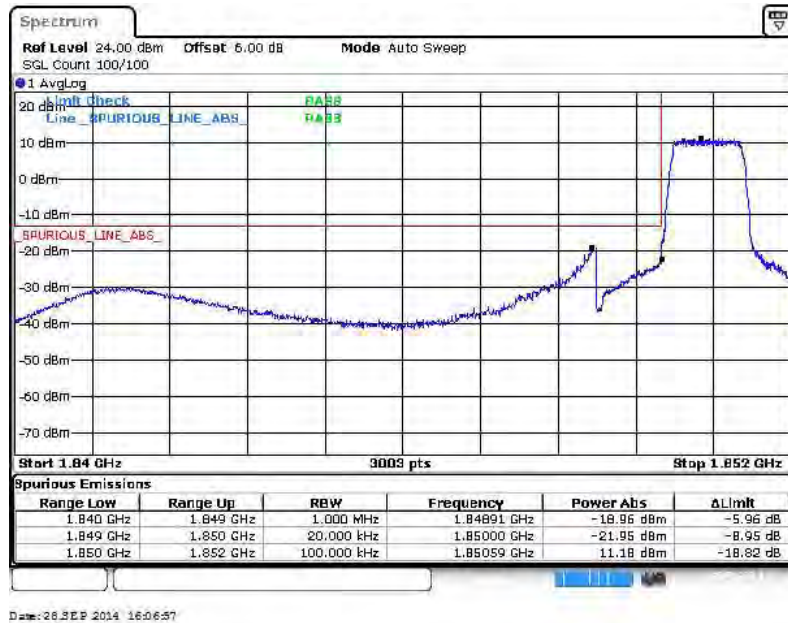



Higher Band Edge Plot for QPSK-RB Size 1, RB Offset 5

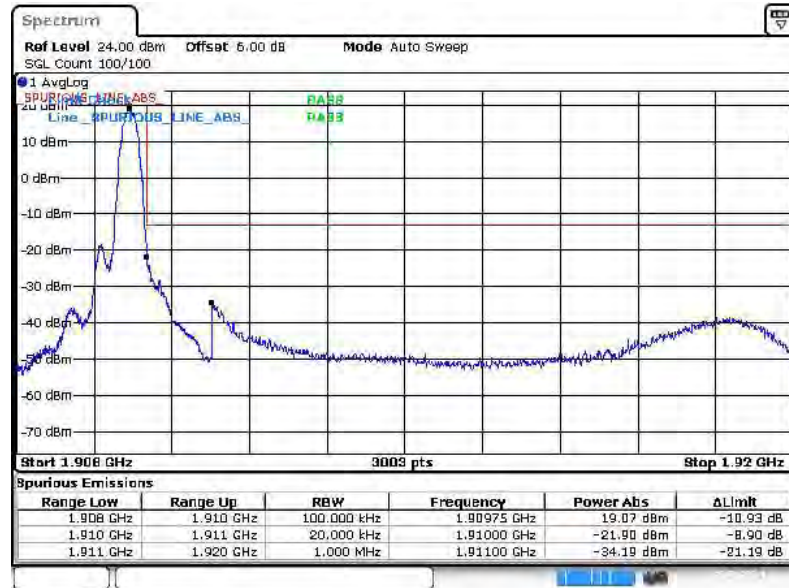

Date: 28 SEP 2014 16:09:25

Higher Band Edge Plot for QPSK-RB Size 6, RB Offset 0

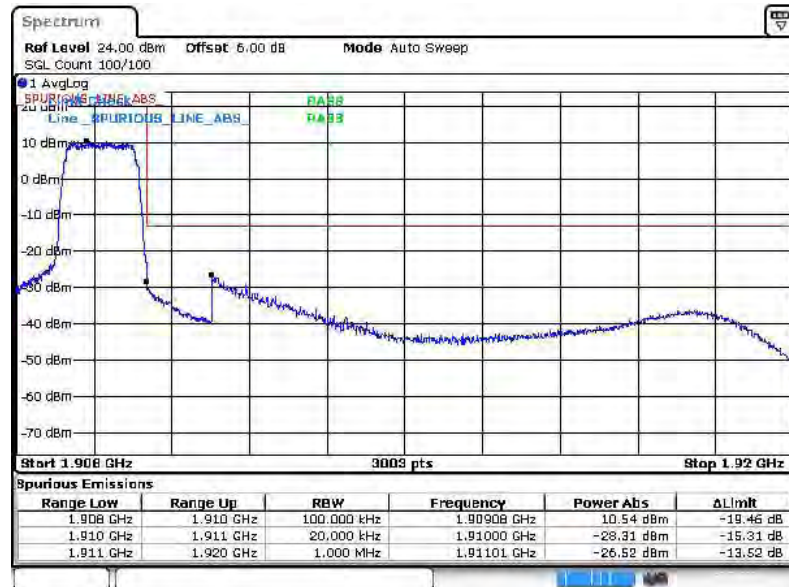

Date: 28 SEP 2014 16:11:54



Band :	LTE Band 2	Band Width :	1.4MHz / 16QAM
--------	------------	--------------	----------------

Lower Band Edge Plot for 16QAM -RB Size 1, RB Offset 0

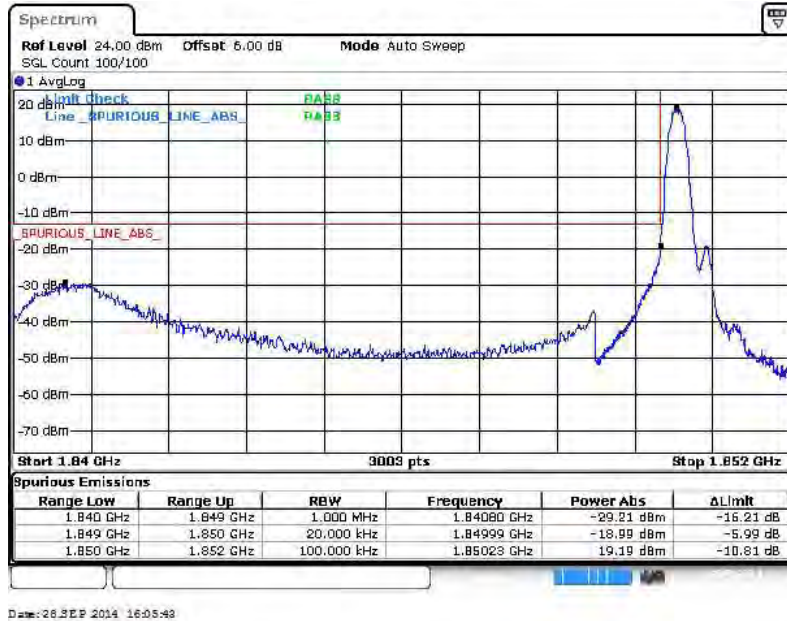

Lower Band Edge Plot for 16QAM -RB Size 6, RB Offset 0

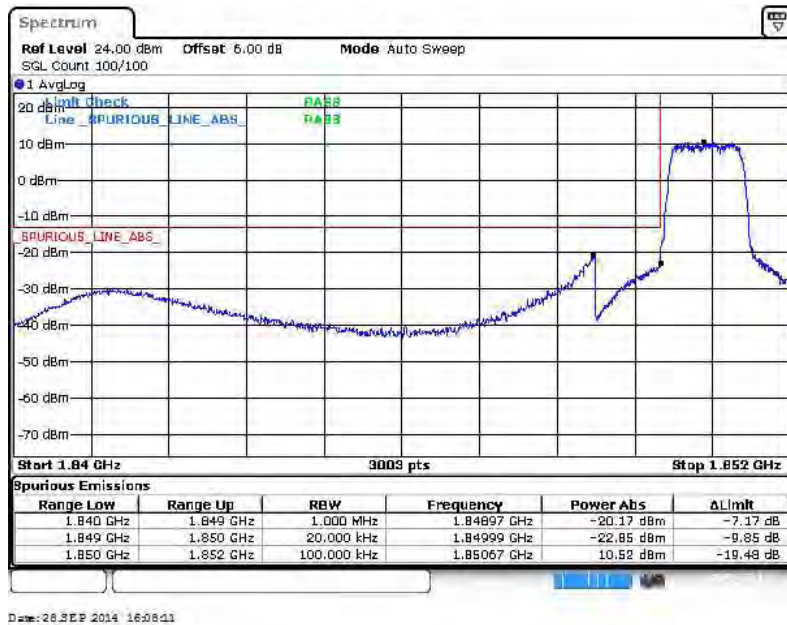



Higher Band Edge Plot for 16QAM -RB Size 1, RB Offset 5

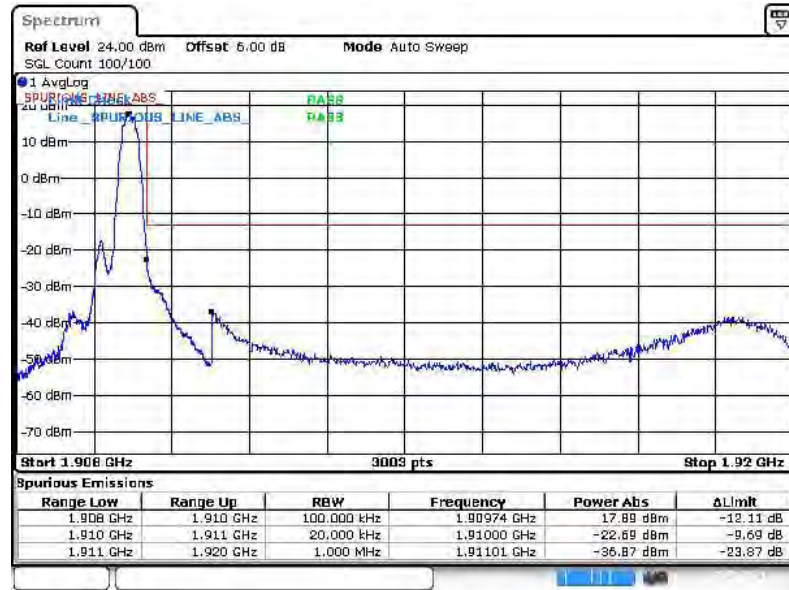

Date: 28 SEP 2014 16:10:40

Higher Band Edge Plot for 16QAM -RB Size 6, RB Offset 0

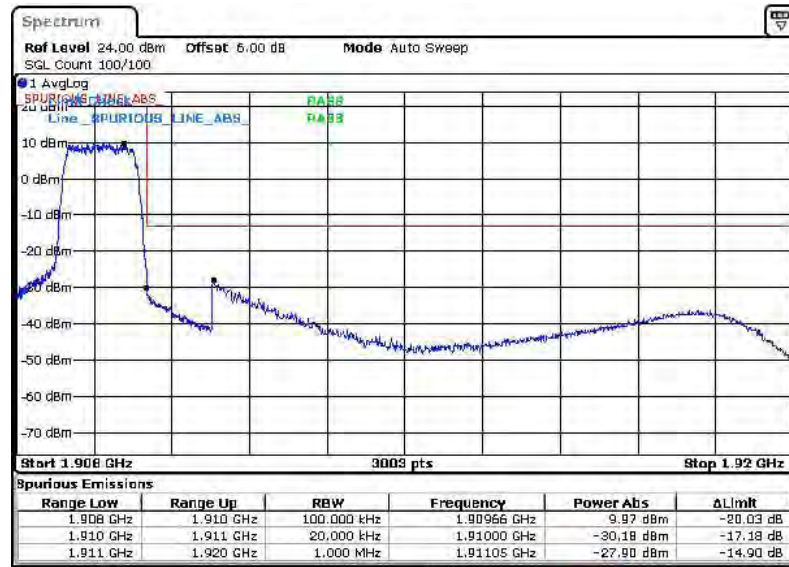

Date: 28 SEP 2014 16:13:08



Band :	LTE Band 2	Band Width :	3MHz / QPSK
---------------	------------	---------------------	-------------

Lower Band Edge Plot for QPSK-RB Size 1, RB Offset 0

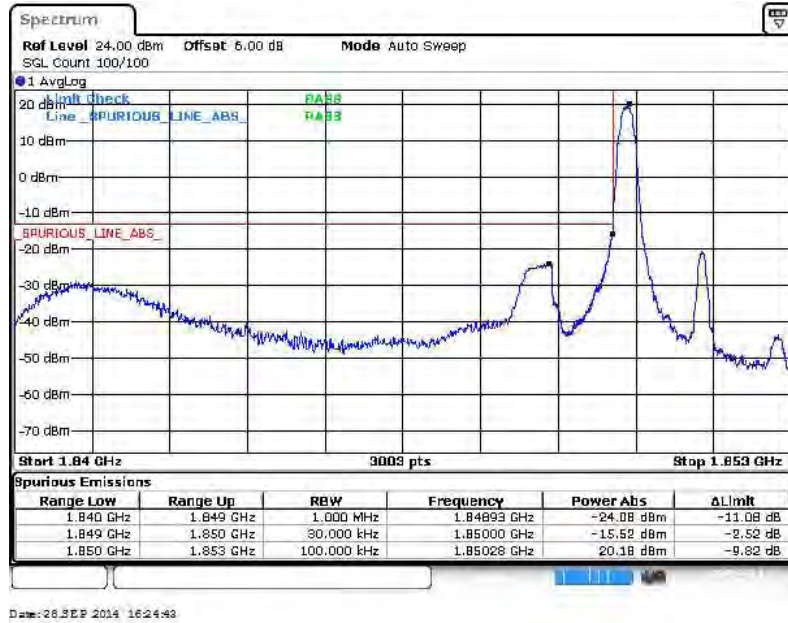

Lower Band Edge Plot for QPSK-RB Size 15, RB Offset 0

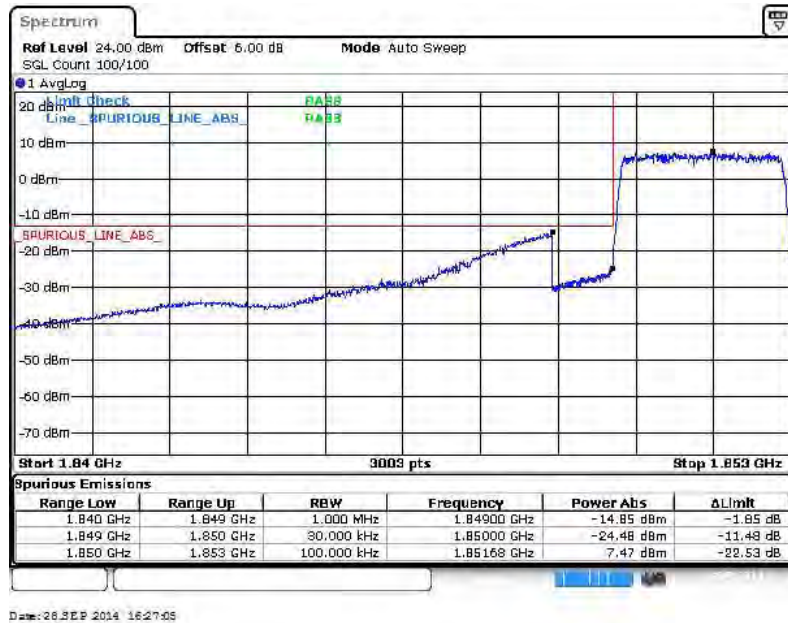



Higher Band Edge Plot for QPSK-RB Size 1, RB Offset 14

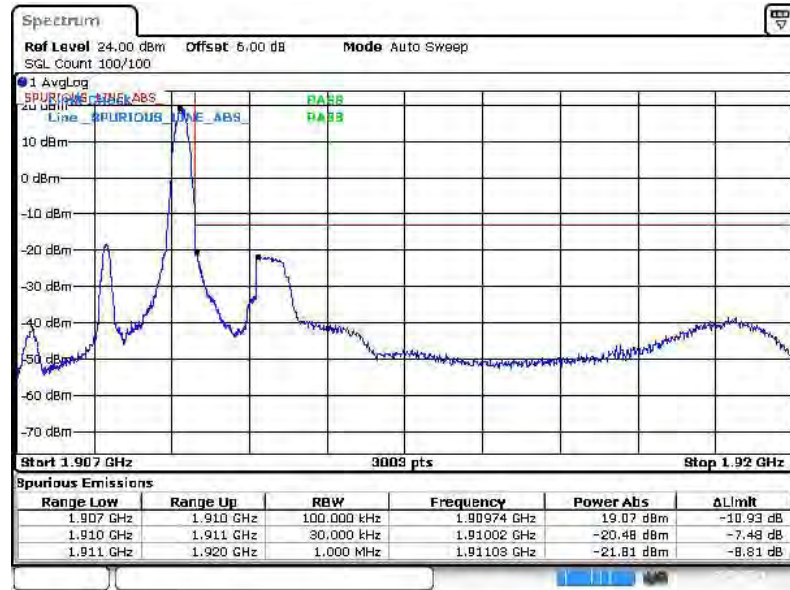

Date: 28 SEP 2014 16:29:27

Higher Band Edge Plot for QPSK-RB Size 15, RB Offset 0

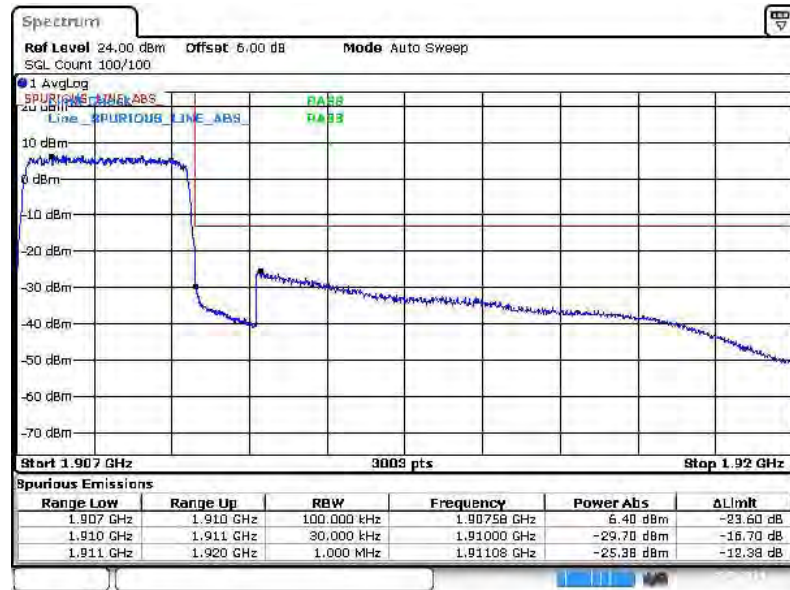

Date: 28 SEP 2014 16:21:50



Band :	LTE Band 2	Band Width :	3MHz / 16QAM
--------	------------	--------------	--------------

Lower Band Edge Plot for 16QAM -RB Size 1, RB Offset 0

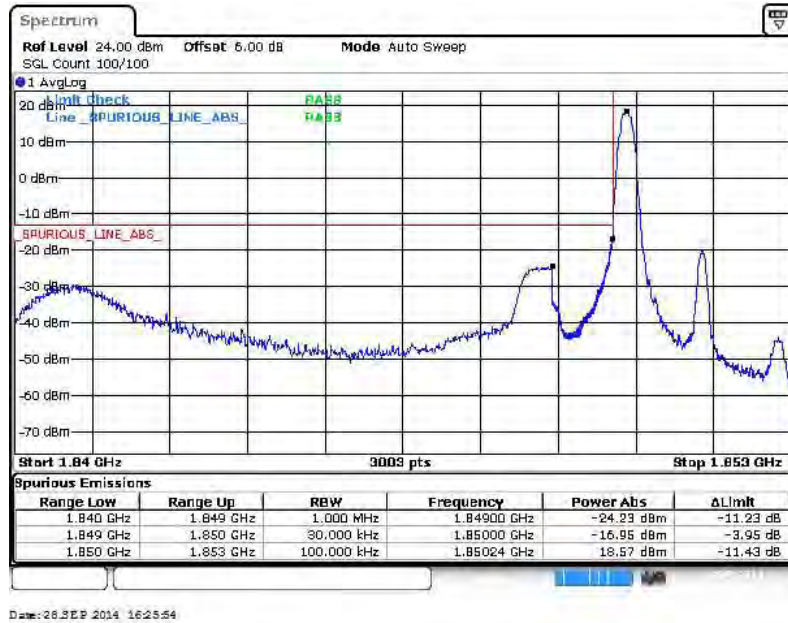

Lower Band Edge Plot for 16QAM -RB Size 15, RB Offset 0

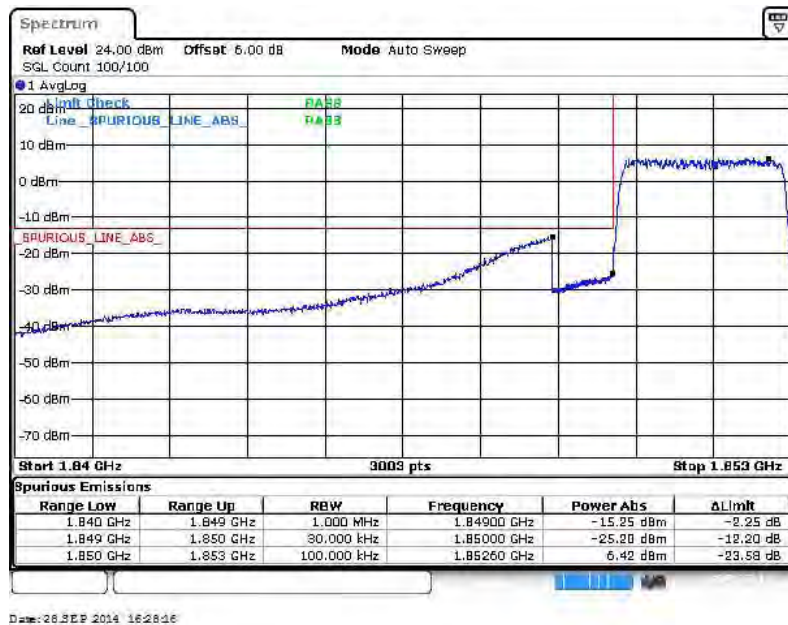



Higher Band Edge Plot for 16QAM -RB Size 1, RB Offset 14

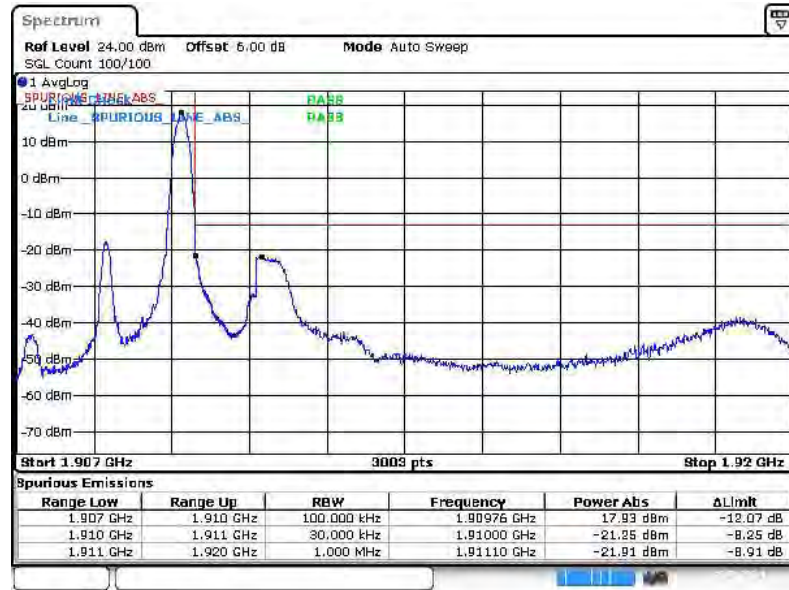

Date: 26 SEP 2014 16:20:29

Higher Band Edge Plot for 16QAM -RB Size 15, RB Offset 0

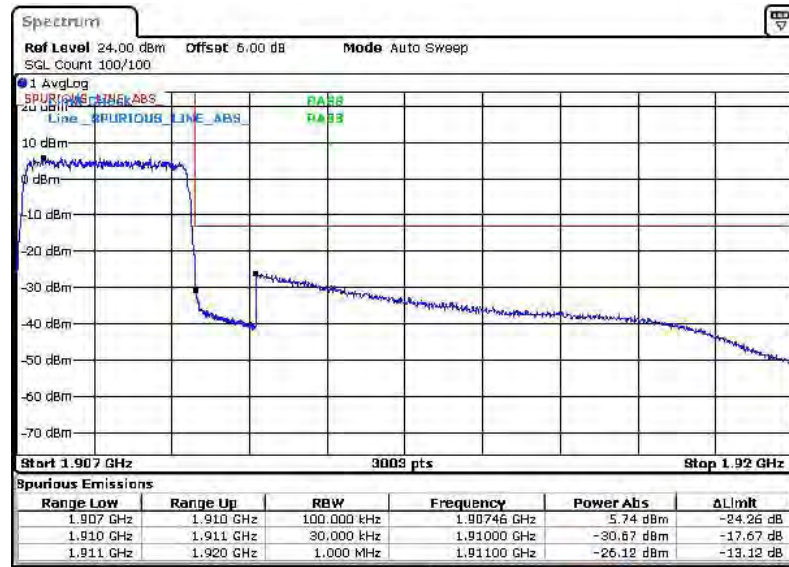

Date: 26 SEP 2014 16:23:01



Band :	LTE Band 2	Band Width :	5MHz / QPSK
--------	------------	--------------	-------------

Lower Band Edge Plot for QPSK-RB Size 1, RB Offset 0

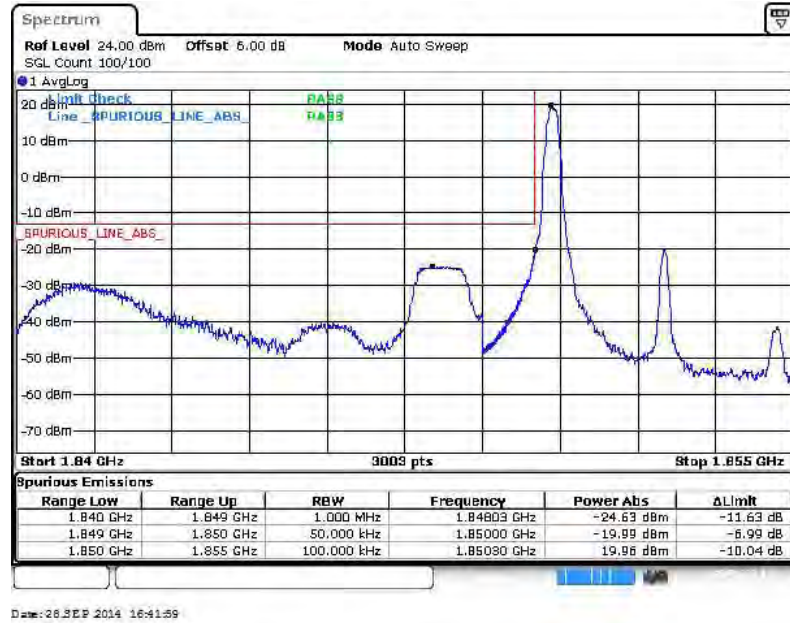

Lower Band Edge Plot for QPSK-RB Size 25, RB Offset 0

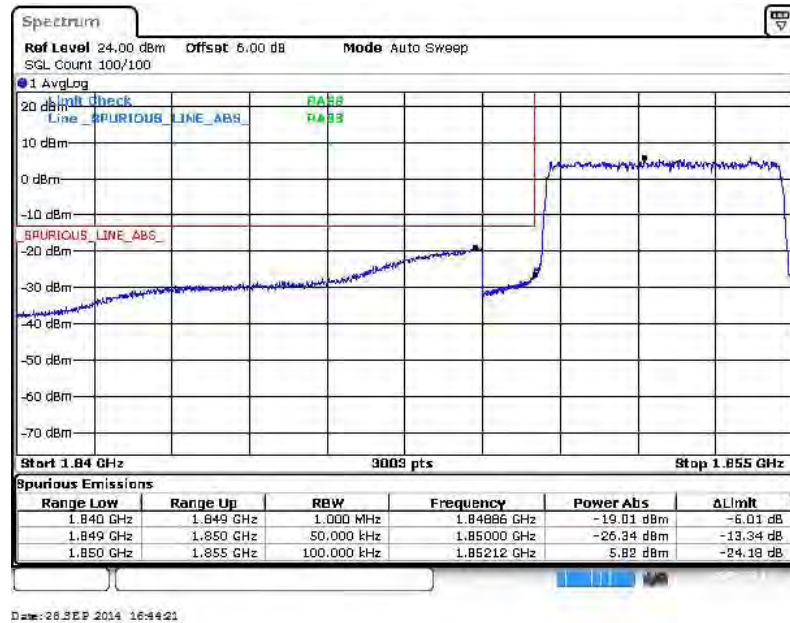



Higher Band Edge Plot for QPSK-RB Size 1, RB Offset 24

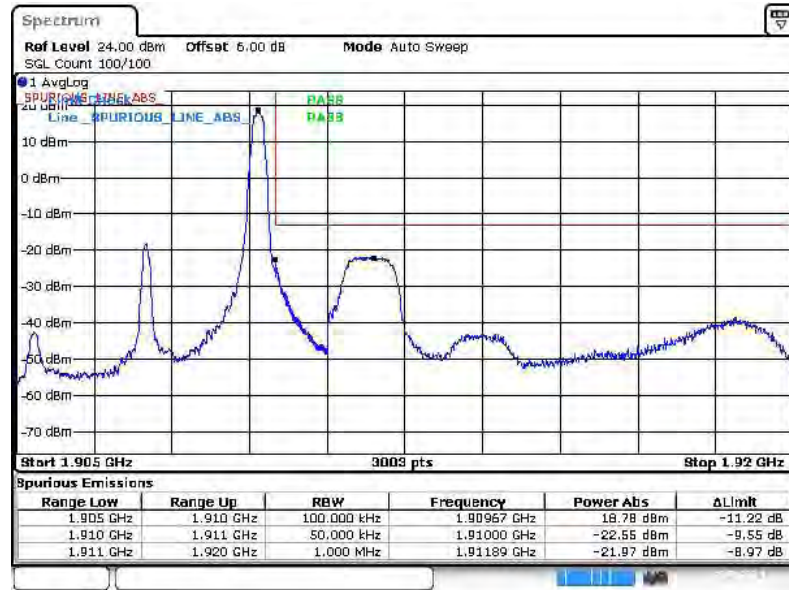

Date: 28 SEP 2014 16:46:44

Higher Band Edge Plot for QPSK-RB Size 25, RB Offset 0



Date: 28 SEP 2014 16:49:06



Band :	LTE Band 2	Band Width :	5MHz / 16QAM
--------	------------	--------------	--------------

Lower Band Edge Plot for 16QAM-RB Size 1, RB Offset 0

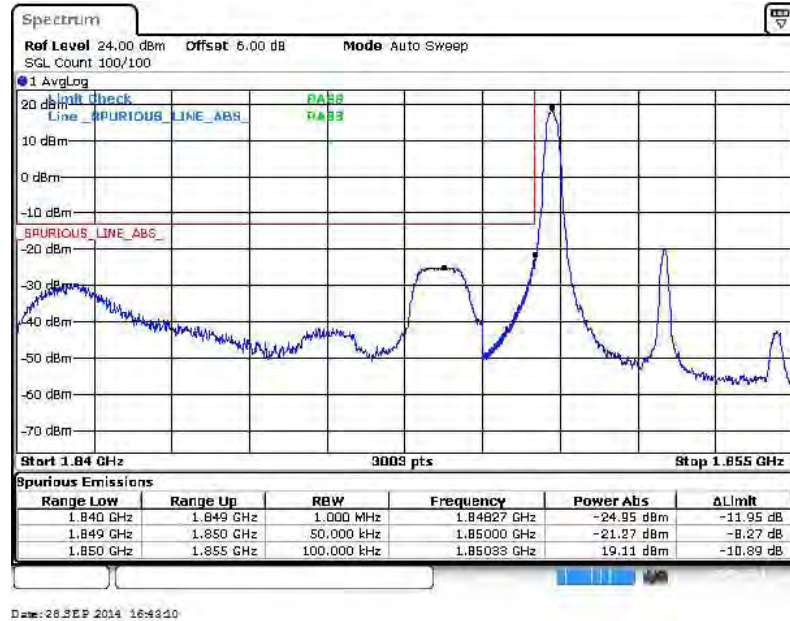

Lower Band Edge Plot for 16QAM-RB Size 25, RB Offset 0

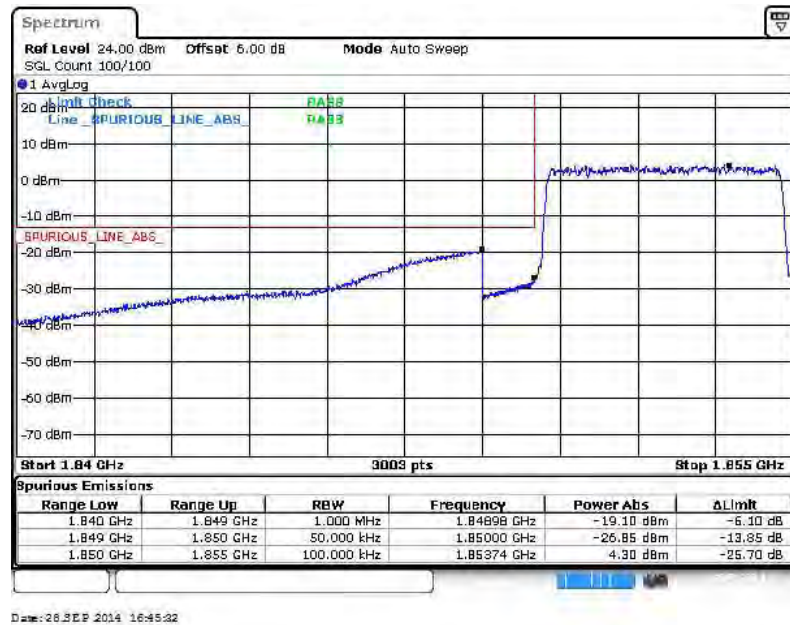



Higher Band Edge Plot for 16QAM-RB Size 1, RB Offset 24

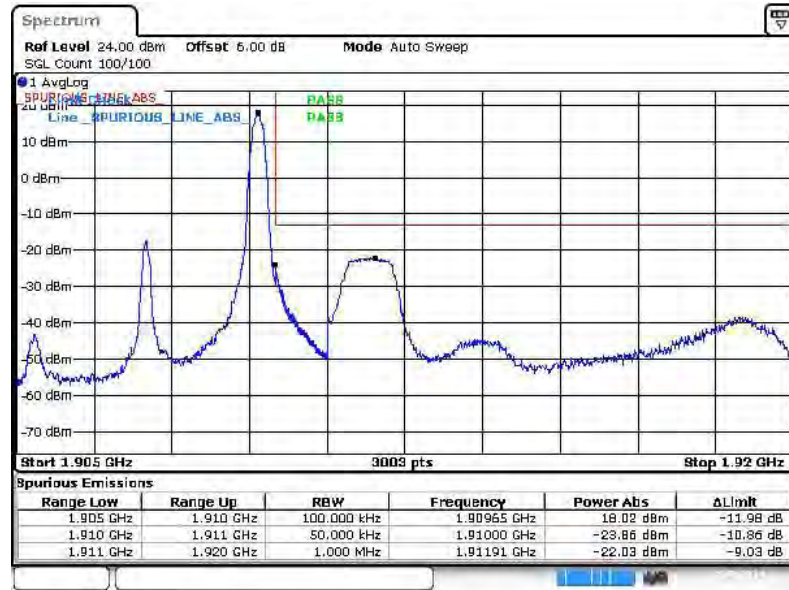

Date: 28 SEP 2014 16:47:55

Higher Band Edge Plot for 16QAM-RB Size 25, RB Offset 0

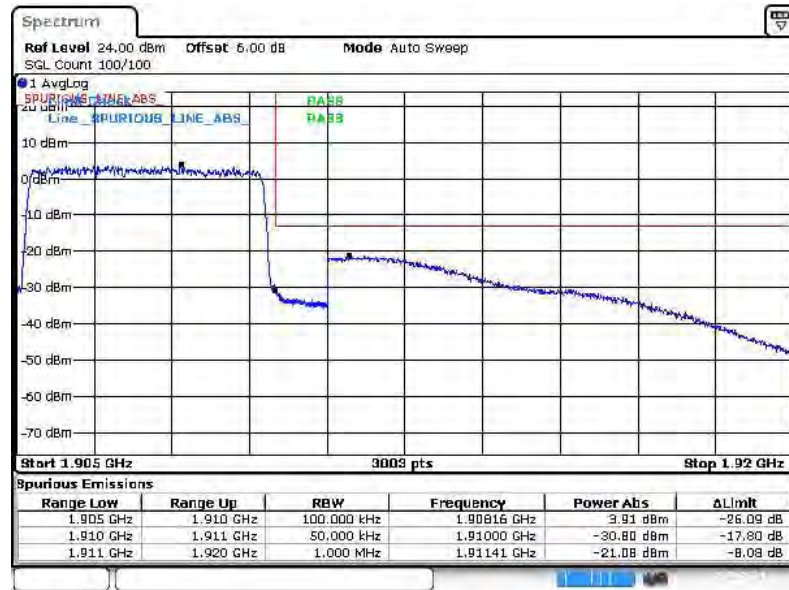

Date: 28 SEP 2014 16:50:17



Band :	LTE Band 2	Band Width :	10MHz / QPSK
--------	------------	--------------	--------------

Lower Band Edge Plot for QPSK-RB Size 1, RB Offset 0

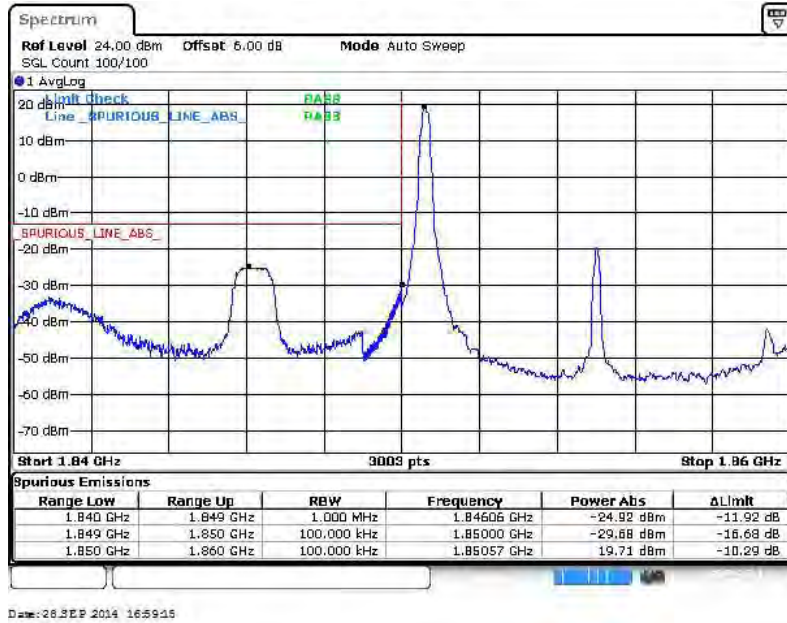

Lower Band Edge Plot for QPSK-RB Size 50, RB Offset 0

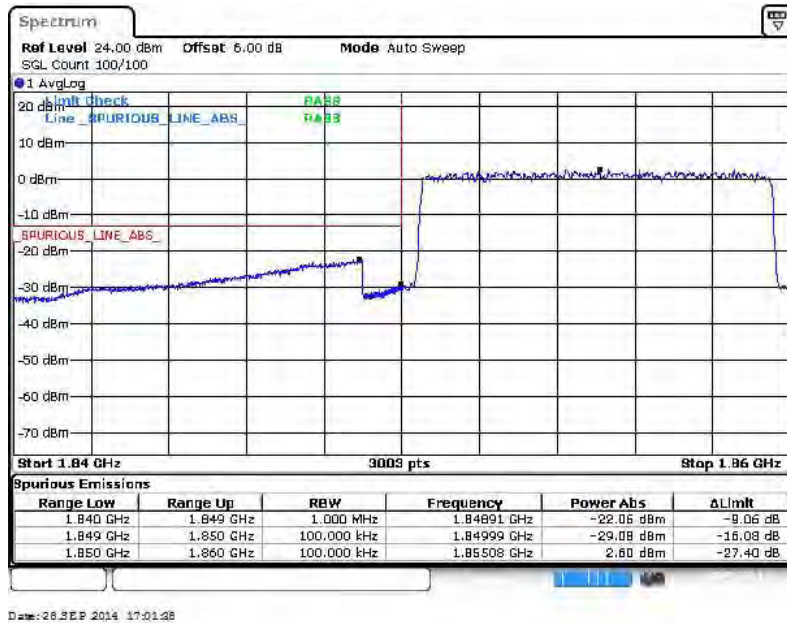



Higher Band Edge Plot for QPSK-RB Size 1, RB Offset 49

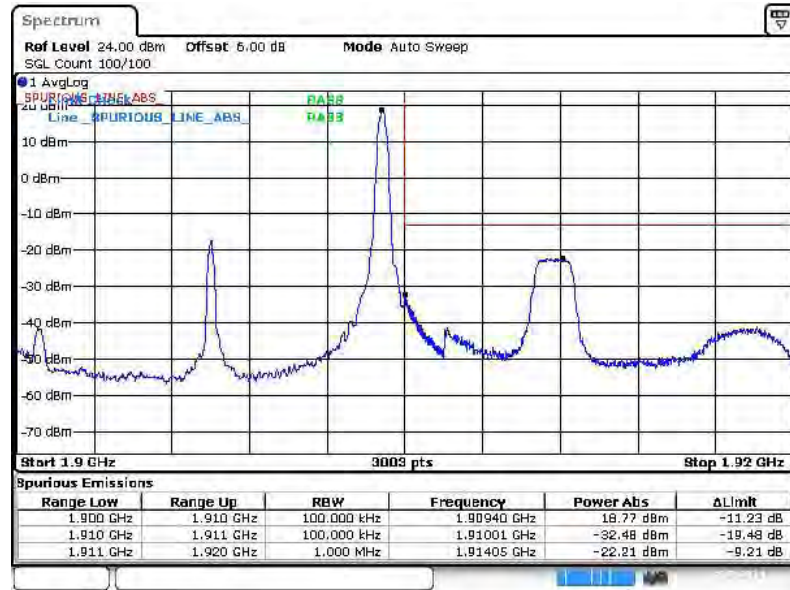

Date: 28 SEP 2014 17:04:00

Higher Band Edge Plot for QPSK-RB Size 50, RB Offset 0

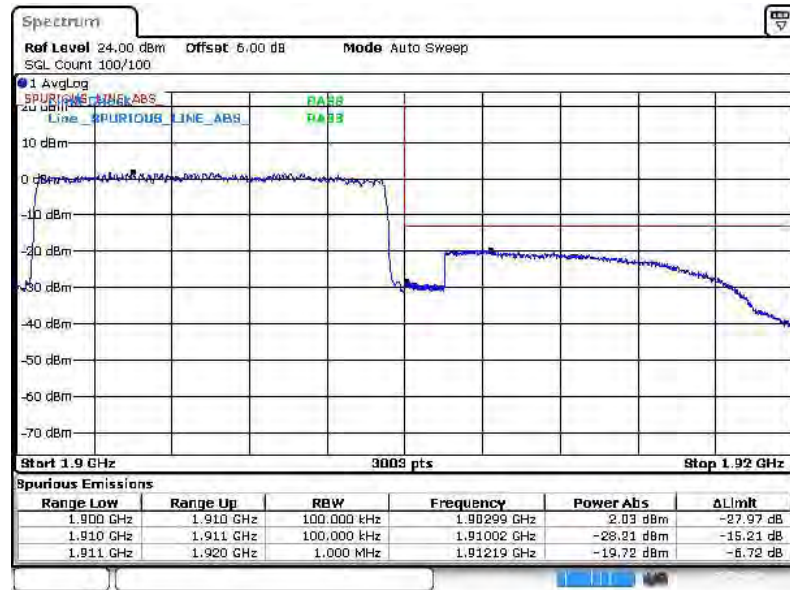

Date: 28 SEP 2014 17:07:24



Band :	LTE Band 2	Band Width :	10MHz / 16QAM
---------------	------------	---------------------	---------------

Lower Band Edge Plot for 16QAM-RB Size 1, RB Offset 0

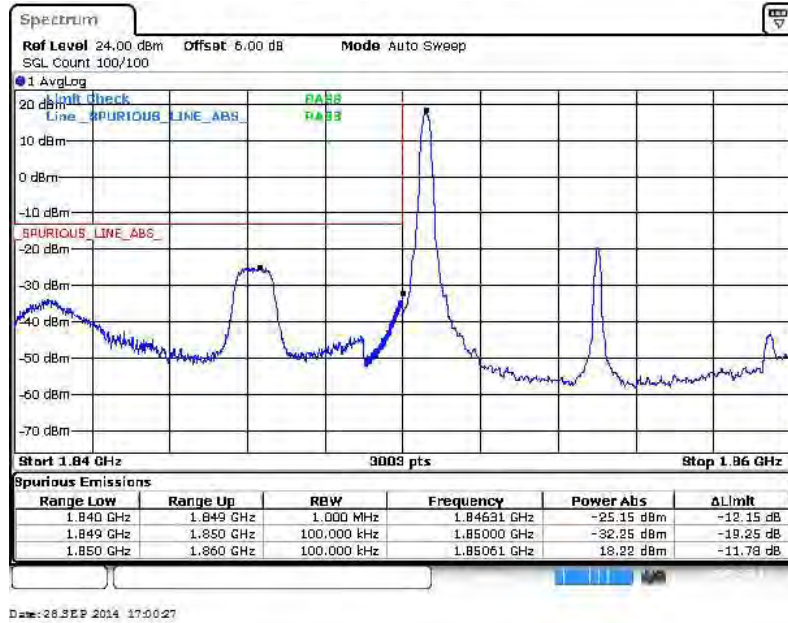

Lower Band Edge Plot for 16QAM-RB Size 50, RB Offset 0

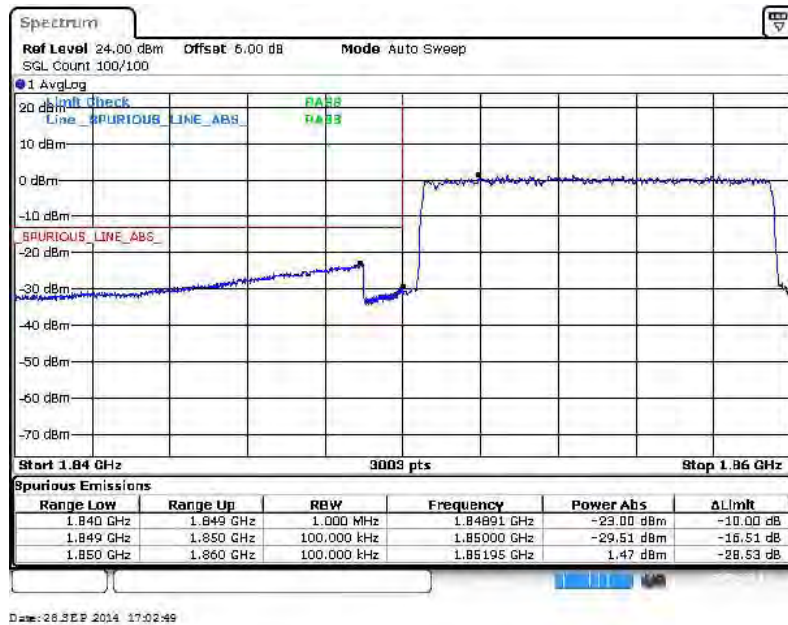



Higher Band Edge Plot for 16QAM-RB Size 1, RB Offset 49

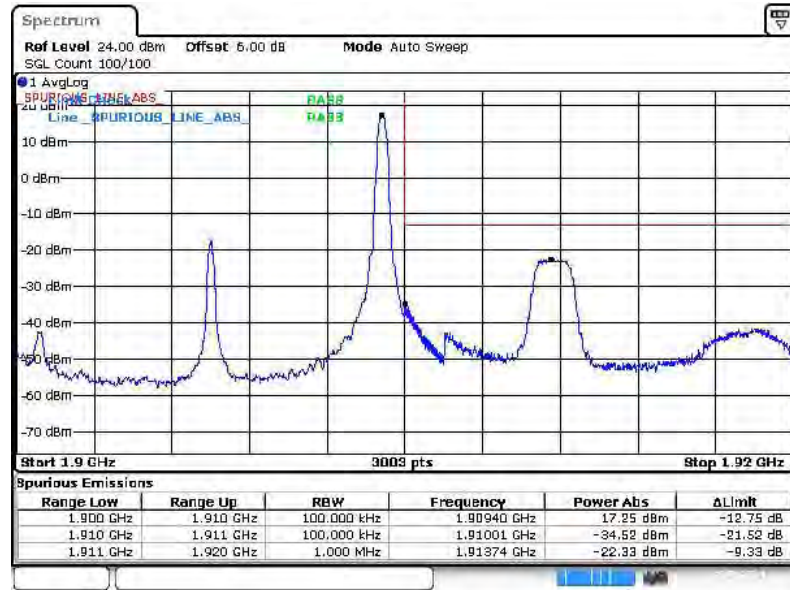

Date: 28 SEP 2014 17:05:11

Higher Band Edge Plot for 16QAM-RB Size 50, RB Offset 0

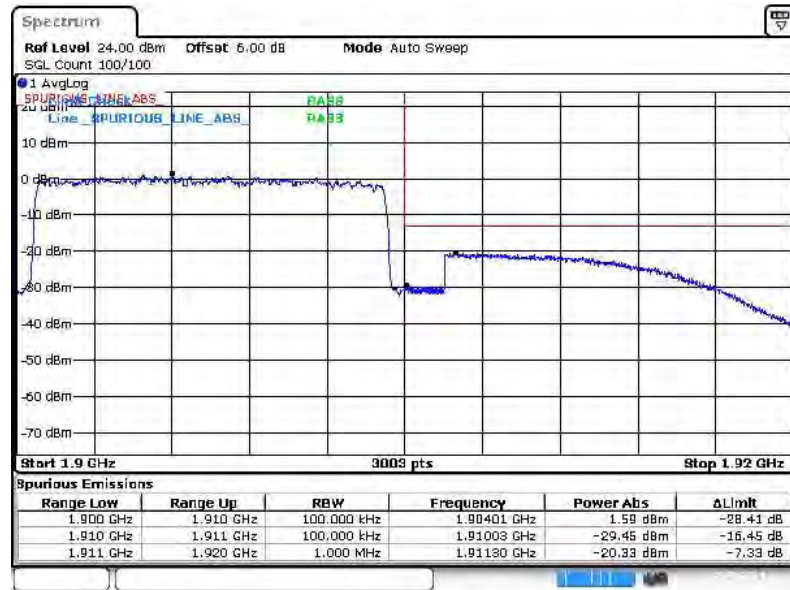

Date: 28 SEP 2014 17:06:23



Band :	LTE Band 2	Band Width :	15MHz / QPSK
--------	------------	--------------	--------------

Lower Band Edge Plot for QPSK-RB Size 1, RB Offset 0

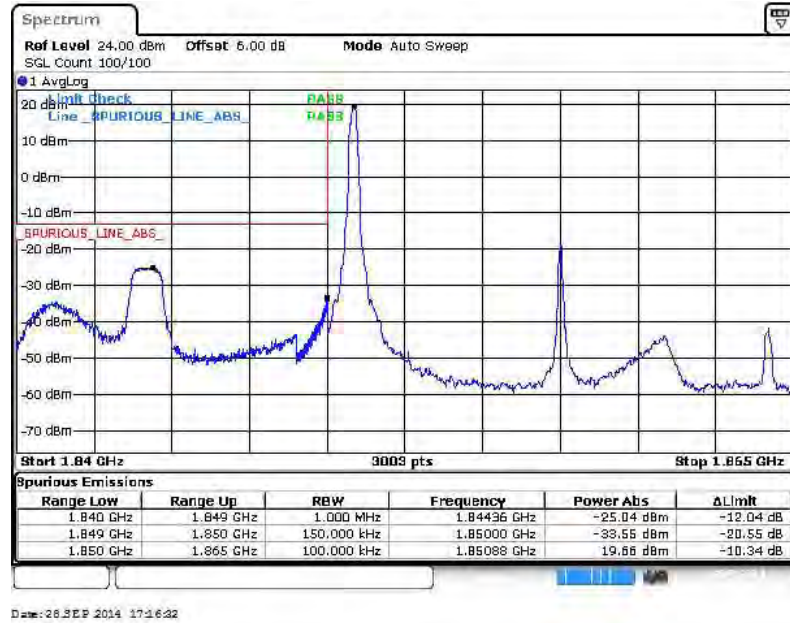

Lower Band Edge Plot for QPSK-RB Size 75, RB Offset 0

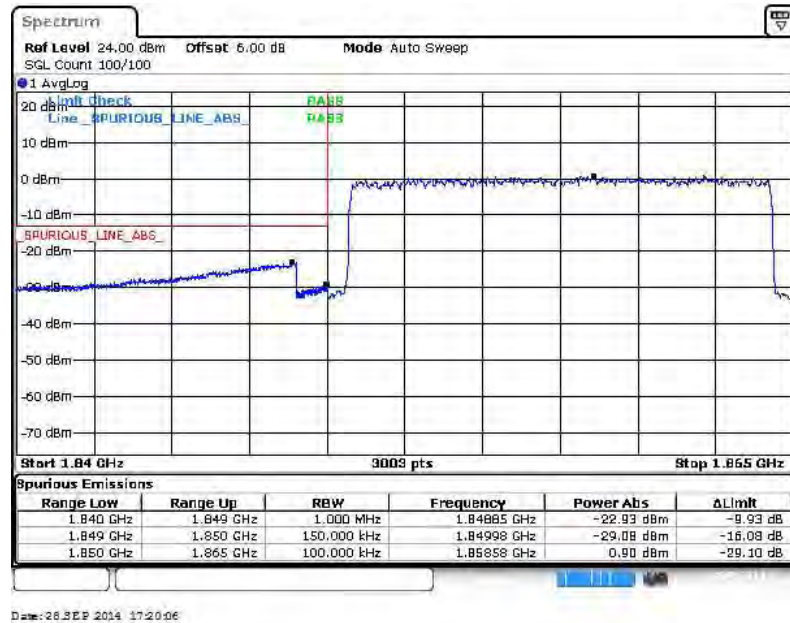



Higher Band Edge Plot for QPSK-RB Size 1, RB Offset 74

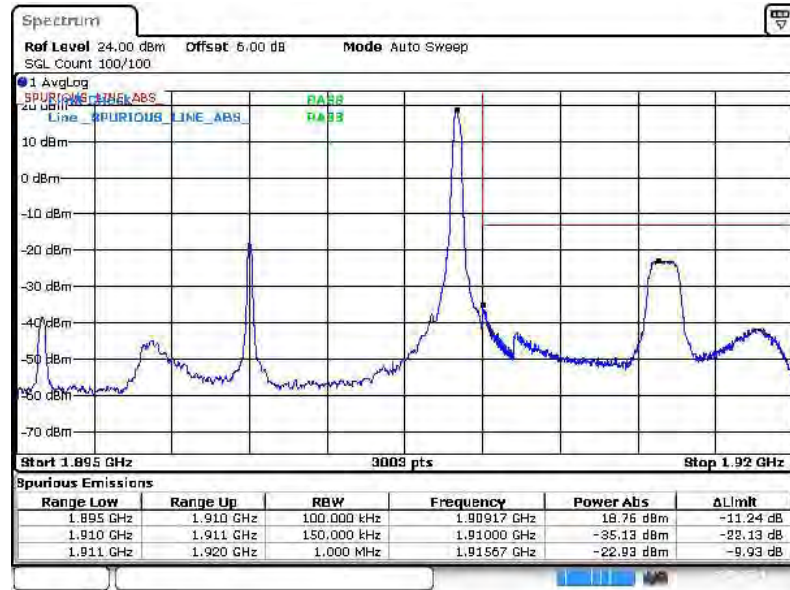

Date: 26 SEP 2014 17:21:17

Higher Band Edge Plot for QPSK-RB Size 75, RB Offset 0

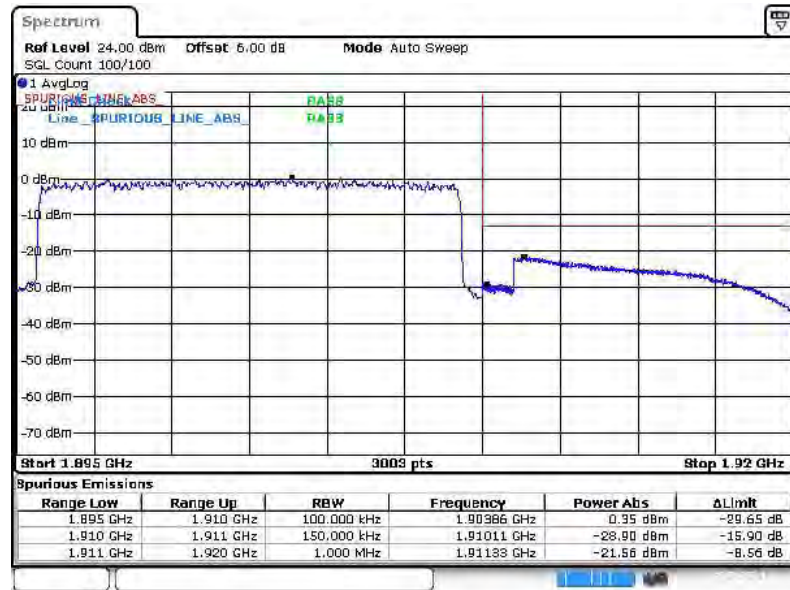

Date: 26 SEP 2014 17:23:29



Band :	LTE Band 2	Band Width :	15MHz / 16QAM
--------	------------	--------------	---------------

Lower Band Edge Plot for 16QAM-RB Size 1, RB Offset 0

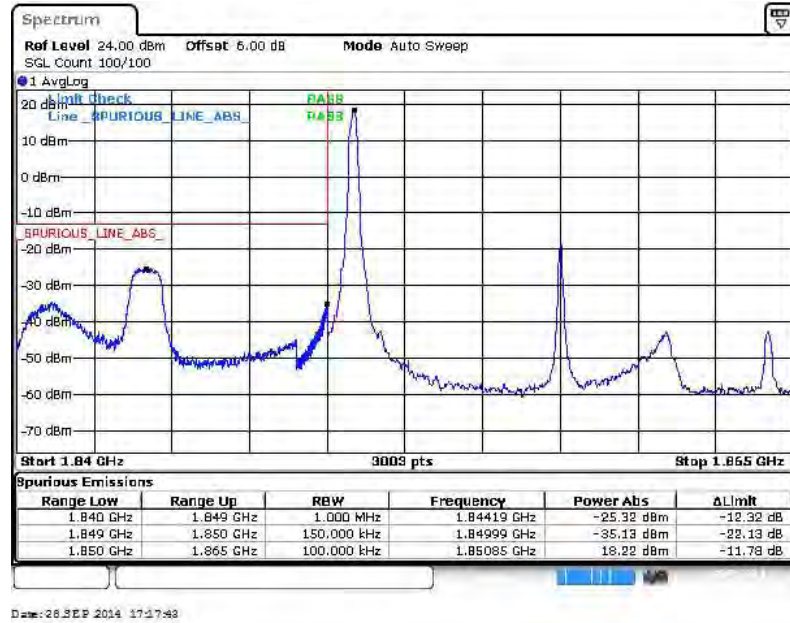

Lower Band Edge Plot for 16QAM-RB Size 75, RB Offset 0

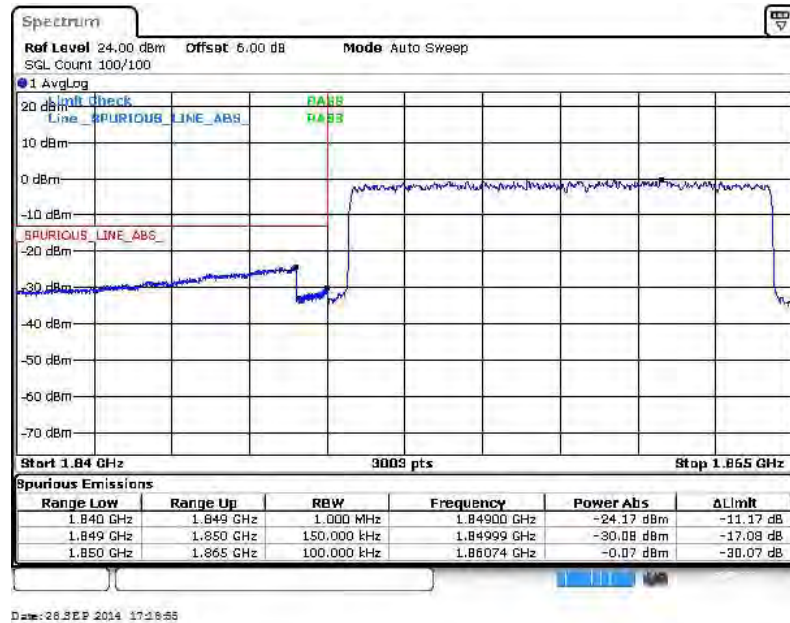



Higher Band Edge Plot for 16QAM-RB Size 1, RB Offset 74

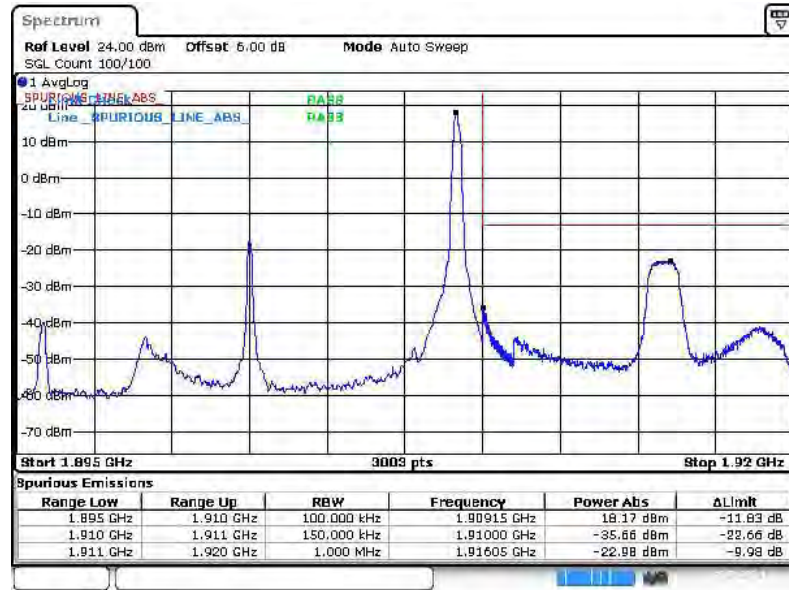

Date: 26 SEP 2014 17:22:28

Higher Band Edge Plot for 16QAM-RB Size 75, RB Offset 0

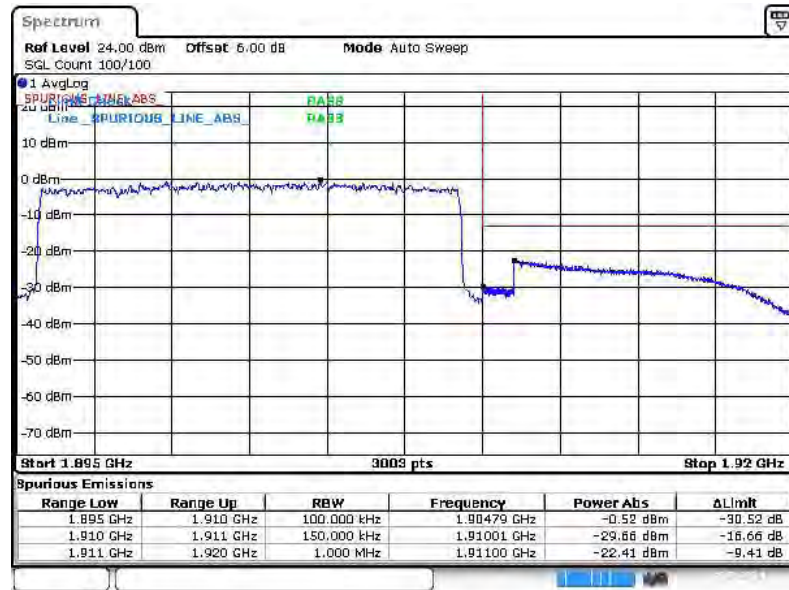

Date: 26 SEP 2014 17:24:51



Band :	LTE Band 2	Band Width :	20MHz / QPSK
--------	------------	--------------	--------------

Lower Band Edge Plot for QPSK-RB Size 1, RB Offset 0

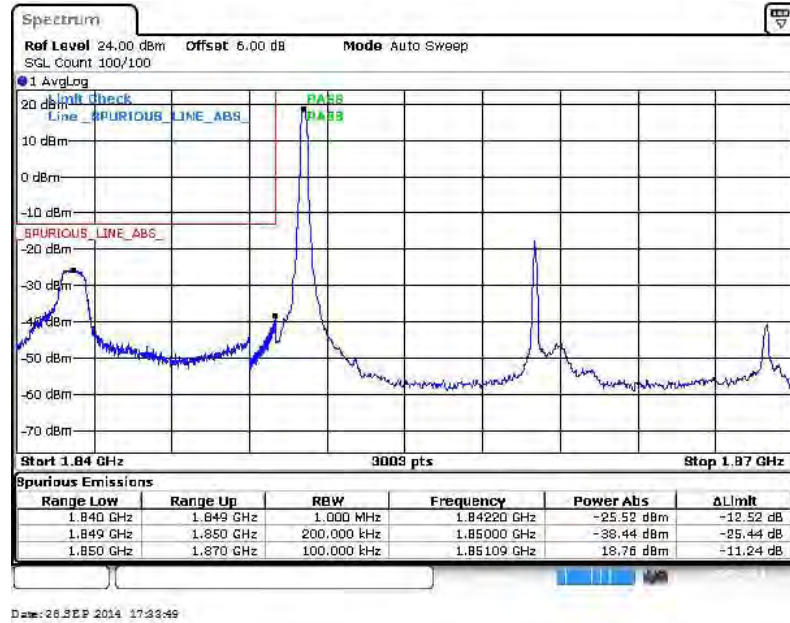

Lower Band Edge Plot for QPSK-RB Size 100, RB Offset 0

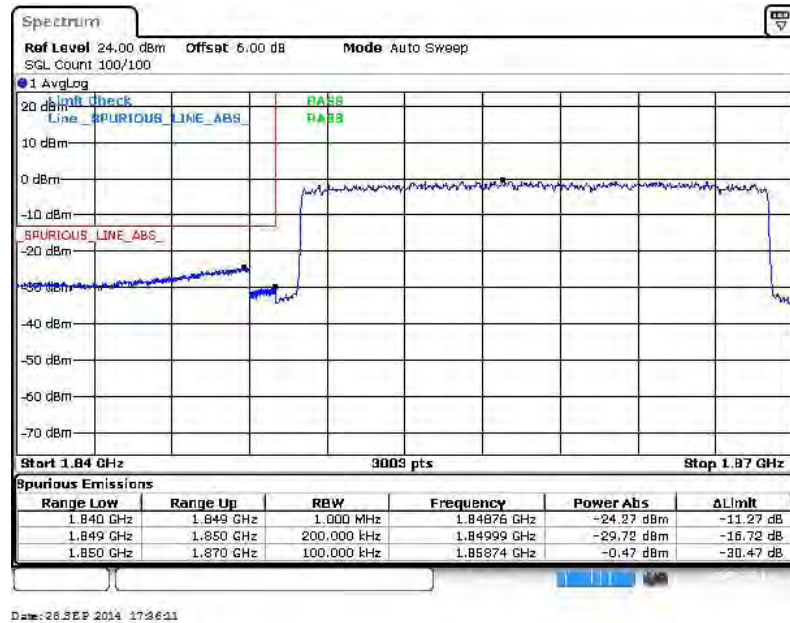



Higher Band Edge Plot for QPSK-RB Size 1, RB Offset 99

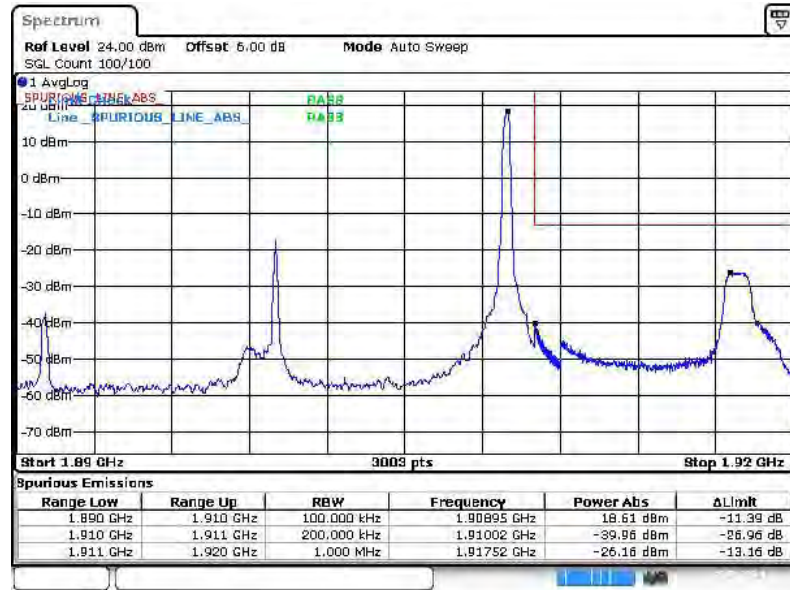

Date: 26 SEP 2014 17:28:23

Higher Band Edge Plot for QPSK-RB Size 100, RB Offset 0

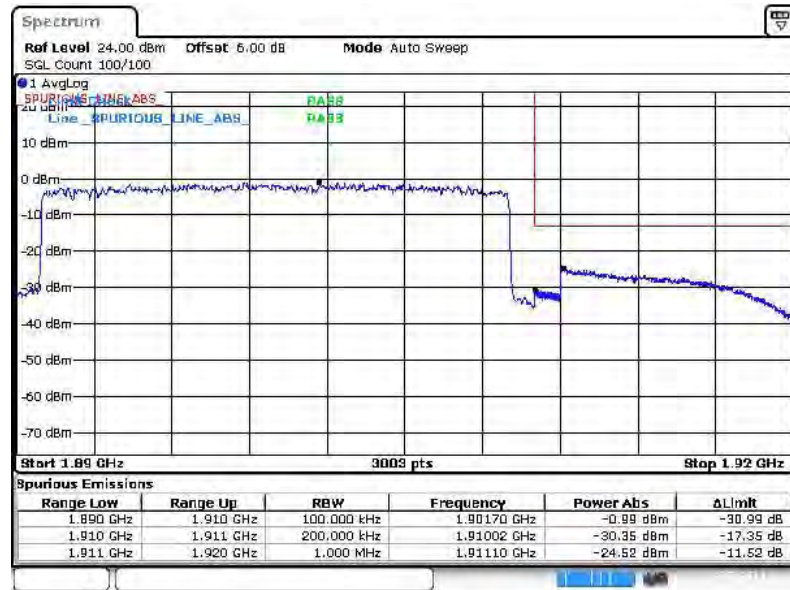

Date: 26 SEP 2014 17:40:56



Band :	LTE Band 2	Band Width :	20MHz / 16QAM
---------------	------------	---------------------	---------------

Lower Band Edge Plot for 16QAM-RB Size 1, RB Offset 0

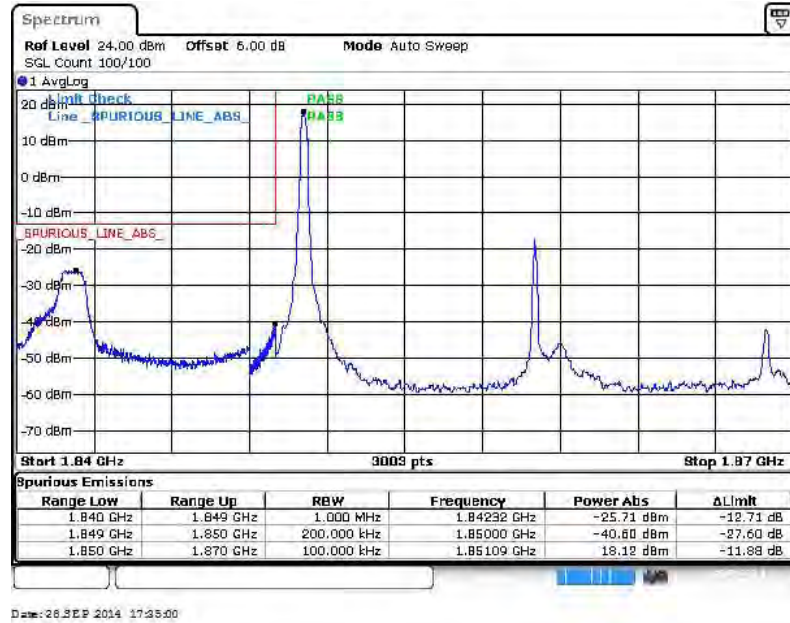

Lower Band Edge Plot for 16QAM-RB Size 100, RB Offset 0

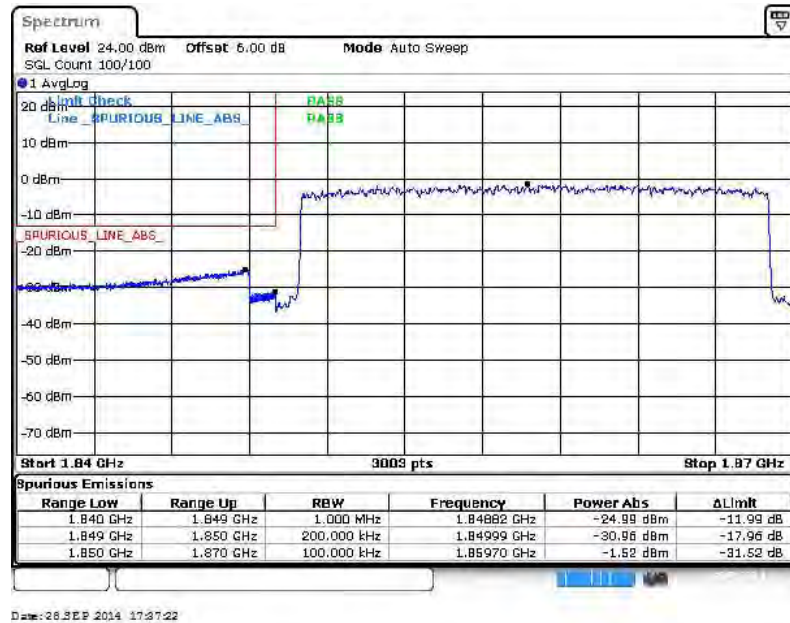



Higher Band Edge Plot for 16QAM-RB Size 1, RB Offset 99

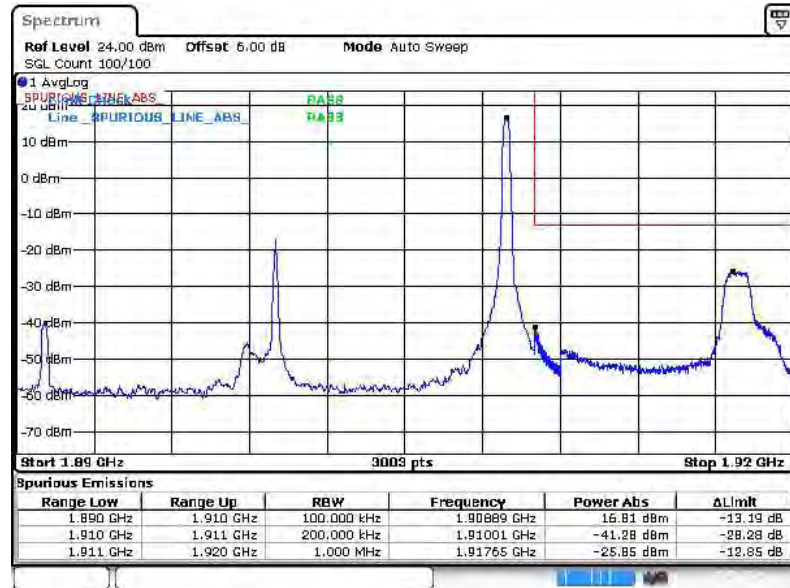

Date: 26 SEP 2014 17:29:55

Higher Band Edge Plot for 16QAM-RB Size 100, RB Offset 0

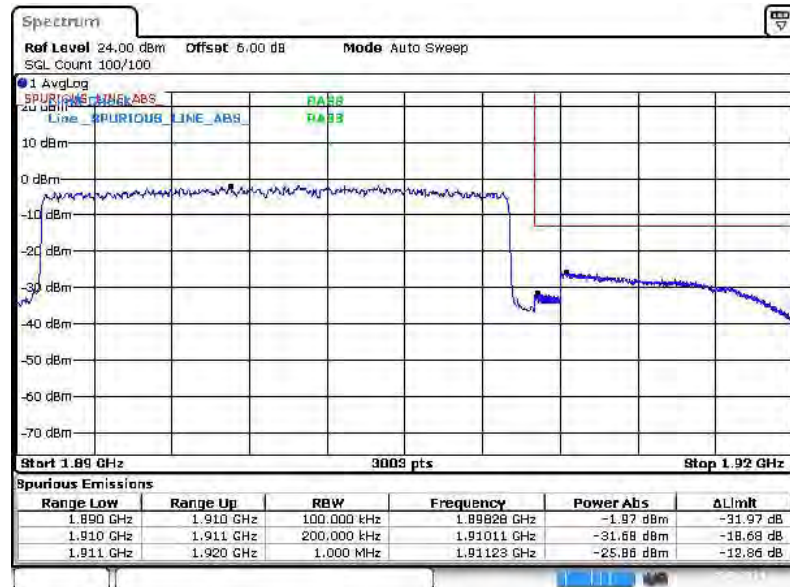

Date: 26 SEP 2014 17:42:07