



FCC RF Test Report

APPLICANT : Lenovo Mobile Communication
Technology Ltd.
EQUIPMENT : Lenovo Mobile Phone
BRAND NAME : lenovo
MODEL NAME : Lenovo S856
MID : 85600011
FCC ID : YCNS856
STANDARD : FCC Part 15 Subpart C §15.247
CLASSIFICATION : (DTS) Digital Transmission System

The product was received on Sep. 17, 2014 and testing was completed on Oct. 09, 2014. We, SPORTON INTERNATIONAL (KUNSHAN) INC., would like to declare that the tested sample has been evaluated in accordance with the test procedures and has been in compliance with the applicable technical standards.

The test results in this report apply exclusively to the tested model / sample. Without written approval of SPORTON INTERNATIONAL (KUNSHAN) INC., the test report shall not be reproduced except in full.

Reviewed by: Joseph Lin / Supervisor

Approved by: Jones Tsai / Manager



SPORTON INTERNATIONAL (KUNSHAN) INC.
No. 3-2, PingXiang Road, Kunshan, Jiangsu Province, P.R.C.



TABLE OF CONTENTS

REVISION HISTORY..... 3

SUMMARY OF TEST RESULT 4

1 GENERAL DESCRIPTION 5

 1.1 Applicant 5

 1.2 Manufacturer 5

 1.3 Product Feature of Equipment Under Test 5

 1.4 Product Specification subjective to this standard 6

 1.5 Modification of EUT 6

 1.6 Testing Location 7

 1.7 Applicable Standards 8

2 TEST CONFIGURATION OF EQUIPMENT UNDER TEST 9

 2.1 Carrier Frequency Channel 9

 2.2 Pre-Scanned RF Power 10

 2.3 Test Mode 11

 2.4 Connection Diagram of Test System 12

 2.5 Support Unit used in test configuration and system 13

 2.6 EUT Operation Test Setup 13

 2.7 Measurement Results Explanation Example 14

3 TEST RESULT 15

 3.1 6dB Bandwidth Measurement 15

 3.2 Output Power Measurement 18

 3.3 Power Spectral Density Measurement 21

 3.4 Conducted Band Edges and Spurious Emission Measurement 24

 3.5 Radiated Band Edges and Spurious Emission Measurement 37

 3.6 AC Conducted Emission Measurement 59

 3.7 Antenna Requirements 63

4 LIST OF MEASURING EQUIPMENT 64

5 UNCERTAINTY OF EVALUATION 65

APPENDIX A. SETUP PHOTOGRAPHS



SUMMARY OF TEST RESULT

Report Section	FCC Rule	Description	Limit	Result	Remark
3.1	15.247(a)(2)	6dB Bandwidth	$\geq 0.5\text{MHz}$	Pass	-
3.2	15.247(b)	Power Output Measurement	$\leq 30\text{dBm}$	Pass	-
3.3	15.247(e)	Power Spectral Density	$\leq 8\text{dBm}/3\text{kHz}$	Pass	-
3.4	15.247(d)	Conducted Band Edges	$\leq 20\text{dBc}$	Pass	-
		Conducted Spurious Emission		Pass	-
3.5	15.247(d)	Radiated Band Edges and Radiated Spurious Emission	15.209(a) & 15.247(d)	Pass	Under limit 4.9 dB at 2483.680 MHz
3.6	15.207	AC Conducted Emission	15.207(a)	Pass	Under limit 13.45 dB at 0.560 MHz
0	15.203 & 15.247(b)	Antenna Requirement	N/A	Pass	-



1 General Description

1.1 Applicant

Lenovo Mobile Communication Technology Ltd.

No. 999, Qishan North 2nd Road, Information & Optoelectronics Park, Torch Hi-tech Industry Development Zone, Xiamen, P.R.China

1.2 Manufacturer

Lenovo PC HK Limited

23/F, Lincoln House, Taikoo Place 979 King's Road, Quarry Bay, Hong Kong

1.3 Product Feature of Equipment Under Test

Product Feature	
Equipment	Lenovo Mobile Phone
Brand Name	lenovo
Model Name	Lenovo S856
MID	85600011
FCC ID	YCNS856
EUT supports Radios application	GSM/GPRS/EGPRS/WCDMA/HSPA/HSPA+/DC-HSDPA/LTE/ WLAN 2.4GHz 802.11b/g/n HT20/HT40 Bluetooth v3.0 + EDR/Bluetooth v4.0 LE
HW Version	H301
SW Version	S856_AMX_ROW_S017_141013
EUT Stage	Identical Prototype

Remark: The above EUT's information was declared by manufacturer. Please refer to the specifications or user's manual for more detailed description.



1.4 Product Specification subjective to this standard

Product Specification subjective to this standard	
Tx/Rx Channel Frequency Range	802.11b/g/n : 2412 MHz ~ 2462 MHz
Maximum (Peak) Output Power to Antenna	802.11b : 18.81 dBm (0.0760 W) 802.11g : 21.80 dBm (0.1514 W) 802.11n HT20 : 21.12 dBm (0.1294 W) 802.11n HT40 : 20.85 dBm (0.1216 W)
Antenna Type/Gain	802.11b/g/n : IFA Antenna with gain -2.3 dBi
Type of Modulation	802.11b : DSSS (DBPSK / DQPSK / CCK) 802.11g/n : OFDM (BPSK / QPSK / 16QAM / 64QAM)

1.5 Modification of EUT

No modifications are made to the EUT during all test items.



1.6 Testing Location

Test Site	SPORTON INTERNATIONAL (KUNSHAN) INC.			
Test Site Location	No. 3-2, PingXiang Road, Kunshan, Jiangsu Province, P.R.C. TEL: +86-0512-5790-0158 FAX: +86-0512-5790-0958			
Test Site No.	Sporton Site No.			FCC Registration No.
	TH01-KS	03CH01-KS	CO01-KS	149928

Note: The test site complies with ANSI C63.4 2003 requirement.



1.7 Applicable Standards

According to the specifications of the manufacturer, the EUT must comply with the requirements of the following standards:

- ♦ FCC Part 15 Subpart C §15.247
- ♦ FCC KDB Publication No. 558074 D01 DTS Meas. Guidance v03r02
- ♦ ANSI C63.4-2003

Remark:

1. All test items were verified and recorded according to the standards and without any deviation during the test.
2. This EUT has also been tested and complied with the requirements of FCC Part 15, Subpart B, recorded in a separate test report.



2 Test Configuration of Equipment Under Test

The EUT has been associated with peripherals and configuration operated in a manner tended to maximize its emission characteristics in a typical application. Frequency range investigated: conducted emission (150 kHz to 30 MHz) and radiated emission (9 kHz to the 10th harmonic of the highest fundamental frequency or to 40 GHz, whichever is lower). For radiated measurement, pre-scanned in three orthogonal panels, X, Y, Z. The worst cases were recorded in this report.

The final configuration from all the combinations and the worst-case data rates were investigated by measuring the maximum power across all the data rates and modulation modes under section 2.2.

Based on the worst configuration found above, the RF power setting is set individually to meet FCC compliance limit for the final conducted and radiated tests shown in section 2.3.

2.1 Carrier Frequency Channel

Frequency Band	Channel	Freq. (MHz)	Channel	Freq. (MHz)
2400-2483.5 MHz	1	2412	7	2442
	2	2417	8	2447
	3	2422	9	2452
	4	2427	10	2457
	5	2432	11	2462
	6	2437	-	-



2.2 Pre-Scanned RF Power

Preliminary tests were performed in different data rate and data rate associated with the highest power were chosen for full test shown in the following tables.

2.4GHz 802.11b RF Output Power (dBm)						
Power vs. Channel			Power vs. Data Rate			
Channel	Frequency (MHz)	Data Rate 1Mbps	Channel	2Mbps	5.5Mbps	11Mbps
CH 01	2412 MHz	17.31	CH 11	18.36	18.42	18.67
CH 06	2437 MHz	18.10				
CH 11	2462 MHz	18.81				

2.4GHz 802.11g RF Output Power (dBm)										
Power vs. Channel			Power vs. Data Rate							
Channel	Frequency (MHz)	Data Rate 6Mbps	Channel	9Mbps	12Mbps	18Mbps	24Mbps	36Mbps	48Mbps	54Mbps
CH 01	2412 MHz	21.22	CH 11	21.70	21.62	21.60	21.71	21.61	21.75	21.77
CH 06	2437 MHz	21.79								
CH 11	2462 MHz	21.80								

2.4GHz 802.11n HT20 RF Output Power (dBm)										
Power vs. Channel			Power vs. MCS Index							
Channel	Frequency (MHz)	MCS Index MCS0	Channel	MCS1	MCS2	MCS3	MCS4	MCS5	MCS6	MCS7
CH 01	2412 MHz	20.55	CH 11	20.92	21.11	20.11	19.95	19.95	20.10	19.75
CH 06	2437 MHz	21.11								
CH 11	2462 MHz	21.12								

2.4GHz 802.11n HT40 RF Output Power (dBm)										
Power vs. Channel			Power vs. MCS Index							
Channel	Frequency (MHz)	MCS Index MCS0	Channel	MCS1	MCS2	MCS3	MCS4	MCS5	MCS6	MCS7
CH 03	2422 MHz	20.85	CH 03	20.84	20.60	20.82	20.72	20.32	20.25	20.30
CH 06	2437 MHz	20.82								
CH 09	2452 MHz	20.20								



2.3 Test Mode

Final results of test modes, data rates and test channels are shown as following table.

Test Cases				
	Test Items	Mode	Data Rate	Test Channel
Conducted TCs	6dB BW Power Spectral Density	802.11b	1 Mbps	1/6/11
		802.11g	6 Mbps	1/6/11
		802.11n HT20	MCS0	1/6/11
		802.11n HT40	MCS0	3/6/9
	Output Power	802.11b	1 Mbps	1/6/11
		802.11g	6 Mbps	1/6/11
		802.11n HT20	MCS0	1/6/11
		802.11n HT40	MCS0	3/6/9
	Conducted Band Edge	802.11b	1 Mbps	1/11
		802.11g	6 Mbps	1/11
		802.11n HT20	MCS0	1/11
		802.11n HT40	MCS0	3/9
	Conducted Spurious Emission	802.11b	1 Mbps	1/6/11
		802.11g	6 Mbps	1/6/11
		802.11n HT20	MCS0	1/6/11
		802.11n HT40	MCS0	3/6/9
Radiated TCs	Radiated Band Edge	802.11b	1 Mbps	1/11
		802.11g	6 Mbps	1/11
		802.11n HT20	MCS0	1/11
		802.11n HT40	MCS0	3/9
	Radiated Spurious Emission	802.11b	1 Mbps	1/6/11
		802.11g	6 Mbps	1/6/11
		802.11n HT20	MCS0	1/6/11
		802.11n HT40	MCS0	3/6/9
Test Cases				
AC Conducted Emission	Mode 1 : GSM850 Idle + Bluetooth Link + WLAN Link + USB Cable (Charging from Adapter) + Earphone			
Remark: For radiated test cases, the tests were performance with adapter, earphone and USB cable.				

2.4 Connection Diagram of Test System

<WLAN Tx Mode>

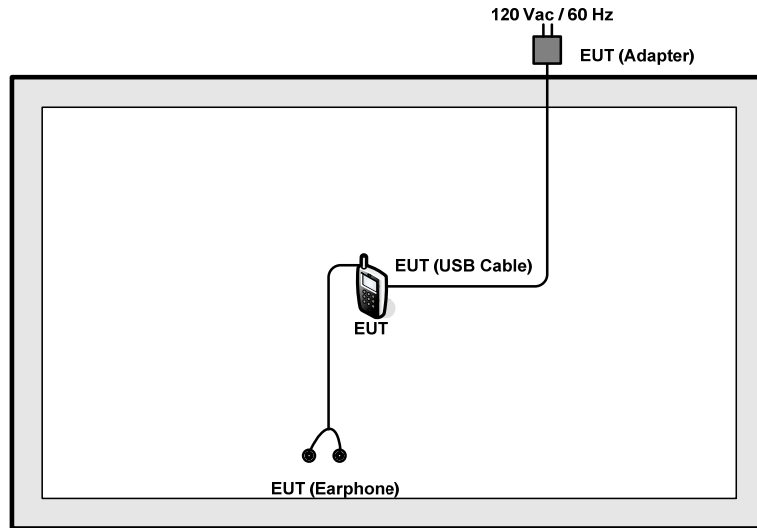

<AC Conducted Emission Mode>

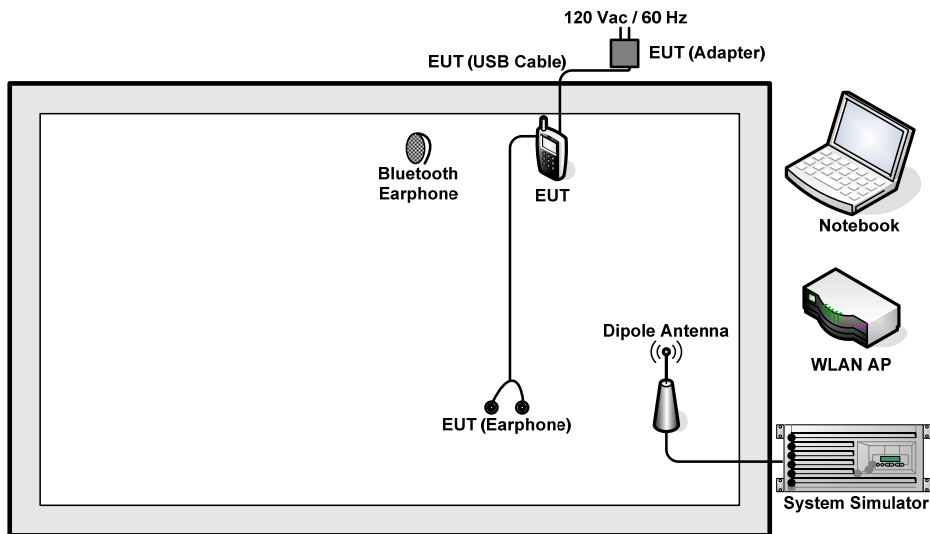

2.5 Support Unit used in test configuration and system

Item	Equipment	Trade Name	Model Name	FCC ID	Data Cable	Power Cord
1.	System Simulator	R&S	CMU 200	N/A	N/A	Unshielded, 1.8 m
2.	WLAN AP	D-Link	DIR-855	KA2DIR855A2	N/A	Unshielded, 1.8 m
3.	Notebook	Lenovo	G480	FCC DoC	N/A	AC I/P: Unshielded, 1.2 m DC O/P: Shielded, 1.8 m
4.	Bluetooth Earphone	Lenovo	LBH505	N/A	N/A	N/A

2.6 EUT Operation Test Setup

For WLAN function, the engineering test program was provided and enabled to make EUT continuous transmit/receive.

For AC power line conducted emissions, the EUT was set to connect with the WLAN AP under large package sizes transmission.



2.7 Measurement Results Explanation Example

For all conducted test items:

The offset level is set in the spectrum analyzer to compensate the RF cable loss between EUT conducted output port and spectrum analyzer. With the offset compensation, the spectrum analyzer reading level is exactly the EUT RF output level.

Example :

The spectrum analyzer offset is derived from RF cable loss.

Offset = RF cable loss.

Following shows an offset computation example with cable loss 6.0 dB.

$$\begin{aligned} \text{Offset(dB)} &= \text{RF cable loss(dB)}. \\ &= 6.0 \text{ (dB)} \end{aligned}$$

3 Test Result

3.1 6dB Bandwidth Measurement

3.1.1 Limit of 6dB Bandwidth

The minimum 6 dB bandwidth shall be at least 500 kHz.

3.1.2 Measuring Instruments

The measuring equipment is listed in the section 4 of this test report.

3.1.3 Test Procedures

1. The testing follows FCC KDB Publication No. 558074 DTS D01 Meas. Guidance v03r02.
2. The RF output of EUT was connected to the spectrum analyzer by RF cable and attenuator. The path loss was compensated to the results for each measurement.
3. Set to the maximum power setting and enable the EUT transmit continuously.
4. Make the measurement with the spectrum analyzer's resolution bandwidth (RBW) = 100 kHz. Set the Video bandwidth (VBW) = 300 kHz. In order to make an accurate measurement. The 6 dB bandwidth must be greater than 500 kHz.
5. Measure and record the results in the test report.

3.1.4 Test Setup

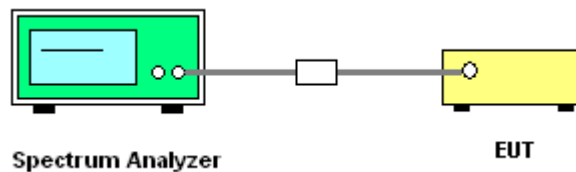



3.1.5 Test Result of 6dB Bandwidth

Test Band :	2.4GHz	Temperature :	24~25°C
Test Engineer :	Issac Song	Relative Humidity :	49~51%

Mod.	Data Rate	N _{TX}	Channel	Freq. (MHz)	6dB Bandwidth (MHz)	6dB Bandwidth Min. Limit (MHz)	Pass/Fail
11b	1Mbps	1	1	2412	7.53	0.50	Pass
11b	1Mbps	1	6	2437	7.07	0.50	Pass
11b	1Mbps	1	11	2462	7.07	0.50	Pass
11g	6Mbps	1	1	2412	16.34	0.50	Pass
11g	6Mbps	1	6	2437	16.34	0.50	Pass
11g	6Mbps	1	11	2462	16.34	0.50	Pass
HT20	MCS0	1	1	2412	17.32	0.50	Pass
HT20	MCS0	1	6	2437	17.58	0.50	Pass
HT20	MCS0	1	11	2462	17.58	0.50	Pass
HT40	MCS0	1	3	2422	35.29	0.50	Pass
HT40	MCS0	1	6	2437	35.29	0.50	Pass
HT40	MCS0	1	9	2452	35.29	0.50	Pass

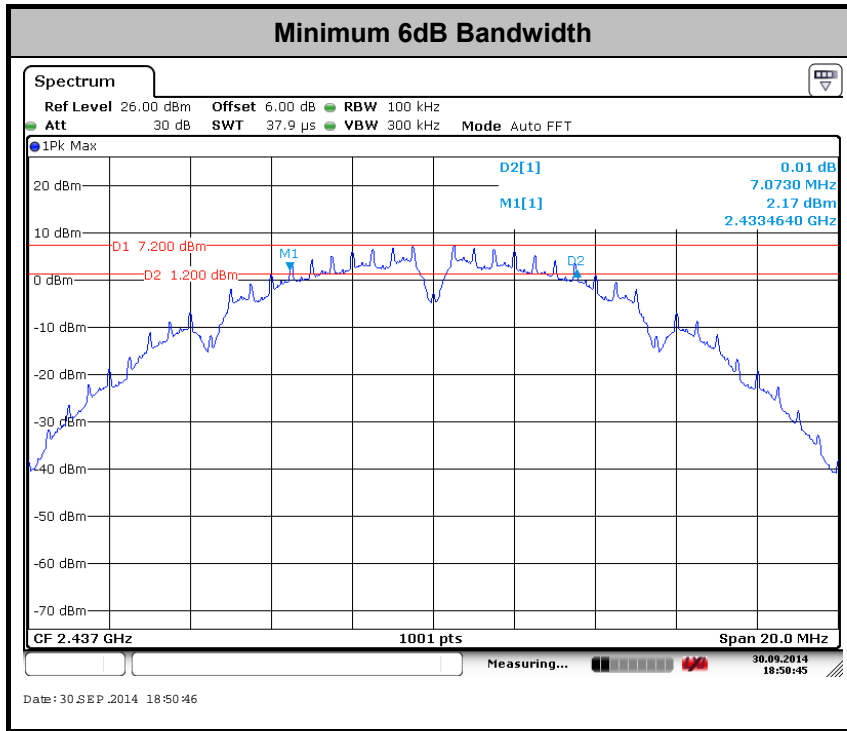

Note : The occupied channel bandwidth is maintained within the band of operation for all of the modulations.

3.2 Output Power Measurement

3.2.1 Limit of Output Power

For systems using digital modulation in the 2400-2483.5MHz, the limit for peak output power is 30dBm. If transmitting Antenna of directional gain greater than 6dBi are used the peak output power from the intentional radiator shall be reduced below the above stated value by the amount in dB that the directional gain of the Antenna exceeds 6 dBi. In case of point-to-point operation, the limit has to be reduced by 1dB for every 3dB that the directional gain of the Antenna exceeds 6dBi.

3.2.2 Measuring Instruments

The measuring equipment is listed in the section 4 of this test report.

3.2.3 Test Procedures

1. The testing follows the Measurement Procedure of FCC KDB No. 558074 DTS D01 Meas. Guidance v03r02.
2. The RF output of EUT was connected to the power meter by RF cable and attenuator. The path loss was compensated to the results for each measurement.
3. Set to the maximum power setting and enable the EUT transmit continuously.
4. Measure the conducted output power and record the results in the test report.

3.2.4 Test Setup

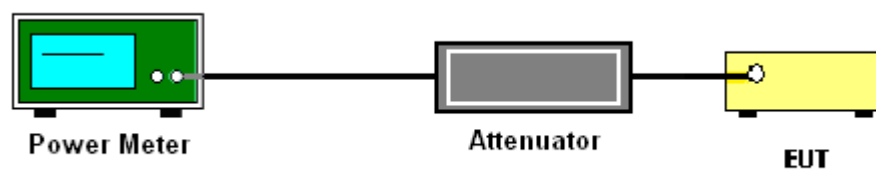



3.2.5 Test Result of Peak Output Power

Test Mode :	2.4GHz	Temperature :	24~25°C
Test Engineer :	Issac Song	Relative Humidity :	49~51%

Mod.	Data Rate	N _{TX}	Channel	Freq. (MHz)	RF Output Power (dBm)	Power Limit (dBm)	DG (dBi)	Pass/Fail
11b	1Mbps	1	1	2412	17.31	30	-2.30	Pass
11b	1Mbps	1	6	2437	18.10	30	-2.30	Pass
11b	1Mbps	1	11	2462	18.81	30	-2.30	Pass
11g	6Mbps	1	1	2412	21.22	30	-2.30	Pass
11g	6Mbps	1	6	2437	21.79	30	-2.30	Pass
11g	6Mbps	1	11	2462	21.80	30	-2.30	Pass
HT20	MCS0	1	1	2412	20.55	30	-2.30	Pass
HT20	MCS0	1	6	2437	21.11	30	-2.30	Pass
HT20	MCS0	1	11	2462	21.12	30	-2.30	Pass
HT40	MCS0	1	3	2422	20.85	30	-2.30	Pass
HT40	MCS0	1	6	2437	20.82	30	-2.30	Pass
HT40	MCS0	1	9	2452	20.20	30	-2.30	Pass

Note: Measured power (dBm) has offset with cable loss.



3.2.6 Test Result of Average output Power (Reporting Only)

Test Mode :	2.4GHz	Temperature :	24~25°C
Test Engineer :	Issac Song	Relative Humidity :	49~51%

Mod.	Data Rate	N _{TX}	Channel	Freq. (MHz)	Duty Factor (dB)	Average Output Power (dBm)	Power Limit (dBm)	DG (dBi)	Pass/Fail
11b	1Mbps	1	1	2412	0.11	14.34	30	-2.30	Pass
11b	1Mbps	1	6	2437	0.11	15.08	30	-2.30	Pass
11b	1Mbps	1	11	2462	0.11	15.36	30	-2.30	Pass
11g	6Mbps	1	1	2412	0.58	13.73	30	-2.30	Pass
11g	6Mbps	1	6	2437	0.58	13.93	30	-2.30	Pass
11g	6Mbps	1	11	2462	0.58	14.68	30	-2.30	Pass
HT20	MCS0	1	1	2412	0.63	12.13	30	-2.30	Pass
HT20	MCS0	1	6	2437	0.63	12.27	30	-2.30	Pass
HT20	MCS0	1	11	2462	0.63	12.61	30	-2.30	Pass
HT40	MCS0	1	3	2422	1.17	11.60	30	-2.30	Pass
HT40	MCS0	1	6	2437	1.17	11.16	30	-2.30	Pass
HT40	MCS0	1	9	2452	1.17	10.84	30	-2.30	Pass

Note: Measured power (dBm) has offset with cable loss and duty factor.

3.3 Power Spectral Density Measurement

3.3.1 Limit of Power Spectral Density

The peak power spectral density shall not be greater than 8dBm in any 3kHz band at any time interval of continuous transmission.

3.3.2 Measuring Instruments

The measuring equipment is listed in the section 4 of this test report.

3.3.3 Test Procedures

1. The testing follows Measurement Procedure 10.2 Method PKPSD of FCC KDB Publication No. 558074 D01 DTS Meas. Guidance v03r02
2. The RF output of EUT was connected to the spectrum analyzer by RF cable and attenuator. The path loss was compensated to the results for each measurement.
3. Set to the maximum power setting and enable the EUT transmit continuously.
4. Make the measurement with the spectrum analyzer's resolution bandwidth (RBW) = 3 kHz. Video bandwidth VBW = 10 kHz In order to make an accurate measurement, set the span to 1.5 times DTS Channel Bandwidth. (6dB BW)
5. Detector = peak, Sweep time = auto couple, Trace mode = max hold, Allow trace to fully stabilize. Use the peak marker function to determine the maximum power level.
6. Measure and record the results in the test report.

3.3.4 Test Setup

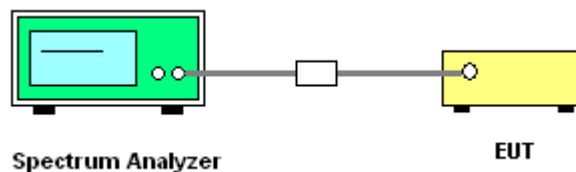



3.3.5 Test Result of Power Spectral Density

Test Mode :	2.4GHz	Temperature :	24~25°C
Test Engineer :	Issac Song	Relative Humidity :	49~51%

Mod.	Data Rate	N _{TX}	Channel	Freq. (MHz)	Peak Power Density (dBm/3kHz)	Max. Limits (dBm/3kHz)	DG (dBi)	Pass/Fail
11b	1Mbps	1	1	2412	-6.28	8	-2.30	Pass
11b	1Mbps	1	6	2437	-6.29	8	-2.30	Pass
11b	1Mbps	1	11	2462	-4.96	8	-2.30	Pass
11g	6Mbps	1	1	2412	-9.75	8	-2.30	Pass
11g	6Mbps	1	6	2437	-8.22	8	-2.30	Pass
11g	6Mbps	1	11	2462	-8.43	8	-2.30	Pass
HT20	MCS0	1	1	2412	-12.13	8	-2.30	Pass
HT20	MCS0	1	6	2437	-11.51	8	-2.30	Pass
HT20	MCS0	1	11	2462	-10.65	8	-2.30	Pass
HT40	MCS0	1	3	2422	-15.20	8	-2.30	Pass
HT40	MCS0	1	6	2437	-14.59	8	-2.30	Pass
HT40	MCS0	1	9	2452	-14.79	8	-2.30	Pass

Note: Measured power density (dBm) has offset with cable loss.

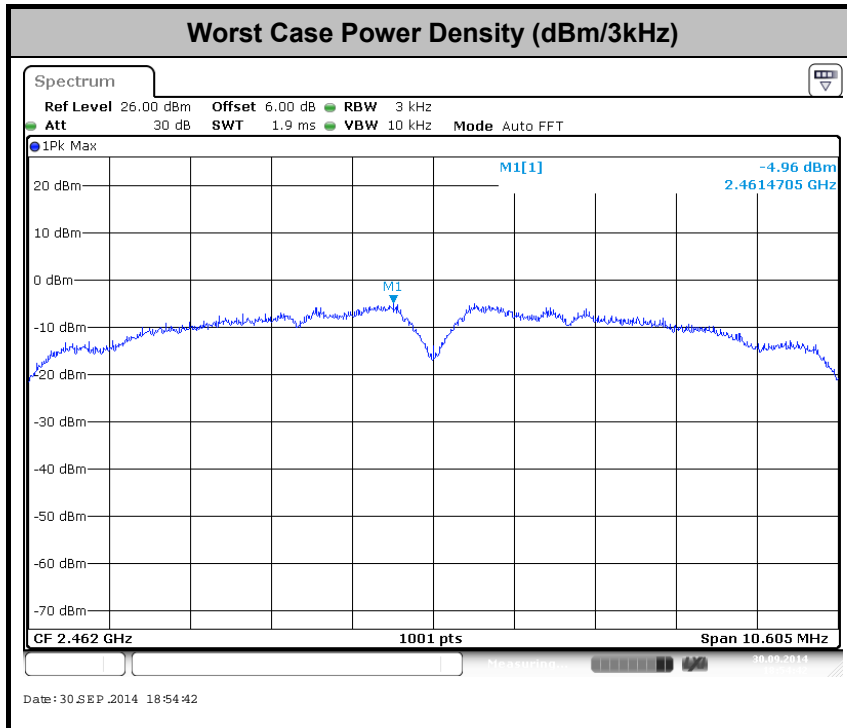

3.4 Conducted Band Edges and Spurious Emission Measurement

3.4.1 Limit of Conducted Band Edges and Spurious Emission Measurement

In any 100 kHz bandwidth outside of the authorized frequency band, the emissions which fall in the non-restricted bands shall be attenuated at least 20 dB / 30dB relative to the maximum PSD level in 100 kHz by RF conducted measurement and radiated emissions which fall in the restricted bands, as defined in Section 15.205(a), must also comply with the radiated emission limits specified in Section 15.209(a).

3.4.2 Measuring Instruments

The measuring equipment is listed in the section 4 of this test report.

3.4.3 Test Procedures

1. The testing follows FCC KDB Publication No. 558074 D01 DTS Meas. Guidance v03r02.
2. The RF output of EUT was connected to the spectrum analyzer by RF cable and attenuator. The path loss was compensated to the results for each measurement.
3. Set to the maximum power setting and enable the EUT transmit continuously.
4. Set RBW = 100 kHz, VBW=300 kHz, Peak Detector. Unwanted Emissions measured in any 100 kHz bandwidth outside of the authorized frequency band shall be attenuated by at least 20 dB relative to the maximum in-band peak PSD level in 100 kHz when maximum peak conducted output power procedure is used. If the transmitter complies with the conducted power limits based on the use of RMS averaging over a time interval, the attenuation required under this paragraph shall be 30 dB instead of 20 dB per 15.247(d).
5. Measure and record the results in the test report.
6. The RF fundamental frequency should be excluded against the limit line in the operating frequency band.

3.4.4 Test Setup

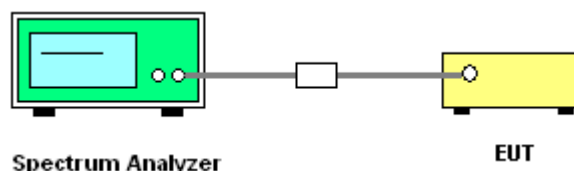



3.4.5 Test Result of Conducted Band Edges and Spurious Emission

Test Mode :	802.11b	Temperature :	24~25°C
Test Band :	2.4GHz Low	Relative Humidity :	49~51%
Test Channel :	01	Test Engineer :	Issac Song

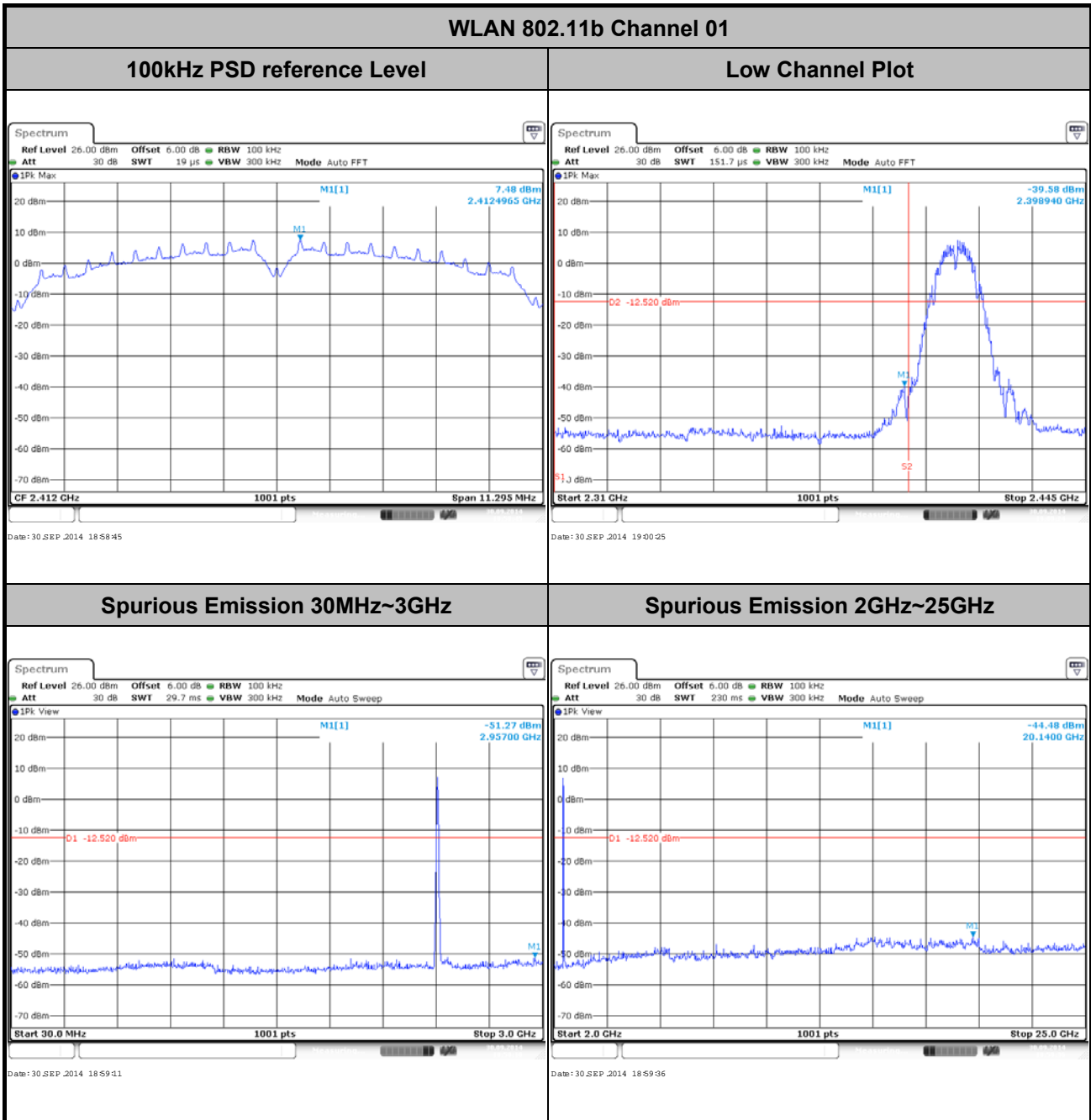



Test Mode :	802.11b	Temperature :	24~25°C
Test Band :	2.4GHz Mid	Relative Humidity :	49~51%
Test Channel :	06	Test Engineer :	Issac Song

WLAN 802.11b Channel 06

100kHz PSD reference Level

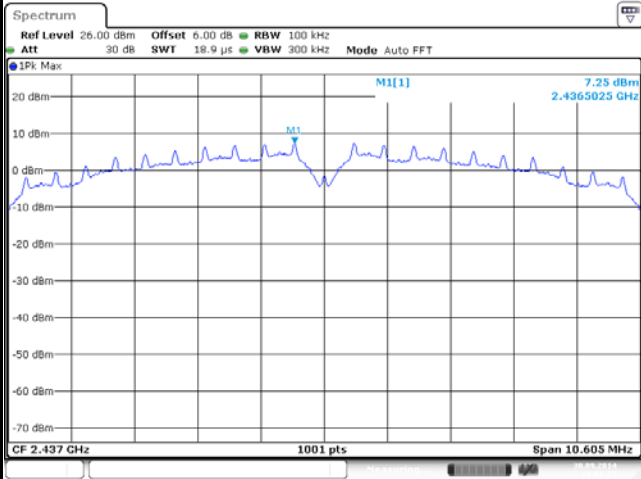

Spurious Emission 30MHz~3GHz

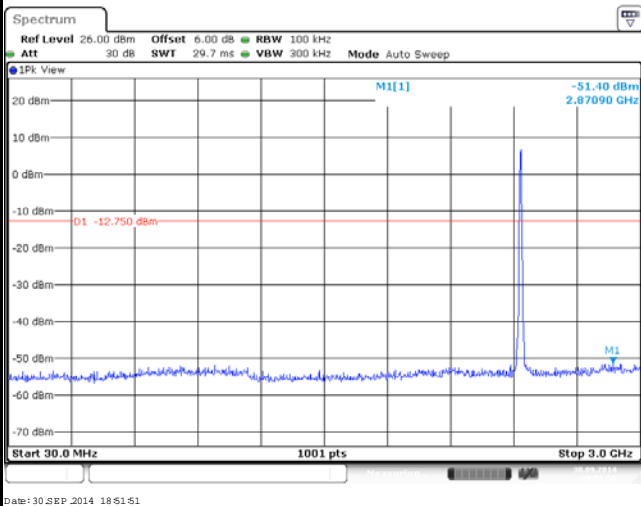

Spurious Emission 2GHz~25GHz

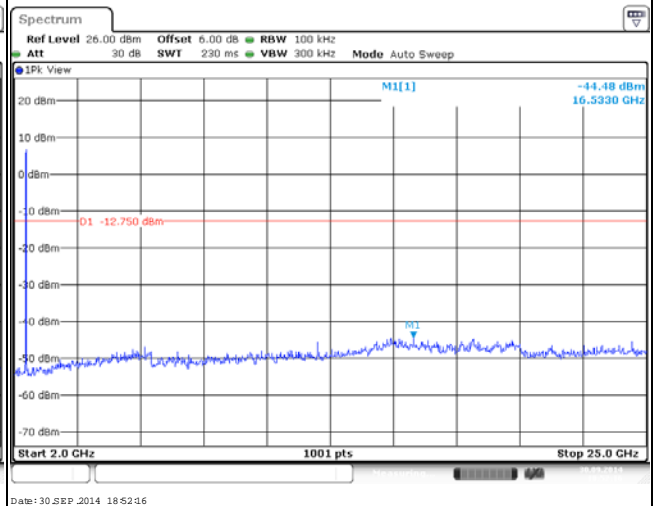



Test Mode :	802.11b	Temperature :	24~25°C
Test Band :	2.4GHz High	Relative Humidity :	49~51%
Test Channel :	11	Test Engineer :	Issac Song

WLAN 802.11b Channel 11

100kHz PSD reference Level	High Channel Plot
----------------------------	-------------------

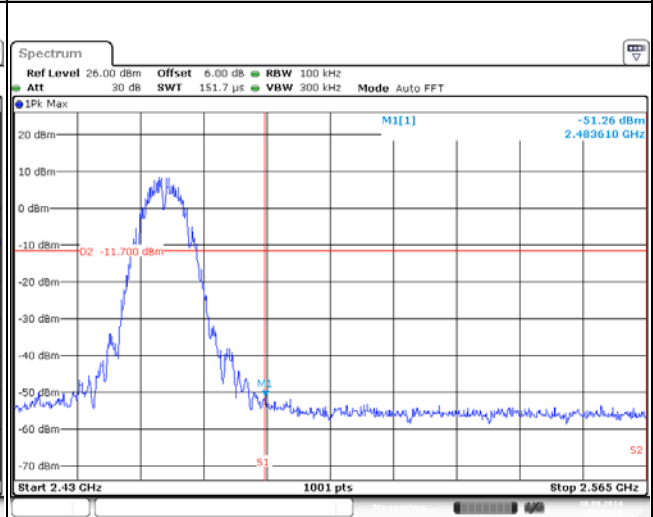
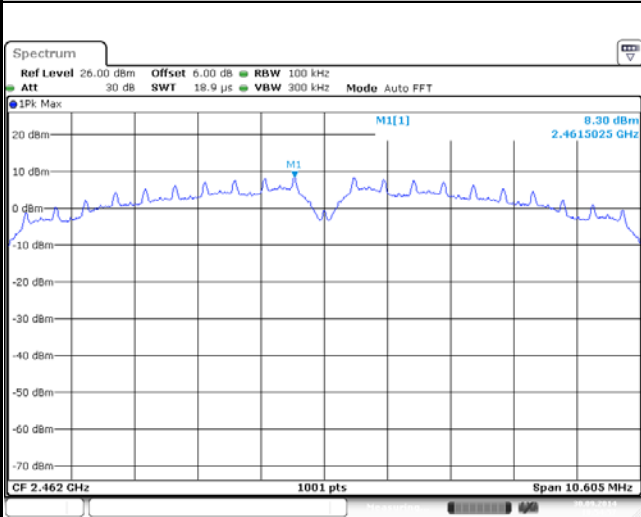

Date: 30.SEP.2014 18:54:57

Date: 30.SEP.2014 19:02:10

Spurious Emission 30MHz~3GHz

Spurious Emission 2GHz~25GHz

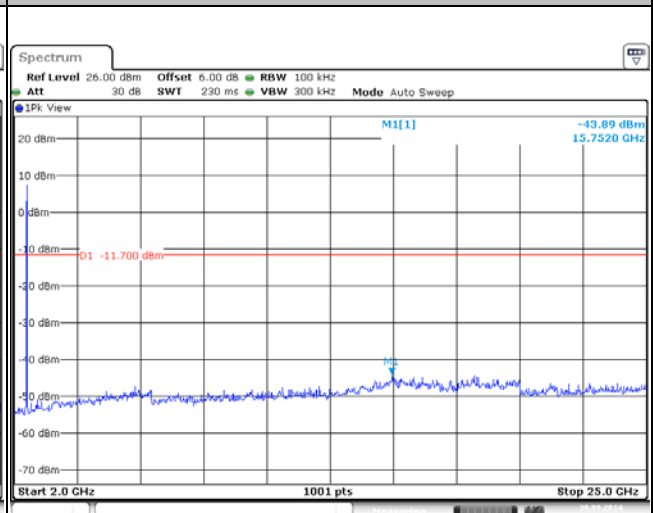
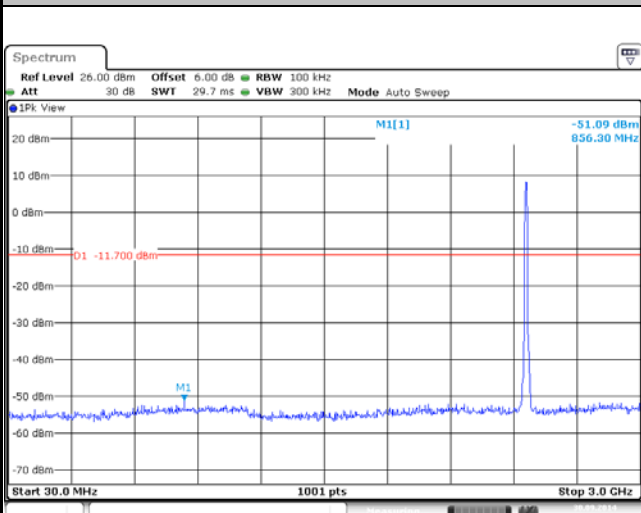

Date: 30.SEP.2014 18:55:22

Date: 30.SEP.2014 18:55:48



Test Mode :	802.11g	Temperature :	24~25°C
Test Band :	2.4GHz Low	Relative Humidity :	49~51%
Test Channel :	01	Test Engineer :	Issac Song

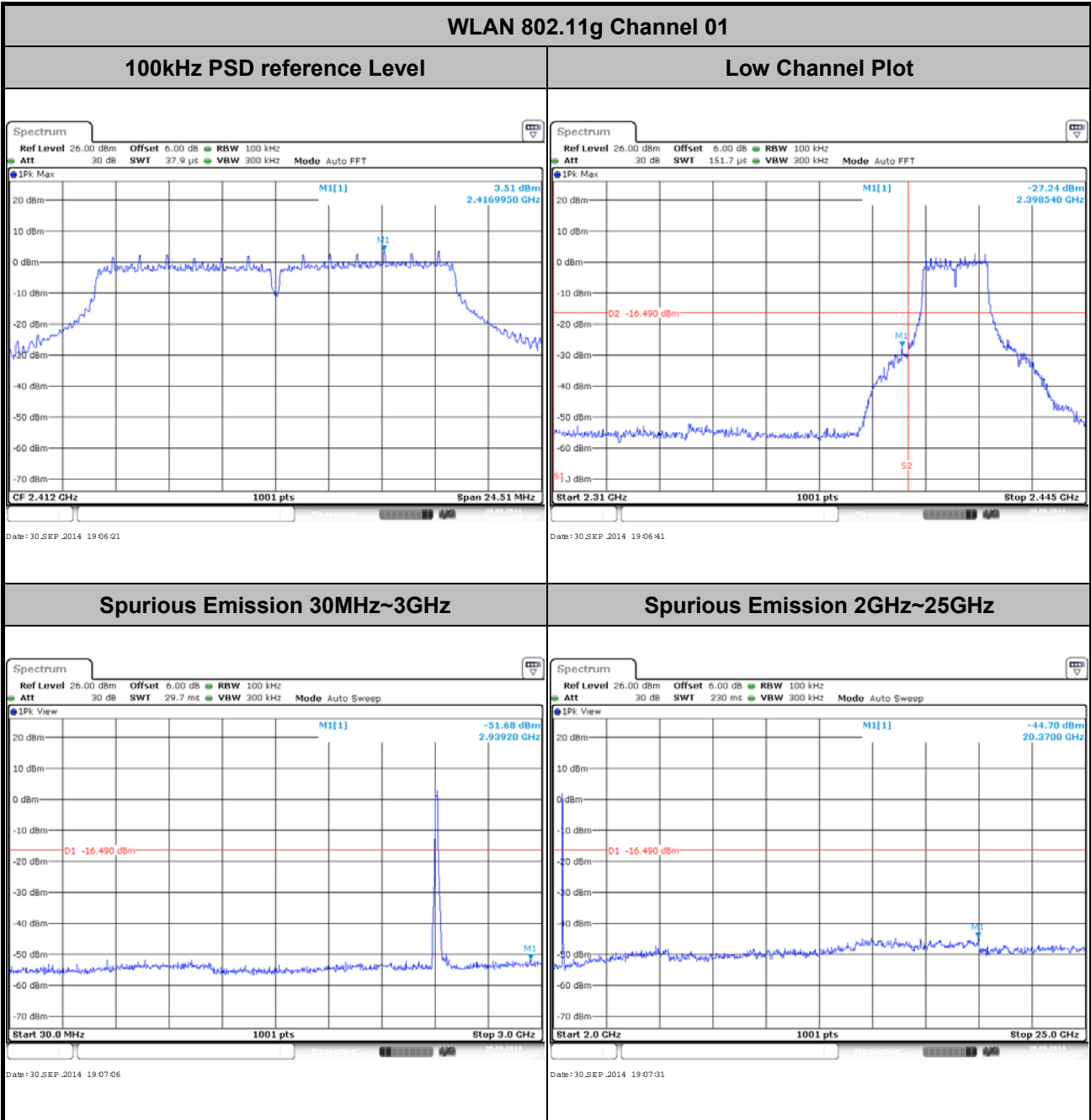



Test Mode :	802.11g	Temperature :	24~25°C
Test Band :	2.4GHz Mid	Relative Humidity :	49~51%
Test Channel :	06	Test Engineer :	Issac Song

WLAN 802.11g Channel 06

100kHz PSD reference Level

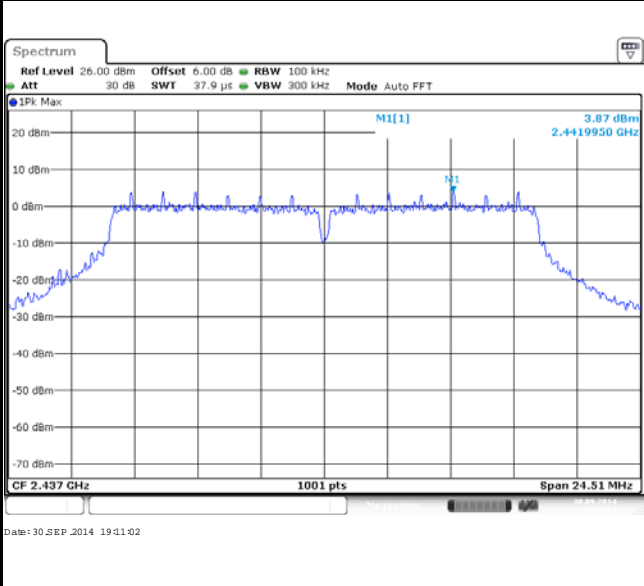

Spurious Emission 30MHz~3GHz

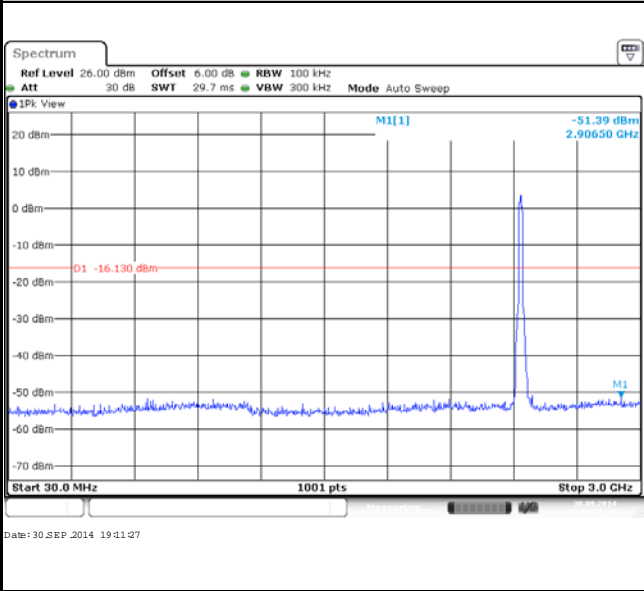

Spurious Emission 2GHz~25GHz

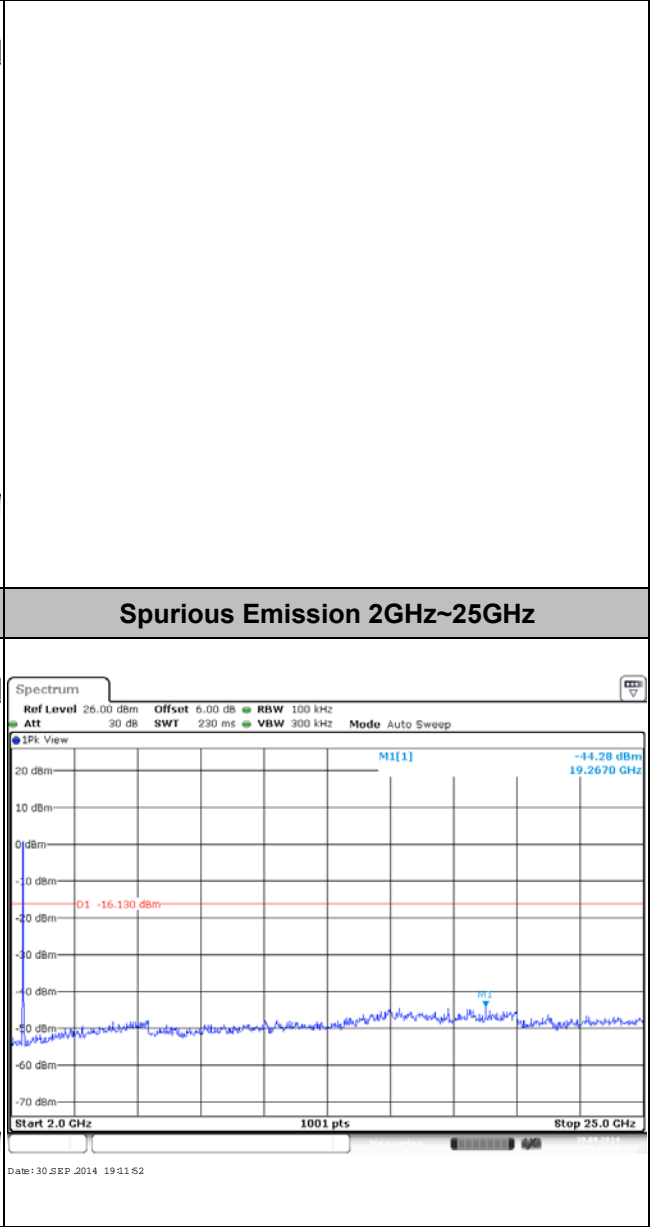



Test Mode :	802.11g	Temperature :	24~25°C
Test Band :	2.4GHz High	Relative Humidity :	49~51%
Test Channel :	11	Test Engineer :	Issac Song

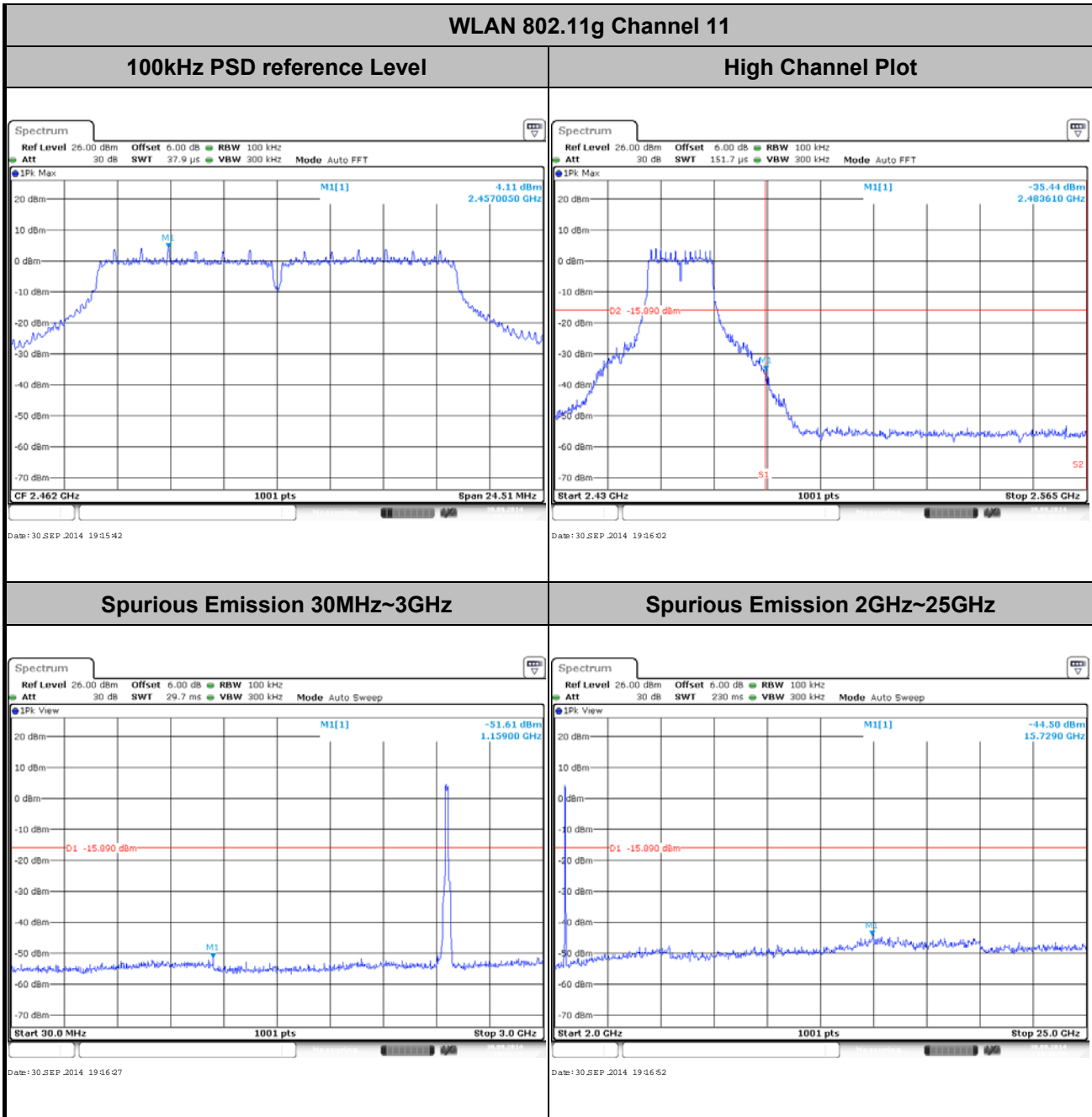



Test Mode :	802.11n HT20	Temperature :	24~25°C
Test Band :	2.4GHz Low	Relative Humidity :	49~51%
Test Channel :	01	Test Engineer :	Issac Song

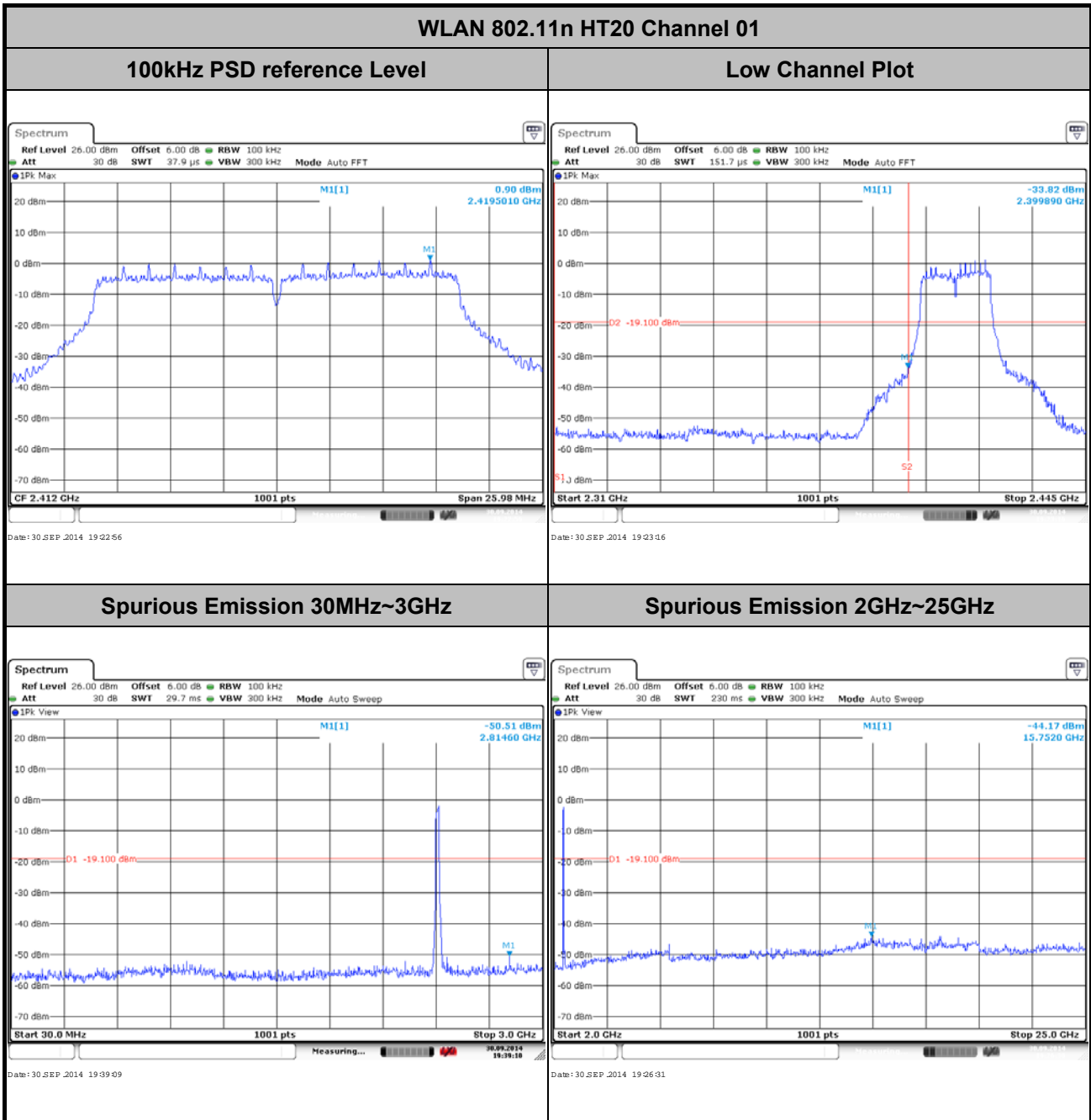



Test Mode :	802.11n HT20	Temperature :	24~25°C
Test Band :	2.4GHz Mid	Relative Humidity :	49~51%
Test Channel :	06	Test Engineer :	Issac Song

WLAN 802.11n HT20 Channel 06

100kHz PSD reference Level

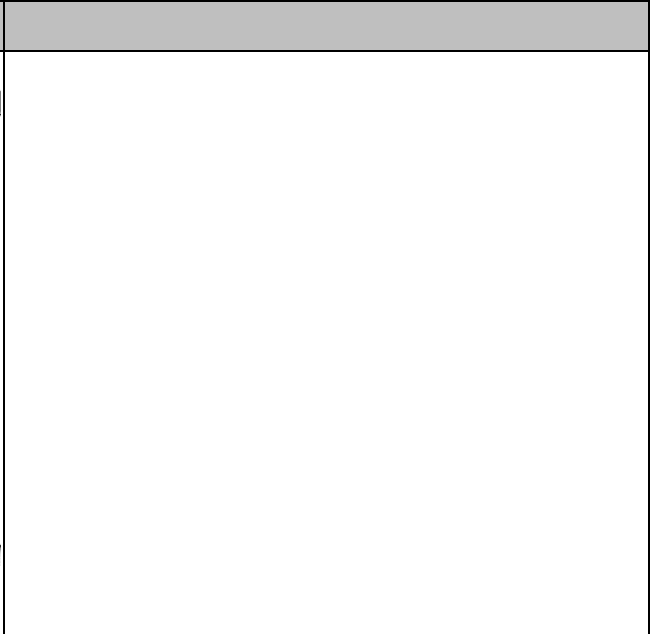
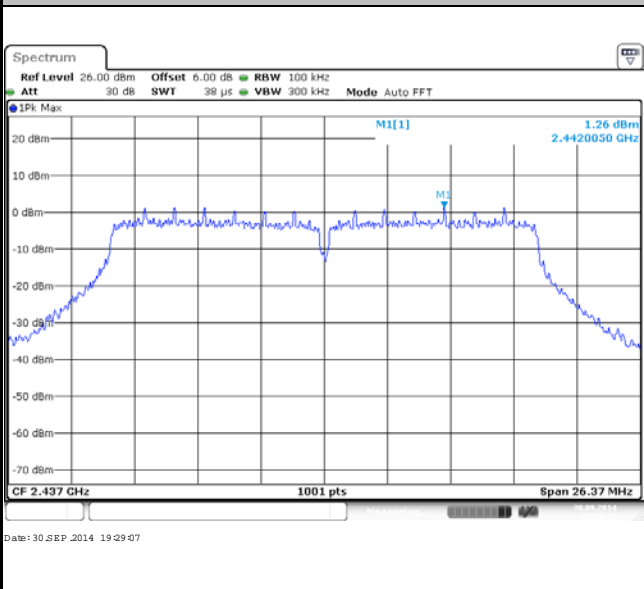

Spurious Emission 30MHz~3GHz

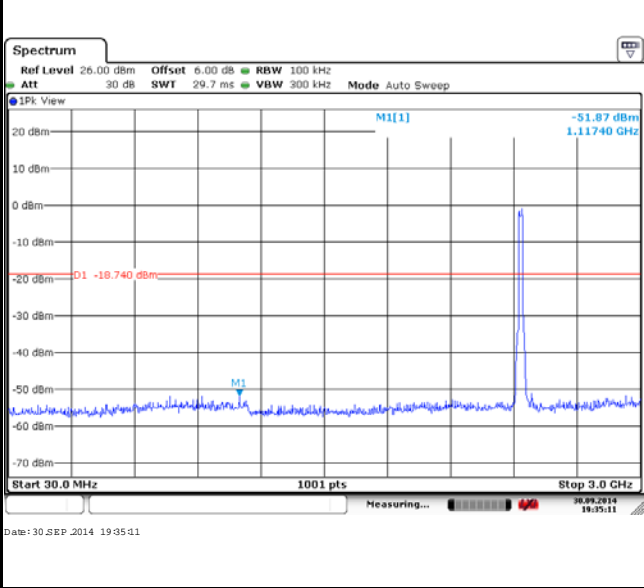

Spurious Emission 2GHz~25GHz

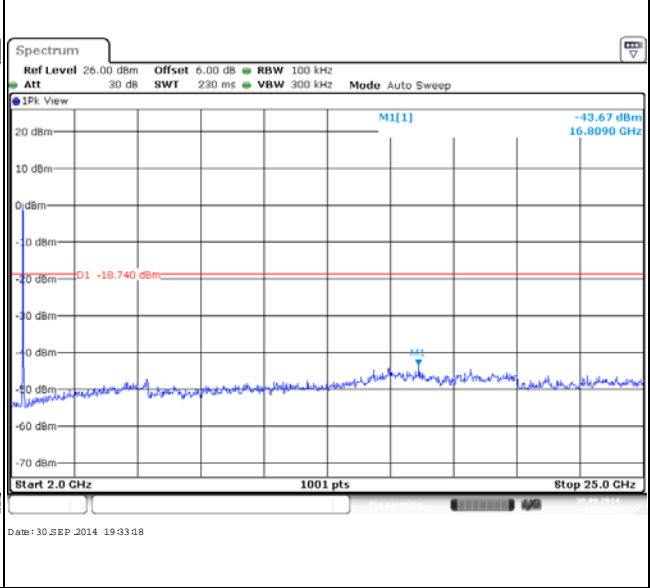



Test Mode :	802.11n HT20	Temperature :	24~25°C
Test Band :	2.4GHz High	Relative Humidity :	49~51%
Test Channel :	11	Test Engineer :	Issac Song

WLAN 802.11n HT20 Channel 11

100kHz PSD reference Level	High Channel Plot
----------------------------	-------------------

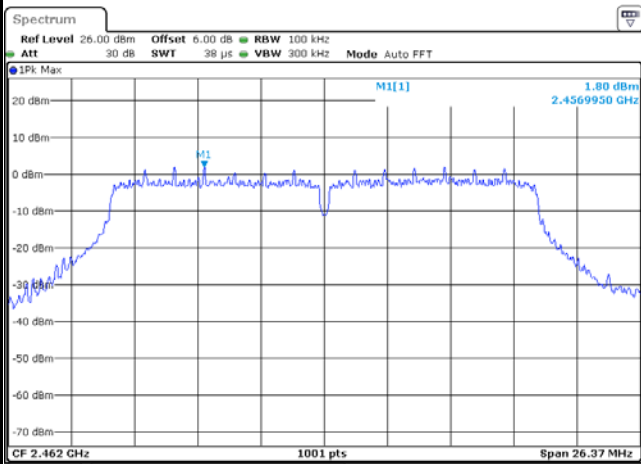

Date: 30.SEP.2014 19:43:46

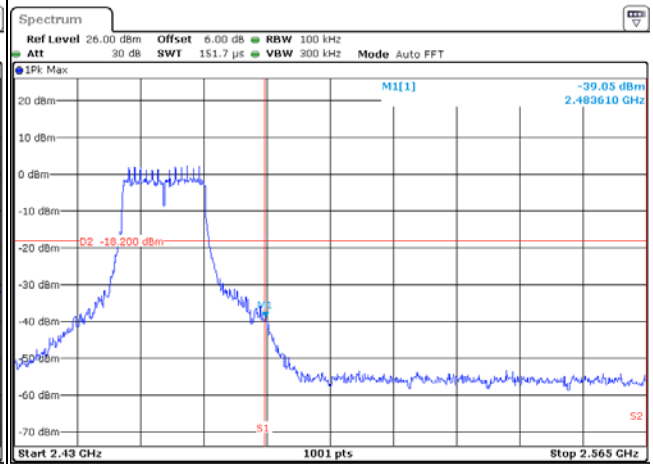

Date: 30.SEP.2014 19:44:06

Spurious Emission 30MHz~3GHz	Spurious Emission 2GHz~25GHz
------------------------------	------------------------------

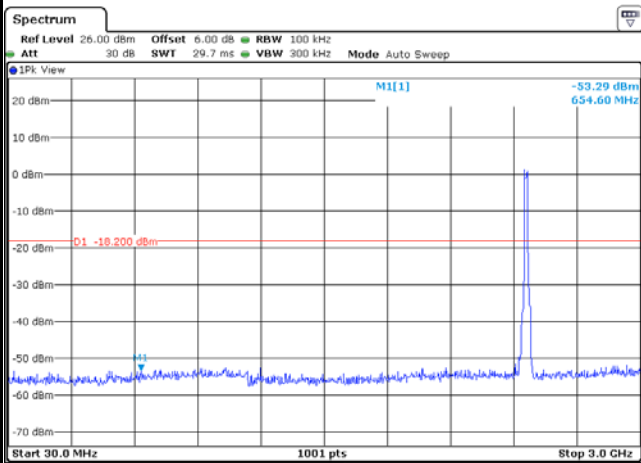

Date: 30.SEP.2014 19:47:51

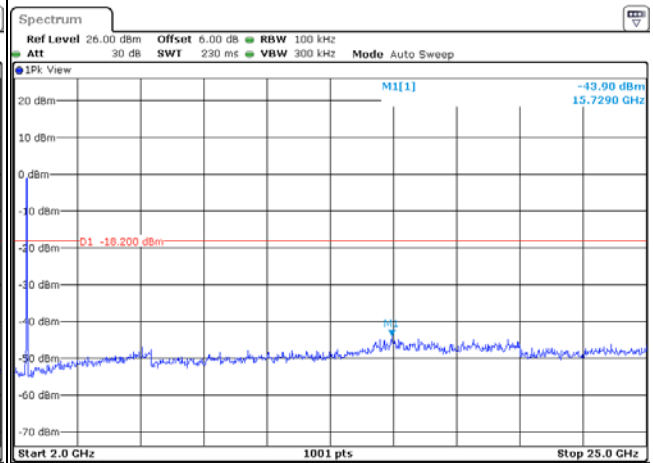

Date: 30.SEP.2014 19:46:15



Test Mode :	802.11n HT40	Temperature :	24~25°C
Test Band :	2.4GHz Low	Relative Humidity :	49~51%
Test Channel :	03	Test Engineer :	Issac Song

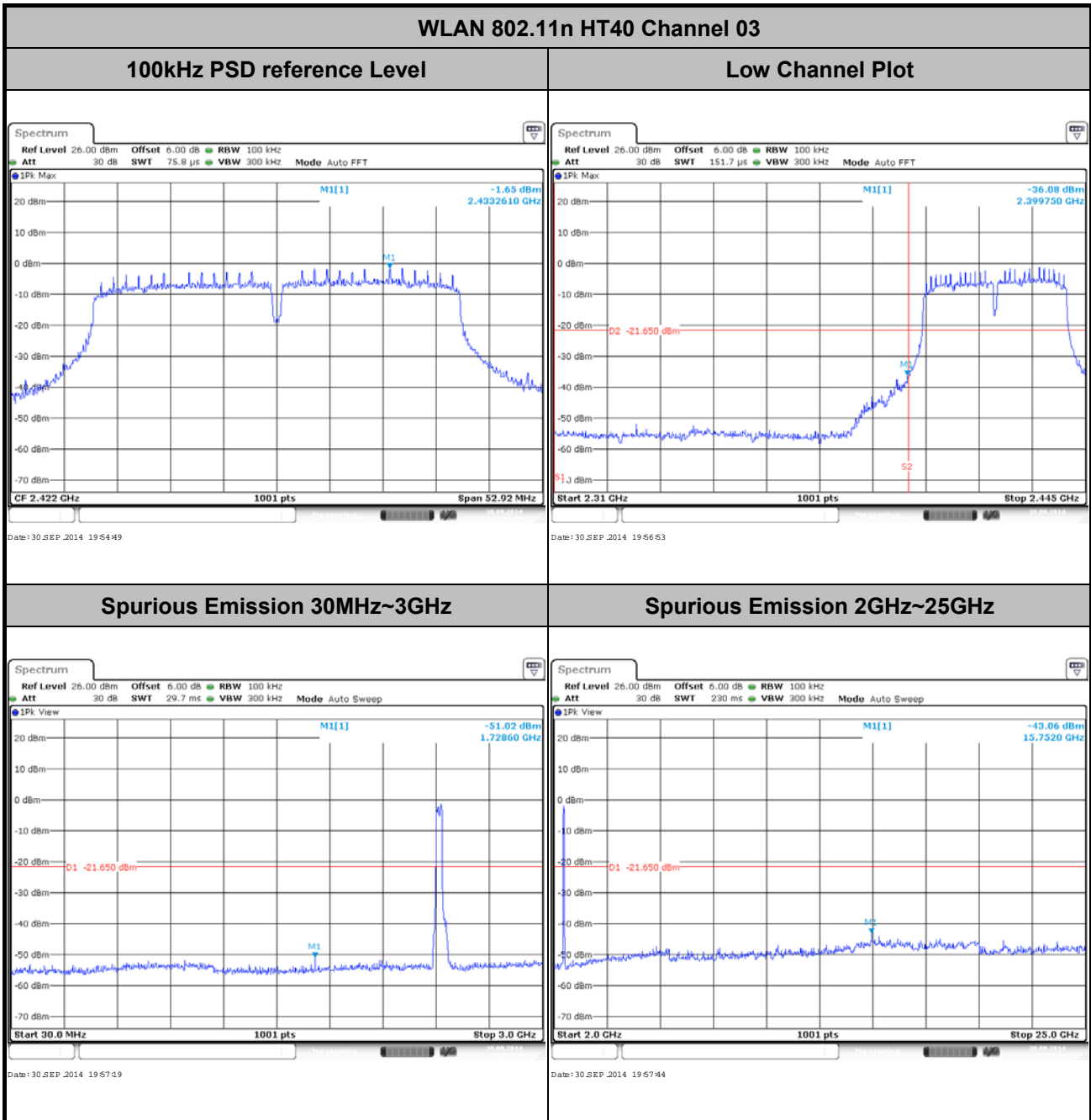



Test Mode :	802.11n HT40	Temperature :	24~25°C
Test Band :	2.4GHz Mid	Relative Humidity :	49~51%
Test Channel :	06	Test Engineer :	Issac Song

WLAN 802.11n HT40 Channel 06

100kHz PSD reference Level

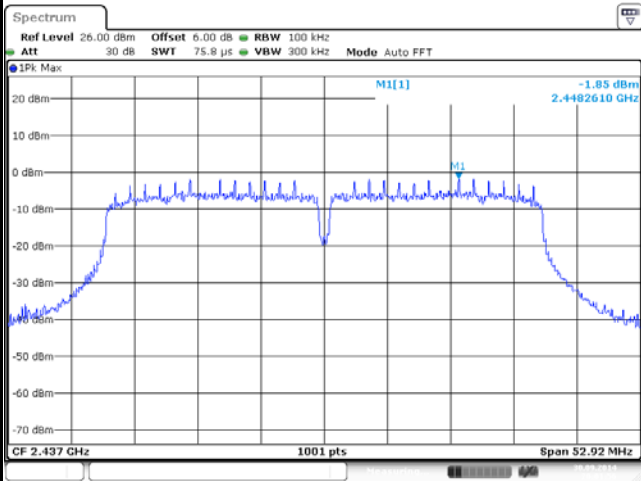

Date: 30.SEP.2014 20:01:56

Spurious Emission 30MHz~3GHz

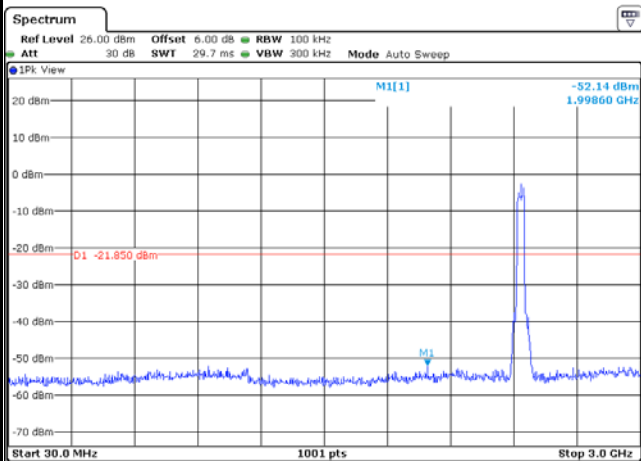

Date: 30.SEP.2014 20:05:22

Spurious Emission 2GHz~25GHz

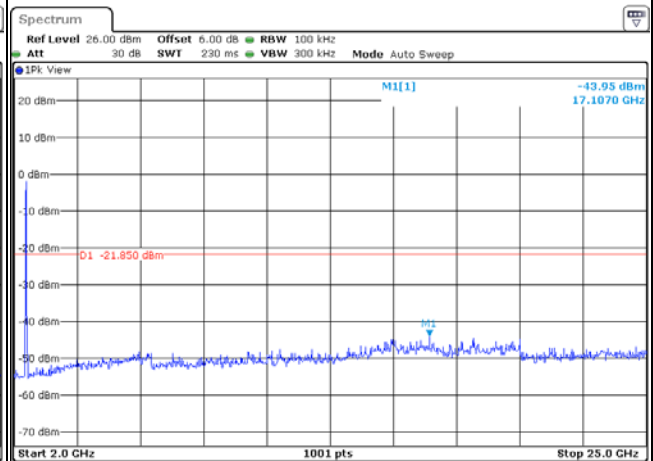

Date: 30.SEP.2014 20:04:10



Test Mode :	802.11n HT40	Temperature :	24~25°C
Test Band :	2.4GHz High	Relative Humidity :	49~51%
Test Channel :	09	Test Engineer :	Issac Song

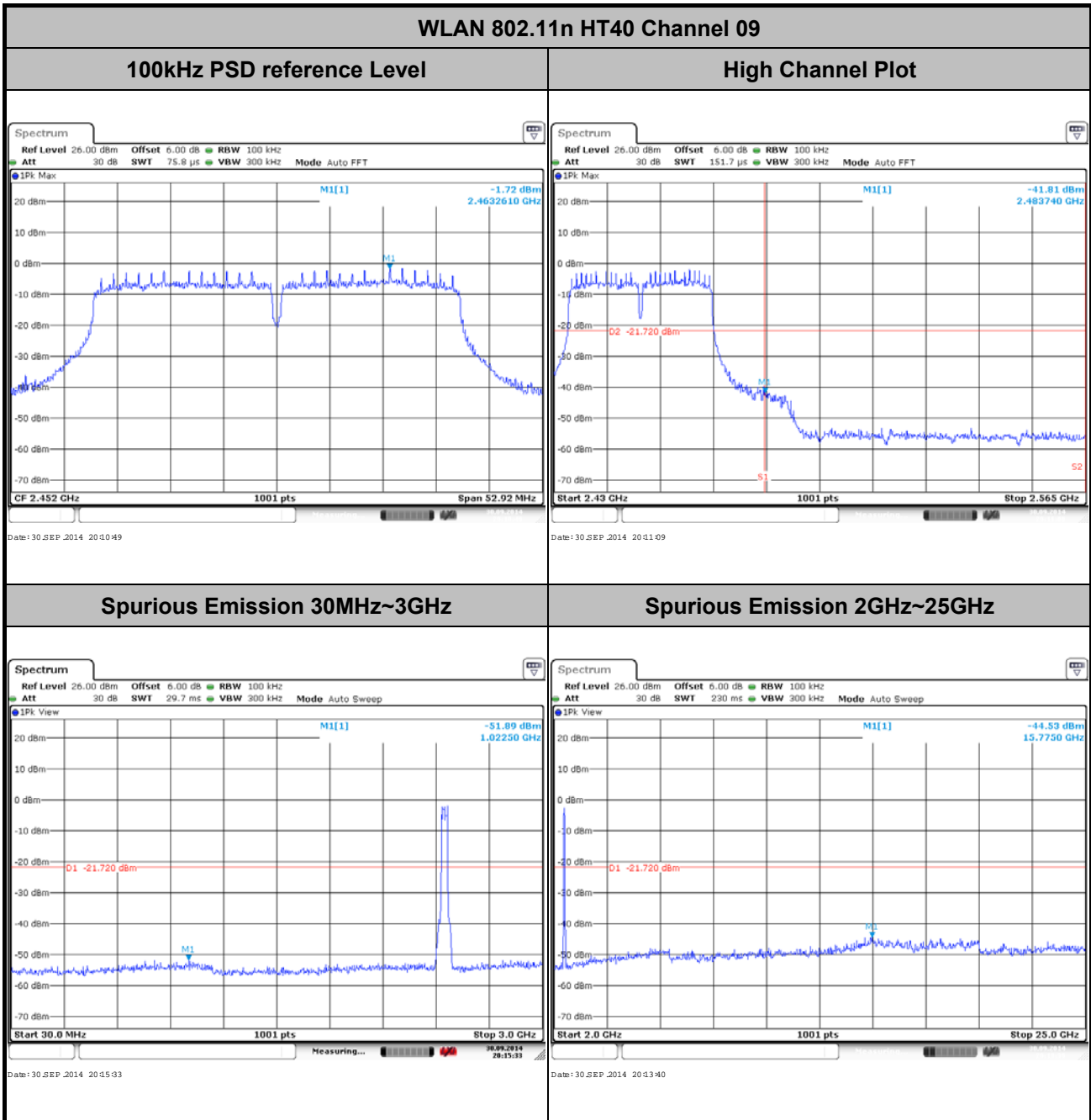



3.5 Radiated Band Edges and Spurious Emission Measurement

3.5.1 Limit of Radiated band edge and Spurious Emission Measurement

In any 100 kHz bandwidth outside the intentional radiator frequency band, all harmonics/spurious must be at least 20 dB below the highest emission level within the authorized band. If the output power of this device was measured by spectrum analyzer, the attenuation under this paragraph shall be 30 dB instead of 20 dB. In addition, radiated emissions which fall in the restricted bands must also comply with the FCC section 15.209 limits as below.

Frequency (MHz)	Field Strength (microvolts/meter)	Measurement Distance (meters)
0.009 – 0.490	2400/F(kHz)	300
0.490 – 1.705	24000/F(kHz)	30
1.705 – 30.0	30	30
30 – 88	100	3
88 – 216	150	3
216 - 960	200	3
Above 960	500	3

3.5.2 Measuring Instruments

The measuring equipment is listed in the section 4 of this test report.



3.5.3 Test Procedures

1. The testing follows FCC KDB Publication No. 558074 D01 DTS Meas. Guidance v03r02.
2. The EUT was arranged to its worst case and then tune the antenna tower (from 1 m to 4 m) and turntable (from 0 degree to 360 degrees) to find the maximum reading. A pre-amp and a high pass filter are used for the test in order to get better signal level.
3. The EUT was placed on a turntable with 0.8 meter above ground.
4. The EUT was set 3 meters from the interference receiving antenna, which was mounted on the top of a variable height antenna tower.
5. Corrected Reading: Antenna Factor + Cable Loss + Read Level - Preamp Factor = Level
6. For measurement below 1GHz, If the emission level of the EUT measured by the peak detector is 3 dB lower than the applicable limit, the peak emission level will be reported. Otherwise, the emission measurement will be repeated using the quasi-peak detector and reported.
7. Use the following spectrum analyzer settings:
 - (1) Span shall wide enough to fully capture the emission being measured;
 - (2) Set RBW=100 kHz for $f < 1$ GHz; $VBW \geq RBW$; Sweep = auto; Detector function = peak; Trace = max hold;
 - (3) Set RBW = 1 MHz, VBW= 3MHz for $f \geq 1$ GHz for peak measurement.
 For average measurement:
 - $VBW = 10$ Hz, when duty cycle is no less than 98 percent.
 - $VBW \geq 1/T$, when duty cycle is less than 98 percent where T is the minimum transmission duration over which the transmitter is on and is transmitting at its maximum power control level for the tested mode of operation.

Band	Duty Cycle(%)	T(ms)	1/T(kHz)	VBW Setting
802.11b	97.59	8.23	0.12	300Hz
802.11g	87.50	1.37	0.73	1kHz
2.4GHz 802.11n HT20	86.50	1.27	0.79	1kHz
2.4GHz 802.11n HT40	76.30	0.64	1.56	3kHz

3.5.4 Test Setup

For radiated emissions below 30MHz

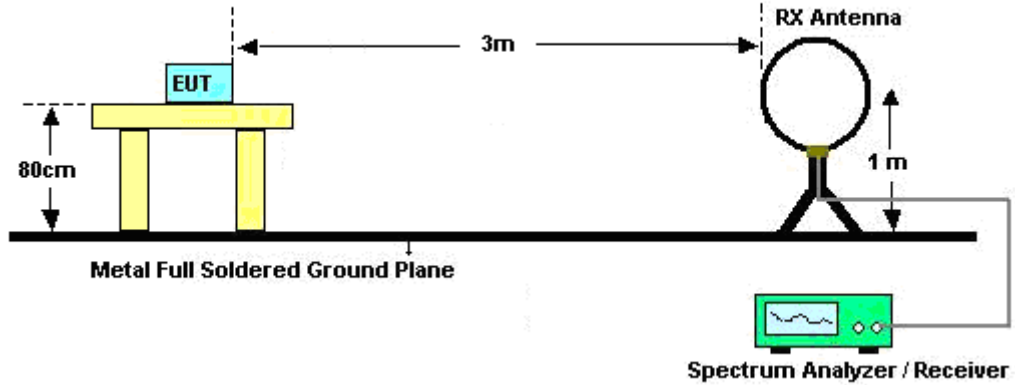

For radiated emissions from 30MHz to 1GHz

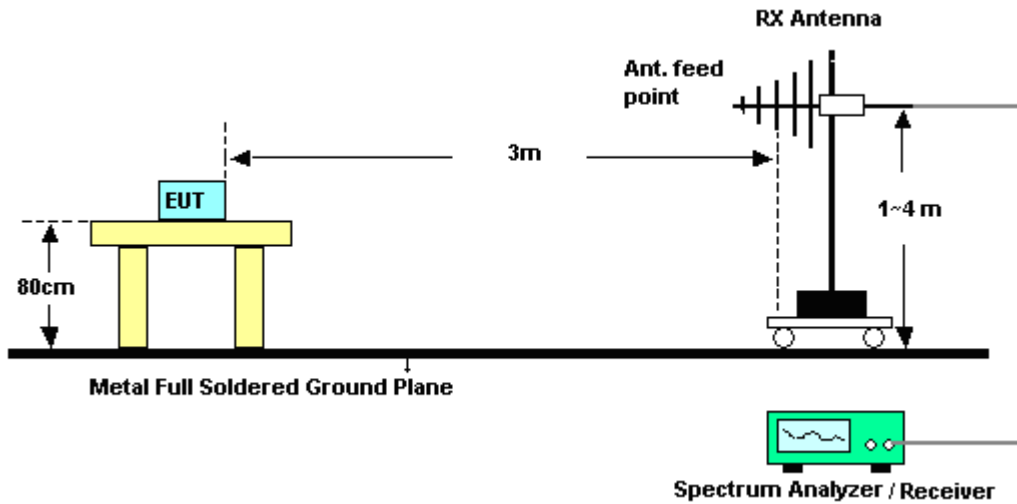

For radiated emissions above 1GHz

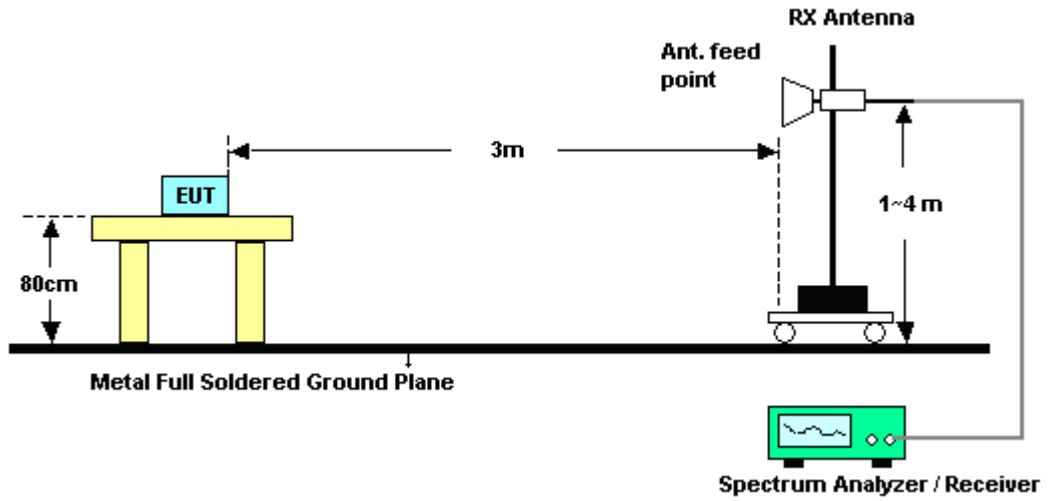

3.5.5 Test Results of Radiated Spurious Emissions (9kHz ~ 30MHz)

The low frequency, which started from 9 kHz to 30MHz, was pre-scanned and the result which was 20dB lower than the limit line per 15.31(o) was not reported.



3.5.6 Test Result of Radiated Spurious at Band Edges

Test Mode :	802.11b	Temperature :	22~23°C
Test Band :	Low	Relative Humidity :	40~42%
Test Channel :	01	Test Engineer :	Nick Su

ANTENNA POLARITY : HORIZONTAL										
Frequency (MHz)	Level (dBμV/m)	Over Limit (dB)	Limit Line (dBμV/m)	Read Level (dBμV)	Antenna Factor (dB)	Cable Loss (dB)	Preamp Factor (dB)	Ant Pos (cm)	Table Pos (deg)	Remark
2344.38	50.19	-23.81	74	52.1	31.82	2.61	36.34	149	274	Peak
2389.65	37.66	-16.34	54	39.09	32.01	2.64	36.08	149	274	Average

ANTENNA POLARITY : VERTICAL										
Frequency (MHz)	Level (dBμV/m)	Over Limit (dB)	Limit Line (dBμV/m)	Read Level (dBμV)	Antenna Factor (dB)	Cable Loss (dB)	Preamp Factor (dB)	Ant Pos (cm)	Table Pos (deg)	Remark
2353.92	50.22	-23.78	74	51.97	31.89	2.61	36.25	100	16	Peak
2388.03	37.57	-16.43	54	39	32.01	2.64	36.08	100	16	Average

Test Mode :	802.11b	Temperature :	22~23°C
Test Band :	High	Relative Humidity :	40~42%
Test Channel :	11	Test Engineer :	Nick Su

ANTENNA POLARITY : HORIZONTAL										
Frequency (MHz)	Level (dBμV/m)	Over Limit (dB)	Limit Line (dBμV/m)	Read Level (dBμV)	Antenna Factor (dB)	Cable Loss (dB)	Preamp Factor (dB)	Ant Pos (cm)	Table Pos (deg)	Remark
2494.93	51.17	-22.83	74	51.83	32.4	2.68	35.74	151	276	Peak
2483.5	38.86	-15.14	54	39.63	32.34	2.68	35.79	151	276	Average

ANTENNA POLARITY : VERTICAL										
Frequency (MHz)	Level (dBμV/m)	Over Limit (dB)	Limit Line (dBμV/m)	Read Level (dBμV)	Antenna Factor (dB)	Cable Loss (dB)	Preamp Factor (dB)	Ant Pos (cm)	Table Pos (deg)	Remark
2485.24	51.27	-22.73	74	52.04	32.34	2.68	35.79	100	62	Peak
2483.62	38.98	-15.02	54	39.75	32.34	2.68	35.79	100	62	Average



Test Mode :	802.11g	Temperature :	22~23°C
Test Band :	Low	Relative Humidity :	40~42%
Test Channel :	01	Test Engineer :	Nick Su

ANTENNA POLARITY : HORIZONTAL										
Frequency (MHz)	Level (dBμV/m)	Over Limit (dB)	Limit Line (dBμV/m)	Read Level (dBμV)	Antenna Factor (dB)	Cable Loss (dB)	Preamp Factor (dB)	Ant Pos (cm)	Table Pos (deg)	Remark
2390	65.76	-8.24	74	67.19	32.01	2.64	36.08	200	140	Peak
2390	42	-12	54	43.43	32.01	2.64	36.08	200	140	Average

ANTENNA POLARITY : VERTICAL										
Frequency (MHz)	Level (dBμV/m)	Over Limit (dB)	Limit Line (dBμV/m)	Read Level (dBμV)	Antenna Factor (dB)	Cable Loss (dB)	Preamp Factor (dB)	Ant Pos (cm)	Table Pos (deg)	Remark
2390	62.19	-11.81	74	63.62	32.01	2.64	36.08	100	178	Peak
2390	41.25	-12.75	54	42.68	32.01	2.64	36.08	100	178	Average

Test Mode :	802.11g	Temperature :	22~23°C
Test Band :	High	Relative Humidity :	40~42%
Test Channel :	11	Test Engineer :	Nick Su

ANTENNA POLARITY : HORIZONTAL										
Frequency (MHz)	Level (dBμV/m)	Over Limit (dB)	Limit Line (dBμV/m)	Read Level (dBμV)	Antenna Factor (dB)	Cable Loss (dB)	Preamp Factor (dB)	Ant Pos (cm)	Table Pos (deg)	Remark
2483.68	69.1	-4.9	74	69.87	32.34	2.68	35.79	100	304	Peak
2483.56	45.91	-8.09	54	46.68	32.34	2.68	35.79	100	304	Average

ANTENNA POLARITY : VERTICAL										
Frequency (MHz)	Level (dBμV/m)	Over Limit (dB)	Limit Line (dBμV/m)	Read Level (dBμV)	Antenna Factor (dB)	Cable Loss (dB)	Preamp Factor (dB)	Ant Pos (cm)	Table Pos (deg)	Remark
2483.86	66.62	-7.38	74	67.39	32.34	2.68	35.79	100	0	Peak
2483.5	43.27	-10.73	54	44.04	32.34	2.68	35.79	100	0	Average



Test Mode :	802.11n HT20	Temperature :	22~23°C
Test Band :	Low	Relative Humidity :	40~42%
Test Channel :	01	Test Engineer :	Nick Su

ANTENNA POLARITY : HORIZONTAL										
Frequency (MHz)	Level (dBμV/m)	Over Limit (dB)	Limit Line (dBμV/m)	Read Level (dBμV)	Antenna Factor (dB)	Cable Loss (dB)	Preamp Factor (dB)	Ant Pos (cm)	Table Pos (deg)	Remark
2389.92	60.59	-13.41	74	62.02	32.01	2.64	36.08	100	199	Peak
2390	40.83	-13.17	54	42.26	32.01	2.64	36.08	100	199	Average

ANTENNA POLARITY : VERTICAL										
Frequency (MHz)	Level (dBμV/m)	Over Limit (dB)	Limit Line (dBμV/m)	Read Level (dBμV)	Antenna Factor (dB)	Cable Loss (dB)	Preamp Factor (dB)	Ant Pos (cm)	Table Pos (deg)	Remark
2389.74	58.38	-15.62	74	59.81	32.01	2.64	36.08	100	116	Peak
2389.83	38.71	-15.29	54	40.14	32.01	2.64	36.08	100	116	Average

Test Mode :	802.11n HT20	Temperature :	22~23°C
Test Band :	High	Relative Humidity :	40~42%
Test Channel :	11	Test Engineer :	Nick Su

ANTENNA POLARITY : HORIZONTAL										
Frequency (MHz)	Level (dBμV/m)	Over Limit (dB)	Limit Line (dBμV/m)	Read Level (dBμV)	Antenna Factor (dB)	Cable Loss (dB)	Preamp Factor (dB)	Ant Pos (cm)	Table Pos (deg)	Remark
2483.68	65.12	-8.88	74	65.89	32.34	2.68	35.79	115	193	Peak
2483.56	42.54	-11.46	54	43.31	32.34	2.68	35.79	115	193	Average

ANTENNA POLARITY : VERTICAL										
Frequency (MHz)	Level (dBμV/m)	Over Limit (dB)	Limit Line (dBμV/m)	Read Level (dBμV)	Antenna Factor (dB)	Cable Loss (dB)	Preamp Factor (dB)	Ant Pos (cm)	Table Pos (deg)	Remark
2483.59	62.31	-11.69	74	63.08	32.34	2.68	35.79	100	98	Peak
2483.5	40.98	-13.02	54	41.75	32.34	2.68	35.79	100	98	Average



Test Mode :	802.11n HT40	Temperature :	22~23°C
Test Band :	Low	Relative Humidity :	40~42%
Test Channel :	03	Test Engineer :	Nick Su

ANTENNA POLARITY : HORIZONTAL										
Frequency (MHz)	Level (dBμV/m)	Over Limit (dB)	Limit Line (dBμV/m)	Read Level (dBμV)	Antenna Factor (dB)	Cable Loss (dB)	Preamp Factor (dB)	Ant Pos (cm)	Table Pos (deg)	Remark
2387.04	62.33	-11.67	74	63.76	32.01	2.64	36.08	120	329	Peak
2389.92	46	-8	54	47.43	32.01	2.64	36.08	120	329	Average
2483.53	53.54	-20.46	74	54.31	32.34	2.68	35.79	100	192	Peak
2483.8	38.98	-15.02	54	39.75	32.34	2.68	35.79	100	192	Average

ANTENNA POLARITY : VERTICAL										
Frequency (MHz)	Level (dBμV/m)	Over Limit (dB)	Limit Line (dBμV/m)	Read Level (dBμV)	Antenna Factor (dB)	Cable Loss (dB)	Preamp Factor (dB)	Ant Pos (cm)	Table Pos (deg)	Remark
2389.11	62.24	-11.76	74	63.67	32.01	2.64	36.08	103	53	Peak
2390	45.1	-8.9	54	46.53	32.01	2.64	36.08	103	52	Average
2486.14	52.56	-21.44	74	53.33	32.34	2.68	35.79	104	52	Peak
2486.11	38.81	-15.19	54	39.58	32.34	2.68	35.79	104	52	Average



Test Mode :	802.11n HT40	Temperature :	22~23°C
Test Band :	High	Relative Humidity :	40~42%
Test Channel :	09	Test Engineer :	Nick Su

ANTENNA POLARITY : HORIZONTAL										
Frequency (MHz)	Level (dBμV/m)	Over Limit (dB)	Limit Line (dBμV/m)	Read Level (dBμV)	Antenna Factor (dB)	Cable Loss (dB)	Preamp Factor (dB)	Ant Pos (cm)	Table Pos (deg)	Remark
2320.26	50.06	-23.94	74	52.15	31.76	2.58	36.43	100	194	Peak
2388.75	38.41	-15.59	54	39.84	32.01	2.64	36.08	100	194	Average
2484.07	66.54	-7.46	74	67.31	32.34	2.68	35.79	143	191	Peak
2483.59	45.6	-8.4	54	46.37	32.34	2.68	35.79	143	191	Average

ANTENNA POLARITY : VERTICAL										
Frequency (MHz)	Level (dBμV/m)	Over Limit (dB)	Limit Line (dBμV/m)	Read Level (dBμV)	Antenna Factor (dB)	Cable Loss (dB)	Preamp Factor (dB)	Ant Pos (cm)	Table Pos (deg)	Remark
2374.71	50.12	-23.88	74	51.71	31.95	2.62	36.16	100	47	Peak
2389.38	38.18	-15.82	54	39.61	32.01	2.64	36.08	100	47	Average
2485.66	66.26	-7.74	74	67.03	32.34	2.68	35.79	100	53	Peak
2483.59	45.58	-8.42	54	46.35	32.34	2.68	35.79	100	53	Average



3.5.7 Test Result of Radiated Spurious Emission (30MHz ~ 10th Harmonic)

Note: Pre-scanned all test modes and only choose the worst case mode recorded in the test report for radiated spurious emission below 1GHz.

Test Mode :	802.11b	Temperature :	22~23°C
Test Channel :	01	Relative Humidity :	40~42%
Test Engineer :	Nick Su	Polarization :	Horizontal
Remark :	1. 2412 MHz is fundamental signal which can be ignored. 2. Average measurement was not performed if peak level went lower than the average limit.		

Frequency (MHz)	Level (dBμV/m)	Over Limit (dB)	Limit Line (dBμV/m)	Read Level (dBμV)	Antenna Factor (dB)	Cable Loss (dB)	Preamp Factor (dB)	Ant Pos (cm)	Table Pos (deg)	Remark
2412	101.97	-	-	103.25	32.08	2.66	36.02	149	274	Peak
2412	96.16	-	-	97.44	32.08	2.66	36.02	149	274	Average
4824	44.98	-29.02	74	43.65	34.2	3.78	36.65	112	58	Peak

Test Mode :	802.11b	Temperature :	22~23°C
Test Channel :	01	Relative Humidity :	40~42%
Test Engineer :	Nick Su	Polarization :	Vertical
Remark :	1. 2412 MHz is fundamental signal which can be ignored. 2. Average measurement was not performed if peak level went lower than the average limit.		

Frequency (MHz)	Level (dBμV/m)	Over Limit (dB)	Limit Line (dBμV/m)	Read Level (dBμV)	Antenna Factor (dB)	Cable Loss (dB)	Preamp Factor (dB)	Ant Pos (cm)	Table Pos (deg)	Remark
2412	99	-	-	100.28	32.08	2.66	36.02	100	16	Peak
2412	93.36	-	-	94.64	32.08	2.66	36.02	100	16	Average
4824	44.9	-29.1	74	43.57	34.2	3.78	36.65	100	0	Peak



Test Mode :	802.11b	Temperature :	22~23°C
Test Channel :	06	Relative Humidity :	40~42%
Test Engineer :	Nick Su	Polarization :	Horizontal
Remark :	1. 2437 MHz is fundamental signal which can be ignored. 2. Average measurement was not performed if peak level went lower than the average limit.		

Frequency (MHz)	Level (dBμV/m)	Over Limit (dB)	Limit Line (dBμV/m)	Read Level (dBμV)	Antenna Factor (dB)	Cable Loss (dB)	Preamp Factor (dB)	Ant Pos (cm)	Table Pos (deg)	Remark
2437	99.04	-	-	100.08	32.21	2.66	35.91	151	300	Peak
2437	94.31	-	-	95.35	32.21	2.66	35.91	151	300	Average
4874	44.56	-29.44	74	43.42	34.2	3.78	36.84	123	47	Peak
7312	46.63	-27.37	74	45.04	35.72	4.73	38.86	100	0	Peak

Test Mode :	802.11b	Temperature :	22~23°C
Test Channel :	06	Relative Humidity :	40~42%
Test Engineer :	Nick Su	Polarization :	Vertical
Remark :	1. 2437 MHz is fundamental signal which can be ignored. 2. Average measurement was not performed if peak level went lower than the average limit.		

Frequency (MHz)	Level (dBμV/m)	Over Limit (dB)	Limit Line (dBμV/m)	Read Level (dBμV)	Antenna Factor (dB)	Cable Loss (dB)	Preamp Factor (dB)	Ant Pos (cm)	Table Pos (deg)	Remark
2437	104.32	-	-	105.36	32.21	2.66	35.91	100	106	Peak
2437	98.86	-	-	99.9	32.21	2.66	35.91	100	106	Average
4874	44.19	-29.81	74	43.05	34.2	3.78	36.84	100	34	Peak
7312	46.25	-27.75	74	44.66	35.72	4.73	38.86	110	78	Peak



Test Mode :	802.11b	Temperature :	22~23°C
Test Channel :	11	Relative Humidity :	40~42%
Test Engineer :	Nick Su	Polarization :	Horizontal
Remark :	1. 2462 MHz is fundamental signal which can be ignored. 2. Average measurement was not performed if peak level went lower than the average limit.		

Frequency (MHz)	Level (dBμV/m)	Over Limit (dB)	Limit Line (dBμV/m)	Read Level (dBμV)	Antenna Factor (dB)	Cable Loss (dB)	Preamp Factor (dB)	Ant Pos (cm)	Table Pos (deg)	Remark
2462	102.19	-	-	103.1	32.27	2.67	35.85	151	276	Peak
2462	97.29	-	-	98.2	32.27	2.67	35.85	151	276	Average
4924	44.48	-29.52	74	43.53	34.2	3.78	37.03	100	145	Peak
7386	47.36	-26.64	74	46.02	35.76	4.77	39.19	145	87	Peak

Test Mode :	802.11b	Temperature :	22~23°C
Test Channel :	11	Relative Humidity :	40~42%
Test Engineer :	Nick Su	Polarization :	Vertical
Remark :	1. 2462 MHz is fundamental signal which can be ignored. 2. Average measurement was not performed if peak level went lower than the average limit.		

Frequency (MHz)	Level (dBμV/m)	Over Limit (dB)	Limit Line (dBμV/m)	Read Level (dBμV)	Antenna Factor (dB)	Cable Loss (dB)	Preamp Factor (dB)	Ant Pos (cm)	Table Pos (deg)	Remark
2462	101.49	-	-	102.4	32.27	2.67	35.85	100	62	Peak
2462	96.71	-	-	97.62	32.27	2.67	35.85	100	62	Average
4924	45.65	-28.35	74	44.7	34.2	3.78	37.03	100	48	Peak
7386	46.71	-27.29	74	45.37	35.76	4.77	39.19	100	54	Peak



Test Mode :	802.11g	Temperature :	22~23°C
Test Channel :	01	Relative Humidity :	40~42%
Test Engineer :	Nick Su	Polarization :	Horizontal
Remark :	1. 2412 MHz is fundamental signal which can be ignored. 2. Average measurement was not performed if peak level went lower than the average limit.		

Frequency (MHz)	Level (dBμV/m)	Over Limit (dB)	Limit Line (dBμV/m)	Read Level (dBμV)	Antenna Factor (dB)	Cable Loss (dB)	Preamp Factor (dB)	Ant Pos (cm)	Table Pos (deg)	Remark
2412	105.17	-	-	106.45	32.08	2.66	36.02	200	148	Peak
2412	93.57	-	-	94.85	32.08	2.66	36.02	200	148	Average
4824	44.5	-29.5	74	43.17	34.2	3.78	36.65	100	58	Peak

Test Mode :	802.11g	Temperature :	22~23°C
Test Channel :	01	Relative Humidity :	40~42%
Test Engineer :	Nick Su	Polarization :	Vertical
Remark :	1. 2412 MHz is fundamental signal which can be ignored. 2. Average measurement was not performed if peak level went lower than the average limit.		

Frequency (MHz)	Level (dBμV/m)	Over Limit (dB)	Limit Line (dBμV/m)	Read Level (dBμV)	Antenna Factor (dB)	Cable Loss (dB)	Preamp Factor (dB)	Ant Pos (cm)	Table Pos (deg)	Remark
2412	102.09	-	-	103.37	32.08	2.66	36.02	100	171	Peak
2412	90.41	-	-	91.69	32.08	2.66	36.02	100	171	Average
4824	45.55	-28.45	74	44.22	34.2	3.78	36.65	100	48	Peak



Test Mode :	802.11g	Temperature :	22~23°C
Test Channel :	06	Relative Humidity :	40~42%
Test Engineer :	Nick Su	Polarization :	Horizontal
Remark :	1. 2437 MHz is fundamental signal which can be ignored. 2. Average measurement was not performed if peak level went lower than the average limit.		

Frequency (MHz)	Level (dBμV/m)	Over Limit (dB)	Limit Line (dBμV/m)	Read Level (dBμV)	Antenna Factor (dB)	Cable Loss (dB)	Preamp Factor (dB)	Ant Pos (cm)	Table Pos (deg)	Remark
2437	104.15	-	-	105.19	32.21	2.66	35.91	100	299	Peak
2437	90.8	-	-	91.84	32.21	2.66	35.91	100	299	Average
4874	44.02	-29.98	74	42.88	34.2	3.78	36.84	100	56	Peak
7312	45.5	-28.5	74	43.91	35.72	4.73	38.86	125	62	Peak

Test Mode :	802.11g	Temperature :	22~23°C
Test Channel :	06	Relative Humidity :	40~42%
Test Engineer :	Nick Su	Polarization :	Vertical
Remark :	1. 2437 MHz is fundamental signal which can be ignored. 2. Average measurement was not performed if peak level went lower than the average limit.		

Frequency (MHz)	Level (dBμV/m)	Over Limit (dB)	Limit Line (dBμV/m)	Read Level (dBμV)	Antenna Factor (dB)	Cable Loss (dB)	Preamp Factor (dB)	Ant Pos (cm)	Table Pos (deg)	Remark
2437	101.85	-	-	102.89	32.21	2.66	35.91	100	165	Peak
2437	89.54	-	-	90.58	32.21	2.66	35.91	100	165	Average
4874	43.92	-30.08	74	42.78	34.2	3.78	36.84	100	36	Peak
7312	46.57	-27.43	74	44.98	35.72	4.73	38.86	100	58	Peak



Test Mode :	802.11g	Temperature :	22~23°C
Test Channel :	11	Relative Humidity :	40~42%
Test Engineer :	Nick Su	Polarization :	Horizontal
Remark :	1. 2462 MHz is fundamental signal which can be ignored. 2. Average measurement was not performed if peak level went lower than the average limit.		

Frequency (MHz)	Level (dBμV/m)	Over Limit (dB)	Limit Line (dBμV/m)	Read Level (dBμV)	Antenna Factor (dB)	Cable Loss (dB)	Preamp Factor (dB)	Ant Pos (cm)	Table Pos (deg)	Remark
67.83	25.17	-14.83	40	49.55	7.78	0.47	32.63	-	-	Peak
96.93	27.63	-15.87	43.5	48.84	10.97	0.43	32.61	-	-	Peak
133.79	26.63	-16.87	43.5	46.98	11.57	0.67	32.59	-	-	Peak
169.68	32.13	-11.37	43.5	52.86	10.95	0.83	32.51	125	60	Peak
226.91	27.1	-18.9	46	47.75	11.04	0.8	32.49	-	-	Peak
296.75	21.64	-24.36	46	40.27	12.95	0.81	32.39	-	-	Peak
2462	104.25	-	-	105.16	32.27	2.67	35.85	100	293	Peak
2462	92.53	-	-	93.44	32.27	2.67	35.85	100	293	Average
4924	45.03	-28.97	74	44.08	34.2	3.78	37.03	100	54	Peak
7386	46.78	-27.22	74	45.44	35.76	4.77	39.19	100	0	Peak



Test Mode :	802.11g	Temperature :	22~23°C
Test Channel :	11	Relative Humidity :	40~42%
Test Engineer :	Nick Su	Polarization :	Vertical
Remark :	1. 2462 MHz is fundamental signal which can be ignored. 2. Average measurement was not performed if peak level went lower than the average limit.		

Frequency (MHz)	Level (dBμV/m)	Over Limit (dB)	Limit Line (dBμV/m)	Read Level (dBμV)	Antenna Factor (dB)	Cable Loss (dB)	Preamp Factor (dB)	Ant Pos (cm)	Table Pos (deg)	Remark
30	23.59	-16.41	40	36.86	19.2	0.19	32.66	-	-	Peak
59.1	23.82	-16.18	40	49.59	6.36	0.47	32.6	-	-	Peak
98.87	29.25	-14.25	43.5	50.26	11.19	0.43	32.63	100	350	Peak
120.21	25.87	-17.63	43.5	46.47	11.46	0.58	32.64	-	-	Peak
151.25	25.86	-17.64	43.5	45.94	11.66	0.82	32.56	-	-	Peak
167.74	25.6	-17.9	43.5	46.26	11.03	0.83	32.52	-	-	Peak
2462	102.18	-	-	103.09	32.27	2.67	35.85	100	0	Peak
2462	89.67	-	-	90.58	32.27	2.67	35.85	100	0	Average
4924	42.67	-31.33	74	41.72	34.2	3.78	37.03	158	10	Peak
7386	45.45	-28.55	74	44.11	35.76	4.77	39.19	123	45	Peak



Test Mode :	2.4GHz 802.11n HT20	Temperature :	22~23°C
Test Channel :	01	Relative Humidity :	40~42%
Test Engineer :	Nick Su	Polarization :	Horizontal
Remark :	1. 2412 MHz is fundamental signal which can be ignored. 2. Average measurement was not performed if peak level went lower than the average limit.		

Frequency (MHz)	Level (dBμV/m)	Over Limit (dB)	Limit Line (dBμV/m)	Read Level (dBμV)	Antenna Factor (dB)	Cable Loss (dB)	Preamp Factor (dB)	Ant Pos (cm)	Table Pos (deg)	Remark
2412	104.64	-	-	105.92	32.08	2.66	36.02	100	199	Peak
2412	92.27	-	-	93.55	32.08	2.66	36.02	100	199	Average
4824	43.5	-30.5	74	42.17	34.2	3.78	36.65	100	32	Peak

Test Mode :	2.4GHz 802.11n HT20	Temperature :	22~23°C
Test Channel :	01	Relative Humidity :	40~42%
Test Engineer :	Nick Su	Polarization :	Vertical
Remark :	1. 2412 MHz is fundamental signal which can be ignored. 2. Average measurement was not performed if peak level went lower than the average limit.		

Frequency (MHz)	Level (dBμV/m)	Over Limit (dB)	Limit Line (dBμV/m)	Read Level (dBμV)	Antenna Factor (dB)	Cable Loss (dB)	Preamp Factor (dB)	Ant Pos (cm)	Table Pos (deg)	Remark
2412	101.52	-	-	102.8	32.08	2.66	36.02	104	116	Peak
2412	89.69	-	-	90.97	32.08	2.66	36.02	104	116	Average
4824	44.53	-29.47	74	43.2	34.2	3.78	36.65	108	215	Peak



Test Mode :	2.4GHz 802.11n HT20	Temperature :	22~23°C
Test Channel :	06	Relative Humidity :	40~42%
Test Engineer :	Nick Su	Polarization :	Horizontal
Remark :	1. 2437 MHz is fundamental signal which can be ignored. 2. Average measurement was not performed if peak level went lower than the average limit.		

Frequency (MHz)	Level (dBμV/m)	Over Limit (dB)	Limit Line (dBμV/m)	Read Level (dBμV)	Antenna Factor (dB)	Cable Loss (dB)	Preamp Factor (dB)	Ant Pos (cm)	Table Pos (deg)	Remark
2437	104.43	-	-	105.47	32.21	2.66	35.91	100	197	Peak
2437	92.64	-	-	93.68	32.21	2.66	35.91	100	197	Average
4874	43.36	-30.64	74	42.22	34.2	3.78	36.84	148	52	Peak
7312	45.5	-28.5	74	43.91	35.72	4.73	38.86	148	200	Peak

Test Mode :	2.4GHz 802.11n HT20	Temperature :	22~23°C
Test Channel :	06	Relative Humidity :	40~42%
Test Engineer :	Nick Su	Polarization :	Vertical
Remark :	1. 2437 MHz is fundamental signal which can be ignored. 2. Average measurement was not performed if peak level went lower than the average limit.		

Frequency (MHz)	Level (dBμV/m)	Over Limit (dB)	Limit Line (dBμV/m)	Read Level (dBμV)	Antenna Factor (dB)	Cable Loss (dB)	Preamp Factor (dB)	Ant Pos (cm)	Table Pos (deg)	Remark
2437	100.81	-	-	101.85	32.21	2.66	35.91	100	105	Peak
2437	89.55	-	-	90.59	32.21	2.66	35.91	100	105	Average
4874	43.98	-30.02	74	42.84	34.2	3.78	36.84	100	58	Peak
7312	46.39	-27.61	74	44.8	35.72	4.73	38.86	100	48	Peak



Test Mode :	2.4GHz 802.11n HT20	Temperature :	22~23°C
Test Channel :	11	Relative Humidity :	40~42%
Test Engineer :	Nick Su	Polarization :	Horizontal
Remark :	1. 2462 MHz is fundamental signal which can be ignored. 2. Average measurement was not performed if peak level went lower than the average limit.		

Frequency (MHz)	Level (dBμV/m)	Over Limit (dB)	Limit Line (dBμV/m)	Read Level (dBμV)	Antenna Factor (dB)	Cable Loss (dB)	Preamp Factor (dB)	Ant Pos (cm)	Table Pos (deg)	Remark
2462	104.36	-	-	105.27	32.27	2.67	35.85	100	194	Peak
2462	92.65	-	-	93.56	32.27	2.67	35.85	100	194	Average
4924	42.65	-31.35	74	41.7	34.2	3.78	37.03	100	251	Peak
7386	46.64	-27.36	74	45.3	35.76	4.77	39.19	100	122	Peak

Test Mode :	2.4GHz 802.11n HT20	Temperature :	22~23°C
Test Channel :	11	Relative Humidity :	40~42%
Test Engineer :	Nick Su	Polarization :	Vertical
Remark :	1. 2462 MHz is fundamental signal which can be ignored. 2. Average measurement was not performed if peak level went lower than the average limit.		

Frequency (MHz)	Level (dBμV/m)	Over Limit (dB)	Limit Line (dBμV/m)	Read Level (dBμV)	Antenna Factor (dB)	Cable Loss (dB)	Preamp Factor (dB)	Ant Pos (cm)	Table Pos (deg)	Remark
2462	101.82	-	-	102.73	32.27	2.67	35.85	100	104	Peak
2462	88.95	-	-	89.86	32.27	2.67	35.85	100	104	Average
4924	45.56	-28.44	74	44.61	34.2	3.78	37.03	125	140	Peak
7386	46.27	-27.73	74	44.93	35.76	4.77	39.19	100	56	Peak



Test Mode :	2.4GHz 802.11n HT40	Temperature :	22~23°C
Test Channel :	03	Relative Humidity :	40~42%
Test Engineer :	Nick Su	Polarization :	Horizontal
Remark :	1. 2422 MHz is fundamental signal which can be ignored. 2. Average measurement was not performed if peak level went lower than the average limit.		

Frequency (MHz)	Level (dBμV/m)	Over Limit (dB)	Limit Line (dBμV/m)	Read Level (dBμV)	Antenna Factor (dB)	Cable Loss (dB)	Preamp Factor (dB)	Ant Pos (cm)	Table Pos (deg)	Remark
2422	102.41	-	-	103.57	32.14	2.66	35.96	100	192	Peak
2422	90.57	-	-	91.73	32.14	2.66	35.96	100	192	Average
4844	45.57	-28.43	74	44.31	34.2	3.78	36.72	125	145	Peak
7266	46.35	-27.65	74	44.65	35.71	4.72	38.73	105	95	Peak

Test Mode :	2.4GHz 802.11n HT40	Temperature :	22~23°C
Test Channel :	03	Relative Humidity :	40~42%
Test Engineer :	Nick Su	Polarization :	Vertical
Remark :	1. 2422 MHz is fundamental signal which can be ignored. 2. Average measurement was not performed if peak level went lower than the average limit.		

Frequency (MHz)	Level (dBμV/m)	Over Limit (dB)	Limit Line (dBμV/m)	Read Level (dBμV)	Antenna Factor (dB)	Cable Loss (dB)	Preamp Factor (dB)	Ant Pos (cm)	Table Pos (deg)	Remark
2422	100.22	-	-	101.38	32.14	2.66	35.96	104	52	Peak
2422	89.75	-	-	90.91	32.14	2.66	35.96	104	52	Average
4844	45.35	-28.65	74	44.09	34.2	3.78	36.72	200	0	Peak
7266	46.84	-27.16	74	45.14	35.71	4.72	38.73	127	340	Peak



Test Mode :	2.4GHz 802.11n HT40	Temperature :	22~23°C
Test Channel :	06	Relative Humidity :	40~42%
Test Engineer :	Nick Su	Polarization :	Horizontal
Remark :	1. 2437 MHz is fundamental signal which can be ignored. 2. Average measurement was not performed if peak level went lower than the average limit.		

Frequency (MHz)	Level (dBμV/m)	Over Limit (dB)	Limit Line (dBμV/m)	Read Level (dBμV)	Antenna Factor (dB)	Cable Loss (dB)	Preamp Factor (dB)	Ant Pos (cm)	Table Pos (deg)	Remark
2437	99.26	-	-	100.3	32.21	2.66	35.91	147	190	Peak
2437	88.01	-	-	89.05	32.21	2.66	35.91	147	190	Average
4874	44.47	-29.53	74	43.33	34.2	3.78	36.84	105	147	Peak
7311	47.81	-26.19	74	46.22	35.72	4.73	38.86	108	214	Peak

Test Mode :	2.4GHz 802.11n HT40	Temperature :	22~23°C
Test Channel :	06	Relative Humidity :	40~42%
Test Engineer :	Nick Su	Polarization :	Vertical
Remark :	1. 2437 MHz is fundamental signal which can be ignored. 2. Average measurement was not performed if peak level went lower than the average limit.		

Frequency (MHz)	Level (dBμV/m)	Over Limit (dB)	Limit Line (dBμV/m)	Read Level (dBμV)	Antenna Factor (dB)	Cable Loss (dB)	Preamp Factor (dB)	Ant Pos (cm)	Table Pos (deg)	Remark
2437	99.39	-	-	100.43	32.21	2.66	35.91	106	51	Peak
2437	88.18	-	-	89.22	32.21	2.66	35.91	106	51	Average
4874	45.29	-28.71	74	44.15	34.2	3.78	36.84	200	189	Peak
7311	46.59	-27.41	74	45	35.72	4.73	38.86	108	143	Peak



Test Mode :	2.4GHz 802.11n HT40	Temperature :	22~23°C
Test Channel :	09	Relative Humidity :	40~42%
Test Engineer :	Nick Su	Polarization :	Horizontal
Remark :	1. 2452 MHz is fundamental signal which can be ignored. 2. Average measurement was not performed if peak level went lower than the average limit.		

Frequency (MHz)	Level (dBμV/m)	Over Limit (dB)	Limit Line (dBμV/m)	Read Level (dBμV)	Antenna Factor (dB)	Cable Loss (dB)	Preamp Factor (dB)	Ant Pos (cm)	Table Pos (deg)	Remark
2452	99.3	-	-	100.33	32.21	2.67	35.91	100	194	Peak
2452	88.66	-	-	89.69	32.21	2.67	35.91	100	194	Average
4904	44.21	-29.79	74	43.19	34.2	3.78	36.96	157	320	Peak
7356	47.45	-26.55	74	46.01	35.74	4.76	39.06	127	198	Peak

Test Mode :	2.4GHz 802.11n HT40	Temperature :	22~23°C
Test Channel :	09	Relative Humidity :	40~42%
Test Engineer :	Nick Su	Polarization :	Vertical
Remark :	1. 2452 MHz is fundamental signal which can be ignored. 2. Average measurement was not performed if peak level went lower than the average limit.		

Frequency (MHz)	Level (dBμV/m)	Over Limit (dB)	Limit Line (dBμV/m)	Read Level (dBμV)	Antenna Factor (dB)	Cable Loss (dB)	Preamp Factor (dB)	Ant Pos (cm)	Table Pos (deg)	Remark
2452	100.24	-	-	101.27	32.21	2.67	35.91	100	47	Peak
2452	89.28	-	-	90.31	32.21	2.67	35.91	100	47	Average
4904	44.8	-29.2	74	43.78	34.2	3.78	36.96	195	319	Peak
7356	47.42	-26.58	74	45.98	35.74	4.76	39.06	128	254	Peak



3.6 AC Conducted Emission Measurement

3.6.1 Limit of AC Conducted Emission

For equipment that is designed to be connected to the public utility (AC) power line, the radio frequency voltage that is conducted back onto the AC power line on any frequency or frequencies within the band 150 kHz to 30 MHz shall not exceed the limits in the following table.

Frequency of Emission (MHz)	Conducted Limit (dB μ V)	
	Quasi-Peak	Average
0.15-0.5	66 to 56*	56 to 46*
0.5-5	56	46
5-30	60	50

*Decreases with the logarithm of the frequency.

3.6.2 Measuring Instruments

The measuring equipment is listed in the section 4 of this test report.

3.6.3 Test Procedures

1. The EUT was placed 0.4 meter from the conducting wall of the shielding room, and it was kept at least 80 centimeters from any other grounded conducting surface.
2. Connect EUT to the power mains through a line impedance stabilization network (LISN).
3. All the support units are connecting to the other LISN.
4. The LISN provides 50 ohm coupling impedance for the measuring instrument.
5. The FCC states that a 50 ohm, 50 microhenry LISN should be used.
6. Both sides of AC line were checked for maximum conducted interference.
7. The frequency range from 150 kHz to 30 MHz was searched.
8. Set the test-receiver system to Peak Detect Function and specified bandwidth (IF bandwidth = 9kHz) with Maximum Hold Mode.

3.6.4 Test Setup

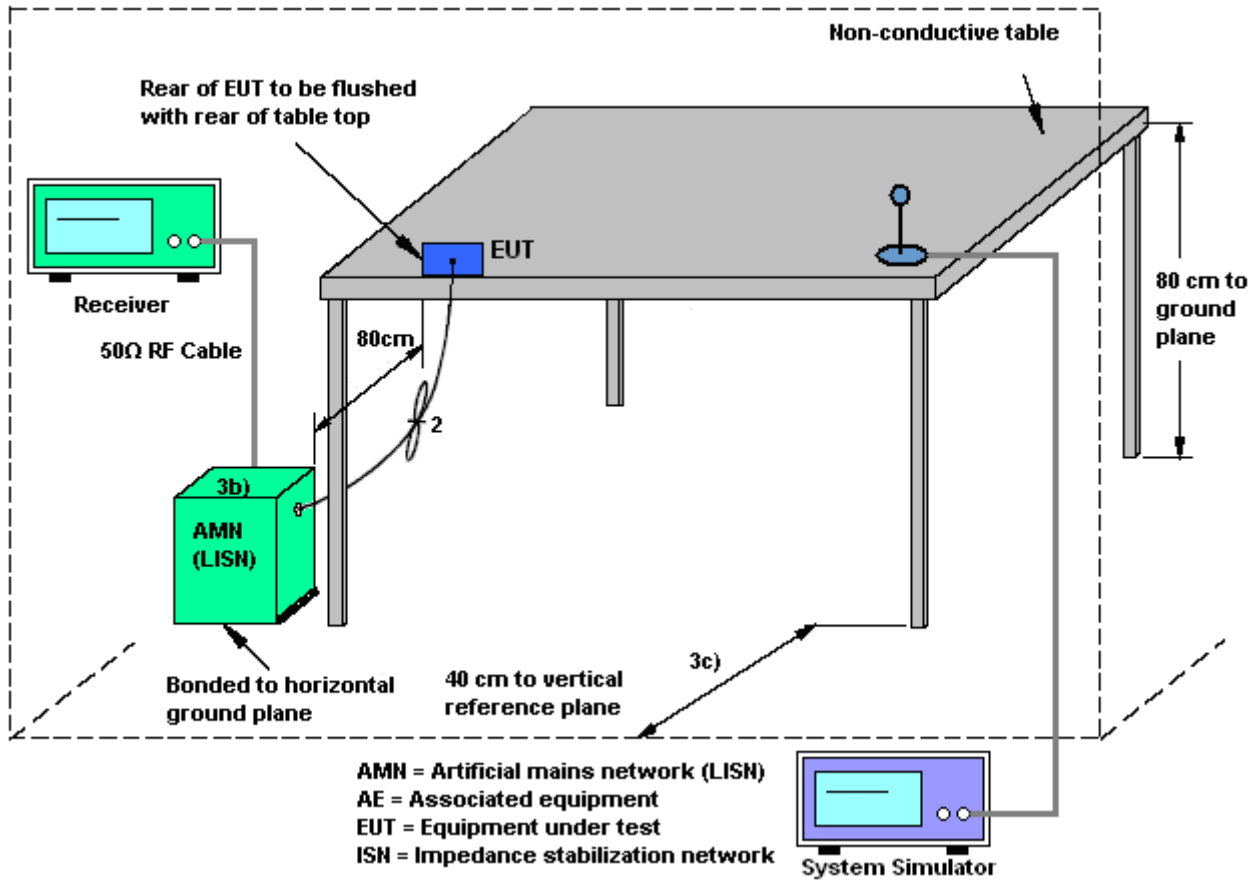



3.6.5 Test Result of AC Conducted Emission

Test Mode :	Mode 1	Temperature :	22~24°C
Test Engineer :	Eligah Wang	Relative Humidity :	55~58%
Test Voltage :	120Vac / 60Hz	Phase :	Line
Function Type :	GSM850 Idle + Bluetooth Link + WLAN Link + USB Cable (Charging from Adapter) + Earphone		

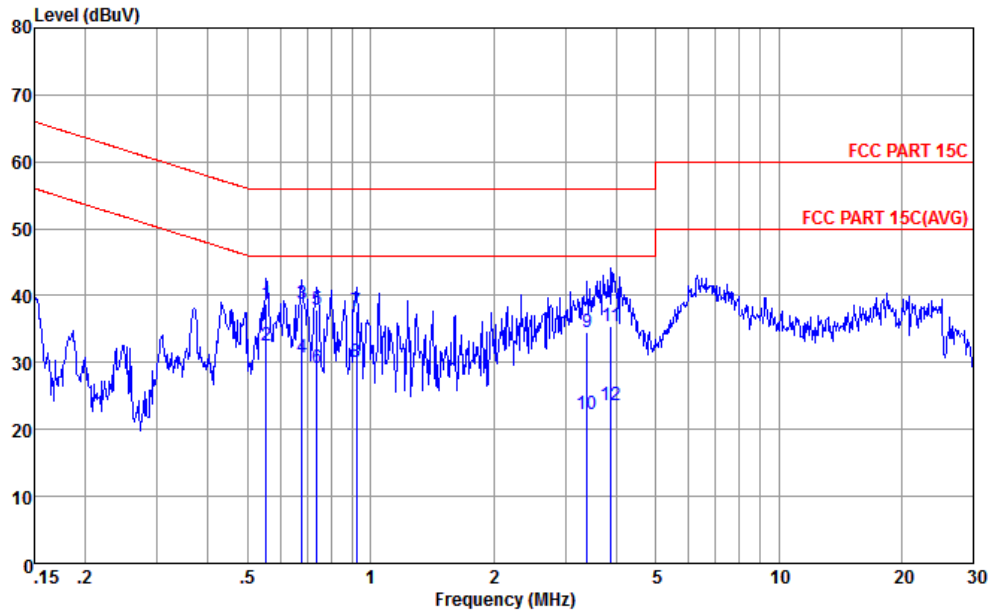

Site : CO01-KS
 Condition : FCC PART 15C LISN-L20140306 LINE

mode : Mode 1

	Freq	Level	Over Limit	Limit Line	Read Level	LISN Factor	Cable Loss	Remark
	MHz	dBuV	dB	dBuV	dBuV	dB	dB	
1	0.56	38.85	-17.15	56.00	28.40	0.20	10.25	QP
2	0.56	32.55	-13.45	46.00	22.10	0.20	10.25	Average
3	0.68	38.72	-17.28	56.00	28.30	0.20	10.22	QP
4	0.68	30.72	-15.28	46.00	20.30	0.20	10.22	Average
5	0.74	37.89	-18.11	56.00	27.49	0.19	10.21	QP
6	0.74	29.29	-16.71	46.00	18.89	0.19	10.21	Average
7	0.92	37.60	-18.40	56.00	27.29	0.12	10.19	QP
8	0.92	30.10	-15.90	46.00	19.79	0.12	10.19	Average
9	3.40	34.50	-21.50	56.00	24.10	0.17	10.23	QP
10	3.40	22.30	-23.70	46.00	11.90	0.17	10.23	Average
11	3.88	35.32	-20.68	56.00	24.90	0.18	10.24	QP
12	3.88	23.62	-22.48	46.00	13.10	0.18	10.24	Average



Test Mode :	Mode 1	Temperature :	22~24°C
Test Engineer :	Eligah Wang	Relative Humidity :	55~58%
Test Voltage :	120Vac / 60Hz	Phase :	Neutral
Function Type :	GSM850 Idle + Bluetooth Link + WLAN Link + USB Cable (Charging from Adapter) + Earphone		

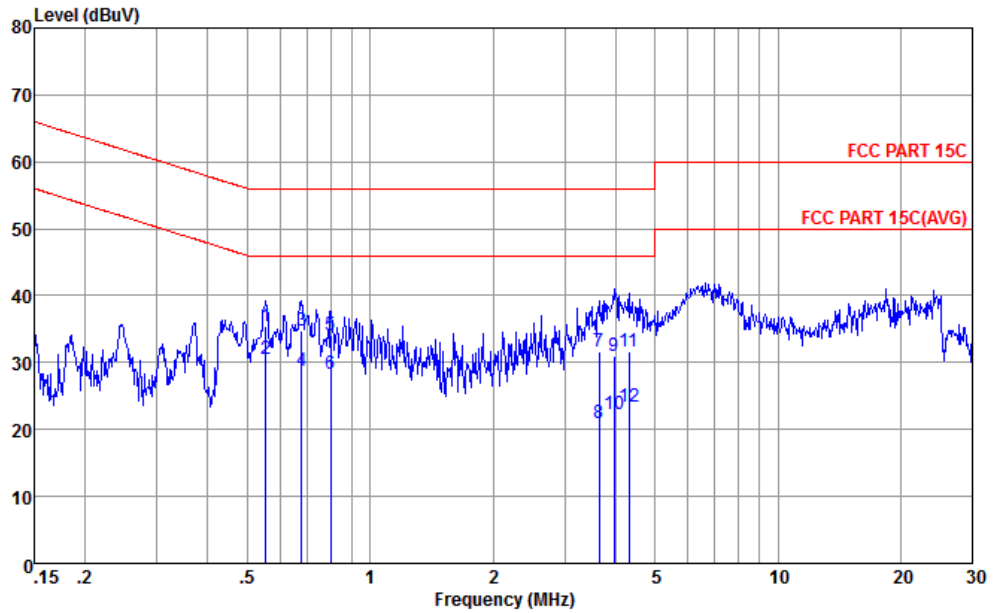

Site : CO01-KS
Condition : FCC PART 15C LISN-N20140306 NEUTRAL

mode : Mode 1

	Freq	Level	Over	Limit	Read	LISN	Cable	Remark
	MHz	dBuV	Limit	Line	Level	Factor	Loss	
			dB	dBuV	dBuV	dB	dB	
1	0.56	35.43	-20.57	56.00	24.91	0.27	10.25	QP
2	0.56	30.43	-15.57	46.00	19.91	0.27	10.25	Average
3	0.68	34.72	-21.28	56.00	24.29	0.21	10.22	QP
4	0.68	28.72	-17.28	46.00	18.29	0.21	10.22	Average
5	0.80	34.16	-21.84	56.00	23.79	0.17	10.20	QP
6	0.80	28.26	-17.74	46.00	17.89	0.17	10.20	Average
7	3.64	31.71	-24.29	56.00	21.30	0.17	10.24	QP
8	3.64	20.91	-25.09	46.00	10.50	0.17	10.24	Average
9	3.96	31.02	-24.98	56.00	20.60	0.18	10.24	QP
10	3.96	22.32	-23.68	46.00	11.90	0.18	10.24	Average
11	4.31	31.54	-24.46	56.00	21.10	0.19	10.25	QP
12	4.31	23.34	-22.66	46.00	12.90	0.19	10.25	Average



3.7 Antenna Requirements

3.7.1 Standard Applicable

If directional gain of transmitting antennas is greater than 6dBi, the power shall be reduced by the same level in dB comparing to gain minus 6dBi. For the fixed point-to-point operation, the power shall be reduced by one dB for every 3 dB that the directional gain of the antenna exceeds 6 dBi. The use of a permanently attached antenna or of an antenna that uses a unique coupling to the intentional radiator shall be considered sufficient to comply with the FCC rule.

3.7.2 Antenna Anti-Replacement Construction

An embedded-in antenna design is used.

3.7.3 Antenna Gain

The antenna peak gain of EUT is less than 6 dBi. Therefore, it is not necessary to reduce maximum peak output power limit.



4 List of Measuring Equipment

Instrument	Manufacturer	Model No.	Serial No.	Characteristics	Calibration Date	Test Date	Due Date	Remark
Spectrum Analyzer	R&S	FSV30	101338	9kHz~30GHz	May. 04, 2014	Sep. 30, 2014	May. 03, 2015	Conducted (TH01-KS)
Pulse Power Sensor	Anritsu	MA2411B	0917070	30MHz~40GHz	Feb. 27, 2014	Sep. 30, 2014	Feb. 26, 2015	Conducted (TH01-KS)
Power Meter	Anritsu	ML2495A	1005002	50MHz Bandwidth	Feb. 27, 2014	Sep. 30, 2014	Feb. 26, 2015	Conducted (TH01-KS)
EMI Test Receiver	R&S	ESCI	100534	9kHz~3GHz	Nov. 05, 2013	Oct. 02, 2014	Nov. 04, 2014	Radiation (03CH01-KS)
Spectrum Analyzer	R&S	FSP30	101399	9kHz~30GHz	May 04, 2014	Oct. 02, 2014	May 03, 2015	Radiation (03CH01-KS)
Loop Antenna	R&S	HFH2-Z2	100321	9kHz~30MHz	Oct. 08, 2014	Oct. 02, 2014	Oct. 07, 2015	Radiation (03CH01-KS)
Bilog Antenna	SCHAFFNER	CBL6112D	23182	25MHz~2GHz	Jan. 08, 2014	Oct. 02, 2014	Jan. 07, 2015	Radiation (03CH01-KS)
Double Ridge Horn Antenna	ETS-Lindgren	3117	75959	1GHz~18GHz	Jan. 08, 2014	Oct. 02, 2014	Jan. 07, 2015	Radiation (03CH01-KS)
Active Horn Antenna	com-power	AHA-118	701030	1GHz~18GHz	Nov. 18, 2013	Oct. 02, 2014	Nov. 17, 2014	Radiation (03CH01-KS)
SHF-EHF Horn	Schwarzbeck	BBHA 9170	BBHA170249	15GHz~40GHz	Mar. 10, 2014	Oct. 02, 2014	Mar. 09, 2015	Radiation (03CH01-KS)
Amplifier	com-power	PA-103A	161073	1MHz~1GHz	May 04, 2014	Oct. 02, 2014	May 03, 2015	Radiation (03CH01-KS)
Amplifier	Agilent	8449B	3008A02371	1GHz~26.5GHz	Dec. 10, 2013	Oct. 02, 2014	Dec. 09, 2014	Radiation (03CH01-KS)
AC Power Source	Chroma	61601	F104090004	N/A	NCR	Oct. 02, 2014	NCR	Radiation (03CH01-KS)
Turn Table	MF	MF7802	N/A	0~360 degree	NCR	Oct. 02, 2014	NCR	Radiation (03CH01-KS)
Antenna Mast	MF	MF7802	N/A	1 m~4 m	NCR	Oct. 02, 2014	NCR	Radiation (03CH01-KS)
EMI Receiver	R&S	ESCI7	100768	9kHz~7GHz;	May 04, 2014	Oct. 09, 2014	May 03, 2015	Conduction (CO01-KS)
AC LISN	MessTec	AN3016	060103	9kHz~30MHz	Dec. 10, 2013	Oct. 09, 2014	Dec. 09, 2014	Conduction (CO01-KS)
AC LISN (for auxiliary equipment)	MessTec	AN3016	060105	9kHz~30MHz	Dec. 10, 2013	Oct. 09, 2014	Dec. 09, 2014	Conduction (CO01-KS)
AC Power Source	Chroma	61602	ABP00000811	AC 0V~300V, 45Hz~1000Hz	Nov. 12, 2013	Oct. 09, 2014	Nov. 11, 2014	Conduction (CO01-KS)



5 Uncertainty of Evaluation

Uncertainty of Conducted Emission Measurement (150kHz ~ 30MHz)

Measuring Uncertainty for a Level of Confidence of 95% ($U = 2Uc(y)$)	2.3
---	-----

Uncertainty of Radiated Emission Measurement (30 MHz ~ 1000 MHz)

Measuring Uncertainty for a Level of Confidence of 95% ($U = 2Uc(y)$)	2.5
---	-----