



# FCC SAR Test Report

APPLICANT : Lenovo Mobile Communication Technology Ltd.  
EQUIPMENT : Mobile Phone GSM/WCDMA  
BRAND NAME : lenovo  
MODEL NAME : Lenovo S820  
MARKETING NAME : Mobile Phone GSM/WCDMA  
MID : 82000011  
FCC ID : YCNS820  
STANDARD : FCC 47 CFR Part 2 (2.1093)  
ANSI/IEEE C95.1-1992  
IEEE 1528-2003  
FCC OET Bulletin 65 Supplement C (Edition 01-01)

The product was completely tested on Jun. 07, 2013. We, SPORTON INTERNATIONAL (SHENZHEN) INC., would like to declare that the tested sample has been evaluated in accordance with the procedures and shown the compliance with the applicable technical standards.

The test results in this report apply exclusively to the tested model / sample. Without written approval of SPORTON INTERNATIONAL (SHENZHEN) INC., the test report shall not be reproduced except in full.

Reviewed by: Eric Huang / Deputy Manager

Approved by: Jones Tsai / Manager



## **SPORTON INTERNATIONAL (SHENZHEN) INC.**

**No. 101, Complex Building C, Guanlong Village, Xili Town, Nanshan District, Shenzhen, Guangdong, P.R.C.**

SPORTON INTERNATIONAL (SHENZHEN) INC.

TEL : 86-755-8637-9589

FAX : 86-755-8637-9595

FCC ID : YCNS820

Page Number : 1 of 57

Report Issued Date : Jun. 14, 2013

Report Version : Rev. 01



Table of Contents

1. Statement of Compliance .....4
2. Administration Data .....6
2.1 Testing Laboratory .....6
2.2 Applicant .....6
2.3 Manufacturer .....6
2.4 Application Details .....6
3. General Information .....7
3.1 Description of Equipment Under Test (EUT) .....7
3.2 Maximum RF output power among production units .....8
3.3 Applied Standard .....10
3.4 Device Category and SAR Limits .....10
3.5 Test Conditions .....10
4. Specific Absorption Rate (SAR) .....11
4.1 Introduction .....11
4.2 SAR Definition .....11
5. SAR Measurement System .....12
5.1 E-Field Probe .....13
5.2 Data Acquisition Electronics (DAE) .....13
5.3 Robot .....14
5.4 Measurement Server .....14
5.5 Phantom .....15
5.6 Device Holder .....15
5.7 Data Storage and Evaluation .....16
5.8 Test Equipment List .....18
6. Tissue Simulating Liquids .....19
7. System Verification Procedures .....20
7.1 Purpose of System Performance check .....20
7.2 System Setup .....20
7.3 SAR System Verification Results .....21
8. EUT Testing Position .....22
8.1 Define two imaginary lines on the handset .....22
8.2 Cheek Position .....23
8.3 Tilted Position .....23
8.4 Body Worn Position .....24
9. Measurement Procedures .....25
9.1 Spatial Peak SAR Evaluation .....25
9.2 Power Reference Measurement .....26
9.3 Area & Zoom Scan Procedures .....26
9.4 Volume Scan Procedures .....27
9.5 SAR Averaged Methods .....27
9.6 Power Drift Monitoring .....27
10. Conducted RF Output Power (Unit: dBm) .....28
11. DUT Antenna Location .....38
12. SAR Test Results .....40
12.1 Test Records for Head SAR Test .....40
12.2 Test Records for Hotspot SAR Test .....41
12.3 Test Records for Body Worn SAR Test .....43
12.4 Repeated SAR Measurement .....44
12.5 Highest SAR Plot .....45
13. Simultaneous Transmission Analysis .....50
13.1 Head Exposure Conditions .....51
13.2 Hotspot Exposure Conditions .....52
13.3 Body-Worn Exposure Conditions .....54
14. Uncertainty Assessment .....55
15. References .....57
Appendix A. Plots of System Performance Check
Appendix B. Plots of SAR Measurement
Appendix C. DASYS Calibration Certificate
Appendix D. Test Setup Photos





### 1. Statement of Compliance

The maximum results of Specific Absorption Rate (SAR) found during testing for **Lenovo Mobile Communication Technology Ltd., DUT: Mobile Phone GSM/WCDMA, Brand Name: lenovo, Model Name: Lenovo S820, Marketing Name: Mobile Phone GSM/WCDMA** are as follows.

<Highest Reported standalone SAR Summary>

Exposure Position	Frequency Band	Highest Reported 1g-SAR (W/kg)	Equipment Class	Highest Reported 1g-SAR (W/kg)
Head	GSM850	0.36	PCE	0.69
	GSM1900	0.37		
	WCDMA Band V	0.37		
	WCDMA Band II	0.69		
	WLAN 2.4GHz Band	0.40	DTS	0.40
Hotspot (1cm Gap)	GSM850	1.26	PCE	1.26
	GSM1900	1.00		
	WCDMA Band V	0.73		
	WCDMA Band II	0.91		
	WLAN 2.4GHz Band	0.13	DTS	0.13
Body-worn (1cm Gap)	GSM850	0.66	PCE	0.91
	GSM1900	0.48		
	WCDMA Band V	0.73		
	WCDMA Band II	0.91		
	WLAN 2.4GHz Band	0.13	DTS	0.13



<Highest Simultaneous transmission SAR>

Frequency Band	Equipment Class	Exposure Position	Highest Reported Simultaneous Transmission 1g-SAR (W/kg)
GSM850	PCE	Hotspot	1.38
WLAN 2.4GHz Band	DTS		

Frequency Band	Equipment Class	Exposure Position	Highest Reported Simultaneous Transmission 1g-SAR (W/kg)
GSM850	PCE	Hotspot	1.39
Bluetooth	DSS		

This device is in compliance with Specific Absorption Rate (SAR) for general population/uncontrolled exposure limits (1.6 W/kg) specified in FCC 47 CFR part 2 (2.1093) and ANSI/IEEE C95.1-1992, and had been tested in accordance with the measurement methods and procedures specified in IEEE 1528-2003 and FCC OET Bulletin 65 Supplement C (Edition 01-01).



## 2. Administration Data

### 2.1 Testing Laboratory

Test Site	SPORTON INTERNATIONAL (SHENZHEN) INC.
Test Site Location	No. 101, Complex Building C, Guanlong Village, Xili Town, Nanshan District, Shenzhen, Guangdong, P.R.C. TEL: +86-755-8637-9589 FAX: +86-755-8637-9595

### 2.2 Applicant

Company Name	Lenovo Mobile Communication Technology Ltd.
Address	No.999, Qishan North 2nd Road, Information & Optoelectronics Park, Torch Hi-tech Industry Development Zone, Xiamen, P.R.China

### 2.3 Manufacturer

Company Name	Lenovo PC HK Limited
Address	23/F, Lincoln House, Taikoo Place 979 King's Road, Quarry Bay, Hong Kong

### 2.4 Application Details

Date of Start during the Test	Jun. 05, 2013
Date of End during the Test	Jun. 07, 2013



### 3. General Information

#### 3.1 Description of Equipment Under Test (EUT)

Product Feature & Specification	
EUT	Mobile Phone GSM/WCDMA
Brand Name	lenovo
Model Name	Lenovo S820
Marketing Name	Mobile Phone GSM/WCDMA
MID	82000011
FCC ID	YCNS820
IMEI Code	#1: 860365020120826 #2: 860365020120834
Wireless Technology and Frequency Range	GSM850: 824.2 MHz ~ 848.8 MHz GSM1900: 1850.2 MHz ~ 1909.8 MHz WCDMA Band V: 826.4 MHz ~ 846.6 MHz WCDMA Band II: 1852.4 MHz ~ 1907.6 MHz WLAN 2.4GHz Band: 2412 MHz ~ 2462 MHz Bluetooth: 2402 MHz ~ 2480 MHz
Type of Modulations	GSM: GMSK GPRS: GMSK EDGE: GMSK / 8PSK WCDMA (Rel 99): QPSK HSDPA (Rel 8): QPSK / DC-HSDPA (Rel 8 Cat24): QPSK HSUPA (Rel 7): QPSK DC-HSDPA (Rel 8 Cat24): 64QAM(Downlink only) HSPA+ (Rel 7, Cat 7): 16QAM 802.11b: DSSS (DBPSK / DQPSK / CCK) 802.11g/n: OFDM (BPSK / QPSK / 16QAM / 64QAM) Bluetooth BDR (1Mbps) : GFSK Bluetooth EDR (2Mbps) : $\pi/4$ -DQPSK Bluetooth EDR (3Mbps) : 8-DPSK Bluetooth 4.0 LE: GFSK
Antenna Type	WWAN: PIFA Antenna WLAN: PIFA Antenna Bluetooth: PIFA Antenna
HW Version	Swarovski_MB_H301
SW Version	Lenovo S820_ROW_S104_130514
Transfer Mode Category	Class B – EUT cannot support Packet Switched and Circuit Switched Network simultaneously but can automatically switch between Packet and Circuit Switched Network.
EUT Stage	Production Unit
<b>Remark:</b> The above EUT's information was declared by manufacturer. Please refer to the specifications or user's manual for more detailed description.	



**3.2 Maximum RF output power among production units**

Band	GSM850 (Burst Average Power) (dBm)	GSM1900 (Burst Average Power) (dBm)
GSM (GMSK, 1 Tx slot)	33	30
GPRS/EDGE (GMSK, 1 Tx slot)	33	30
GPRS/EDGE (GMSK, 2 Tx slots)	31.5	29
GPRS/EDGE (GMSK, 3 Tx slots)	30	27
GPRS/EDGE (GMSK, 4 Tx slots)	29.5	27
EDGE (8PSK, 1 Tx slot)	27	26
EDGE (8PSK, 2 Tx slots)	26	24.5
EDGE (8PSK, 3 Tx slots)	23.5	22
EDGE (8PSK, 4 Tx slots)	22.5	21

Mode	WCDMA Band V		WCDMA Band II
	Average power(dBm)		
AMR 12.2Kbps	24		23.5
RMC 12.2Kbps	24		23.5
HSDPA Subtest-1	21.5		22
HSDPA Subtest-2	21.5		22
HSDPA Subtest-3	21		22
HSDPA Subtest-4	21		22
DC-HSDPA Subtest-1	21.5		22
DC-HSDPA Subtest-2	21.5		22
DC-HSDPA Subtest-3	21		21
DC-HSDPA Subtest-4	21		21
HSUPA Subtest-1	20.5		20.5
HSUPA Subtest-2	19		19
HSUPA Subtest-3	20		20
HSUPA Subtest-4	19		19
HSUPA Subtest-5	20.5		20.5
HSPA+ (16QAM) Subtest-1	19		19





Average power (dBm)					
Mode / Band	IEEE 802.11				
	a	b	g	n-HT20	n-HT40
WLAN 2.4GHz		15	11	11	11

Bluetooth average power(dBm)			
Mode/Band	1Mbps (GMSK)	2Mbps ( $\pi/4$ -DQPSK)	3Mbps (8-DPSK)
Bluetooth	8	6	6

Maximum Target Average Power for Production Unit (dBm)	
Mode / Band	BT4.0-LE (GFSK)
Bluetooth	1



### 3.3 Applied Standard

The Specific Absorption Rate (SAR) testing specification, method, and procedure for this device is in accordance with the following standards:

- FCC 47 CFR Part 2 (2.1093)
- ANSI/IEEE C95.1-1992
- IEEE 1528-2003
- FCC OET Bulletin 65 Supplement C (Edition 01-01)
- FCC KDB 447498 D01 v05r01
- FCC KDB 648474 D04 v01r01
- FCC KDB 248227 D01 v01r02
- FCC KDB 941225 D01 v02
- FCC KDB 941225 D03 v01
- FCC KDB 941225 D06 v01r01
- FCC KDB 865664 D01 v01

### 3.4 Device Category and SAR Limits

This device belongs to portable device category because its radiating structure is allowed to be used within 20 centimeters of the body of the user. Limit for General Population/Uncontrolled exposure should be applied for this device, it is 1.6 W/kg as averaged over any 1 gram of tissue.

### 3.5 Test Conditions

#### 3.5.1 Ambient Condition

Ambient Temperature	20 to 24 °C
Humidity	< 60 %

#### 3.5.2 Test Configuration

For WWAN SAR testing, the device was controlled by using a base station emulator. Communication between the device and the emulator was established by air link. The distance between the EUT and the antenna of the emulator is larger than 50 cm and the output power radiated from the emulator antenna is at least 30 dB smaller than the output power of EUT.

During WLAN SAR testing EUT is configured with the WLAN continuous TX tool, and the transmission duty factor was monitored on the spectrum analyzer with zero-span setting

For WLAN SAR testing, WLAN engineering testing software installed on the EUT can provide continuous transmitting RF signal.

## **4. Specific Absorption Rate (SAR)**

### **4.1 Introduction**

SAR is related to the rate at which energy is absorbed per unit mass in an object exposed to a radio field. The SAR distribution in a biological body is complicated and is usually carried out by experimental techniques or numerical modeling. The standard recommends limits for two tiers of groups, occupational/controlled and general population/uncontrolled, based on a person's awareness and ability to exercise control over his or her exposure. In general, occupational/controlled exposure limits are higher than the limits for general population/uncontrolled.

### **4.2 SAR Definition**

The SAR definition is the time derivative (rate) of the incremental energy (dW) absorbed by (dissipated in) an incremental mass (dm) contained in a volume element (dv) of a given density ( $\rho$ ). The equation description is as below:

$$\text{SAR} = \frac{d}{dt} \left( \frac{dW}{dm} \right) = \frac{d}{dt} \left( \frac{dW}{\rho dv} \right)$$

SAR is expressed in units of Watts per kilogram (W/kg)

SAR measurement can be either related to the temperature elevation in tissue by

$$\text{SAR} = c \left( \frac{\delta T}{\delta t} \right)$$

Where: C is the specific heat capacity,  $\delta T$  is the temperature rise and  $\delta t$  is the exposure duration, or related to the electrical field in the tissue by

$$\text{SAR} = \frac{\sigma |E|^2}{\rho}$$

Where:  $\sigma$  is the conductivity of the tissue,  $\rho$  is the mass density of the tissue and E is the RMS electrical field strength.

However for evaluating SAR of low power transmitter, electrical field measurement is typically applied.

## 5. SAR Measurement System

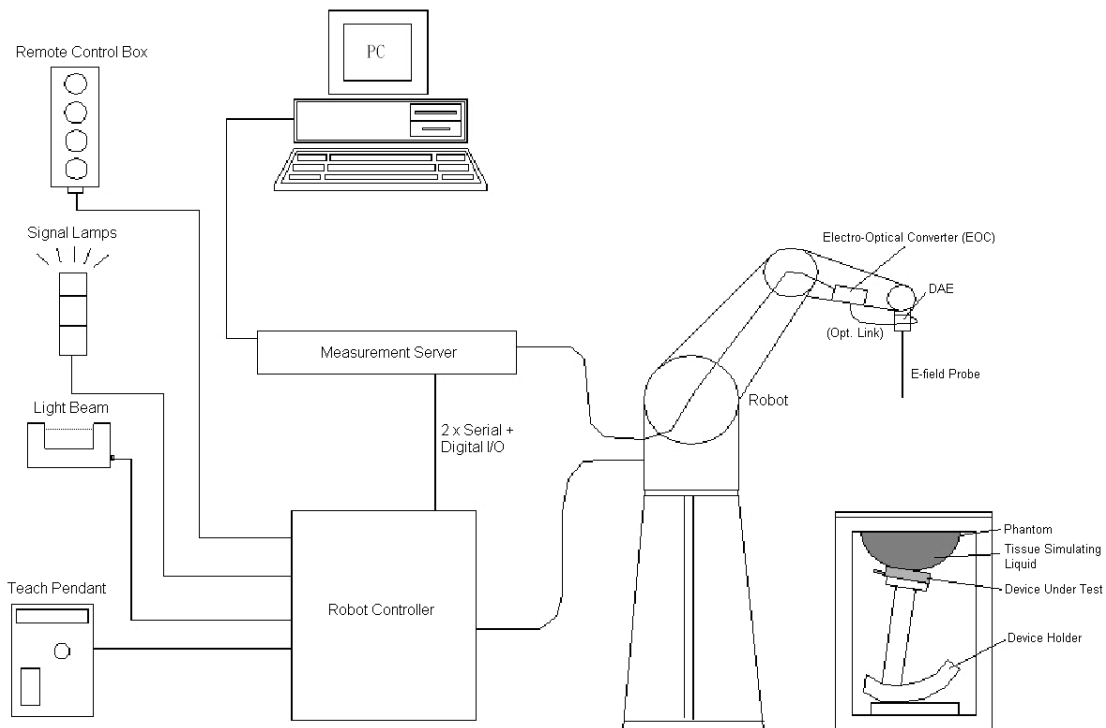

**Fig 5.1 SPEAG DASY System Configurations**

The DASY system for performance compliance tests is illustrated above graphically. This system consists of the following items:

- A standard high precision 6-axis robot with controller, a teach pendant and software
- A data acquisition electronic (DAE) attached to the robot arm extension
- A dosimetric probe equipped with an optical surface detector system
- The electro-optical converter (EOC) performs the conversion between optical and electrical signals
- A measurement server performs the time critical tasks such as signal filtering, control of the robot operation and fast movement interrupts.
- A probe alignment unit which improves the accuracy of the probe positioning
- A computer operating Windows XP
- DASY software
- Remote control with teach pendant and additional circuitry for robot safety such as warning lamps, etc.
- The SAM twin phantom
- A device holder
- Tissue simulating liquid
- Dipole for evaluating the proper functioning of the system

Component details are described in in the following sub-sections.

**5.1 E-Field Probe**

The SAR measurement is conducted with the dosimetric probe (manufactured by SPEAG). The probe is specially designed and calibrated for use in liquid with high permittivity. The dosimetric probe has special calibration in liquid at different frequency. This probe has a built in optical surface detection system to prevent from collision with phantom.

**5.1.1 E-Field Probe Specification**

**<EX3DV4 Probe>**

<b>Construction</b>	Symmetrical design with triangular core Built-in shielding against static charges PEEK enclosure material (resistant to organic solvents, e.g., DGBE)
<b>Frequency</b>	10 MHz to 6 GHz; Linearity: $\pm 0.2$ dB
<b>Directivity</b>	$\pm 0.3$ dB in HSL (rotation around probe axis) $\pm 0.5$ dB in tissue material (rotation normal to probe axis)
<b>Dynamic Range</b>	10 $\mu$ W/g to 100 mW/g; Linearity: $\pm 0.2$ dB (noise: typically $< 1 \mu$ W/g)
<b>Dimensions</b>	Overall length: 330 mm (Tip: 20 mm) Tip diameter: 2.5 mm (Body: 12 mm) Typical distance from probe tip to dipole centers: 1 mm

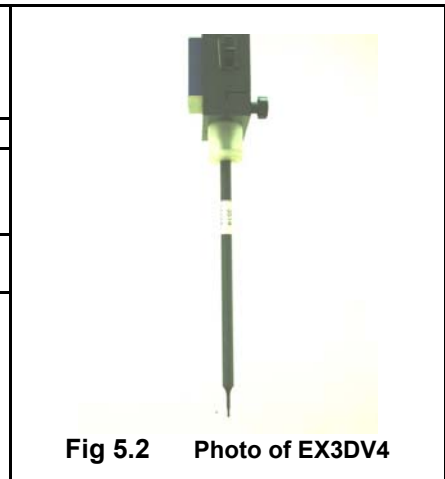

**Fig 5.2 Photo of EX3DV4**

**5.1.2 E-Field Probe Calibration**

Each probe needs to be calibrated according to a dosimetric assessment procedure with accuracy better than  $\pm 10\%$ . The spherical isotropy shall be evaluated and within  $\pm 0.25$ dB. The sensitivity parameters (NormX, NormY, and NormZ), the diode compression parameter (DCP) and the conversion factor (ConvF) of the probe are tested. The calibration data can be referred to appendix C of this report.

**5.2 Data Acquisition Electronics (DAE)**

The data acquisition electronics (DAE) consists of a highly sensitive electrometer-grade preamplifier with auto-zeroing, a channel and gain-switching multiplexer, a fast 16 bit AD-converter and a command decoder and control logic unit. Transmission to the measurement server is accomplished through an optical downlink for data and status information as well as an optical uplink for commands and the clock. The input impedance of the DAE is 200 MOhm; the inputs are symmetrical and floating. Common mode rejection is above 80 dB.



**Fig 5.3 Photo of DAE**

### 5.3 Robot

The SPEAG DASY system uses the high precision robots (DASY5: TX90XL) type from Stäubli SA (France). For the 6-axis controller system, the robot controller version (DASY5: CS8c) from Stäubli is used. The Stäubli robot series have many features that are important for our application:

- High precision (repeatability  $\pm 0.035$  mm)
- High reliability (industrial design)
- Jerk-free straight movements
- Low ELF interference (the closed metallic construction shields against motor control fields)



Fig 5.4 Photo of DASY5

### 5.4 Measurement Server

The measurement server is based on a PC/104 CPU board with CPU (DASY5: 400 MHz, Intel Celeron), chipdisk (DASY5: 128 MB), RAM (DASY5: 128 MB). The necessary circuits for communication with the DAE electronic box, as well as the 16 bit AD converter system for optical detection and digital I/O interface are contained on the DASY I/O board, which is directly connected to the PC/104 bus of the CPU board.

The measurement server performs all the real-time data evaluation for field measurements and surface detection, controls robot movements and handles safety operations.

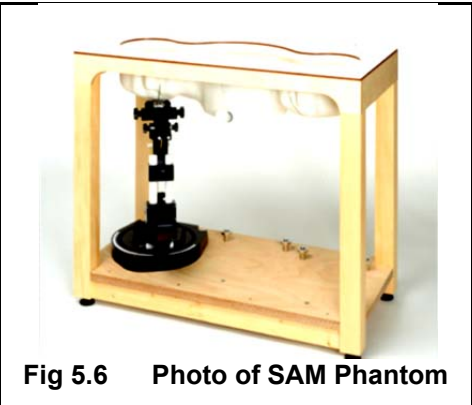

Fig 5.5 Photo of Server for DASY5

**5.5 Phantom**

**<SAM Twin Phantom>**

<b>Shell Thickness</b>	2 ± 0.2 mm; Center ear point: 6 ± 0.2 mm
<b>Filling Volume</b>	Approx. 25 liters
<b>Dimensions</b>	Length: 1000 mm; Width: 500 mm; Height: adjustable feet
<b>Measurement Areas</b>	Left Hand, Right Hand, Flat Phantom



The bottom plate contains three pair of bolts for locking the device holder. The device holder positions are adjusted to the standard measurement positions in the three sections. A white cover is provided to tap the phantom during off-periods to prevent water evaporation and changes in the liquid parameters. On the phantom top, three reference markers are provided to identify the phantom position with respect to the robot.

**5.6 Device Holder**

**<Device Holder for SAM Twin Phantom>**

The SAR in the phantom is approximately inversely proportional to the square of the distance between the source and the liquid surface. For a source at 5 mm distance, a positioning uncertainty of ± 0.5 mm would produce a SAR uncertainty of ± 20 %. Accurate device positioning is therefore crucial for accurate and repeatable measurements. The positions in which the devices must be measured are defined by the standards.

The DASY device holder is designed to cope with different positions given in the standard. It has two scales for the device rotation (with respect to the body axis) and the device inclination (with respect to the line between the ear reference points). The rotation center for both scales is the ear reference point (ERP). Thus the device needs no repositioning when changing the angles.

The DASY device holder is constructed of low-loss POM material having the following dielectric parameters: relative permittivity  $\epsilon = 3$  and loss tangent  $\delta = 0.02$ . The amount of dielectric material has been reduced in the closest vicinity of the device, since measurements have suggested that the influence of the clamp on the test results could thus be lowered.



Fig 5.7 Device Holder

## 5.7 Data Storage and Evaluation

### 5.7.1 Data Storage

The DASY software stores the assessed data from the data acquisition electronics as raw data (in microvolt readings from the probe sensors), together with all the necessary software parameters for the data evaluation (probe calibration data, liquid parameters and device frequency and modulation data) in measurement files. The post-processing software evaluates the desired unit and format for output each time the data is visualized or exported. This allows verification of the complete software setup even after the measurement and allows correction of erroneous parameter settings. For example, if a measurement has been performed with an incorrect crest factor parameter in the device setup, the parameter can be corrected afterwards and the data can be reevaluated.

The measured data can be visualized or exported in different units or formats, depending on the selected probe type (e.g., [V/m], [A/m], [mW/g]). Some of these units are not available in certain situations or give meaningless results, e.g., a SAR-output in a non-lose media, will always be zero. Raw data can also be exported to perform the evaluation with other software packages.

### 5.7.2 Data Evaluation

The DASY post-processing software (SEMCAD) automatically executes the following procedures to calculate the field units from the microvolt readings at the probe connector. The parameters used in the evaluation are stored in the configuration modules of the software :

<b>Probe parameters :</b>	- Sensitivity	Norm <sub>i</sub> , a <sub>i0</sub> , a <sub>i1</sub> , a <sub>i2</sub>
	- Conversion factor	ConvF <sub>i</sub>
	- Diode compression point	dcp <sub>i</sub>
<b>Device parameters :</b>	- Frequency	f
	- Crest factor	cf
	<b>Media parameters :</b>	- Conductivity
	- Density	$\rho$

These parameters must be set correctly in the software. They can be found in the component documents or they can be imported into the software from the configuration files issued for the DASY components. In the direct measuring mode of the multi-meter option, the parameters of the actual system setup are used. In the scan visualization and export modes, the parameters stored in the corresponding document files are used.

The first step of the evaluation is a linearization of the filtered input signal to account for the compression characteristics of the detector diode. The compensation depends on the input signal, the diode type and the DC-transmission factor from the diode to the evaluation electronics. If the exciting field is pulsed, the crest factor of the signal must be known to correctly compensate for peak power.



The formula for each channel can be given as :

$$V_i = U_i + U_i^2 \cdot \frac{cf}{dcp_i}$$

with  $V_i$  = compensated signal of channel  $i$ , ( $i = x, y, z$ )  
 $U_i$  = input signal of channel  $i$ , ( $i = x, y, z$ )  
 $cf$  = crest factor of exciting field (DASY parameter)  
 $dcp_i$  = diode compression point (DASY parameter)

From the compensated input signals, the primary field data for each channel can be evaluated :

$$\text{E-field Probes : } E_i = \sqrt{\frac{V_i}{\text{Norm}_i \cdot \text{ConvF}}}$$

$$\text{H-field Probes : } H_i = \sqrt{V_i \cdot \frac{a_{i0} + a_{i1}f + a_{i2}f^2}{f}}$$

with  $V_i$  = compensated signal of channel  $i$ , ( $i = x, y, z$ )  
 $\text{Norm}_i$  = sensor sensitivity of channel  $i$ , ( $i = x, y, z$ ),  $\mu\text{V}/(\text{V/m})^2$  for E-field Probes  
 $\text{ConvF}$  = sensitivity enhancement in solution  
 $a_{ij}$  = sensor sensitivity factors for H-field probes  
 $f$  = carrier frequency [GHz]  
 $E_i$  = electric field strength of channel  $i$  in V/m  
 $H_i$  = magnetic field strength of channel  $i$  in A/m

The RSS value of the field components gives the total field strength (Hermitian magnitude) :

$$E_{\text{tot}} = \sqrt{E_x^2 + E_y^2 + E_z^2}$$

The primary field data are used to calculate the derived field units.

$$\text{SAR} = E_{\text{tot}}^2 \cdot \frac{\sigma}{\rho \cdot 1000}$$

with SAR = local specific absorption rate in mW/g  
 $E_{\text{tot}}$  = total field strength in V/m  
 $\sigma$  = conductivity in [mho/m] or [Siemens/m]  
 $\rho$  = equivalent tissue density in  $\text{g}/\text{cm}^3$

Note that the density is set to 1, to account for actual head tissue density rather than the density of the tissue simulating liquid.



**5.8 Test Equipment List**

Manufacturer	Name of Equipment	Type/Model	Serial Number	Calibration	
				Last Cal.	Due Date
SPEAG	835MHz System Validation Kit	D835V2	4d091	Nov. 18, 2011	Nov. 16, 2013
SPEAG	1900MHz System Validation Kit	D1900V2	5d118	Nov. 21, 2011	Nov. 16, 2013
SPEAG	2450MHz System Validation Kit	D2450V2	736	Jul. 25, 2011	Jul. 24, 2013
SPEAG	Data Acquisition Electronics	DAE4	1303	Nov. 22, 2012	Nov. 21, 2013
SPEAG	Dosimetric E-Field Probe	EX3DV4	3819	Nov. 26, 2012	Nov. 25, 2013
SPEAG	SAM Twin Phantom	QD 000 P40 CD	TP-1670	NCR	NCR
SPEAG	SAM Twin Phantom	QD 000 P40 CD	TP-1671	NCR	NCR
SPEAG	Test Arch Phantom	Par phantom	1105	NCR	NCR
SPEAG	Phone Positioner	N/A	N/A	NCR	NCR
Agilent	Base Station	E5515C	MY50267224	Dec. 29, 2012	Dec. 28, 2013
Agilent	ENA Series Network Analyzer	E5071C	MY46106933	Aug. 31, 2012	Aug. 30, 2013
Anritsu	Power Meter	ML2495A	1218010	Mar.28.2013	Mar. 27, 2014
Anritsu	Power Sensor	MA2411B	1207253	Mar.28.2013	Mar. 27, 2014
Agilent	Dual Directional Coupler	778D	50422	Note 4	
Woken	Attenuator 1	WK0602-XX	N/A	Note 4	
PE	Attenuator 2	PE7005-10	N/A	Note 4	
PE	Attenuator 3	PE7005-3	N/A	Note 4	
Agilent	Dielectric Probe Kit	85070D	US01440205	Note 5	
AR	Power Amplifier	5S1G4M2	0328767	Note 6	
R&S	Spectrum Analyzer	FSP30	100818	Aug. 22, 2012	Aug. 21, 2013

**Table 5.1 Test Equipment List**

**Note:**

1. The calibration certificate of DASY can be referred to appendix C of this report.
2. Referring to KDB 865664 D01v01, the dipole calibration interval can be extended to 3 years with justification. The dipoles are also not physically damaged, or repaired during the interval.
3. The justification data of dipole D835V2, SN: 4d091, D1900V2, SN: 5d118, D2450V2, SN: 736, can be found in appendix C. The return loss is < -20dB, within 20% of prior calibration, the impedance is within 5 ohm of prior calibration.
4. The Insertion Loss calibration of Dual Directional Coupler and Attenuator were characterized via the network analyzer and compensated during system check.
5. The dielectric probe kit was calibrated via the network analyzer, with the specified procedure (calibrated in pure water) and calibration kit (standard) short circuit, before the dielectric measurement. The specific procedure and calibration kit are provided by Agilent.
6. In system check we need to monitor the level on the power meter, and adjust the power amplifier level to have precise power level to the dipole; the measured SAR will be normalized to 1W input power according to the ratio of 1W to the input power to the dipole. For system check, the calibration of the power amplifier is deemed not critically required for correct measurement; the power meter is critical and we do have calibration for it
7. Attenuator 1 insertion loss is calibrated by the network Analyzer, which the calibration is valid, before system check.

## 6. Tissue Simulating Liquids

For the measurement of the field distribution inside the SAM phantom with DASY, the phantom must be filled with around 25 liters of homogeneous body tissue simulating liquid. For head SAR testing, the liquid height from the ear reference point (ERP) of the phantom to the liquid top surface is larger than 15 cm, which is shown in Fig. 6.1. For body SAR testing, the liquid height from the center of the flat phantom to the liquid top surface is larger than 15 cm, which is shown in Fig. 6.2.



Fig 6.1 Photo of Liquid Height for Head SAR



Fig 6.2 Photo of Liquid Height for Body SAR

The following table gives the recipes for tissue simulating liquid.

Frequency (MHz)	Water (%)	Sugar (%)	Cellulose (%)	Salt (%)	Preventol (%)	DGBE (%)	Conductivity ( $\sigma$ )	Permittivity ( $\epsilon_r$ )
<b>For Head</b>								
835	40.3	57.9	0.2	1.4	0.2	0	0.90	41.5
1800, 1900, 2000	55.2	0	0	0.3	0	44.5	1.40	40.0
2450	55.0	0	0	0	0	45.0	1.80	39.2
<b>For Body</b>								
835	50.8	48.2	0	0.9	0.1	0	0.97	55.2
1800, 1900, 2000	70.2	0	0	0.4	0	29.4	1.52	53.3
2450	68.6	0	0	0	0	31.4	1.95	52.7

Table 6.1 Recipes of Tissue Simulating Liquid

The dielectric parameters of the liquids were verified prior to the SAR evaluation using an Agilent 85070D Dielectric Probe Kit and an Agilent Network Analyzer.

The following table shows the measuring results for simulating liquid.

Frequency (MHz)	Liquid Type	Liquid Temp. ( $^{\circ}\text{C}$ )	Conductivity ( $\sigma$ )	Permittivity ( $\epsilon_r$ )	Conductivity Target ( $\sigma$ )	Permittivity Target ( $\epsilon_r$ )	Delta ( $\sigma$ ) (%)	Delta ( $\epsilon_r$ ) (%)	Limit (%)	Date
835	Head	21.2	0.901	40.589	0.90	41.5	0.11	-2.20	$\pm 5$	Jun. 06, 2013
1900	Head	21.8	1.407	39.644	1.40	40.0	0.50	-0.89	$\pm 5$	Jun. 06, 2013
2450	Head	21.3	1.856	37.685	1.80	39.2	3.11	-3.86	$\pm 5$	Jun. 07, 2013
835	Body	21.5	0.97	56.499	0.97	55.2	0.00	2.35	$\pm 5$	Jun. 05, 2013
1900	Body	21.6	1.519	53.569	1.52	53.3	-0.07	0.50	$\pm 5$	Jun. 05, 2013
2450	Body	21.9	1.939	53.98	1.95	52.7	-0.56	2.43	$\pm 5$	Jun. 07, 2013

Table 6.2 Measuring Results for Simulating Liquid

## 7. System Verification Procedures

Each DASY system is equipped with one or more system validation kits. These units, together with the predefined measurement procedures within the DASY software, enable the user to conduct the system performance check and system validation. System validation kit includes a dipole, tripod holder to fix it underneath the flat phantom and a corresponding distance holder.

### 7.1 Purpose of System Performance check

The system performance check verifies that the system operates within its specifications. System and operator errors can be detected and corrected. It is recommended that the system performance check be performed prior to any usage of the system in order to guarantee reproducible results. The system performance check uses normal SAR measurements in a simplified setup with a well characterized source. This setup was selected to give a high sensitivity to all parameters that might fail or vary over time. The system check does not intend to replace the calibration of the components, but indicates situations where the system uncertainty is exceeded due to drift or failure.

### 7.2 System Setup

In the simplified setup for system evaluation, the EUT is replaced by a calibrated dipole and the power source is replaced by a continuous wave that comes from a signal generator. The calibrated dipole must be placed beneath the flat phantom section of the SAM twin phantom with the correct distance holder. The distance holder should touch the phantom surface with a light pressure at the reference marking and be oriented parallel to the long side of the phantom. The equipment setup is shown below:

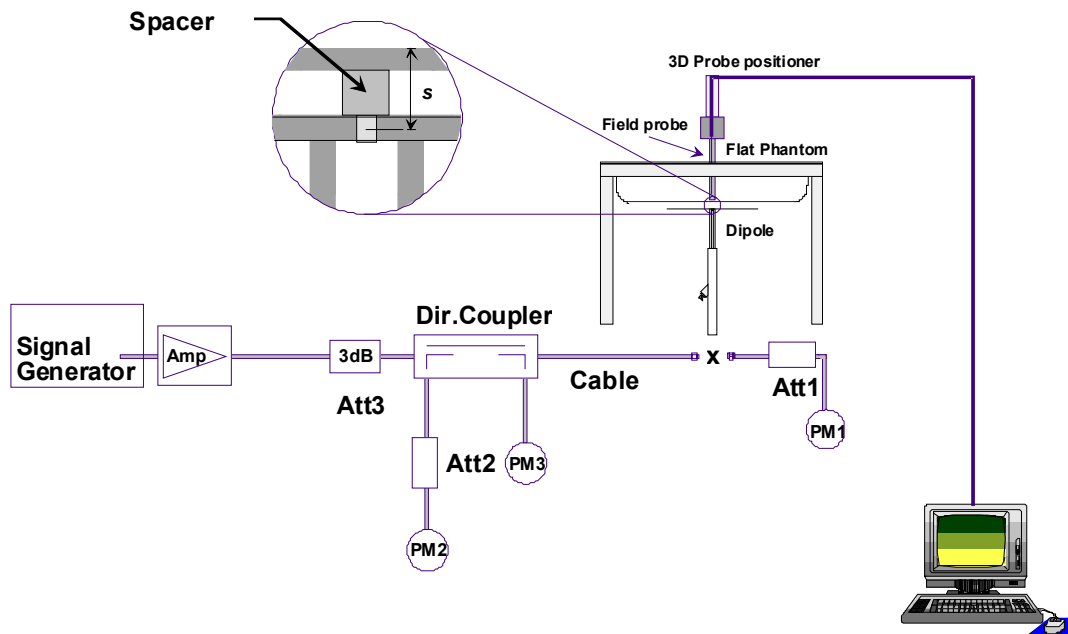

Fig 7.1 System Setup for System Evaluation

1. Signal Generator
2. Amplifier
3. Directional Coupler
4. Power Meter
5. Calibrated Dipole



**Fig 7.2 Photo of Dipole Setup**

**7.3 SAR System Verification Results**

Comparing to the original SAR value provided by SPEAG, the verification data should be within its specification of 10 %. Table 7.1 shows the target SAR and measured SAR after normalized to 1W input power. The table below indicates the system performance check can meet the variation criterion and the plots can be referred to Appendix A of this report.

Date	Frequency (MHz)	Liquid Type	Power fed onto reference dipole (mW)	Target SAR <sub>1g</sub> (W/kg)	Measured SAR <sub>1g</sub> (W/kg)	Normalized SAR <sub>1g</sub> (W/kg)	Deviation (%)
Jun. 06, 2013	835	Head	250	9.4	2.51	10.04	6.81
Jun. 06, 2013	1900	Head	250	40.3	10	40	-0.74
Jun. 07, 2013	2450	Head	250	54.8	14.2	56.8	3.65
Jun. 05, 2013	835	Body	250	9.42	2.45	9.8	4.03
Jun. 05, 2013	1900	Body	250	41.8	10.1	40.4	-3.35
Jun. 07, 2013	2450	Body	250	52.3	13.3	53.2	1.72

**Table 7.1 Target and Measurement SAR after Normalized**

## 8. EUT Testing Position

This EUT was tested in ten different positions. They are right cheek/right tilted/left cheek/left tilted for Head, Front/Back/Right Side/Left Side/Top Side/Bottom Side of the EUT with phantom 1 cm gap, as illustrated below, please refer to Appendix D for the test setup photos.

### 8.1 Define two imaginary lines on the handset

- The vertical centerline passes through two points on the front side of the handset - the midpoint of the width  $w_t$  of the handset at the level of the acoustic output, and the midpoint of the width  $w_b$  of the bottom of the handset.
- The horizontal line is perpendicular to the vertical centerline and passes through the center of the acoustic output. The horizontal line is also tangential to the face of the handset at point A.
- The two lines intersect at point A. Note that for many handsets, point A coincides with the center of the acoustic output; however, the acoustic output may be located elsewhere on the horizontal line. Also note that the vertical centerline is not necessarily parallel to the front face of the handset, especially for clamshell handsets, handsets with flip covers, and other irregularly shaped handsets.

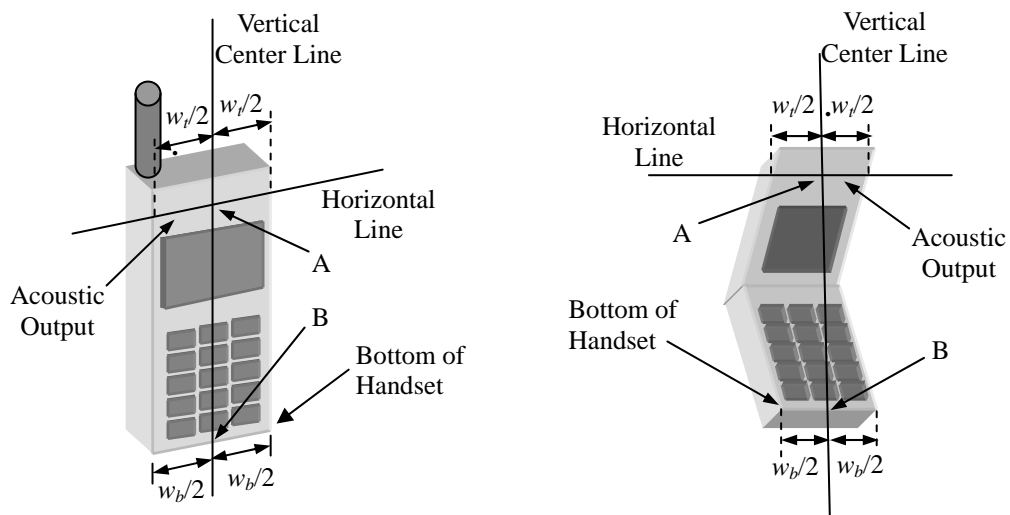
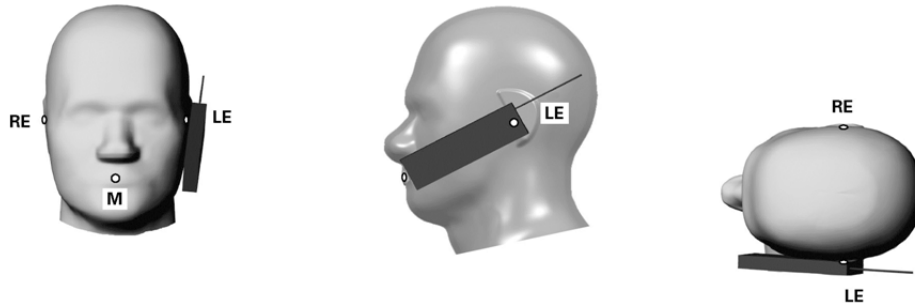

Fig 8.1 Illustration for Handset Vertical and Horizontal Reference Lines

**8.2 Cheek Position**

- (a) To position the device with the vertical center line of the body of the device and the horizontal line crossing the center piece in a plane parallel to the sagittal plane of the phantom. While maintaining the device in this plane, align the vertical center line with the reference plane containing the three ear and mouth reference point (M: Mouth, RE: Right Ear, and LE: Left Ear) and align the center of the ear piece with the line RE-LE.
- (b) To move the device towards the phantom with the ear piece aligned with the line LE-RE until the phone touched the ear. While maintaining the device in the reference plane and maintaining the phone contact with the ear, move the bottom of the phone until any point on the front side is in contact with the cheek of the phantom or until contact with the ear is lost (see Fig. 8.2).



**Fig 8.2 Illustration for Cheek Position**

**8.3 Tilted Position**

- (a) To position the device in the “cheek” position described above.
- (b) While maintaining the device the reference plane described above and pivoting against the ear, moves it outward away from the mouth by an angle of 15 degrees or until contact with the ear is lost (see Fig. 8.3).

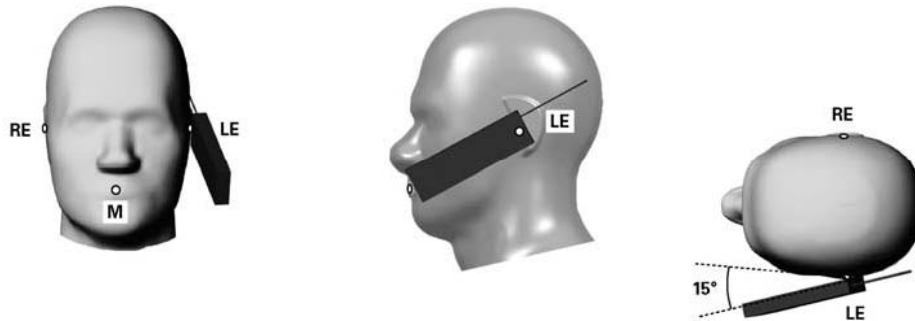

**Fig 8.3 Illustration for Tilted Position**

### **8.4 Body Worn Position**

- (a) To position the device parallel to the phantom surface with either keypad up or down.
- (b) To adjust the device parallel to the flat phantom.
- (c) To adjust the distance between the device surface and the flat phantom to 1 cm.

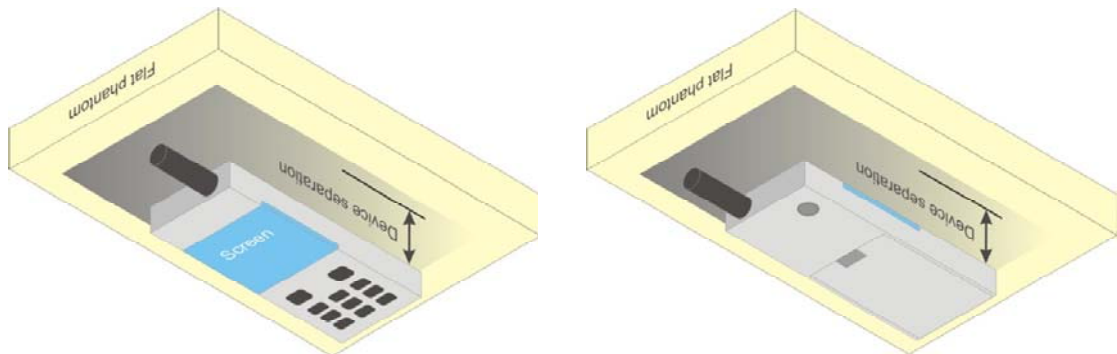

**Fig 8.4 Illustration for Body Worn Position**

### **8.5 Hotspot Position**

- (a) To position the device parallel to the phantom surface with all sides.
- (b) To adjust the device parallel to the flat phantom.
- (c) To adjust the distance between the device and the flat phantom to 1.0cm.

#### **<EUT Setup Photos>**

Please refer to Appendix D for the test setup photos.



## 9. Measurement Procedures

The measurement procedures are as follows:

### <Conducted power measurement>

- (a) For WWAN power measurement, use base station simulator to configure EUT WWAN transmission in conducted connection with RF cable, at maximum power in each supported wireless interface and frequency band.
- (b) Read the WWAN RF power level from the base station simulator.
- (c) For WLAN/BT power measurement, use engineering software to configure EUT WLAN/BT continuously transmission, at maximum RF power in each supported wireless interface and frequency band
- (d) Connect EUT RF port through RF cable to the power meter, and measure WLAN/BT output power

### <SAR measurement>

- (a) Use base station simulator to configure EUT WWAN transmission in radiated connection, and engineering software to configure EUT WLAN/BT continuously transmission, at maximum RF power, in the highest power channel.
- (b) Place the EUT in the positions as Appendix D demonstrates.
- (c) Set scan area, grid size and other setting on the DASY software.
- (d) Measure SAR results for the highest power channel on each testing position.
- (e) Find out the largest SAR result on these testing positions of each band
- (f) Measure SAR results for other channels in worst SAR testing position if the reported SAR of highest power channel is larger than 0.8 W/kg

According to the test standard, the recommended procedure for assessing the peak spatial-average SAR value consists of the following steps:

- (a) Power reference measurement
- (b) Area scan
- (c) Zoom scan
- (d) Power drift measurement

### 9.1 Spatial Peak SAR Evaluation

The procedure for spatial peak SAR evaluation has been implemented according to the test standard. It can be conducted for 1g and 10g, as well as for user-specific masses. The DASY software includes all numerical procedures necessary to evaluate the spatial peak SAR value.

The base for the evaluation is a "cube" measurement. The measured volume must include the 1g and 10g cubes with the highest averaged SAR values. For that purpose, the center of the measured volume is aligned to the interpolated peak SAR value of a previously performed area scan.

The entire evaluation of the spatial peak values is performed within the post-processing engine (SEMCAD). The system always gives the maximum values for the 1g and 10g cubes. The algorithm to find the cube with highest averaged SAR is divided into the following stages:

- (a) Extraction of the measured data (grid and values) from the Zoom Scan
- (b) Calculation of the SAR value at every measurement point based on all stored data (A/D values and measurement parameters)
- (c) Generation of a high-resolution mesh within the measured volume
- (d) Interpolation of all measured values from the measurement grid to the high-resolution grid
- (e) Extrapolation of the entire 3-D field distribution to the phantom surface over the distance from sensor to surface
- (f) Calculation of the averaged SAR within masses of 1g and 10g

### 9.2 Power Reference Measurement

The Power Reference Measurement and Power Drift Measurements are for monitoring the power drift of the device under test in the batch process. The minimum distance of probe sensors to surface determines the closest measurement point to phantom surface. This distance cannot be smaller than the distance of sensor calibration points to probe tip as defined in the probe properties.

### 9.3 Area & Zoom Scan Procedures

First Area Scan is used to locate the approximate location(s) of the local peak SAR value(s). The measurement grid within an Area Scan is defined by the grid extent, grid step size and grid offset. Next, in order to determine the EM field distribution in a three-dimensional spatial extension, Zoom Scan is required. The Zoom Scan is performed around the highest E-field value to determine the averaged SAR-distribution over 10 g. Area scan and zoom scan resolution setting follows KDB 865664 D01v01 quoted below.

When the 1-g SAR of the highest peak is within 2 dB of the SAR limit, additional zoom scans are required for other peaks within 2 dB of the highest peak that have not been included in any zoom scan to ensure there is no increase in SAR.

		$\leq 3$ GHz	$> 3$ GHz	
Maximum distance from closest measurement point (geometric center of probe sensors) to phantom surface		$5 \pm 1$ mm	$\frac{1}{2} \delta \ln(2) \pm 0.5$ mm	
Maximum probe angle from probe axis to phantom surface normal at the measurement location		$30^\circ \pm 1^\circ$	$20^\circ \pm 1^\circ$	
Maximum area scan spatial resolution: $\Delta x_{Area}, \Delta y_{Area}$		$\leq 2$ GHz: $\leq 15$ mm 2 – 3 GHz: $\leq 12$ mm	3 – 4 GHz: $\leq 12$ mm 4 – 6 GHz: $\leq 10$ mm	
		When the x or y dimension of the test device, in the measurement plane orientation, is smaller than the above, the measurement resolution must be $\leq$ the corresponding x or y dimension of the test device with at least one measurement point on the test device.		
Maximum zoom scan spatial resolution: $\Delta x_{Zoom}, \Delta y_{Zoom}$		$\leq 2$ GHz: $\leq 8$ mm 2 – 3 GHz: $\leq 5$ mm*	3 – 4 GHz: $\leq 5$ mm* 4 – 6 GHz: $\leq 4$ mm*	
Maximum zoom scan spatial resolution, normal to phantom surface	uniform grid: $\Delta z_{Zoom}(n)$	$\leq 5$ mm	3 – 4 GHz: $\leq 4$ mm 4 – 5 GHz: $\leq 3$ mm 5 – 6 GHz: $\leq 2$ mm	
	graded grid	$\Delta z_{Zoom}(1)$ : between 1 <sup>st</sup> two points closest to phantom surface	$\leq 4$ mm	3 – 4 GHz: $\leq 3$ mm 4 – 5 GHz: $\leq 2.5$ mm 5 – 6 GHz: $\leq 2$ mm
		$\Delta z_{Zoom}(n>1)$ : between subsequent points	$\leq 1.5 \cdot \Delta z_{Zoom}(n-1)$	
Minimum zoom scan volume	x, y, z	$\geq 30$ mm	3 – 4 GHz: $\geq 28$ mm 4 – 5 GHz: $\geq 25$ mm 5 – 6 GHz: $\geq 22$ mm	
<p>Note: <math>\delta</math> is the penetration depth of a plane-wave at normal incidence to the tissue medium; see draft standard IEEE P1528-2011 for details.</p> <p>* When zoom scan is required and the <i>reported</i> SAR from the area scan based 1-g SAR estimation procedures of KDB 447498 is <math>\leq 1.4</math> W/kg, <math>\leq 8</math> mm, <math>\leq 7</math> mm and <math>\leq 5</math> mm zoom scan resolution may be applied, respectively, for 2 GHz to 3 GHz, 3 GHz to 4 GHz and 4 GHz to 6 GHz.</p>				

### **9.4 Volume Scan Procedures**

The volume scan is used for assess overlapping SAR distributions for antennas transmitting in different frequency bands. It is equivalent to an oversized zoom scan used in standalone measurements. The measurement volume will be used to enclose all the simultaneous transmitting antennas. For antennas transmitting simultaneously in different frequency bands, the volume scan is measured separately in each frequency band. In order to sum correctly to compute the 1g aggregate SAR, the EUT remain in the same test position for all measurements and all volume scan use the same spatial resolution and grid spacing. When all volume scan were completed, the software, SEMCAD postprocessor can combine and subsequently superpose these measurement data to calculating the multiband SAR.

### **9.5 SAR Averaged Methods**

In DASYS, the interpolation and extrapolation are both based on the modified Quadratic Shepard's method. The interpolation scheme combines a least-square fitted function method and a weighted average method which are the two basic types of computational interpolation and approximation.

Extrapolation routines are used to obtain SAR values between the lowest measurement points and the inner phantom surface. The extrapolation distance is determined by the surface detection distance and the probe sensor offset. The uncertainty increases with the extrapolation distance. To keep the uncertainty within 1% for the 1 g and 10 g cubes, the extrapolation distance should not be larger than 5 mm.

### **9.6 Power Drift Monitoring**

All SAR testing is under the EUT install full charged battery and transmit maximum output power. In DASYS measurement software, the power reference measurement and power drift measurement procedures are used for monitoring the power drift of EUT during SAR test. Both these procedures measure the field at a specified reference position before and after the SAR testing. The software will calculate the field difference in dB. If the power drifts more than 5%, the SAR will be retested.



### 10. Conducted RF Output Power (Unit: dBm)

**<GSM Conducted Power>**

**Note:**

1. Per KDB 447498 D01v05, the maximum output power channel is used for SAR testing and for further SAR test reduction.
2. The EUT do not support DTM function.
3. Per KDB 447498 D01v05, the maximum output power channel is used for SAR testing and for further SAR test reduction.
4. For Head SAR testing, GSM should be evaluated, therefore the EUT was set in GSM Voice for GSM850 and GSM1900 due to its highest frame-average power.
5. For Body worn SAR testing, GSM should be evaluated, therefore the EUT was set in GSM Voice for GSM850 and GSM1900 due to its highest frame-average power.
6. For hotspot mode SAR testing, GPRS and EDGE should be evaluated, therefore the EUT was set in GPRS (4 Tx slots) for GSM850 and GSM1900 due to its highest frame-average power.

**For SIM1 Card**

Band: GSM850 Channel	Burst Average Power (dBm)			Frame-Average Power (dBm)		
	128	189	251	128	189	251
Frequency (MHz)	824.2	836.4	848.8	824.2	836.4	848.8
GSM (GMSK, 1 Tx slot)	32.15	32.17	32.18	23.15	23.17	23.18
GPRS (GMSK, 1 Tx slot) – CS1	32.14	32.15	32.16	23.14	23.15	23.16
GPRS (GMSK, 2 Tx slots) – CS1	31.35	31.36	31.36	25.35	25.36	25.36
GPRS (GMSK, 3 Tx slots) – CS1	29.77	29.78	29.79	25.51	25.52	25.53
GPRS (GMSK, 4 Tx slots) – CS1	29.03	29.03	29.04	26.03	26.03	26.04
EDGE (GMSK, 1 Tx slot) – MCS1	32.13	32.14	32.15	23.13	23.14	23.15
EDGE (GMSK, 2 Tx slots) – MCS1	31.34	31.35	31.35	25.34	25.35	25.35
EDGE (GMSK, 3 Tx slots) – MCS1	29.76	29.76	29.78	25.50	25.50	25.52
EDGE (GMSK, 4 Tx slots) – MCS1	29.01	29.02	29.03	26.01	26.02	26.03
EDGE (8PSK, 1 Tx slot) – MCS5	26.88	26.75	26.66	17.88	17.75	17.66
EDGE (8PSK, 2 Tx slots) – MCS5	25.64	25.49	25.43	19.64	19.49	19.43
EDGE (8PSK, 3 Tx slots) – MCS5	23.31	23.25	23.19	19.05	18.99	18.93
EDGE (8PSK, 4 Tx slots) – MCS5	22.20	22.17	22.05	19.20	19.17	19.05

**Remark:** The frame-averaged power is linearly scaled the maximum burst averaged power over 8 time slots.  
 The calculated method are shown as below:  
 Frame-averaged power = Maximum burst averaged power (1 Tx Slot) - 9 dB  
 Frame-averaged power = Maximum burst averaged power (2 Tx Slots) - 6 dB  
 Frame-averaged power = Maximum burst averaged power (3 Tx Slots) - 4.26 dB  
 Frame-averaged power = Maximum burst averaged power (4 Tx Slots) - 3 dB



Band: GSM1900	Burst Average Power (dBm)			Frame-Average Power (dBm)		
Channel	512	661	810	512	661	810
Frequency (MHz)	1850.2	1880.0	1909.8	1850.2	1880.0	1909.8
GSM (GMSK, 1 Tx slot)	29.21	29.22	29.24	20.21	20.22	20.24
GPRS (GMSK, 1 Tx slot) – CS1	29.20	29.20	29.23	20.20	20.20	20.23
GPRS (GMSK, 2 Tx slots) – CS1	28.41	28.42	28.47	22.41	22.42	22.47
GPRS (GMSK, 3 Tx slots) – CS1	26.88	26.86	26.94	22.62	22.60	22.68
GPRS (GMSK, 4 Tx slots) – CS1	26.11	26.13	26.19	23.11	23.13	23.19
EDGE (GMSK, 1 Tx slot) – MCS1	29.20	29.21	29.22	20.20	20.21	20.22
EDGE (GMSK, 2 Tx slots) – MCS1	28.41	28.43	28.47	22.41	22.43	22.47
EDGE (GMSK, 3 Tx slots) – MCS1	26.88	26.87	26.94	22.62	22.61	22.68
EDGE (GMSK, 4 Tx slots) – MCS1	26.12	26.14	26.18	23.12	23.14	23.18
EDGE (8PSK, 1 Tx slot) – MCS5	24.95	25.20	25.50	15.95	16.20	16.50
EDGE (8PSK, 2 Tx slots) – MCS5	23.54	23.71	24.31	17.54	17.71	18.31
EDGE (8PSK, 3 Tx slots) – MCS5	21.48	21.52	21.83	17.22	17.26	17.57
EDGE (8PSK, 4 Tx slots) – MCS5	20.18	20.45	20.73	17.18	17.45	17.73

**Remark:** The frame-averaged power is linearly scaled the maximum burst averaged power over 8 time slots.  
The calculated method are shown as below:  
Frame-averaged power = Maximum burst averaged power (1 Tx Slot) - 9 dB  
Frame-averaged power = Maximum burst averaged power (2 Tx Slots) - 6 dB  
Frame-averaged power = Maximum burst averaged power (3 Tx Slots) - 4.26 dB  
Frame-averaged power = Maximum burst averaged power (4 Tx Slots) - 3 dB

For SIM2 Card

Band: GSM850	Burst Average Power (dBm)			Frame-Average Power (dBm)		
Channel	128	189	251	128	189	251
Frequency (MHz)	824.2	836.4	848.8	824.2	836.4	848.8
GSM (GMSK, 1 Tx slot)	32.14	32.17	32.18	23.14	23.17	23.18
GPRS (GMSK, 1 Tx slot) – CS1	32.13	32.15	32.16	23.13	23.15	23.16
GPRS (GMSK, 2 Tx slots) – CS1	31.34	31.36	31.37	25.34	25.36	25.37
GPRS (GMSK, 3 Tx slots) – CS1	29.77	29.78	29.79	25.51	25.52	25.53
GPRS (GMSK, 4 Tx slots) – CS1	29.02	29.02	29.03	26.02	26.02	26.03
EDGE (GMSK, 1 Tx slot) – MCS1	32.12	32.13	32.14	23.12	23.13	23.14
EDGE (GMSK, 2 Tx slots) – MCS1	31.33	31.34	31.35	25.33	25.34	25.35
EDGE (GMSK, 3 Tx slots) – MCS1	29.75	29.76	29.77	25.49	25.50	25.51
EDGE (GMSK, 4 Tx slots) – MCS1	29.01	29.00	29.02	26.01	26.00	26.02
EDGE (8PSK, 1 Tx slot) – MCS5	26.74	26.67	26.58	17.74	17.67	17.58
EDGE (8PSK, 2 Tx slots) – MCS5	25.50	25.39	25.33	19.50	19.39	19.33
EDGE (8PSK, 3 Tx slots) – MCS5	23.23	23.06	23.09	18.97	18.80	18.83
EDGE (8PSK, 4 Tx slots) – MCS5	22.13	22.06	21.96	19.13	19.06	18.96

**Remark:** The frame-averaged power is linearly scaled the maximum burst averaged power over 8 time slots.  
The calculated method are shown as below:  
Frame-averaged power = Maximum burst averaged power (1 Tx Slot) - 9 dB  
Frame-averaged power = Maximum burst averaged power (2 Tx Slots) - 6 dB  
Frame-averaged power = Maximum burst averaged power (3 Tx Slots) - 4.26 dB  
Frame-averaged power = Maximum burst averaged power (4 Tx Slots) - 3 dB



Band: GSM1900 Channel	Burst Average Power (dBm)			Frame-Average Power (dBm)		
	512	661	810	512	661	810
Frequency (MHz)	1850.2	1880.0	1909.8	1850.2	1880.0	1909.8
GSM (GMSK, 1 Tx slot)	29.20	29.19	29.23	20.20	20.19	20.23
GPRS (GMSK, 1 Tx slot) – CS1	29.19	29.18	29.21	20.19	20.18	20.21
GPRS (GMSK, 2 Tx slots) – CS1	28.39	28.41	28.45	22.39	22.41	22.45
GPRS (GMSK, 3 Tx slots) – CS1	26.86	26.85	26.92	22.60	22.59	22.66
GPRS (GMSK, 4 Tx slots) – CS1	26.10	26.12	26.18	23.10	23.12	23.18
EDGE (GMSK, 1 Tx slot) – MCS1	29.18	29.17	29.20	20.18	20.17	20.20
EDGE (GMSK, 2 Tx slots) – MCS1	28.39	28.41	28.44	22.39	22.41	22.44
EDGE (GMSK, 3 Tx slots) – MCS1	26.87	26.85	26.91	22.61	22.59	22.65
EDGE (GMSK, 4 Tx slots) – MCS1	26.10	26.12	26.17	23.10	23.12	23.17
EDGE (8PSK, 1 Tx slot) – MCS5	24.81	25.03	25.37	15.81	16.03	16.37
EDGE (8PSK, 2 Tx slots) – MCS5	23.41	23.55	24.28	17.41	17.55	18.28
EDGE (8PSK, 3 Tx slots) – MCS5	21.35	21.45	21.80	17.09	17.19	17.54
EDGE (8PSK, 4 Tx slots) – MCS5	20.14	20.32	20.62	17.14	17.32	17.62

**Remark:** The frame-averaged power is linearly scaled the maximum burst averaged power over 8 time slots.  
The calculated method are shown as below:  
Frame-averaged power = Maximum burst averaged power (1 Tx Slot) - 9 dB  
Frame-averaged power = Maximum burst averaged power (2 Tx Slots) - 6 dB  
Frame-averaged power = Maximum burst averaged power (3 Tx Slots) - 4.26 dB  
Frame-averaged power = Maximum burst averaged power (4 Tx Slots) - 3 dB



**<WCDMA Conducted Power>**

The following tests were conducted according to the test requirements outlines in 3GPP TS 34.121 specification.

A summary of these settings are illustrated below:

**HSDPA Setup Configuration:**

- a. The EUT was connected to Base Station Agilent E5515C referred to the Setup Configuration.
- b. The RF path losses were compensated into the measurements.
- c. A call was established between EUT and Base Station with following setting:
  - i. Set Gain Factors ( $\beta_c$  and  $\beta_d$ ) and parameters were set according to each
  - ii. Specific sub-test in the following table, C10.1.4, quoted from the TS 34.121
  - iii. Set RMC 12.2Kbps + HSDPA mode.
  - iv. Set Cell Power = -86 dBm
  - v. Set HS-DSCH Configuration Type to FRC (H-set 1, QPSK)
  - vi. Select HSDPA Uplink Parameters
  - vii. Set Delta ACK, Delta NACK and Delta CQI = 8
  - viii. Set Ack-Nack Repetition Factor to 3
  - ix. Set CQI Feedback Cycle (k) to 4 ms
  - x. Set CQI Repetition Factor to 2
  - xi. Power Ctrl Mode = All Up bits
- d. The transmitted maximum output power was recorded.

**Table C.10.1.4:  $\beta$  values for transmitter characteristics tests with HS-DPCCH**

Sub-test	$\beta_c$	$\beta_d$	$\beta_d$ (SF)	$\beta_c/\beta_d$	$\beta_{HS}$ (Note 1, Note 2)	CM (dB) (Note 3)	MPR (dB) (Note 3)
1	2/15	15/15	64	2/15	4/15	0.0	0.0
2	12/15 (Note 4)	15/15 (Note 4)	64	12/15 (Note 4)	24/15	1.0	0.0
3	15/15	8/15	64	15/8	30/15	1.5	0.5
4	15/15	4/15	64	15/4	30/15	1.5	0.5

Note 1:  $\Delta_{ACK}, \Delta_{NACK}$  and  $\Delta_{CQI} = 30/15$  with  $\beta_{HS} = 30/15 * \beta_c$ .

Note 2: For the HS-DPCCH power mask requirement test in clause 5.2C, 5.7A, and the Error Vector Magnitude (EVM) with HS-DPCCH test in clause 5.13.1A, and HSDPA EVM with phase discontinuity in clause 5.13.1AA,  $\Delta_{ACK}$  and  $\Delta_{NACK} = 30/15$  with  $\beta_{HS} = 30/15 * \beta_c$ , and  $\Delta_{CQI} = 24/15$  with  $\beta_{HS} = 24/15 * \beta_c$ .

Note 3: CM = 1 for  $\beta_c/\beta_d = 12/15, \beta_{HS}/\beta_c = 24/15$ . For all other combinations of DPDCH, DPCCH and HS-DPCCH the MPR is based on the relative CM difference. This is applicable for only UEs that support HSDPA in release 6 and later releases.

Note 4: For subtest 2 the  $\beta_c/\beta_d$  ratio of 12/15 for the TFC during the measurement period (TF1, TF0) is achieved by setting the signalled gain factors for the reference TFC (TF1, TF1) to  $\beta_c = 11/15$  and  $\beta_d = 15/15$ .

**Setup Configuration**

**HSUPA Setup Configuration:**

- a. The EUT was connected to Base Station Agilent E5515C referred to the Setup Configuration.
- b. The RF path losses were compensated into the measurements.
- c. A call was established between EUT and Base Station with following setting \* :
  - i. Call Configs = 5.2B, 5.9B, 5.10B, and 5.13.2B with QPSK
  - ii. Set the Gain Factors ( $\beta_c$  and  $\beta_d$ ) and parameters (AG Index) were set according to each specific sub-test in the following table, C11.1.3, quoted from the TS 34.121
  - iii. Set Cell Power = -86 dBm
  - iv. Set Channel Type = 12.2k + HSPA
  - v. Set UE Target Power
  - vi. Power Ctrl Mode= Alternating bits
  - vii. Set and observe the E-TFCl
  - viii. Confirm that E-TFCl is equal to the target E-TFCl of 75 for sub-test 1, and other subtest's E-TFCl
- d. The transmitted maximum output power was recorded.

**Table C.11.1.3:  $\beta$  values for transmitter characteristics tests with HS-DPCCH and E-DCH**

Sub-test	$\beta_c$	$\beta_d$	$\beta_d$ (SF)	$\beta_c/\beta_d$	$\beta_{HS}$ (Note 1)	$\beta_{ec}$	$\beta_{ed}$ (Note 5) (Note 6)	$\beta_{ed}$ (SF)	$\beta_{ed}$ (Codes)	CM (dB) (Note 2)	MPR (dB) (Note 2)	AG Index (Note 6)	E-TFCl
1	11/15 (Note 3)	15/15 (Note 3)	64	11/15 (Note 3)	22/15	209/225	1309/225	4	1	1.0	0.0	20	75
2	6/15	15/15	64	6/15	12/15	12/15	94/75	4	1	3.0	2.0	12	67
3	15/15	9/15	64	15/9	30/15	30/15	$\beta_{ed1}: 47/15$ $\beta_{ed2}: 47/15$	4	2	2.0	1.0	15	92
4	2/15	15/15	64	2/15	4/15	2/15	56/75	4	1	3.0	2.0	17	71
5	15/15 (Note 4)	15/15 (Note 4)	64	15/15 (Note 4)	30/15	24/15	134/15	4	1	1.0	0.0	21	81

Note 1:  $\Delta_{ACK}, \Delta_{NACK}$  and  $\Delta_{CQI} = 30/15$  with  $\beta_{hs} = 30/15 * \beta_c$ .

Note 2: CM = 1 for  $\beta_c/\beta_d = 12/15, \beta_{hs}/\beta_c = 24/15$ . For all other combinations of DPDCH, DPCCH, HS-DPCCH, E-DPDCH and E-DPCCH the MPR is based on the relative CM difference.

Note 3: For subtest 1 the  $\beta_c/\beta_d$  ratio of 11/15 for the TFC during the measurement period (TF1, TF0) is achieved by setting the signalled gain factors for the reference TFC (TF1, TF1) to  $\beta_c = 10/15$  and  $\beta_d = 15/15$ .

Note 4: For subtest 5 the  $\beta_c/\beta_d$  ratio of 15/15 for the TFC during the measurement period (TF1, TF0) is achieved by setting the signalled gain factors for the reference TFC (TF1, TF1) to  $\beta_c = 14/15$  and  $\beta_d = 15/15$ .

Note 5: In case of testing by UE using E-DPDCH Physical Layer category 1, Sub-test 3 is omitted according to TS25.306 Table 5.1g.

Note 6:  $\beta_{ed}$  can not be set directly, it is set by Absolute Grant Value.

**Setup Configuration**



**HSPA+ 3GPP release 7 (uplink category 7) 16QAM, Setup Configuration:**

- a. The EUT was connected to Base Station Agilent E5515C referred to the Setup Configuration.
- b. The RF path losses were compensated into the measurements.
- c. A call was established between EUT and Base Station with following setting \* :
  - i. Call Configs = 5.2E:HSPA+:UL with 16QAM
  - ii. Set the Gain Factors ( $\beta_c$  and  $\beta_d$ ) and parameters (AG Index) were set according to each specific sub-test in the following table, C11.1.4, quoted from the TS 34.121-1 s5.2E
  - iii. Set Channel Params
  - iv. Set Cell Power = -86 dBm
  - v. Set Channel Type = HSPA
  - vi. Set UE Target Power =21 dBm
  - vii. Power Ctrl Mode= All Up Bits
  - viii. Set Manual Uplink DPCH Bc/Bd = Manual
  - ix. Set Manual Uplink DPCH Bc and Bd=15,15(for 34.121-1 v8.10.0 table C11.1.4 sub-test 1)
  - x. Set HSPA Conn DL Channel Levels
  - xi. Set HS-SCCH Configs
  - xii. Set RB Test Mode Setup
  - xiii. Set Common HSUPA Parameters
  - xiv. Set Serving Grant
  - xv. Confirm that E-TFCI is equal to the target E-TFCI of 105 for sub-test 1, and other subtest's E-TFCI
- d. The transmitted maximum output power was recorded.

**Table C.11.1.4:  $\beta$  values for transmitter characteristics tests with HS-DPCCH and E-DCH with 16QAM**

Sub-test	$\beta_c$ (Note3)	$\beta_d$	$\beta_{HS}$ (Note1)	$\beta_{ec}$	$\beta_{ed}$ (2xSF2) (Note 4)	$\beta_{ed}$ (2xSF4) (Note 4)	CM (dB) (Note 2)	MPR (dB) (Note 2)	AG Index (Note 4)	E-TFCI (Note 5)	E-TFCI (boost)
1	1	0	30/15	30/15	$\beta_{ed1}$ : 30/15 $\beta_{ed2}$ : 30/15	$\beta_{ed3}$ : 24/15 $\beta_{ed4}$ : 24/15	3.5	2.5	14	105	105

Note 1:  $\Delta_{ACK}, \Delta_{NACK}$  and  $\Delta_{CQI} = 30/15$  with  $\beta_{ts} = 30/15 * \beta_c$ .

Note 2: CM = 3.5 and the MPR is based on the relative CM difference, MPR = MAX(CM-1,0).

Note 3: DPDCH is not configured, therefore the  $\beta_c$  is set to 1 and  $\beta_d = 0$  by default.

Note 4:  $\beta_{ed}$  can not be set directly; it is set by Absolute Grant Value.

Note 5: All the sub-tests require the UE to transmit 2SF2+2SF4 16QAM EDCH and they apply for UE using E-DPDCH category 7. E-DCH TTI is set to 2ms TTI and E-DCH table index = 2. To support these E-DCH configurations DPDCH is not allocated. The UE is signaled to use the extrapolation algorithm.

**Setup Configuration**

**DC-HSDPA 3GPP release 8 Setup Configuration:**

- a. The EUT was connected to Base Station Agilent E5515C referred to the Setup Configuration below
- b. The RF path losses were compensated into the measurements.
- c. A call was established between EUT and Base Station with following setting:
  - i. Set RMC 12.2Kbps + HSDPA mode.
  - ii. Set Cell Power = -25 dBm
  - iii. Set HS-DSCH Configuration Type to FRC (H-set 12, QPSK)
  - iv. Select HSDPA Uplink Parameters
  - v. Set Gain Factors ( $\beta_c$  and  $\beta_d$ ) and parameters were set according to each Specific sub-test in the following table, C10.1.4, quoted from the TS 34.121
    - a). Subtest 1:  $\beta_c/\beta_d=2/15$
    - b). Subtest 2:  $\beta_c/\beta_d=12/15$
    - c). Subtest 3:  $\beta_c/\beta_d=15/8$
    - d). Subtest 4:  $\beta_c/\beta_d=15/4$
  - vi. Set Delta ACK, Delta NACK and Delta CQI = 8
  - vii. Set Ack-Nack Repetition Factor to 3
  - viii. Set CQI Feedback Cycle (k) to 4 ms
  - ix. Set CQI Repetition Factor to 2
  - x. Power Ctrl Mode = All Up bits
- d. The transmitted maximum output power was recorded.

The following tests were conducted according to the test requirements outlines in 3GPP TS 34.121 specification. A summary of these settings are illustrated below:

**C.8.1.12 Fixed Reference Channel Definition H-Set 12**

**Table C.8.1.12: Fixed Reference Channel H-Set 12**

Parameter	Unit	Value
Nominal Avg. Inf. Bit Rate	kbps	60
Inter-TTI Distance	TTI's	1
Number of HARQ Processes	Processes	6
Information Bit Payload ( $N_{INF}$ )	Bits	120
Number Code Blocks	Blocks	1
Binary Channel Bits Per TTI	Bits	960
Total Available SML's in UE	SML's	19200
Number of SML's per HARQ Proc.	SML's	3200
Coding Rate		0.15
Number of Physical Channel Codes	Codes	1
Modulation		QPSK
Note 1: The RMC is intended to be used for DC-HSDPA mode and both cells shall transmit with identical parameters as listed in the table.		
Note 2: Maximum number of transmission is limited to 1, i.e., retransmission is not allowed. The redundancy and constellation version 0 shall be used.		

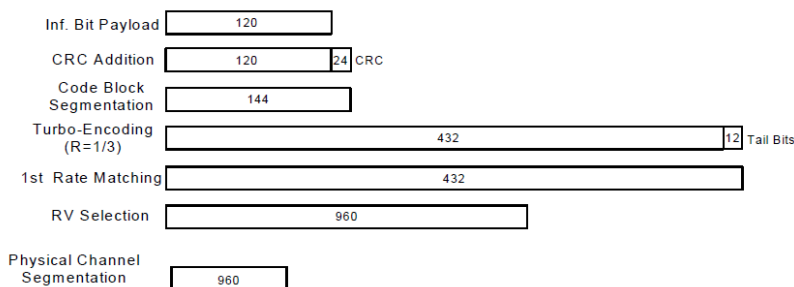

**Figure C.8.19: Coding rate for Fixed reference Channel H-Set 12 (QPSK)**

**Setup Configuration**



<WCDMA Conducted Power>

Note:

1. Applying the subtest setup in Table C.11.1.3 of 3GPP TS 34.121-1 V9.1.0 to Rel. 6 HSPA, the subtest setup in Table C.11.1.4 to Rel. 7 HSPA+, and the subtest setup in Table C10.1.4 to Rel. 8 DC-HSDPA.
2. Per KDB 941225 D01, RMC 12.2kbps setting is used to evaluate SAR. If AMR 12.2kbps power is < 0.25dB higher than RMC 12.2kbps, SAR tests with AMR 12.2kbps can be excluded.
3. By design, AMR, HSDPA/DC-HSDPA/HSUPA and HSPA+ (16QAM in uplink) RF power will not be larger than RMC 12.2kbps., detailed information is included in Tune-up Procure exhibit.
4. It is expected by the manufacturer that MPR for some HSDPA/DC-HSDPA/HSUPA, HSPA+ (16QAM in uplink) subtests may differ from the specification of 3GPP, according to the chipset implementation in this model. The implementation and expected deviation are detailed in tune-up procedure exhibit.

For SIM1 Card

		WCDMA Average power (dBm)					
Band		WCDMA Band V			WCDMA Band II		
Channel		4132	4182	4233	9262	9400	9538
Frequency (MHz)		826.4	836.4	846.6	1852.4	1880.0	1907.6
3GPP Rel 99	AMR 12.2K	22.26	22.30	22.27	22.76	22.56	22.36
3GPP Rel 99	RMC 12.2K	22.27	22.31	22.28	22.78	22.58	22.37
3GPP Rel 8	HSDPA Subtest-1	21.33	21.37	21.35	21.77	21.60	21.46
3GPP Rel 8	HSDPA Subtest-2	21.19	21.23	21.21	21.66	21.49	21.35
3GPP Rel 8	HSDPA Subtest-3	20.85	20.89	20.87	21.35	21.18	21.04
3GPP Rel 8	HSDPA Subtest-4	20.84	20.88	20.86	21.32	21.15	21.01
3GPP Rel 8	DC-HSDPA Subtest-1	21.10	21.02	21.09	21.31	21.26	21.33
3GPP Rel 8	DC-HSDPA Subtest-2	21.07	21.02	21.06	21.28	21.24	21.27
3GPP Rel 8	DC-HSDPA Subtest-3	20.60	20.53	20.58	20.81	20.76	20.76
3GPP Rel 8	DC-HSDPA Subtest-4	20.58	20.50	20.56	20.77	20.75	20.74
3GPP Rel 7	HSUPA Subtest-1	20.10	20.13	20.08	20.10	19.96	19.87
3GPP Rel 7	HSUPA Subtest-2	18.78	18.81	18.76	18.77	18.63	18.54
3GPP Rel 7	HSUPA Subtest-3	19.99	20.02	19.97	19.96	19.82	19.73
3GPP Rel 7	HSUPA Subtest-4	18.75	18.78	18.73	18.82	18.68	18.59
3GPP Rel 7	HSUPA Subtest-5	20.30	20.33	20.28	20.32	20.18	20.09
3GPP Rel 7	HSPA+ (16QAM) Subtest-1	18.48	18.43	18.48	18.40	18.26	18.24

		MPR (dB)					
3GPP MPR	Subtest	WCDMA Band V			WCDMA Band II		
0	3GPP Rel 8 HSDPA Subtest-1	0.00	0.00	0.00	0.00	0.00	0.00
0	3GPP Rel 8 HSDPA Subtest-2	0.14	0.14	0.14	0.11	0.11	0.11
≤0.5	3GPP Rel 8 HSDPA Subtest-3	0.48	0.48	0.48	0.42	0.42	0.42
≤0.5	3GPP Rel 8 HSDPA Subtest-4	0.49	0.49	0.49	0.45	0.45	0.45
0	3GPP Rel 8 DC-HSDPA Subtest-1	0.00	0.00	0.00	0.00	0.00	0.00
0	3GPP Rel 8 DC-HSDPA Subtest-2	0.03	0.00	0.03	0.03	0.02	0.06
≤0.5	3GPP Rel 8 DC-HSDPA Subtest-3	0.50	0.49	0.51	0.50	0.50	0.57
≤0.5	3GPP Rel 8 DC-HSDPA Subtest-4	0.52	0.52	0.53	0.54	0.51	0.59
≤0	3GPP Rel 7 HSUPA Subtest-1	0.20	0.20	0.20	0.22	0.22	0.22
≤2	3GPP Rel 7 HSUPA Subtest-2	1.52	1.52	1.52	1.55	1.55	1.55
≤1	3GPP Rel 7 HSUPA Subtest-3	0.31	0.31	0.31	0.36	0.36	0.36
≤2	3GPP Rel 7 HSUPA Subtest-4	1.55	1.55	1.55	1.50	1.50	1.50
≤0	3GPP Rel 7 HSUPA Subtest-5	0.00	0.00	0.00	0.00	0.00	0.00
≤2.5	3GPP Rel 7 HSPA+ (16QAM) Subtest-1	1.82	1.90	1.80	1.92	1.92	1.85

**<WLAN 2.4GHz Conducted Power>**

**Note:**

1. Per KDB 248227 D01 v01r02, choose the highest output power channel to test SAR and determine further SAR exclusion
2. For each frequency band, testing at higher data rates and higher order modulations is not required when the maximum average output power for each of these configurations is less than 1/4dB higher than those measured at the lowest data rate
3. Per KDB 248227 D01 v01r02, 11g, 11n-HT20 and 11n-HT40 output power is less than 1/4dB higher than 11b mode, thus the SAR can be excluded.

802.11b Average Power (dBm)					
Channel	Frequency (MHz)	Data Rate (bps)			
		1M bps	2M bps	5.5M bps	11M bps
CH 01	2412	14.02	13.98	14.00	13.99
CH 06	2437	14.23	14.13	14.23	14.19
CH 11	2462	14.58	14.50	14.50	14.55

802.11g Average Power (dBm)									
Channel	Frequency (MHz)	Data Rate (bps)							
		6M bps	9M bps	12M bps	18M bps	24M bps	36M bps	48M bps	54M bps
CH 01	2412	10.34	10.43	10.44	10.29	10.26	10.23	10.19	10.20
CH 06	2437	10.37	10.42	10.41	10.38	10.35	10.43	10.53	10.49
CH 11	2462	10.94	10.92	10.91	10.89	10.86	10.84	10.83	10.80

WLAN 2.4GHz Band 802.11n-HT20 Average Power (dBm)									
Channel	Frequency (MHz)	Data Rate (bps)							
		6.5 Mbps	13 Mbps	19.5 Mbps	26 Mbps	39 Mbps	52 Mbps	58.5 Mbps	65 Mbps
CH 01	2412	10.44	10.49	10.45	10.41	10.47	10.44	10.28	10.29
CH 06	2437	10.46	10.48	10.48	10.43	10.45	10.43	10.58	10.59
CH 11	2462	10.98	10.95	10.96	10.95	10.90	10.95	10.83	10.88

WLAN 2.4GHz Band 802.11n-HT20 Average Power (dBm)									
Channel	Frequency (MHz)	Data Rate (bps)							
		13.5 Mbps	27 Mbps	40.5 Mbps	54 Mbps	81 Mbps	108 Mbps	121.5 Mbps	135 Mbps
CH 03	2422	10.01	10.10	10.16	10.05	10.10	10.09	10.19	9.99
CH 06	2437	10.16	10.25	10.32	10.15	10.21	10.13	10.04	10.19
CH 09	2452	10.43	10.41	10.40	10.33	10.37	10.37	10.28	10.39

<Bluetooth Conducted Power>

Bluetooth Average Power (dBm)										
Channel	Frequency (MHz)	Data Rate								
		DH1	DH3	DH5	2DH1	2DH3	2DH5	3DH1	3DH3	3DH5
CH 00	2402	7.22	7.12	6.91	5.50	5.04	4.67	5.44	4.42	4.64
CH 39	2441	6.68	7.00	6.81	5.38	4.51	4.62	4.97	4.72	4.51
CH 78	2480	7.33	6.95	7.10	5.60	5.04	4.75	5.63	5.06	4.75

Channel	Frequency (MHz)	Average power (dBm)
		Mode
		BT v4.0 LE, GFSK
CH 00	2402	0.13
CH 19	2440	0.15
CH 39	2480	0.20

Note:

- Per KDB 447498 D01v05, the 1-g SAR test exclusion thresholds for 100 MHz to 6 GHz at test separation distances ≤ 50 mm are determined by:  

$$[(\text{max. power of channel, including tune-up tolerance, mW}) / (\text{min. test separation distance, mm})] \cdot [\sqrt{f(\text{GHz})}] \leq 3.0$$
 for 1-g SAR
  - f(GHz) is the RF channel transmit frequency in GHz
  - Power and distance are rounded to the nearest mW and mm before calculation
  - The result is rounded to one decimal place for comparison
  - If the test separation distance (antenna-user) is < 5mm, 5mm is used for excluded SAR calculation

Bluetooth Max Power (dBm)	mW	Test Distance (mm)	Frequency (GHz)	exclusion thresholds
8	6.31	0	2.48	1.99
		10	2.48	0.99

- Per KDB 447498 D01v05 exclusion thresholds is 1.99 < 3, RF exposure evaluation is not required.

### 11. DUT Antenna Location

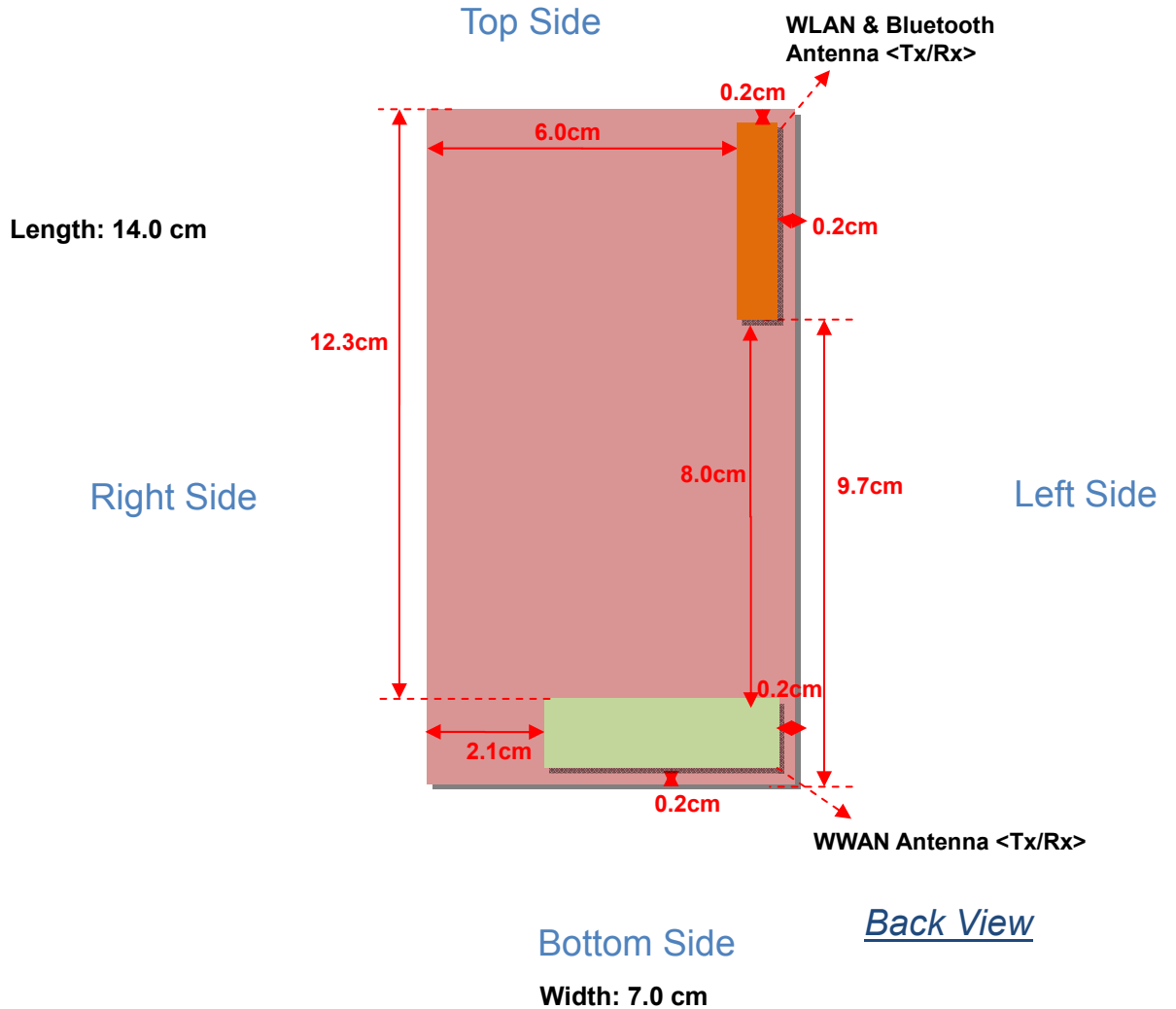

Antennas	Wireless Interface
WWAN Antenna (Tx / Rx)	GSM850 GSM1900 WCDMA Band V WCDMA Band II
WLAN & Bluetooth Antenna <Tx / Rx>	WLAN 2.4GHz Bluetooth

Distance of the Antenna to the EUT surface/edge						
Antennas	Back	Front	Top Side	Bottom Side	Right Side	Left Side
<b>WWAN</b>	≤ 25mm	≤ 25mm	123mm	≤ 25mm	≤ 25mm	≤ 25mm
<b>WLAN &amp; Bluetooth</b>	≤ 25mm	≤ 25mm	≤ 25mm	97mm	60.mm	≤ 25mm

Positions for SAR tests; Hotspot mode Test distance: 10 mm						
Antennas	Back	Front	Top Side	Bottom Side	Right Side	Left Side
<b>WWAN</b>	Yes	Yes	NO	Yes	Yes	Yes
<b>WLAN &amp; Bluetooth</b>	Yes	Yes	Yes	NO	NO	Yes

1. Head/Body-worn/Hotspot mode SAR assessments are required.
2. Referring to KDB 941225 D06 v01, when the overall device length and width are ≥ 9cm\*5cm, the test distance is 10 mm. SAR must be measured for all sides and surfaces with a transmitting antenna located within 25mm from that surface or edge
3. Per KDB 447498 D01v05, for handsets the *test separation distance* is determined by the smallest distance between the outer surface of the device and the user; which is 0mm for head SAR, 10mm for hotspot SAR, 10mm for body-worn SAR.

## 12. SAR Test Results

**Note:**

- Per KDB 447498 D01v05, the reported SAR is the measured SAR value adjusted for maximum tune-up tolerance.  
 $Scaling\ Factor = \frac{tune-up\ limit\ power\ (mW)}{EUT\ RF\ power\ (mW)}$ , where tune-up limit is the maximum rated power among all production units.  
 $Reported\ SAR(W/kg) = Measured\ SAR(W/kg) * Scaling\ Factor$
- Per KDB 447498 D01v05, for each exposure position, if the highest output channel reported SAR  $\leq 0.8W/kg$ , other channels SAR testing is not necessary.
- Additional WLAN SAR testing was performed for simultaneous transmission analysis
- For Hotspot SAR testing, per KDB 941225 D06, for EUT dimension  $\geq 9cm*5cm$ , the test distance is 1cm. SAR must be measured for all surfaces and sides with a transmitting antenna located within 2.5cm from that surface or edge.

### 12.1 Test Records for Head SAR Test

**<GSM SAR>**

Plot No.	Band	Mode	Test Position	Ch.	Freq. (MHz)	Average Power (dBm)	Tune-Up Limit (dBm)	Scaling Factor	Power Drift (dB)	Measured SAR <sub>1g</sub> (W/kg)	Reported SAR <sub>1g</sub> (W/kg)
45	GSM850	GSM Voice	Right Cheek	251	848.8	32.18	33	1.208	-0.14	0.301	0.364
46	GSM850	GSM Voice	Right Tilted	251	848.8	32.18	33	1.208	-0.12	0.173	0.209
47	GSM850	GSM Voice	Left Cheek	251	848.8	32.18	33	1.208	-0.02	0.281	0.339
48	GSM850	GSM Voice	Left Tilted	251	848.8	32.18	33	1.208	-0.08	0.188	0.227
49	GSM1900	GSM Voice	Right Cheek	810	1909.8	29.24	30	1.191	-0.13	0.173	0.206
50	GSM1900	GSM Voice	Right Tilted	810	1909.8	29.24	30	1.191	-0.09	0.111	0.132
51	GSM1900	GSM Voice	Left Cheek	810	1909.8	29.24	30	1.191	-0.14	0.310	0.369
52	GSM1900	GSM Voice	Left Tilted	810	1909.8	29.24	30	1.191	0.11	0.113	0.135

**<WCDMA SAR>**

Plot No.	Band	Mode	Test Position	Ch.	Freq. (MHz)	Average Power (dBm)	Tune-Up Limit (dBm)	Scaling Factor	Power Drift (dB)	Measured SAR <sub>1g</sub> (W/kg)	Reported SAR <sub>1g</sub> (W/kg)
53	WCDMA Band V	RMC 12.2K	Right Cheek	4182	836.4	22.31	24	1.476	-0.17	0.249	0.367
54	WCDMA Band V	RMC 12.2K	Right Tilted	4182	836.4	22.31	24	1.476	-0.03	0.151	0.223
55	WCDMA Band V	RMC 12.2K	Left Cheek	4182	836.4	22.31	24	1.476	-0.02	0.229	0.338
56	WCDMA Band V	RMC 12.2K	Left Tilted	4182	836.4	22.31	24	1.476	-0.07	0.150	0.221
57	WCDMA Band II	RMC 12.2K	Right Cheek	9262	1852.4	22.78	23.5	1.180	-0.07	0.385	0.454
58	WCDMA Band II	RMC 12.2K	Right Tilted	9262	1852.4	22.78	23.5	1.180	-0.07	0.207	0.244
59	WCDMA Band II	RMC 12.2K	Left Cheek	9262	1852.4	22.78	23.5	1.180	-0.16	0.585	0.690
60	WCDMA Band II	RMC 12.2K	Left Tilted	9262	1852.4	22.78	23.5	1.180	-0.09	0.206	0.243

**<WLAN2.4GHz SAR>**

Plot No.	Band	Mode	Data Rate	Test Position	Ch.	Freq. (MHz)	Average Power (dBm)	Tune-Up Limit (dBm)	Scaling Factor	Power Drift (dB)	Measured SAR <sub>1g</sub> (W/kg)	Reported SAR <sub>1g</sub> (W/kg)
61	WLAN2.4GHz	802.11b	1M	Right Cheek	11	2462	14.58	15	1.102	-0.07	0.360	0.397
62	WLAN2.4GHz	802.11b	1M	Right Tilted	11	2462	14.58	15	1.102	-0.03	0.284	0.313
63	WLAN2.4GHz	802.11b	1M	Left Cheek	11	2462	14.58	15	1.102	0.04	0.183	0.202
64	WLAN2.4GHz	802.11b	1M	Left Tilted	11	2462	14.58	15	1.102	0.11	0.183	0.202





12.2 Test Records for Hotspot SAR Test

<GSM SAR>

Plot No.	Band	Mode	Test Position	Gap (cm)	Ch.	Freq. (MHz)	Average Power (dBm)	Tune-Up Limit (dBm)	Scaling Factor	Power Drift (dB)	Measured SAR <sub>1g</sub> (W/kg)	Reported SAR <sub>1g</sub> (W/kg)
1	GSM850	GPRS(4 Tx slots)	Front	1	251	848.8	29.04	29.5	1.112	0.04	0.855	0.951
2	<b>GSM850</b>	<b>GPRS(4 Tx slots)</b>	<b>Back</b>	<b>1</b>	<b>251</b>	<b>848.8</b>	<b>29.04</b>	<b>29.5</b>	<b>1.112</b>	<b>-0.11</b>	<b>1.130</b>	<b>1.256</b>
3	GSM850	GPRS(4 Tx slots)	Left Side	1	251	848.8	29.04	29.5	1.112	0.03	0.820	0.912
4	GSM850	GPRS(4 Tx slots)	Right Side	1	251	848.8	29.04	29.5	1.112	-0.02	0.938	1.043
5	GSM850	GPRS(4 Tx slots)	Bottom Side	1	251	848.8	29.04	29.5	1.112	-0.13	0.134	0.149
6	GSM850	GPRS(4 Tx slots)	Front	1	128	824.2	29.03	29.5	1.114	0.04	0.923	1.028
7	GSM850	GPRS(4 Tx slots)	Front	1	189	836.4	29.03	29.5	1.114	0.04	0.911	1.015
8	GSM850	GPRS(4 Tx slots)	Back	1	128	824.2	29.03	29.5	1.114	-0.02	0.909	1.013
9	GSM850	GPRS(4 Tx slots)	Back	1	189	836.4	29.03	29.5	1.114	-0.08	0.920	1.025
10	GSM850	GPRS(4 Tx slots)	Left Side	1	128	824.2	29.03	29.5	1.114	-0.01	0.980	1.092
11	GSM850	GPRS(4 Tx slots)	Left Side	1	189	836.4	29.03	29.5	1.114	-0.01	0.918	1.023
12	GSM850	GPRS(4 Tx slots)	Right Side	1	128	824.2	29.03	29.5	1.114	0.02	0.966	1.076
13	GSM850	GPRS(4 Tx slots)	Right Side	1	189	836.4	29.03	29.5	1.114	-0.05	0.986	1.099
22	GSM1900	GPRS(4 Tx slots)	Front	1	810	1909.8	26.19	27	1.205	-0.04	0.723	0.871
23	<b>GSM1900</b>	<b>GPRS(4 Tx slots)</b>	<b>Back</b>	<b>1</b>	<b>810</b>	<b>1909.8</b>	<b>26.19</b>	<b>27</b>	<b>1.205</b>	<b>-0.04</b>	<b>0.830</b>	<b>1.000</b>
24	GSM1900	GPRS(4 Tx slots)	Left Side	1	810	1909.8	26.19	27	1.205	-0.02	0.443	0.534
25	GSM1900	GPRS(4 Tx slots)	Right Side	1	810	1909.8	26.19	27	1.205	-0.06	0.184	0.222
26	GSM1900	GPRS(4 Tx slots)	Bottom Side	1	810	1909.8	26.19	27	1.205	0.04	0.717	0.864
27	GSM1900	GPRS(4 Tx slots)	Front	1	512	1850.2	26.11	27	1.227	-0.09	0.714	0.876
28	GSM1900	GPRS(4 Tx slots)	Front	1	661	1880	26.13	27	1.222	-0.14	0.736	0.899
29	GSM1900	GPRS(4 Tx slots)	Back	1	512	1850.2	26.11	27	1.227	-0.09	0.714	0.876
30	GSM1900	GPRS(4 Tx slots)	Back	1	661	1880	26.13	27	1.222	-0.07	0.776	0.948
31	GSM1900	GPRS(4 Tx slots)	Bottom Side	1	512	1850.2	26.11	27	1.227	0.03	0.616	0.756
32	GSM1900	GPRS(4 Tx slots)	Bottom Side	1	661	1880	26.13	27	1.222	0.02	0.666	0.814



<WCDMA SAR>

Plot No.	Band	Mode	Test Position	Gap (cm)	Ch.	Freq. (MHz)	Average Power (dBm)	Tune-Up Limit (dBm)	Scaling Factor	Power Drift (dB)	Measured SAR <sub>1g</sub> (W/kg)	Reported SAR <sub>1g</sub> (W/kg)
17	WCDMA Band V	RMC 12.2K	Front	1	4182	836.4	22.31	24	1.476	-0.09	0.420	0.620
18	<b>WCDMA Band V</b>	<b>RMC 12.2K</b>	<b>Back</b>	<b>1</b>	<b>4182</b>	<b>836.4</b>	<b>22.31</b>	<b>24</b>	<b>1.476</b>	<b>-0.15</b>	<b>0.497</b>	<b>0.733</b>
19	WCDMA Band V	RMC 12.2K	Left Side	1	4182	836.4	22.31	24	1.476	-0.02	0.402	0.593
20	WCDMA Band V	RMC 12.2K	Right Side	1	4182	836.4	22.31	24	1.476	-0.01	0.467	0.689
21	WCDMA Band V	RMC 12.2K	Bottom Side	1	4182	836.4	22.31	24	1.476	-0.18	0.056	0.083
36	<b>WCDMA Band II</b>	<b>RMC 12.2K</b>	<b>Front</b>	<b>1</b>	<b>9262</b>	<b>1852.4</b>	<b>22.78</b>	<b>23.5</b>	<b>1.180</b>	<b>-0.12</b>	<b>0.771</b>	<b>0.910</b>
37	WCDMA Band II	RMC 12.2K	Back	1	9262	1852.4	22.78	23.5	1.180	-0.08	0.735	0.868
38	WCDMA Band II	RMC 12.2K	Left Side	1	9262	1852.4	22.78	23.5	1.180	-0.03	0.465	0.549
39	WCDMA Band II	RMC 12.2K	Right Side	1	9262	1852.4	22.78	23.5	1.180	0.03	0.177	0.209
40	WCDMA Band II	RMC 12.2K	Bottom Side	1	9262	1852.4	22.78	23.5	1.180	0.02	0.672	0.793
41	WCDMA Band II	RMC 12.2K	Front	1	9400	1880	22.58	23.5	1.236	-0.1	0.659	0.814
42	WCDMA Band II	RMC 12.2K	Front	1	9538	1907.6	22.37	23.5	1.297	-0.1	0.626	0.812
43	WCDMA Band II	RMC 12.2K	Back	1	9400	1880	22.58	23.5	1.236	-0.17	0.719	0.889
44	WCDMA Band II	RMC 12.2K	Back	1	9538	1907.6	22.37	23.5	1.297	-0.17	0.693	0.899

**Note:** Per KDB 941225 D01, RMC 12.2kbps setting is used to evaluate SAR. If HSDPA/DC-HSDPA/HSUPA, HSPA+ (16QAM in uplink) output power is < 0.25dB higher than RMC, or reported SAR with RMC 12.2kbps setting is ≤ 1.2W/kg, HSDPA/DC-HSDPA/HSUPA and HSPA+ (16QAM in uplink) SAR evaluation can be excluded.

<WLAN2.4GHz SAR>

Plot No.	Band	Mode	Data Rate	Test Position	Gap (cm)	Ch.	Freq. (MHz)	Average Power (dBm)	Tune-Up Limit (dBm)	Scaling Factor	Power Drift (dB)	Measured SAR <sub>1g</sub> (W/kg)	Reported SAR <sub>1g</sub> (W/kg)
65	WLAN2.4GHz	802.11b	1M	Front	1	11	2462	14.58	15	1.102	-0.16	0.070	0.077
66	<b>WLAN2.4GHz</b>	<b>802.11b</b>	<b>1M</b>	<b>Back</b>	<b>1</b>	<b>11</b>	<b>2462</b>	<b>14.58</b>	<b>15</b>	<b>1.102</b>	<b>-0.06</b>	<b>0.116</b>	<b>0.128</b>
67	WLAN2.4GHz	802.11b	1M	Left Side	1	11	2462	14.58	15	1.102	0.07	0.055	0.061
68	WLAN2.4GHz	802.11b	1M	Top Side	1	11	2462	14.58	15	1.102	-0.03	0.064	0.070

**12.3 Test Records for Body Worn SAR Test**

**Note:**

1. Body-worn SAR testing was performed at 10mm separation, and this distance is determined by the handset manufacturer that there will be body-worn accessories that users may acquire at the time of equipment certification, to enable users to purchase aftermarket body-worn accessories with the required minimum separation.
2. Per KDB 941225 D06, when the same wireless modes and device transmission configurations are required for testing body-worn accessories and hotspot mode, it is not necessary to test body-worn accessory SAR for the same device orientation if the test separation distance for hotspot mode is more conservative than that used for body-worn accessories.
3. Body-worn exposure conditions are intended to voice call operations, therefore GSM voice call mode is selected to be tested.
4. Per KDB 648474 D04v01, when the *reported* SAR for a body-worn accessory measured without a headset connected to the handset is  $\leq 1.2$  W/kg, SAR testing with a headset connected to the handset is not required.

**<GSM SAR>**

Plot No.	Band	Mode	Test Position	Gap (cm)	Ch.	Freq. (MHz)	Average Power (dBm)	Tune-Up Limit (dBm)	Scaling Factor	Power Drift (dB)	Measured SAR <sub>1g</sub> (W/kg)	Reported SAR <sub>1g</sub> (W/kg)
14	GSM850	GSM Voice	Front	1	251	848.8	32.18	33	1.208	-0.01	0.464	0.560
15	<b>GSM850</b>	<b>GSM Voice</b>	<b>Back</b>	<b>1</b>	<b>251</b>	<b>848.8</b>	<b>32.18</b>	<b>33</b>	<b>1.208</b>	<b>-0.06</b>	<b>0.548</b>	<b>0.662</b>
33	GSM1900	GSM Voice	Front	1	810	1909.8	29.24	30	1.191	-0.11	0.382	0.455
34	<b>GSM1900</b>	<b>GSM Voice</b>	<b>Back</b>	<b>1</b>	<b>810</b>	<b>1909.8</b>	<b>29.24</b>	<b>30</b>	<b>1.191</b>	<b>-0.04</b>	<b>0.406</b>	<b>0.484</b>

**<WCDMA SAR>**

Plot No.	Band	Mode	Test Position	Gap (cm)	Ch.	Freq. (MHz)	Average Power (dBm)	Tune-Up Limit (dBm)	Scaling Factor	Power Drift (dB)	Measured SAR <sub>1g</sub> (W/kg)	Reported SAR <sub>1g</sub> (W/kg)
17	WCDMA Band V	RMC 12.2K	Front	1	4182	836.4	22.31	24	1.476	-0.09	0.420	0.620
18	<b>WCDMA Band V</b>	<b>RMC 12.2K</b>	<b>Back</b>	<b>1</b>	<b>4182</b>	<b>836.4</b>	<b>22.31</b>	<b>24</b>	<b>1.476</b>	<b>-0.15</b>	<b>0.497</b>	<b>0.733</b>
36	<b>WCDMA Band II</b>	<b>RMC 12.2K</b>	<b>Front</b>	<b>1</b>	<b>9262</b>	<b>1852.4</b>	<b>22.78</b>	<b>23.5</b>	<b>1.180</b>	<b>-0.12</b>	<b>0.771</b>	<b>0.910</b>
37	WCDMA Band II	RMC 12.2K	Back	1	9262	1852.4	22.78	23.5	1.180	-0.08	0.735	0.868
41	WCDMA Band II	RMC 12.2K	Front	1	9400	1880	22.58	23.5	1.236	-0.1	0.659	0.814
42	WCDMA Band II	RMC 12.2K	Front	1	9538	1907.6	22.37	23.5	1.297	-0.1	0.626	0.812
43	WCDMA Band II	RMC 12.2K	Back	1	9400	1880	22.58	23.5	1.236	-0.17	0.719	0.889
44	WCDMA Band II	RMC 12.2K	Back	1	9538	1907.6	22.37	23.5	1.297	-0.17	0.693	0.899

**<WLAN2.4GHz SAR>**

Plot No.	Band	Mode	Data Rate	Test Position	Gap (cm)	Ch.	Freq. (MHz)	Average Power (dBm)	Tune-Up Limit (dBm)	Scaling Factor	Power Drift (dB)	Measured SAR <sub>1g</sub> (W/kg)	Reported SAR <sub>1g</sub> (W/kg)
65	WLAN2.4GHz	802.11b	1M	Front	1	11	2462	14.58	15	1.102	-0.16	0.070	0.077
66	<b>WLAN2.4GHz</b>	<b>802.11b</b>	<b>1M</b>	<b>Back</b>	<b>1</b>	<b>11</b>	<b>2462</b>	<b>14.58</b>	<b>15</b>	<b>1.102</b>	<b>-0.06</b>	<b>0.116</b>	<b>0.128</b>



12.4 Repeated SAR Measurement

Plot No.	Band	Mode	Test Position	Gap (cm)	Ch.	Freq. (MHz)	Average Power (dBm)	Tune-Up Limit (dBm)	Scaling Factor	Power Drift (dB)	Measured SAR <sub>1g</sub> (W/kg)	Reported SAR <sub>1g</sub> (W/kg)
2	GSM850	GPRS(4 Tx slots )	Back	1	251	848.8	29.04	29.5	1.112	-0.11	1.130	1.256
16	GSM850	GPRS(4 Tx slots )	Back	1	251	848.8	29.04	29.5	1.112	-0.08	1.120	1.245
23	GSM1900	GPRS(4 Tx slots )	Back	1	810	1909.8	26.19	27	1.205	-0.04	0.830	1.000
35	GSM1900	GPRS(4 Tx slots )	Back	1	810	1909.8	26.19	27	1.205	-0.07	0.766	0.923

Note:

1. Per KDB 865664 D01v01, for each frequency band, repeated SAR measurement is required only when the measured SAR is  $\geq 0.8$ W/kg
2. Per KDB 865664 D01v01, if the ratio among the repeated measurement is  $\leq 1.2$  and the measured SAR  $< 1.45$ W/kg, only one repeated measurement is required.
3. The ratio is the difference in percentage between original and repeated *measured SAR*.
4. All measurement SAR result is scaled-up to account for tune-up tolerance and is compliant.

**12.5 Highest SAR Plot**

Test Laboratory: Sporton International Inc. SAR/HAC Testing Lab

Date: 05.06.2013

02 GSM850\_GPRS(4 Tx slots)\_Back\_1cm\_Ch251

DUT: 342509

Communication System: GPRS/EDGE12; Frequency: 848.8 MHz; Duty Cycle: 1:2  
 Medium: MSL\_835\_130605 Medium parameters used:  $f = 849$  MHz;  $\sigma = 0.983$  mho/m;  $\epsilon_r = 56.369$ ;  $\rho = 1000$  kg/m<sup>3</sup>  
 Ambient Temperature : 23.5 °C; Liquid Temperature : 21.5 °C

DASY5 Configuration:

- Probe: EX3DV4 - SN3819; ConvF(9.5, 9.5, 9.5); Calibrated: 26.11.2012;
- Sensor-Surface: 2mm (Mechanical Surface Detection)
- Electronics: DAE4 Sn1303; Calibrated: 22.11.2012
- Phantom: SAM1; Type: QD000P40CD; Serial: TP:1670
- Measurement SW: DASY52, Version 52.8 (2); SEMCAD X Version 14.6.6 (6824)

**Ch251/Area Scan (61x111x1):** Interpolated grid: dx=15mm, dy=15mm  
 Maximum value of SAR (interpolated) = 1.25 W/kg

**Ch251/Zoom Scan (5x5x7)/Cube 0:** Measurement grid: dx=8mm, dy=8mm, dz=5mm  
 Reference Value = 36.529 V/m; Power Drift = -0.11 dB  
 Peak SAR (extrapolated) = 1.509 mW/g  
**SAR(1 g) = 1.130 mW/g; SAR(10 g) = 0.806 mW/g**  
 Maximum value of SAR (measured) = 1.32 W/kg

**Ch251/Zoom Scan (5x5x7)/Cube 1:** Measurement grid: dx=8mm, dy=8mm, dz=5mm  
 Reference Value = 36.529 V/m; Power Drift = -0.11 dB  
 Peak SAR (extrapolated) = 1.462 mW/g  
**SAR(1 g) = 1.11 mW/g; SAR(10 g) = 0.638 mW/g**  
 Maximum value of SAR (measured) = 1.27 W/kg

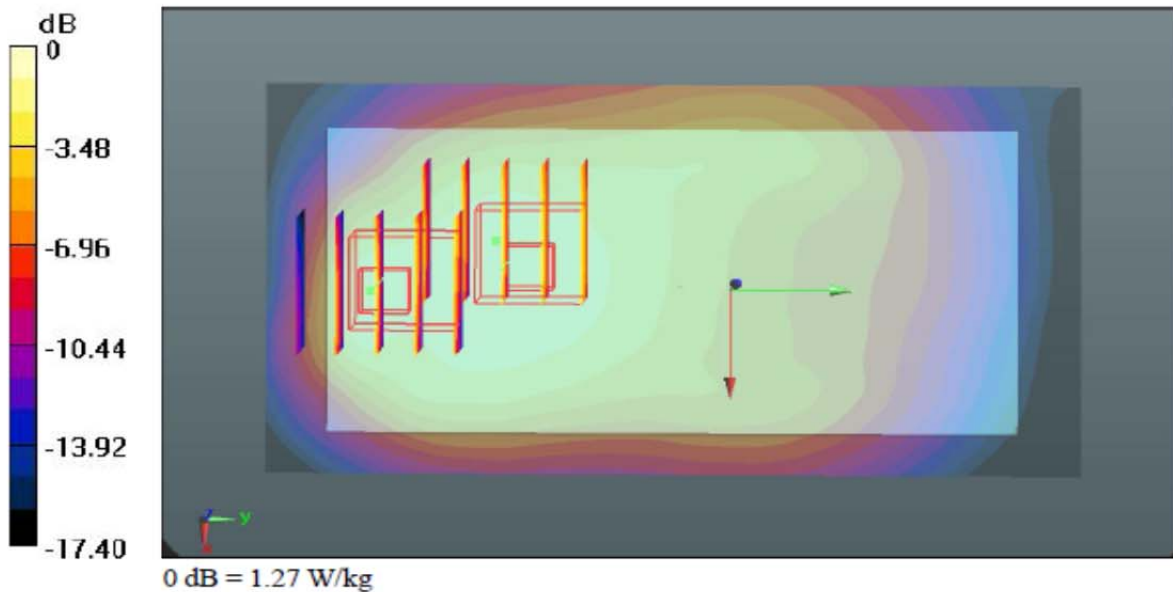



Test Laboratory: Sporton International Inc. SAR/HAC Testing Lab

Date: 05.06.2013

**23 GSM1900\_GPRS(4 Tx slots)\_Back\_1cm\_Ch810**

**DUT: 342509**

Communication System: GPRS/EDGE12; Frequency: 1909.8 MHz; Duty Cycle: 1:2  
 Medium: MSL\_1900\_130605 Medium parameters used:  $f = 1910 \text{ MHz}$ ;  $\sigma = 1.529 \text{ mho/m}$ ;  $\epsilon_r = 53.552$ ;  $\rho = 1000 \text{ kg/m}^3$   
 Ambient Temperature : 23.6 °C ; Liquid Temperature : 21.6 °C

**DASY5 Configuration:**

- Probe: EX3DV4 - SN3819; ConvF(7.67, 7.67, 7.67); Calibrated: 26.11.2012;
- Sensor-Surface: 2mm (Mechanical Surface Detection)
- Electronics: DAE4 Sn1303; Calibrated: 22.11.2012
- Phantom: SAM2; Type: QD000P40CD; Serial: TP:1671
- Measurement SW: DASY52, Version 52.8 (2); SEMCAD X Version 14.6.6 (6824)

**Ch810/Area Scan (61x111x1):** Interpolated grid: dx=15mm, dy=15mm  
 Maximum value of SAR (interpolated) = 1.06 W/kg

**Ch810/Zoom Scan (5x5x7)/Cube 0:** Measurement grid: dx=8mm, dy=8mm, dz=5mm  
 Reference Value = 27.212 V/m; Power Drift = -0.04 dB  
 Peak SAR (extrapolated) = 1.408 mW/g  
 SAR(1 g) = 0.830 mW/g; SAR(10 g) = 0.498 mW/g  
 Maximum value of SAR (measured) = 1.10 W/kg

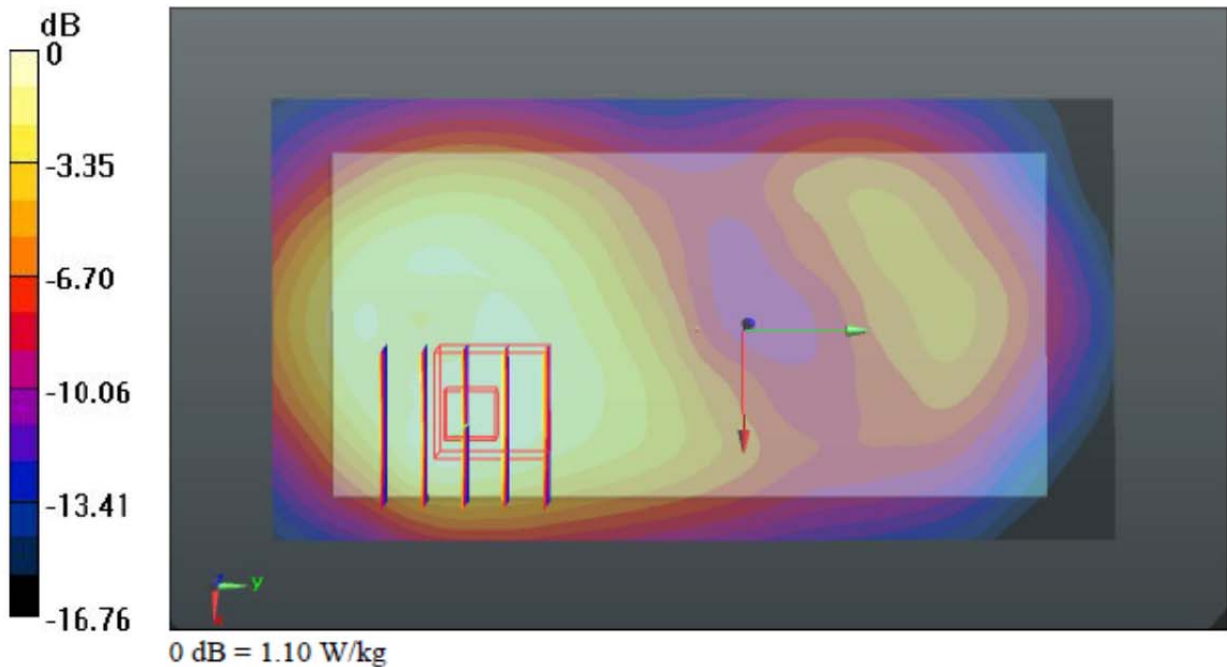

Test Laboratory: Sporton International Inc. SAR/HAC Testing Lab

Date: 05.06.2013

**18 WCDMA V\_RMC 12.2K\_Back\_1cm\_Ch4182****DUT: 342509**

Communication System: UMTS; Frequency: 836.4 MHz; Duty Cycle: 1:1

Medium: MSL\_835\_130605 Medium parameters used:  $f = 836.4$  MHz;  $\sigma = 0.972$  mho/m;  $\epsilon_r =$ 56.486;  $\rho = 1000$  kg/m<sup>3</sup>

Ambient Temperature : 23.5 °C ; Liquid Temperature : 21.5 °C

**DASY5 Configuration:**

- Probe: EX3DV4 - SN3819; ConvF(9.5, 9.5, 9.5); Calibrated: 26.11.2012;

- Sensor-Surface: 2mm (Mechanical Surface Detection)

- Electronics: DAE4 Sn1303; Calibrated: 22.11.2012

- Phantom: SAM1; Type: QD000P40CD; Serial: TP:1670

- Measurement SW: DASY52, Version 52.8 (2); SEMCAD X Version 14.6.6 (6824)

**Ch4182/Area Scan (61x111x1):** Interpolated grid: dx=15mm, dy=15mm

Maximum value of SAR (interpolated) = 0.574 W/kg

**Ch4182/Zoom Scan (5x5x7)/Cube 0:** Measurement grid: dx=8mm, dy=8mm, dz=5mm

Reference Value = 24.976 V/m; Power Drift = -0.15 dB

Peak SAR (extrapolated) = 0.638 mW/g

**SAR(1 g) = 0.497 mW/g; SAR(10 g) = 0.371 mW/g**

Maximum value of SAR (measured) = 0.571 W/kg

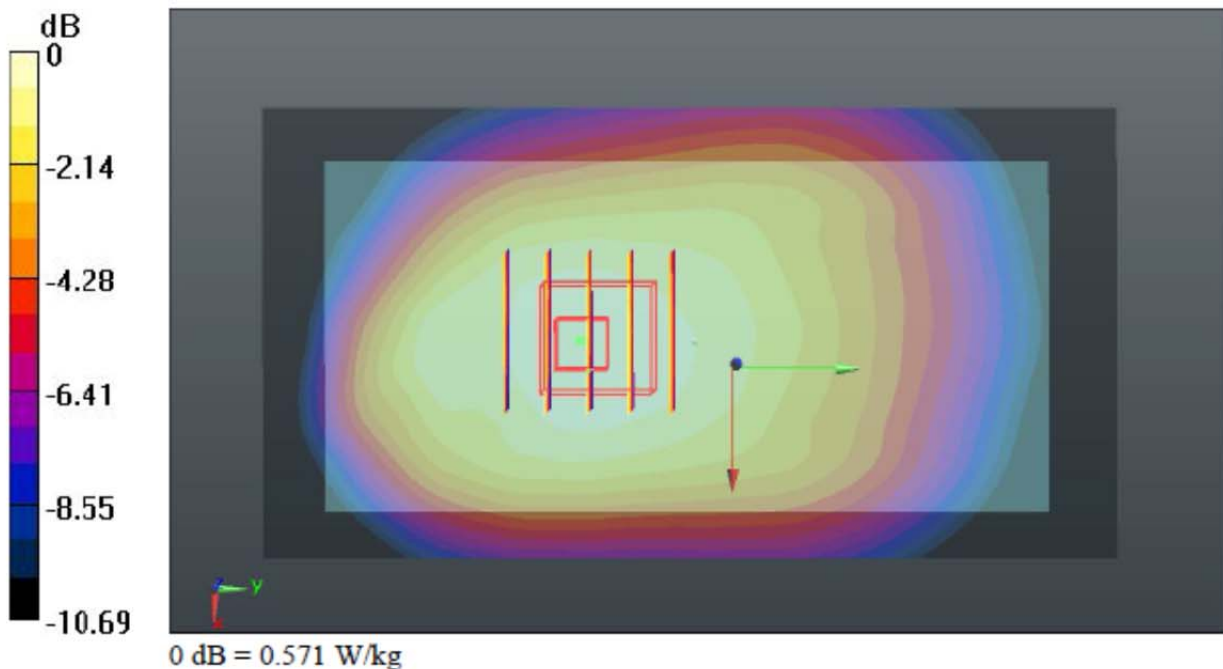

Test Laboratory: Sporton International Inc. SAR/HAC Testing Lab

Date: 05.06.2013

**36 WCDMA II\_RMC 12.2K\_Front\_1cm\_Ch9262**

**DUT: 342509**

Communication System: UMTS; Frequency: 1852.4 MHz; Duty Cycle: 1:1

Medium: MSL\_1900\_130605 Medium parameters used:  $f = 1852.4$  MHz;  $\sigma = 1.462$  mho/m;  $\epsilon_r =$

$53.584$ ;  $\rho = 1000$  kg/m<sup>3</sup>

Ambient Temperature : 23.6 °C ; Liquid Temperature : 21.6 °C

DASY5 Configuration:

- Probe: EX3DV4 - SN3819; ConvF(7.67, 7.67, 7.67); Calibrated: 26.11.2012;
- Sensor-Surface: 2mm (Mechanical Surface Detection)
- Electronics: DAE4 Sn1303; Calibrated: 22.11.2012
- Phantom: SAM2; Type: QD000P40CD; Serial: TP:1671
- Measurement SW: DASY52, Version 52.8 (2); SEMCAD X Version 14.6.6 (6824)

**Ch9262/Area Scan (61x111x1):** Interpolated grid: dx=15mm, dy=15mm

Maximum value of SAR (interpolated) = 1.01 W/kg

**Ch9262/Zoom Scan (5x5x7)/Cube 0:** Measurement grid: dx=8mm, dy=8mm, dz=5mm

Reference Value = 26.698 V/m; Power Drift = -0.12 dB

Peak SAR (extrapolated) = 1.287 mW/g

SAR(1 g) = 0.771 mW/g; SAR(10 g) = 0.469 mW/g

Maximum value of SAR (measured) = 0.996 W/kg

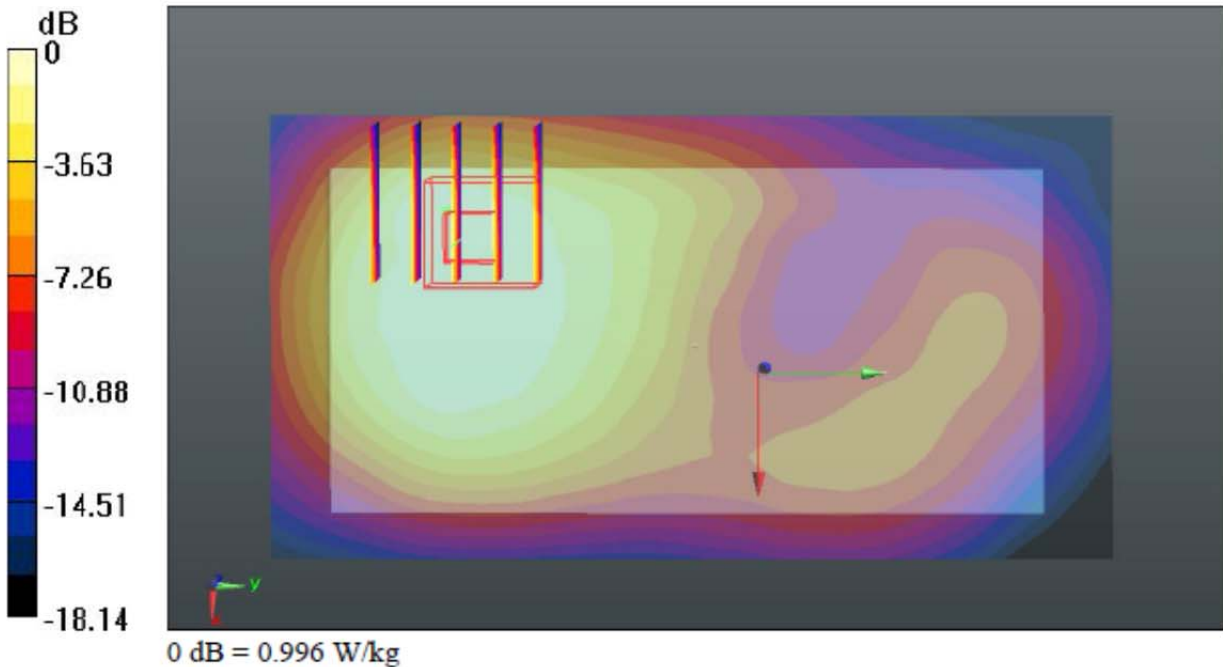



Test Laboratory: Sporton International Inc. SAR/HAC Testing Lab

Date: 07.06.2013

**61 WLAN2.4G 802.11b\_Right Cheek\_Ch11****DUT: 342509**

Communication System: WIFI; Frequency: 2462 MHz; Duty Cycle: 1:1

Medium: HSL\_2450\_130607 Medium parameters used:  $f = 2462$  MHz;  $\sigma = 1.87$  mho/m;  $\epsilon_r = 37.641$ ; $\rho = 1000$  kg/m<sup>3</sup>

Ambient Temperature : 23.6 °C; Liquid Temperature : 21.3 °C

**DASY5 Configuration:**

- Probe: EX3DV4 - SN3819; ConvF(6.99, 6.99, 6.99); Calibrated: 26.11.2012;
- Sensor-Surface: 2mm (Mechanical Surface Detection)
- Electronics: DAE4 Sn1303; Calibrated: 22.11.2012
- Phantom: SAM1; Type: QD000P40CD; Serial: TP:1670
- Measurement SW: DASY52, Version 52.8 (2); SEMCAD X Version 14.6.6 (6824)

**Ch11/Area Scan (71x141x1):** Interpolated grid: dx=12mm, dy=12mm

Maximum value of SAR (interpolated) = 0.528 W/kg

**Ch11/Zoom Scan (7x7x7)/Cube 0:** Measurement grid: dx=5mm, dy=5mm, dz=5mm

Reference Value = 17.420 V/m; Power Drift = -0.07 dB

Peak SAR (extrapolated) = 0.776 mW/g

SAR(1 g) = 0.360 mW/g; SAR(10 g) = 0.170 mW/g

Maximum value of SAR (measured) = 0.533 W/kg

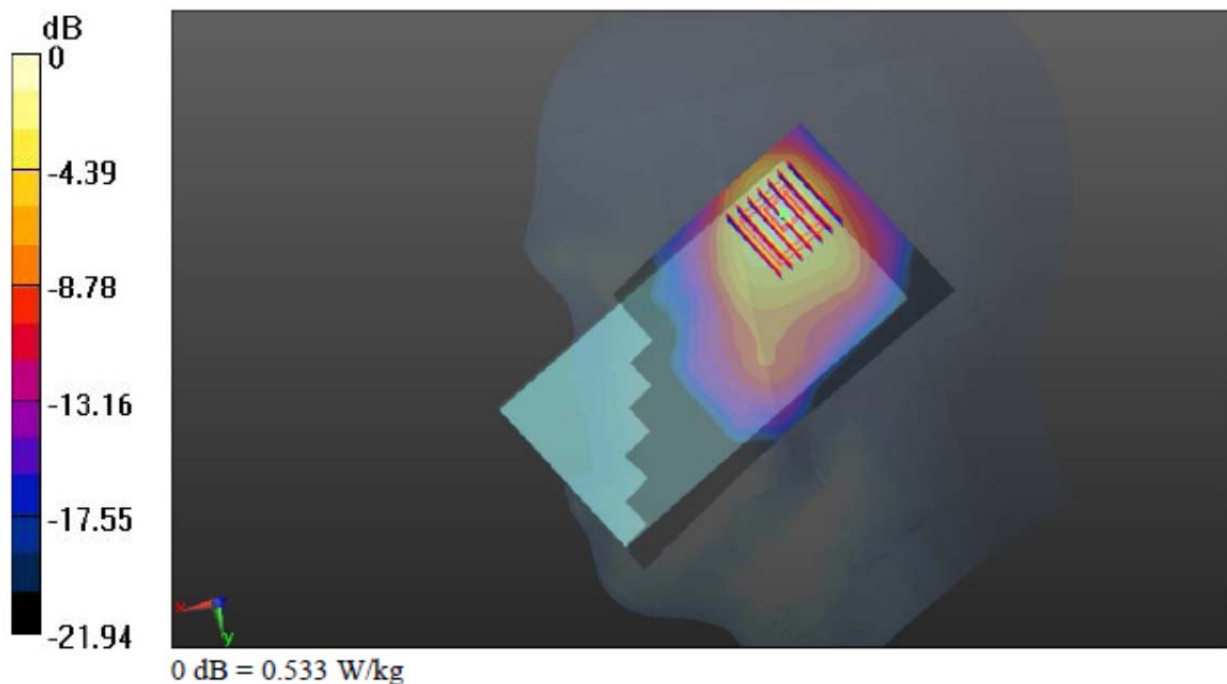

### 13. Simultaneous Transmission Analysis

NO.	Simultaneous Transmission Configurations	Phone			Note
		Head	Body-worn	Hotspot	
1.	GSM(Voice) + WLAN2.4GHz(data)	Yes	Yes	-	-
2.	WCDMA(Voice) + WLAN2.4GHz(data)	Yes	Yes	-	-
3.	GSM(Voice) + Bluetooth(data)	Yes	Yes	-	-
4.	WCDMA((Voice) + Bluetooth(data)	Yes	Yes	-	-
5.	GPRS/EDGE(Data) + WLAN2.4GHz(data)	-	-	Yes	2.4GHz Hotspot
6.	WCDMA(Data) + WLAN2.4GHz(data)	Yes	Yes	Yes	2.4GHz Hotspot
7.	GPRS/EDGE(Data) + Bluetooth(data)	-	-	Yes	Bluetooth Tethering
8.	WCDMA(Data) + Bluetooth(data)	Yes	Yes	Yes	Bluetooth Tethering

**Note:**

1. WLAN and Bluetooth share the same antenna, and cannot transmit simultaneously.
2. EUT will choose either GSM or WCDMA according to the network signal condition; therefore, they will not transmit simultaneously.
3. The Report SAR summation is calculated based on the same configuration and test position.
4. Per KDB 447498 D01v05, simultaneous transmission SAR is compliant if,
  - i) Scalar SAR summation < 1.6W/kg.
  - ii)  $SPLSR = (SAR_1 + SAR_2)^{1.5} / (min. \text{ separation distance, mm})$ , and the peak separation distance is determined from the square root of  $[(x_1-x_2)^2 + (y_1-y_2)^2 + (z_1-z_2)^2]$ , where  $(x_1, y_1, z_1)$  and  $(x_2, y_2, z_2)$  are the coordinates of the extrapolated peak SAR locations in the zoom scan  
If  $SPLSR \leq 0.04$ , simultaneously transmission SAR measurement is not necessary
  - iii) Simultaneously transmission SAR measurement, and the reported multi-band SAR < 1.6W/kg
5. For simultaneous transmission analysis, Bluetooth SAR is estimated per KDB 447498 D01v05 based on the formula below.
  - i)  $(max. \text{ power of channel, including tune-up tolerance, mW}) / (min. \text{ test separation distance, mm}) \cdot [\sqrt{f(\text{GHz})} \cdot x] \text{ W/kg}$  for test separation distances  $\leq 50 \text{ mm}$ ; where  $x = 7.5$  for 1-g SAR, and  $x = 18.75$  for 10-g SAR.
  - ii) 0.4 W/kg for 1-g SAR and 1.0 W/kg for 10-g SAR, when the test separation distances is > 50 mm.

In this report, 50mm separation is applied to conservatively estimate SAR value for separation distance > 50mm

Maximum Power	Exposure Position	Head	Hotspot 1cm	Body-worn 1cm
	Test separation	0 mm	10 mm	10 mm
8 dBm	Estimated SAR (W/kg)	0.265W/kg	0.132W/kg	0.132W/kg



13.1 Head Exposure Conditions

Position	WWAN-PCE			WLAN 2.4GHz -DTS		WWAN + WLAN SAR (W/kg)	SPLSR ≤ 0.04	Case No
	WWAN Band	Plot No	Max. WWAN SAR (W/kg)	Plot No	Max. WLAN SAR (W/kg)			
Right Cheek	GSM850	45	0.364	61	0.397	0.76		
	GSM1900	49	0.206	61	0.397	0.60		
	WCDMA Band V	53	0.367	61	0.397	0.76		
	WCDMA Band II	57	0.454	61	0.397	0.85		
Right Tilted	GSM850	46	0.209	62	0.313	0.52		
	GSM1900	50	0.132	62	0.313	0.45		
	WCDMA Band V	54	0.223	62	0.313	0.54		
	WCDMA Band II	58	0.244	62	0.313	0.56		
Left Cheek	GSM850	47	0.339	63	0.202	0.54		
	GSM1900	51	0.369	63	0.202	0.57		
	WCDMA Band V	55	0.338	63	0.202	0.54		
	WCDMA Band II	59	0.690	63	0.202	0.89		
Left Tilted	GSM850	48	0.227	64	0.202	0.43		
	GSM1900	52	0.135	64	0.202	0.34		
	WCDMA Band V	56	0.221	64	0.202	0.42		
	WCDMA Band II	60	0.243	64	0.202	0.45		

Position	WWAN-PCE			Bluetooth-DSS	WWAN + Bluetooth SAR (W/kg)	SPLSR ≤ 0.04	Case No
	WWAN Band	Plot No	Max. WWAN SAR (W/kg)	Estimated SAR (W/kg)			
Right Cheek	GSM850	45	0.364	0.265	0.63		
	GSM1900	49	0.206	0.265	0.47		
	WCDMA Band V	53	0.367	0.265	0.63		
	WCDMA Band II	57	0.454	0.265	0.72		
Right Tilted	GSM850	46	0.209	0.265	0.47		
	GSM1900	50	0.132	0.265	0.40		
	WCDMA Band V	54	0.223	0.265	0.49		
	WCDMA Band II	58	0.244	0.265	0.51		
Left Cheek	GSM850	47	0.339	0.265	0.60		
	GSM1900	51	0.369	0.265	0.63		
	WCDMA Band V	55	0.338	0.265	0.60		
	WCDMA Band II	59	0.690	0.265	0.96		
Left Tilted	GSM850	48	0.227	0.265	0.49		
	GSM1900	52	0.135	0.265	0.40		
	WCDMA Band V	56	0.221	0.265	0.49		
	WCDMA Band II	60	0.243	0.265	0.51		



**13.2 Hotspot Exposure Conditions**

Position	WWAN-PCE			WLAN 2.4GHz -DTS		WWAN + WLAN SAR (W/kg)	SPLSR ≤ 0.04	Case No
	WWAN Band	Plot No	Max. WWAN SAR (W/kg)	Plot No	Max. WLAN SAR (W/kg)			
Front	GSM850	6	1.028	65	0.077	1.11		
	GSM1900	28	0.899	65	0.077	0.98		
	WCDMA Band V	17	0.620	65	0.077	0.70		
	WCDMA Band II	36	0.910	65	0.077	0.99		
Back	GSM850	2	1.256	66	0.128	1.38		
	GSM1900	23	1.000	66	0.128	1.13		
	WCDMA Band V	18	0.733	66	0.128	0.86		
	WCDMA Band II	44	0.899	66	0.128	1.03		
Left Side	GSM850	10	1.092	67	0.061	1.15		
	GSM1900	24	0.534	67	0.061	0.60		
	WCDMA Band V	19	0.593	67	0.061	0.65		
	WCDMA Band II	38	0.549	67	0.061	0.61		
Right Side	GSM850	13	1.099			1.10		
	GSM1900	25	0.222			0.22		
	WCDMA Band V	20	0.689			0.69		
	WCDMA Band II	39	0.209			0.21		
Top Side	GSM850			68	0.070	0.07		
	GSM1900			68	0.070	0.07		
	WCDMA Band V			68	0.070	0.07		
	WCDMA Band II			68	0.070	0.07		
Bottom Side	GSM850	5	0.149			0.15		
	GSM1900	26	0.864			0.86		
	WCDMA Band V	21	0.083			0.08		
	WCDMA Band II	40	0.793			0.79		



Position	WWAN-PCE			Bluetooth-DSS	WWAN + Bluetooth SAR (W/kg)	SPLSR ≤ 0.04	Case No
	WWAN Band	Plot No	Max. WWAN SAR (W/kg)	Estimated SAR (W/kg)			
Front	GSM850	6	1.028	0.132	1.16		
	GSM1900	28	0.899	0.132	1.03		
	WCDMA Band V	17	0.620	0.132	0.75		
	WCDMA Band II	36	0.910	0.132	1.04		
Back	GSM850	2	1.256	0.132	1.39		
	GSM1900	23	1.000	0.132	1.13		
	WCDMA Band V	18	0.733	0.132	0.87		
	WCDMA Band II	44	0.899	0.132	1.03		
Left Side	GSM850	10	1.092	0.132	1.22		
	GSM1900	24	0.534	0.132	0.67		
	WCDMA Band V	19	0.593	0.132	0.73		
	WCDMA Band II	38	0.549	0.132	0.68		
Right Side	GSM850	13	1.099		1.10		
	GSM1900	25	0.222		0.22		
	WCDMA Band V	20	0.689		0.69		
	WCDMA Band II	39	0.209		0.21		
Top Side	GSM850			0.132	0.13		
	GSM1900			0.132	0.13		
	WCDMA Band V			0.132	0.13		
	WCDMA Band II			0.132	0.13		
Bottom Side	GSM850	5	0.149		0.15		
	GSM1900	26	0.864		0.86		
	WCDMA Band V	21	0.083		0.08		
	WCDMA Band II	40	0.793		0.79		

**13.3 Body-Worn Exposure Conditions**

Position	WWAN-PCE			Bluetooth-DSS		WWAN + WLAN SAR (W/kg)	SPLSR ≤ 0.04	Case No
	WWAN Band	Plot No	Max. WWAN SAR (W/kg)	Plot No	Max. WLAN SAR (W/kg)			
Front	GSM850	14	0.560	65	0.077	0.64		
	GSM1900	33	0.455	65	0.077	0.53		
	WCDMA Band V	17	0.620	65	0.077	0.70		
	WCDMA Band II	36	0.910	65	0.077	0.99		
Back	GSM850	15	0.662	66	0.128	0.79		
	GSM1900	34	0.484	66	0.128	0.61		
	WCDMA Band V	18	0.733	66	0.128	0.86		
	WCDMA Band II	44	0.899	66	0.128	1.03		

Position	WWAN-PCE			Bluetooth-DSS	WWAN + Bluetooth (W/kg)	SPLSR ≤ 0.04	Case No
	WWAN Band	Plot No	Max. WWAN SAR (W/kg)	Estimated SAR (W/kg)			
Front	GSM850	14	0.560	0.132	0.69		
	GSM1900	33	0.455	0.132	0.59		
	WCDMA Band V	17	0.620	0.132	0.75		
	WCDMA Band II	36	0.910	0.132	1.04		
Back	GSM850	15	0.662	0.132	0.79		
	GSM1900	34	0.484	0.132	0.62		
	WCDMA Band V	18	0.733	0.132	0.87		
	WCDMA Band II	44	0.899	0.132	1.03		

Test Engineer : Krin Wu

## 14. Uncertainty Assessment

The component of uncertainty may generally be categorized according to the methods used to evaluate them. The evaluation of uncertainty by the statistical analysis of a series of observations is termed a Type A evaluation of uncertainty. The evaluation of uncertainty by means other than the statistical analysis of a series of observations is termed a Type B evaluation of uncertainty. Each component of uncertainty, however evaluated, is represented by an estimated standard deviation, termed standard uncertainty, which is determined by the positive square root of the estimated variance.

A Type A evaluation of standard uncertainty may be based on any valid statistical method for treating data. This includes calculating the standard deviation of the mean of a series of independent observations; using the method of least squares to fit a curve to the data in order to estimate the parameter of the curve and their standard deviations; or carrying out an analysis of variance in order to identify and quantify random effects in certain kinds of measurement.

A type B evaluation of standard uncertainty is typically based on scientific judgment using all of the relevant information available. These may include previous measurement data, experience, and knowledge of the behavior and properties of relevant materials and instruments, manufacture’s specification, data provided in calibration reports and uncertainties assigned to reference data taken from handbooks. Broadly speaking, the uncertainty is either obtained from an outdoor source or obtained from an assumed distribution, such as the normal distribution, rectangular or triangular distributions indicated in Table 12.1

Uncertainty Distributions	Normal	Rectangular	Triangular	U-Shape
Multi-plying Factor <sup>(a)</sup>	1/k <sup>(b)</sup>	1/√3	1/√6	1/√2

(a) standard uncertainty is determined as the product of the multiplying factor and the estimated range of variations in the measured quantity

(b)  $\kappa$  is the coverage factor

**Table 14.1 Standard Uncertainty for Assumed Distribution**

The combined standard uncertainty of the measurement result represents the estimated standard deviation of the result. It is obtained by combining the individual standard uncertainties of both Type A and Type B evaluation using the usual “root-sum-squares” (RSS) methods of combining standard deviations by taking the positive square root of the estimated variances.

Expanded uncertainty is a measure of uncertainty that defines an interval about the measurement result within which the measured value is confidently believed to lie. It is obtained by multiplying the combined standard uncertainty by a coverage factor. Typically, the coverage factor ranges from 2 to 3. Using a coverage factor allows the true value of a measured quantity to be specified with a defined probability within the specified uncertainty range. For purpose of this document, a coverage factor two is used, which corresponds to confidence interval of about 95 %. The DASY uncertainty Budget is shown in the following tables.





Error Description	Uncertainty	Probability	Divisor	Ci	Ci	Standard	Standard
	Value (±%)	Distribution		(1g)	(10g)	Uncertainty (1g)	Uncertainty (10g)
<b>Measurement System</b>							
Probe Calibration	6.0	Normal	1	1	1	± 6.0 %	± 6.0 %
Axial Isotropy	4.7	Rectangular	√3	0.7	0.7	± 1.9 %	± 1.9 %
Hemispherical Isotropy	9.6	Rectangular	√3	0.7	0.7	± 3.9 %	± 3.9 %
Boundary Effects	1.0	Rectangular	√3	1	1	± 0.6 %	± 0.6 %
Linearity	4.7	Rectangular	√3	1	1	± 2.7 %	± 2.7 %
System Detection Limits	1.0	Rectangular	√3	1	1	± 0.6 %	± 0.6 %
Readout Electronics	0.3	Normal	1	1	1	± 0.3 %	± 0.3 %
Response Time	0.8	Rectangular	√3	1	1	± 0.5 %	± 0.5 %
Integration Time	2.6	Rectangular	√3	1	1	± 1.5 %	± 1.5 %
RF Ambient Noise	3.0	Rectangular	√3	1	1	± 1.7 %	± 1.7 %
RF Ambient Reflections	3.0	Rectangular	√3	1	1	± 1.7 %	± 1.7 %
Probe Positioner	0.4	Rectangular	√3	1	1	± 0.2 %	± 0.2 %
Probe Positioning	2.9	Rectangular	√3	1	1	± 1.7 %	± 1.7 %
Max. SAR Eval.	1.0	Rectangular	√3	1	1	± 0.6 %	± 0.6 %
<b>Test Sample Related</b>							
Device Positioning	2.9	Normal	1	1	1	± 2.9 %	± 2.9 %
Device Holder	3.6	Normal	1	1	1	± 3.6 %	± 3.6 %
Power Drift	5.0	Rectangular	√3	1	1	± 2.9 %	± 2.9 %
<b>Phantom and Setup</b>							
Phantom Uncertainty	4.0	Rectangular	√3	1	1	± 2.3 %	± 2.3 %
Liquid Conductivity (Target)	5.0	Rectangular	√3	0.64	0.43	± 1.8 %	± 1.2 %
Liquid Conductivity (Meas.)	2.5	Normal	1	0.64	0.43	± 1.6 %	± 1.1 %
Liquid Permittivity (Target)	5.0	Rectangular	√3	0.6	0.49	± 1.7 %	± 1.4 %
Liquid Permittivity (Meas.)	2.5	Normal	1	0.6	0.49	± 1.5 %	± 1.2 %
<b>Combined Standard Uncertainty</b>						± 11.0 %	± 10.8 %
<b>Coverage Factor for 95 %</b>						K=2	
<b>Expanded Uncertainty</b>						± 22.0 %	± 21.5 %

Table 14.2 Uncertainty Budget for frequency range 300 MHz to 3 GHz





## **15. References**

- [1] FCC 47 CFR Part 2 "Frequency Allocations and Radio Treaty Matters; General Rules and Regulations"
- [2] ANSI/IEEE Std. C95.1-1992, "IEEE Standard for Safety Levels with Respect to Human Exposure to Radio Frequency Electromagnetic Fields, 3 kHz to 300 GHz", September 1992
- [3] IEEE Std. 1528-2003, "Recommended Practice for Determining the Peak Spatial-Average Specific Absorption Rate (SAR) in the Human Head from Wireless Communications Devices: Measurement Techniques", December 2003
- [4] FCC OET Bulletin 65 (Edition 97-01) Supplement C (Edition 01-01), "Evaluating Compliance with FCC Guidelines for Human Exposure to Radiofrequency Electromagnetic Fields", June 2001
- [5] SPEAG DASY System Handbook
- [6] FCC KDB 248227 D01 v01r02, "SAR Measurement Procedures for 802.11 a/b/g Transmitters", May 2007
- [7] FCC KDB 447498 D01 v05r01, "Mobile and Portable Device RF Exposure Procedures and Equipment Authorization Policies", May 2013
- [8] FCC KDB 648474 D04 v01r01, "SAR Evaluation Considerations for Handsets with Multiple Transmitters and Antennas", May 2013
- [9] FCC KDB 941225 D03 v01, "Recommended SAR Test Reduction Procedures for GSM / GPRS / EDGE", December 2008
- [10] FCC KDB 941225 D01 v02, "SAR Measurement Procedures for 3G Devices – CDMA 2000 / Ev-Do / WCDMA / HSDPA / HSPA", October 2007
- [11] FCC KDB 941225 D02 v02r02 "3GPP R6 HSPA and R7 HSPA+ SAR Guidance", May 2013.
- [12] FCC KDB 941225 D06 v01r01, "SAR Evaluation Procedures for Portable Devices with Wireless Router Capabilities", May 2013
- [13] FCC KDB 865664 D01 v01, "SAR Measurement Requirements for 100MHz to 6 GHz", October 2012



## ***Appendix A. Plots of System Performance Check***

The plots are shown as follows.

**System Check\_Head\_835MHz\_130606**

**DUT: D835V2-SN:4d091**

Communication System: CW; Frequency: 835 MHz; Duty Cycle: 1:1

Medium: HSL\_835\_130606 Medium parameters used:  $f = 835 \text{ MHz}$ ;  $\sigma = 0.901 \text{ mho/m}$ ;  $\epsilon_r = 40.589$ ;  $\rho = 1000 \text{ kg/m}^3$

Ambient Temperature :  $23.2 \text{ }^\circ\text{C}$  ; Liquid Temperature :  $21.2 \text{ }^\circ\text{C}$

DASY5 Configuration:

- Probe: EX3DV4 - SN3819; ConvF(9.56, 9.56, 9.56); Calibrated: 26.11.2012;
- Sensor-Surface: 2mm (Mechanical Surface Detection)
- Electronics: DAE4 Sn1303; Calibrated: 22.11.2012
- Phantom: SAM2; Type: QD000P40CD; Serial: TP:1671
- Measurement SW: DASY52, Version 52.8 (2); SEMCAD X Version 14.6.6 (6824)

**Pin=250mW/Area Scan (61x61x1):** Interpolated grid:  $dx=15\text{mm}$ ,  $dy=15\text{mm}$

Maximum value of SAR (interpolated) =  $3.18 \text{ W/kg}$

**Pin=250mW/Zoom Scan (5x5x7)/Cube 0:** Measurement grid:  $dx=8\text{mm}$ ,  $dy=8\text{mm}$ ,  $dz=5\text{mm}$

Reference Value =  $60.209 \text{ V/m}$ ; Power Drift =  $0.02 \text{ dB}$

Peak SAR (extrapolated) =  $3.795 \text{ mW/g}$

**SAR(1 g) =  $2.51 \text{ mW/g}$ ; SAR(10 g) =  $1.64 \text{ mW/g}$**

Maximum value of SAR (measured) =  $3.19 \text{ W/kg}$

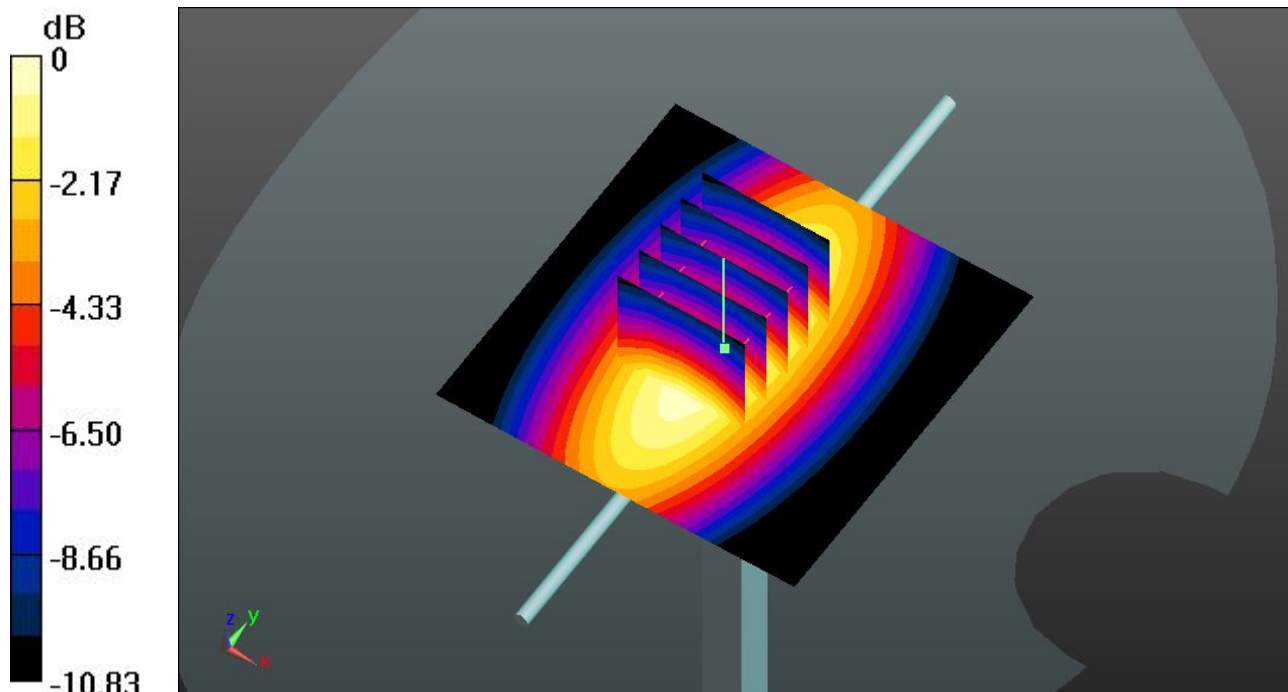

0 dB =  $3.19 \text{ W/kg}$

**System Check\_Head\_1900MHz\_130606**

**DUT: D1900V2-SN:5d118**

Communication System: CW; Frequency: 1900 MHz; Duty Cycle: 1:1

Medium: HSL\_1900\_130606 Medium parameters used:  $f = 1900$  MHz;  $\sigma = 1.407$  mho/m;  $\epsilon_r =$

$39.644$ ;  $\rho = 1000$  kg/m<sup>3</sup>

Ambient Temperature : 23.5 °C ; Liquid Temperature : 21.8 °C

DASY5 Configuration:

- Probe: EX3DV4 - SN3819; ConvF(7.84, 7.84, 7.84); Calibrated: 26.11.2012;
- Sensor-Surface: 2mm (Mechanical Surface Detection)
- Electronics: DAE4 Sn1303; Calibrated: 22.11.2012
- Phantom: SAM2; Type: QD000P40CD; Serial: TP:1671
- Measurement SW: DASY52, Version 52.8 (2); SEMCAD X Version 14.6.6 (6824)

**Pin=250mW/Area Scan (61x61x1):** Interpolated grid: dx=15mm, dy=15mm

Maximum value of SAR (interpolated) = 14.5 W/kg

**Pin=250mW/Zoom Scan (5x5x7)/Cube 0:** Measurement grid: dx=8mm, dy=8mm, dz=5mm

Reference Value = 101.9 V/m; Power Drift = 0.01 dB

Peak SAR (extrapolated) = 18.638 mW/g

**SAR(1 g) = 10 mW/g; SAR(10 g) = 5.15 mW/g**

Maximum value of SAR (measured) = 14.0 W/kg

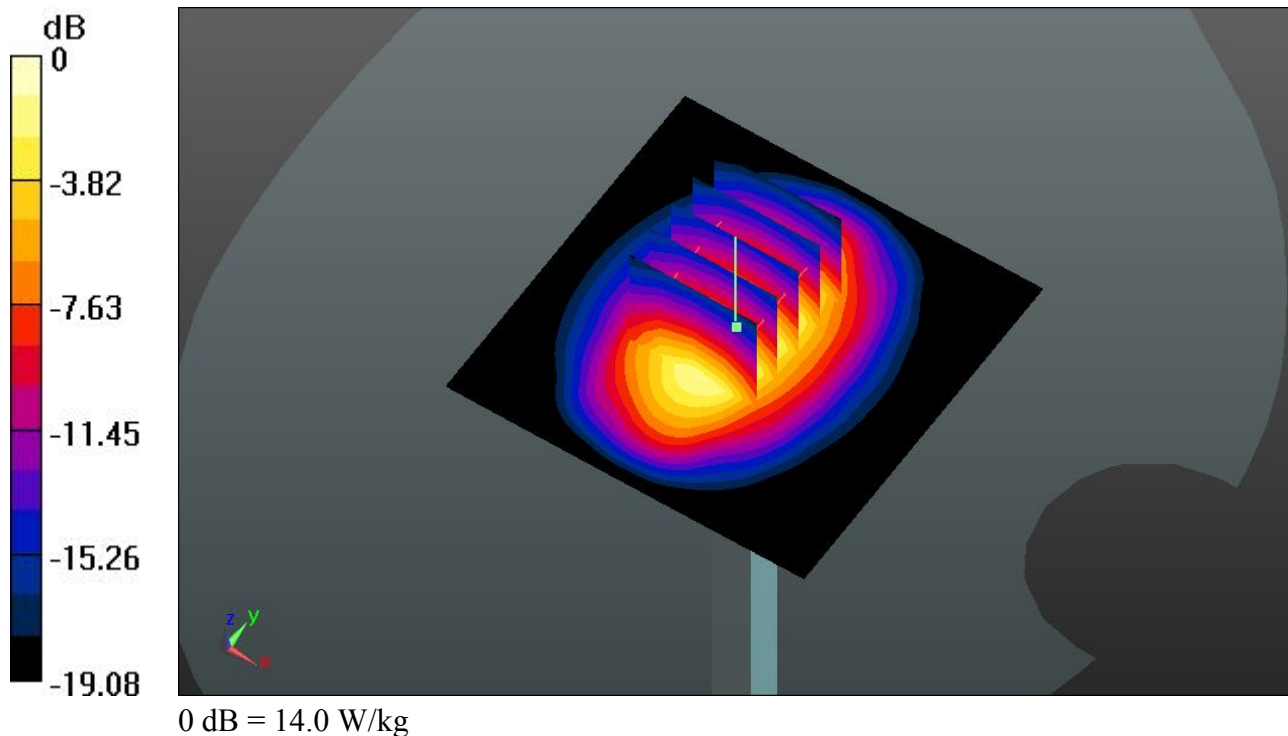

**System Check\_Head\_2450MHz\_130607**

**DUT: D2450V2-SN:736**

Communication System: CW; Frequency: 2450 MHz; Duty Cycle: 1:1

Medium: HSL\_2450\_130607 Medium parameters used:  $f = 2450$  MHz;  $\sigma = 1.856$  mho/m;  $\epsilon_r =$

$37.685$ ;  $\rho = 1000$  kg/m<sup>3</sup>

Ambient Temperature : 23.6 °C ; Liquid Temperature : 21.3 °C

DASY5 Configuration:

- Probe: EX3DV4 - SN3819; ConvF(6.99, 6.99, 6.99); Calibrated: 26.11.2012;
- Sensor-Surface: 2mm (Mechanical Surface Detection)
- Electronics: DAE4 Sn1303; Calibrated: 22.11.2012
- Phantom: SAM1; Type: QD000P40CD; Serial: TP:1670
- Measurement SW: DASY52, Version 52.8 (2); SEMCAD X Version 14.6.6 (6824)

**Pin=250mW/Area Scan (81x81x1):** Interpolated grid: dx=12mm, dy=12mm

Maximum value of SAR (interpolated) = 21.9 W/kg

**Pin=250mW/Zoom Scan (7x7x7)/Cube 0:** Measurement grid: dx=5mm, dy=5mm, dz=5mm

Reference Value = 93.333 V/m; Power Drift = -0.01 dB

Peak SAR (extrapolated) = 30.492 mW/g

**SAR(1 g) = 14.2 mW/g; SAR(10 g) = 6.46 mW/g**

Maximum value of SAR (measured) = 22.2 W/kg

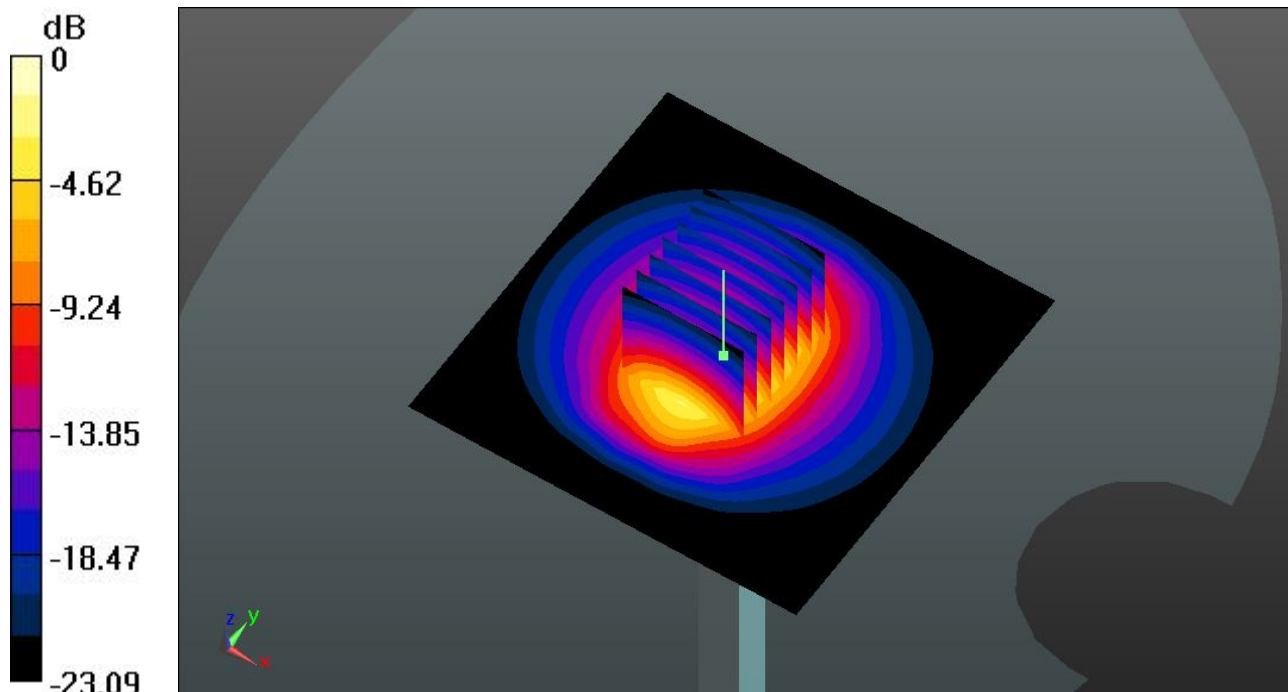

0 dB = 22.2 W/kg

**System Check\_Body\_835MHz\_130605**

**DUT: D835V2-SN:4d091**

Communication System: CW; Frequency: 835 MHz; Duty Cycle: 1:1

Medium: MSL\_835\_130605 Medium parameters used:  $f = 835 \text{ MHz}$ ;  $\sigma = 0.97 \text{ mho/m}$ ;  $\epsilon_r = 56.499$ ;  $\rho = 1000 \text{ kg/m}^3$

Ambient Temperature :  $23.5 \text{ }^\circ\text{C}$  ; Liquid Temperature :  $21.5 \text{ }^\circ\text{C}$

DASY5 Configuration:

- Probe: EX3DV4 - SN3819; ConvF(9.5, 9.5, 9.5); Calibrated: 26.11.2012;
- Sensor-Surface: 2mm (Mechanical Surface Detection)
- Electronics: DAE4 Sn1303; Calibrated: 22.11.2012
- Phantom: SAM1; Type: QD000P40CD; Serial: TP:1670
- Measurement SW: DASY52, Version 52.8 (2); SEMCAD X Version 14.6.6 (6824)

**Pin=250mW/Area Scan (61x61x1):** Interpolated grid:  $dx=15\text{mm}$ ,  $dy=15\text{mm}$

Maximum value of SAR (interpolated) =  $2.64 \text{ W/kg}$

**Pin=250mW/Zoom Scan (5x5x7)/Cube 0:** Measurement grid:  $dx=8\text{mm}$ ,  $dy=8\text{mm}$ ,  $dz=5\text{mm}$

Reference Value =  $52.277 \text{ V/m}$ ; Power Drift =  $0.01 \text{ dB}$

Peak SAR (extrapolated) =  $3.583 \text{ mW/g}$

**SAR(1 g) =  $2.45 \text{ mW/g}$ ; SAR(10 g) =  $1.62 \text{ mW/g}$**

Maximum value of SAR (measured) =  $2.63 \text{ W/kg}$

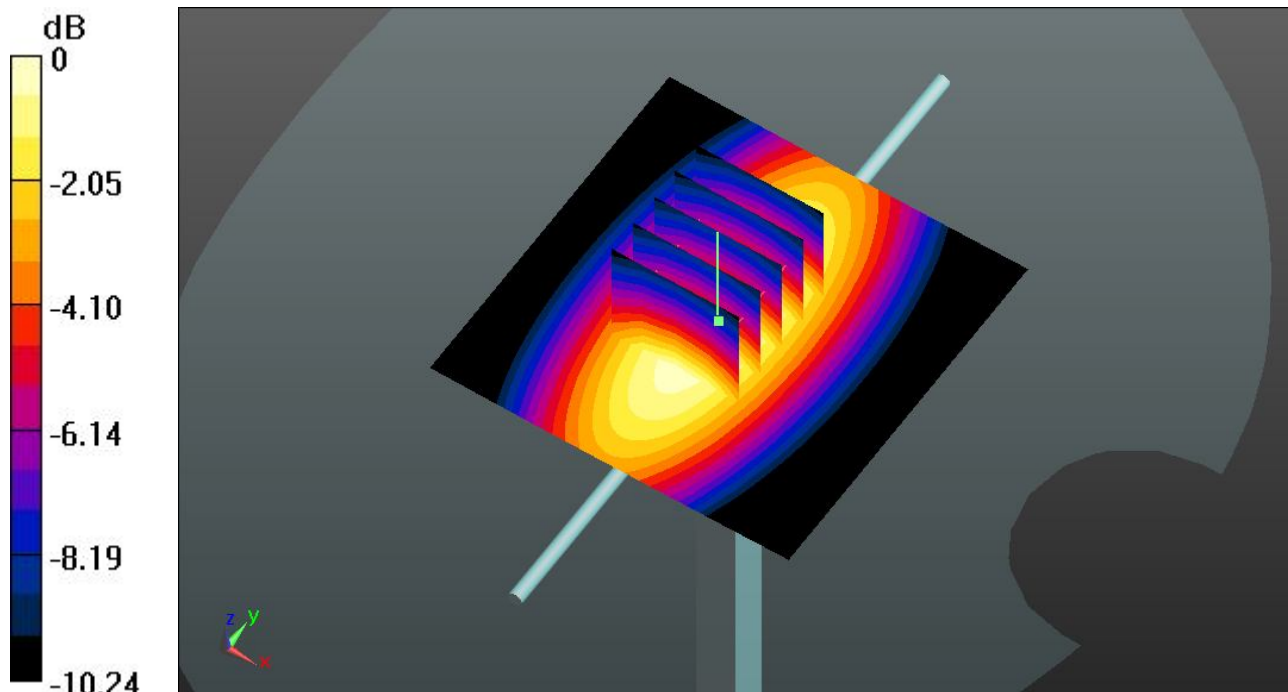

0 dB =  $2.63 \text{ W/kg}$

**System Check\_Body\_1900MHz\_130605**

**DUT: D1900V2-SN:5d118**

Communication System: CW; Frequency: 1900 MHz; Duty Cycle: 1:1

Medium: MSL\_1900\_130605 Medium parameters used:  $f = 1900$  MHz;  $\sigma = 1.519$  mho/m;  $\epsilon_r =$

$53.569$ ;  $\rho = 1000$  kg/m<sup>3</sup>

Ambient Temperature : 23.6 °C ; Liquid Temperature : 21.6 °C

DASY5 Configuration:

- Probe: EX3DV4 - SN3819; ConvF(7.67, 7.67, 7.67); Calibrated: 26.11.2012;
- Sensor-Surface: 2mm (Mechanical Surface Detection)
- Electronics: DAE4 Sn1303; Calibrated: 22.11.2012
- Phantom: SAM2; Type: QD000P40CD; Serial: TP:1671
- Measurement SW: DASY52, Version 52.8 (2); SEMCAD X Version 14.6.6 (6824)

**Pin=250mW/Area Scan (61x61x1):** Interpolated grid: dx=15mm, dy=15mm

Maximum value of SAR (interpolated) = 14.4 W/kg

**Pin=250mW/Zoom Scan (5x5x7)/Cube 0:** Measurement grid: dx=8mm, dy=8mm, dz=5mm

Reference Value = 85.872 V/m; Power Drift = 0.04 dB

Peak SAR (extrapolated) = 18.338 mW/g

**SAR(1 g) = 10.1 mW/g; SAR(10 g) = 5.24 mW/g**

Maximum value of SAR (measured) = 14.5 W/kg

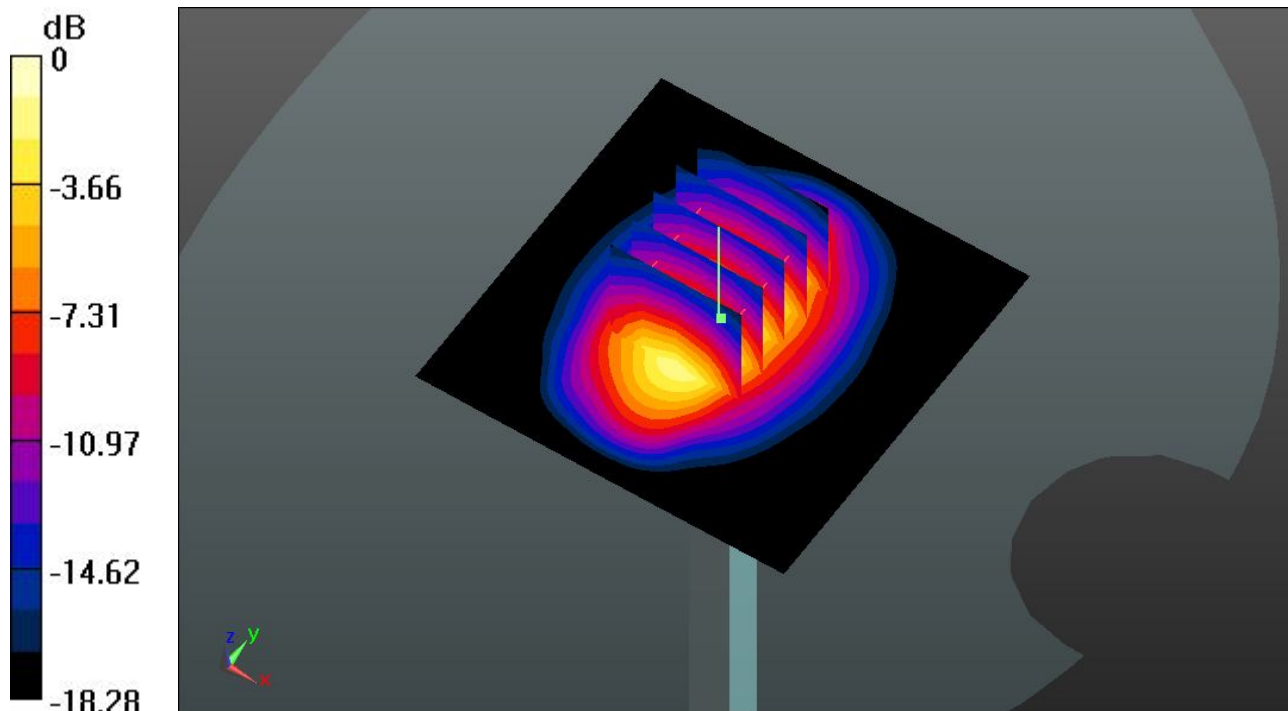

0 dB = 14.5 W/kg



**System Check\_Body\_2450MHz\_130607**

**DUT: D2450V2-SN:736**

Communication System: CW; Frequency: 2450 MHz; Duty Cycle: 1:1

Medium: MSL\_2450\_130607 Medium parameters used:  $f = 2450$  MHz;  $\sigma = 1.939$  mho/m;  $\epsilon_r = 53.98$ ;

$\rho = 1000$  kg/m<sup>3</sup>

Ambient Temperature : 23.9 °C ; Liquid Temperature : 21.9 °C

DASY5 Configuration:

- Probe: EX3DV4 - SN3819; ConvF(7.21, 7.21, 7.21); Calibrated: 26.11.2012;
- Sensor-Surface: 2mm (Mechanical Surface Detection)
- Electronics: DAE4 Sn1303; Calibrated: 22.11.2012
- Phantom: SAM2; Type: QD000P40CD; Serial: TP:1671
- Measurement SW: DASY52, Version 52.8 (2); SEMCAD X Version 14.6.6 (6824)

**Pin=250mW/Area Scan (81x81x1):** Interpolated grid: dx=12mm, dy=12mm

Maximum value of SAR (interpolated) = 20.5 W/kg

**Pin=250mW/Zoom Scan (7x7x7)/Cube 0:** Measurement grid: dx=5mm, dy=5mm, dz=5mm

Reference Value = 87.992 V/m; Power Drift = 0.01 dB

Peak SAR (extrapolated) = 28.039 mW/g

**SAR(1 g) = 13.3 mW/g; SAR(10 g) = 6.1 mW/g**

Maximum value of SAR (measured) = 20.5 W/kg

