

COMOSAR Dipole 1800 MHz Calibration Report



Ref: CR-280-5-08-SATB-B

Page: 1/6

Issue: B

Date: 2010/10/05

DIPOLE 1800 MHZ CALIBRATION REPORT

Prepared By: LUC Jérôme, SATIMO
Project Description: SAR TEST BENCH
Prepared For (End User): Shenzhen Morlab Communication Technology

This document is issued by SATIMO, in confidence and is not to be reproduced in whole or in part without the prior written permission. The information contained herein is to be used only for the purpose for which it is submitted and is not to be released in whole or in part without the prior written permission of SATIMO.

COMOSAR Dipole 1800 MHz Calibration Report



Ref: CR-280-5-08-SATB-B

Page: 2/6

Issue: B

Date: 2010/10/05

DIPOLE 1800 MHz CALIBRATION REPORT

DATE: 19/02/2009

REFERENCE: SN 36/08 DIPF101

OBJECT: COMOSAR IEEE REFERENCE DIPOLE

MANUFACTURER: SATIMO

SERIAL NUMBER: SN 36/08 DIPF101

CUSTOMER: Shenzhen Morlab Communication Technology

CONTRACT: PF2130108b_SAR_Morlab

DATE OF CALIBRATION: 23/09/2010

WARRANTY:

This Calibration certificate may not be reproduced other than in full. Calibration certificates without signature and seal are not valid. This documentation contains property information which is protected by copyright. All right are reserved. No part of this document may be photocopied, reproduced without the prior written agreement of SATIMO. SATIMO shall not be liable for errors contained herein or for incidental or consequential in connection with the furnishing, performance or use of this material. Warranty doesn't apply to Normal wear, Normal tear, Improper use, Improper maintain, Improper installation.

Date

2010/10/05

SAR TEAM MANAGER

JS

SATIMO Bretagne
Technopôle Brest Iroise
Zone du Vernis
225 rue Pierre Rivoalon
29200 BREST

COMOSAR Dipole 1800 MHz Calibration Report



Ref: CR-280-5-08-SATB-B

Page: 3/6

Issue: B

Date: 2010/10/05

PRODUCT DESCRIPTION

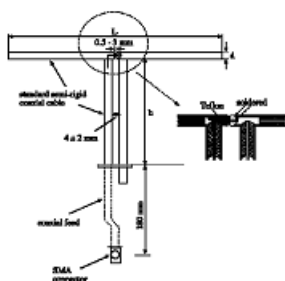

Dimension: L=72 mm/ h=41.7 mm / d=3.6 mm

CALIBRATION TEST EQUIPMENT

TYPE	IDENTIFICATION	DATE OF CALIBRATION
Vector Network Analyzer	HP8753D (SN: 5410A08882)	10-05-2010

MEASUREMENT PROCEDURE

We placed the dipole under the flat part of SAM phantom fill with 1800 MHz head liquid.

COMOSAR Dipole 1800 MHz Calibration Report



Ref: CR-280-5-08-SATB-B

Page: 4/6

Issue: B

Date: 2010/10/05

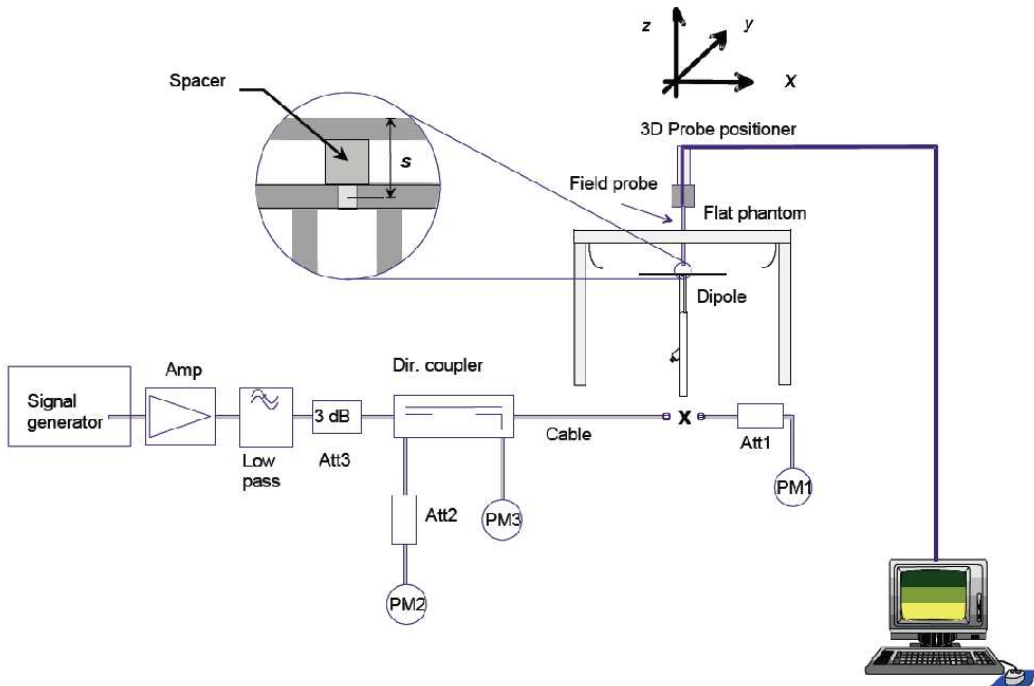

Calibration was performed according to IEEE Std P1528-2003 and OET bulletin 65 Supplement C (Ed. 01-01)

VSWR at 1800 MHz: -25.09 dB

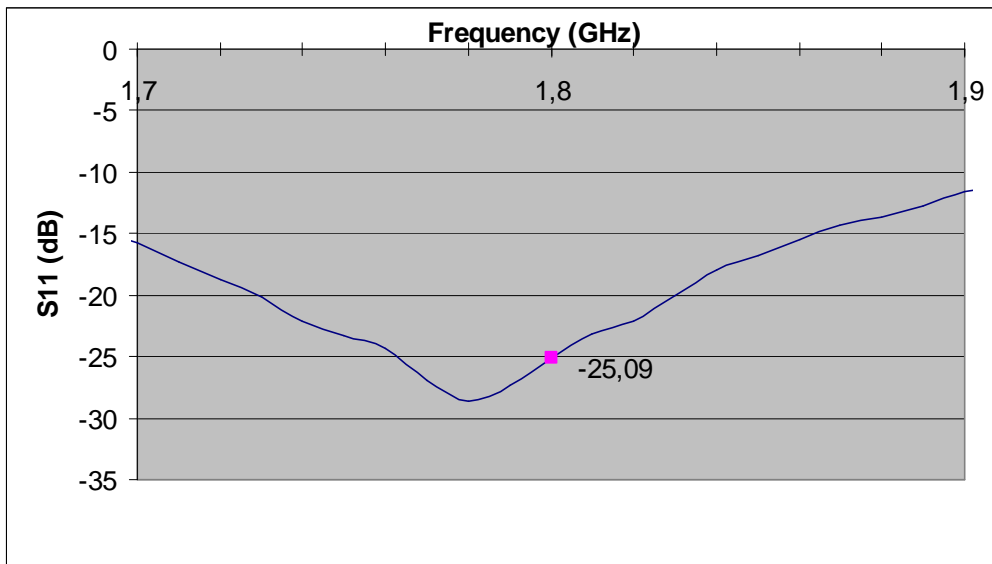

COMOSAR Dipole 1800 MHz Calibration Report



Ref: CR-280-5-08-SATB-B

Page: 5/6

Issue: B

Date: 2010/10/05

SAR MEASUREMENT EQUIPEMENT

Voltmeter	Keithley (2000, SN:1000572)	Date of calibration: 01-07-2010
Signal generator	Rohde&Schwarz (SML_03, SN:101868)	Date of calibration: 15-11-2009
Power amplifier	Nuclétudes (ALB216, SN:10800)	Date of calibration: 24-10-2009
Power meter	Rohde&Schwarz (NRVD, SN:101066)	Date of calibration: 04-07-2010
Probe	SATIMO Bretagne (SN:EP37) CF (35.35,34.93,37.42)	Date of calibration: 19-06-2010

SAR MEASUREMENT CONDITION

Software	OpenSAR V3
Phantom	SATIMO Bretagne (SN: SN_20_07_SAM42)
Liquid	SATIMO Bretagne (Last Calibration: 19 09 08) Head Liquid Values: eps' : 39,80 sigma : 1,45
Distance between the center of the dipole and the liquid (set with a spacer)	10 mm
Area scan resolution	dx=8mm/dy=8mm
Zoom scan resolution	dx=8mm/dy=8m/dz=5mm
Frequency	1800 MHz
Input power	30 dBm
Expanded uncertainty (K=1)	8.09%

SAR MEASUREMENT RESULT

	10g	1g
SAR measured	20,05 W/Kg	39,32 W/Kg
Liquid : HL	+ 1,24 %	+ 3,20 %
Input power : 1W		

COMOSAR Dipole 1800 MHz Calibration Report



Ref: CR-280-5-08-SATB-B

Page: 6/6

Issue: B

Date: 2010/10/05

SAR MEASUREMENT PLOTS

