

FCC TEST REPORT (PART 22)

REPORT NO.: RF140804N016-4
MODEL NO.: Lenovo A606
FCC ID: YCNA606
RECEIVED: Aug. 04, 2014
TESTED: Aug. 04, 2014 ~ Aug. 21, 2014
ISSUED: Aug. 22, 2014

APPLICANT: Lenovo Mobile Communication Technology Ltd.

ADDRESS: No.999, Qishan North 2nd Road, Information &
Optoelectronics Park, Torch Hi-tech Industry Development
Zone, Xiamen, P.R.China

ISSUED BY: Bureau Veritas Shenzhen Co., Ltd. Dongguan
Branch

LAB ADDRESS: No. 34, Chenwulu Section, Guantai Road, Houjie
Town, Dongguan City, Guangdong 523942, China

TEST LOCATION: No. 34, Chenwulu Section, Guantai Road, Houjie
Town, Dongguan City, Guangdong 523942, China

This report should not be used by the client to claim
product certification, approval, or endorsement by A2LA
or any government agencies.

This report is for your exclusive use. Any copying or replication of this report to or for any other person or entity, or use of our name or trademark, is permitted only with our prior written permission. This report sets forth our findings solely with respect to the test samples identified herein. The results set forth in this report are not indicative or representative of the quality or characteristics of the lot from which a test sample was taken or any similar or identical product unless specifically and expressly noted. Our report includes all of the tests requested by you and the results thereof based upon the information that you provided to us. You have 60 days from date of issuance of this report to notify us of any material error or omission caused by our negligence, provided, however, that such notice shall be in writing and shall specifically address the issue you wish to raise. A failure to raise such issue within the prescribed time shall constitute your unqualified acceptance of the completeness of this report, the tests conducted and the correctness of the report contents. Unless specific mention, the uncertainty of measurement has been explicitly taken into account to declare the compliance or non-compliance to the specification.



TABLE OF CONTENTS

RELEASE CONTROL RECORD 4

1 CERTIFICATION 5

2 SUMMARY OF TEST RESULTS 6

2.1 MEASUREMENT UNCERTAINTY 6

2.2 TEST SITE AND INSTRUMENTS 7

3 GENERAL INFORMATION 8

3.1 GENERAL DESCRIPTION OF EUT 8

3.2 CONFIGURATION OF SYSTEM UNDER TEST 10

3.3 DESCRIPTION OF SUPPORT UNITS 11

3.4 TEST ITEM AND TEST CONFIGURATION 11

3.5 EUT OPERATING CONDITIONS 13

3.6 GENERAL DESCRIPTION OF APPLIED STANDARDS 13

4 TEST TYPES AND RESULTS 14

4.1 OUTPUT POWER MEASUREMENT 14

4.1.1 LIMITS OF OUTPUT POWER MEASUREMENT 14

4.1.2 TEST PROCEDURES 14

4.1.3 TEST SETUP 15

4.1.4 TEST RESULTS 16

4.2 FREQUENCY STABILITY MEASUREMENT 18

4.2.1 LIMITS OF FREQUENCY STABILITY MEASUREMENT 18

4.2.2 TEST PROCEDURE 18

4.2.3 TEST SETUP 18

4.2.4 TEST RESULTS 19

4.3 OCCUPIED BANDWIDTH MEASUREMENT 20

4.3.1 TEST PROCEDURES 20

4.3.2 TEST SETUP 20

4.3.3 TEST RESULTS 21

4.4 BAND EDGE MEASUREMENT 23

4.4.1 LIMITS OF BAND EDGE MEASUREMENT 23

4.4.2 TEST SETUP 23

4.4.3 TEST PROCEDURES 23

4.4.4 TEST RESULTS 24

4.5 CONDUCTED SPURIOUS EMISSIONS 25

4.5.1 LIMITS OF CONDUCTED SPURIOUS EMISSIONS MEASUREMENT 25

4.5.2 TEST PROCEDURE 25

4.5.3 TEST SETUP 25

4.5.4 TEST RESULTS 26

4.6 RADIATED EMISSION MEASUREMENT 29

4.6.1 LIMITS OF RADIATED EMISSION MEASUREMENT 29

4.6.2 TEST PROCEDURES 29

4.6.3 DEVIATION FROM TEST STANDARD 29

4.6.4 TEST SETUP 30

4.6.5 TEST RESULTS 31

5 PHOTOGRAPHS OF THE TEST CONFIGURATION 37



**BUREAU
VERITAS**

Test Report No.: RF140804N016-4

6	INFORMATION ON THE TESTING LABORATORIES	38
7	APPENDIX A – MODIFICATIONS RECORDERS FOR ENGINEERING CHANGES TO THE EUT BY THE LAB	39



Test Report No.: RF140804N016-4

RELEASE CONTROL RECORD

ISSUE NO.	REASON FOR CHANGE	DATE ISSUED
RF140804N016-4	Original release	Aug. 22, 2014



Test Report No.: RF140804N016-4

1 CERTIFICATION

PRODUCT: Lenovo Mobile Phone
MODEL: Lenovo A606
BRAND: lenovo
APPLICANT: Lenovo Mobile Communication Technology Ltd.
TESTED: Aug. 04, 2014 ~ Aug. 21, 2014
TEST SAMPLE: ENGINEERING SAMPLE
STANDARDS: FCC PART 22, Subpart H

The above equipment has been tested by **Bureau Veritas Shenzhen Co., Ltd. Dongguan Branch**, and found compliance with the requirement of the above standards. The test record, data evaluation & Equipment Under Test (EUT) configurations represented herein are true and accurate accounts of the measurements of the sample's EMC characteristics under the conditions specified in this report.

TESTED BY :  _____ **DATE** : Aug. 22, 2014
Glyn He/ Project Engineer

APPROVED BY :  _____ **DATE** : Aug. 22, 2014
Sam Tung / Technical Manager

2 SUMMARY OF TEST RESULTS

The EUT has been tested according to the following specifications:

APPLIED STANDARD: FCC Part 22 & Part 2			
STANDARD SECTION	1.1.1.1.1 TEST TYPE	RESULT	REMARK
2.1046 22.913 (a)	Effective Radiated Power	PASS	Meet the requirement of limit.
2.1055 22.355	Frequency Stability	PASS	Meet the requirement of limit.
2.1049	Occupied Bandwidth	PASS	Meet the requirement of limit.
22.917	Band Edge Measurements	PASS	Meet the requirement of limit.
2.1051 22.917	Conducted Spurious Emissions	PASS	Meet the requirement of limit.
2.1053 22.917	Radiated Spurious Emissions	PASS	Meet the requirement of limit. Minimum passing margin is -23.46dB at 1672MHz.

2.1 MEASUREMENT UNCERTAINTY

Where relevant, the following measurement uncertainty levels have been estimated for tests performed on the EUT as specified in CISPR 16-4-2:

MEASUREMENT	FREQUENCY	UNCERTAINTY
Conducted emissions	9kHz~30MHz	2.67dB
Radiated emissions	9KHz ~ 30MHz	2.74dB
	30MHz ~ 1GHz	4.06dB
	1GHz ~ 18GHz	4.58dB
	18GHz ~ 40GHz	1.94dB

This uncertainty represents an expanded uncertainty expressed at approximately the 95% confidence level using a coverage factor of k=2.

2.2 TEST SITE AND INSTRUMENTS

Equipment	Manufacturer	Model No.	Serial No.	Last Cal.	Next Cal.
Spectrum Analyzer	Agilent	E4446A	MY46180622	Apr. 29,14	Apr. 28,15
Spectrum Analyzer (10Hz~40GHz)	Rohde&Schwarz	FSV40	101003	Apr. 09,14	Apr. 08,15
Signal Analyzer	Rohde&Schwarz	FSV7	102331	Nov. 25,13	Nov. 24,14
EMI Test Receiver	Rohde&Schwarz	ESVD	ESVS10	May 18,14	May 17,15
Loop antenna (9kHz~30MHz)	Daze	ZN30900A	0708	Nov. 28,13	Nov. 27,14
Bilog Antenna (20MHz~2GHz)	Teseq	CBL 6111D	30643	Jul. 27, 14	Jul. 26, 15
Horn Antenna (1GHz -18GHz)	ETS -Lindgren	3117	00062558	Oct. 18, 12	Oct. 17, 14
Horn Antenna (15GHz-40GHz)	SCHWARZBECK	BBHA 9170	BBHA9170242	Feb. 13,14	Feb. 12,15
Signal Amplifier	Agilent	8447D	2944A10488	Jun. 25,14	Jun. 24,15
Pre-Amplifier (100MHz-26.5GHz)	Agilent	8449B	3008A00409	May 13,14	May 12,15
Pre-Amplifier (18GHz-40GHz)	EMCI	EMC 184045	980102	Nov. 04,13	Nov. 03,14
Digital Multimeter	FLUKE	15B	A1220010DG	Oct. 30, 13	Oct. 29, 14
Power Sensor	Anritsu	MA2411B	1126068	Feb. 21,14	Feb. 20,15
Power Meter	Anritsu	ML2495A	1139001	Feb. 21,14	Feb. 20,15
3m Semi-anechoic Chamber	ETS-LINDGREN	9m*6m*6m	NSEMC003	Apr. 19,14	Apr. 18,15
Humid & Temp Programmable Tester	Haida	HD-2257	110807201	Sep. 17,13	Sep. 16,14
Universal Radio Communication Tester	Rohde&Schwarz	CMU 200	123259	Apr. 16,13	Apr. 15,15
RADIO COMMUNICATION ANALYZER	Anritsu	8820C	6201300716	Sep. 26,13	Sep. 26,14
Test Software	ADT	ADT_Radiated V7.6.15.9.2	N/A	N/A	N/A

- NOTE:**
1. The calibration interval of the above test instruments is 12 months or 24 months and the calibrations are traceable to CEPREI/CHINA, GRGT/CHINA and NIM/CHINA.
 2. The test was performed in Dongguan 966 Chamber
 3. The horn antenna are used only for the measurement of emission frequency above 1GHz if tested.
 4. The FCC Site Registration No. is 494399.

3 GENERAL INFORMATION

3.1 GENERAL DESCRIPTION OF EUT

EUT	Lenovo Mobile Phone	
MODEL NO.	Lenovo A606	
MID	60600031	
POWER SUPPLY	5.0Vdc (adapter or host equipment) 3.8Vdc (Li-ion battery)	
MODULATION TYPE	GSM/GPRS	GMSK
	EDGE	GMSK, 8PSK
	WCDMA	BPSK
	LTE	QPSK, 16QAM
FREQUENCY RANGE	GSM/GPRS/EDGE	824.2MHz ~ 848.8MHz
	WCDMA	826.4MHz ~ 846.6MHz
MAX. ERP POWER	GSM	716mW
	EDGE	309mW
	WCDMA	130mW
EMISSION DESIGNATOR	GSM	246KGXW
	EDGE	252KG7W
	WCDMA	4M22F9W
ANTENNA TYPE	Fixed Internal antenna with -5dBi gain	
HW VERSION	LWDM015C	
SW VERSION	LWD3I20.1.6.1.0T05A0731_M015	
I/O PORTS	Refer to user's manual	
DATA CABLE	USB cable : Shielded, Detachable, 1.0m Earphone cable: Unshielded, Detachable, 1.5m	

NOTE:

- The EUT consumes power from the following adapter.

ADAPTER	
BRAND:	lenovo
MODEL:	C-P56
INPUT:	AC 100-240V, 50/60Hz, 300mA
OUTPUT:	DC 5V, 1000mA
MANUFACTURER:	Huntkey

- The EUT matched the following USB cable:

USB CABLE	
BRAND:	LIQI
MODEL:	LQ-0350005-02
SIGNAL LINE:	1.0 METER



Test Report No.: RF140804N016-4

3. The above EUT information is declared by manufacturer and for more detailed features description, please refer to the manufacturer's specifications or User's Manual.

3.2 CONFIGURATION OF SYSTEM UNDER TEST

FOR RADIATION EMISSION TEST

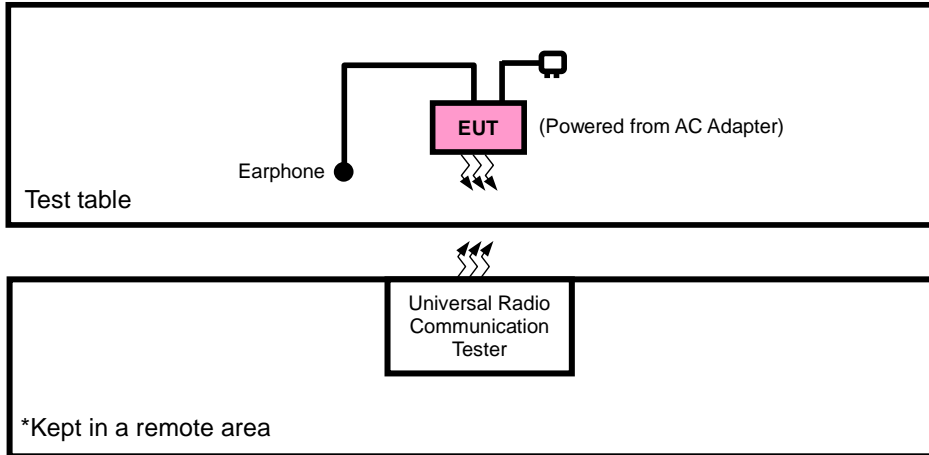

FOR E.R.P. TEST

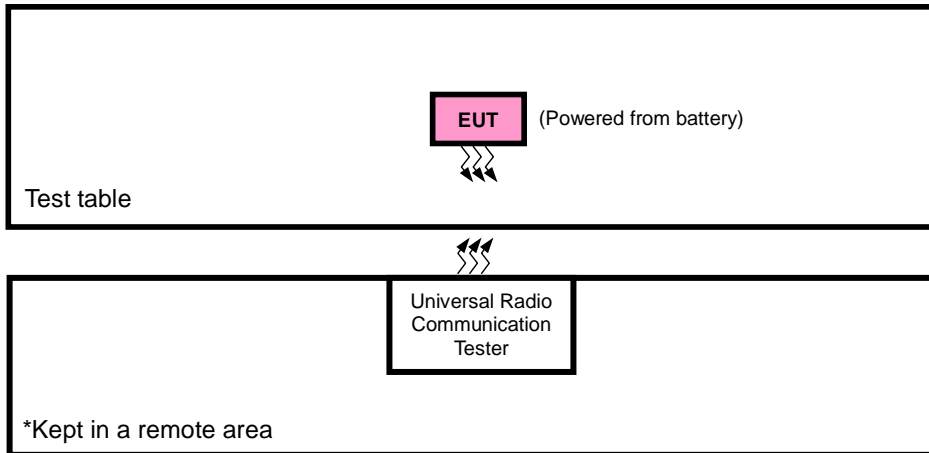

3.3 DESCRIPTION OF SUPPORT UNITS

The EUT has been tested as an independent unit together with other necessary accessories or support units. The following support units or accessories were used to form a representative test configuration during the tests.

NO.	PRODUCT	BRAND	MODEL NO.	SERIAL NO.	FCC ID
1	N/A	N/A	N/A	N/A	N/A

NO.	SIGNAL CABLE DESCRIPTION OF THE ABOVE SUPPORT UNITS
1.	N/A

3.4 TEST ITEM AND TEST CONFIGURATION

Pre-Scan has been conducted to determine the worst-case mode from all possible combinations between available modulations, data rates, XYZ axis and antenna ports. The worst case was found when positioned on Y-plane for ERP and X-axis for radiated emission. Following channel(s) was (were) selected for the final test as listed below:

EUT CONFIGURE MODE	DESCRIPTION
A	EUT + Adapter with GSM ,WCDMA or LTE link
B	EUT + Battery with GSM ,WCDMA or LTE link

GSM MODE

EUT CONFIGURE MODE	TEST ITEM	AVAILABLE CHANNEL	TESTED CHANNEL	MODE
B	ERP	128 to 251	128, 190, 251	GSM, EDGE
B	FREQUENCY STABILITY	128 to 251	190	GSM, EDGE
B	OCCUPIED BANDWIDTH	128 to 251	128, 190, 251	GSM, GPRS, EDGE
B	BAND EDGE	128 to 251	128, 251	GSM, GPRS, EDGE
B	CONDCUDED EMISSION	128 to 251	128, 190, 251	GSM
A	RADIATED EMISSION	128 to 251	190	GSM, EDGE



Test Report No.: RF140804N016-4

WCDMA MODE

EUT CONFIGURE MODE	TEST ITEM	AVAILABLE CHANNEL	TESTED CHANNEL	MODE
B	ERP	4132 to 4233	4132, 4182, 4233	WCDMA
B	FREQUENCY STABILITY	4132 to 4233	4182	WCDMA
B	OCCUPIED BANDWIDTH	4132 to 4233	4132, 4182, 4233	WCDMA, HSDPA, HSUPA
B	BAND EDGE	4132 to 4233	4132, 4233	WCDMA, HSDPA, HSUPA
B	CONDCUDED EMISSION	4132 to 4233	4132, 4182, 4233	WCDMA
A	RADIATED EMISSION	4132 to 4233	4182	WCDMA

TEST ITEM	ENVIRONMENTAL CONDITIONS	INPUT POWER	TESTED BY
ERP	23deg. C, 62%RH	3.8Vdc from Battery	Yuqiang Yin
FREQUENCY STABILITY	23deg. C, 62%RH	3.8Vdc from Battery	Yuqiang Yin
OCCUPIED BANDWIDTH	23deg. C, 62%RH	3.8Vdc from Battery	Yuqiang Yin
BAND EDGE	23deg. C, 62%RH	3.8Vdc from Battery	Yuqiang Yin
CONDCUDED EMISSION	23deg. C, 62%RH	5Vdc from adapter	Yuqiang Yin
RADIATED EMISSION	25deg. C, 63.6%RH	5Vdc from adapter	Blue Zheng



Test Report No.: RF140804N016-4

3.5 EUT OPERATING CONDITIONS

The EUT makes a call to the communication simulator. The communication simulator station system controlled a EUT to export maximum output power under transmission mode and specific channel frequency

3.6 GENERAL DESCRIPTION OF APPLIED STANDARDS

The EUT is a RF product. According to the specifications of the manufacturer, it must comply with the requirements of the following standards:

FCC 47 CFR Part 2

FCC 47 CFR Part 22

ANSI/TIA/EIA-603-C 2004

NOTE: All test items have been performed and recorded as per the above standards.



4 TEST TYPES AND RESULTS

4.1 OUTPUT POWER MEASUREMENT

4.1.1 LIMITS OF OUTPUT POWER MEASUREMENT

Mobile / Portable station are limited to 7 watts e.r.p.

4.1.2 TEST PROCEDURES

EIRP / ERP MEASUREMENT:

- a. All measurements were done at low, middle and high operational frequency range. RBW and VBW is 1MHz for GSM, GPRS & EDGE, 5MHz for WCDMA mode.
- b. Substitution method is used for E.I.R.P measurement. In the semi-anechoic chamber, EUT placed on the 0.8m height of Turn Table, rotated the table around 360 degrees to search the maximum radiation power and receiver antenna shall be rotated vertical and horizontal polarization and moved height from 1m to 4m to find the maximum polar radiated power. The “Read Value” is the spectrum reading the maximum power value.
- c. The substitution horn antenna is substituted for EUT at the same position and signals generator export the CW signal to the substitution antenna via a tx cable. Rotated the Turn Table and moved receiving antenna to find the maximum radiation power. Adjust output power level of S.G to get a Value of spectrum reading equal to “Read Value “ of step b. Record the power level of S.G
- d. $ERP = \text{Output power level of S.G} - \text{TX cable loss} + \text{Antenna gain of substitution horn.}$
E.R.P power can be calculated form E.I.R.P power by subtracting the gain of dipole, $E.R.P \text{ power} = E.I.P.R \text{ power} - 2.15\text{dBi.}$

CONDUCTED POWER MEASUREMENT:

The EUT was set up for the maximum power with GSM, GPRS, EDGE & WCDMA link data modulation and link up with simulator. Set the EUT to transmit under low, middle and high channel and record the power level shown on simulator.

4.1.3 TEST SETUP

EIRP / ERP MEASUREMENT:

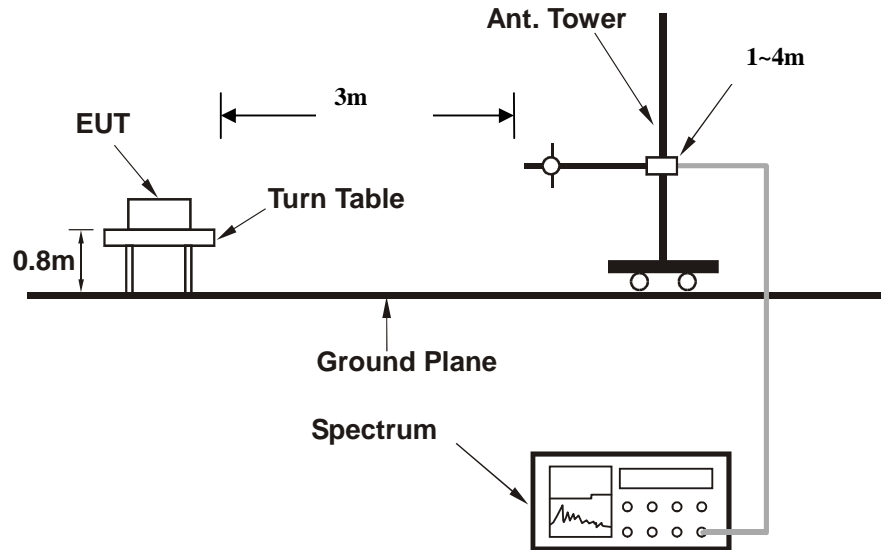

For the actual test configuration, please refer to the attached file (Test Setup Photo).

CONDUCTED POWER MEASUREMENT:



For the actual test configuration, please refer to the attached file (Test Setup Photo).

4.1.4 TEST RESULTS

CONDUCTED OUTPUT POWER (dBm)

Band	GSM850		
Channel	128	190	251
Frequency (MHz)	824.2	836.6	848.8
GSM	31.99	32.15	31.97
GPRS 8	31.93	32.08	31.92
GPRS 10	30.89	31.04	30.93
EDGE 8 (MCS1)	31.98	32.07	31.91
EDGE 10 (MCS1)	30.93	31.02	30.91
EDGE 8 (MCS9)	25.91	25.93	26.00
EDGE 10 (MCS9)	24.87	24.89	24.93

Band	WCDMA V		
Channel	4132	4182	4233
Frequency (MHz)	826.4	836.4	846.6
RMC 12.2K	23.58	23.56	23.41
HSPA			
HSDPA Subtest-1	23.09	22.98	22.87
HSDPA Subtest-2	23.10	22.96	22.87
HSDPA Subtest-3	22.60	22.50	22.39
HSDPA Subtest-4	22.58	22.49	22.40
HSUPA Subtest-1	22.88	22.87	22.72
HSUPA Subtest-2	21.09	20.98	20.83
HSUPA Subtest-3	22.08	21.94	21.83
HSUPA Subtest-4	21.20	21.25	21.15
HSUPA Subtest-5	23.06	22.90	22.74

ERP POWER (dBm)

GSM

Channel	Frequency (MHz)	LVL (dBm)	Correction Factor(dB)	ERP(dBm)	ERP(mW)	Polarization (H/V)
128	824.2	-15.34	35.85	18.36	68.55	H
189	836.4	-15.48	37.09	19.46	88.31	H
251	848.8	-15.85	36.96	18.96	78.70	H
128	824.2	-6.57	36.88	28.16	654.64	V
189	836.4	-6.86	37.56	28.55	716.14	V
251	848.8	-7.02	37.72	28.55	716.14	V

EDGE

Channel	Frequency (MHz)	LVL (dBm)	Correction Factor(dB)	ERP(dBm)	ERP(mW)	Polarization (H/V)
128	826.4	-17.51	35.85	16.19	41.59	H
189	836.4	-17.83	37.09	17.11	51.40	H
251	846.6	-17.92	36.96	16.89	48.87	H
128	826.4	-10.33	36.88	24.40	275.42	V
189	836.4	-10.51	37.56	24.90	309.03	V
251	846.6	-10.88	37.72	24.69	294.44	V

WCDMA

Channel	Frequency (MHz)	LVL (dBm)	Correction Factor(dB)	ERP(dBm)	ERP(mW)	Polarization (H/V)
4132	826.4	-24.16	35.85	9.54	8.99	H
4182	836.4	-24.34	37.09	10.60	11.48	H
4233	846.6	-24.55	37	10.30	10.72	H
4132	826.4	-14.25	36.85	20.45	110.92	V
4182	836.4	-14.26	37.56	21.15	130.32	V
4233	846.6	-14.65	37.77	20.97	125.03	V

4.2 FREQUENCY STABILITY MEASUREMENT

4.2.1 LIMITS OF FREQUENCY STABILITY MEASUREMENT

1.5 ppm is for base and fixed station. 2.5 ppm is for mobile station.

4.2.2 TEST PROCEDURE

- a. Device is placed at the oven room. The oven room could control the temperatures and humidity. Power warm up is at least 15 min and power applied should perform before recording frequency error.
- b. EUT is connected the external power supply to control the DC input power. The test voltage range is from minimum to maximum working voltage. Each step shall be record the frequency error rate.
- c. The temperature range step is 10 degrees in this test items. All temperature levels shall be hold the $\pm 0.5^{\circ}\text{C}$ during the measurement testing. The each temperature step shall be at least 0.5 hours, consider the EUT could be test under the stability condition.

NOTE: The frequency error was recorded frequency error from the communication simulator.

4.2.3 TEST SETUP

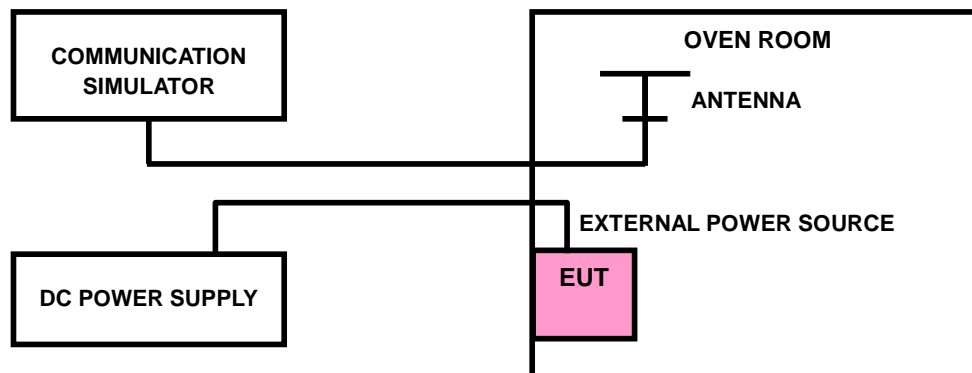

4.2.4 TEST RESULTS

FREQUENCY ERROR VS. VOLTAGE

Voltage (Volts)	Frequency Error (ppm)			Limit (ppm)
	GSM	EDGE	WCDMA	
3.8(normal)	0.0007	0.0010	0.00	2.5
3.6(Min.)	-0.0030	-0.0041	0.00	2.5
4.2(Max.)	0.0040	0.0048	0.01	2.5

NOTE: The applicant defined the normal working voltage of the battery is from 3.6Vdc to 4.2Vdc.

FREQUENCY ERROR vs. TEMPERATURE.

Voltage (Volts)	Frequency Error (ppm)			Limit (ppm)
	GSM	EDGE	WCDMA	
-30	-0.0158	-0.0148	-0.01	2.5
-20	-0.0132	-0.0123	-0.01	2.5
-10	-0.0113	-0.0107	-0.01	2.5
0	-0.0085	-0.0088	-0.01	2.5
10	-0.0062	-0.0069	0.00	2.5
20	-0.0017	-0.0038	0.00	2.5
30	0.0015	-0.0002	0.00	2.5
40	0.0041	0.0033	0.00	2.5
50	0.0057	0.0056	0.01	2.5
60	0.0074	0.0077	0.01	2.5

4.3 OCCUPIED BANDWIDTH MEASUREMENT

4.3.1 TEST PROCEDURES

The EUT makes a call to the communication simulator. All measurements were done at low, middle and high operational frequency range. The communication simulator station system controlled a EUT to export maximum output power under transmission mode and specific channel frequency. Use OBW measurement function of Spectrum analyzer to measure 99 % occupied bandwidth.

4.3.2 TEST SETUP

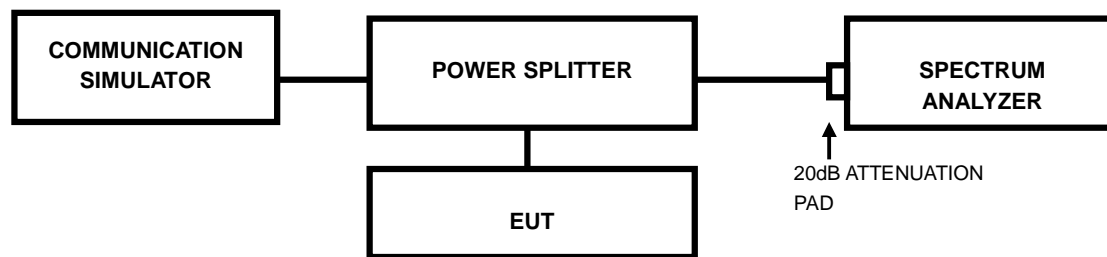

4.3.3 TEST RESULTS

CHANNEL	Frequency (MHz)	99% OCCUPIED Bandwidth (kHz)		CHANNEL	Frequency (MHz)	99% OCCUPIED Bandwidth (MHz)
		GSM	EDGE			WCDMA
128	824.2	246.38	252.17	4132	826.4	4.22
189	836.6	246.38	249.28	4182	836.4	4.22
251	848.8	246.38	250.72	4233	846.6	4.22

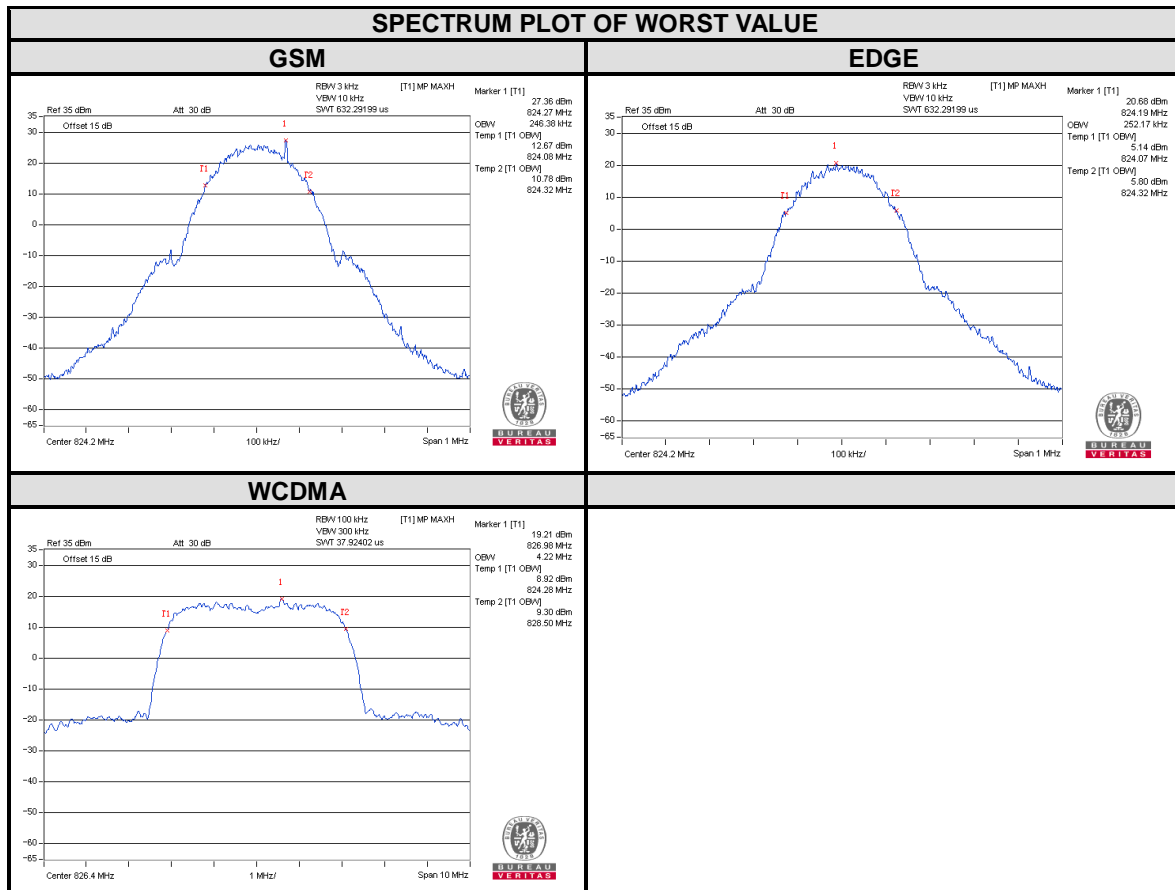



Test Report No.: RF140804N016-4

CHANNEL	Frequency (MHz)	26dB Bandwidth (kHz)		CHANNEL	Frequency (MHz)	26dB Bandwidth (MHz)
		GSM	EDGE			
128	824.2	315.78	314.74	4132	826.4	4.86
189	836.6	314.65	318.36	4182	836.4	4.85
251	848.8	313.84	320.48	4233	846.6	4.85

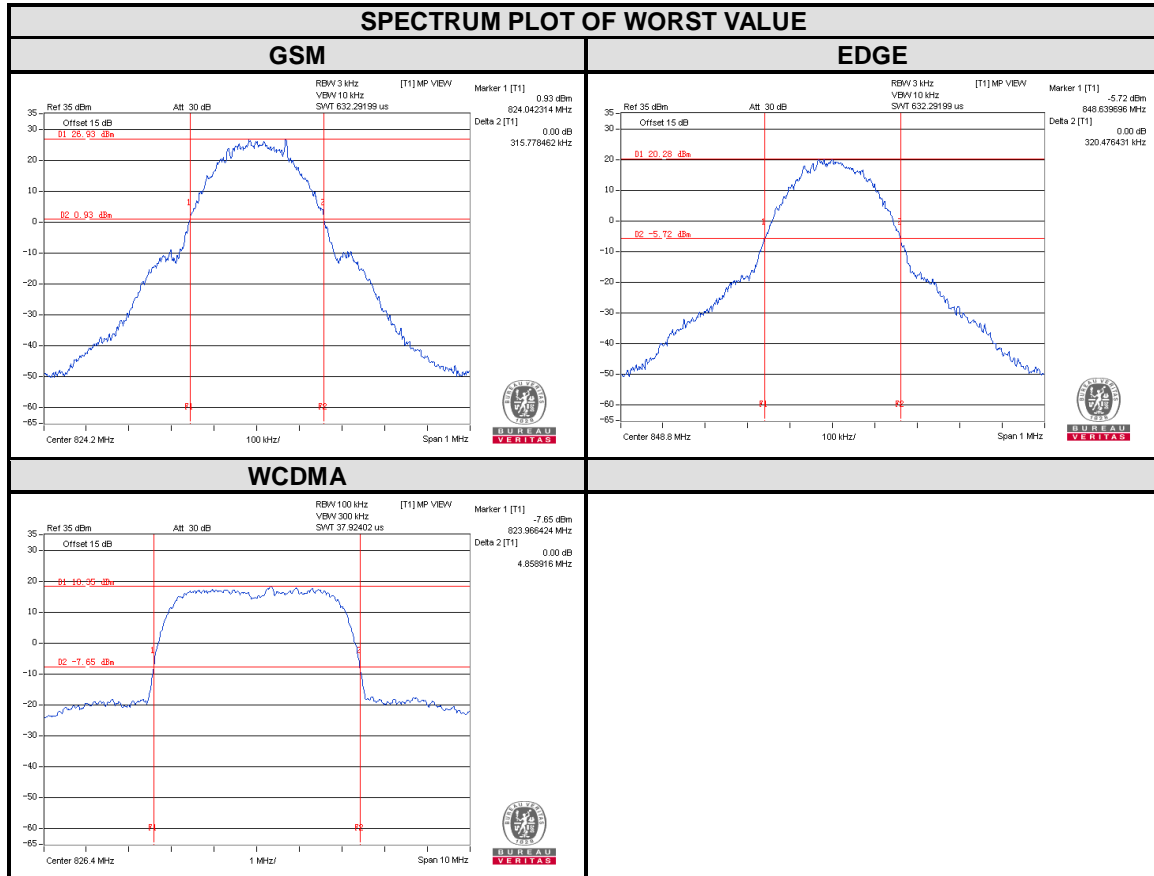

4.4 BAND EDGE MEASUREMENT

4.4.1 LIMITS OF BAND EDGE MEASUREMENT

Power of any emission outside of the authorized operating frequency ranges must be attenuated below the transmitting power (P) by a factor of at least $43 + 10 \log(P)$ dB. In the 1 MHz bands immediately outside and adjacent to the frequency block a resolution bandwidth of at least one percent of the emission bandwidth of the fundamental emission of the transmitter may be employed.

4.4.2 TEST SETUP

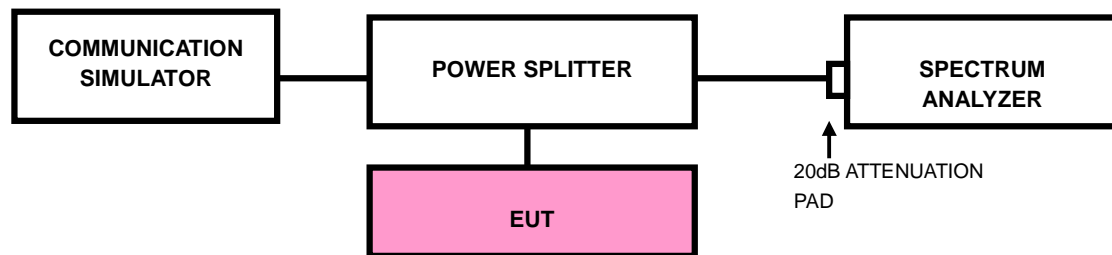

4.4.3 TEST PROCEDURES

- All measurements were done at low and high operational frequency range.
- The center frequency of spectrum is the band edge frequency and span is 1.5MHz. RBW of the spectrum is 10kHz and VBW of the spectrum is 30kHz (GSM/GPRS/EDGE).
- The center frequency of spectrum is the band edge frequency and span is 10MHz. RBW of the spectrum is 100kHz and VBW of the spectrum is 300kHz (WCDMA).
- Record the max trace plot into the test report.



4.4.4 TEST RESULTS

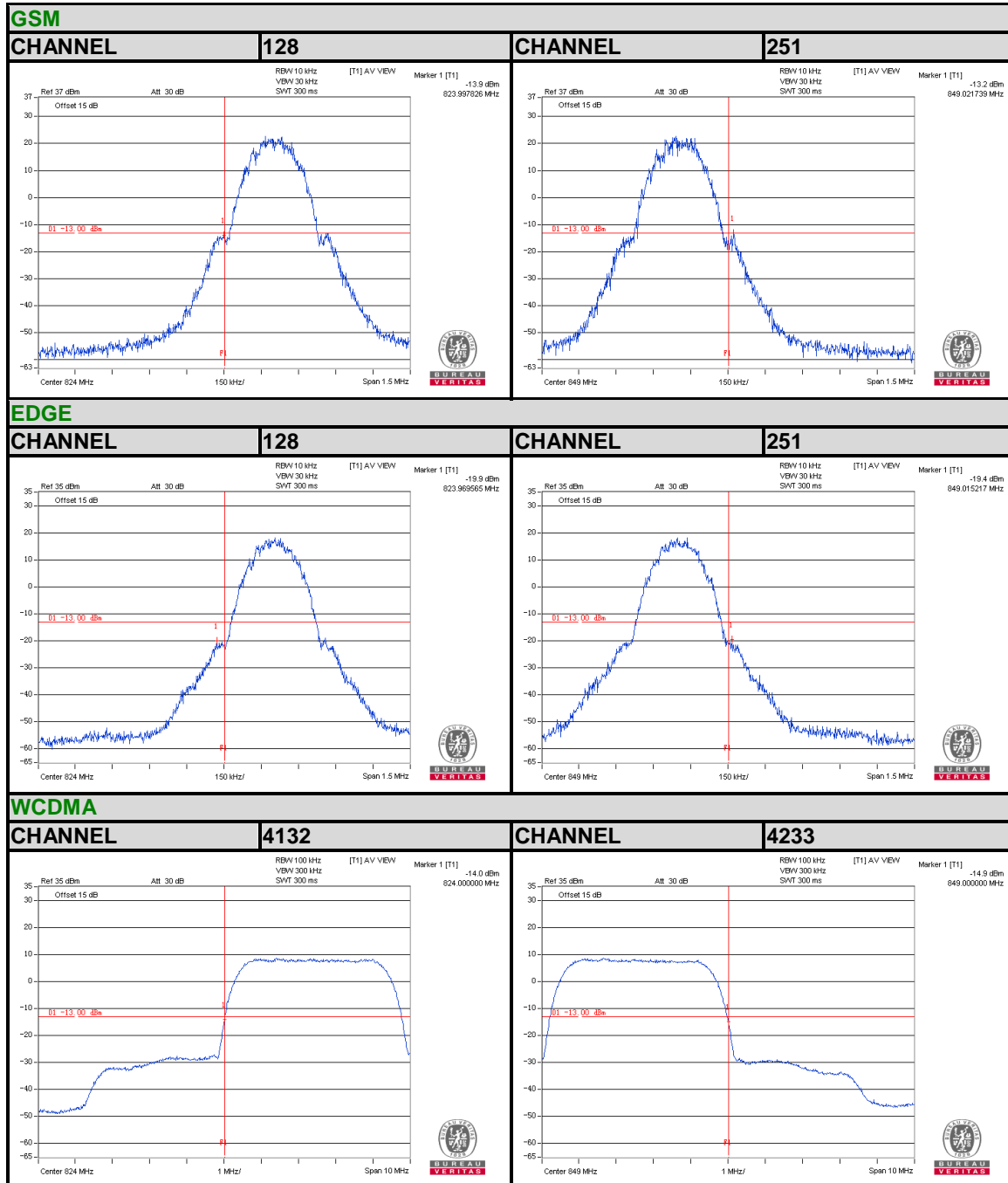

4.5 CONDUCTED SPURIOUS EMISSIONS

4.5.1 LIMITS OF CONDUCTED SPURIOUS EMISSIONS MEASUREMENT

The power of any emission outside of the authorized operating frequency ranges must be attenuated below the transmitting power (P) by a factor of at least $43 + 10 \log(P)$ dB. The emission limit equal to -13dBm .

4.5.2 TEST PROCEDURE

- a. The EUT makes a phone call to the communication simulator. All measurements were done at low, middle and high operational frequency range.
- b. Measuring frequency range is from 9 kHz to 9GHz. 20dB attenuation pad is connected with spectrum. RBW=1MHz and VBW=3MHz is used for conducted emission measurement.

4.5.3 TEST SETUP

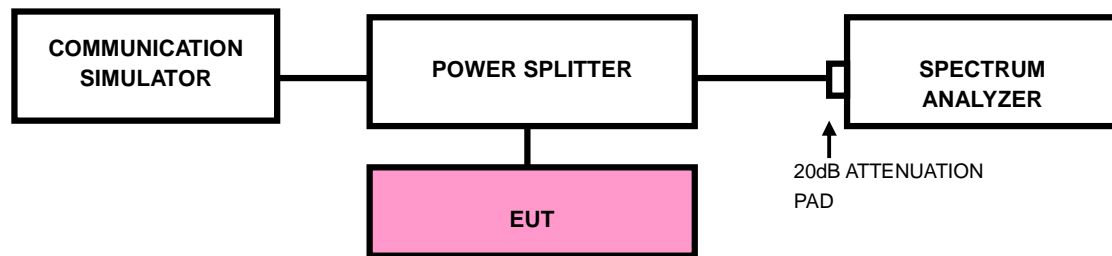



4.5.4 TEST RESULTS

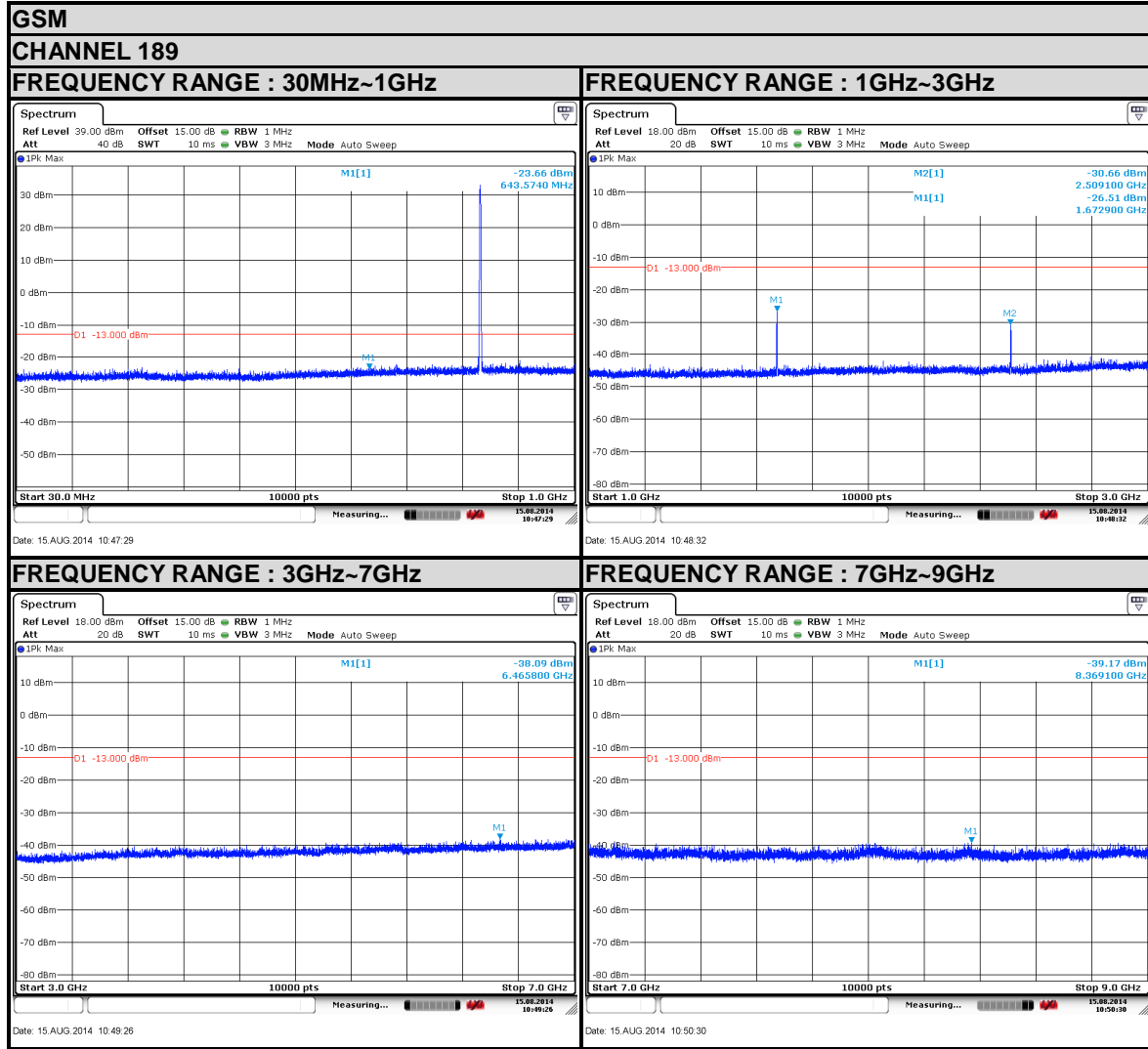



Test Report No.: RF140804N016-4

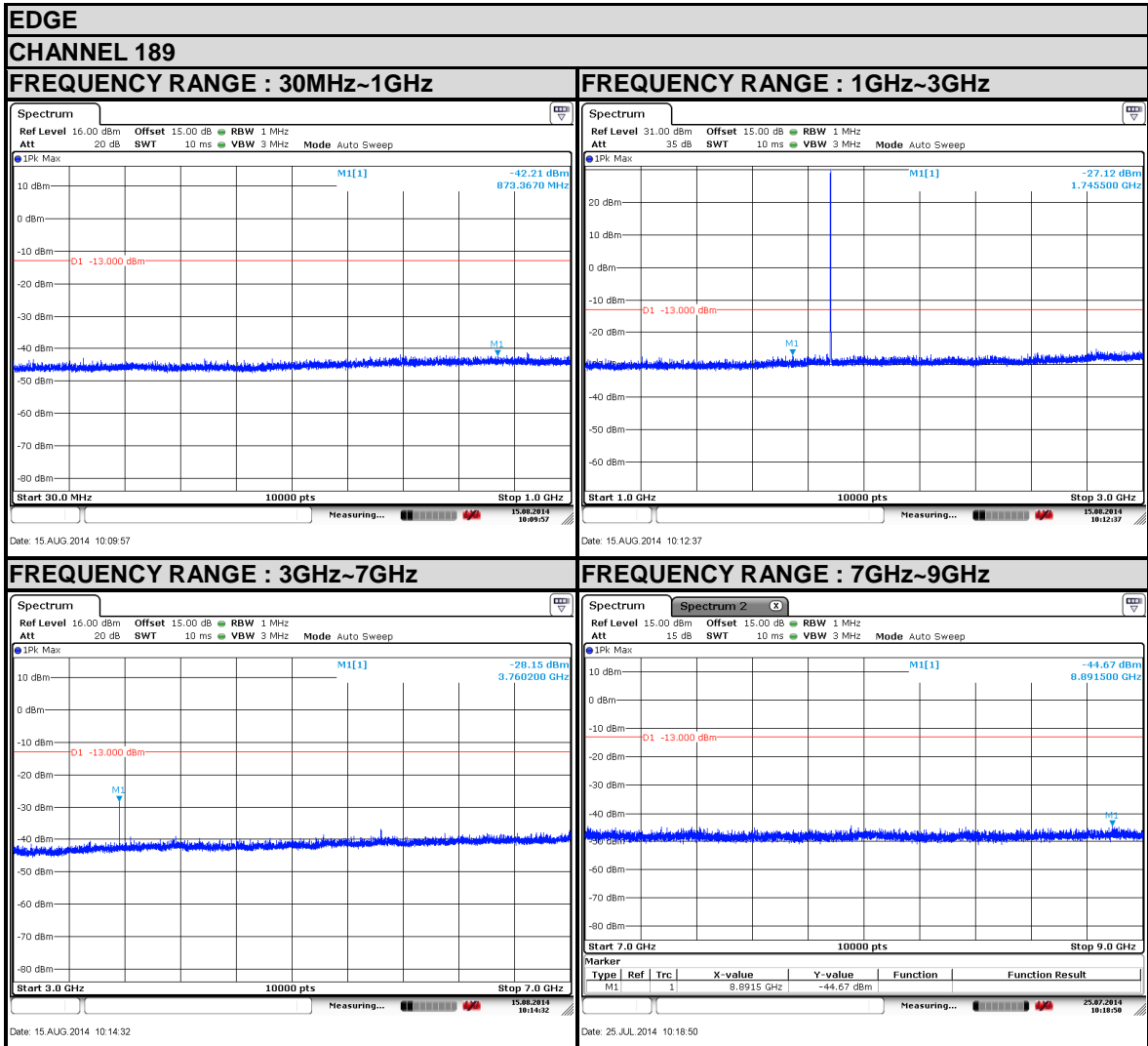



Test Report No.: RF140804N016-4

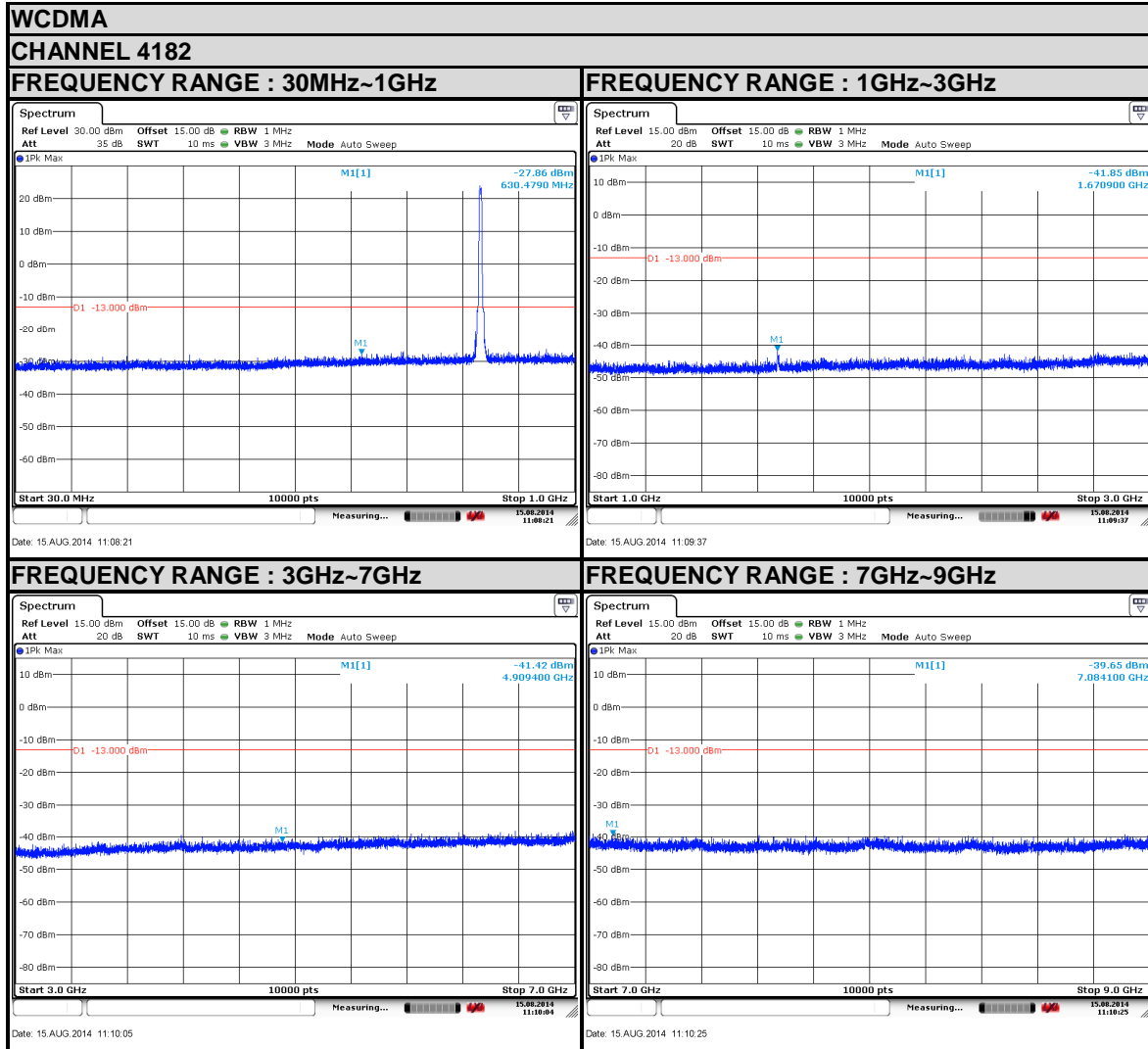

4.6 RADIATED EMISSION MEASUREMENT

4.6.1 LIMITS OF RADIATED EMISSION MEASUREMENT

The power of any emission outside of the authorized operating frequency ranges must be attenuated below the transmitting power (P) by a factor of at least $43 + 10 \log(P)$ dB. The emission limit equal to -13dBm .

4.6.2 TEST PROCEDURES

- a. Substitution method is used for E.I.R.P measurement. In the semi-anechoic chamber, EUT placed on the 0.8m height of Turn Table, rotated the table around 360 degrees to search the maximum radiation power and receiver antenna shall be rotated vertical and horizontal polarization and moved height from 1m to 4m to find the maximum polar radiated power. The “Read Value” is the spectrum reading the maximum power value.
- b. The substitution horn antenna is substituted for EUT at the same position and signals generator export the CW signal to the substitution antenna via a TX cable. Rotated the Turn Table and moved receiving antenna to find the maximum radiation power. Adjust output power level of S.G to get a Value of spectrum reading equal to “Read Value “ of step a. Record the power level of S.G
- c. $\text{EIRP} = \text{Output power level of S.G} - \text{TX cable loss} + \text{Antenna gain of substitution horn}$.
- d. E.R.P power can be calculated form E.I.R.P power by subtracting the gain of dipole, $\text{E.R.P power} = \text{E.I.P.R power} - 2.15\text{dBi}$.

NOTE: The resolution bandwidth and video bandwidth of test receiver/spectrum analyzer is 1MHz/3MHz.

4.6.3 DEVIATION FROM TEST STANDARD

No deviation

4.6.4 TEST SETUP

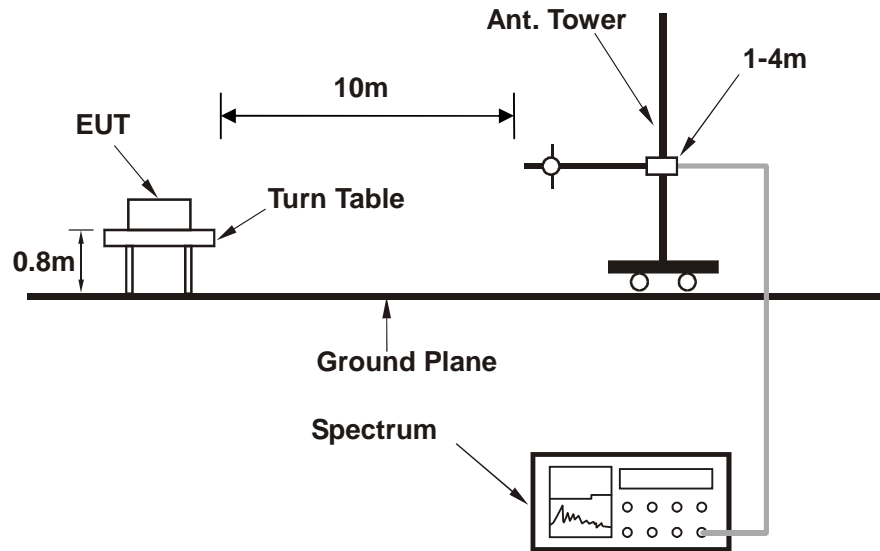

For the actual test configuration, please refer to the attached file (Test Setup Photo).

4.6.5 TEST RESULTS

BELOW 1GHz WORST-CASE DATA GSM 850

SPURIOUS EMISSION FREQUENCY RANGE	Below 1000MHz	OPERATING CHANNEL	128
--	---------------	------------------------------	-----

SPURIOUS EMISSION LEVEL				
Frequency (MHz)	Antenna Polarization	Level (dBm)	Limit (dBm)	Margin (dB)
33.23	H	-83.46	-13.00	-70.46
107.60	H	-83.16	-13.00	-70.16
141.55	H	-81.92	-13.00	-68.92
212.68	H	-84.53	-13.00	-71.53
353.33	H	-75.50	-13.00	-62.50
447.10	H	-80.24	-13.00	-67.24

NOTE: The emission behavior belongs to narrowband spurious emission.

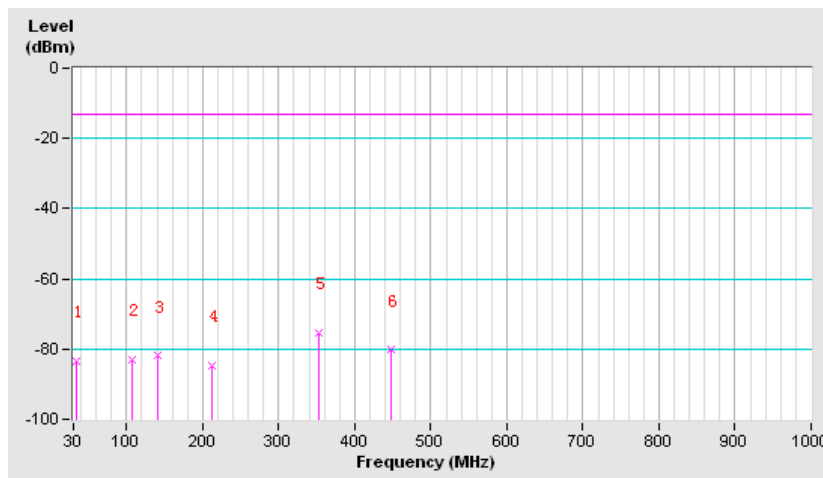



SPURIOUS EMISSION FREQUENCY RANGE	Below 1000MHz	OPERATING CHANNEL	128
--	---------------	--------------------------	-----

SPURIOUS EMISSION LEVEL				
Frequency (MHz)	Antenna Polarization	Level (dBm)	Limit (dBm)	Margin (dB)
30.00	V	-73.35	-13.00	-60.35
49.40	V	-78.20	-13.00	-65.20
141.55	V	-79.28	-13.00	-66.28
354.95	V	-76.69	-13.00	-63.69
447.10	V	-71.97	-13.00	-58.97
540.87	V	-75.50	-13.00	-62.50

NOTE: The emission behavior belongs to narrowband spurious emission.

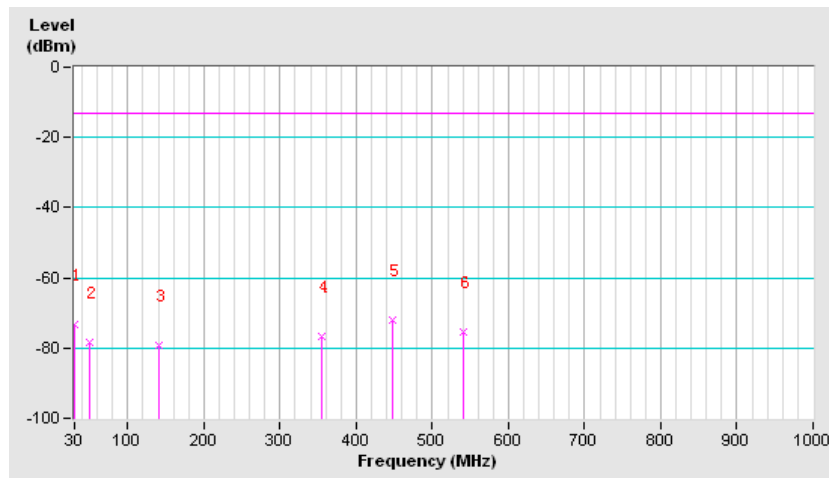

BELOW 1GHz WORST-CASE DATA

WCDMA BAND5

SPURIOUS EMISSION FREQUENCY RANGE	Below 1000MHz	OPERATING CHANNEL	128
--	---------------	------------------------------	-----

SPURIOUS EMISSION LEVEL				
Frequency (MHz)	Antenna Polarization	Level (dBm)	Limit (dBm)	Margin (dB)
54.25	H	-70.51	-13.00	-57.51
99.52	H	-59.10	-13.00	-46.10
196.52	H	-63.34	-13.00	-50.34
296.75	H	-63.02	-13.00	-50.02
363.03	H	-59.89	-13.00	-46.89
419.62	H	-65.16	-13.00	-52.16

NOTE: The emission behavior belongs to narrowband spurious emission.

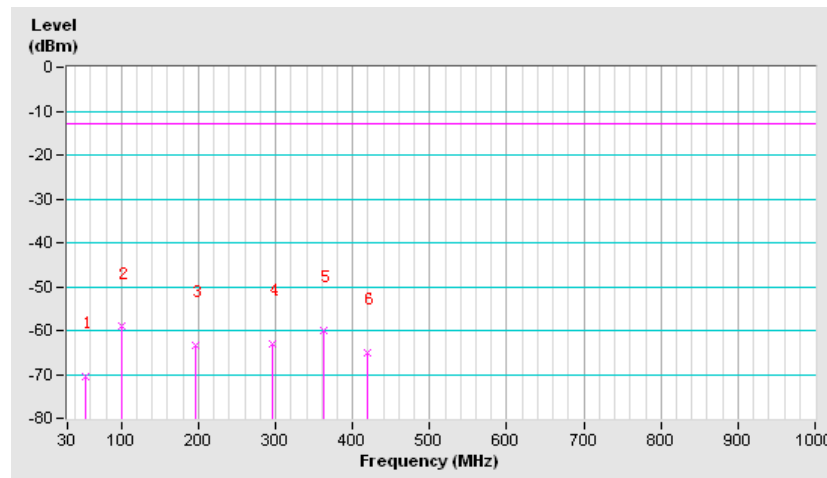



SPURIOUS EMISSION FREQUENCY RANGE	Below 1000MHz	OPERATING CHANNEL	128
--	---------------	--------------------------	-----

SPURIOUS EMISSION LEVEL				
Frequency (MHz)	Antenna Polarization	Level (dBm)	Limit (dBm)	Margin (dB)
54.25	V	-54.30	-13.00	-41.30
99.52	V	-56.52	-13.00	-43.52
230.47	V	-61.70	-13.00	-48.70
296.75	V	-61.25	-13.00	-48.25
363.03	V	-64.22	-13.00	-51.22
540.87	V	-67.71	-13.00	-54.71

NOTE: The emission behavior belongs to narrowband spurious emission.

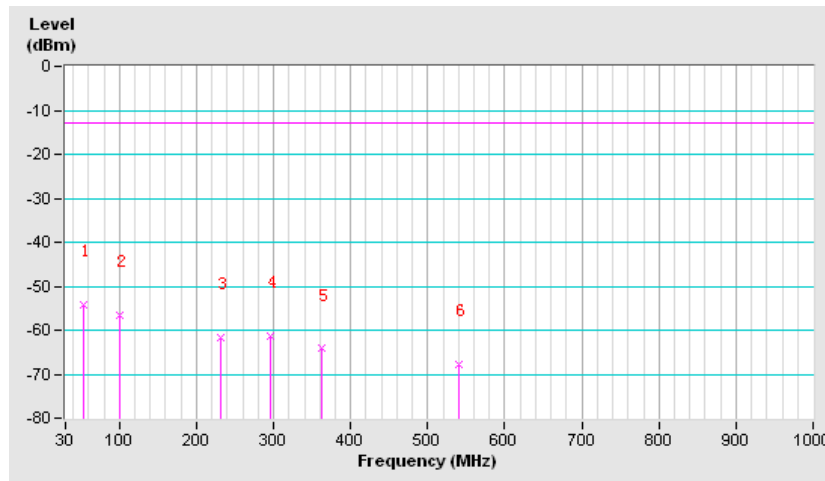



ABOVE 1GHz DATA

GSM:

ANTENNA POLARITY & TEST DISTANCE: HORIZONTAL AT 3 M							
No.	Freq. (MHz)	SPA READING (dBm)	Limit (dBm)	S.G Power Value (dBm)	Correction Factor (dB)	ERP (dBm)	Margin (dB)
1	1672	-51.97	-13	-45.37	0.11	-45.26	-32.26
2	2509	-51.12	-13	-40.96	-0.06	-41.02	-28.02
3	3345	-64.83	-13	-53.24	0.69	-52.55	-39.55
ANTENNA POLARITY & TEST DISTANCE: VERTICAL AT 3 M							
No.	Freq. (MHz)	SPA READING (dBm)	Limit (dBm)	S.G Power Value (dBm)	Correction Factor (dB)	ERP (dBm)	Margin (dB)
1	1672	-47.52	-13	-36.57	0.11	-36.46	-23.46
2	2509	-51.32	-13	-39.27	-0.06	-39.33	-26.33
3	3345	-63.76	-13	-51.37	0.69	-50.68	-37.68

REMARKS:

1. ERP (dBm) = S.G Value (dBm) + Correction Factor (dB).
2. Correction Factor (dB) = Substitution Antenna Gain (dB) + Cable Loss (dB) - 2.15 (dB)

EDGE:

ANTENNA POLARITY & TEST DISTANCE: HORIZONTAL AT 3 M							
No.	Freq. (MHz)	SPA READING (dBm)	Limit (dBm)	S.G Power Value (dBm)	Correction Factor (dB)	ERP (dBm)	Margin (dB)
1	1672	-61.04	-13	-54.51	0.11	-54.40	-41.40
2	2509	-58.59	-13	-48.46	-0.06	-48.52	-35.52
3	3345	-64.55	-13	-52.96	0.69	-52.27	-39.27
ANTENNA POLARITY & TEST DISTANCE: VERTICAL AT 3 M							
No.	Freq. (MHz)	SPA READING (dBm)	Limit (dBm)	S.G Power Value (dBm)	Correction Factor (dB)	ERP (dBm)	Margin (dB)
1	1672	-56.65	-13	-45.70	0.11	-45.59	-32.59
2	2509	-59.64	-13	-47.80	-0.06	-47.86	-34.86
3	3345	-63.65	-13	-51.26	0.69	-50.57	-37.57

REMARKS:

1. ERP (dBm) = S.G Value (dBm) + Correction Factor (dB).
2. Correction Factor (dB) = Substitution Antenna Gain (dB) + Cable Loss (dB) - 2.15 (dB)



Test Report No.: RF140804N016-4

WCDMA:

ANTENNA POLARITY & TEST DISTANCE: HORIZONTAL AT 3 M							
No.	Freq. (MHz)	SPA READING (dBm)	Limit (dBm)	S.G Power Value (dBm)	Correction Factor (dB)	ERP (dBm)	Margin (dB)
1	1672	-62.06	-13	-55.54	0.11	-55.43	-42.43
2	2509	-61.96	-13	-51.85	-0.06	-51.91	-38.91
3	3345	-64.57	-13	-52.98	0.69	-52.29	-39.29
ANTENNA POLARITY & TEST DISTANCE: VERTICAL AT 3 M							
No.	Freq. (MHz)	SPA READING (dBm)	Limit (dBm)	S.G Power Value (dBm)	Correction Factor (dB)	ERP (dBm)	Margin (dB)
1	1672	-61.83	-13	-50.88	0.11	-50.77	-37.77
2	2509	-61.61	-13	-49.82	-0.06	-49.88	-36.88
3	3345	-64.25	-13	-51.86	0.69	-51.17	-38.17

REMARKS:

1. ERP (dBm) = S.G Value (dBm) + Correction Factor (dB).
2. Correction Factor (dB) = Substitution Antenna Gain (dB) + Cable Loss (dB) - 2.15 (dB)



Test Report No.: RF140804N016-4

5 PHOTOGRAPHS OF THE TEST CONFIGURATION

Please refer to the attached file (Test Setup Photo).



Test Report No.: RF140804N016-4

6 INFORMATION ON THE TESTING LABORATORIES

We, Bureau Veritas Shenzhen Co., Ltd. Dongguan Branch, were founded in 2002 to provide our best service in EMC, Radio, Telecom and Safety consultation. Our laboratories are accredited and approved according to ISO/IEC 17025.

If you have any comments, please feel free to contact us at the following:

Dongguan EMC/RF Lab:

Tel: +86-769-85935656

Fax: +86-769-85931080

Email: customerservice.dg@cn.bureauveritas.com

Web Site: www.adt.com.tw

The address and road map of all our labs can be found in our web site also.



Test Report No.: RF140804N016-4

7 APPENDIX A – MODIFICATIONS RECORDERS FOR ENGINEERING CHANGES TO THE EUT BY THE LAB

No any modifications are made to the EUT by the lab during the test.

---END---