



FCC RF Test Report

APPLICANT : Lenovo Mobile Communication Technology Ltd.
EQUIPMENT : Lenovo Mobile Phone
BRAND NAME : Lenovo
MODEL NAME : Lenovo A6020I36
FCC ID : YCNA6020L36
STANDARD : FCC Part 15 Subpart C §15.247
CLASSIFICATION : (DTS) Digital Transmission System

The product was completed on Dec. 17, 2015. We, SPORTON INTERNATIONAL (KUNSHAN) INC., would like to declare that the tested sample has been evaluated in accordance with the test procedures and has been in compliance with the applicable technical standards.

The test results in this report apply exclusively to the tested model / sample. Without written approval of SPORTON INTERNATIONAL (KUNSHAN) INC., the test report shall not be reproduced except in full.

Prepared by: James Huang / Manager



Approved by: Jones Tsai / Manager

SPORTON INTERNATIONAL (KUNSHAN) INC.
No. 3-2, PingXiang Road, Kunshan, Jiangsu Province, P. R. China



TABLE OF CONTENTS

REVISION HISTORY..... 3

SUMMARY OF TEST RESULT 4

1 GENERAL DESCRIPTION 5

 1.1 Applicant 5

 1.2 Manufacturer 5

 1.3 Product Feature of Equipment Under Test..... 5

 1.4 Product Specification of Equipment Under Test..... 6

 1.5 Modification of EUT 7

 1.6 Testing Location 7

 1.7 Applicable Standards 7

2 TEST CONFIGURATION OF EQUIPMENT UNDER TEST 8

 2.1 Carrier Frequency Channel 8

 2.2 Pre-Scanned RF Power 9

 2.3 Test Mode 10

 2.4 Connection Diagram of Test System 11

 2.5 Support Unit used in test configuration and system 13

 2.6 EUT Operation Test Setup 13

 2.7 Measurement Results Explanation Example 13

3 TEST RESULT 14

 3.1 6dB and 99% Bandwidth Measurement 14

 3.2 Output Power Measurement 16

 3.3 Power Spectral Density Measurement 18

 3.4 Conducted Band Edges and Spurious Emission Measurement 20

 3.5 Radiated Band Edges and Spurious Emission Measurement 30

 3.6 AC Conducted Emission Measurement 34

 3.7 Antenna Requirements 38

4 LIST OF MEASURING EQUIPMENT 39

5 UNCERTAINTY OF EVALUATION 40

APPENDIX A. CONDUCTED TEST RESULTS

APPENDIX B. RADIATED TEST RESULTS

APPENDIX C. SETUP PHOTOGRAPHS

APPENDIX D. PRODUCT EQUALITY DECLARATION



REVISION HISTORY

REPORT NO.	VERSION	DESCRIPTION	ISSUED DATE
FR5D0806-02C	Rev. 01	This is a variant report for Lenovo A6020I36. The product equality declaration could be referred to Appendix D. Based on the similarity between two models, all test results are not affected, and were leveraged from original report which can be referred to sporton report number FR5D0806C (Model name: Lenovo A6020I36; FCC ID: YCNA6020L36).	Feb. 02, 2016



SUMMARY OF TEST RESULT

Report Section	FCC Rule	Description	Limit	Result	Remark
3.1	15.247(a)(2)	6dB Bandwidth	$\geq 0.5\text{MHz}$	Pass	-
3.1	-	99% Bandwidth	-	Pass	-
3.2	15.247(b)	Power Output Measurement	$\leq 30\text{dBm}$	Pass	-
3.3	15.247(e)	Power Spectral Density	$\leq 8\text{dBm}/3\text{kHz}$	Pass	-
3.4	15.247(d)	Conducted Band Edges	$\leq 20\text{dBc}$	Pass	-
		Conducted Spurious Emission		Pass	-
3.5	15.247(d)	Radiated Band Edges and Radiated Spurious Emission	15.209(a) & 15.247(d)	Pass	Under limit 11.27 dB at 2483.520 MHz
3.6	15.207	AC Conducted Emission	15.207(a)	Pass	Under limit 8.31 dB at 0.660 MHz
3.7	15.203 & 15.247(b)	Antenna Requirement	N/A	Pass	-



1 General Description

1.1 Applicant

Lenovo Mobile Communication Technology Ltd.

No. 999, Qishan North 2nd Road, Information & Optoelectronics Park, Torch Hi-tech Industry Development Zone, Xiamen, P. R. China

1.2 Manufacturer

Lenovo PC HK Limited

23/F, Lincoln House, Taikoo Place 979 King's Road, Quarry Bay, Hong Kong

1.3 Product Feature of Equipment Under Test

Product Feature	
Equipment	Lenovo Mobile Phone
Brand Name	Lenovo
Model Name	Lenovo A6020I36
FCC ID	YCNA6020L36
EUT supports Radios application	GSM/GPRS/EGPRS/WCDMA/HSPA/HSPA+(16QAM uplink is not supported)/DC-HSDPA/LTE/ WLAN2.4GHz 802.11b/g/n HT20/ Bluetooth v2.1+EDR/Bluetooth v4.1 LE
IMEI Code	Conducted: 868526021058495/868526021058503 Conduction: 868526021058115/868526021058123 Radiation: 868526021058115/868526021058123
HW Version	H201
SW Version	A6020I36_S003_151202_ROW
EUT Stage	Identical Prototype

Remark: The above EUT's information was declared by manufacturer. Please refer to the specifications or user's manual for more detailed description.



1.4 Product Specification of Equipment Under Test

Standards-related Product Specification	
Tx/Rx Channel Frequency Range	802.11b/g/n : 2412 MHz ~ 2462 MHz
Maximum (Peak) Output Power to Antenna	802.11b : 14.76 dBm (0.0299 W) 802.11g : 19.62 dBm (0.0916 W) 802.11n HT20 : 18.82 dBm (0.0762 W)
99% Occupied Bandwidth	802.11b : 13.49MHz 802.11g : 18.73MHz 802.11n HT20 : 19.33MHz
Antenna Type/Gain	PIFA Antenna with gain 0.75 dBi
Type of Modulation	802.11b : DSSS (DBPSK / DQPSK / CCK) 802.11g/n : OFDM (BPSK / QPSK / 16QAM / 64QAM)



1.5 Modification of EUT

No modifications are made to the EUT during all test items.

1.6 Testing Location

Test Site	SPORTON INTERNATIONAL (KUNSHAN) INC.			
Test Site Location	No. 3-2, PingXiang Road, Kunshan, Jiangsu Province, P. R. China TEL: +86-0512-5790-0158 FAX: +86-0512-5790-0958			
Test Site No.	Sporton Site No.			FCC Registration No.
	TH01-KS	03CH03-KS	CO01-KS	306251

Note: The test site complies with ANSI C63.4 2009 requirement.

1.7 Applicable Standards

According to the specifications of the manufacturer, the EUT must comply with the requirements of the following standards:

- ♦ FCC Part 15 Subpart C §15.247
- ♦ FCC KDB Publication No. 558074 D01 DTS Meas. Guidance v03r03
- ♦ ANSI C63.10-2013

Remark:

1. All test items were verified and recorded according to the standards and without any deviation during the test.
2. This EUT has also been tested and complied with the requirements of FCC Part 15, Subpart B, recorded in a separate test report.



2 Test Configuration of Equipment Under Test

The EUT has been associated with peripherals and configuration operated in a manner tended to maximize its emission characteristics in a typical application. Frequency range investigated: conducted emission (150 kHz to 30 MHz) and radiated emission (9 kHz to the 10th harmonic of the highest fundamental frequency or to 40 GHz, whichever is lower). For radiated measurement, pre-scanned in three orthogonal panels, X, Y, Z. The worst cases(X, Z Plane) were recorded in this report.

The final configuration from all the combinations and the worst-case data rates were investigated by measuring the maximum power across all the data rates and modulation modes under section 2.2.

Based on the worst configuration found above, the RF power setting is set individually to meet FCC compliance limit for the final conducted and radiated tests shown in section 2.3.

2.1 Carrier Frequency Channel

Frequency Band	Channel	Freq. (MHz)	Channel	Freq. (MHz)
2400-2483.5 MHz	1	2412	7	2442
	2	2417	8	2447
	3	2422	9	2452
	4	2427	10	2457
	5	2432	11	2462
	6	2437	-	-



2.2 Pre-Scanned RF Power

Preliminary tests were performed in different data rate and data rate associated with the highest power were chosen for full test shown in the following tables.

2.4GHz 802.11b mode				
Data Rate (MHz)	1M bps	2M bps	5.5M bps	11M bps
Peak Power (dBm)	14.76	14.71	14.75	14.73

2.4GHz 802.11g mode								
Data Rate (MHz)	6M bps	9M bps	12M bps	18M bps	24M bps	36M bps	48M bps	54M bps
Peak Power (dBm)	19.62	19.53	19.45	19.52	19.39	19.46	19.33	19.60

2.4GHz 802.11n HT20 mode								
Data Rate (MHz)	MCS0	MCS1	MCS2	MCS3	MCS4	MCS5	MCS6	MCS7
Peak Power (dBm)	18.82	18.55	18.65	18.73	18.61	18.71	18.51	18.62



2.3 Test Mode

Final test mode of conducted test items and radiated spurious emissions are considering the modulation and worse data rates from the power table described in section 2.2.

<2.4GHz>

Modulation	Data Rate
802.11b	1 Mbps
802.11g	6 Mbps
802.11n HT20	MCS0

Test Cases	
AC Conducted Emission	Mode 1 : GSM850 Idle + Bluetooth Link + WLAN Link + Earphone + USB Cable (Charging from Adapter)

2.4 Connection Diagram of Test System

<WLAN b Tx Mode>

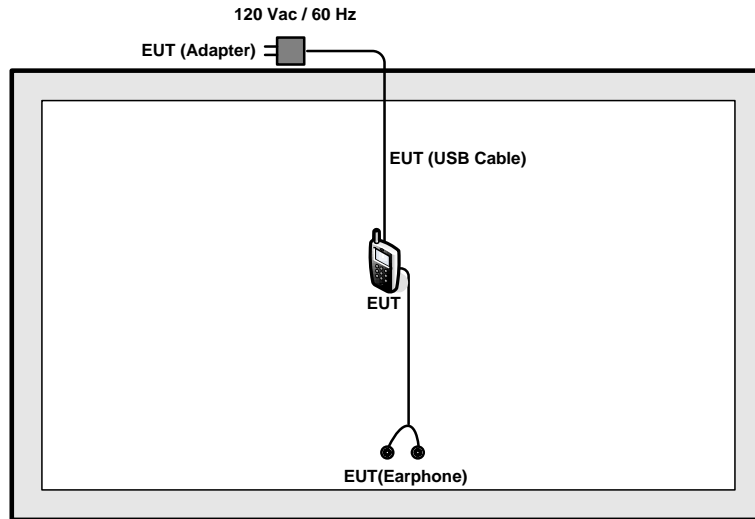

<WLAN g/n Tx Mode>

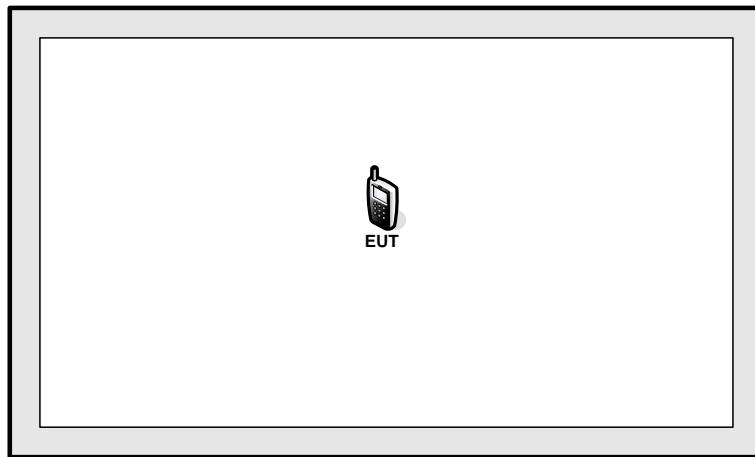

<AC Conducted Emission Mode>

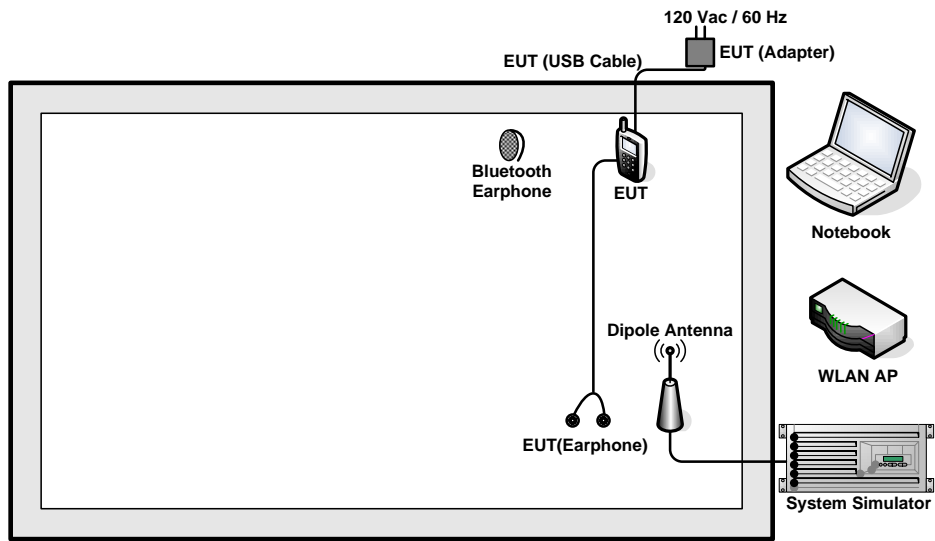

2.5 Support Unit used in test configuration and system

Item	Equipment	Trade Name	Model Name	FCC ID	Data Cable	Power Cord
1.	System Simulator	Anritus	MT8820C	N/A	N/A	Unshielded, 1.8 m
2.	WLAN AP	D-Link	DIR-855	KA2DIR855A2	N/A	Unshielded, 1.8 m
3.	Notebook	Lenovo	G480	PRC4	N/A	AC I/P: Unshielded, 1.8 m DC O/P: Shielded, 1.8 m
4.	SD Card	Kingstone	4GB	N/A	N/A	N/A
5.	Bluetooth Earphone	Lenovo	LBH505	N/A	N/A	N/A

2.6 EUT Operation Test Setup

For WLAN function, the engineering test program was provided and enabled to make EUT continuous transmit/receive.

For AC power line conducted emissions, the EUT was set to connect with the Notebook under large package sizes transmission.

2.7 Measurement Results Explanation Example

For all conducted test items:

The offset level is set in the spectrum analyzer to compensate the RF cable loss between EUT conducted output port and spectrum analyzer. With the offset compensation, the spectrum analyzer reading level is exactly the EUT RF output level.

Example :

The spectrum analyzer offset is derived from RF cable loss.

Offset = RF cable loss.

Following shows an offset computation example with cable loss 5.5 dB.

$$\begin{aligned} \text{Offset(dB)} &= \text{RF cable loss(dB)}. \\ &= 5.5 \text{ (dB)} \end{aligned}$$

3 Test Result

3.1 6dB and 99% Bandwidth Measurement

3.1.1 Limit of 6dB and 99% Bandwidth

The minimum 6 dB bandwidth shall be at least 500 kHz.

3.1.2 Measuring Instruments

The measuring equipment is listed in the section 4 of this test report.

3.1.3 Test Procedures

1. The testing follows FCC KDB Publication No. 558074 DTS D01 Meas. Guidance v03r03.
2. The RF output of EUT was connected to the spectrum analyzer by RF cable and attenuator. The path loss was compensated to the results for each measurement.
3. Set to the maximum power setting and enable the EUT transmit continuously.
4. Make the measurement with the spectrum analyzer's resolution bandwidth (RBW) = 100 kHz. Set the Video bandwidth (VBW) = 300 kHz. In order to make an accurate measurement. The 6 dB bandwidth must be greater than 500 kHz.
5. For 99% Bandwidth Measurement, the spectrum analyzer's resolution bandwidth (RBW) = 1MHz and set the Video bandwidth (VBW) = 3MHz.
6. Measure and record the results in the test report.

3.1.4 Test Setup





3.1.5 Test Result of 6dB and 99% Occupied Bandwidth

Please refer to Appendix A of this test report.

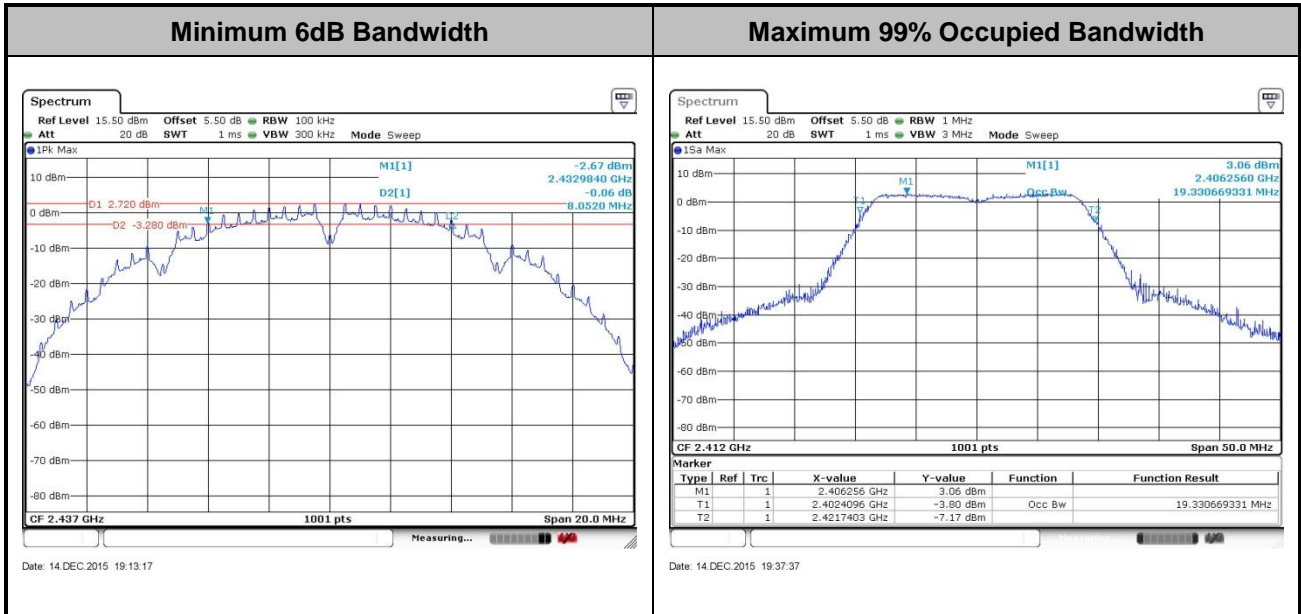

Note : The occupied channel bandwidth is maintained within the band of operation for all of the modulations.

3.2 Output Power Measurement

3.2.1 Limit of Output Power

For systems using digital modulation in the 2400-2483.5MHz, the limit for peak output power is 30dBm. If transmitting Antenna of directional gain greater than 6dBi are used the peak output power from the intentional radiator shall be reduced below the above stated value by the amount in dB that the directional gain of the Antenna exceeds 6 dBi. In case of point-to-point operation, the limit has to be reduced by 1dB for every 3dB that the directional gain of the Antenna exceeds 6dBi.

3.2.2 Measuring Instruments

The measuring equipment is listed in the section 4 of this test report.

3.2.3 Test Procedures

1. The testing follows the Measurement Procedure of FCC KDB No. 558074 DTS D01 Meas. Guidance v03r03 section 9.1.2 PKPM1 Peak power meter method.
2. The RF output of EUT was connected to the power meter by RF cable and attenuator. The path loss was compensated to the results for each measurement.
3. Set to the maximum power setting and enable the EUT transmit continuously.
4. Measure the conducted output power and record the results in the test report.

3.2.4 Test Setup

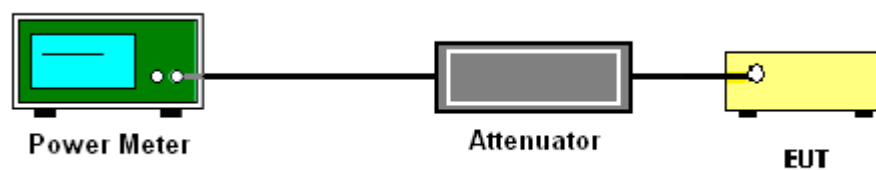



3.2.5 Test Result of Peak Output Power

Please refer to Appendix A of this test report.

3.2.6 Test Result of Average output Power (Reporting Only)

Please refer to Appendix A of this test report.

3.3 Power Spectral Density Measurement

3.3.1 Limit of Power Spectral Density

The peak power spectral density shall not be greater than 8dBm in any 3kHz band at any time interval of continuous transmission.

3.3.2 Measuring Instruments

The measuring equipment is listed in the section 4 of this test report.

3.3.3 Test Procedures

1. The testing follows Measurement Procedure 10.2 Method PKPSD of FCC KDB Publication No. 558074 D01 DTS Meas. Guidance v03r03
2. The RF output of EUT was connected to the spectrum analyzer by RF cable and attenuator. The path loss was compensated to the results for each measurement.
3. Set to the maximum power setting and enable the EUT transmit continuously.
4. Make the measurement with the spectrum analyzer's resolution bandwidth (RBW) = 3 kHz. Video bandwidth VBW = 10 kHz In order to make an accurate measurement, set the span to 1.5 times DTS Channel Bandwidth. (6dB BW)
5. Detector = peak, Sweep time = auto couple, Trace mode = max hold, Allow trace to fully stabilize. Use the peak marker function to determine the maximum power level.
6. Measure and record the results in the test report.

3.3.4 Test Setup





3.3.5 Test Result of Power Spectral Density

Please refer to Appendix A of this test report.

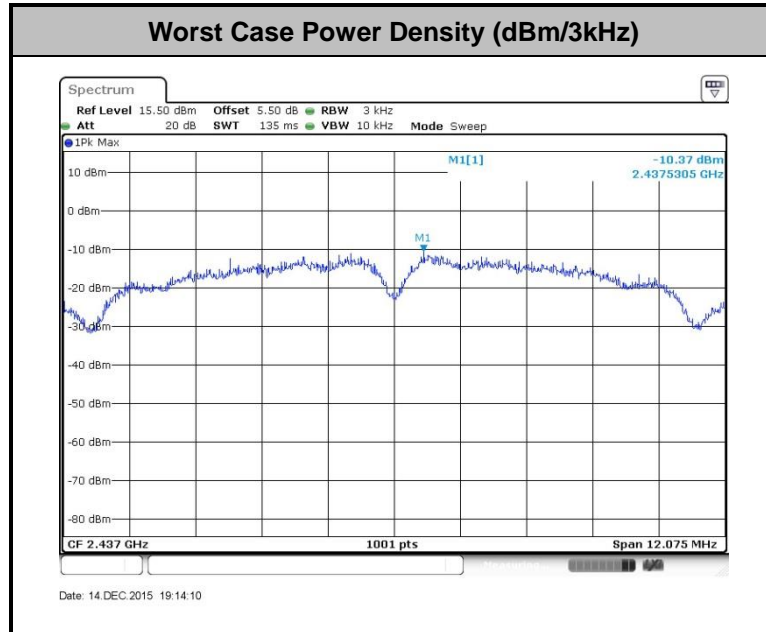

3.4 Conducted Band Edges and Spurious Emission Measurement

3.4.1 Limit of Conducted Band Edges and Spurious Emission Measurement

In any 100 kHz bandwidth outside of the authorized frequency band, the emissions which fall in the non-restricted bands shall be attenuated at least 20 dB / 30dB relative to the maximum PSD level in 100 kHz by RF conducted measurement and radiated emissions which fall in the restricted bands, as defined in Section 15.205(a), must also comply with the radiated emission limits specified in Section 15.209(a).

3.4.2 Measuring Instruments

The measuring equipment is listed in the section 4 of this test report.

3.4.3 Test Procedures

1. The testing follows FCC KDB Publication No. 558074 D01 DTS Meas. Guidance v03r03.
2. The RF output of EUT was connected to the spectrum analyzer by RF cable and attenuator. The path loss was compensated to the results for each measurement.
3. Set to the maximum power setting and enable the EUT transmit continuously.
4. Set RBW = 100 kHz, VBW=300 kHz, Peak Detector. Unwanted Emissions measured in any 100 kHz bandwidth outside of the authorized frequency band shall be attenuated by at least 20 dB relative to the maximum in-band peak PSD level in 100 kHz when maximum peak conducted output power procedure is used. If the transmitter complies with the conducted power limits based on the use of RMS averaging over a time interval, the attenuation required under this paragraph shall be 30 dB instead of 20 dB per 15.247(d).
5. Measure and record the results in the test report.
6. The RF fundamental frequency should be excluded against the limit line in the operating frequency band.

3.4.4 Test Setup

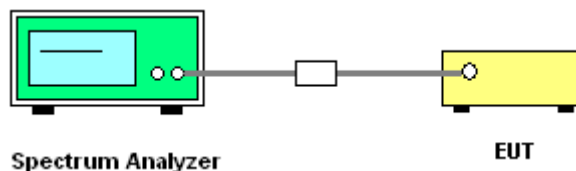



3.4.5 Test Result of Conducted Band Edges and Spurious Emission

Test Mode :	802.11b	Temperature :	24~25°C
Test Band :	2.4GHz Low	Relative Humidity :	49~51%
Test Channel :	01	Test Engineer :	Issac Song

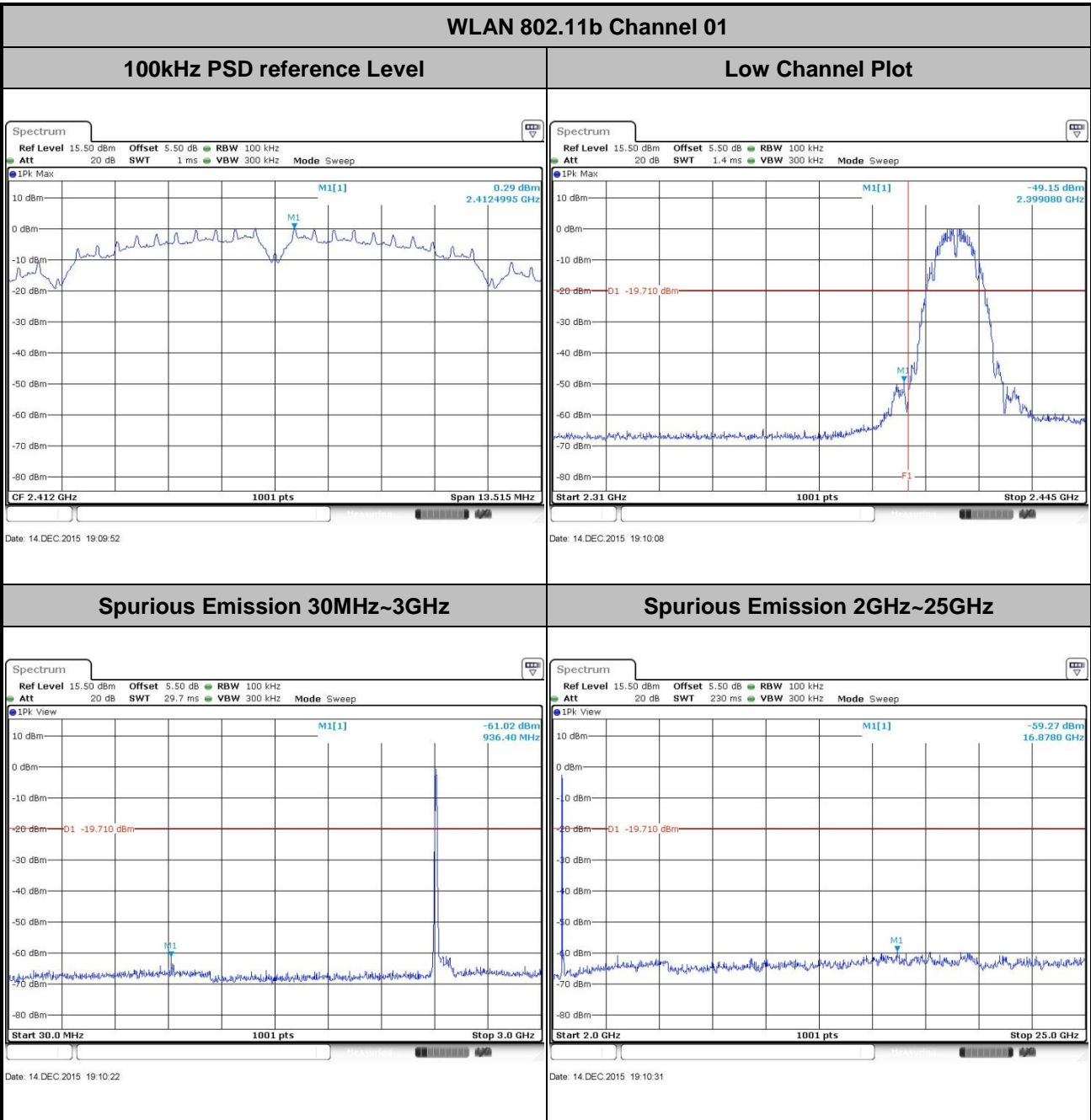



Test Mode :	802.11b	Temperature :	24~25°C
Test Band :	2.4GHz Mid	Relative Humidity :	49~51%
Test Channel :	06	Test Engineer :	Issac Song

WLAN 802.11b Channel 06

100kHz PSD reference Level

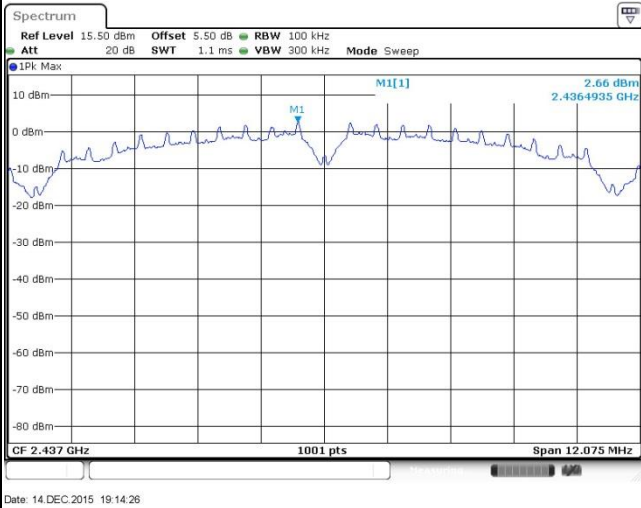

Spurious Emission 30MHz~3GHz

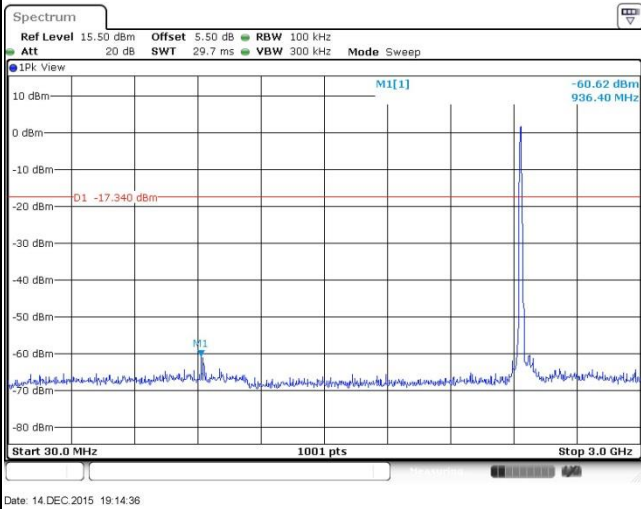

Spurious Emission 2GHz~25GHz

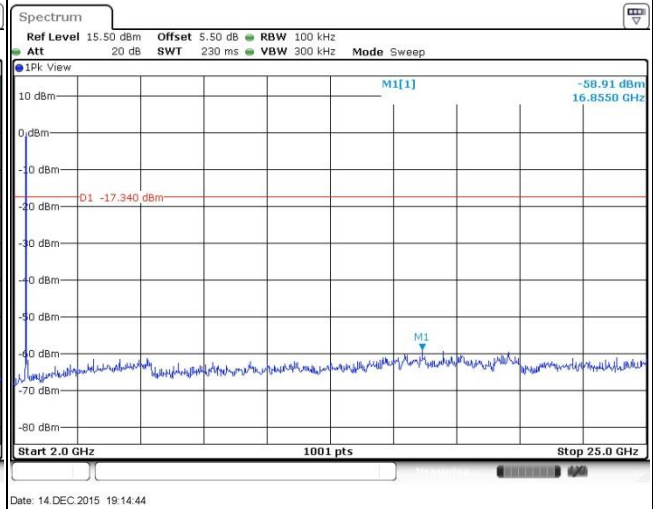



Test Mode :	802.11b	Temperature :	24~25°C
Test Band :	2.4GHz High	Relative Humidity :	49~51%
Test Channel :	11	Test Engineer :	Issac Song

WLAN 802.11b Channel 11

100kHz PSD reference Level

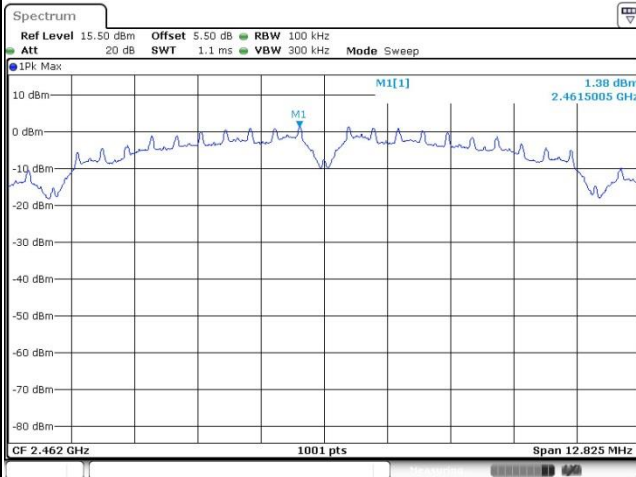

Date: 14 DEC.2015 19:17:55

High Channel Plot

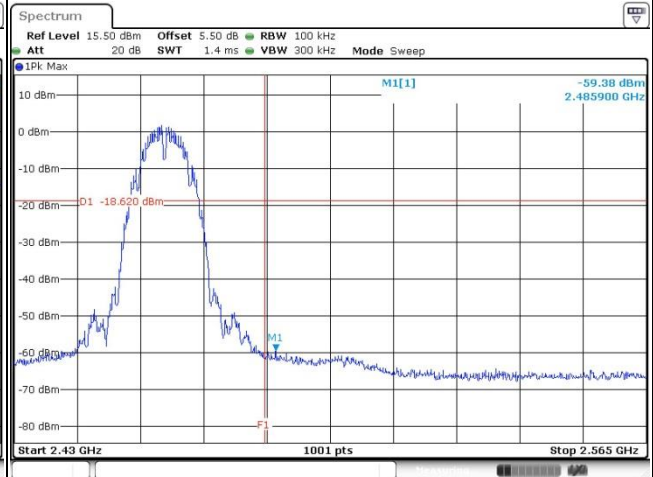

Date: 14 DEC.2015 19:18:10

Spurious Emission 30MHz~3GHz

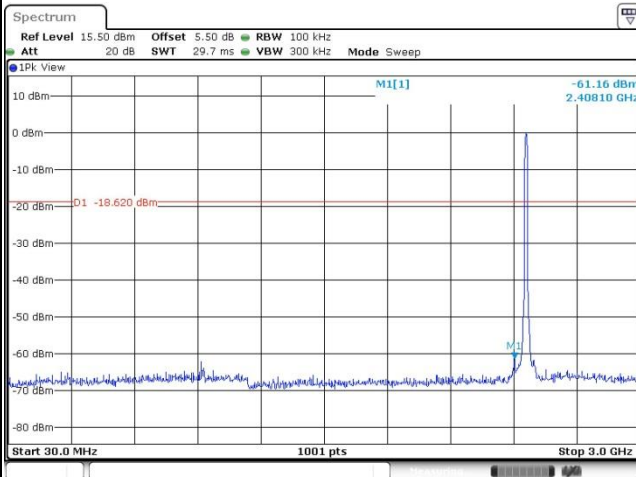

Date: 14 DEC.2015 19:18:23

Spurious Emission 2GHz~25GHz

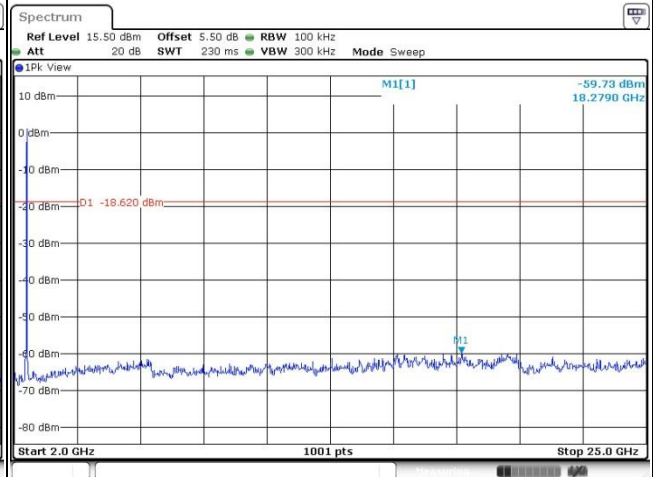

Date: 14 DEC.2015 19:18:32



Test Mode :	802.11g	Temperature :	24~25°C
Test Band :	2.4GHz Low	Relative Humidity :	49~51%
Test Channel :	01	Test Engineer :	Issac Song

WLAN 802.11g Channel 01

100kHz PSD reference Level

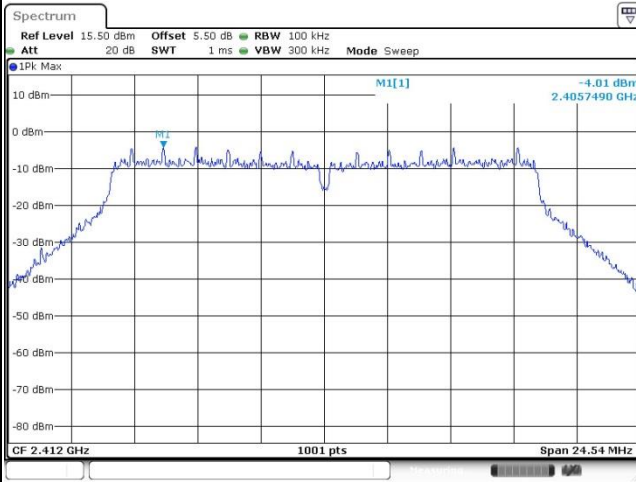

Date: 14 DEC.2015 19:21:19

Low Channel Plot

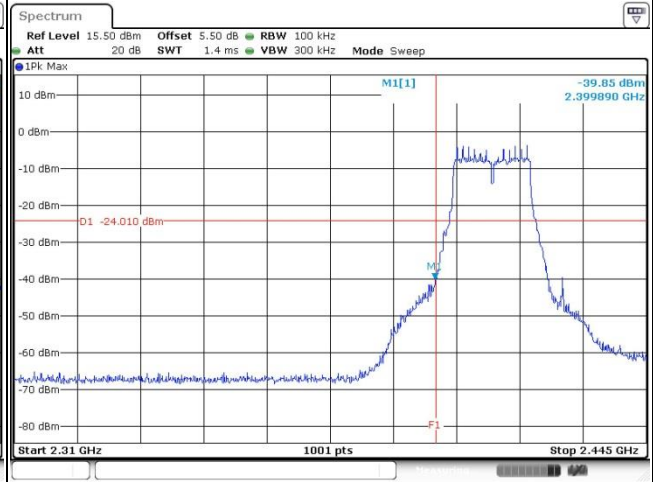

Date: 14 DEC.2015 19:22:17

Spurious Emission 30MHz~3GHz

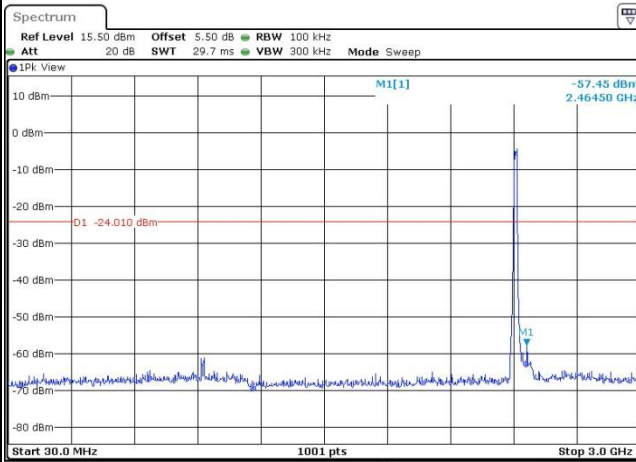

Date: 14 DEC.2015 19:23:14

Spurious Emission 2GHz~25GHz

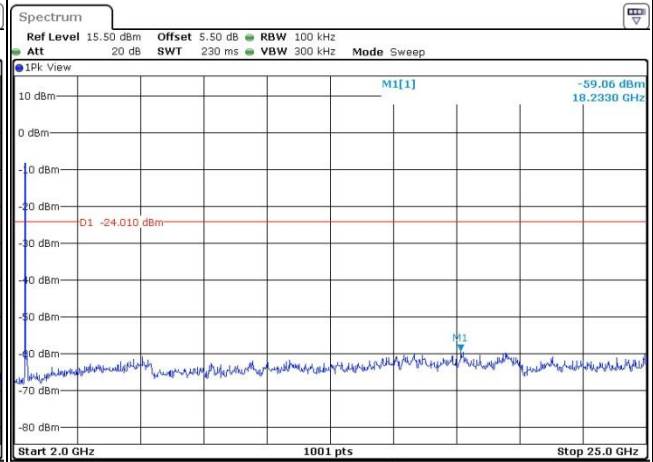

Date: 14 DEC.2015 19:23:22



Test Mode :	802.11g	Temperature :	24~25°C
Test Band :	2.4GHz Mid	Relative Humidity :	49~51%
Test Channel :	06	Test Engineer :	Issac Song

WLAN 802.11g Channel 06

100kHz PSD reference Level

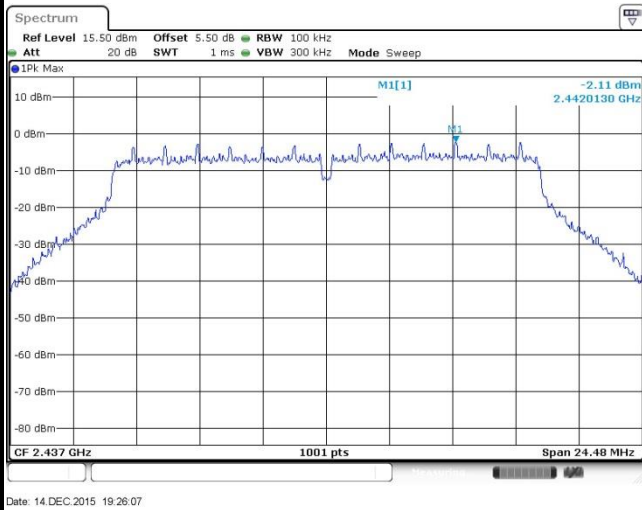

Spurious Emission 30MHz~3GHz

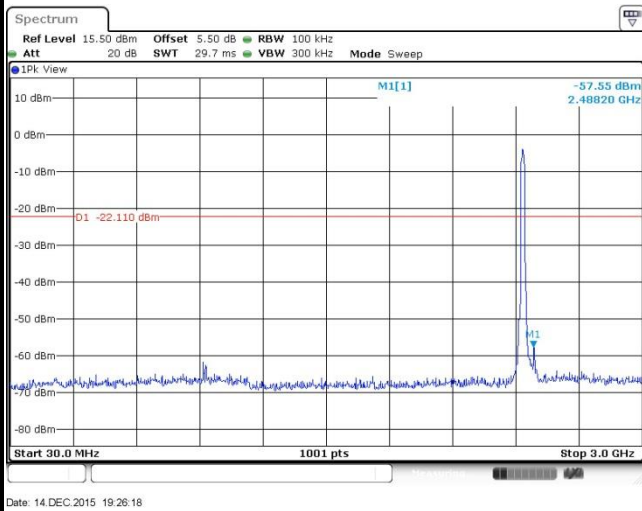

Spurious Emission 2GHz~25GHz

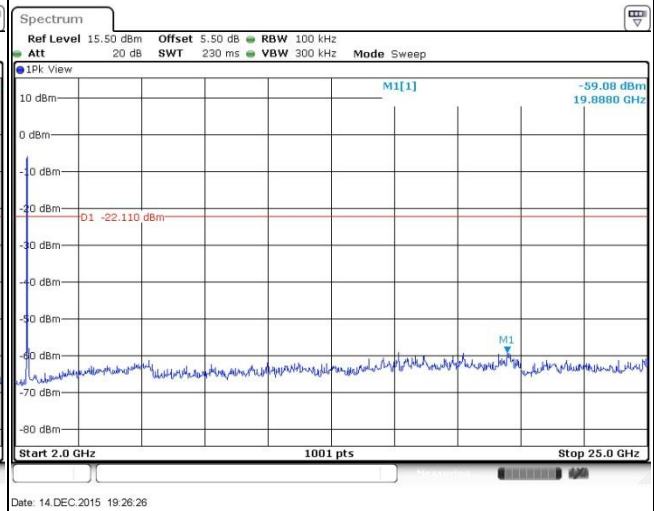



Test Mode :	802.11g	Temperature :	24~25°C
Test Band :	2.4GHz High	Relative Humidity :	49~51%
Test Channel :	11	Test Engineer :	Issac Song

WLAN 802.11g Channel 11

100kHz PSD reference Level

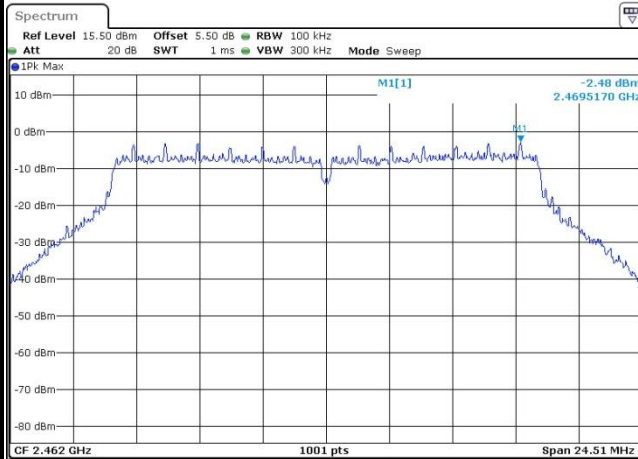

Date: 14 DEC.2015 19:29:31

High Channel Plot

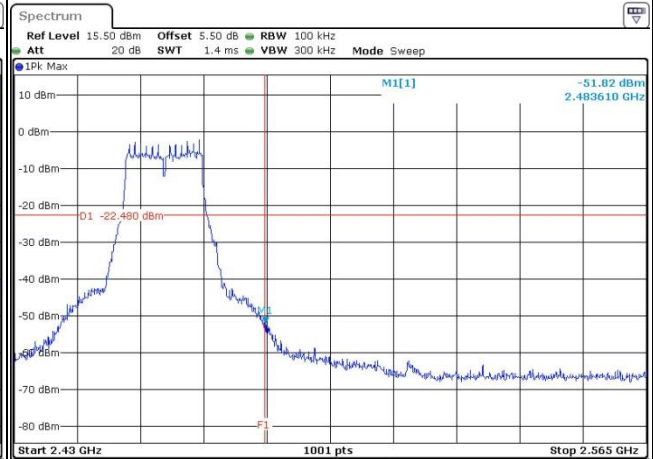

Date: 14 DEC.2015 19:29:52

Spurious Emission 30MHz~3GHz

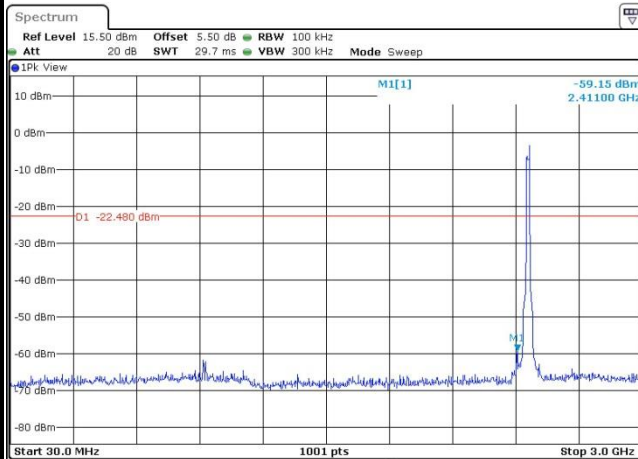

Date: 14 DEC.2015 19:31:01

Spurious Emission 2GHz~25GHz

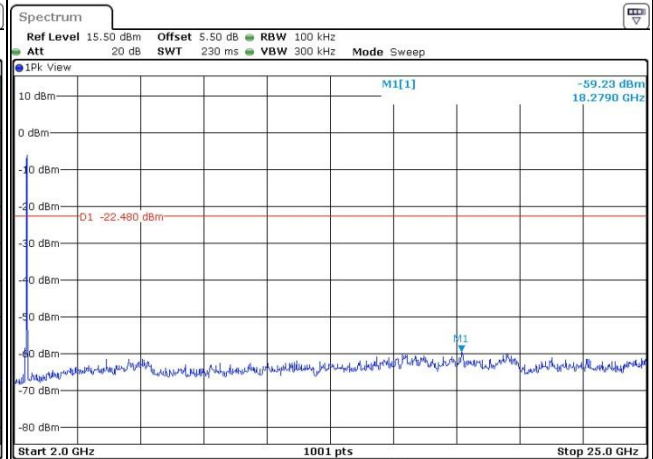

Date: 14 DEC.2015 19:31:09



Test Mode :	802.11n HT20	Temperature :	24~25°C
Test Band :	2.4GHz Low	Relative Humidity :	49~51%
Test Channel :	01	Test Engineer :	Issac Song

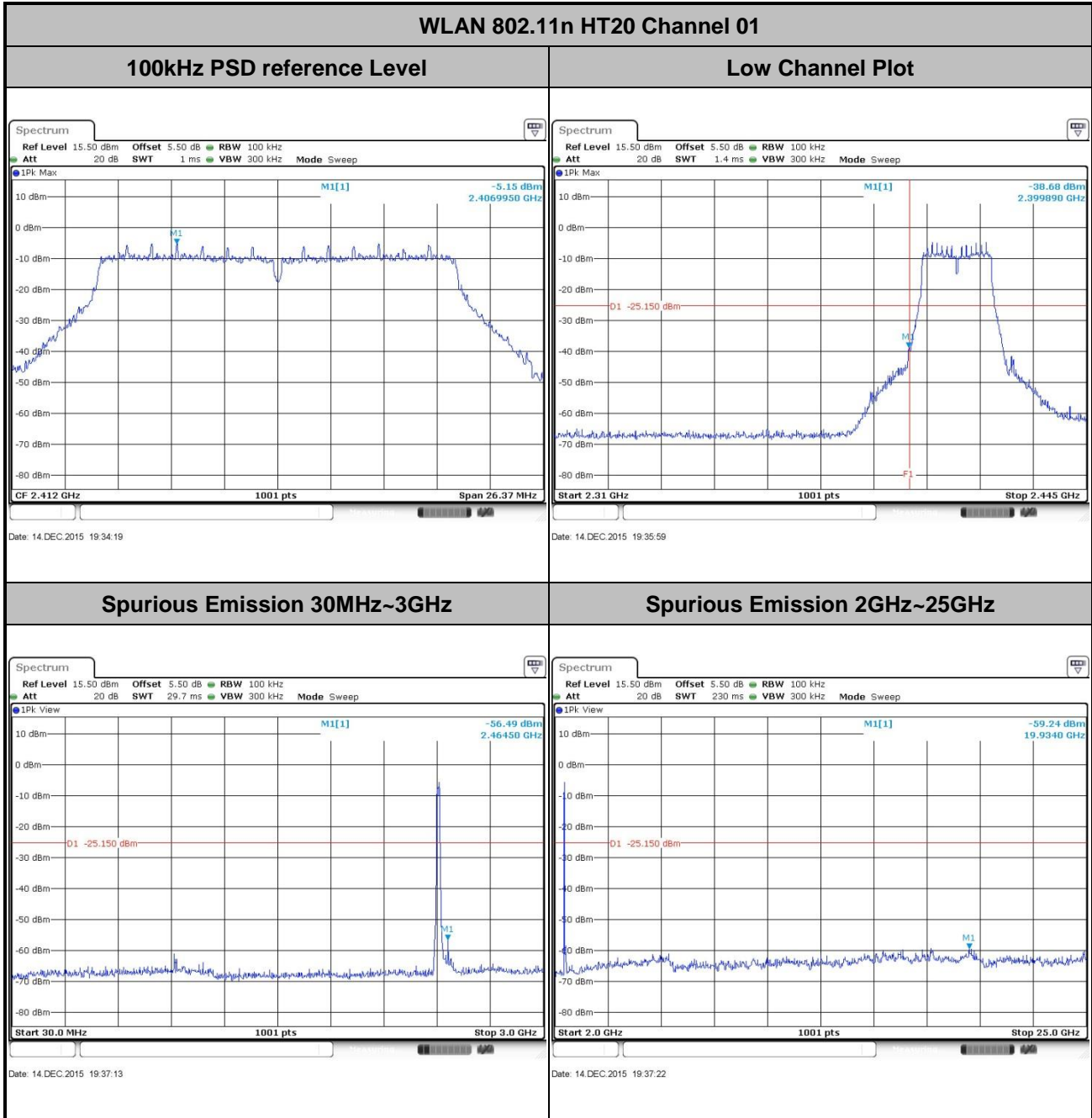



Test Mode :	802.11n HT20	Temperature :	24~25°C
Test Band :	2.4GHz Mid	Relative Humidity :	49~51%
Test Channel :	06	Test Engineer :	Issac Song

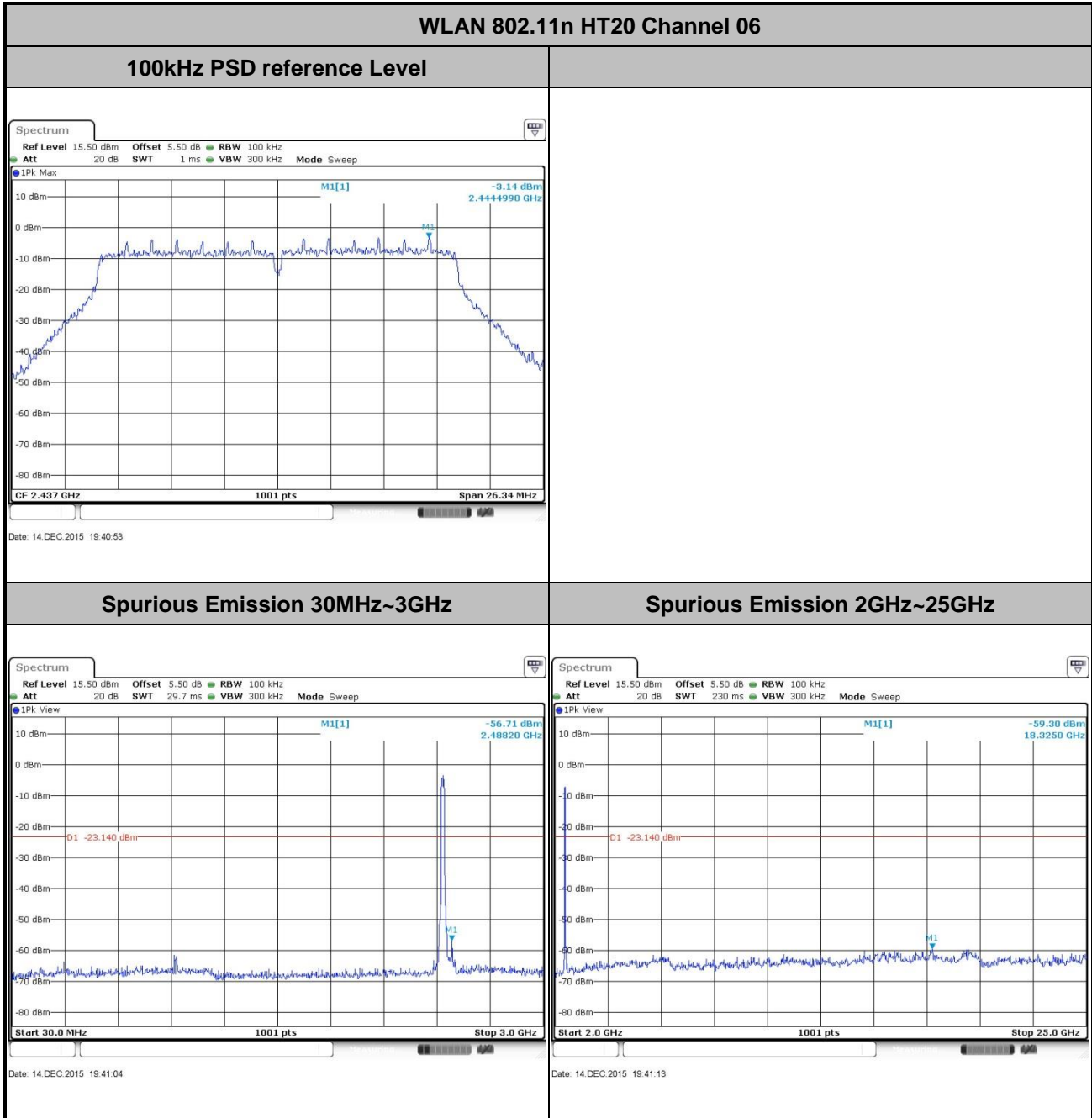



Test Mode :	802.11n HT20	Temperature :	24~25°C
Test Band :	2.4GHz High	Relative Humidity :	49~51%
Test Channel :	11	Test Engineer :	Issac Song

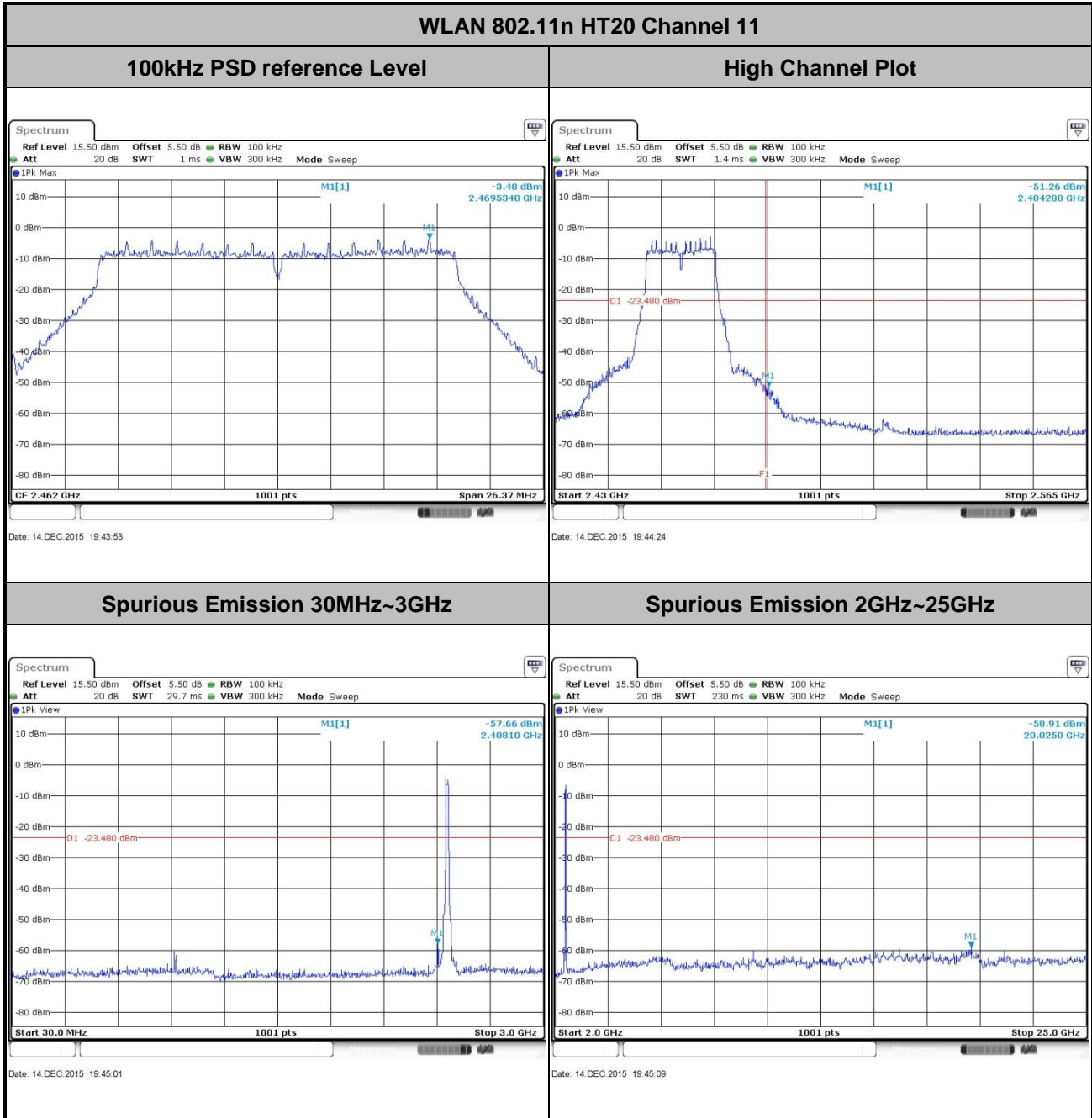



3.5 Radiated Band Edges and Spurious Emission Measurement

3.5.1 Limit of Radiated band edge and Spurious Emission Measurement

In any 100 kHz bandwidth outside the intentional radiator frequency band, all harmonics/spurious must be at least 20 dB below the highest emission level within the authorized band. If the output power of this device was measured by spectrum analyzer, the attenuation under this paragraph shall be 30 dB instead of 20 dB. In addition, radiated emissions which fall in the restricted bands must also comply with the FCC section 15.209 limits as below.

Frequency (MHz)	Field Strength (microvolts/meter)	Measurement Distance (meters)
0.009 – 0.490	2400/F(kHz)	300
0.490 – 1.705	24000/F(kHz)	30
1.705 – 30.0	30	30
30 – 88	100	3
88 – 216	150	3
216 - 960	200	3
Above 960	500	3

3.5.2 Measuring Instruments

The measuring equipment is listed in the section 4 of this test report.



3.5.3 Test Procedures

1. The testing follows FCC KDB Publication No. 558074 D01 DTS Meas. Guidance v03r03.
2. The EUT was arranged to its worst case and then tune the antenna tower (from 1 m to 4 m) and turntable (from 0 degree to 360 degrees) to find the maximum reading. A pre-amp and a high pass filter are used for the test in order to get better signal level.
3. The EUT was placed on a turntable with 0.8 meter for frequency below 1GHz and 1.5 meter for frequency above 1GHz respectively above ground.
4. The EUT was set 3 meters from the interference receiving antenna, which was mounted on the top of a variable height antenna tower.
5. Corrected Reading: Antenna Factor + Cable Loss + Read Level - Preamp Factor = Level
6. For measurement below 1GHz, If the emission level of the EUT measured by the peak detector is 3 dB lower than the applicable limit, the peak emission level will be reported. Otherwise, the emission measurement will be repeated using the quasi-peak detector and reported.
7. Use the following spectrum analyzer settings:
 - (1) Span shall wide enough to fully capture the emission being measured;
 - (2) Set RBW=100 kHz for $f < 1$ GHz; $VBW \geq RBW$; Sweep = auto; Detector function = peak; Trace = max hold;
 - (3) Set RBW = 1 MHz, VBW= 3MHz for $f \geq 1$ GHz for peak measurement.

For average measurement:

 - $VBW = 10$ Hz, when duty cycle is no less than 98 percent.
 - $VBW \geq 1/T$, when duty cycle is less than 98 percent where T is the minimum transmission duration over which the transmitter is on and is transmitting at its maximum power control level for the tested mode of operation.

Band	Duty Cycle(%)	T(ms)	1/T(kHz)	VBW Setting
802.11b	97.62	8.22	0.12	300Hz
802.11g	87.28	1.37	0.73	1KHz
2.4GHz 802.11n HT20	86.50	1.28	0.78	1KHz

3.5.4 Test Setup

For radiated emissions below 30MHz

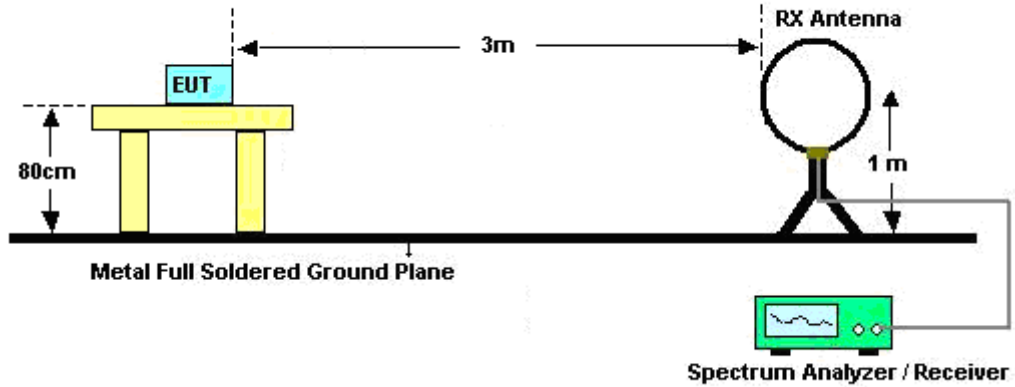

For radiated emissions from 30MHz to 1GHz

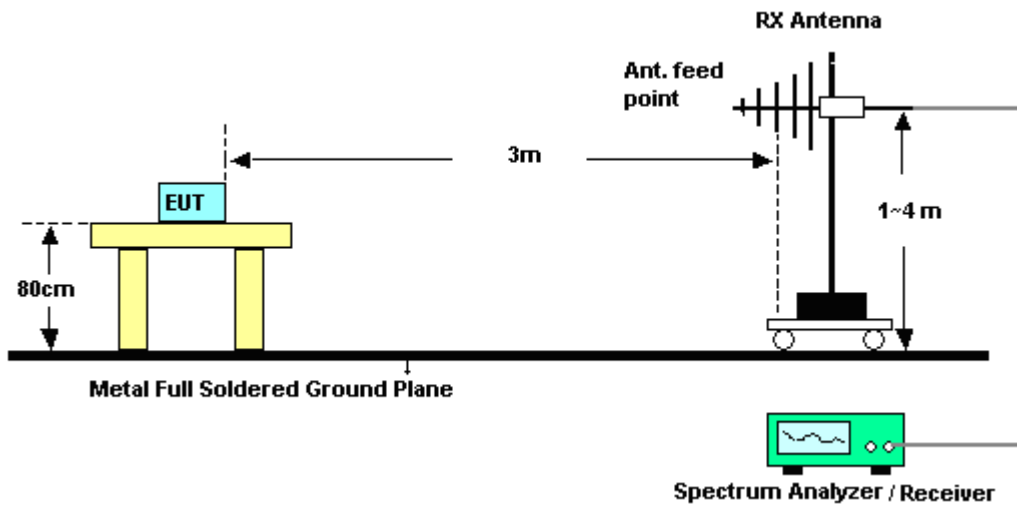

For radiated emissions above 1GHz

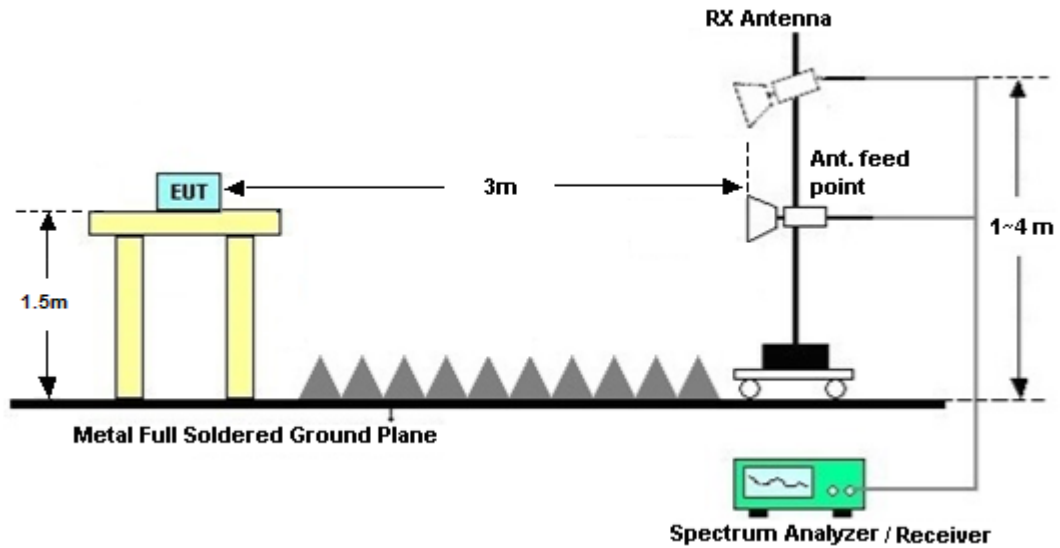

3.5.5 Test Results of Radiated Spurious Emissions (9kHz ~ 30MHz)

The low frequency, which started from 9 kHz to 30MHz, was pre-scanned and the result which was 20dB lower than the limit line per 15.31(o) was not reported.

3.5.6 Test Result of Radiated Spurious at Band Edges

Please refer to Appendix B.

3.5.7 Test Result of Radiated Spurious Emission (30MHz ~ 10th Harmonic)

Please refer to Appendix B.



3.6 AC Conducted Emission Measurement

3.6.1 Limit of AC Conducted Emission

For equipment that is designed to be connected to the public utility (AC) power line, the radio frequency voltage that is conducted back onto the AC power line on any frequency or frequencies within the band 150 kHz to 30 MHz shall not exceed the limits in the following table.

Frequency of Emission (MHz)	Conducted Limit (dB μ V)	
	Quasi-Peak	Average
0.15-0.5	66 to 56*	56 to 46*
0.5-5	56	46
5-30	60	50

*Decreases with the logarithm of the frequency.

3.6.2 Measuring Instruments

The measuring equipment is listed in the section 4 of this test report.

3.6.3 Test Procedures

1. The EUT was placed 0.4 meter from the conducting wall of the shielding room, and it was kept at least 80 centimeters from any other grounded conducting surface.
2. Connect EUT to the power mains through a line impedance stabilization network (LISN).
3. All the support units are connecting to the other LISN.
4. The LISN provides 50 ohm coupling impedance for the measuring instrument.
5. The FCC states that a 50 ohm, 50 microhenry LISN should be used.
6. Both sides of AC line were checked for maximum conducted interference.
7. The frequency range from 150 kHz to 30 MHz was searched.
8. Set the test-receiver system to Peak Detect Function and specified bandwidth (IF bandwidth = 9kHz) with Maximum Hold Mode.

3.6.4 Test Setup

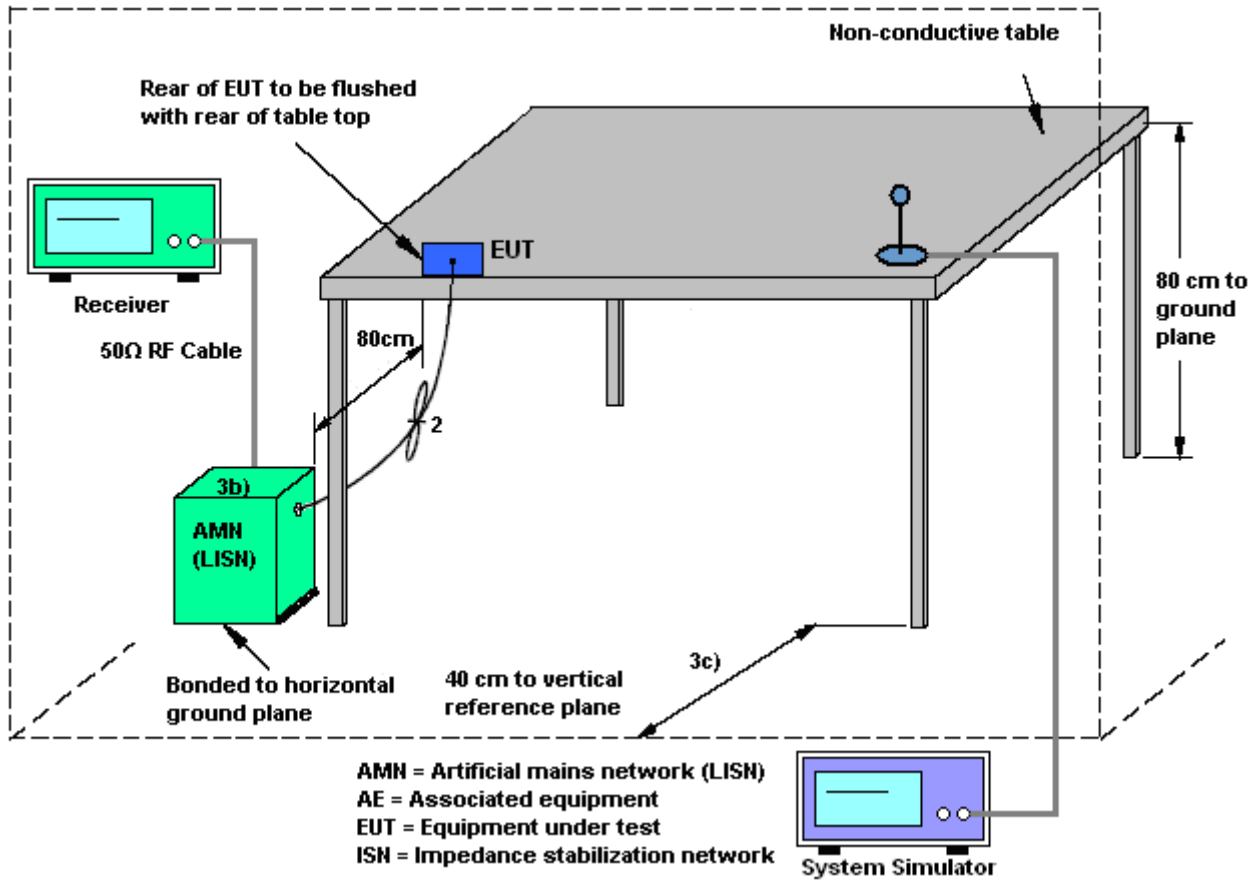



3.6.5 Test Result of AC Conducted Emission

Test Mode :	Mode 1	Temperature :	22~24°C
Test Engineer :	Amos Zhang	Relative Humidity :	45~47%
Test Voltage :	120Vac / 60Hz	Phase :	Line
Function Type :	GSM850 Idle + Bluetooth Link + WLAN Link + Earphone + USB Cable (Charging from Adapter)		

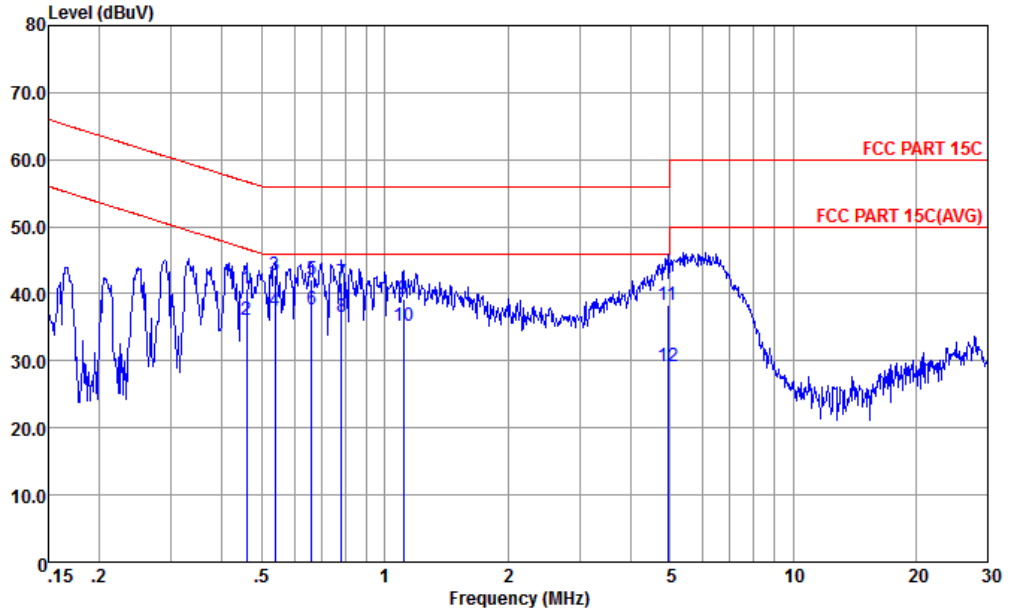

Site : CO01-kS
 Condition : FCC PART 15C LISN-L-20151024 LINE

mode : Mode 1
 : 868526021058115/868526021058123 #8

	Over	Limit	Read	LISN	Cable		
Freq	Level	Limit	Line	Level	Factor	Loss	Remark
MHz	dBuV	dB	dBuV	dBuV	dB	dB	
1	0.46	40.70	-16.01	56.71	30.30	0.23	10.17 QP
2	0.46	36.00	-10.71	46.71	25.60	0.23	10.17 Average
3	0.54	42.79	-13.21	56.00	32.40	0.23	10.16 QP
4	0.54	37.49	-8.51	46.00	27.10	0.23	10.16 Average
5	0.66	42.09	-13.91	56.00	31.70	0.24	10.15 QP
6 *	0.66	37.69	-8.31	46.00	27.30	0.24	10.15 Average
7	0.78	41.59	-14.41	56.00	31.20	0.24	10.15 QP
8	0.78	36.59	-9.41	46.00	26.20	0.24	10.15 Average
9	1.11	39.28	-16.72	56.00	28.90	0.24	10.14 QP
10	1.11	35.18	-10.82	46.00	24.80	0.24	10.14 Average
11	4.93	38.27	-17.73	56.00	27.90	0.19	10.18 QP
12	4.93	29.27	-16.73	46.00	18.90	0.19	10.18 Average



Test Mode :	Mode 1	Temperature :	22~24°C
Test Engineer :	Amos Zhang	Relative Humidity :	45~47%
Test Voltage :	120Vac / 60Hz	Phase :	Neutral
Function Type :	GSM850 Idle + Bluetooth Link + WLAN Link + Earphone + USB Cable (Charging from Adapter)		

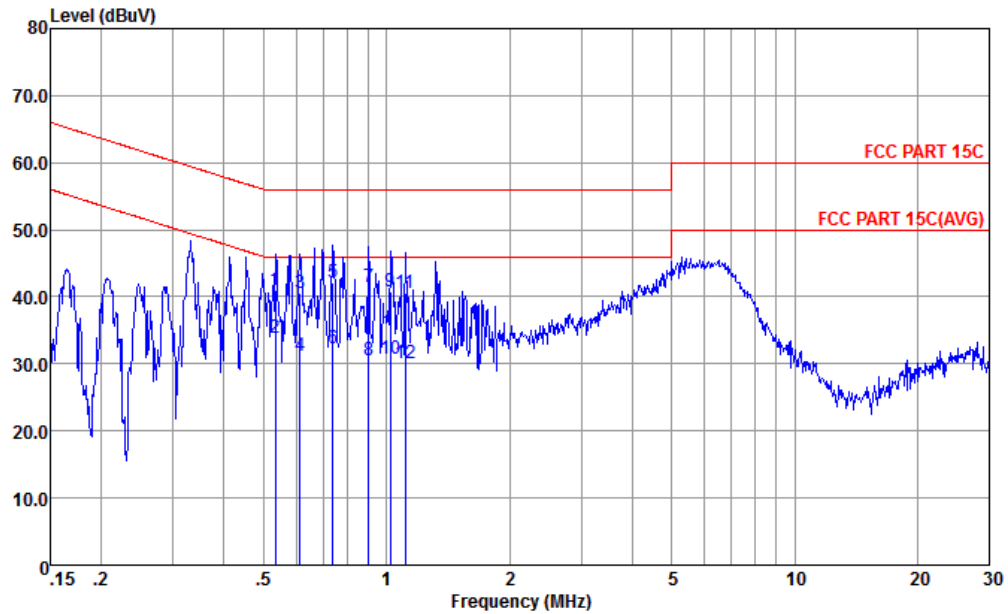

Site : CO01-kS
 Condition : FCC PART 15C LISN-N-20151024 NEUTRAL

mode : Mode 1
 : 868526021058115/868526021058123 #8

	Freq	Level	Over Limit	Limit	Read	LISN	Cable	Remark
	MHz	dBuV	dB	dBuV	dBuV	dB	dB	
1	0.53	41.09	-14.91	56.00	30.61	0.32	10.16	QP
2 *	0.53	33.89	-12.11	46.00	23.41	0.32	10.16	Average
3	0.61	40.59	-15.41	56.00	30.10	0.33	10.16	QP
4	0.61	31.29	-14.71	46.00	20.80	0.33	10.16	Average
5	0.74	42.19	-13.81	56.00	31.70	0.34	10.15	QP
6	0.74	32.39	-13.61	46.00	21.90	0.34	10.15	Average
7	0.90	41.40	-14.60	56.00	30.90	0.36	10.14	QP
8	0.90	30.60	-15.40	46.00	20.10	0.36	10.14	Average
9	1.02	40.71	-15.29	56.00	30.20	0.37	10.14	QP
10	1.02	30.71	-15.29	46.00	20.20	0.37	10.14	Average
11	1.11	40.61	-15.39	56.00	30.10	0.37	10.14	QP
12	1.11	30.01	-15.99	46.00	19.50	0.37	10.14	Average



3.7 Antenna Requirements

3.7.1 Standard Applicable

If directional gain of transmitting antennas is greater than 6dBi, the power shall be reduced by the same level in dB comparing to gain minus 6dBi. For the fixed point-to-point operation, the power shall be reduced by one dB for every 3 dB that the directional gain of the antenna exceeds 6 dBi. The use of a permanently attached antenna or of an antenna that uses a unique coupling to the intentional radiator shall be considered sufficient to comply with the FCC rule.

3.7.2 Antenna Anti-Replacement Construction

An embedded-in antenna design is used.

3.7.3 Antenna Gain

The antenna peak gain of EUT is less than 6 dBi. Therefore, it is not necessary to reduce maximum peak output power limit.



4 List of Measuring Equipment

Instrument	Manufacturer	Model No.	Serial No.	Characteristics	Calibration Date	Test Date	Due Date	Remark
Spectrum Analyzer	R&S	FSV30	101338	9kHz~30GHz	May 04, 2015	Dec. 14, 2015	May 03, 2016	Conducted (TH01-KS)
Pulse Power Sensor	Anritsu	MA2411B	0917070	30MHz~40GHz	Jan. 23, 2015	Dec. 14, 2015	Jan. 22, 2016	Conducted (TH01-KS)
Power Meter	Anritsu	ML2495A	1005002	50MHz Bandwidth	Jan. 23, 2015	Dec. 14, 2015	Jan. 22, 2016	Conducted (TH01-KS)
EMI Receiver	R&S	ESCI7	100768	9kHz~7GHz;	May 04, 2015	Dec. 11, 2015	May 03, 2016	Conduction (CO01-KS)
AC LISN	MessTec	AN3016	060103	9kHz~30MHz	Oct. 24, 2015	Dec. 11, 2015	Oct. 23, 2016	Conduction (CO01-KS)
AC LISN (for auxiliary equipment)	MessTec	AN3016	060105	9kHz~30MHz	Oct. 24, 2015	Dec. 11, 2015	Oct. 23, 2016	Conduction (CO01-KS)
AC Power Source	Chroma	61602	ABP00000811	AC 0V~300V, 45Hz~1000Hz	Oct. 24, 2015	Dec. 11, 2015	Oct. 23, 2016	Conduction (CO01-KS)
EMI Test Receiver	R&S	ESR7	101403	9kHz~7GHz;Max 30dBm	Sep. 10, 2015	Dec. 17, 2015	Sep. 09, 2016	Radiation (03CH03-KS)
EXA Spectrum Analyzer	Keysight	N9010A	MY55150244	10Hz-44GHz	Jun. 05, 2015	Dec. 17, 2015	Jun. 04, 2016	Radiation (03CH03-KS)
Loop Antenna	R&S	HFH2-Z2	100321	9kHz~30MHz	Nov. 10, 2015	Dec. 17, 2015	Nov. 09, 2016	Radiation (03CH03-KS)
Bilog Antenna	TeseQ	CBL6112D	35406	25MHz-2GHz	Jun. 25, 2015	Dec. 17, 2015	Jun. 24, 2016	Radiation (03CH03-KS)
Horn Antenna	Schwarzbeck	BBHA9120D	9120D-1356	1GHz~18GHz	Jun. 25, 2015	Dec. 17, 2015	Jun. 24, 2016	Radiation (03CH03-KS)
SHF-EHF Horn	Schwarzbeck	BBHA 9170	BBHA170249	15GHz ~40GHz	Mar. 03, 2015	Dec. 17, 2015	Mar. 02, 2016	Radiation (03CH03-KS)
Amplifier	Burgeon	BPA-530	102212	0.01MHz-3000MHz	Aug. 10, 2015	Dec. 17, 2015	Aug. 09, 2016	Radiation (03CH03-KS)
Amplifier	MITEQ	TTA1840-35-HG	1887435	18~40GHz	Aug. 27, 2015	Dec. 17, 2015	Aug. 26, 2016	Radiation (03CH03-KS)
high gain Amplifier	MITEQ	AMF-7D-0010 1800-30-10P	1889560	1GHz-18GHz	Aug. 10, 2015	Dec. 17, 2015	Aug. 09, 2016	Radiation (03CH03-KS)
Amplifier	Agilent	8449B	3008A02370	1GHz~26.5GHz	Oct. 24, 2015	Dec. 17, 2015	Oct. 23, 2016	Radiation (03CH03-KS)
AC Power Source	Chroma	61601	F104090004	N/A	NCR	Dec. 17, 2015	NCR	Radiation (03CH03-KS)
Turn Table	ChamPro	EM 1000-T	060762-T	0~360 degree	NCR	Dec. 17, 2015	NCR	Radiation (03CH03-KS)



5 Uncertainty of Evaluation

Uncertainty of Conducted Emission Measurement (150kHz ~ 30MHz)

Measuring Uncertainty for a Level of Confidence of 95% ($U = 2Uc(y)$)	2.3 dB
---	--------

Uncertainty of Radiated Emission Measurement (30 MHz ~ 1000 MHz)

Measuring Uncertainty for a Level of Confidence of 95% ($U = 2Uc(y)$)	4.5 dB
---	--------



Appendix A. Conducted Test Results

A1 - DTS Part

Test Engineer:	Issac Song	Temperature:	24~25	°C
Test Date:	2015/12/14	Relative Humidity:	49~51	%

TEST RESULTS DATA
6dB and 99% Occupied Bandwidth

2.4GHz Band								
Mod.	Data Rate	NTX	CH.	Freq. (MHz)	99% Occupied BW (MHz)	6dB BW (MHz)	6dB BW Limit (MHz)	Pass/Fail
11b	1Mbps	1	1	2412	13.49	9.01	0.50	Pass
11b	1Mbps	1	6	2437	13.29	8.05	0.50	Pass
11b	1Mbps	1	11	2462	13.49	8.55	0.50	Pass
11g	6Mbps	1	1	2412	18.63	16.36	0.50	Pass
11g	6Mbps	1	6	2437	18.43	16.32	0.50	Pass
11g	6Mbps	1	11	2462	18.73	16.34	0.50	Pass
HT20	MCS0	1	1	2412	19.33	17.58	0.50	Pass
HT20	MCS0	1	6	2437	19.13	17.56	0.50	Pass
HT20	MCS0	1	11	2462	19.33	17.58	0.50	Pass

TEST RESULTS DATA
Peak Power Table

2.4GHz Band										
Mod.	Data Rate	NTX	CH.	Freq. (MHz)	Peak Conducted Power (dBm)	Conducted Power Limit (dBm)	DG (dBi)	EIRP Power (dBm)	EIRP Power Limit (dBm)	Pass /Fail
11b	1Mbps	1	1	2412	12.44	30.00	0.75	13.19	36.00	Pass
11b	1Mbps	1	6	2437	14.76	30.00	0.75	15.51	36.00	Pass
11b	1Mbps	1	11	2462	13.86	30.00	0.75	14.61	36.00	Pass
11g	6Mbps	1	1	2412	18.09	30.00	0.75	18.84	36.00	Pass
11g	6Mbps	1	6	2437	19.62	30.00	0.75	20.37	36.00	Pass
11g	6Mbps	1	11	2462	19.37	30.00	0.75	20.12	36.00	Pass
HT20	MCS0	1	1	2412	17.03	30.00	0.75	17.78	36.00	Pass
HT20	MCS0	1	6	2437	18.82	30.00	0.75	19.57	36.00	Pass
HT20	MCS0	1	11	2462	18.35	30.00	0.75	19.10	36.00	Pass

TEST RESULTS DATA
Average Power Table
(Reporting Only)

2.4GHz Band						
Mod.	Data Rate	NTX	CH.	Freq. (MHz)	Duty Factor (dB)	Average Conducted Power (dBm)
11b	1Mbps	1	1	2412	0.10	9.68
11b	1Mbps	1	6	2437	0.10	11.98
11b	1Mbps	1	11	2462	0.10	11.17
11g	6Mbps	1	1	2412	0.59	8.28
11g	6Mbps	1	6	2437	0.59	10.01
11g	6Mbps	1	11	2462	0.59	9.57
HT20	MCS0	1	1	2412	0.63	7.28
HT20	MCS0	1	6	2437	0.63	9.08
HT20	MCS0	1	11	2462	0.63	8.50

TEST RESULTS DATA
Peak Power Density

2.4GHz Band								
Mod.	Data Rate	NTX	CH.	Freq. (MHz)	Peak PSD (dBm /3kHz)	DG (dBi)	Peak PSD Limit (dBm /3kHz)	Pass/Fail
11b	1Mbps	1	1	2412	-13.22	0.75	8.00	Pass
11b	1Mbps	1	6	2437	-10.37	0.75	8.00	Pass
11b	1Mbps	1	11	2462	-12.21	0.75	8.00	Pass
11g	6Mbps	1	1	2412	-18.15	0.75	8.00	Pass
11g	6Mbps	1	6	2437	-15.51	0.75	8.00	Pass
11g	6Mbps	1	11	2462	-16.47	0.75	8.00	Pass
HT20	MCS0	1	1	2412	-18.90	0.75	8.00	Pass
HT20	MCS0	1	6	2437	-16.78	0.75	8.00	Pass
HT20	MCS0	1	11	2462	-17.02	0.75	8.00	Pass



Appendix B. Radiated Spurious Emission

2.4GHz 2400~2483.5MHz

WIFI 802.11b (Band Edge @ 3m)

WIFI Ant.	Note	Frequency	Level	Over Limit	Limit Line	Read Level	Antenna Factor	Cable Loss	Preamp Factor	Ant Pos	Table Pos	Peak Avg.	Pol.
1		(MHz)	(dBμV/m)	(dB)	(dBμV/m)	(dBμV)	(dB/m)	(dB)	(dB)	(cm)	(deg)	(P/A)	(H/V)
802.11b CH 01 2412MHz		2362.2	50.92	-23.08	74	55.49	26.91	5.54	37.02	139	268	P	H
		2388.57	40.13	-13.87	54	44.56	27	5.59	37.02	139	268	A	H
	*	2412.024	97.33	-	-	101.59	27.13	5.61	37	139	268	P	H
	*	2413.193	94.24	-	-	98.5	27.13	5.61	37	139	268	A	H
		2350.5	51.23	-22.77	74	55.86	26.86	5.52	37.01	377	321	P	V
		2385.96	40.04	-13.96	54	44.47	27	5.59	37.02	377	321	A	V
	*	2412.024	95.31	-	-	99.57	27.13	5.61	37	377	321	P	V
	*	2411.189	92.76	-	-	97.02	27.13	5.61	37	377	321	A	V
802.11b CH 06 2437MHz	*	2437.074	99.35	-	-	103.28	27.39	5.65	36.97	100	290	P	H
	*	2435.989	96.74	-	-	100.84	27.26	5.63	36.99	100	290	A	H
	*	2436.99	95.05	-	-	98.98	27.39	5.65	36.97	379	49	P	V
	*	2438.159	92.27	-	-	96.2	27.39	5.65	36.97	379	49	A	V
802.11b CH 11 2462MHz	*	2460.872	98.9	-	-	102.68	27.51	5.67	36.96	135	266	P	H
	*	2461.039	96.47	-	-	100.25	27.51	5.67	36.96	135	266	A	H
		2488.88	52.02	-21.98	74	55.47	27.77	5.71	36.93	135	266	P	H
		2487.6	41.33	-12.67	54	44.78	27.77	5.71	36.93	135	266	A	H
	*	2460.955	96.1	-	-	99.88	27.51	5.67	36.96	360	264	P	V
	*	2460.955	93.65	-	-	97.43	27.51	5.67	36.96	360	264	A	V
		2490.08	51.77	-22.23	74	55.22	27.77	5.71	36.93	360	264	P	V
		2487.6	41.33	-12.67	54	44.78	27.77	5.71	36.93	360	264	A	V
Remark	1. No other spurious found. 2. All results are PASS against Peak and Average limit line.												



2.4GHz 2400~2483.5MHz
WIFI 802.11b (Harmonic @ 3m)

Table with 14 columns: WIFI Ant. 1, Note, Frequency (MHz), Level (dBµV/m), Over Limit (dB), Limit Line (dBµV/m), Read Level (dBµV), Antenna Factor (dB/m), Cable Loss (dB), Preamp Factor (dB), Ant Pos (cm), Table Pos (deg), Peak Avg. (P/A), Pol. (H/V). Rows include data for CH 01 (2412MHz) and CH 06 (2437MHz) and CH 11 (2462MHz).



**2.4GHz 2400~2483.5MHz
WIFI 802.11g (Band Edge @ 3m)**

WIFI Ant. 1	Note	Frequency (MHz)	Level (dBμV/m)	Over Limit (dB)	Limit Line (dBμV/m)	Read Level (dBμV)	Antenna Factor (dB/m)	Cable Loss (dB)	Preamp Factor (dB)	Ant Pos (cm)	Table Pos (deg)	Peak Avg. (P/A)	Pol. (H/V)
802.11g CH 01 2412MHz		2382.99	51.9	-22.1	74	56.4	26.95	5.57	37.02	300	45	P	H
		2389.47	40.46	-13.54	54	44.89	27	5.59	37.02	300	45	A	H
	*	2417.284	95.79	-	-	100.05	27.13	5.61	37	300	45	P	H
	*	2418.704	87.87	-	-	92.13	27.13	5.61	37	300	45	A	H
		2390	53.28	-20.72	74	57.71	27	5.59	37.02	100	71	P	V
		2390	41.15	-12.85	54	45.58	27	5.59	37.02	100	71	A	V
	*	2418.454	98.99	-	-	103.25	27.13	5.61	37	100	71	P	V
	*	2419.289	91.33	-	-	95.59	27.13	5.61	37	100	71	A	V
802.11g CH 06 2437MHz	*	2431.313	96.78	-	-	100.88	27.26	5.63	36.99	305	146	P	H
	*	2432.648	88.45	-	-	92.55	27.26	5.63	36.99	305	146	A	H
	*	2432.398	100.27	-	-	104.37	27.26	5.63	36.99	100	65	P	V
	*	2432.064	92.36	-	-	96.46	27.26	5.63	36.99	100	65	A	V
802.11g CH 11 2462MHz	*	2468.553	96.89	-	-	100.67	27.51	5.67	36.96	293	44	P	H
	*	2467.719	88.72	-	-	92.5	27.51	5.67	36.96	293	44	A	H
		2483.92	54.78	-19.22	74	58.39	27.64	5.69	36.94	293	44	P	H
		2483.52	42.53	-11.47	54	46.14	27.64	5.69	36.94	293	44	A	H
	*	2467.552	98.69	-	-	102.47	27.51	5.67	36.96	116	7	P	V
	*	2458.7	90.52	-	-	94.3	27.51	5.67	36.96	116	7	A	V
		2483.6	55.68	-18.32	74	59.29	27.64	5.69	36.94	116	7	P	V
		2483.52	42.73	-11.27	54	46.34	27.64	5.69	36.94	116	7	A	V
Remark	1. No other spurious found. 2. All results are PASS against Peak and Average limit line.												



2.4GHz 2400~2483.5MHz
WIFI 802.11g (Harmonic @ 3m)

Table with 14 columns: WIFI Ant. 1, Note, Frequency (MHz), Level (dBµV/m), Over Limit (dB), Limit Line (dBµV/m), Read Level (dBµV), Antenna Factor (dB/m), Cable Loss (dB), Preamp Factor (dB), Ant Pos (cm), Table Pos (deg), Peak Avg. (P/A), Pol. (H/V). Rows include data for CH 01 (2412MHz) and CH 06 (2437MHz) and CH 11 (2462MHz).



**2.4GHz 2400~2483.5MHz
WIFI 802.11n HT20 (Band Edge @ 3m)**

WIFI Ant. 1	Note	Frequency (MHz)	Level (dBμV/m)	Over Limit (dB)	Limit Line (dBμV/m)	Read Level (dBμV)	Antenna Factor (dB/m)	Cable Loss (dB)	Preamp Factor (dB)	Ant Pos (cm)	Table Pos (deg)	Peak Avg. (P/A)	Pol. (H/V)
802.11n HT20 CH 01 2412MHz		2389.83	52.06	-21.94	74	56.49	27	5.59	37.02	300	120	P	H
		2389.83	40.63	-13.37	54	45.06	27	5.59	37.02	300	120	A	H
	*	2417.618	96.32	-	-	100.58	27.13	5.61	37	300	120	P	H
	*	2419.706	88.28	-	-	92.38	27.26	5.63	36.99	300	120	A	H
		2389.56	52.61	-21.39	74	57.04	27	5.59	37.02	126	121	P	V
		2390	40.91	-13.09	54	45.34	27	5.59	37.02	126	121	A	V
	*	2417.201	97.52	-	-	101.78	27.13	5.61	37	126	121	P	V
	*	2418.704	89.31	-	-	93.57	27.13	5.61	37	126	121	A	V
802.11n HT20 CH 06 2437MHz	*	2436.823	97.93	-	-	101.86	27.39	5.65	36.97	378	39	P	H
	*	2440.999	88.83	-	-	92.76	27.39	5.65	36.97	378	39	A	H
	*	2432.481	98.46	-	-	102.56	27.26	5.63	36.99	100	72	P	V
	*	2432.147	90.83	-	-	94.93	27.26	5.63	36.99	100	72	A	V
802.11n HT20 CH 11 2462MHz	*	2458.45	96.33	-	-	100.11	27.51	5.67	36.96	327	50	P	H
	*	2457.615	87.69	-	-	91.47	27.51	5.67	36.96	327	50	A	H
		2484.32	54.29	-19.71	74	57.9	27.64	5.69	36.94	327	50	P	H
		2484.12	42.01	-11.99	54	45.62	27.64	5.69	36.94	327	50	A	H
	*	2455.361	96.9	-	-	100.68	27.51	5.67	36.96	100	21	P	V
	*	2458.032	88.73	-	-	92.51	27.51	5.67	36.96	100	21	A	V
		2484.12	54.21	-19.79	74	57.82	27.64	5.69	36.94	100	21	P	V
	2483.52	42.59	-11.41	54	46.2	27.64	5.69	36.94	100	21	A	V	
Remark	1. No other spurious found. 2. All results are PASS against Peak and Average limit line.												



2.4GHz 2400~2483.5MHz
WIFI 802.11n HT20 (Harmonic @ 3m)

Table with 14 columns: WIFI Ant. 1, Note, Frequency (MHz), Level (dBµV/m), Over Limit (dB), Limit Line (dBµV/m), Read Level (dBµV), Antenna Factor (dB/m), Cable Loss (dB), Preamp Factor (dB), Ant Pos (cm), Table Pos (deg), Peak Avg. (P/A), Pol. (H/V). Rows include test data for 802.11n HT20 CH 01 (2412MHz), CH 06 (2437MHz), and CH 11 (2462MHz).

- 1. No other spurious found.
2. All results are PASS against Peak and Average limit line.



Emission below 1GHz
2.4GHz WIFI 802.11g (LF)

Table with 14 columns: WIFI, Note, Frequency, Level, Over, Limit, Read, Antenna, Cable, Preamp, Ant, Table, Peak, Pol. It contains 12 rows of test data for 2.4GHz WIFI 802.11g LF and a Remark section at the bottom.



Note symbol

*	Fundamental Frequency which can be ignored. However, the level of any unwanted emissions shall not exceed the level of the fundamental frequency.
!	Test result is over limit line.
P/A	Peak or Average
H/V	Horizontal or Vertical



A calculation example for radiated spurious emission is shown as below:

WIFI	Note	Frequency	Level	Over	Limit	Read	Antenna	Cable	Preamp	Ant	Table	Peak	Pol.
Ant.				Limit	Line	Level	Factor	Loss	Factor	Pos	Pos	Avg.	
1		(MHz)	(dBμV/m)	(dB)	(dBμV/m)	(dBμV)	(dB/m)	(dB)	(dB)	(cm)	(deg)	(P/A)	(H/V)
802.11b		2390	55.45	-18.55	74	54.51	32.22	4.58	35.86	103	308	P	H
CH 01													
2412MHz		2390	43.54	-10.46	54	42.6	32.22	4.58	35.86	103	308	A	H

- Level(dBμV/m) =
Antenna Factor(dB/m) + Cable Loss(dB) + Read Level(dBμV) - Preamp Factor(dB)
- Over Limit(dB) = Level(dBμV/m) – Limit Line(dBμV/m)

For Peak Limit @ 2390MHz:

- Level(dBμV/m)
= Antenna Factor(dB/m) + Cable Loss(dB) + Read Level(dBμV) - Preamp Factor(dB)
= 32.22(dB/m) + 4.58(dB) + 54.51(dBμV) – 35.86 (dB)
= 55.45 (dBμV/m)
- Over Limit(dB)
= Level(dBμV/m) – Limit Line(dBμV/m)
= 55.45(dBμV/m) – 74(dBμV/m)
= -18.55(dB)

For Average Limit @ 2390MHz:

- Level(dBμV/m)
= Antenna Factor(dB/m) + Cable Loss(dB) + Read Level(dBμV) - Preamp Factor(dB)
= 32.22(dB/m) + 4.58(dB) + 42.6(dBμV) – 35.86 (dB)
= 43.54 (dBμV/m)
- Over Limit(dB)
= Level(dBμV/m) – Limit Line(dBμV/m)
= 43.54(dBμV/m) – 54(dBμV/m)
= -10.46(dB)

Both peak and average measured complies with the limit line, so test result is “PASS”.



Appendix D. Product Equality Declaration

Lenovo Mobile Communication Technology Ltd.
No.999, Qishan North 2nd Road, Information & Optoelectronics Park, Torch
Hi-tech Industry Development Zone, Xiamen, P.R.China
Tel: 86-10-58866181; Fax: 86-10-56720293

Date: February 2, 2016

Product Equality Declaration

We, Lenovo Mobile Communication Technology Ltd., declare on our sole responsibility for the product of **Lenovo A6020I36** as below:

The differences between Lenovo A6020I36 and previous as below:

1. Main antenna is different.
2. Charger is different, and the model of charger is C-P35, the output is 5.2V/2.0A.

Except listings above, the others are all the same.

Should you have any questions or comments regarding this matter, please have my best attention.

Sincerely yours,

Contact Person:

Li Wei

COMPANY: Lenovo Mobile Communication Technology Ltd.

Tel: +86-18116117204

E-Mail: liwei26@lenovo.com