



FCC SAR Test Report

Report No. : SA131203C01

Applicant : Lenovo Mobile Communication Technology Ltd.

Address : No. 999, Qishan North 2nd Road, Information & Optoelectronics Park, Torch Hi-tech Industry Development Zone, Xiamen, P.R.China

Product : Lenovo Mobile Phone

FCC ID : YCNA526

Brand : lenovo

Model No. : Lenovo A526

Standards : FCC 47 CFR Part 2 (2.1093) / IEEE C95.1:1992 / IEEE 1528:2003
 IEEE 1528a-2005 / KDB 865664 D01 v01r02
 KDB 248227 D01 v01r02 / KDB 447498 D01 v05r01 / KDB 648474 D04 v01r02
 KDB 941225 D01 v02 / KDB 941225 D02 v02r02 / KDB 941225 D03 v01
 KDB 941225 D06 v01r01

Sample Received Date : Dec. 03, 2013

Date of Testing : Dec. 13, 2013 ~ Dec. 20, 2013

CERTIFICATION: The above equipment have been tested by **Bureau Veritas Consumer Products Services (H.K.) Ltd., Taoyuan Branch – Lin Kou Laboratories**, and found compliance with the requirement of the above standards. The test record, data evaluation & Equipment Under Test (EUT) configurations represented herein are true and accurate accounts of the measurements of the sample’s SAR characteristics under the conditions specified in this report. It should not be reproduced except in full, without the written approval of our laboratory. The client should not use it to claim product certification, approval, or endorsement by TAF or any government agencies.

Prepared By : 
 Vera Huang / Specialist

Approved By : 
 Gordon Lin / Assistant Manager



This report is for your exclusive use. Any copying or replication of this report to or for any other person or entity, or use of our name or trademark, is permitted only with our prior written permission. This report sets forth our findings solely with respect to the test samples identified herein. The results set forth in this report are not indicative or representative of the quality or characteristics of the lot from which a test sample was taken or any similar or identical product unless specifically and expressly noted. Our report includes all of the tests requested by you and the results thereof based upon the information that you provided to us. You have 60 days from date of issuance of this report to notify us of any material error or omission caused by our negligence, provided, however, that such notice shall be in writing and shall specifically address the issue you wish to raise. A failure to raise such issue within the prescribed time shall constitute your unqualified acceptance of the completeness of this report, the tests conducted and the correctness of the report contents. Unless specific mention, the uncertainty of measurement has been explicitly taken into account to declare the compliance or non-compliance to the specification.



Table of Contents

| | |
|---|----|
| Release Control Record | 3 |
| 1. Summary of Maximum SAR Value | 4 |
| 2. Description of Equipment Under Test | 5 |
| 3. SAR Measurement System | 6 |
| 3.1 Definition of Specific Absorption Rate (SAR) | 6 |
| 3.2 SPEAG DASY System | 6 |
| 3.2.1 Robot..... | 7 |
| 3.2.2 Probes..... | 8 |
| 3.2.3 Data Acquisition Electronics (DAE) | 8 |
| 3.2.4 Phantoms | 9 |
| 3.2.5 Device Holder..... | 10 |
| 3.2.6 System Validation Dipoles | 10 |
| 3.2.7 Tissue Simulating Liquids..... | 11 |
| 3.3 SAR System Verification | 14 |
| 3.4 SAR Measurement Procedure | 15 |
| 3.4.1 Area & Zoom Scan Procedure | 15 |
| 3.4.2 Volume Scan Procedure..... | 15 |
| 3.4.3 Power Drift Monitoring..... | 16 |
| 3.4.4 Spatial Peak SAR Evaluation | 16 |
| 3.4.5 SAR Averaged Methods | 16 |
| 4. SAR Measurement Evaluation | 17 |
| 4.1 EUT Configuration and Setting..... | 17 |
| 4.2 EUT Testing Position | 19 |
| 4.2.1 Head Exposure Conditions..... | 19 |
| 4.2.2 Body-Worn Accessory Exposure Conditions | 21 |
| 4.2.3 Hotspot Mode Exposure conditions..... | 22 |
| 4.2.4 SAR Test Exclusions | 22 |
| 4.3 Issue Verification | 23 |
| 4.4 System Validation..... | 23 |
| 4.5 System Verification..... | 23 |
| 4.6 Maximum Output Power..... | 24 |
| 4.6.1 Maximum Conducted Power | 24 |
| 4.6.2 Measured Conducted Power Result..... | 25 |
| 4.7 SAR Testing Results | 26 |
| 4.7.1 SAR Results for Head | 26 |
| 4.7.2 SAR Results for Body-Worn (Separation Distance is 1.0 cm Gap) | 27 |
| 4.7.3 SAR Results for Hotspot (Separation Distance is 1.0 cm Gap)..... | 28 |
| 4.7.4 SAR Measurement Variability..... | 29 |
| 4.7.5 Simultaneous Multi-band Transmission Evaluation | 30 |
| 5. Calibration of Test Equipment..... | 34 |
| 6. Measurement Uncertainty..... | 35 |
| 7. Information on the Testing Laboratories | 36 |

- Appendix A. SAR Plots of System Verification
- Appendix B. SAR Plots of SAR Measurement
- Appendix C. Calibration Certificate for Probe and Dipole
- Appendix D. Photographs of EUT and Setup



Release Control Record

| Issue No. | Reason for Change | Date Issued |
|-----------|-------------------|---------------|
| R01 | Initial release | Dec. 23, 2013 |
| | | |
| | | |
| | | |



FCC SAR Test Report

1. Summary of Maximum SAR Value

| Equipment Class | Mode | Highest Reported Head SAR _{1g} (W/kg) | Highest Reported Body-Worn SAR _{1g} (1.0 cm Gap) (W/kg) | Highest Reported Hotspot SAR _{1g} (1.0 cm Gap) (W/kg) |
|---------------------------------------|-----------|--|--|--|
| PCE | GSM850 | 0.34 | 0.79 | 0.79 |
| | GSM1900 | 0.37 | 1.43 | 1.43 |
| | WCDMA II | 0.29 | 1.14 | 1.14 |
| | WCDMA V | 0.21 | 0.48 | 0.48 |
| DTS | 2.4G WLAN | 0.18 | 0.07 | 0.07 |
| DSS | Bluetooth | N/A | N/A | N/A |
| Highest Simultaneous Transmission SAR | | Head (W/kg) | Body-Worn (W/kg) | Hotspot (W/kg) |
| PCE+DTS | | 0.52 | 1.50 | 1.50 |
| PCE+DSS | | N/A | 1.49 | N/A |

Note:

1. The SAR limit (**Head & Body: SAR_{1g} 1.6 W/kg**) for general population / uncontrolled exposure is specified in FCC 47 CFR part 2 (2.1093) and ANSI/IEEE C95.1-1992.

2. Description of Equipment Under Test

| | |
|--|---|
| EUT Type | Lenovo Mobile Phone |
| FCC ID | YCNA526 |
| Brand Name | lenovo |
| Model Name | Lenovo A526 |
| EUT Configuration | EUT 1: Phone + LCD Module 1 + Camera Module 1 + Touch Panel 1 + IC MCP 1 EUT 2: Phone + LCD Module 2 + Camera Module 2 + Touch Panel 2 + IC MCP 2 |
| MID | 52600031 |
| Tx Frequency Bands (Unit: MHz) | GSM850 : 824.2 ~ 848.8 GSM1900 : 1850.2 ~ 1909.8 WCDMA Band II : 1852.4 ~ 1907.6 WCDMA Band V : 826.4 ~ 846.6 WLAN : 2412 ~ 2462 Bluetooth : 2402 ~ 2480 |
| Uplink Modulations | GSM & GPRS : GMSK EDGE : 8PSK WCDMA : QPSK 802.11b : DSSS 802.11g/n : OFDM Bluetooth : GFSK |
| Maximum Tune-up Conducted Power (Unit: dBm) | GSM850 : 32.5 GSM1900 : 30.0 WCDMA Band II : 23.5 WCDMA Band V : 23.5 WLAN 2.4G : 11.5 Bluetooth : 4.5 |
| Antenna Type | Fixed Internal Antenna |
| EUT Stage | Identical Prototype |

Note:

- The above EUT information is declared by manufacturer and for more detailed features description please refers to the manufacturer's specifications or User's Manual.

List of Accessory:

| | | |
|-----------------|-------------------------|---|
| Battery | Brand Name | lenovo |
| | Model Name | BL192 |
| | Power Rating | 4.2Vdc, 2000mAh |
| | Type | Li-ion |
| Earphone | Brand Name | lenovo |
| | Model Name | TS300-01MS21-8S |
| | Signal Line Type | 1.6 meter non-shielded cable without ferrite core |

3. SAR Measurement System

3.1 Definition of Specific Absorption Rate (SAR)

SAR is related to the rate at which energy is absorbed per unit mass in an object exposed to a radio field. The SAR distribution in a biological body is complicated and is usually carried out by experimental techniques or numerical modeling. The standard recommends limits for two tiers of groups, occupational/controlled and general population/uncontrolled, based on a person's awareness and ability to exercise control over his or her exposure. In general, occupational/controlled exposure limits are higher than the limits for general population/uncontrolled.

The SAR definition is the time derivative (rate) of the incremental energy (dW) absorbed by (dissipated in) an incremental mass (dm) contained in a volume element (dv) of a given density (ρ). The equation description is as below:

$$\text{SAR} = \frac{d}{dt} \left(\frac{dW}{dm} \right) = \frac{d}{dt} \left(\frac{dW}{\rho dv} \right)$$

SAR is expressed in units of Watts per kilogram (W/kg)

SAR measurement can be related to the electrical field in the tissue by

$$\text{SAR} = \frac{\sigma |E|^2}{\rho}$$

Where: σ is the conductivity of the tissue, ρ is the mass density of the tissue and E is the RMS electrical field strength.

3.2 SPEAG DASY System

DASY system consists of high precision robot, probe alignment sensor, phantom, robot controller, controlled measurement server and near-field probe. The robot includes six axes that can move to the precision position of the DASY4/5 software defined. The DASY software can define the area that is detected by the probe. The robot is connected to controlled box. Controlled measurement server is connected to the controlled robot box. The DAE includes amplifier, signal multiplexing, AD converter, offset measurement and surface detection. It is connected to the Electro-optical coupler (ECO). The ECO performs the conversion from the optical into digital electric signal of the DAE and transfers data to the PC.

FCC SAR Test Report

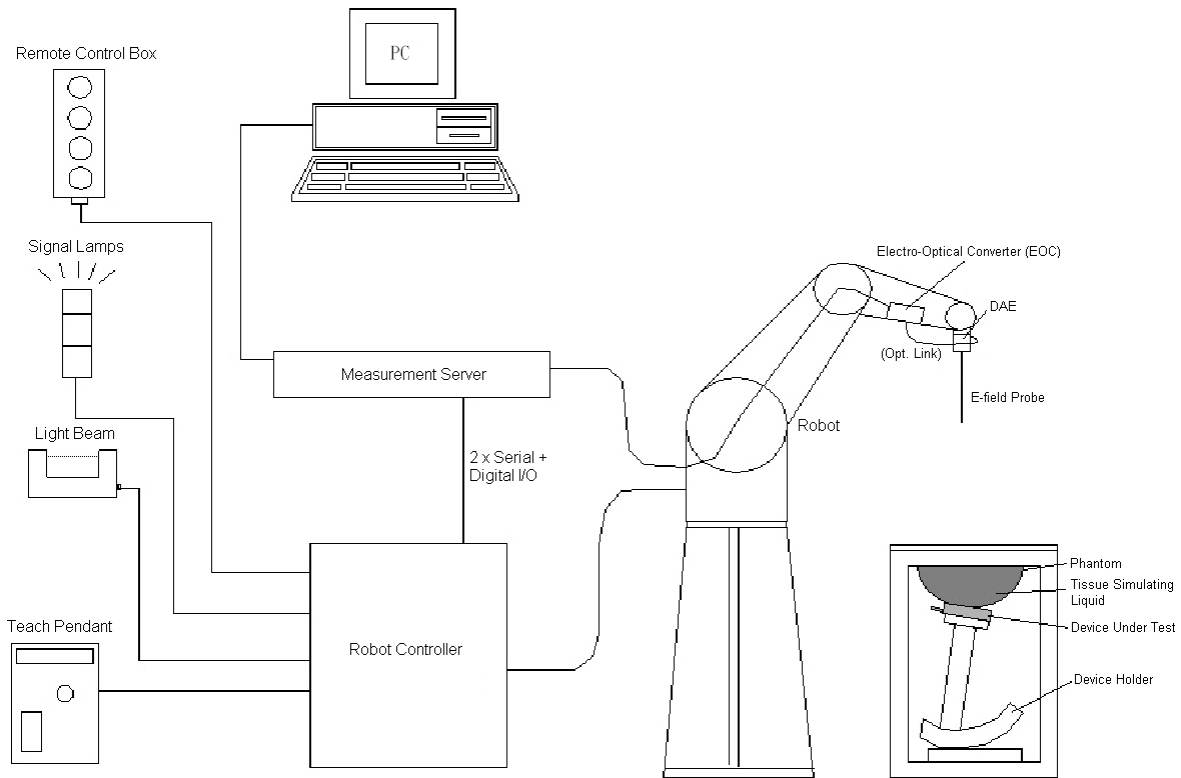

Fig-3.1 DASY System Setup

3.2.1 Robot

The DASY system uses the high precision robots from Stäubli SA (France). For the 6-axis controller system, the robot controller version (DASY4: CS7MB; DASY5: CS8c) from Stäubli is used. The Stäubli robot series have many features that are important for our application:

- High precision (repeatability ± 0.035 mm)
- High reliability (industrial design)
- Jerk-free straight movements
- Low ELF interference (the closed metallic construction shields against motor control fields)



Fig-3.2 DASY4





Fig-3.3 DASY5

FCC SAR Test Report

3.2.2 Probes

The SAR measurement is conducted with the dosimetric probe. The probe is specially designed and calibrated for use in liquid with high permittivity. The dosimetric probe has special calibration in liquid at different frequency.

| | | |
|----------------------|--|---|
| Model | EX3DV4 |  |
| Construction | Symmetrical design with triangular core. Built-in shielding against static charges. PEEK enclosure material (resistant to organic solvents, e.g., DGBE). | |
| Frequency | 10 MHz to 6 GHz Linearity: ± 0.2 dB | |
| Directivity | ± 0.3 dB in HSL (rotation around probe axis) ± 0.5 dB in tissue material (rotation normal to probe axis) | |
| Dynamic Range | 10 μ W/g to 100 mW/g Linearity: ± 0.2 dB (noise: typically < 1 μ W/g) | |
| Dimensions | Overall length: 337 mm (Tip: 20 mm) Tip diameter: 2.5 mm (Body: 12 mm) Typical distance from probe tip to dipole centers: 1 mm | |

| | | |
|----------------------|---|--|
| Model | ES3DV3 |  |
| Construction | Symmetrical design with triangular core. Interleaved sensors. Built-in shielding against static charges. PEEK enclosure material (resistant to organic solvents, e.g., DGBE). | |
| Frequency | 10 MHz to 4 GHz Linearity: ± 0.2 dB | |
| Directivity | ± 0.2 dB in HSL (rotation around probe axis) ± 0.3 dB in tissue material (rotation normal to probe axis) | |
| Dynamic Range | 5 μ W/g to 100 mW/g Linearity: ± 0.2 dB | |
| Dimensions | Overall length: 337 mm (Tip: 20 mm) Tip diameter: 3.9 mm (Body: 12 mm) Distance from probe tip to dipole centers: 2.0 mm | |

3.2.3 Data Acquisition Electronics (DAE)

| | | |
|-----------------------------|--|---|
| Model | DAE3, DAE4 |  |
| Construction | Signal amplifier, multiplexer, A/D converter and control logic. Serial optical link for communication with DASY4/5 embedded system (fully remote controlled). Two step probe touch detector for mechanical surface detection and emergency robot stop. | |
| Measurement Range | -100 to +300 mV (16 bit resolution and two range settings: 4mV, 400mV) | |
| Input Offset Voltage | < 5 μ V (with auto zero) | |
| Input Bias Current | < 50 fA | |
| Dimensions | 60 x 60 x 68 mm | |

FCC SAR Test Report

3.2.4 Phantoms

| | | |
|------------------------|---|---|
| Model | Twin SAM |  |
| Construction | The shell corresponds to the specifications of the Specific Anthropomorphic Mannequin (SAM) phantom defined in IEEE 1528 and IEC 62209-1. It enables the dosimetric evaluation of left and right hand phone usage as well as body mounted usage at the flat phantom region. A cover prevents evaporation of the liquid. Reference markings on the phantom allow the complete setup of all predefined phantom positions and measurement grids by teaching three points with the robot. | |
| Material | Vinylester, glass fiber reinforced (VE-GF) | |
| Shell Thickness | 2 ± 0.2 mm (6 ± 0.2 mm at ear point) | |
| Dimensions | Length: 1000 mm Width: 500 mm Height: adjustable feet | |
| Filling Volume | approx. 25 liters | |

| | | |
|------------------------|---|--|
| Model | ELI |  |
| Construction | Phantom for compliance testing of handheld and body-mounted wireless devices in the frequency range of 30 MHz to 6 GHz. ELI is fully compatible with the IEC 62209-2 standard and all known tissue simulating liquids. ELI has been optimized regarding its performance and can be integrated into our standard phantom tables. A cover prevents evaporation of the liquid. Reference markings on the phantom allow installation of the complete setup, including all predefined phantom positions and measurement grids, by teaching three points. The phantom is compatible with all SPEAG dosimetric probes and dipoles. | |
| Material | Vinylester, glass fiber reinforced (VE-GF) | |
| Shell Thickness | 2.0 ± 0.2 mm (bottom plate) | |
| Dimensions | Major axis: 600 mm Minor axis: 400 mm | |
| Filling Volume | approx. 30 liters | |

FCC SAR Test Report

3.2.5 Device Holder

| | | |
|---------------------|---|---|
| Model | Mounting Device |  |
| Construction | In combination with the Twin SAM Phantom or ELI4, the Mounting Device enables the rotation of the mounted transmitter device in spherical coordinates. Rotation point is the ear opening point. Transmitter devices can be easily and accurately positioned according to IEC, IEEE, FCC or other specifications. The device holder can be locked for positioning at different phantom sections (left head, right head, flat). | |
| Material | POM | |

| | | |
|---------------------|---|---|
| Model | Laptop Extensions Kit |  |
| Construction | Simple but effective and easy-to-use extension for Mounting Device that facilitates the testing of larger devices according to IEC 62209-2 (e.g., laptops, cameras, etc.). It is lightweight and fits easily on the upper part of the Mounting Device in place of the phone positioner. | |
| Material | POM, Acrylic glass, Foam | |

3.2.6 System Validation Dipoles

| | | |
|-------------------------|--|---|
| Model | D-Serial |  |
| Construction | Symmetrical dipole with 1/4 balun. Enables measurement of feed point impedance with NWA. Matched for use near flat phantoms filled with tissue simulating solutions. | |
| Frequency | 750 MHz to 5800 MHz | |
| Return Loss | > 20 dB | |
| Power Capability | > 100 W (f < 1GHz), > 40 W (f > 1GHz) | |

FCC SAR Test Report

3.2.7 Tissue Simulating Liquids

For SAR measurement of the field distribution inside the phantom, the phantom must be filled with homogeneous tissue simulating liquid to a depth of at least 15 cm. For head SAR testing, the liquid height from the ear reference point (ERP) of the phantom to the liquid top surface is larger than 15 cm. For body SAR testing, the liquid height from the center of the flat phantom to the liquid top surface is larger than 15 cm. The nominal dielectric values of the tissue simulating liquids in the phantom and the tolerance of 5% are listed in Table-3.1.

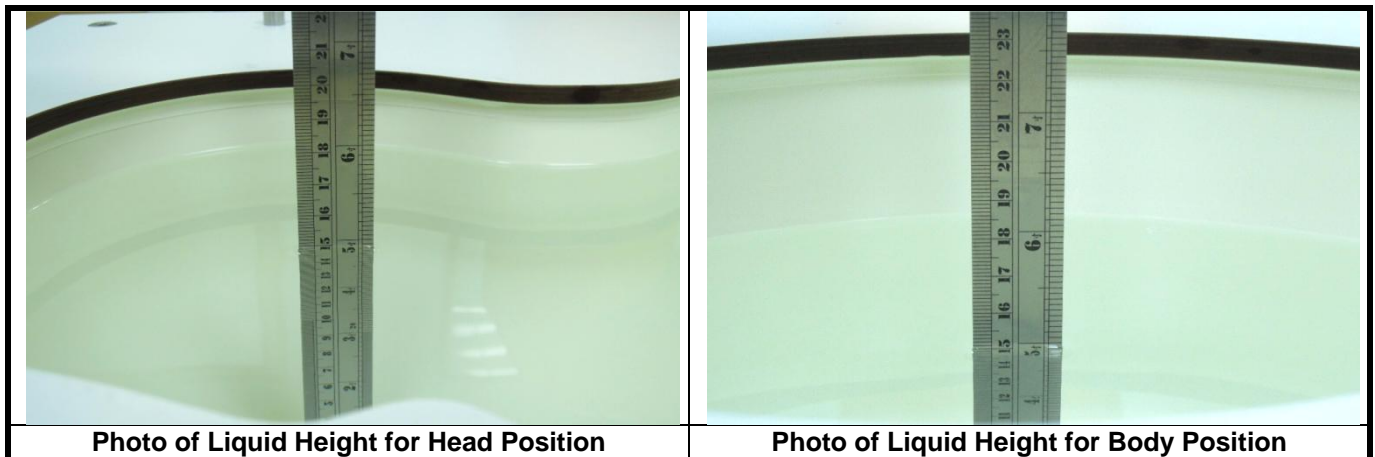

The dielectric properties of the head tissue simulating liquids are defined in IEEE 1528, and KDB 865664 D01 Appendix A. For the body tissue simulating liquids, the dielectric properties are defined in KDB 865664 D01 Appendix A. The dielectric properties of the tissue simulating liquids were verified prior to the SAR evaluation using an Agilent 85070D Dielectric Probe Kit and an Agilent Network Analyzer.



FCC SAR Test Report

Table-3.1 Targets of Tissue Simulating Liquid

| Frequency (MHz) | Target Permittivity | Range of $\pm 5\%$ | Target Conductivity | Range of $\pm 5\%$ |
|-----------------|---------------------|--------------------|---------------------|--------------------|
| For Head | | | | |
| 750 | 41.9 | 39.8 ~ 44.0 | 0.89 | 0.85 ~ 0.93 |
| 835 | 41.5 | 39.4 ~ 43.6 | 0.90 | 0.86 ~ 0.95 |
| 900 | 41.5 | 39.4 ~ 43.6 | 0.97 | 0.92 ~ 1.02 |
| 1450 | 40.5 | 38.5 ~ 42.5 | 1.20 | 1.14 ~ 1.26 |
| 1640 | 40.3 | 38.3 ~ 42.3 | 1.29 | 1.23 ~ 1.35 |
| 1750 | 40.1 | 38.1 ~ 42.1 | 1.37 | 1.30 ~ 1.44 |
| 1800 | 40.0 | 38.0 ~ 42.0 | 1.40 | 1.33 ~ 1.47 |
| 1900 | 40.0 | 38.0 ~ 42.0 | 1.40 | 1.33 ~ 1.47 |
| 2000 | 40.0 | 38.0 ~ 42.0 | 1.40 | 1.33 ~ 1.47 |
| 2300 | 39.5 | 37.5 ~ 41.5 | 1.67 | 1.59 ~ 1.75 |
| 2450 | 39.2 | 37.2 ~ 41.2 | 1.80 | 1.71 ~ 1.89 |
| 2600 | 39.0 | 37.1 ~ 41.0 | 1.96 | 1.86 ~ 2.06 |
| 3500 | 37.9 | 36.0 ~ 39.8 | 2.91 | 2.76 ~ 3.06 |
| 5200 | 36.0 | 34.2 ~ 37.8 | 4.66 | 4.43 ~ 4.89 |
| 5300 | 35.9 | 34.1 ~ 37.7 | 4.76 | 4.52 ~ 5.00 |
| 5500 | 35.6 | 33.8 ~ 37.4 | 4.96 | 4.71 ~ 5.21 |
| 5600 | 35.5 | 33.7 ~ 37.3 | 5.07 | 4.82 ~ 5.32 |
| 5800 | 35.3 | 33.5 ~ 37.1 | 5.27 | 5.01 ~ 5.53 |
| For Body | | | | |
| 750 | 55.5 | 52.7 ~ 58.3 | 0.96 | 0.91 ~ 1.01 |
| 835 | 55.2 | 52.4 ~ 58.0 | 0.97 | 0.92 ~ 1.02 |
| 900 | 55.0 | 52.3 ~ 57.8 | 1.05 | 1.00 ~ 1.10 |
| 1450 | 54.0 | 51.3 ~ 56.7 | 1.30 | 1.24 ~ 1.37 |
| 1640 | 53.8 | 51.1 ~ 56.5 | 1.40 | 1.33 ~ 1.47 |
| 1750 | 53.4 | 50.7 ~ 56.1 | 1.49 | 1.42 ~ 1.56 |
| 1800 | 53.3 | 50.6 ~ 56.0 | 1.52 | 1.44 ~ 1.60 |
| 1900 | 53.3 | 50.6 ~ 56.0 | 1.52 | 1.44 ~ 1.60 |
| 2000 | 53.3 | 50.6 ~ 56.0 | 1.52 | 1.44 ~ 1.60 |
| 2300 | 52.9 | 50.3 ~ 55.5 | 1.81 | 1.72 ~ 1.90 |
| 2450 | 52.7 | 50.1 ~ 55.3 | 1.95 | 1.85 ~ 2.05 |
| 2600 | 52.5 | 49.9 ~ 55.1 | 2.16 | 2.05 ~ 2.27 |
| 3500 | 51.3 | 48.7 ~ 53.9 | 3.31 | 3.14 ~ 3.48 |
| 5200 | 49.0 | 46.6 ~ 51.5 | 5.30 | 5.04 ~ 5.57 |
| 5300 | 48.9 | 46.5 ~ 51.3 | 5.42 | 5.15 ~ 5.69 |
| 5500 | 48.6 | 46.2 ~ 51.0 | 5.65 | 5.37 ~ 5.93 |
| 5600 | 48.5 | 46.1 ~ 50.9 | 5.77 | 5.48 ~ 6.06 |
| 5800 | 48.2 | 45.8 ~ 50.6 | 6.00 | 5.70 ~ 6.30 |

FCC SAR Test Report

The following table gives the recipes for tissue simulating liquids.

Table-3.2 Recipes of Tissue Simulating Liquid

| Tissue Type | Bactericide | DGBE | HEC | NaCl | Sucrose | Triton X-100 | Water | Diethylene Glycol Mono-hexylether |
|-------------|-------------|------|-----|------|---------|--------------|-------|-----------------------------------|
| H750 | 0.2 | - | 0.2 | 1.5 | 56.0 | - | 42.1 | - |
| H835 | 0.2 | - | 0.2 | 1.5 | 57.0 | - | 41.1 | - |
| H900 | 0.2 | - | 0.2 | 1.4 | 58.0 | - | 40.2 | - |
| H1450 | - | 43.3 | - | 0.6 | - | - | 56.1 | - |
| H1640 | - | 45.8 | - | 0.5 | - | - | 53.7 | - |
| H1750 | - | 47.0 | - | 0.4 | - | - | 52.6 | - |
| H1800 | - | 44.5 | - | 0.3 | - | - | 55.2 | - |
| H1900 | - | 44.5 | - | 0.2 | - | - | 55.3 | - |
| H2000 | - | 44.5 | - | 0.1 | - | - | 55.4 | - |
| H2300 | - | 44.9 | - | 0.1 | - | - | 55.0 | - |
| H2450 | - | 45.0 | - | 0.1 | - | - | 54.9 | - |
| H2600 | - | 45.1 | - | 0.1 | - | - | 54.8 | - |
| H3500 | - | 8.0 | - | 0.2 | - | 20.0 | 71.8 | - |
| H5G | - | - | - | - | - | 17.2 | 65.5 | 17.3 |
| B750 | 0.2 | - | 0.2 | 0.8 | 48.8 | - | 50.0 | - |
| B835 | 0.2 | - | 0.2 | 0.9 | 48.5 | - | 50.2 | - |
| B900 | 0.2 | - | 0.2 | 0.9 | 48.2 | - | 50.5 | - |
| B1450 | - | 34.0 | - | 0.3 | - | - | 65.7 | - |
| B1640 | - | 32.5 | - | 0.3 | - | - | 67.2 | - |
| B1750 | - | 31.0 | - | 0.2 | - | - | 68.8 | - |
| B1800 | - | 29.5 | - | 0.4 | - | - | 70.1 | - |
| B1900 | - | 29.5 | - | 0.3 | - | - | 70.2 | - |
| B2000 | - | 30.0 | - | 0.2 | - | - | 69.8 | - |
| B2300 | - | 31.0 | - | 0.1 | - | - | 68.9 | - |
| B2450 | - | 31.4 | - | 0.1 | - | - | 68.5 | - |
| B2600 | - | 31.8 | - | 0.1 | - | - | 68.1 | - |
| B3500 | - | 28.8 | - | 0.1 | - | - | 71.1 | - |
| B5G | - | - | - | - | - | 10.7 | 78.6 | 10.7 |

3.3 SAR System Verification

The system check verifies that the system operates within its specifications. It is performed daily or before every SAR measurement. The system check uses normal SAR measurements in the flat section of the phantom with a matched dipole at a specified distance. The system verification setup is shown as below.

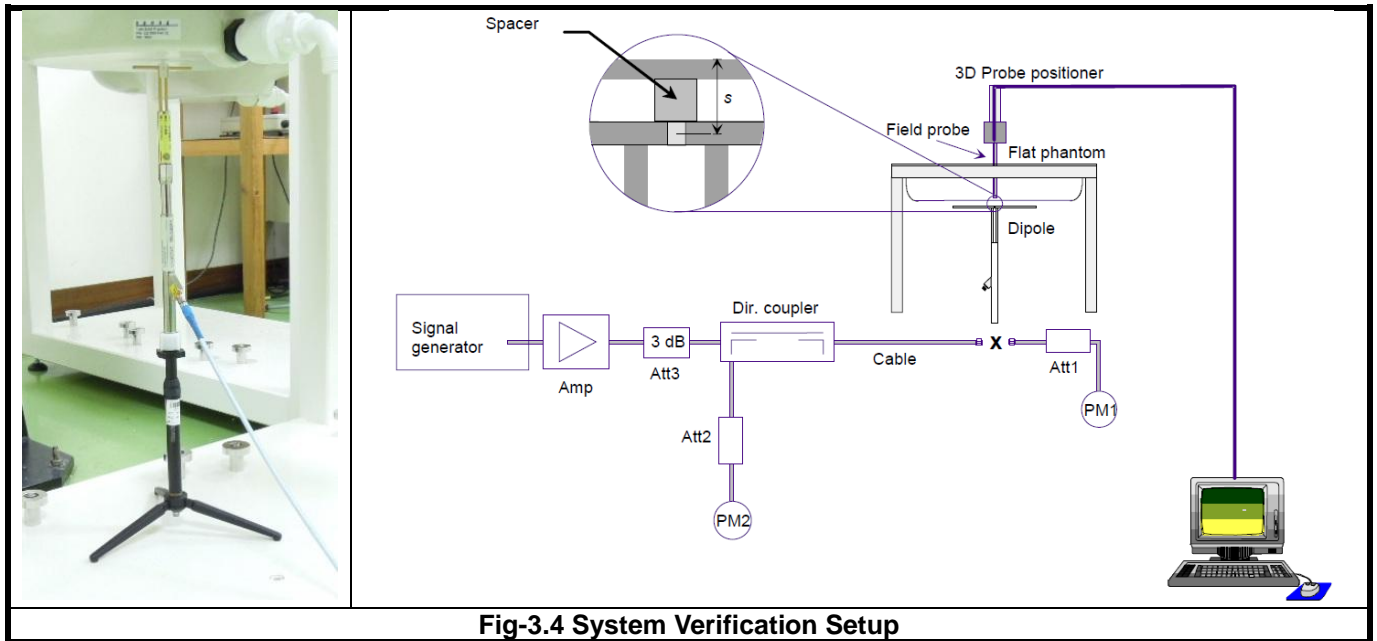

Fig-3.4 System Verification Setup

The validation dipole is placed beneath the flat phantom with the specific spacer in place. The distance spacer is touch the phantom surface with a light pressure at the reference marking and be oriented parallel to the long side of the phantom. The power meter PM1 measures the forward power at the location of the system check dipole connector. The signal generator is adjusted for the desired forward power (250 mW is used for 700 MHz to 3 GHz, 100 mW is used for 3.5 GHz to 6 GHz) at the dipole connector and the power meter PM2 is read at that level. After connecting the cable to the dipole, the signal generator is readjusted for the same reading at power meter PM2.

After system check testing, the SAR result will be normalized to 1W forward input power and compared with the reference SAR value derived from validation dipole certificate report. The deviation of system check should be within 10 %.

3.4 SAR Measurement Procedure

According to the SAR test standard, the recommended procedure for assessing the peak spatial-average SAR value consists of the following steps:

- (a) Power reference measurement
- (b) Area scan
- (c) Zoom scan
- (d) Power drift measurement

The SAR measurement procedures for each of test conditions are as follows:

- (a) Make EUT to transmit maximum output power
- (b) Measure conducted output power through RF cable
- (c) Place the EUT in the specific position of phantom
- (d) Perform SAR testing steps on the DASY system
- (e) Record the SAR value

3.4.1 Area & Zoom Scan Procedure

First Area Scan is used to locate the approximate location(s) of the local peak SAR value(s). The measurement grid within an Area Scan is defined by the grid extent, grid step size and grid offset. Next, in order to determine the EM field distribution in a three-dimensional spatial extension, Zoom Scan is required. The Zoom Scan is performed around the highest E-field value to determine the averaged SAR-distribution over 10 g. According to KDB 865664 D01 v01r02, the resolution for Area and Zoom scan is specified in the table below.

| Items | <= 2 GHz | 2-3 GHz | 3-4 GHz | 4-5 GHz | 5-6 GHz |
|---------------------------------------|----------|----------|----------|----------|----------|
| Area Scan ($\Delta x, \Delta y$) | <= 15 mm | <= 12 mm | <= 12 mm | <= 10 mm | <= 10 mm |
| Zoom Scan ($\Delta x, \Delta y$) | <= 8 mm | <= 5 mm | <= 5 mm | <= 4 mm | <= 4 mm |
| Zoom Scan (Δz) | <= 5 mm | <= 5 mm | <= 4 mm | <= 3 mm | <= 2 mm |
| Zoom Scan Volume | >= 30 mm | >= 30 mm | >= 28 mm | >= 25 mm | >= 22 mm |

Note:

When zoom scan is required and report SAR is <= 1.4 W/kg, the zoom scan resolution of $\Delta x / \Delta y$ (2-3GHz: <= 8 mm, 3-4GHz: <= 7 mm, 4-6GHz: <= 5 mm) may be applied.

3.4.2 Volume Scan Procedure

The volume scan is used for assess overlapping SAR distributions for antennas transmitting in different frequency bands. It is equivalent to an oversized zoom scan used in standalone measurements. The measurement volume will be used to enclose all the simultaneous transmitting antennas. For antennas transmitting simultaneously in different frequency bands, the volume scan is measured separately in each frequency band. In order to sum correctly to compute the 1g aggregate SAR, the EUT remain in the same test position for all measurements and all volume scan use the same spatial resolution and grid spacing. When all volume scan were completed, the software, SEMCAD postprocessor can combine and subsequently superpose these measurement data to calculating the multiband SAR.

FCC SAR Test Report

3.4.3 Power Drift Monitoring

All SAR testing is under the EUT install full charged battery and transmit maximum output power. In DASY measurement software, the power reference measurement and power drift measurement procedures are used for monitoring the power drift of EUT during SAR test. Both these procedures measure the field at a specified reference position before and after the SAR testing. The software will calculate the field difference in dB. If the power drift more than 5%, the SAR will be retested.

3.4.4 Spatial Peak SAR Evaluation

The procedure for spatial peak SAR evaluation has been implemented according to the test standard. It can be conducted for 1g and 10g, as well as for user-specific masses. The DASY software includes all numerical procedures necessary to evaluate the spatial peak SAR value.

The base for the evaluation is a "cube" measurement. The measured volume must include the 1g and 10g cubes with the highest averaged SAR values. For that purpose, the center of the measured volume is aligned to the interpolated peak SAR value of a previously performed area scan.

The entire evaluation of the spatial peak values is performed within the post-processing engine (SEMCAD). The system always gives the maximum values for the 1g and 10g cubes. The algorithm to find the cube with highest averaged SAR is divided into the following stages:

- (a) Extraction of the measured data (grid and values) from the Zoom Scan
- (b) Calculation of the SAR value at every measurement point based on all stored data (A/D values and measurement parameters)
- (c) Generation of a high-resolution mesh within the measured volume
- (d) Interpolation of all measured values from the measurement grid to the high-resolution grid
- (e) Extrapolation of the entire 3-D field distribution to the phantom surface over the distance from sensor to surface
- (f) Calculation of the averaged SAR within masses of 1g and 10g

3.4.5 SAR Averaged Methods

In DASY, the interpolation and extrapolation are both based on the modified Quadratic Shepard's method. The interpolation scheme combines a least-square fitted function method and a weighted average method which are the two basic types of computational interpolation and approximation.

Extrapolation routines are used to obtain SAR values between the lowest measurement points and the inner phantom surface. The extrapolation distance is determined by the surface detection distance and the probe sensor offset. The uncertainty increases with the extrapolation distance. To keep the uncertainty within 1% for the 1 g and 10 g cubes, the extrapolation distance should not be larger than 5 mm.

4. SAR Measurement Evaluation

4.1 EUT Configuration and Setting

For WWAN SAR testing, the EUT was linked and controlled by base station emulator (Agilent E5515C). Communication between the EUT and the emulator was established by air link. The distance between the EUT and the communicating antenna of the emulator is larger than 50 cm and the output power radiated from the emulator antenna is at least 30 dB smaller than the output power of EUT. The EUT was set from the emulator to radiate maximum output power during SAR testing.

For GSM850, the power control level is set to 5. For GPRS850 (GMSK, CS1), the power control level is set to 5. For EDGE850 (GMSK: MCS1, 8PSK:MCS9), the power control level is set to 8. For GSM1900, the power control level is set to 0. For GPRS1900 (GMSK, CS1), the power control level is set to 0. For EDGE1900 (GMSK: MCS1, 8PSK:MCS9), the power control level is set to 2.

For WCDMA, head and body SAR is tested under 12.2k RMC mode with power control set all up bits. SAR for AMR is not required since its power is less than 1/4 dB higher than RMC. SAR for HSDPA/HSUPA is not required since its power is less than 1/4 dB higher than RMC without HSDPA/HSUPA and SAR for 12.2 kbps RMC is less than 75% of the SAR limit (1.2 W/kg).

For WLAN SAR testing, the EUT has installed WLAN engineering testing software which can provide continuous transmitting RF signal. According to KDB 248227 D01, WLAN SAR should be tested at the lowest data rate, and testing at higher data rate is not required when the maximum average output power is less than 1/4 dB higher than those measured at the lowest data rate. Since the WLAN power at lowest data rate has highest output power, WLAN SAR for this device was performed at the lowest data rate as set in 1 Mbps for 802.11b. This RF signal utilized in SAR measurement has almost 100% duty cycle, and the duty factor is 1 during WLAN SAR testing.

<Antenna Location>

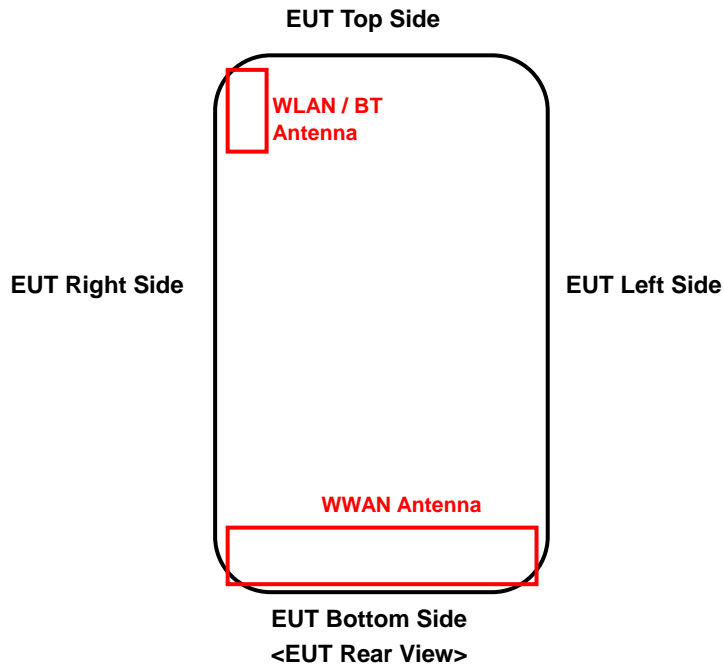

The separation distance for antenna to edge:

| Antenna | To Top Side (mm) | To Bottom Side (mm) | To Left Side (mm) | To Right Side (mm) |
|-----------|------------------|---------------------|-------------------|--------------------|
| WWAN | 112 | 3 | 3 | 3 |
| WLAN / BT | 3 | 95 | 47 | 3 |

The simultaneous transmission possibilities are listed as below.

| Simultaneous TX Combination | Configuration | Head (Voice / VoIP) | Body Worn (Voice / VoIP) | Hotspot (Data) |
|-----------------------------|---------------------------------------|---------------------|--------------------------|----------------|
| 1 | GSM850 (Voice / Data) + WLAN (Data) | Yes | Yes | Yes |
| 2 | GSM1900 (Voice / Data) + WLAN (Data) | Yes | Yes | Yes |
| 3 | WCDMA II (Voice / Data) + WLAN (Data) | Yes | Yes | Yes |
| 4 | WCDMA V (Voice / Data) + WLAN (Data) | Yes | Yes | Yes |
| 5 | GSM850 (Voice / Data) + BT (Data) | No | Yes | No |
| 6 | GSM1900 (Voice / Data) + BT (Data) | No | Yes | No |
| 7 | WCDMA II (Voice / Data) + BT (Data) | No | Yes | No |
| 8 | WCDMA V (Voice / Data) + BT (Data) | No | Yes | No |

Note :

1. The WLAN and BT cannot transmit simultaneously, so there is no co-location test requirement for WLAN and BT.

4.2 EUT Testing Position

According to KDB 648474 D04, handsets are tested for SAR compliance in head, body-worn accessory and other use configurations described in the following subsections.

4.2.1 Head Exposure Conditions

Head exposure is limited to next to the ear voice mode operations. Head SAR compliance is tested according to the test positions defined in IEEE Std 1528-2003 using the SAM phantom illustrated as below.

1. Define two imaginary lines on the handset
 - (a) The vertical centerline passes through two points on the front side of the handset - the midpoint of the width w_t of the handset at the level of the acoustic output, and the midpoint of the width w_b of the bottom of the handset.
 - (b) The horizontal line is perpendicular to the vertical centerline and passes through the center of the acoustic output. The horizontal line is also tangential to the face of the handset at point A.
 - (c) The two lines intersect at point A. Note that for many handsets, point A coincides with the center of the acoustic output; however, the acoustic output may be located elsewhere on the horizontal line. Also note that the vertical centerline is not necessarily parallel to the front face of the handset, especially for clamshell handsets, handsets with flip covers, and other irregularly shaped handsets.

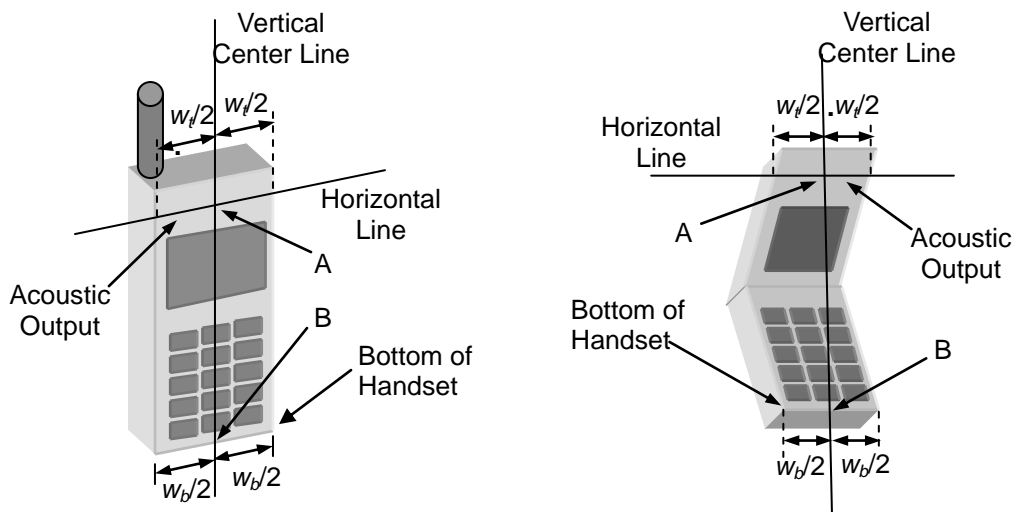

Fig-4.1 Illustration for Handset Vertical and Horizontal Reference Lines

FCC SAR Test Report

2. Cheek Position

- (a) To position the device with the vertical center line of the body of the device and the horizontal line crossing the center piece in a plane parallel to the sagittal plane of the phantom. While maintaining the device in this plane, align the vertical center line with the reference plane containing the three ear and mouth reference point (M: Mouth, RE: Right Ear, and LE: Left Ear) and align the center of the ear piece with the line RE-LE.
- (b) To move the device towards the phantom with the ear piece aligned with the line LE-RE until the phone touched the ear. While maintaining the device in the reference plane and maintaining the phone contact with the ear, move the bottom of the phone until any point on the front side is in contact with the cheek of the phantom or until contact with the ear is lost (see Fig-4.2).

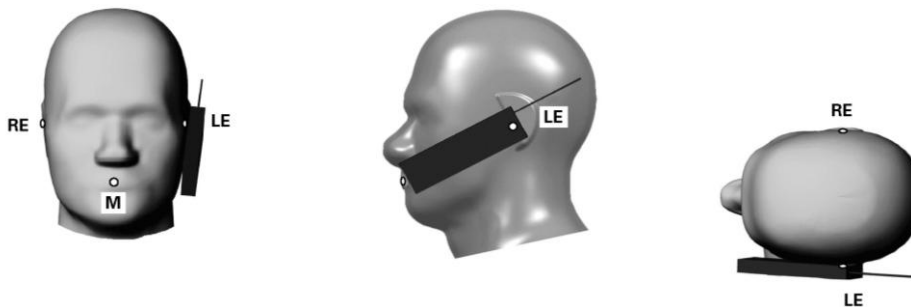

Fig-4.2 Illustration for Cheek Position

3. Tilted Position

- (a) To position the device in the “cheek” position described above.
- (b) While maintaining the device the reference plane described above and pivoting against the ear, moves it outward away from the mouth by an angle of 15 degrees or until contact with the ear is lost (see Fig-4.3).

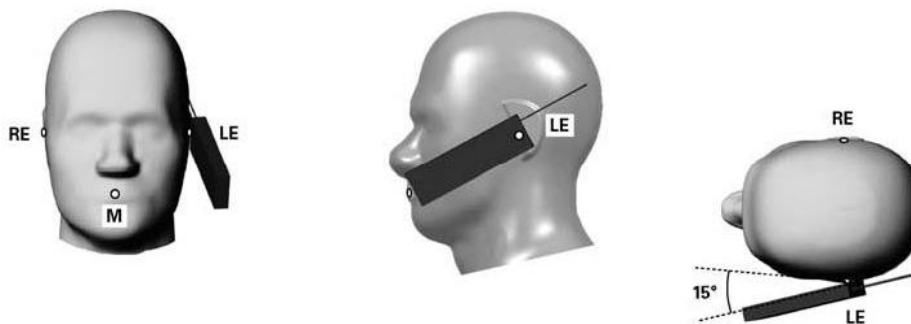

Fig-4.3 Illustration for Tilted Position

4.2.2 Body-Worn Accessory Exposure Conditions

Body-worn accessory exposure is typically related to voice mode operations when handsets are carried in body-worn accessories. The body-worn accessory procedures in KDB 447498 D01 are used to test for body-worn accessory SAR compliance, without a headset connected to it. This enables the test results for such configuration to be compatible with that required for hotspot mode when the body-worn accessory test separation distance is greater than or equal to that required for hotspot mode. When the reported SAR for a body-worn accessory, measured without a headset connected to the handset, is $> 1.2 \text{ W/kg}$, the highest reported SAR configuration for that wireless mode and frequency band should be repeated for that body-worn accessory with a headset attached to the handset.

Body-worn accessories that do not contain metallic or conductive components may be tested according to worst-case exposure configurations, typically according to the smallest test separation distance required for the group of body-worn accessories with similar operating and exposure characteristics. All body-worn accessories containing metallic components are tested in conjunction with the host device.

Body-worn accessory SAR compliance is based on a single minimum test separation distance for all wireless and operating modes applicable to each body-worn accessory used by the host, and according to the relevant voice and/or data mode transmissions and operations. If a body-worn accessory supports voice only operations in its normal and expected use conditions, testing of data mode for body-worn compliance is not required.

A conservative minimum test separation distance for supporting off-the-shelf body-worn accessories that may be acquired by users of consumer handsets is used to test for body-worn accessory SAR compliance. This distance is determined by the handset manufacturer, according to the requirements of Supplement C 01-01. Devices that are designed to operate on the body of users using lanyards and straps, or without requiring additional body-worn accessories, will be tested using a conservative minimum test separation distance $\leq 5 \text{ mm}$ to support compliance.

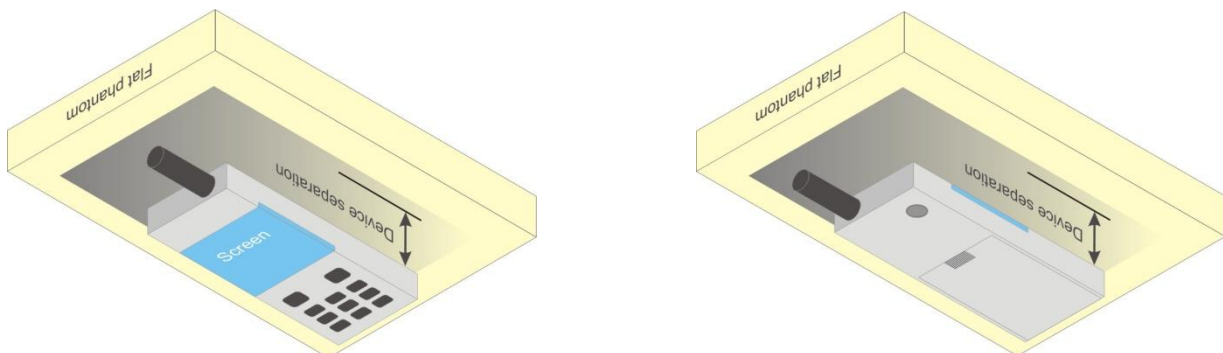
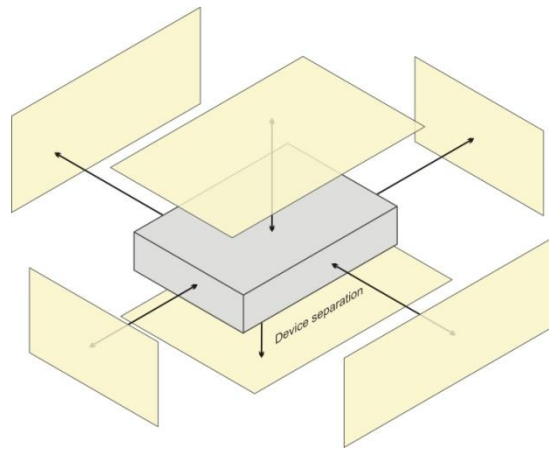

Fig-4.4 Illustration for Body Worn Position

FCC SAR Test Report

4.2.3 Hotspot Mode Exposure conditions

For handsets that support hotspot mode operations, with wireless router capabilities and various web browsing functions, the relevant hand and body exposure conditions are tested according to the hotspot SAR procedures in KDB 941225 D06. A test separation distance of 10 mm is required between the phantom and all surfaces and edges with a transmitting antenna located within 25 mm from that surface or edge. When the form factor of a handset is smaller than 9 cm x 5 cm, a test separation distance of 5 mm (instead of 10 mm) is required for testing hotspot mode. When the separation distance required for body-worn accessory testing is larger than or equal to that tested for hotspot mode, in the same wireless mode and for the same surface of the phone, the hotspot mode SAR data may be used to support body-worn accessory SAR compliance for that particular configuration (surface).



Based on the antenna location shown on section 4.1 of this report, the SAR testing required for hotspot mode is listed as below.

| Antenna | Front Face | Rear Face | Left Side | Right Side | Top Side | Bottom Side |
|-----------|------------|-----------|-----------|------------|----------|-------------|
| WWAN | √ | √ | √ | √ | - | √ |
| WLAN / BT | √ | √ | - | √ | √ | - |

4.2.4 SAR Test Exclusions

According to KDB 447498 D01, the SAR test exclusion condition is based on source-based time-averaged maximum conducted output power, adjusted for tune-up tolerance, and the minimum test separation distance required for the exposure conditions. The SAR exclusion threshold is determined by the following formula.

$$\frac{\text{Max. Tune up Power}_{(mW)}}{\text{Min. Test Separation Distance}_{(mm)}} \times \sqrt{f_{(GHz)}} \leq 3.0 \text{ for SAR-1g, } \leq 7.5 \text{ for SAR-10g}$$

When the minimum test separation distance is < 5 mm, a distance of 5 mm is applied to determine SAR test exclusion.

| Mode | Max. Tune-up Power (dBm) | Max. Tune-up Power (mW) | Body-Worn | | |
|---------------|--------------------------|-------------------------|----------------------|-------------------|----------------------|
| | | | Ant. to Surface (mm) | Calculated Result | Require SAR Testing? |
| BT (2.48 GHz) | 4.5 | 3 | 10 | 0.5 | No |

FCC SAR Test Report

4.3 Issue Verification

The measuring results for tissue simulating liquid are shown as below.

| Test Date | Tissue Type | Frequency (MHz) | Liquid Temp. (°C) | Measured Conductivity (σ) | Measured Permittivity (ε _r) | Target Conductivity (σ) | Target Permittivity (ε _r) | Conductivity Deviation (%) | Permittivity Deviation (%) |
|---------------|-------------|-----------------|-------------------|---------------------------|---|-------------------------|---------------------------------------|----------------------------|----------------------------|
| Dec. 13, 2013 | Head | 835 | 20.4 | 0.890 | 43.044 | 0.90 | 41.5 | -1.11 | 3.72 |
| Dec. 14, 2013 | Head | 1900 | 20.3 | 1.425 | 39.171 | 1.40 | 40.0 | 1.80 | -2.07 |
| Dec. 14, 2013 | Head | 2450 | 20.8 | 1.887 | 38.789 | 1.80 | 39.2 | 4.83 | -1.05 |
| Dec. 14, 2013 | Body | 835 | 20.8 | 0.980 | 55.320 | 0.97 | 55.2 | 1.03 | 0.22 |
| Dec. 20, 2013 | Body | 1900 | 20.7 | 1.555 | 53.563 | 1.52 | 53.3 | 2.30 | 0.49 |
| Dec. 14, 2013 | Body | 2450 | 21.5 | 1.966 | 51.383 | 1.95 | 52.7 | 0.82 | -2.50 |

Note:

The dielectric properties of the tissue simulating liquid must be measured within 24 hours before the SAR testing and within ±5% of the target values. Liquid temperature during the SAR testing must be within ±2 °C.

4.4 System Validation

The SAR measurement system was validated according to procedures in KDB 865664 D01 v01r01. The validation status in tabulated summary is as below.

| Test Date | Probe S/N | Calibration Point | | Measured Conductivity (σ) | Measured Permittivity (ε _r) | Validation for CW | | | Validation for Modulation | | |
|---------------|-----------|-------------------|------|---------------------------|---|-------------------|-----------------|----------------|---------------------------|-------------|------|
| | | | | | | Sensitivity Range | Probe Linearity | Probe Isotropy | Modulation Type | Duty Factor | PAR |
| Dec. 13, 2013 | 3801 | Head | 835 | 0.890 | 43.044 | Pass | Pass | Pass | GMSK | Pass | N/A |
| Dec. 14, 2013 | 3801 | Head | 1900 | 1.425 | 39.171 | Pass | Pass | Pass | GMSK | Pass | N/A |
| Dec. 14, 2013 | 3801 | Head | 2450 | 1.887 | 38.789 | Pass | Pass | Pass | OFDM | N/A | Pass |
| Dec. 14, 2013 | 3801 | Body | 835 | 0.980 | 55.320 | Pass | Pass | Pass | GMSK | Pass | N/A |
| Dec. 20, 2013 | 3650 | Body | 1900 | 1.555 | 53.563 | Pass | Pass | Pass | GMSK | Pass | N/A |
| Dec. 14, 2013 | 3590 | Body | 2450 | 1.966 | 51.383 | Pass | Pass | Pass | OFDM | N/A | Pass |

4.5 System Verification

The measuring result for system verification is tabulated as below.

| Test Date | Mode | Frequency (MHz) | 1W Target SAR-1g (W/kg) | Measured SAR-1g (W/kg) | Normalized to 1W SAR-1g (W/kg) | Deviation (%) | Dipole S/N | Probe S/N | DAE S/N |
|---------------|------|-----------------|-------------------------|------------------------|--------------------------------|---------------|------------|-----------|---------|
| Dec. 13, 2013 | Head | 835 | 9.68 | 2.24 | 8.96 | -7.44 | 4d121 | 3801 | 510 |
| Dec. 14, 2013 | Head | 1900 | 40.60 | 9.40 | 37.60 | -7.39 | 5d036 | 3801 | 510 |
| Dec. 14, 2013 | Head | 2450 | 52.50 | 13.2 | 52.80 | 0.57 | 737 | 3801 | 510 |
| Dec. 14, 2013 | Body | 835 | 9.69 | 2.31 | 9.24 | -4.64 | 4d121 | 3801 | 510 |
| Dec. 20, 2013 | Body | 1900 | 41.00 | 10.2 | 40.80 | -0.49 | 5d036 | 3650 | 360 |
| Dec. 14, 2013 | Body | 2450 | 49.60 | 12.1 | 48.40 | -2.42 | 737 | 3590 | 861 |

Note:

Comparing to the reference SAR value provided by SPEAG, the validation data should be within its specification of 10 %. The result indicates the system check can meet the variation criterion and the plots can be referred to Appendix A of this report.



FCC SAR Test Report

4.6 Maximum Output Power

4.6.1 Maximum Conducted Power

The maximum conducted average power (Unit: dBm) including tune-up tolerance is shown as below.

| Mode | GSM850 | GSM1900 |
|--------------------------|--------|---------|
| GSM (GMSK, 1 Uplink) | 32.5 | 30.0 |
| GPRS 8 (GMSK, 1 Uplink) | 32.5 | 30.0 |
| GPRS 10 (GMSK, 2 Uplink) | 32.0 | 29.3 |
| GPRS 11 (GMSK, 3 Uplink) | 30.0 | 27.5 |
| GPRS 12 (GMSK, 4 Uplink) | 29.1 | 26.0 |
| EDGE 8 (8PSK, 1 Uplink) | 26.5 | 26.0 |
| EDGE 10 (8PSK, 2 Uplink) | 25.5 | 25.0 |
| EDGE 11 (8PSK, 3 Uplink) | 23.5 | 23.0 |
| EDGE 12 (8PSK, 4 Uplink) | 22.5 | 22.0 |

| Mode | WCDMA Band II | WCDMA Band V |
|-----------|---------------|--------------|
| RMC 12.2K | 23.5 | 23.5 |
| HSDPA | 21.5 | 20.5 |
| HSUPA | 21.5 | 21.0 |

| Mode | 2.4G WLAN |
|--------------|-----------|
| 802.11b | 11.5 |
| 802.11g | 8.5 |
| 802.11n HT20 | 7.5 |
| 802.11n HT40 | 7.5 |

| Mode | Bluetooth |
|------|-----------|
| All | 4.5 |

FCC SAR Test Report

4.6.2 Measured Conducted Power Result

The measuring conducted average power (Unit: dBm) is shown as below.

| Band Channel Frequency (MHz) | GSM850 | | | GSM1900 | | |
|--|--------------|--------------|--------------|---------------|---------------|---------------|
| | 128 | 189 | 251 | 512 | 661 | 810 |
| | 824.2 | 836.4 | 848.8 | 1850.2 | 1880.0 | 1909.8 |
| Maximum Burst-Averaged Output Power | | | | | | |
| GSM (GMSK, 1 Uplink) | 32.24 | 32.31 | 32.32 | 29.61 | 29.56 | 29.80 |
| GPRS 8 (GMSK, 1 Uplink) | 32.19 | 32.26 | 32.27 | 29.57 | 29.52 | 29.76 |
| GPRS 10 (GMSK, 2 Uplink) | 31.48 | 31.55 | 31.56 | 28.79 | 28.74 | 28.98 |
| GPRS 11 (GMSK, 3 Uplink) | 29.77 | 29.84 | 29.85 | 26.82 | 26.77 | 27.01 |
| GPRS 12 (GMSK, 4 Uplink) | 28.73 | 28.80 | 28.81 | 25.69 | 25.64 | 25.88 |
| EDGE 8 (8PSK, 1 Uplink) | 26.35 | 26.42 | 26.43 | 25.58 | 25.53 | 25.77 |
| EDGE 10 (8PSK, 2 Uplink) | 25.40 | 25.47 | 25.48 | 24.55 | 24.50 | 24.74 |
| EDGE 11 (8PSK, 3 Uplink) | 23.39 | 23.46 | 23.47 | 22.53 | 22.48 | 22.72 |
| EDGE 12 (8PSK, 4 Uplink) | 22.29 | 22.36 | 22.37 | 21.42 | 21.37 | 21.61 |
| Maximum Frame-Averaged Output Power | | | | | | |
| GSM (GMSK, 1 Uplink) | 23.24 | 23.31 | 23.32 | 20.61 | 20.56 | 20.80 |
| GPRS 8 (GMSK, 1 Uplink) | 23.19 | 23.26 | 23.27 | 20.57 | 20.52 | 20.76 |
| GPRS 10 (GMSK, 2 Uplink) | 25.48 | 25.55 | 25.56 | 22.79 | 22.74 | 22.98 |
| GPRS 11 (GMSK, 3 Uplink) | 25.51 | 25.58 | 25.59 | 22.56 | 22.51 | 22.75 |
| GPRS 12 (GMSK, 4 Uplink) | 25.73 | 25.80 | 25.81 | 22.69 | 22.64 | 22.88 |
| EDGE 8 (8PSK, 1 Uplink) | 17.35 | 17.42 | 17.43 | 16.58 | 16.53 | 16.77 |
| EDGE 10 (8PSK, 2 Uplink) | 19.40 | 19.47 | 19.48 | 18.55 | 18.50 | 18.74 |
| EDGE 11 (8PSK, 3 Uplink) | 19.13 | 19.20 | 19.21 | 18.27 | 18.22 | 18.46 |
| EDGE 12 (8PSK, 4 Uplink) | 19.29 | 19.36 | 19.37 | 18.42 | 18.37 | 18.61 |

Note:

- SAR testing was performed on the maximum frame-averaged power mode.
- The frame-averaged power is linearly proportion to the slot number configured and it is linearly scaled the maximum burst-averaged power based on time slots. The calculated method is shown as below:

$$\text{Frame-averaged power} = 10 \times \log (\text{Burst-averaged power mW} \times \text{Slot used} / 8)$$

| Band Channel Frequency (MHz) | WCDMA Band II | | | WCDMA Band V | | | 3GPP MPR (dB) |
|------------------------------------|---------------|---------------|---------------|--------------|--------------|--------------|---------------------|
| | 9262 | 9400 | 9538 | 4132 | 4182 | 4233 | |
| | 1852.4 | 1880.0 | 1907.6 | 826.4 | 836.4 | 846.6 | |
| RMC 12.2K | 23.20 | 22.40 | 22.32 | 23.02 | 22.90 | 22.96 | - |
| HSDPA Subtest-1 | 21.36 | 20.56 | 20.48 | 20.33 | 20.21 | 20.27 | 0 |
| HSDPA Subtest-2 | 21.35 | 20.55 | 20.47 | 20.32 | 20.20 | 20.26 | 0 |
| HSDPA Subtest-3 | 21.34 | 20.54 | 20.46 | 20.31 | 20.19 | 20.25 | 0.5 |
| HSDPA Subtest-4 | 21.33 | 20.53 | 20.45 | 20.30 | 20.18 | 20.24 | 0.5 |
| HSUPA Subtest-1 | 21.43 | 20.63 | 20.55 | 20.80 | 20.68 | 20.74 | 0 |
| HSUPA Subtest-2 | 19.66 | 18.86 | 18.78 | 19.02 | 18.90 | 18.96 | 2 |
| HSUPA Subtest-3 | 20.11 | 19.31 | 19.23 | 19.36 | 19.24 | 19.30 | 1 |
| HSUPA Subtest-4 | 19.65 | 18.85 | 18.77 | 19.04 | 18.92 | 18.98 | 2 |
| HSUPA Subtest-5 | 21.46 | 20.66 | 20.58 | 20.83 | 20.71 | 20.77 | 0 |

<WLAN 2.4G>

| Mode | 802.11b | | |
|---------------------------|----------------|----------|-----------|
| Channel / Frequency (MHz) | 1 (2412) | 6 (2437) | 11 (2462) |
| Average Power | 11.39 | 11.24 | 11.35 |
| Mode | 802.11g | | |
| Channel / Frequency (MHz) | 1 (2412) | 6 (2437) | 11 (2462) |
| Average Power | 8.45 | 8.38 | 8.15 |
| Mode | 802.11n (HT20) | | |
| Channel / Frequency (MHz) | 1 (2412) | 6 (2437) | 11 (2462) |
| Average Power | 7.48 | 7.28 | 7.23 |
| Mode | 802.11n (HT40) | | |
| Channel / Frequency (MHz) | 3 (2422) | 6 (2437) | 9 (2452) |
| Average Power | 7.44 | 7.13 | 7.29 |

4.7 SAR Testing Results

4.7.1 SAR Results for Head

| Plot No. | Band | Mode | Test Position | Ch. | EUT Config. | Max. Tune-up Power (dBm) | Measured Conducted Power (dBm) | Scaling Factor | Power Drift (dB) | Measured SAR-1g (W/kg) | Scaled SAR-1g (W/kg) |
|----------|----------|----------|---------------|------|-------------|--------------------------|--------------------------------|----------------|------------------|------------------------|----------------------|
| 01 | GSM850 | GPRS 12 | Right Cheek | 251 | 1 | 29.1 | 28.81 | 1.07 | 0.07 | 0.294 | 0.31 |
| | GSM850 | GPRS 12 | Right Tilted | 251 | 1 | 29.1 | 28.81 | 1.07 | 0.04 | 0.2 | 0.21 |
| | GSM850 | GPRS 12 | Left Cheek | 251 | 1 | 29.1 | 28.81 | 1.07 | 0.08 | 0.318 | 0.34 |
| | GSM850 | GPRS 12 | Left Tilted | 251 | 1 | 29.1 | 28.81 | 1.07 | -0.01 | 0.196 | 0.21 |
| | GSM850 | GPRS 12 | Left Cheek | 251 | 2 | 29.1 | 28.81 | 1.07 | -0.12 | 0.296 | 0.32 |
| 02 | GSM1900 | GPRS 10 | Right Cheek | 810 | 1 | 29.3 | 28.98 | 1.08 | 0.08 | 0.196 | 0.21 |
| | GSM1900 | GPRS 10 | Right Tilted | 810 | 1 | 29.3 | 28.98 | 1.08 | 0.06 | 0.088 | 0.09 |
| | GSM1900 | GPRS 10 | Left Cheek | 810 | 1 | 29.3 | 28.98 | 1.08 | -0.07 | 0.157 | 0.17 |
| | GSM1900 | GPRS 10 | Left Tilted | 810 | 1 | 29.3 | 28.98 | 1.08 | -0.02 | 0.085 | 0.09 |
| | GSM1900 | GPRS 10 | Right Cheek | 810 | 2 | 29.3 | 28.98 | 1.08 | 0.04 | 0.346 | 0.37 |
| 03 | WCDMA II | RMC12.2K | Right Cheek | 9262 | 1 | 23.5 | 23.20 | 1.07 | 0.01 | 0.269 | 0.29 |
| | WCDMA II | RMC12.2K | Right Tilted | 9262 | 1 | 23.5 | 23.20 | 1.07 | 0.00 | 0.1 | 0.11 |
| | WCDMA II | RMC12.2K | Left Cheek | 9262 | 1 | 23.5 | 23.20 | 1.07 | 0.10 | 0.241 | 0.26 |
| | WCDMA II | RMC12.2K | Left Tilted | 9262 | 1 | 23.5 | 23.20 | 1.07 | -0.02 | 0.109 | 0.12 |
| | WCDMA II | RMC12.2K | Right Cheek | 9262 | 2 | 23.5 | 23.20 | 1.07 | 0.03 | 0.153 | 0.16 |
| 04 | WCDMA V | RMC12.2K | Right Cheek | 4132 | 1 | 23.5 | 23.02 | 1.12 | 0.15 | 0.186 | 0.21 |
| | WCDMA V | RMC12.2K | Right Tilted | 4132 | 1 | 23.5 | 23.02 | 1.12 | 0.13 | 0.137 | 0.15 |
| | WCDMA V | RMC12.2K | Left Cheek | 4132 | 1 | 23.5 | 23.02 | 1.12 | -0.06 | 0.19 | 0.21 |
| | WCDMA V | RMC12.2K | Left Tilted | 4132 | 1 | 23.5 | 23.02 | 1.12 | 0.07 | 0.127 | 0.14 |
| | WCDMA V | RMC12.2K | Left Cheek | 4132 | 2 | 23.5 | 23.02 | 1.12 | -0.07 | 0.105 | 0.12 |
| 05 | 802.11b | - | Right Cheek | 1 | 1 | 11.5 | 11.39 | 1.03 | -0.06 | 0.086 | 0.09 |
| | 802.11b | - | Right Tilted | 1 | 1 | 11.5 | 11.39 | 1.03 | 0.14 | 0.056 | 0.06 |
| | 802.11b | - | Left Cheek | 1 | 1 | 11.5 | 11.39 | 1.03 | 0.06 | 0.17 | 0.17 |
| | 802.11b | - | Left Tilted | 1 | 1 | 11.5 | 11.39 | 1.03 | 0.07 | 0.092 | 0.09 |
| | 802.11b | - | Left Cheek | 1 | 2 | 11.5 | 11.39 | 1.03 | -0.06 | 0.178 | 0.18 |

Note:

- SAR is performed on the highest power channel. When the reported SAR value of highest power channel is <= 0.8 W/kg, SAR testing for optional channel is not required.
- According to KDB 248227, when the extrapolated maximum peak SAR for the maximum output power channel is <= 1.6 W/kg and the 1g averaged SAR is <= 0.8 W/kg, WLAN SAR testing for other channels is not required.
- SAR testing for 802.11g/n is not required when its maximum power is less than 1/4 dB higher than 802.11b.

4.7.2 SAR Results for Body-Worn (Separation Distance is 1.0 cm Gap)

| Plot No. | Band | Mode | Test Position | Ch. | EUT Config. | Max. Tune-up Power (dBm) | Measured Conducted Power (dBm) | Scaling Factor | Power Drift (dB) | Measured SAR-1g (W/kg) | Scaled SAR-1g (W/kg) |
|----------|----------|----------|---------------|------|-------------|--------------------------|--------------------------------|----------------|------------------|------------------------|----------------------|
| 06 | GSM850 | GPRS 12 | Front Face | 251 | 1 | 29.1 | 28.81 | 1.07 | -0.05 | 0.413 | 0.44 |
| | GSM850 | GPRS 12 | Rear Face | 251 | 1 | 29.1 | 28.81 | 1.07 | 0.06 | 0.735 | 0.79 |
| | GSM850 | GPRS 12 | Rear Face | 251 | 2 | 29.1 | 28.81 | 1.07 | -0.01 | 0.695 | 0.74 |
| 07 | GSM1900 | GPRS 10 | Front Face | 810 | 1 | 29.3 | 28.98 | 1.08 | -0.04 | 0.263 | 0.28 |
| | GSM1900 | GPRS 10 | Rear Face | 810 | 1 | 29.3 | 28.98 | 1.08 | 0.11 | 0.694 | 0.75 |
| | GSM1900 | GPRS 10 | Rear Face | 810 | 2 | 29.3 | 28.98 | 1.08 | 0.17 | 1.07 | 1.15 |
| | GSM1900 | GPRS 10 | Rear Face | 512 | 2 | 29.3 | 28.79 | 1.12 | 0.12 | 1.22 | 1.37 |
| | GSM1900 | GPRS 10 | Rear Face | 661 | 2 | 29.3 | 28.74 | 1.14 | 0.09 | 1.26 | 1.43 |
| | GSM1900 | GPRS 10 | Rear Face | 661 | 2 | 29.3 | 28.74 | 1.14 | -0.18 | 1.25 | 1.42 |
| 08 | WCDMA II | RMC12.2K | Front Face | 9262 | 1 | 23.5 | 23.20 | 1.07 | -0.11 | 0.34 | 0.36 |
| | WCDMA II | RMC12.2K | Rear Face | 9262 | 1 | 23.5 | 23.20 | 1.07 | 0.07 | 0.834 | 0.89 |
| | WCDMA II | RMC12.2K | Rear Face | 9400 | 1 | 23.5 | 22.40 | 1.29 | 0.02 | 0.884 | 1.14 |
| | WCDMA II | RMC12.2K | Rear Face | 9538 | 1 | 23.5 | 22.32 | 1.31 | -0.16 | 0.59 | 0.77 |
| | WCDMA II | RMC12.2K | Rear Face | 9400 | 2 | 23.5 | 22.40 | 1.07 | 0.10 | 0.58 | 0.62 |
| 09 | WCDMA II | RMC12.2K | Rear Face | 9400 | 1 | 23.5 | 22.40 | 1.29 | 0.05 | 0.871 | 1.12 |
| | WCDMA V | RMC12.2K | Front Face | 4132 | 1 | 23.5 | 23.02 | 1.12 | 0.00 | 0.26 | 0.29 |
| | WCDMA V | RMC12.2K | Rear Face | 4132 | 1 | 23.5 | 23.02 | 1.12 | -0.11 | 0.428 | 0.48 |
| 10 | WCDMA V | RMC12.2K | Rear Face | 4132 | 2 | 23.5 | 23.02 | 1.12 | -0.07 | 0.246 | 0.27 |
| | 802.11b | - | Front Face | 1 | 1 | 11.5 | 11.39 | 1.03 | -0.11 | 0.036 | 0.04 |
| | 802.11b | - | Rear Face | 1 | 1 | 11.5 | 11.39 | 1.03 | 0.10 | 0.069 | 0.07 |
| | 802.11b | - | Rear Face | 1 | 2 | 11.5 | 11.39 | 1.03 | 0.11 | 0.06 | 0.06 |

Note:

- SAR is performed on the highest power channel. When the reported SAR value of highest power channel is ≤ 0.8 W/kg, SAR testing for optional channel is not required.
- According to KDB 248227, when the extrapolated maximum peak SAR for the maximum output power channel is ≤ 1.6 W/kg and the 1g averaged SAR is ≤ 0.8 W/kg, WLAN SAR testing for other channels is not required.
- SAR testing for 802.11g/n is not required when its maximum power is less than 1/4 dB higher than 802.11b.

4.7.3 SAR Results for Hotspot (Separation Distance is 1.0 cm Gap)

| Plot No. | Band | Mode | Test Position | Ch. | EUT Config. | Max. Tune-up Power (dBm) | Measured Conducted Power (dBm) | Scaling Factor | Power Drift (dB) | Measured SAR-1g (W/kg) | Scaled SAR-1g (W/kg) |
|----------|----------|----------|---------------|------|-------------|--------------------------|--------------------------------|----------------|------------------|------------------------|----------------------|
| 06 | GSM850 | GPRS 12 | Front Face | 251 | 1 | 29.1 | 28.81 | 1.07 | -0.05 | 0.413 | 0.44 |
| | GSM850 | GPRS 12 | Rear Face | 251 | 1 | 29.1 | 28.81 | 1.07 | 0.06 | 0.735 | 0.79 |
| | GSM850 | GPRS 12 | Left Side | 251 | 1 | 29.1 | 28.81 | 1.07 | -0.03 | 0.435 | 0.47 |
| | GSM850 | GPRS 12 | Right Side | 251 | 1 | 29.1 | 28.81 | 1.07 | 0.02 | 0.37 | 0.40 |
| | GSM850 | GPRS 12 | Bottom Side | 251 | 1 | 29.1 | 28.81 | 1.07 | 0.04 | 0.105 | 0.11 |
| | GSM850 | GPRS 12 | Rear Face | 251 | 2 | 29.1 | 28.81 | 1.07 | -0.01 | 0.695 | 0.74 |
| | GSM1900 | GPRS 10 | Front Face | 810 | 1 | 29.3 | 28.98 | 1.08 | -0.04 | 0.263 | 0.28 |
| | GSM1900 | GPRS 10 | Rear Face | 810 | 1 | 29.3 | 28.98 | 1.08 | 0.11 | 0.694 | 0.75 |
| | GSM1900 | GPRS 10 | Left Side | 810 | 1 | 29.3 | 28.98 | 1.08 | -0.17 | 0.075 | 0.08 |
| | GSM1900 | GPRS 10 | Right Side | 810 | 1 | 29.3 | 28.98 | 1.08 | -0.16 | 0.199 | 0.21 |
| | GSM1900 | GPRS 10 | Bottom Side | 810 | 1 | 29.3 | 28.98 | 1.08 | 0.11 | 0.551 | 0.59 |
| | GSM1900 | GPRS 10 | Rear Face | 810 | 2 | 29.3 | 28.98 | 1.08 | 0.17 | 1.07 | 1.15 |
| 07 | GSM1900 | GPRS 10 | Rear Face | 512 | 2 | 29.3 | 28.79 | 1.12 | 0.12 | 1.22 | 1.37 |
| | GSM1900 | GPRS 10 | Rear Face | 661 | 2 | 29.3 | 28.74 | 1.14 | 0.09 | 1.26 | 1.43 |
| | GSM1900 | GPRS 10 | Rear Face | 661 | 2 | 29.3 | 28.74 | 1.14 | -0.18 | 1.25 | 1.42 |
| | WCDMA II | RMC12.2K | Front Face | 9262 | 1 | 23.5 | 23.20 | 1.07 | -0.11 | 0.34 | 0.36 |
| | WCDMA II | RMC12.2K | Rear Face | 9262 | 1 | 23.5 | 23.20 | 1.07 | 0.07 | 0.834 | 0.89 |
| | WCDMA II | RMC12.2K | Left Side | 9262 | 1 | 23.5 | 23.20 | 1.07 | 0.03 | 0.073 | 0.08 |
| | WCDMA II | RMC12.2K | Right Side | 9262 | 1 | 23.5 | 23.20 | 1.07 | -0.07 | 0.154 | 0.17 |
| | WCDMA II | RMC12.2K | Bottom Side | 9262 | 1 | 23.5 | 23.20 | 1.07 | 0.09 | 0.575 | 0.62 |
| | WCDMA II | RMC12.2K | Rear Face | 9400 | 1 | 23.5 | 22.40 | 1.29 | 0.02 | 0.884 | 1.14 |
| | WCDMA II | RMC12.2K | Rear Face | 9538 | 1 | 23.5 | 22.32 | 1.31 | -0.16 | 0.59 | 0.77 |
| | WCDMA II | RMC12.2K | Rear Face | 9400 | 2 | 23.5 | 22.40 | 1.07 | 0.10 | 0.58 | 0.62 |
| | WCDMA II | RMC12.2K | Rear Face | 9400 | 1 | 23.5 | 22.40 | 1.29 | 0.05 | 0.871 | 1.12 |
| | WCDMA V | RMC12.2K | Front Face | 4132 | 1 | 23.5 | 23.02 | 1.12 | 0.00 | 0.26 | 0.29 |
| 09 | WCDMA V | RMC12.2K | Rear Face | 4132 | 1 | 23.5 | 23.02 | 1.12 | -0.11 | 0.428 | 0.48 |
| | WCDMA V | RMC12.2K | Left Side | 4132 | 1 | 23.5 | 23.02 | 1.12 | 0.09 | 0.296 | 0.33 |
| | WCDMA V | RMC12.2K | Right Side | 4132 | 1 | 23.5 | 23.02 | 1.12 | 0.01 | 0.298 | 0.33 |
| | WCDMA V | RMC12.2K | Bottom Side | 4132 | 1 | 23.5 | 23.02 | 1.12 | 0.09 | 0.063 | 0.07 |
| | WCDMA V | RMC12.2K | Rear Face | 4132 | 2 | 23.5 | 23.02 | 1.12 | -0.07 | 0.246 | 0.27 |
| 10 | 802.11b | - | Front Face | 1 | 1 | 11.5 | 11.39 | 1.03 | -0.11 | 0.036 | 0.04 |
| | 802.11b | - | Rear Face | 1 | 1 | 11.5 | 11.39 | 1.03 | 0.10 | 0.069 | 0.07 |
| | 802.11b | - | Right Side | 1 | 1 | 11.5 | 11.39 | 1.03 | 0.01 | 0.042 | 0.04 |
| | 802.11b | - | Top Side | 1 | 1 | 11.5 | 11.39 | 1.03 | 0.01 | 0.017 | 0.02 |
| | 802.11b | - | Rear Face | 1 | 2 | 11.5 | 11.39 | 1.03 | 0.11 | 0.06 | 0.06 |

Note:

- SAR is performed on the highest power channel. When the reported SAR value of highest power channel is ≤ 0.8 W/kg, SAR testing for optional channel is not required.
- According to KDB 248227, when the extrapolated maximum peak SAR for the maximum output power channel is ≤ 1.6 W/kg and the 1g averaged SAR is ≤ 0.8 W/kg, WLAN SAR testing for other channels is not required.
- SAR testing for 802.11g/n is not required when its maximum power is less than 1/4 dB higher than 802.11b.

FCC SAR Test Report

4.7.4 SAR Measurement Variability

According to KDB 865664 D01 v01r01, SAR measurement variability was assessed for each frequency band, which is determined by the SAR probe calibration point and tissue-equivalent medium used for the device measurements. When both head and body tissue-equivalent media are required for SAR measurements in a frequency band, the variability measurement procedures should be applied to the tissue medium with the highest measured SAR, using the highest measured SAR configuration for that tissue-equivalent medium. Alternatively, if the highest measured SAR for both head and body tissue-equivalent media are ≤ 1.45 W/kg and the ratio of these highest SAR values, i.e., largest divided by smallest value, is ≤ 1.10 , the highest SAR configuration for either head or body tissue-equivalent medium may be used to perform the repeated measurement. These additional measurements are repeated after the completion of all measurements requiring the same head or body tissue-equivalent medium in a frequency band. The test device should be returned to ambient conditions (normal room temperature) with the battery fully charged before it is re-mounted on the device holder for the repeated measurement(s) to minimize any unexpected variations in the repeated results.

SAR repeated measurement procedure:

1. When the highest measured SAR is < 0.80 W/kg, repeated measurement is not required.
2. When the highest measured SAR is ≥ 0.80 W/kg, repeat that measurement once.
3. If the ratio of largest to smallest SAR for the original and first repeated measurements is > 1.20 , or when the original or repeated measurement is ≥ 1.45 W/kg, perform a second repeated measurement.
4. If the ratio of largest to smallest SAR for the original, first and second repeated measurements is > 1.20 , and the original, first or second repeated measurement is ≥ 1.5 W/kg, perform a third repeated measurement.

| Band | Mode | Test Position | Ch. | Original Measured SAR-1g (W/kg) | 1st Repeated SAR-1g (W/kg) | L/S Ratio | 2nd Repeated SAR-1g (W/kg) | L/S Ratio | 3rd Repeated SAR-1g (W/kg) | L/S Ratio |
|----------|----------|---------------|------|---------------------------------|----------------------------|-----------|----------------------------|-----------|----------------------------|-----------|
| GSM1900 | GPRS 10 | Rear Face | 661 | 1.26 | 1.25 | 1.01 | N/A | N/A | N/A | N/A |
| WCDMA II | RMC12.2K | Rear Face | 9400 | 0.884 | 0.871 | 1.01 | N/A | N/A | N/A | N/A |

FCC SAR Test Report

4.7.5 Simultaneous Multi-band Transmission Evaluation

<Estimated SAR Calculation>

According to KDB 447498 D01, when standalone SAR test exclusion applies to an antenna that transmits simultaneously with other antennas, the standalone SAR was estimated according to following formula to result in substantially conservative SAR values of ≤ 0.4 W/kg to determine simultaneous transmission SAR test exclusion.

$$\text{Estimated SAR} = \frac{\text{Max. Tune up Power}_{(\text{mW})}}{\text{Min. Test Separation Distance}_{(\text{mm})}} \times \frac{\sqrt{f_{(\text{GHz})}}}{7.5}$$

If the minimum test separation distance is < 5 mm, a distance of 5 mm is used for estimated SAR calculation. When the test separation distance is > 50 mm, the 0.4 W/kg is used for SAR-1g.

| Mode / Band | Frequency (GHz) | Max. Tune-up Power (dBm) | Test Position | Separation Distance (mm) | Estimated SAR (W/kg) |
|-------------|-----------------|--------------------------|---------------|--------------------------|----------------------|
| BT (DSS) | 2.48 | 4.5 | Body-worn | 10 | 0.06 |

Note:

1. The separation distance is determined from the outer housing of the EUT to the user.
2. When standalone SAR testing is not required, an estimated SAR can be applied to determine simultaneous transmission SAR test exclusion.

FCC SAR Test Report

<SAR Summation Analysis>

Simultaneous transmission SAR test exclusion is determined for each operating configuration and exposure condition according to the reported standalone SAR of each applicable simultaneous transmitting antenna. When the sum of SAR_{1g} of all simultaneously transmitting antennas in an operating mode and exposure condition combination is within the SAR limit (SAR_{1g} 1.6 W/kg), the simultaneous transmission SAR is not required. When the sum of SAR_{1g} is greater than the SAR limit (SAR_{1g} 1.6 W/kg), SAR test exclusion is determined by the SPLSR.

| No. | Conditions (SAR1 + SAR2) | Exposure Condition | Test Position | Max. SAR1 | Max. SAR2 | SAR Summation | SPLSR Analysis |
|-----|------------------------------------|-----------------------|------------------|--------------|--------------|------------------|------------------------------|
| 1 | GSM850 + WLAN (DTS) | Head | Right Cheek | 0.31 | 0.09 | 0.40 | Σ SAR < 1.6, Not required |
| | | | Right Tilted | 0.21 | 0.06 | 0.27 | Σ SAR < 1.6, Not required |
| | | | Left Cheek | 0.34 | 0.18 | 0.52 | Σ SAR < 1.6, Not required |
| | | | Left Tilted | 0.21 | 0.09 | 0.30 | Σ SAR < 1.6, Not required |
| | | Body-Worn | Front Face | 0.44 | 0.04 | 0.48 | Σ SAR < 1.6, Not required |
| | | | Rear Face | 0.79 | 0.07 | 0.86 | Σ SAR < 1.6, Not required |
| | | Hotspot | Front Face | 0.44 | 0.04 | 0.48 | Σ SAR < 1.6, Not required |
| | | | Rear Face | 0.79 | 0.07 | 0.86 | Σ SAR < 1.6, Not required |
| | | | Left Side | 0.47 | - | 0.47 | Σ SAR < 1.6, Not required |
| | | | Right Side | 0.40 | 0.04 | 0.44 | Σ SAR < 1.6, Not required |
| | | | Top Side | - | 0.02 | 0.02 | Σ SAR < 1.6, Not required |
| | | | | Bottom Side | 0.11 | - | 0.11 |
| 2 | GSM850 + BT (DSS) | Body-Worn | Front Face | 0.44 | 0.06 | 0.50 | Σ SAR < 1.6, Not required |
| | | | Rear Face | 0.79 | 0.06 | 0.85 | Σ SAR < 1.6, Not required |



FCC SAR Test Report

A D T

| No. | Conditions (SAR1 + SAR2) | Exposure Condition | Test Position | Max. SAR1 | Max. SAR2 | SAR Summation | SPLSR Analysis |
|-----|--------------------------|--------------------|---------------|-----------|-----------|----------------------------------|----------------------------------|
| 3 | GSM1900 + WLAN (DTS) | Head | Right Cheek | 0.37 | 0.09 | 0.46 | Σ SAR < 1.6, Not required |
| | | | Right Tilted | 0.09 | 0.06 | 0.15 | Σ SAR < 1.6, Not required |
| | | | Left Cheek | 0.17 | 0.18 | 0.35 | Σ SAR < 1.6, Not required |
| | | | Left Tilted | 0.09 | 0.09 | 0.18 | Σ SAR < 1.6, Not required |
| | | Body-Worn | Front Face | 0.28 | 0.04 | 0.32 | Σ SAR < 1.6, Not required |
| | | | Rear Face | 1.43 | 0.07 | 1.50 | Σ SAR < 1.6, Not required |
| | | Hotspot | Front Face | 0.28 | 0.04 | 0.32 | Σ SAR < 1.6, Not required |
| | | | Rear Face | 1.43 | 0.07 | 1.50 | Σ SAR < 1.6, Not required |
| | | | Left Side | 0.08 | - | 0.08 | Σ SAR < 1.6, Not required |
| | | | Right Side | 0.21 | 0.04 | 0.25 | Σ SAR < 1.6, Not required |
| | | | Top Side | - | 0.02 | 0.02 | Σ SAR < 1.6, Not required |
| | | Bottom Side | 0.59 | - | 0.59 | Σ SAR < 1.6, Not required | |
| 4 | GSM1900 + BT (DSS) | Body-Worn | Front Face | 0.28 | 0.06 | 0.34 | Σ SAR < 1.6, Not required |
| | | | Rear Face | 1.43 | 0.06 | 1.49 | Σ SAR < 1.6, Not required |

| No. | Conditions (SAR1 + SAR2) | Exposure Condition | Test Position | Max. SAR1 | Max. SAR2 | SAR Summation | SPLSR Analysis |
|-----|--------------------------|--------------------|---------------|-----------|-----------|----------------------------------|----------------------------------|
| 5 | WCDMA II + WLAN (DTS) | Head | Right Cheek | 0.29 | 0.09 | 0.38 | Σ SAR < 1.6, Not required |
| | | | Right Tilted | 0.11 | 0.06 | 0.17 | Σ SAR < 1.6, Not required |
| | | | Left Cheek | 0.26 | 0.18 | 0.44 | Σ SAR < 1.6, Not required |
| | | | Left Tilted | 0.12 | 0.09 | 0.21 | Σ SAR < 1.6, Not required |
| | | Body-Worn | Front Face | 0.36 | 0.04 | 0.40 | Σ SAR < 1.6, Not required |
| | | | Rear Face | 1.14 | 0.07 | 1.21 | Σ SAR < 1.6, Not required |
| | | Hotspot | Front Face | 0.36 | 0.04 | 0.40 | Σ SAR < 1.6, Not required |
| | | | Rear Face | 1.14 | 0.07 | 1.21 | Σ SAR < 1.6, Not required |
| | | | Left Side | 0.08 | - | 0.08 | Σ SAR < 1.6, Not required |
| | | | Right Side | 0.17 | 0.04 | 0.21 | Σ SAR < 1.6, Not required |
| | | | Top Side | - | 0.02 | 0.02 | Σ SAR < 1.6, Not required |
| | | Bottom Side | 0.62 | - | 0.62 | Σ SAR < 1.6, Not required | |
| 6 | WCDMA II + BT (DSS) | Body-Worn | Front Face | 0.36 | 0.06 | 0.42 | Σ SAR < 1.6, Not required |
| | | | Rear Face | 1.14 | 0.06 | 1.20 | Σ SAR < 1.6, Not required |



FCC SAR Test Report

A D T

| No. | Conditions (SAR1 + SAR2) | Exposure Condition | Test Position | Max. SAR1 | Max. SAR2 | SAR Summation | SPLSR Analysis |
|-----|--------------------------|--------------------|---------------|-----------|-----------|---------------|----------------------------------|
| 7 | WCDMA V + WLAN (DTS) | Head | Right Cheek | 0.21 | 0.09 | 0.30 | Σ SAR < 1.6, Not required |
| | | | Right Tilted | 0.15 | 0.06 | 0.21 | Σ SAR < 1.6, Not required |
| | | | Left Cheek | 0.21 | 0.18 | 0.39 | Σ SAR < 1.6, Not required |
| | | | Left Tilted | 0.14 | 0.09 | 0.23 | Σ SAR < 1.6, Not required |
| | | Body-Worn | Front Face | 0.29 | 0.04 | 0.33 | Σ SAR < 1.6, Not required |
| | | | Rear Face | 0.48 | 0.07 | 0.55 | Σ SAR < 1.6, Not required |
| | | Hotspot | Front Face | 0.29 | 0.04 | 0.33 | Σ SAR < 1.6, Not required |
| | | | Rear Face | 0.48 | 0.07 | 0.55 | Σ SAR < 1.6, Not required |
| | | | Left Side | 0.33 | - | 0.33 | Σ SAR < 1.6, Not required |
| | | | Right Side | 0.33 | 0.04 | 0.37 | Σ SAR < 1.6, Not required |
| | | | Top Side | - | 0.02 | 0.02 | Σ SAR < 1.6, Not required |
| | | | Bottom Side | 0.07 | - | 0.07 | Σ SAR < 1.6, Not required |
| 8 | WCDMA V + BT (DSS) | Body-Worn | Front Face | 0.29 | 0.06 | 0.35 | Σ SAR < 1.6, Not required |
| | | | Rear Face | 0.48 | 0.06 | 0.54 | Σ SAR < 1.6, Not required |

Test Engineer : Morrison Huang, and Allen Chen



5. Calibration of Test Equipment

| Equipment | Manufacturer | Model | SN | Cal. Date | Cal. Interval |
|------------------------------|--------------|----------------|------------|---------------|---------------|
| System Validation Kit | SPEAG | D835V2 | 4d121 | Apr. 25, 2013 | Annual |
| System Validation Kit | SPEAG | D1900V2 | 5d036 | Jan. 21, 2013 | Annual |
| System Validation Kit | SPEAG | D2450V2 | 737 | Jan. 21, 2013 | Annual |
| Dosimetric E-Field Probe | SPEAG | EX3DV4 | 3590 | Feb. 20, 2013 | Annual |
| Dosimetric E-Field Probe | SPEAG | EX3DV4 | 3650 | Apr. 30, 2013 | Annual |
| Dosimetric E-Field Probe | SPEAG | EX3DV4 | 3801 | Jun. 20, 2013 | Annual |
| Data Acquisition Electronics | SPEAG | DAE3 | 360 | Jan. 30, 2013 | Annual |
| Data Acquisition Electronics | SPEAG | DAE3 | 510 | Sep. 25, 2013 | Annual |
| Data Acquisition Electronics | SPEAG | DAE4 | 861 | Mar. 19, 2013 | Annual |
| SAM Phantom | SPEAG | QD000P40CD | TP-1127 | N/A | N/A |
| SAM Phantom | SPEAG | QD000P40CD | TP-1496 | N/A | N/A |
| ELI Phantom | SPEAG | QDOVA001B | TP-1039 | N/A | N/A |
| ELI Phantom | SPEAG | QDOVA002AA | 1206 | N/A | N/A |
| Radio Communication Tester | Agilent | E5515C | MY50266628 | Nov. 22, 2012 | Biennial |
| ENA Series Network Analyzer | Agilent | E5071C | MY46214281 | Jun. 10, 2013 | Annual |
| MXG Analog Signal Generator | Agilent | N5181A | MY50143868 | Jun. 06, 2013 | Annual |
| Power Meter | Anritsu | ML2495A | 1218009 | Jun. 11, 2013 | Annual |
| Power Sensor | Anritsu | MA2411B | 1207252 | Jun. 11, 2013 | Annual |
| EXA Spectrum Analyzer | Agilent | N9010A | MY52100136 | Jun. 26, 2013 | Annual |
| Dielectric Probe Kit | Agilent | 85070D | E2-020018 | May 13, 2013 | Annual |
| Thermometer | YFE | YF-160A | 110600361 | Feb. 20, 2013 | Annual |
| Directional Coupler | Woken | 0110A056020-10 | 11122702 | Apr. 18, 2013 | Annual |
| Power Amplifier | AR | 5S1G4 | 0339656 | Apr. 18, 2013 | Annual |
| Power Amplifier | Mini-Circuit | ZVE-8G | 001000422 | Apr. 18, 2013 | Annual |
| Attenuator | Woken | 00800A1G01L-03 | N/A | Apr. 18, 2013 | Annual |

6. Measurement Uncertainty

| Error Description | Uncertainty Value (±%) | Probability Distribution | Divisor | Ci (1g) | Standard Uncertainty (1g) | Vi |
|--------------------------------------|------------------------|--------------------------|---------|---------|---------------------------|----|
| Measurement System | | | | | | |
| Probe Calibration | 6.0 | Normal | 1 | 1 | ± 6.0 % | ∞ |
| Axial Isotropy | 4.7 | Rectangular | √3 | 0.7 | ± 1.9 % | ∞ |
| Hemispherical Isotropy | 9.6 | Rectangular | √3 | 0.7 | ± 3.9 % | ∞ |
| Boundary Effects | 1.0 | Rectangular | √3 | 1 | ± 0.6 % | ∞ |
| Linearity | 4.7 | Rectangular | √3 | 1 | ± 2.7 % | ∞ |
| System Detection Limits | 1.0 | Rectangular | √3 | 1 | ± 0.6 % | ∞ |
| Readout Electronics | 0.6 | Normal | 1 | 1 | ± 0.6 % | ∞ |
| Response Time | 0.0 | Rectangular | √3 | 1 | ± 0.0 % | ∞ |
| Integration Time | 1.7 | Rectangular | √3 | 1 | ± 1.0 % | ∞ |
| RF Ambient Noise | 3.0 | Rectangular | √3 | 1 | ± 1.7 % | ∞ |
| RF Ambient Reflections | 3.0 | Rectangular | √3 | 1 | ± 1.7 % | ∞ |
| Probe Positioner | 0.5 | Rectangular | √3 | 1 | ± 0.3 % | ∞ |
| Probe Positioning | 2.9 | Rectangular | √3 | 1 | ± 1.7 % | ∞ |
| Max. SAR Eval. | 2.3 | Rectangular | √3 | 1 | ± 1.3 % | ∞ |
| Test Sample Related | | | | | | |
| Device Positioning | 3.9 | Normal | 1 | 1 | ± 3.9 % | 31 |
| Device Holder | 2.7 | Normal | 1 | 1 | ± 2.7 % | 19 |
| Power Drift | 5.0 | Rectangular | √3 | 1 | ± 2.9 % | ∞ |
| Phantom and Setup | | | | | | |
| Phantom Uncertainty | 4.0 | Rectangular | √3 | 1 | ± 2.3 % | ∞ |
| Liquid Conductivity (Target) | 5.0 | Rectangular | √3 | 0.64 | ± 1.8 % | ∞ |
| Liquid Conductivity (Meas.) | 5.0 | Normal | 1 | 0.64 | ± 3.2 % | 29 |
| Liquid Permittivity (Target) | 5.0 | Rectangular | √3 | 0.6 | ± 1.7 % | ∞ |
| Liquid Permittivity (Meas.) | 5.0 | Normal | 1 | 0.6 | ± 3.0 % | 29 |
| Combined Standard Uncertainty | | | | | ± 11.7 % | |
| Expanded Uncertainty (K=2) | | | | | ± 23.4 % | |

Uncertainty budget for frequency range 300 MHz to 3 GHz



FCC SAR Test Report

7. Information on the Testing Laboratories

We, Bureau Veritas Consumer Products Services (H.K.) Ltd., Taoyuan Branch, were founded in 1988 to provide our best service in EMC, Radio, Telecom and Safety consultation. Our laboratories are accredited and approved according to ISO/IEC 17025.

If you have any comments, please feel free to contact us at the following:

Taiwan HwaYa EMC/RF/Safety/Telecom Lab:

Add: No. 19, Hwa Ya 2nd Rd, Wen Hwa Vil., Kwei Shan Hsiang, Taoyuan Hsien 333, Taiwan, R.O.C.

Tel: 886-3-318-3232

Fax: 886-3-327-0892

Taiwan LinKo EMC/RF Lab:

Add: No. 47, 14th Ling, Chia Pau Vil., Linkou Dist., New Taipei City 244, Taiwan, R.O.C.

Tel: 886-2-2605-2180

Fax: 886-2-2605-1924

Taiwan HsinChu EMC/RF Lab:

Add: No. 81-1, Lu Liao Keng, 9th Ling, Wu Lung Vil., Chiung Lin Township, Hsinchu County 307, Taiwan, R.O.C.

Tel: 886-3-593-5343

Fax: 886-3-593-5342

Email: service.adt@tw.bureauveritas.com

Web Site: www.adt.com.tw

The road map of all our labs can be found in our web site also.

---END---