



A D T

FCC SAR Test Report

Report No. : SA130725C19

Applicant : Lenovo Mobile Communication Technology Ltd.

Address : No. 999, Qishan North 2nd Road, Information & Optoelectronics Park, Torch Hi-tech Industry Development Zone, Xiamen, P.R.China

Product : Lenovo Mobile Phone

FCC ID : YCNA369I

MID : 36930031

Brand : lenovo

Model No. : Lenovo A369i

Standards : FCC 47 CFR Part 2 (2.1093) / IEEE C95.1:1992 / IEEE 1528:2003
 FCC OET Bulletin 65 Supplement C (Edition 01-01)
 KDB 248227 D01 v01r02 / KDB 447498 D01 v05r01 / KDB 648474 D04 v01r01
 KDB 941225 D01 v02 / KDB 941225 D02 v02r02
 KDB 941225 D03 v01 / KDB 941225 D06 v01r01

Date of Testing : Aug. 02, 2013 ~ Aug. 06, 2013

CERTIFICATION: The above equipment have been tested by **Bureau Veritas Consumer Products Services (H.K.) Ltd., China Branch - Dongguan Lab**, and found compliance with the requirement of the above standards. The test record, data evaluation & Equipment Under Test (EUT) configurations represented herein are true and accurate accounts of the measurements of the sample's SAR characteristics under the conditions specified in this report. It should not be reproduced except in full, without the written approval of our laboratory. The client should not use it to claim product certification, approval, or endorsement by A2LA or any government agencies.

Prepared By : Evonne Liu
 Evonne Liu / Specialist

Approved By : Roy Wu
 Roy Wu / Manager



No: 2951.01

This report is for your exclusive use. Any copying or replication of this report to or for any other person or entity, or use of our name or trademark, is permitted only with our prior written permission. This report sets forth our findings solely with respect to the test samples identified herein. The results set forth in this report are not indicative or representative of the quality or characteristics of the lot from which a test sample was taken or any similar or identical product unless specifically and expressly noted. Our report includes all of the tests requested by you and the results thereof based upon the information that you provided to us. You have 60 days from date of issuance of this report to notify us of any material error or omission caused by our negligence, provided, however, that such notice shall be in writing and shall specifically address the issue you wish to raise. A failure to raise such issue within the prescribed time shall constitute your unqualified acceptance of the completeness of this report, the tests conducted and the correctness of the report contents. Unless specific mention, the uncertainty of measurement has been explicitly taken into account to declare the compliance or non-compliance to the specification.



Table of Contents

Release Control Record	3
1. Summary of Maximum SAR Value	4
2. Description of Equipment Under Test	5
3. SAR Measurement System	6
3.1 Definition of Specific Absorption Rate (SAR).....	6
3.2 SPEAG DASY System	6
3.2.1 Robot.....	7
3.2.2 Probes.....	8
3.2.3 Data Acquisition Electronics (DAE)	8
3.2.4 Phantoms	9
3.2.5 Device Holder.....	9
3.2.6 System Validation Dipoles	10
3.2.7 Tissue Simulating Liquids.....	10
3.3 SAR System Verification	13
3.4 SAR Measurement Procedure	14
3.4.1 Area & Zoom Scan Procedure	14
3.4.2 Volume Scan Procedure.....	14
3.4.3 Power Drift Monitoring.....	15
3.4.4 Spatial Peak SAR Evaluation	15
3.4.5 SAR Averaged Methods	15
4. SAR Measurement Evaluation	16
4.1 EUT Configuration and Setting.....	16
4.2 EUT Testing Position	18
4.2.1 Head Exposure Conditions.....	18
4.2.2 Body-Worn Accessory Exposure Conditions	20
4.2.3 Hotspot Mode Exposure conditions.....	21
4.2.4 SAR Test Exclusions	21
4.3 Tissue Verification	22
4.4 System Validation.....	22
4.5 System Verification.....	22
4.6 Maximum Output Power.....	23
4.6.1 Maximum Conducted Power	23
4.6.2 Measured Conducted Power Result.....	24
4.7 SAR Testing Results.....	25
4.7.1 SAR Results for Head	25
4.7.2 SAR Results for Body-Worn (Separation Distance is 1.0 cm Gap)	26
4.7.3 SAR Results for Hotspot (Separation Distance is 1.0 cm Gap)	27
4.7.4 SAR Measurement Variability.....	28
4.7.5 Simultaneous Multi-band Transmission Evaluation	29
5. Calibration of Test Equipment.....	33
6. Measurement Uncertainty.....	34
7. Information on the Testing Laboratories	35

- Appendix A. SAR Plots of System Verification
- Appendix B. SAR Plots of SAR Measurement
- Appendix C. Calibration Certificate for Probe and Dipole
- Appendix D. Photographs of EUT and Setup



Release Control Record

Issue No.	Reason for Change	Date Issued
R01	Initial release	Aug. 09, 2013



FCC SAR Test Report

1. Summary of Maximum SAR Value

Equipment Class	Mode	Highest Reported Head SAR _{1g} (W/kg)	Highest Reported Body-Worn SAR _{1g} (1.0 cm Gap) (W/kg)	Highest Reported Hotspot SAR _{1g} (1.0 cm Gap) (W/kg)
PCE	GSM850	0.70	1.30	1.30
	GSM1900	0.71	1.04	1.06
	WCDMA II	1.16	0.73	0.92
	WCDMA V	0.79	1.12	1.12
DTS	2.4G WLAN	0.41	0.11	0.11
DSS	Bluetooth	N/A	N/A	N/A
Highest Simultaneous Transmission SAR		Head (W/kg)	Body-Worn (W/kg)	Hotspot (W/kg)
PCE+DTS		1.42	1.41	1.41
PCE+DSS		N/A	1.32	N/A

Note:

1. The SAR limit (**Head & Body: SAR_{1g} 1.6 W/kg**) for general population / uncontrolled exposure is specified in FCC 47 CFR part 2 (2.1093) and ANSI/IEEE C95.1-1992.

2. Description of Equipment Under Test

EUT Type	Lenovo Mobile Phone
FCC ID	YCNA369I
Brand Name	lenovo
Model Name	Lenovo A369i
MID	36930031
HW Version	LDAM295B1
SW Version	LDA3I05.1.0_M295
Tx Frequency Bands (Unit: MHz)	GSM850 : 824.2 ~ 848.8 GSM1900 : 1850.2 ~ 1909.8 WCDMA Band II : 1852.4 ~ 1907.6 WCDMA Band V : 826.4 ~ 846.6 WLAN : 2412 ~ 2462 Bluetooth : 2402 ~ 2480
Uplink Modulations	GSM & GPRS : GMSK EDGE : 8PSK WCDMA : QPSK 802.11b : DSSS 802.11g/n : OFDM Bluetooth : GFSK
Maximum Tune-up Conducted Power (Unit: dBm)	GSM850 : 32.5 GSM1900 : 30.0 WCDMA Band II : 23.0 WCDMA Band V : 24.0 WLAN 2.4G : 16.5 Bluetooth : -1.0
Antenna Type	Fixed Internal Antenna
EUT Stage	Identical Prototype

Note:

- The above EUT information is declared by manufacturer and for more detailed features description please refers to the manufacturer's specifications or User's Manual.

List of Accessory:

Battery	Brand Name	lenovo
	Model Name	BL203
	Power Rating	3.7Vdc, 1500mAh
	Type	Li-ion
Earphone	Brand Name	new leader
	Model Name	NLD-EM127E-055S
	Signal Line Type	1.5 meter non-shielded cable without ferrite core

3. SAR Measurement System

3.1 Definition of Specific Absorption Rate (SAR)

SAR is related to the rate at which energy is absorbed per unit mass in an object exposed to a radio field. The SAR distribution in a biological body is complicated and is usually carried out by experimental techniques or numerical modeling. The standard recommends limits for two tiers of groups, occupational/controlled and general population/uncontrolled, based on a person's awareness and ability to exercise control over his or her exposure. In general, occupational/controlled exposure limits are higher than the limits for general population/uncontrolled.

The SAR definition is the time derivative (rate) of the incremental energy (dW) absorbed by (dissipated in) an incremental mass (dm) contained in a volume element (dv) of a given density (ρ). The equation description is as below:

$$SAR = \frac{d}{dt} \left(\frac{dW}{dm} \right) = \frac{d}{dt} \left(\frac{dW}{\rho dv} \right)$$

SAR is expressed in units of Watts per kilogram (W/kg)

SAR measurement can be related to the electrical field in the tissue by

$$SAR = \frac{\sigma |E|^2}{\rho}$$

Where: σ is the conductivity of the tissue, ρ is the mass density of the tissue and E is the RMS electrical field strength.

3.2 SPEAG DASY System

DASY system consists of high precision robot, probe alignment sensor, phantom, robot controller, controlled measurement server and near-field probe. The robot includes six axes that can move to the precision position of the DASY5 software defined. The DASY software can define the area that is detected by the probe. The robot is connected to controlled box. Controlled measurement server is connected to the controlled robot box. The DAE includes amplifier, signal multiplexing, AD converter, offset measurement and surface detection. It is connected to the Electro-optical coupler (ECO). The ECO performs the conversion from the optical into digital electric signal of the DAE and transfers data to the PC.

FCC SAR Test Report

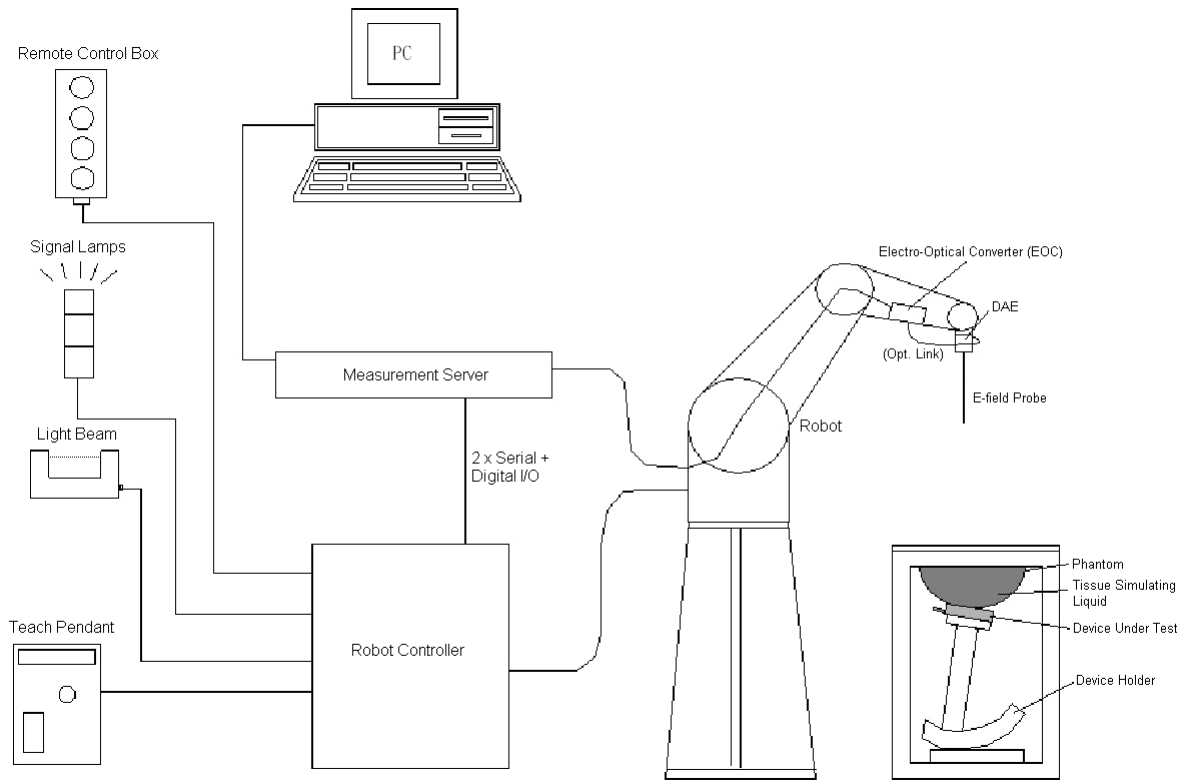

Fig-3.1 DASY System Setup

3.2.1 Robot

The DASY system uses the high precision robots from Stäubli SA (France). For the 6-axis controller system, the robot controller version (DASY5: CS8c) from Stäubli is used. The Stäubli robot series have many features that are important for our application:

- High precision (repeatability ± 0.035 mm)
- High reliability (industrial design)
- Jerk-free straight movements
- Low ELF interference (the closed metallic construction shields against motor control fields)





Fig-3.2 DASY5

FCC SAR Test Report

3.2.2 Probes

The SAR measurement is conducted with the dosimetric probe. The probe is specially designed and calibrated for use in liquid with high permittivity. The dosimetric probe has special calibration in liquid at different frequency.

Model	EX3DV4	
Construction	Symmetrical design with triangular core. Built-in shielding against static charges. PEEK enclosure material (resistant to organic solvents, e.g., DGBE).	
Frequency	10 MHz to 6 GHz Linearity: ± 0.2 dB	
Directivity	± 0.3 dB in HSL (rotation around probe axis) ± 0.5 dB in tissue material (rotation normal to probe axis)	
Dynamic Range	10 μ W/g to 100 mW/g Linearity: ± 0.2 dB (noise: typically < 1 μ W/g)	
Dimensions	Overall length: 337 mm (Tip: 20 mm) Tip diameter: 2.5 mm (Body: 12 mm) Typical distance from probe tip to dipole centers: 1 mm	

Model	ES3DV3	
Construction	Symmetrical design with triangular core. Interleaved sensors. Built-in shielding against static charges. PEEK enclosure material (resistant to organic solvents, e.g., DGBE).	
Frequency	10 MHz to 4 GHz Linearity: ± 0.2 dB	
Directivity	± 0.2 dB in HSL (rotation around probe axis) ± 0.3 dB in tissue material (rotation normal to probe axis)	
Dynamic Range	5 μ W/g to 100 mW/g Linearity: ± 0.2 dB	
Dimensions	Overall length: 337 mm (Tip: 20 mm) Tip diameter: 3.9 mm (Body: 12 mm) Distance from probe tip to dipole centers: 2.0 mm	

3.2.3 Data Acquisition Electronics (DAE)

Model	DAE3, DAE4	
Construction	Signal amplifier, multiplexer, A/D converter and control logic. Serial optical link for communication with DASY5 embedded system (fully remote controlled). Two step probe touch detector for mechanical surface detection and emergency robot stop.	
Measurement Range	-100 to +300 mV (16 bit resolution and two range settings: 4mV, 400mV)	
Input Offset Voltage	< 5 μ V (with auto zero)	
Input Bias Current	< 50 fA	
Dimensions	60 x 60 x 68 mm	

FCC SAR Test Report

3.2.4 Phantoms

Model	Twin SAM	
Construction	The shell corresponds to the specifications of the Specific Anthropomorphic Mannequin (SAM) phantom defined in IEEE 1528 and IEC 62209-1. It enables the dosimetric evaluation of left and right hand phone usage as well as body mounted usage at the flat phantom region. A cover prevents evaporation of the liquid. Reference markings on the phantom allow the complete setup of all predefined phantom positions and measurement grids by teaching three points with the robot.	
Material	Vinylester, glass fiber reinforced (VE-GF)	
Shell Thickness	2 ± 0.2 mm (6 ± 0.2 mm at ear point)	
Dimensions	Length: 1000 mm Width: 500 mm Height: adjustable feet	
Filling Volume	approx. 25 liters	

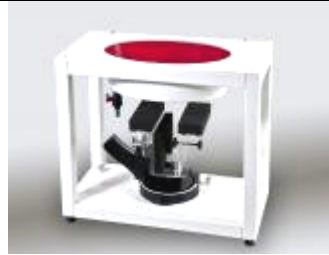
Model	ELI	
Construction	Phantom for compliance testing of handheld and body-mounted wireless devices in the frequency range of 30 MHz to 6 GHz. ELI is fully compatible with the IEC 62209-2 standard and all known tissue simulating liquids. ELI has been optimized regarding its performance and can be integrated into our standard phantom tables. A cover prevents evaporation of the liquid. Reference markings on the phantom allow installation of the complete setup, including all predefined phantom positions and measurement grids, by teaching three points. The phantom is compatible with all SPEAG dosimetric probes and dipoles.	
Material	Vinylester, glass fiber reinforced (VE-GF)	
Shell Thickness	2.0 ± 0.2 mm (bottom plate)	
Dimensions	Major axis: 600 mm Minor axis: 400 mm	
Filling Volume	approx. 30 liters	

3.2.5 Device Holder

Model	Mounting Device	
Construction	In combination with the Twin SAM Phantom or ELI4, the Mounting Device enables the rotation of the mounted transmitter device in spherical coordinates. Rotation point is the ear opening point. Transmitter devices can be easily and accurately positioned according to IEC, IEEE, FCC or other specifications. The device holder can be locked for positioning at different phantom sections (left head, right head, flat).	
Material	POM	

FCC SAR Test Report

3.2.6 System Validation Dipoles

Model	D-Serial	
Construction	Symmetrical dipole with 1/4 balun. Enables measurement of feed point impedance with NWA. Matched for use near flat phantoms filled with tissue simulating solutions.	
Frequency	750 MHz to 5800 MHz	
Return Loss	> 20 dB	
Power Capability	> 100 W (f < 1GHz), > 40 W (f > 1GHz)	

3.2.7 Tissue Simulating Liquids

For SAR measurement of the field distribution inside the phantom, the phantom must be filled with homogeneous tissue simulating liquid to a depth of at least 15 cm. For head SAR testing, the liquid height from the ear reference point (ERP) of the phantom to the liquid top surface is larger than 15 cm. For body SAR testing, the liquid height from the center of the flat phantom to the liquid top surface is larger than 15 cm. The nominal dielectric values of the tissue simulating liquids in the phantom and the tolerance of 5% are listed in Table-3.1.

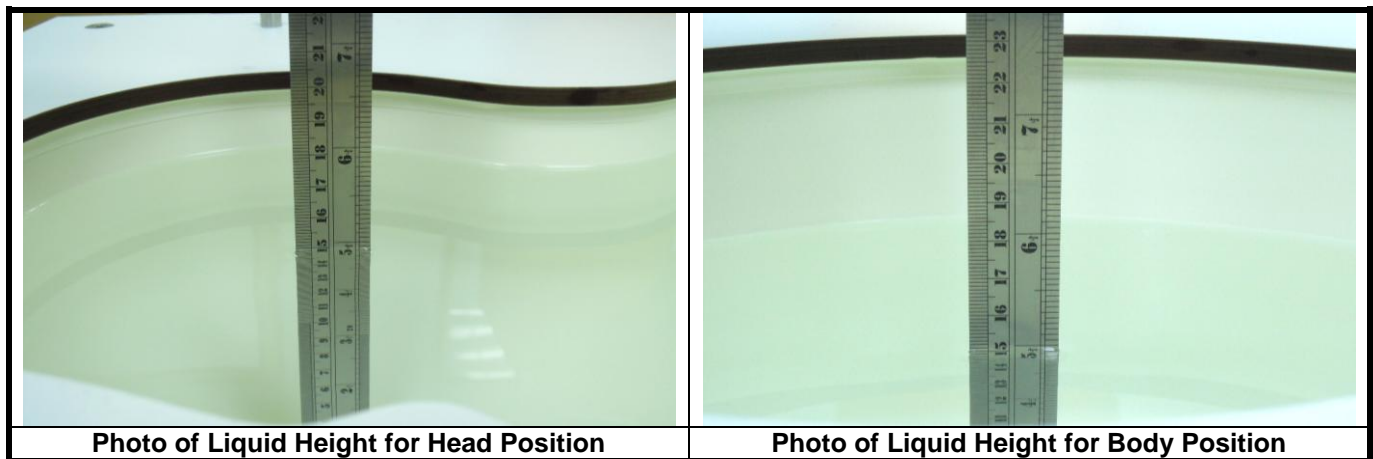

The dielectric properties of the head tissue simulating liquids are defined in IEEE 1528 and FCC OET 65 Supplement C Appendix C. For the body tissue simulating liquids, the dielectric properties are defined in FCC OET 65 Supplement C Appendix C. The dielectric properties of the tissue simulating liquids were verified prior to the SAR evaluation using an SPEAG DAK-3.5 Dielectric Probe Kit and an Agilent Network Analyzer.



FCC SAR Test Report

Table-3.1 Targets of Tissue Simulating Liquid

Frequency (MHz)	Target Permittivity	Range of $\pm 5\%$	Target Conductivity	Range of $\pm 5\%$
For Head				
750	41.9	39.8 ~ 44.0	0.89	0.85 ~ 0.93
835	41.5	39.4 ~ 43.6	0.90	0.86 ~ 0.95
900	41.5	39.4 ~ 43.6	0.97	0.92 ~ 1.02
1450	40.5	38.5 ~ 42.5	1.20	1.14 ~ 1.26
1640	40.3	38.3 ~ 42.3	1.29	1.23 ~ 1.35
1750	40.1	38.1 ~ 42.1	1.37	1.30 ~ 1.44
1800	40.0	38.0 ~ 42.0	1.40	1.33 ~ 1.47
1900	40.0	38.0 ~ 42.0	1.40	1.33 ~ 1.47
2000	40.0	38.0 ~ 42.0	1.40	1.33 ~ 1.47
2300	39.5	37.5 ~ 41.5	1.67	1.59 ~ 1.75
2450	39.2	37.2 ~ 41.2	1.80	1.71 ~ 1.89
2600	39.0	37.1 ~ 41.0	1.96	1.86 ~ 2.06
3500	37.9	36.0 ~ 39.8	2.91	2.76 ~ 3.06
5200	36.0	34.2 ~ 37.8	4.66	4.43 ~ 4.89
5300	35.9	34.1 ~ 37.7	4.76	4.52 ~ 5.00
5500	35.6	33.8 ~ 37.4	4.96	4.71 ~ 5.21
5600	35.5	33.7 ~ 37.3	5.07	4.82 ~ 5.32
5800	35.3	33.5 ~ 37.1	5.27	5.01 ~ 5.53
For Body				
750	55.5	52.7 ~ 58.3	0.96	0.91 ~ 1.01
835	55.2	52.4 ~ 58.0	0.97	0.92 ~ 1.02
900	55.0	52.3 ~ 57.8	1.05	1.00 ~ 1.10
1450	54.0	51.3 ~ 56.7	1.30	1.24 ~ 1.37
1640	53.8	51.1 ~ 56.5	1.40	1.33 ~ 1.47
1750	53.4	50.7 ~ 56.1	1.49	1.42 ~ 1.56
1800	53.3	50.6 ~ 56.0	1.52	1.44 ~ 1.60
1900	53.3	50.6 ~ 56.0	1.52	1.44 ~ 1.60
2000	53.3	50.6 ~ 56.0	1.52	1.44 ~ 1.60
2300	52.9	50.3 ~ 55.5	1.81	1.72 ~ 1.90
2450	52.7	50.1 ~ 55.3	1.95	1.85 ~ 2.05
2600	52.5	49.9 ~ 55.1	2.16	2.05 ~ 2.27
3500	51.3	48.7 ~ 53.9	3.31	3.14 ~ 3.48
5200	49.0	46.6 ~ 51.5	5.30	5.04 ~ 5.57
5300	48.9	46.5 ~ 51.3	5.42	5.15 ~ 5.69
5500	48.6	46.2 ~ 51.0	5.65	5.37 ~ 5.93
5600	48.5	46.1 ~ 50.9	5.77	5.48 ~ 6.06
5800	48.2	45.8 ~ 50.6	6.00	5.70 ~ 6.30



The following table gives the recipes for tissue simulating liquids.

Table-3.2 Recipes of Tissue Simulating Liquid

Tissue Type	Bactericide	DGBE	HEC	NaCl	Sucrose	Triton X-100	Water	Diethylene Glycol Mono-hexylether
H750	0.2	-	0.2	1.5	56.0	-	42.1	-
H835	0.2	-	0.2	1.5	57.0	-	41.1	-
H900	0.2	-	0.2	1.4	58.0	-	40.2	-
H1450	-	43.3	-	0.6	-	-	56.1	-
H1640	-	45.8	-	0.5	-	-	53.7	-
H1750	-	47.0	-	0.4	-	-	52.6	-
H1800	-	44.5	-	0.3	-	-	55.2	-
H1900	-	44.5	-	0.2	-	-	55.3	-
H2000	-	44.5	-	0.1	-	-	55.4	-
H2300	-	44.9	-	0.1	-	-	55.0	-
H2450	-	45.0	-	0.1	-	-	54.9	-
H2600	-	45.1	-	0.1	-	-	54.8	-
H3500	-	8.0	-	0.2	-	20.0	71.8	-
H5G	-	-	-	-	-	17.2	65.5	17.3
B750	0.2	-	0.2	0.8	48.8	-	50.0	-
B835	0.2	-	0.2	0.9	48.5	-	50.2	-
B900	0.2	-	0.2	0.9	48.2	-	50.5	-
B1450	-	34.0	-	0.3	-	-	65.7	-
B1640	-	32.5	-	0.3	-	-	67.2	-
B1750	-	31.0	-	0.2	-	-	68.8	-
B1800	-	29.5	-	0.4	-	-	70.1	-
B1900	-	29.5	-	0.3	-	-	70.2	-
B2000	-	30.0	-	0.2	-	-	69.8	-
B2300	-	31.0	-	0.1	-	-	68.9	-
B2450	-	31.4	-	0.1	-	-	68.5	-
B2600	-	31.8	-	0.1	-	-	68.1	-
B3500	-	28.8	-	0.1	-	-	71.1	-
B5G	-	-	-	-	-	10.7	78.6	10.7

3.3 SAR System Verification

The system check verifies that the system operates within its specifications. It is performed daily or before every SAR measurement. The system check uses normal SAR measurements in the flat section of the phantom with a matched dipole at a specified distance. The system verification setup is shown as below.

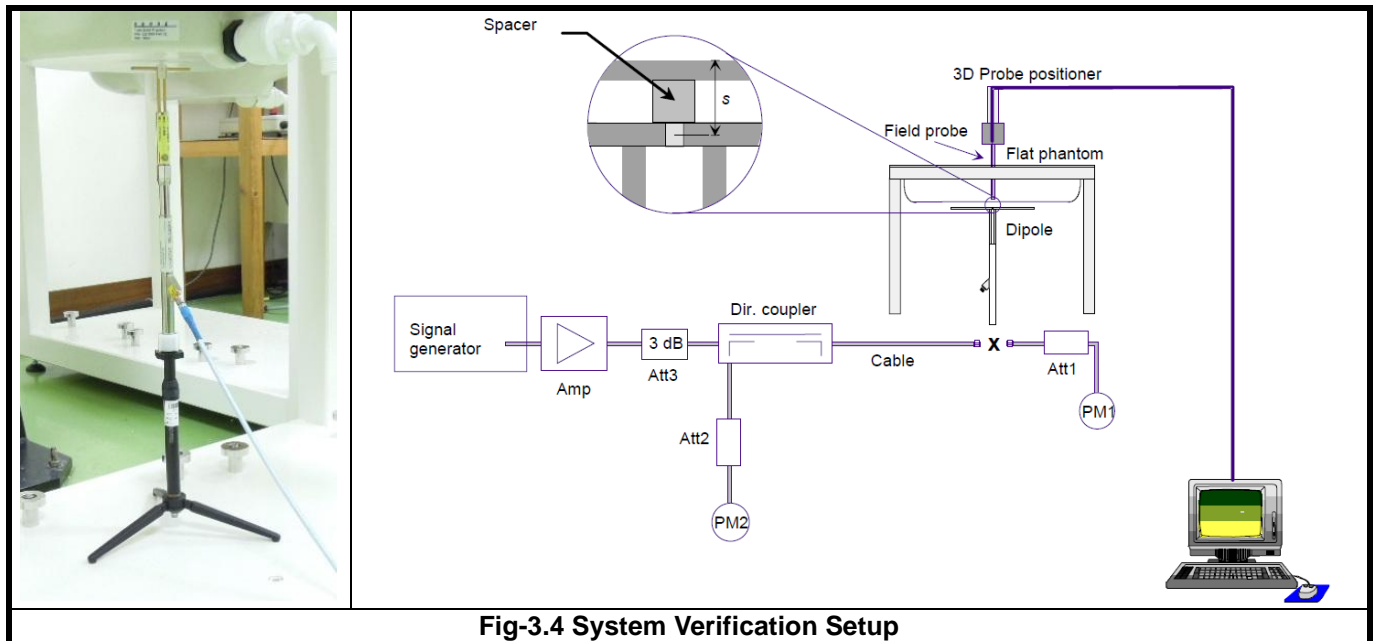

Fig-3.4 System Verification Setup

The validation dipole is placed beneath the flat phantom with the specific spacer in place. The distance spacer is touch the phantom surface with a light pressure at the reference marking and be oriented parallel to the long side of the phantom. The power meter PM1 measures the forward power at the location of the system check dipole connector. The signal generator is adjusted for the desired forward power (250 mW is used for 700 MHz to 3 GHz, 100 mW is used for 3.5 GHz to 6 GHz) at the dipole connector and the power meter PM2 is read at that level. After connecting the cable to the dipole, the signal generator is readjusted for the same reading at power meter PM2.

After system check testing, the SAR result will be normalized to 1W forward input power and compared with the reference SAR value derived from validation dipole certificate report. The deviation of system check should be within 10 %.

3.4 SAR Measurement Procedure

According to the SAR test standard, the recommended procedure for assessing the peak spatial-average SAR value consists of the following steps:

- (a) Power reference measurement
- (b) Area scan
- (c) Zoom scan
- (d) Power drift measurement

The SAR measurement procedures for each of test conditions are as follows:

- (a) Make EUT to transmit maximum output power
- (b) Measure conducted output power through RF cable
- (c) Place the EUT in the specific position of phantom
- (d) Perform SAR testing steps on the DASY system
- (e) Record the SAR value

3.4.1 Area & Zoom Scan Procedure

First Area Scan is used to locate the approximate location(s) of the local peak SAR value(s). The measurement grid within an Area Scan is defined by the grid extent, grid step size and grid offset. Next, in order to determine the EM field distribution in a three-dimensional spatial extension, Zoom Scan is required. The Zoom Scan is performed around the highest E-field value to determine the averaged SAR-distribution over 10 g. According to KDB 865664 D01 v01r01, the resolution for Area and Zoom scan is specified in the table below.

Items	<= 2 GHz	2-3 GHz	3-4 GHz	4-5 GHz	5-6 GHz
Area Scan ($\Delta x, \Delta y$)	<= 15 mm	<= 12 mm	<= 12 mm	<= 10 mm	<= 10 mm
Zoom Scan ($\Delta x, \Delta y$)	<= 8 mm	<= 5 mm	<= 5 mm	<= 4 mm	<= 4 mm
Zoom Scan (Δz)	<= 5 mm	<= 5 mm	<= 4 mm	<= 3 mm	<= 2 mm
Zoom Scan Volume	>= 30 mm	>= 30 mm	>= 28 mm	>= 25 mm	>= 22 mm

Note:

When zoom scan is required and report SAR is <= 1.4 W/kg, the zoom scan resolution of $\Delta x / \Delta y$ (2-3GHz: <= 8 mm, 3-4GHz: <= 7 mm, 4-6GHz: <= 5 mm) may be applied.

3.4.2 Volume Scan Procedure

The volume scan is used for assess overlapping SAR distributions for antennas transmitting in different frequency bands. It is equivalent to an oversized zoom scan used in standalone measurements. The measurement volume will be used to enclose all the simultaneous transmitting antennas. For antennas transmitting simultaneously in different frequency bands, the volume scan is measured separately in each frequency band. In order to sum correctly to compute the 1g aggregate SAR, the EUT remain in the same test position for all measurements and all volume scan use the same spatial resolution and grid spacing. When all volume scan were completed, the software, SEMCAD postprocessor can combine and subsequently superpose these measurement data to calculating the multiband SAR.

FCC SAR Test Report

3.4.3 Power Drift Monitoring

All SAR testing is under the EUT install full charged battery and transmit maximum output power. In DASY measurement software, the power reference measurement and power drift measurement procedures are used for monitoring the power drift of EUT during SAR test. Both these procedures measure the field at a specified reference position before and after the SAR testing. The software will calculate the field difference in dB. If the power drift more than 5%, the SAR will be retested.

3.4.4 Spatial Peak SAR Evaluation

The procedure for spatial peak SAR evaluation has been implemented according to the test standard. It can be conducted for 1g and 10g, as well as for user-specific masses. The DASY software includes all numerical procedures necessary to evaluate the spatial peak SAR value.

The base for the evaluation is a "cube" measurement. The measured volume must include the 1g and 10g cubes with the highest averaged SAR values. For that purpose, the center of the measured volume is aligned to the interpolated peak SAR value of a previously performed area scan.

The entire evaluation of the spatial peak values is performed within the post-processing engine (SEMCAD). The system always gives the maximum values for the 1g and 10g cubes. The algorithm to find the cube with highest averaged SAR is divided into the following stages:

- (a) Extraction of the measured data (grid and values) from the Zoom Scan
- (b) Calculation of the SAR value at every measurement point based on all stored data (A/D values and measurement parameters)
- (c) Generation of a high-resolution mesh within the measured volume
- (d) Interpolation of all measured values from the measurement grid to the high-resolution grid
- (e) Extrapolation of the entire 3-D field distribution to the phantom surface over the distance from sensor to surface
- (f) Calculation of the averaged SAR within masses of 1g and 10g

3.4.5 SAR Averaged Methods

In DASY, the interpolation and extrapolation are both based on the modified Quadratic Shepard's method. The interpolation scheme combines a least-square fitted function method and a weighted average method which are the two basic types of computational interpolation and approximation.

Extrapolation routines are used to obtain SAR values between the lowest measurement points and the inner phantom surface. The extrapolation distance is determined by the surface detection distance and the probe sensor offset. The uncertainty increases with the extrapolation distance. To keep the uncertainty within 1% for the 1 g and 10 g cubes, the extrapolation distance should not be larger than 5 mm.



4. SAR Measurement Evaluation

4.1 EUT Configuration and Setting

For WWAN SAR testing, the EUT was linked and controlled by base station emulator (Agilent E5515C). Communication between the EUT and the emulator was established by air link. The distance between the EUT and the communicating antenna of the emulator is larger than 50 cm and the output power radiated from the emulator antenna is at least 30 dB smaller than the output power of EUT. The EUT was set from the emulator to radiate maximum output power during SAR testing.

For GSM850, the power control level is set to 5. For GPRS850 (GMSK, CS1), the power control level is set to 5. For EDGE850 (8PSK:MCS9), the power control level is set to 8. For GSM1900, the power control level is set to 0. For GPRS1900 (GMSK, CS1), the power control level is set to 0. For EDGE1900 (8PSK:MCS9), the power control level is set to 2.

For WCDMA, head and body SAR is tested under 12.2k RMC mode with power control set all up bits. SAR for AMR is not required since its power is less than 1/4 dB higher than RMC. SAR for HSDPA/HSUPA is not required since its power is less than 1/4 dB higher than RMC without HSDPA/HSUPA and SAR for 12.2 kbps RMC is less than 75% of the SAR limit (1.2 W/kg).

For WLAN SAR testing, the EUT has installed WLAN engineering testing software which can provide continuous transmitting RF signal. According to KDB 248227 D01, WLAN SAR should be tested at the lowest data rate, and testing at higher data rate is not required when the maximum average output power is less than 1/4 dB higher than those measured at the lowest data rate. Since the WLAN power at lowest data rate has highest output power, WLAN SAR for this device was performed at the lowest data rate as set in 1 Mbps for 802.11b. This RF signal utilized in SAR measurement has almost 100% duty cycle, and the duty factor is 1 during WLAN SAR testing.

FCC SAR Test Report

<Antenna Location>

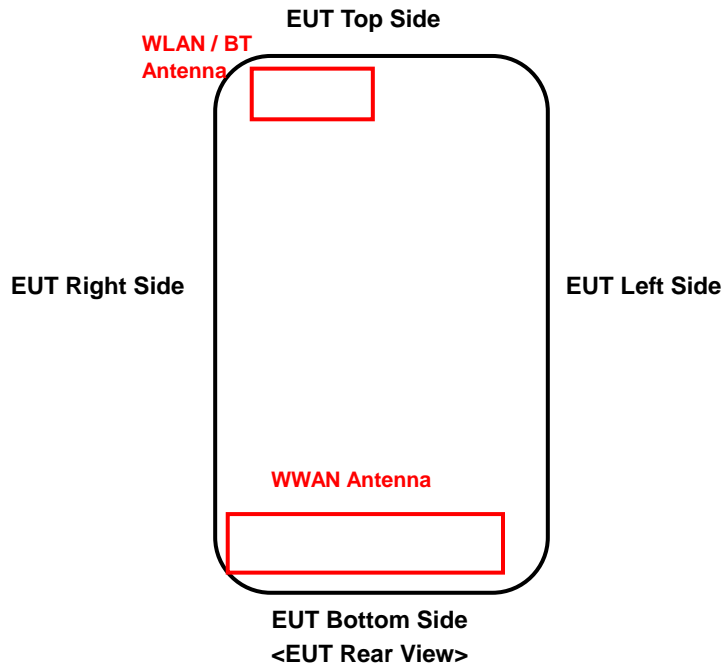

The separation distance for antenna to edge:

Antenna	To Top Side (mm)	To Bottom Side (mm)	To Left Side (mm)	To Right Side (mm)
WWAN	106	5	15	5
WLAN / BT	5	105	39	5

The simultaneous transmission possibilities are listed as below.

Simultaneous TX Combination	Configuration	Head (Voice)	Body Worn (Voice)	Hotspot (Data)
1	GSM850 (Voice / Data) + WLAN (Data)	Yes	Yes	Yes
2	GSM1900 (Voice / Data) + WLAN (Data)	Yes	Yes	Yes
3	WCDMA V (Voice / Data) + WLAN (Data)	Yes	Yes	Yes
4	WCDMA II (Voice / Data) + WLAN (Data)	Yes	Yes	Yes
5	GSM850 (Voice / Data) + BT (Data)	No	Yes	No
6	GSM1900 (Voice / Data) + BT (Data)	No	Yes	No
7	WCDMA V (Voice / Data) + BT (Data)	No	Yes	No
8	WCDMA II (Voice / Data) + BT (Data)	No	Yes	No

4.2 EUT Testing Position

According to KDB 648474 D04, handsets are tested for SAR compliance in head, body-worn accessory and other use configurations described in the following subsections.

4.2.1 Head Exposure Conditions

Head exposure is limited to next to the ear voice mode operations. Head SAR compliance is tested according to the test positions defined in IEEE Std 1528-2003 using the SAM phantom illustrated as below.

1. Define two imaginary lines on the handset
 - (a) The vertical centerline passes through two points on the front side of the handset - the midpoint of the width w_t of the handset at the level of the acoustic output, and the midpoint of the width w_b of the bottom of the handset.
 - (b) The horizontal line is perpendicular to the vertical centerline and passes through the center of the acoustic output. The horizontal line is also tangential to the face of the handset at point A.
 - (c) The two lines intersect at point A. Note that for many handsets, point A coincides with the center of the acoustic output; however, the acoustic output may be located elsewhere on the horizontal line. Also note that the vertical centerline is not necessarily parallel to the front face of the handset, especially for clamshell handsets, handsets with flip covers, and other irregularly shaped handsets.

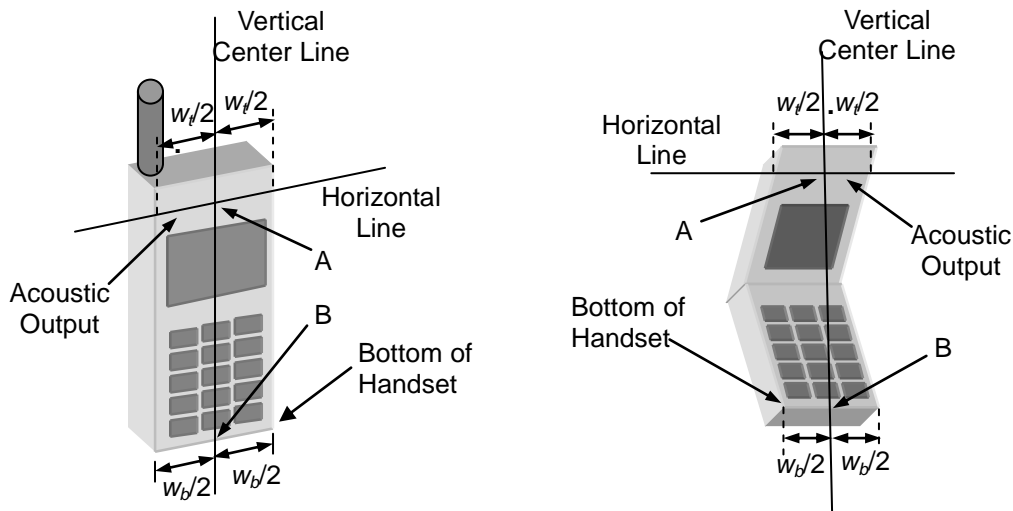

Fig-4.1 Illustration for Handset Vertical and Horizontal Reference Lines

FCC SAR Test Report

2. Cheek Position

- (a) To position the device with the vertical center line of the body of the device and the horizontal line crossing the center piece in a plane parallel to the sagittal plane of the phantom. While maintaining the device in this plane, align the vertical center line with the reference plane containing the three ear and mouth reference point (M: Mouth, RE: Right Ear, and LE: Left Ear) and align the center of the ear piece with the line RE-LE.
- (b) To move the device towards the phantom with the ear piece aligned with the line LE-RE until the phone touched the ear. While maintaining the device in the reference plane and maintaining the phone contact with the ear, move the bottom of the phone until any point on the front side is in contact with the cheek of the phantom or until contact with the ear is lost (see Fig-4.2).

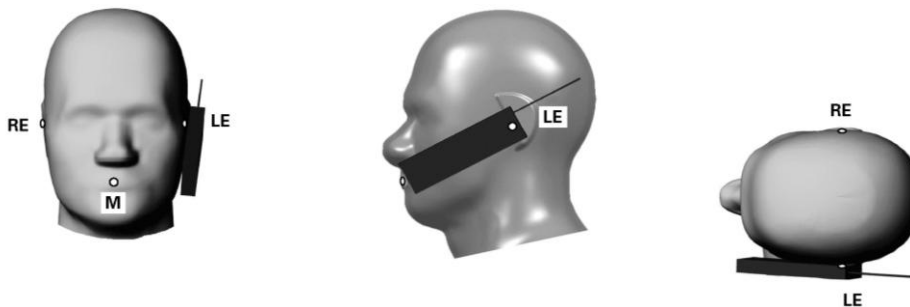

Fig-4.2 Illustration for Cheek Position

3. Tilted Position

- (a) To position the device in the “cheek” position described above.
- (b) While maintaining the device the reference plane described above and pivoting against the ear, moves it outward away from the mouth by an angle of 15 degrees or until contact with the ear is lost (see Fig-4.3).

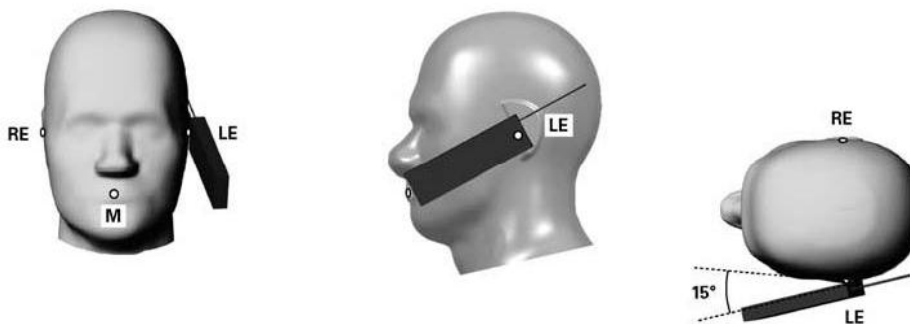

Fig-4.3 Illustration for Tilted Position

4.2.2 Body-Worn Accessory Exposure Conditions

Body-worn accessory exposure is typically related to voice mode operations when handsets are carried in body-worn accessories. The body-worn accessory procedures in KDB 447498 are used to test for body-worn accessory SAR compliance, without a headset connected to it. This enables the test results for such configuration to be compatible with that required for hotspot mode when the body-worn accessory test separation distance is greater than or equal to that required for hotspot mode. When the reported SAR for a body-worn accessory, measured without a headset connected to the handset, is > 1.2 W/kg, the highest reported SAR configuration for that wireless mode and frequency band should be repeated for that body-worn accessory with a headset attached to the handset.

Body-worn accessories that do not contain metallic or conductive components may be tested according to worst-case exposure configurations, typically according to the smallest test separation distance required for the group of body-worn accessories with similar operating and exposure characteristics. All body-worn accessories containing metallic components are tested in conjunction with the host device.

Body-worn accessory SAR compliance is based on a single minimum test separation distance for all wireless and operating modes applicable to each body-worn accessory used by the host, and according to the relevant voice and/or data mode transmissions and operations. If a body-worn accessory supports voice only operations in its normal and expected use conditions, testing of data mode for body-worn compliance is not required.

A conservative minimum test separation distance for supporting off-the-shelf body-worn accessories that may be acquired by users of consumer handsets is used to test for body-worn accessory SAR compliance. This distance is determined by the handset manufacturer, according to the requirements of Supplement C 01-01. Devices that are designed to operate on the body of users using lanyards and straps, or without requiring additional body-worn accessories, will be tested using a conservative minimum test separation distance ≤ 5 mm to support compliance.

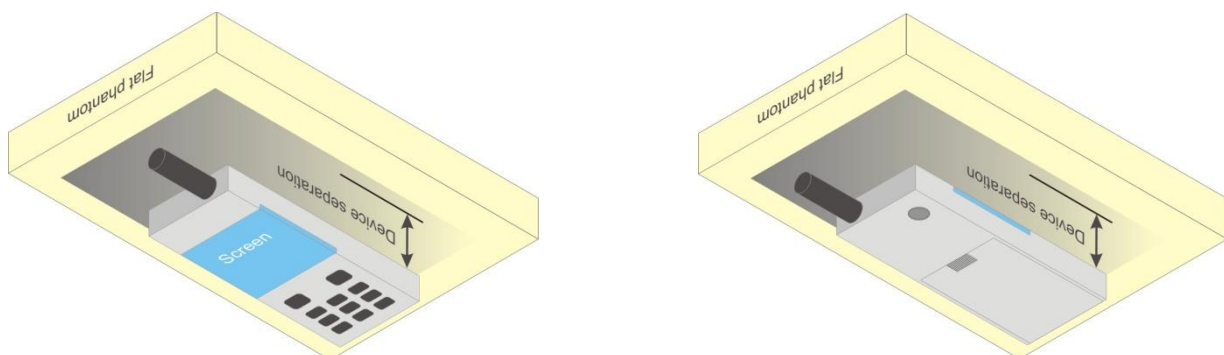
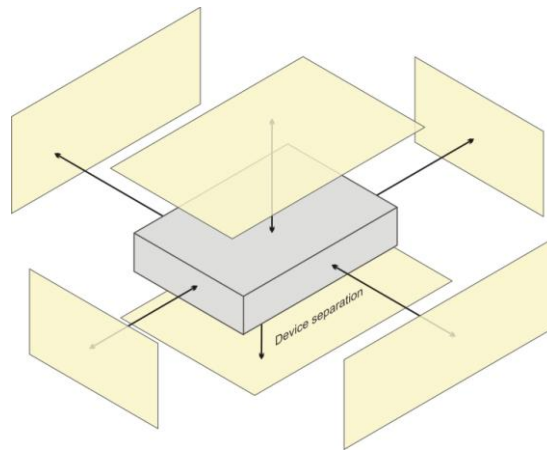

Fig-4.4 Illustration for Body Worn Position

4.2.3 Hotspot Mode Exposure conditions

For handsets that support hotspot mode operations, with wireless router capabilities and various web browsing functions, the relevant hand and body exposure conditions are tested according to the hotspot SAR procedures in KDB 941225 D06. A test separation distance of 10 mm is required between the phantom and all surfaces and edges with a transmitting antenna located within 25 mm from that surface or edge. When the form factor of a handset is smaller than 9 cm x 5 cm, a test separation distance of 5 mm (instead of 10 mm) is required for testing hotspot mode. When the separation distance required for body-worn accessory testing is larger than or equal to that tested for hotspot mode, in the same wireless mode and for the same surface of the phone, the hotspot mode SAR data may be used to support body-worn accessory SAR compliance for that particular configuration (surface).



Based on the antenna location shown on section 4.1 of this report, the SAR testing required for hotspot mode is listed as below.

Antenna	Front Face	Rear Face	Top Side	Bottom Side	Left Side	Right Side
WWAN	√	√		√	√	√
WLAN / BT	√	√	√			√

4.2.4 SAR Test Exclusions

According to KDB 447498 D01, the SAR test exclusion condition is based on source-based time-averaged maximum conducted output power, adjusted for tune-up tolerance, and the minimum test separation distance required for the exposure conditions. The SAR exclusion threshold is determined by the following formula.

$$\frac{\text{Max. Tune up Power}_{(mW)}}{\text{Min. Test Separation Distance}_{(mm)}} \times \sqrt{f_{(GHz)}} \leq 3.0$$

When the minimum test separation distance is < 5 mm, a distance of 5 mm is applied to determine SAR test exclusion.

Mode	Max. Tune-up Power (dBm)	Max. Tune-up Power (mW)	Body-Worn		
			Ant. to Surface (mm)	Calculated Result	Require SAR Testing?
BT	-1.0	1	10	0.2	No

FCC SAR Test Report

4.3 Tissue Verification

The measuring results for tissue simulating liquid are shown as below.

Test Date	Tissue Type	Frequency (MHz)	Liquid Temp. (°C)	Measured Conductivity (σ)	Measured Permittivity (ϵ_r)	Target Conductivity (σ)	Target Permittivity (ϵ_r)	Conductivity Deviation (%)	Permittivity Deviation (%)
Aug. 05, 2013	Head	835	20.5	0.90	43.152	0.90	41.5	0.00	3.98
Aug. 04, 2013	Head	1900	20.5	1.454	40.327	1.40	40.0	3.86	0.82
Aug. 06, 2013	Head	2450	20.5	1.832	38.716	1.80	39.2	1.78	-1.23
Aug. 02, 2013	Body	835	20.5	0.957	56.452	0.97	55.2	-1.34	2.27
Aug. 05, 2013	Body	1900	20.5	1.51	54.116	1.52	53.3	-0.66	1.53
Aug. 06, 2013	Body	2450	20.5	1.902	51.445	1.95	52.7	-2.46	-2.38

Note:

The dielectric properties of the tissue simulating liquid must be measured within 24 hours before the SAR testing and within $\pm 5\%$ of the target values. Liquid temperature during the SAR testing must be within ± 2 °C.

4.4 System Validation

The SAR measurement system was validated according to procedures in KDB 865664 D01 v01r01. The validation status in tabulated summary is as below.

Test Date	Probe S/N	Calibration Point		Measured Conductivity (σ)	Measured Permittivity (ϵ_r)	Validation for CW			Validation for Modulation		
						Sensitivity Range	Probe Linearity	Probe Isotropy	Modulation Type	Duty Factor	PAR
Aug. 05, 2013	3753	Head	835	0.90	43.152	Pass	Pass	Pass	GMSK	Pass	N/A
Aug. 04, 2013	3753	Head	1900	1.454	40.327	Pass	Pass	Pass	GMSK	Pass	N/A
Aug. 06, 2013	3753	Head	2450	1.832	38.716	Pass	Pass	Pass	OFDM	N/A	Pass
Aug. 02, 2013	3753	Body	835	0.957	56.452	Pass	Pass	Pass	GMSK	Pass	N/A
Aug. 05, 2013	3753	Body	1900	1.51	54.116	Pass	Pass	Pass	GMSK	Pass	N/A
Aug. 06, 2013	3753	Body	2450	1.902	51.445	Pass	Pass	Pass	OFDM	N/A	Pass

4.5 System Verification

The measuring result for system verification is tabulated as below.

Test Date	Mode	Frequency (MHz)	1W Target SAR-1g (W/kg)	Measured SAR-1g (W/kg)	Normalized to 1W SAR-1g (W/kg)	Deviation (%)	Dipole S/N	Probe S/N	DAE S/N
Aug. 05, 2013	Head	835	9.35	2.46	9.84	5.24	4d139	3753	915
Aug. 04, 2013	Head	1900	40.60	10.2	40.80	0.49	5d018	3753	915
Aug. 06, 2013	Head	2450	52.60	13.3	53.20	1.14	735	3753	915
Aug. 02, 2013	Body	835	9.50	2.43	9.72	2.32	4d139	3753	915
Aug. 05, 2013	Body	1900	40.40	10.2	40.80	0.99	5d018	3753	915
Aug. 06, 2013	Body	2450	51.90	12.7	50.80	-2.12	735	3753	915

Note:

Comparing to the reference SAR value provided by SPEAG, the validation data should be within its specification of 10 %. The result indicates the system check can meet the variation criterion and the plots can be referred to Appendix A of this report.



FCC SAR Test Report

4.6 Maximum Output Power

4.6.1 Maximum Conducted Power

The maximum conducted power (Unit: dBm) including tune-up tolerance is shown as below.

Mode	GSM850	GSM1900
GSM (GMSK, 1 Uplink)	32.5	30.0
GPRS 8 (GMSK, 1 Uplink)	32.5	30.0
GPRS 10 (GMSK, 2 Uplink)	30.5	29.0
GPRS 11 (GMSK, 3 Uplink)	29.0	28.0
GPRS 12 (GMSK, 4 Uplink)	28.0	27.0
EDGE 8 (8PSK, 1 Uplink)	26.0	24.0
EDGE 10 (8PSK, 2 Uplink)	23.5	23.0
EDGE 11 (8PSK, 3 Uplink)	21.5	21.0
EDGE 12 (8PSK, 4 Uplink)	20.0	20.0

Mode	WCDMA Band II	WCDMA Band V
RMC 12.2K	23.0	24.0
HSDPA	22.0	23.0
HSUPA	22.0	23.0

Mode	2.4G WLAN
802.11b	16.5
802.11g	14.0
802.11n HT20	15.5

Mode	Bluetooth
All	-1.0



FCC SAR Test Report

4.6.2 Measured Conducted Power Result

The measuring conducted power (Unit: dBm) is shown as below.

Band Channel	GSM850			GSM1900		
	128	189	251	512	661	810
Frequency (MHz)	824.2	836.4	848.8	1850.2	1880.0	1909.8
Maximum Burst-Averaged Output Power						
GSM	31.32	31.28	31.43	28.35	28.98	28.92
GPRS 8	31.32	31.37	31.41	28.34	28.96	28.93
GPRS 10	29.98	29.99	30.10	27.69	28.33	28.30
GPRS 11	28.33	28.32	28.40	26.30	26.98	26.91
GPRS 12	27.25	27.27	27.48	25.53	26.22	26.16
EDGE 8 (MCS1)	31.31	31.39	31.43	28.33	28.96	28.94
EDGE 10 ((MCS1)	29.97	30.00	30.08	27.69	28.35	28.30
EDGE 11 ((MCS1)	28.34	28.38	28.47	26.35	27.00	26.95
EDGE 12 ((MCS1)	27.31	27.37	27.43	25.56	26.20	26.18
EDGE 8 (MCS9)	25.38	25.31	25.06	22.72	22.80	23.46
EDGE 10 ((MCS9)	22.80	22.75	22.58	21.53	21.67	22.20
EDGE 11 ((MCS9)	20.63	20.55	20.39	19.47	19.50	20.10
EDGE 12 ((MCS9)	19.43	19.39	19.15	18.32	18.43	18.99
Maximum Frame-Averaged Output Power						
GSM	22.32	22.28	22.43	19.35	19.98	19.92
GPRS 8	22.32	22.37	22.41	19.34	19.96	19.93
GPRS 10	23.98	23.99	24.10	21.69	22.33	22.30
GPRS 11	24.07	24.06	24.14	22.04	22.72	22.65
GPRS 12	24.25	24.27	24.48	22.53	23.22	23.16
EDGE 8 (MCS1)	22.31	22.39	22.43	19.33	19.96	19.94
EDGE 10 ((MCS1)	23.97	24.00	24.08	21.69	22.35	22.30
EDGE 11 ((MCS1)	24.08	24.12	24.21	22.09	22.74	22.69
EDGE 12 ((MCS1)	24.31	24.37	24.43	22.56	23.20	23.18
EDGE 8 (MCS9)	16.38	16.31	16.06	13.72	13.80	14.46
EDGE 10 ((MCS9)	16.80	16.75	16.58	15.53	15.67	16.20
EDGE 11 ((MCS9)	16.37	16.29	16.13	15.21	15.24	15.84
EDGE 12 ((MCS9)	16.43	16.39	16.15	15.32	15.43	15.99

Note:

- SAR testing was performed on the maximum frame-averaged power mode.
- The frame-averaged power is linearly proportion to the slot number configured and it is linearly scaled the maximum burst-averaged power based on time slots. The calculated method is shown as below:

$$\text{Frame-averaged power} = 10 \times \log (\text{Burst-averaged power mW} \times \text{Slot used} / 8)$$

Band Channel	WCDMA Band II			WCDMA Band V			3PGG MPR (dB)
	9262	9400	9538	4132	4182	4233	
Frequency (MHz)	1852.4	1880.0	1907.6	826.4	836.4	846.6	
RMC 12.2K	22.16	22.43	22.15	23.32	23.28	23.49	-
HSDPA Subtest-1	21.22	21.46	21.22	22.34	22.34	22.53	0
HSDPA Subtest-2	21.21	21.45	21.21	22.35	22.33	22.54	0
HSDPA Subtest-3	20.74	20.98	20.74	21.90	21.81	22.05	0.5
HSDPA Subtest-4	20.71	20.96	20.74	21.86	21.84	22.04	0.5
HSUPA Subtest-1	19.23	19.51	19.25	20.37	20.33	20.53	0
HSUPA Subtest-2	19.22	19.48	19.24	20.37	20.32	20.52	2
HSUPA Subtest-3	20.20	20.49	20.24	21.38	21.34	21.54	1
HSUPA Subtest-4	19.72	19.98	19.74	20.88	20.84	21.04	2
HSUPA Subtest-5	21.21	21.44	21.19	22.34	22.28	22.51	0

Mode	802.11b		
Channel / Frequency (MHz)	1 (2412)	6 (2437)	11 (2462)
Average Power	16.48	15.92	15.15
Mode	802.11g		
Channel / Frequency (MHz)	1 (2412)	6 (2437)	11 (2462)
Average Power	13.30	13.95	13.18
Mode	802.11n (HT20)		
Channel / Frequency (MHz)	1 (2412)	6 (2437)	11 (2462)
Average Power	15.19	14.85	14.28

4.7 SAR Testing Results

4.7.1 SAR Results for Head

Plot No.	Band	Mode	Test Position	Ch.	Max. Tune-up Power (dBm)	Measured Conducted Power (dBm)	Scaling Factor	Power Drift (dB)	Measured SAR-1g (W/kg)	Scaled SAR-1g (W/kg)
01	GSM850	GSM	Right Cheek	251	32.5	31.43	1.28	0.02	0.541	0.69
	GSM850	GSM	Right Tilted	251	32.5	31.43	1.28	0.06	0.346	0.44
	GSM850	GSM	Left Cheek	251	32.5	31.43	1.28	0.10	0.546	0.70
	GSM850	GSM	Left Tilted	251	32.5	31.43	1.28	-0.05	0.34	0.43
02	GSM1900	GSM	Right Cheek	661	30.0	28.98	1.26	0.18	0.562	0.71
	GSM1900	GSM	Right Tilted	661	30.0	28.98	1.26	-0.06	0.172	0.22
	GSM1900	GSM	Left Cheek	661	30.0	28.98	1.26	0.04	0.386	0.49
	GSM1900	GSM	Left Tilted	661	30.0	28.98	1.26	-0.02	0.171	0.22
03	WCDMA II	RMC12.2K	Right Cheek	9400	23.0	22.43	1.14	0.00	0.904	1.03
	WCDMA II	RMC12.2K	Right Tilted	9400	23.0	22.43	1.14	-0.19	0.256	0.29
	WCDMA II	RMC12.2K	Left Cheek	9400	23.0	22.43	1.14	-0.14	0.665	0.76
	WCDMA II	RMC12.2K	Left Tilted	9400	23.0	22.43	1.14	-0.02	0.298	0.34
	WCDMA II	RMC12.2K	Right Cheek	9262	23.0	22.16	1.21	0.19	0.953	1.16
	WCDMA II	RMC12.2K	Right Cheek	9538	23.0	22.15	1.22	0.14	0.828	1.01
04	WCDMA II	RMC12.2K	Right Cheek	9262	23.0	22.16	1.21	-0.03	0.955	1.16
	WCDMA V	RMC12.2K	Right Cheek	4233	24.0	23.49	1.12	0.10	0.649	0.73
	WCDMA V	RMC12.2K	Right Tilted	4233	24.0	23.49	1.12	0.07	0.407	0.46
	WCDMA V	RMC12.2K	Left Cheek	4233	24.0	23.49	1.12	0.11	0.703	0.79
05	WCDMA V	RMC12.2K	Left Tilted	4233	24.0	23.49	1.12	0.03	0.385	0.43
	802.11b	-	Right Cheek	1	16.5	16.48	1.00	-0.10	0.255	0.26
	802.11b	-	Right Tilted	1	16.5	16.48	1.00	-0.04	0.326	0.33
	802.11b	-	Left Cheek	1	16.5	16.48	1.00	-0.08	0.406	0.41
	802.11b	-	Left Tilted	1	16.5	16.48	1.00	0.08	0.26	0.26

Note:

- SAR is performed on the highest power channel. When the reported SAR value of highest power channel is <= 0.8 W/kg, SAR testing for optional channel is not required.
- According to KDB 248227, when the extrapolated maximum peak SAR for the maximum output power channel is <= 1.6 W/kg and the 1g averaged SAR is <= 0.8 W/kg, WLAN SAR testing for other channels is not required.
- SAR testing for 802.11g/n is not required when its maximum power is less than 1/4 dB higher than 802.11b.



FCC SAR Test Report

4.7.2 SAR Results for Body-Worn (Separation Distance is 1.0 cm Gap)

Plot No.	Band	Mode	Test Position	Ch.	Max. Tune-up Power (dBm)	Measured Conducted Power (dBm)	Scaling Factor	Power Drift (dB)	Measured SAR-1g (W/kg)	Scaled SAR-1g (W/kg)
	GSM850	GPRS12	Front Face	251	28.0	27.48	1.13	-0.04	0.818	0.92
	GSM850	GPRS12	Rear Face	251	28.0	27.48	1.13	-0.05	0.923	1.04
	GSM850	GPRS12	Front Face	128	28.0	27.25	1.19	0.03	0.939	1.12
	GSM850	GPRS12	Front Face	189	28.0	27.27	1.18	0.06	0.957	1.13
06	GSM850	GPRS12	Rear Face	128	28.0	27.25	1.19	0.01	1.09	1.30
	GSM850	GPRS12	Rear Face	189	28.0	27.27	1.18	0.03	1.02	1.21
	GSM850	GPRS12	Rear Face	128	28.0	27.25	1.19	-0.04	1.08	1.28
	GSM850	GPRS12 (w/ Earphone)	Rear Face	128	28.0	27.25	1.19	0.08	0.802	0.95
	GSM1900	GPRS12	Front Face	661	27.0	26.22	1.20	0.03	0.772	0.92
	GSM1900	GPRS12	Rear Face	661	27.0	26.22	1.20	0.11	0.753	0.90
07	GSM1900	GPRS12	Front Face	512	27.0	25.53	1.40	-0.03	0.739	1.04
	GSM1900	GPRS12	Front Face	810	27.0	26.16	1.21	0.18	0.727	0.88
	GSM1900	GPRS12	Rear Face	512	27.0	25.53	1.40	0.01	0.609	0.85
	GSM1900	GPRS12	Rear Face	810	27.0	26.16	1.21	0.01	0.76	0.92
08	WCDMA II	RMC12.2K	Front Face	9400	23.0	22.43	1.14	0.08	0.644	0.73
	WCDMA II	RMC12.2K	Rear Face	9400	23.0	22.43	1.14	-0.01	0.614	0.70
	WCDMA V	RMC12.2K	Front Face	4233	24.0	23.49	1.12	-0.01	0.737	0.83
	WCDMA V	RMC12.2K	Rear Face	4233	24.0	23.49	1.12	0.01	0.885	1.00
	WCDMA V	RMC12.2K	Front Face	4132	24.0	23.32	1.17	-0.01	0.764	0.89
	WCDMA V	RMC12.2K	Front Face	4182	24.0	23.28	1.18	0.01	0.765	0.90
	WCDMA V	RMC12.2K	Rear Face	4132	24.0	23.32	1.17	0.01	0.933	1.09
	WCDMA V	RMC12.2K	Rear Face	4182	24.0	23.28	1.18	0.00	0.925	1.09
09	WCDMA V	RMC12.2K	Rear Face	4132	24.0	23.32	1.17	-0.01	0.957	1.12
	802.11b	-	Front Face	1	16.5	16.48	1.00	0.02	0.074	0.07
10	802.11b	-	Rear Face	1	16.5	16.48	1.00	-0.10	0.11	0.11

Note:

- SAR is performed on the highest power channel. When the reported SAR value of highest power channel is ≤ 0.8 W/kg, SAR testing for optional channel is not required.
- According to KDB 248227, when the extrapolated maximum peak SAR for the maximum output power channel is ≤ 1.6 W/kg and the 1g averaged SAR is ≤ 0.8 W/kg, WLAN SAR testing for other channels is not required.
- SAR testing for 802.11g/n is not required when its maximum power is less than 1/4 dB higher than 802.11b.



FCC SAR Test Report

4.7.3 SAR Results for Hotspot (Separation Distance is 1.0 cm Gap)

Plot No.	Band	Mode	Test Position	Ch.	Max. Tune-up Power (dBm)	Measured Conducted Power (dBm)	Scaling Factor	Power Drift (dB)	Measured SAR-1g (W/kg)	Scaled SAR-1g (W/kg)
	GSM850	GPRS12	Front Face	251	28.0	27.48	1.13	-0.04	0.818	0.92
	GSM850	GPRS12	Rear Face	251	28.0	27.48	1.13	-0.05	0.923	1.04
	GSM850	GPRS12	Left Side	251	28.0	27.48	1.13	-0.01	0.575	0.65
	GSM850	GPRS12	Right Side	251	28.0	27.48	1.13	0.01	0.608	0.69
	GSM850	GPRS12	Bottom Side	251	28.0	27.48	1.13	-0.06	0.083	0.09
	GSM850	GPRS12	Front Face	128	28.0	27.25	1.19	0.03	0.939	1.12
	GSM850	GPRS12	Front Face	189	28.0	27.27	1.18	0.06	0.957	1.13
06	GSM850	GPRS12	Rear Face	128	28.0	27.25	1.19	0.01	1.09	1.30
	GSM850	GPRS12	Rear Face	189	28.0	27.27	1.18	0.03	1.02	1.21
	GSM850	GPRS12	Rear Face	128	28.0	27.25	1.19	-0.04	1.08	1.28
	GSM1900	GPRS12	Front Face	661	27.0	26.22	1.20	0.03	0.772	0.92
	GSM1900	GPRS12	Rear Face	661	27.0	26.22	1.20	0.11	0.753	0.90
	GSM1900	GPRS12	Left Side	661	27.0	26.22	1.20	-0.04	0.149	0.18
	GSM1900	GPRS12	Right Side	661	27.0	26.22	1.20	0.01	0.272	0.33
	GSM1900	GPRS12	Bottom Side	661	27.0	26.22	1.20	0.11	0.867	1.04
	GSM1900	GPRS12	Front Face	512	27.0	25.53	1.40	-0.03	0.739	1.04
	GSM1900	GPRS12	Front Face	810	27.0	26.16	1.21	0.18	0.727	0.88
	GSM1900	GPRS12	Rear Face	512	27.0	25.53	1.40	0.01	0.609	0.85
	GSM1900	GPRS12	Rear Face	810	27.0	26.16	1.21	0.01	0.76	0.92
	GSM1900	GPRS12	Bottom Side	512	27.0	25.53	1.40	0.02	0.742	1.04
	GSM1900	GPRS12	Bottom Side	810	27.0	26.16	1.21	-0.03	0.842	1.02
11	GSM1900	GPRS12	Bottom Side	661	27.0	26.22	1.20	0.14	0.888	1.06
	WCDMA II	RMC12.2K	Front Face	9400	23.0	22.43	1.14	0.08	0.644	0.73
	WCDMA II	RMC12.2K	Rear Face	9400	23.0	22.43	1.14	-0.01	0.614	0.70
	WCDMA II	RMC12.2K	Left Side	9400	23.0	22.43	1.14	-0.03	0.132	0.15
	WCDMA II	RMC12.2K	Right Side	9400	23.0	22.43	1.14	0.09	0.243	0.28
	WCDMA II	RMC12.2K	Bottom Side	9400	23.0	22.43	1.14	0.00	0.749	0.85
	WCDMA II	RMC12.2K	Bottom Side	9262	23.0	22.16	1.21	0.02	0.704	0.85
12	WCDMA II	RMC12.2K	Bottom Side	9538	23.0	22.15	1.22	0.02	0.758	0.92
	WCDMA V	RMC12.2K	Front Face	4233	24.0	23.49	1.12	-0.01	0.737	0.83
	WCDMA V	RMC12.2K	Rear Face	4233	24.0	23.49	1.12	0.01	0.885	1.00
	WCDMA V	RMC12.2K	Left Side	4233	24.0	23.49	1.12	-0.03	0.534	0.60
	WCDMA V	RMC12.2K	Right Side	4233	24.0	23.49	1.12	-0.02	0.568	0.64
	WCDMA V	RMC12.2K	Bottom Side	4233	24.0	23.49	1.12	-0.01	0.064	0.07
	WCDMA V	RMC12.2K	Front Face	4132	24.0	23.32	1.17	-0.01	0.764	0.89
	WCDMA V	RMC12.2K	Front Face	4182	24.0	23.28	1.18	0.01	0.765	0.90
	WCDMA V	RMC12.2K	Rear Face	4132	24.0	23.32	1.17	0.01	0.933	1.09
	WCDMA V	RMC12.2K	Rear Face	4182	24.0	23.28	1.18	0.00	0.925	1.09
09	WCDMA V	RMC12.2K	Rear Face	4132	24.0	23.32	1.17	-0.01	0.957	1.12
	802.11b	-	Front Face	1	16.5	16.48	1.00	0.02	0.074	0.07
10	802.11b	-	Rear Face	1	16.5	16.48	1.00	-0.10	0.11	0.11
	802.11b	-	Right Side	1	16.5	16.48	1.00	0.05	0.072	0.07
	802.11b	-	Top Side	1	16.5	16.48	1.00	0.15	0.088	0.09

Note:

- SAR is performed on the highest power channel. When the reported SAR value of highest power channel is <= 0.8 W/kg, SAR testing for optional channel is not required.
- According to KDB 248227, when the extrapolated maximum peak SAR for the maximum output power channel is <= 1.6 W/kg and the 1g averaged SAR is <= 0.8 W/kg, WLAN SAR testing for other channels is not required.
- SAR testing for 802.11g/n is not required when its maximum power is less than 1/4 dB higher than 802.11b.

FCC SAR Test Report

4.7.4 SAR Measurement Variability

According to KDB 865664 D01 v01r01, SAR measurement variability was assessed for each frequency band, which is determined by the SAR probe calibration point and tissue-equivalent medium used for the device measurements. When both head and body tissue-equivalent media are required for SAR measurements in a frequency band, the variability measurement procedures should be applied to the tissue medium with the highest measured SAR, using the highest measured SAR configuration for that tissue-equivalent medium. Alternatively, if the highest measured SAR for both head and body tissue-equivalent media are ≤ 1.45 W/kg and the ratio of these highest SAR values, i.e., largest divided by smallest value, is ≤ 1.10 , the highest SAR configuration for either head or body tissue-equivalent medium may be used to perform the repeated measurement. These additional measurements are repeated after the completion of all measurements requiring the same head or body tissue-equivalent medium in a frequency band. The test device should be returned to ambient conditions (normal room temperature) with the battery fully charged before it is re-mounted on the device holder for the repeated measurement(s) to minimize any unexpected variations in the repeated results.

SAR repeated measurement procedure:

1. When the highest measured SAR is < 0.80 W/kg, repeated measurement is not required.
2. When the highest measured SAR is ≥ 0.80 W/kg, repeat that measurement once.
3. If the ratio of largest to smallest SAR for the original and first repeated measurements is > 1.20 , or when the original or repeated measurement is ≥ 1.45 W/kg, perform a second repeated measurement.
4. If the ratio of largest to smallest SAR for the original, first and second repeated measurements is > 1.20 , and the original, first or second repeated measurement is ≥ 1.5 W/kg, perform a third repeated measurement.

Band	Mode	Test Position	Ch.	Original Measured SAR-1g (W/kg)	1st Repeated SAR-1g (W/kg)	L/S Ratio	2nd Repeated SAR-1g (W/kg)	L/S Ratio	3rd Repeated SAR-1g (W/kg)	L/S Ratio
WCDMA II	RMC12.2K	Right Cheek	9262	0.953	0.955	1.00	N/A	N/A	N/A	N/A
GSM850	GPRS12	Rear Face	128	1.09	1.08	1.01	N/A	N/A	N/A	N/A
GSM1900	GPRS12	Bottom side	661	0.867	0.888	1.02	N/A	N/A	N/A	N/A
WCDMA V	RMC12.2K	Rear Face	4132	0.933	0.957	1.03	N/A	N/A	N/A	N/A

FCC SAR Test Report

4.7.5 Simultaneous Multi-band Transmission Evaluation

<Estimated SAR Calculation>

According to KDB 447498 D01, when standalone SAR test exclusion applies to an antenna that transmits simultaneously with other antennas, the standalone SAR was estimated according to following formula to result in substantially conservative SAR values of ≤ 0.4 W/kg to determine simultaneous transmission SAR test exclusion.

$$\text{Estimated SAR} = \frac{\text{Max. Tune up Power}_{(\text{mW})}}{\text{Min. Test Separation Distance}_{(\text{mm})}} \times \frac{\sqrt{f_{(\text{GHz})}}}{7.5}$$

If the minimum test separation distance is < 5 mm, a distance of 5 mm is used for estimated SAR calculation. When the test separation distance is > 50 mm, the 0.4 W/kg is used for SAR-1g.

Mode / Band	Frequency (GHz)	Max. Tune-up Power (dBm)	Test Position	Separation Distance (mm)	Estimated SAR (W/kg)
BT (DSS)	2.48	-1.0	Body-worn	10	0.02

Note:

1. The separation distance is determined from the outer housing of the EUT to the user.
2. When standalone SAR testing is not required, an estimated SAR can be applied to determine simultaneous transmission SAR test exclusion.

FCC SAR Test Report

<SAR Summation Analysis>

Simultaneous transmission SAR test exclusion is determined for each operating configuration and exposure condition according to the reported standalone SAR of each applicable simultaneous transmitting antenna. When the sum of SAR_{1g} of all simultaneously transmitting antennas in an operating mode and exposure condition combination is within the SAR limit (SAR_{1g} 1.6 W/kg), the simultaneous transmission SAR is not required. When the sum of SAR_{1g} is greater than the SAR limit (SAR_{1g} 1.6 W/kg), SAR test exclusion is determined by the SPLSR.

No.	Conditions (SAR1 + SAR2)	Exposure Condition	Test Position	Max. SAR1	Max. SAR2	SAR Summation	SPLSR Analysis
1	GSM850 + WLAN (DTS)	Head	Right Cheek	0.69	0.26	0.95	Σ SAR < 1.6, Not required
			Right Tilted	0.44	0.33	0.77	Σ SAR < 1.6, Not required
			Left Cheek	0.70	0.41	1.11	Σ SAR < 1.6, Not required
			Left Tilted	0.43	0.26	0.69	Σ SAR < 1.6, Not required
		Body-Worn	Front Face	1.13	0.07	1.20	Σ SAR < 1.6, Not required
			Rear Face	1.30	0.11	1.41	Σ SAR < 1.6, Not required
		Hotspot	Front Face	1.13	0.07	1.20	Σ SAR < 1.6, Not required
			Rear Face	1.30	0.11	1.41	Σ SAR < 1.6, Not required
			Left Side	0.65	-	0.65	Σ SAR < 1.6, Not required
			Right Side	0.69	0.07	0.76	Σ SAR < 1.6, Not required
			Top Side	-	0.09	0.09	Σ SAR < 1.6, Not required
			Bottom Side	0.09	-	0.09	Σ SAR < 1.6, Not required
2	GSM850 + BT (DSS)	Body-Worn	Front Face	1.13	0.02	1.15	Σ SAR < 1.6, Not required
			Rear Face	1.30	0.02	1.32	Σ SAR < 1.6, Not required



FCC SAR Test Report

A D T

No.	Conditions (SAR1 + SAR2)	Exposure Condition	Test Position	Max. SAR1	Max. SAR2	SAR Summation	SPLSR Analysis
3	GSM1900 + WLAN (DTS)	Head	Right Cheek	0.71	0.26	0.97	Σ SAR < 1.6, Not required
			Right Tilted	0.22	0.33	0.55	Σ SAR < 1.6, Not required
			Left Cheek	0.49	0.41	0.90	Σ SAR < 1.6, Not required
			Left Tilted	0.22	0.26	0.48	Σ SAR < 1.6, Not required
		Body-Worn	Front Face	1.04	0.07	1.11	Σ SAR < 1.6, Not required
			Rear Face	0.92	0.11	1.03	Σ SAR < 1.6, Not required
		Hotspot	Front Face	1.04	0.07	1.11	Σ SAR < 1.6, Not required
			Rear Face	0.92	0.11	1.03	Σ SAR < 1.6, Not required
			Left Side	0.18	-	0.18	Σ SAR < 1.6, Not required
			Right Side	0.33	0.07	0.40	Σ SAR < 1.6, Not required
			Top Side	-	0.09	0.09	Σ SAR < 1.6, Not required
		Bottom Side	1.06	-	1.06	Σ SAR < 1.6, Not required	
4	GSM1900 + BT (DSS)	Body-Worn	Front Face	1.04	0.02	1.06	Σ SAR < 1.6, Not required
			Rear Face	0.92	0.02	0.94	Σ SAR < 1.6, Not required

No.	Conditions (SAR1 + SAR2)	Exposure Condition	Test Position	Max. SAR1	Max. SAR2	SAR Summation	SPLSR Analysis
5	WCDMA II + WLAN (DTS)	Head	Right Cheek	1.16	0.26	1.42	Σ SAR < 1.6, Not required
			Right Tilted	0.29	0.33	0.62	Σ SAR < 1.6, Not required
			Left Cheek	0.76	0.41	1.17	Σ SAR < 1.6, Not required
			Left Tilted	0.34	0.26	0.60	Σ SAR < 1.6, Not required
		Body-Worn	Front Face	0.73	0.07	0.80	Σ SAR < 1.6, Not required
			Rear Face	0.70	0.11	0.81	Σ SAR < 1.6, Not required
		Hotspot	Front Face	0.73	0.07	0.80	Σ SAR < 1.6, Not required
			Rear Face	0.70	0.11	0.81	Σ SAR < 1.6, Not required
			Left Side	0.15	-	0.15	Σ SAR < 1.6, Not required
			Right Side	0.28	0.07	0.35	Σ SAR < 1.6, Not required
			Top Side	-	0.09	0.09	Σ SAR < 1.6, Not required
		Bottom Side	0.92	-	0.92	Σ SAR < 1.6, Not required	
6	WCDMA II + BT (DSS)	Body-Worn	Front Face	0.73	0.02	0.75	Σ SAR < 1.6, Not required
			Rear Face	0.70	0.02	0.72	Σ SAR < 1.6, Not required



FCC SAR Test Report

A D T

No.	Conditions (SAR1 + SAR2)	Exposure Condition	Test Position	Max. SAR1	Max. SAR2	SAR Summation	SPLSR Analysis
7	WCDMA V + WLAN (DTS)	Head	Right Cheek	0.73	0.26	0.99	Σ SAR < 1.6, Not required
			Right Tilted	0.46	0.33	0.79	Σ SAR < 1.6, Not required
			Left Cheek	0.79	0.41	1.20	Σ SAR < 1.6, Not required
			Left Tilted	0.43	0.26	0.69	Σ SAR < 1.6, Not required
		Body-Worn	Front Face	0.90	0.07	0.97	Σ SAR < 1.6, Not required
			Rear Face	1.12	0.11	1.23	Σ SAR < 1.6, Not required
		Hotspot	Front Face	0.90	0.07	0.97	Σ SAR < 1.6, Not required
			Rear Face	1.12	0.11	1.23	Σ SAR < 1.6, Not required
			Left Side	0.60	-	0.60	Σ SAR < 1.6, Not required
			Right Side	0.64	0.07	0.71	Σ SAR < 1.6, Not required
			Top Side	-	0.09	0.09	Σ SAR < 1.6, Not required
		Bottom Side	0.07	-	0.07	Σ SAR < 1.6, Not required	
8	WCDMA V + BT (DSS)	Body-Worn	Front Face	0.90	0.02	0.92	Σ SAR < 1.6, Not required
			Rear Face	1.12	0.02	1.14	Σ SAR < 1.6, Not required

Test Engineer : Yihu Xiong



5. Calibration of Test Equipment

Equipment	Manufacturer	Model	SN	Cal. Date	Cal. Interval
System Validation Kit	SPEAG	D835V2	4d139	Aug. 07, 2012	Annual
System Validation Kit	SPEAG	D1900V2	5d018	Jun. 10, 2013	Annual
System Validation Kit	SPEAG	D2450V2	735	Jun. 11, 2013	Annual
Dosimetric E-Field Probe	SPEAG	EX3DV4	3753	Jan. 17, 2013	Annual
Data Acquisition Electronics	SPEAG	DAE4	915	Jun. 11, 2013	Annual
SAM Phantom	SPEAG	QD000P40CD	TP-1695	N/A	N/A
SAM Phantom	SPEAG	QD000P40CD	TP-1722	N/A	N/A
Radio Communication Tester	Agilent	E5515C	MY50260600	Mar. 12, 2013	Biennial
ENA Series Network Analyzer	Agilent	E5071C	MY46214638	Sep. 26, 2012	Annual
MXG Analog Signal Generator	Agilent	N5183A	MY50140980	Nov. 05, 2012	Annual
Power Meter	Agilent	N1914A	MY52180044	Aug. 24, 2012	Annual
Power Sensor	Agilent	E9304A	MY52050011	Aug. 23, 2012	Annual
EXA Spectrum Analyzer	Agilent	E7405A	MY45118807	May 14, 2013	Annual
Dielectric Assessment Kit	SPEAG	DAK-3.5	1076	Jul. 29, 2013	Annual
Thermometer	YFE	YF-160A	120100323	Sep. 03, 2012	Annual
Power Amplifier	TESEQ	CBA 1G-150	T44029	Dec. 10, 2012	Annual
Power Amplifier	OPHIR	5161F	1048	Dec. 10, 2012	Annual
Attenuator	Woken	00800A1G01L-03	N/A	Sep. 03, 2012	Annual

6. Measurement Uncertainty

Error Description	Uncertainty Value (±%)	Probability Distribution	Divisor	Ci (1g)	Standard Uncertainty (1g)	Vi
Measurement System						
Probe Calibration	6.0	Normal	1	1	± 6.0 %	∞
Axial Isotropy	4.7	Rectangular	√3	0.7	± 1.9 %	∞
Hemispherical Isotropy	9.6	Rectangular	√3	0.7	± 3.9 %	∞
Boundary Effects	1.0	Rectangular	√3	1	± 0.6 %	∞
Linearity	4.7	Rectangular	√3	1	± 2.7 %	∞
System Detection Limits	1.0	Rectangular	√3	1	± 0.6 %	∞
Readout Electronics	0.6	Normal	1	1	± 0.6 %	∞
Response Time	0.0	Rectangular	√3	1	± 0.0 %	∞
Integration Time	1.7	Rectangular	√3	1	± 1.0 %	∞
RF Ambient Noise	3.0	Rectangular	√3	1	± 1.7 %	∞
RF Ambient Reflections	3.0	Rectangular	√3	1	± 1.7 %	∞
Probe Positioner	0.5	Rectangular	√3	1	± 0.3 %	∞
Probe Positioning	2.9	Rectangular	√3	1	± 1.7 %	∞
Max. SAR Eval.	2.3	Rectangular	√3	1	± 1.3 %	∞
Test Sample Related						
Device Positioning	3.9	Normal	1	1	± 3.9 %	31
Device Holder	2.7	Normal	1	1	± 2.7 %	19
Power Drift	5.0	Rectangular	√3	1	± 2.9 %	∞
Phantom and Setup						
Phantom Uncertainty	4.0	Rectangular	√3	1	± 2.3 %	∞
Liquid Conductivity (Target)	5.0	Rectangular	√3	0.64	± 1.8 %	∞
Liquid Conductivity (Meas.)	5.0	Normal	1	0.64	± 3.2 %	29
Liquid Permittivity (Target)	5.0	Rectangular	√3	0.6	± 1.7 %	∞
Liquid Permittivity (Meas.)	5.0	Normal	1	0.6	± 3.0 %	29
Combined Standard Uncertainty					± 11.7 %	
Expanded Uncertainty (K=2)					± 23.4 %	

Uncertainty budget for frequency range 300 MHz to 3 GHz



7. Information on the Testing Laboratories

We, Bureau Veritas Consumer Products Services (H.K.) Ltd., China Branch, were founded in 1988 to provide our best service in EMC, Radio, Telecom and Safety consultation. Our laboratories are accredited and approved according to ISO/IEC 17025.

If you have any comments, please feel free to contact us at the following:

China Dongguan Lab:

No. 34, Guantai Rd., Houjie Town, Dongguan, Guangdong 523942, China

Tel: 86-769-8593-5656

Fax: 86-769-8599-1080

Email: service.dg@cn.bureauveritas.com

Web Site: www.adt.com.tw

The road map of all our labs can be found in our web site also.

---END---



Appendix A. SAR Plots of System Verification

The plots for system verification with largest deviation for each SAR system combination are shown as follows.

System Check_H835_130805

DUT: Dipole 835 MHz; Type: D835V2; SN: 4d139

Communication System: CW; Frequency: 835 MHz; Duty Cycle: 1:1

Medium: H850-A_0805 Medium parameters used: $f = 835$ MHz; $\sigma = 0.9$ mho/m; $\epsilon_r = 43.152$; $\rho = 1000$ kg/m³

Ambient Temperature : 21.7 °C ; Liquid Temperature : 20.5 °C

DASY5 Configuration:

- Probe: EX3DV4 - SN3753; ConvF(8.95, 8.95, 8.95); Calibrated: 2013/01/17;
- Sensor-Surface: 2mm (Mechanical Surface Detection)
- Electronics: DAE4 Sn915; Calibrated: 2013/06/11
- Phantom: Front Phantom with CRP v5.0; Type: QD000P40CD; Serial: TP:1695
- Measurement SW: DASY52, Version 52.8 (5); SEMCAD X Version 14.6.6 (6824)

Pin=250mW/Area Scan (61x101x1): Measurement grid: dx=15mm, dy=15mm

Maximum value of SAR (interpolated) = 3.09 W/kg

Pin=250mW/Zoom Scan (5x5x7)/Cube 0: Measurement grid: dx=8mm, dy=8mm, dz=5mm

Reference Value = 59.318 V/m; Power Drift = 0.00 dB

Peak SAR (extrapolated) = 3.600 mW/g

SAR(1 g) = 2.46 mW/g; SAR(10 g) = 1.62 mW/g

Maximum value of SAR (measured) = 3.10 W/kg

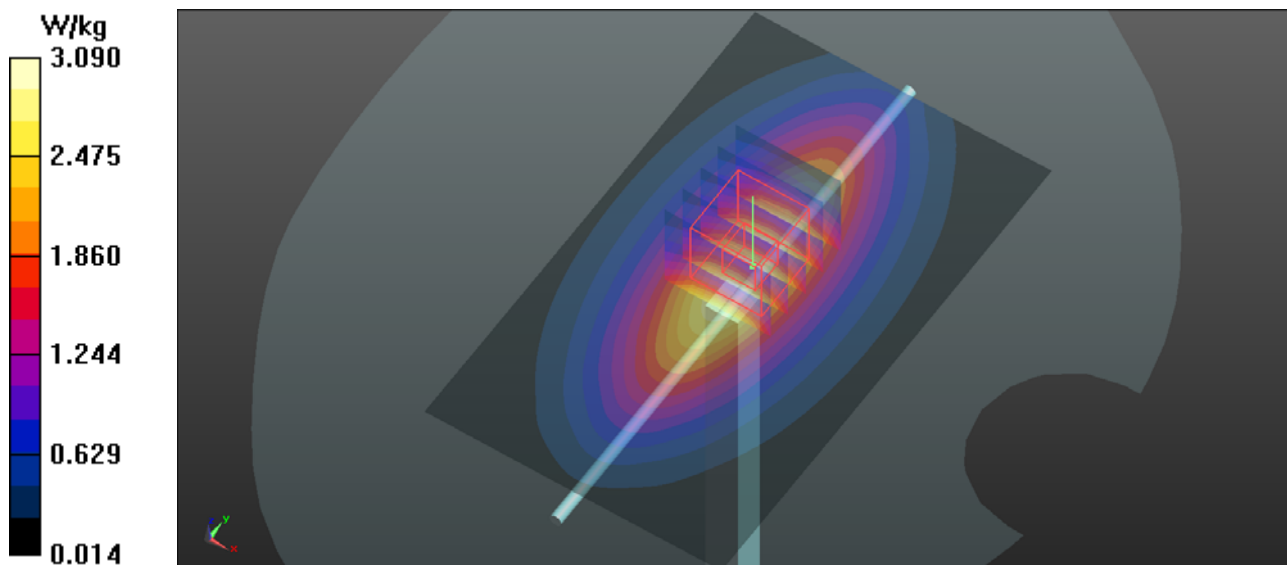

System Check_H1900_130804

DUT: Dipole 1900 MHz; Type: D1900V2; SN: 5d018

Communication System: CW; Frequency: 1900 MHz; Duty Cycle: 1:1

Medium: H1900-A_0804 Medium parameters used: $f = 1900$ MHz; $\sigma = 1.454$ mho/m; $\epsilon_r = 40.327$; $\rho = 1000$ kg/m³

Ambient Temperature : 21.6 °C ; Liquid Temperature : 20.5 °C

DASY5 Configuration:

- Probe: EX3DV4 - SN3753; ConvF(7.63, 7.63, 7.63); Calibrated: 2013/01/17;
- Sensor-Surface: 2mm (Mechanical Surface Detection)
- Electronics: DAE4 Sn915; Calibrated: 2013/06/11
- Phantom: Right Phantom with CRP v5.0; Type: QD000P40CD; Serial: TP:1722
- Measurement SW: DASY52, Version 52.8 (2); SEMCAD X Version 14.6.6 (6824)

Pin=250mW/Area Scan (61x61x1): Measurement grid: dx=15mm, dy=15mm

Maximum value of SAR (interpolated) = 14.8 W/kg

Pin=250mW/Zoom Scan (5x5x7)/Cube 0: Measurement grid: dx=8mm, dy=8mm, dz=5mm

Reference Value = 98.216 V/m; Power Drift = 0.00 dB

Peak SAR (extrapolated) = 18.830 mW/g

SAR(1 g) = 10.2 mW/g; SAR(10 g) = 5.24 mW/g

Maximum value of SAR (measured) = 14.7 W/kg

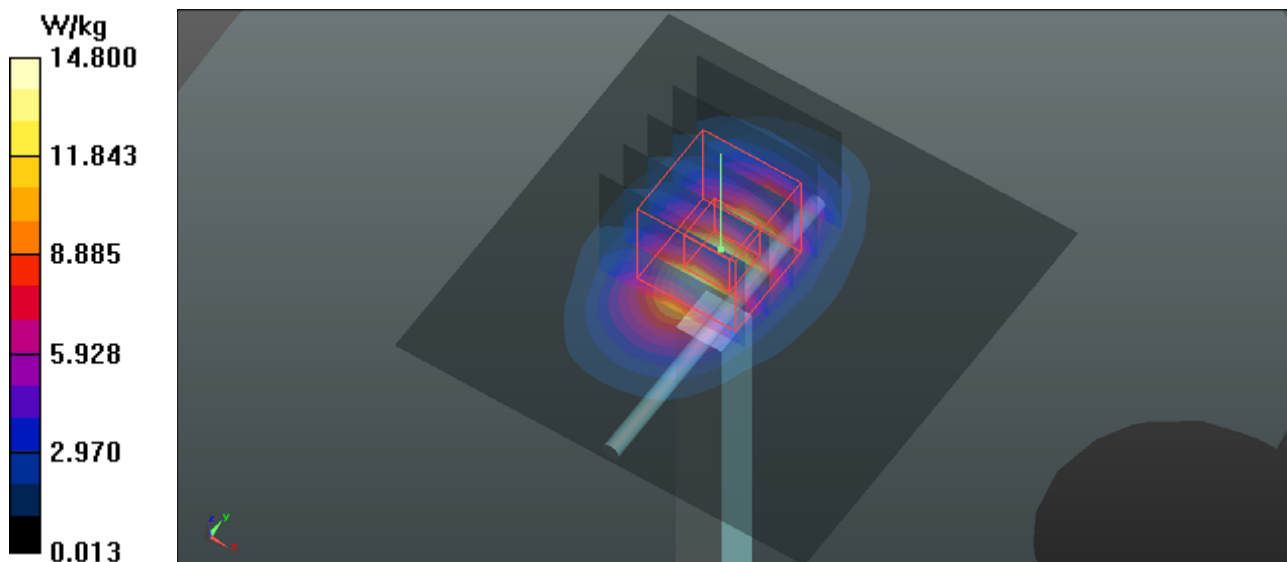

System Check_H2450_130806

DUT: Dipole 2450 MHz; Type: D2450V2; SN: 735

Communication System: CW; Frequency: 2450 MHz; Duty Cycle: 1:1

Medium: H2450-A_0806 Medium parameters used: $f = 2450$ MHz; $\sigma = 1.832$ mho/m; $\epsilon_r = 38.716$; $\rho = 1000$ kg/m³

Ambient Temperature : 21.5 °C ; Liquid Temperature : 20.5 °C

DASY5 Configuration:

- Probe: EX3DV4 - SN3753; ConvF(6.86, 6.86, 6.86); Calibrated: 2013/01/17;
- Sensor-Surface: 2mm (Mechanical Surface Detection)
- Electronics: DAE4 Sn915; Calibrated: 2013/06/11
- Phantom: Front Phantom with CRP v5.0; Type: QD000P40CD; Serial: TP:1695
- Measurement SW: DASY52, Version 52.8 (5); SEMCAD X Version 14.6.6 (6824)

Pin=250mW/Area Scan (61x61x1): Measurement grid: dx=15mm, dy=15mm

Maximum value of SAR (interpolated) = 20.2 W/kg

Pin=250mW/Zoom Scan (5x5x7)/Cube 0: Measurement grid: dx=5mm, dy=5mm, dz=5mm

Reference Value = 107.6 V/m; Power Drift = 0.07 dB

Peak SAR (extrapolated) = 29.013 mW/g

SAR(1 g) = 13.3 mW/g; SAR(10 g) = 5.94 mW/g

Maximum value of SAR (measured) = 21.0 W/kg

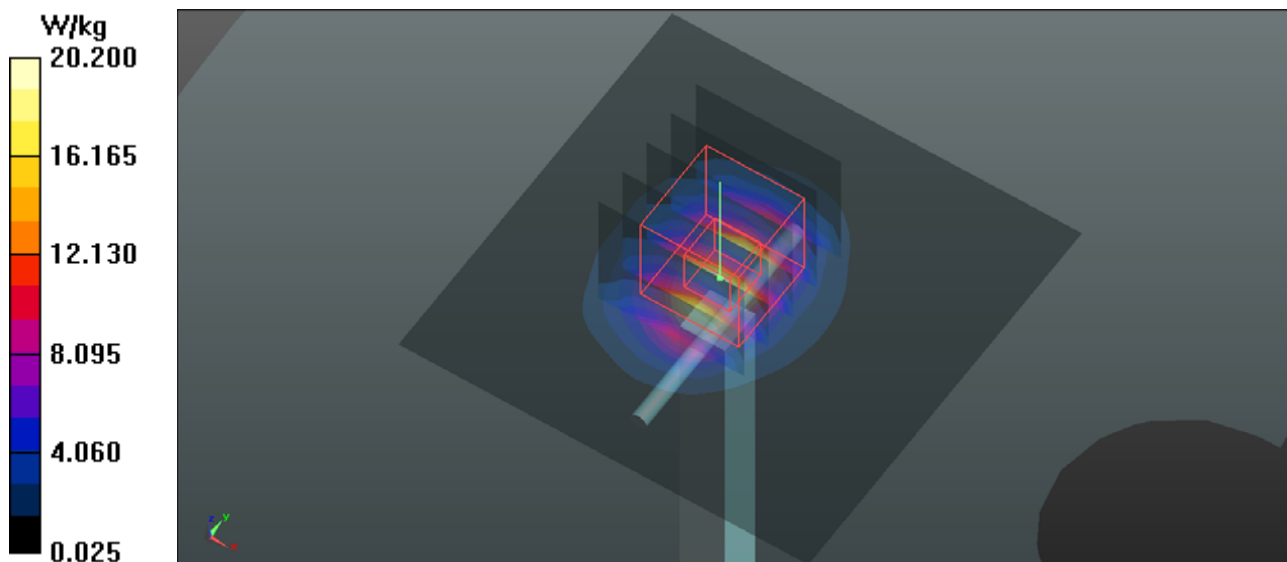

System Check_B835_130802

DUT: Dipole 835 MHz; Type: D835V2; SN: 4d139

Communication System: CW; Frequency: 835 MHz; Duty Cycle: 1:1

Medium: B850-A_0802 Medium parameters used: $f = 835$ MHz; $\sigma = 0.957$ mho/m; $\epsilon_r = 56.452$; $\rho = 1000$ kg/m³

Ambient Temperature : 21.4 °C ; Liquid Temperature : 20.5 °C

DASY5 Configuration:

- Probe: EX3DV4 - SN3753; ConvF(9.05, 9.05, 9.05); Calibrated: 2013/01/17;
- Sensor-Surface: 2mm (Mechanical Surface Detection)
- Electronics: DAE4 Sn915; Calibrated: 2013/06/11
- Phantom: Front Phantom with CRP v5.0; Type: QD000P40CD; Serial: TP:1695
- Measurement SW: DASY52, Version 52.8 (5); SEMCAD X Version 14.6.6 (6824)

Pin=250mW/Area Scan (61x101x1): Measurement grid: dx=15mm, dy=15mm

Maximum value of SAR (interpolated) = 3.03 W/kg

Pin=250mW/Zoom Scan (5x5x7)/Cube 0: Measurement grid: dx=8mm, dy=8mm, dz=5mm

Reference Value = 57.439 V/m; Power Drift = 0.03 dB

Peak SAR (extrapolated) = 3.574 mW/g

SAR(1 g) = 2.43 mW/g; SAR(10 g) = 1.62 mW/g

Maximum value of SAR (measured) = 3.06 W/kg

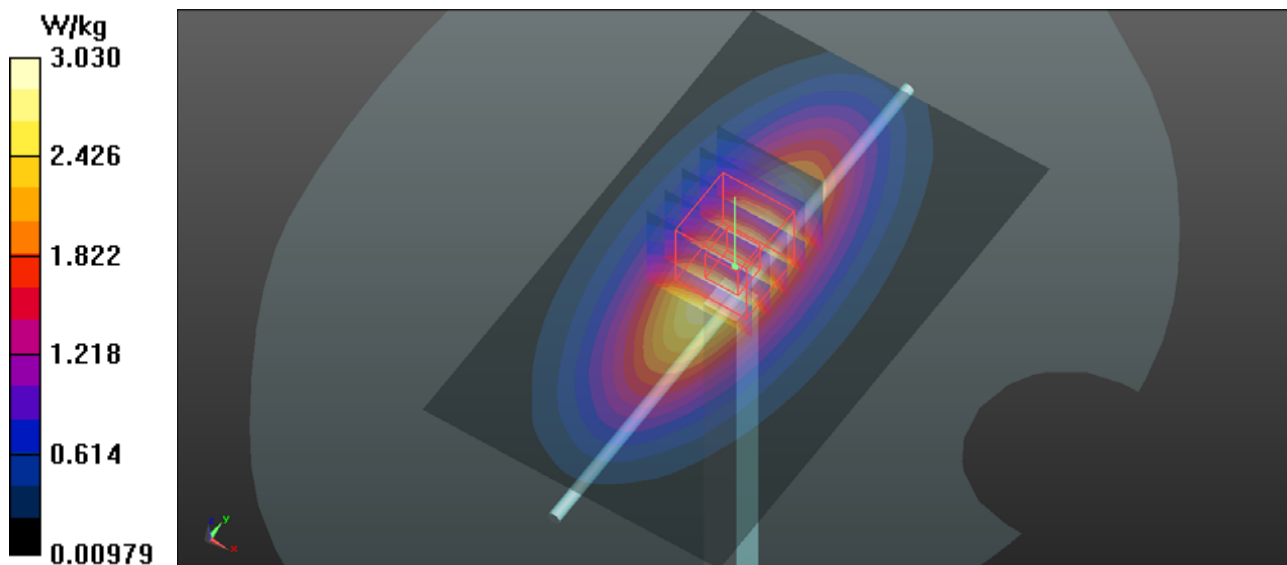

System Check_B1900_130805

DUT: Dipole 1900MHz; Type: D1900V2; SN: 5d018

Communication System: CW; Frequency: 1900 MHz; Duty Cycle: 1:1

Medium: B1900_0805 Medium parameters used: $f=1900$ MHz; $\sigma = 1.51$ mho/m; $\epsilon_r = 54.116$; $\rho = 1000$ kg/m³

Ambient Temperature : 21.3 °C ; Liquid Temperature : 20.5 °C

DASY5 Configuration:

- Probe: EX3DV4 - SN3753; ConvF(7.33, 7.33, 7.33); Calibrated: 2013/01/17;
- Sensor-Surface: 2mm (Mechanical Surface Detection)
- Electronics: DAE4 Sn915; Calibrated: 2013/06/11
- Phantom: Right Phantom with CRP v5.0; Type: QD000P40CD; Serial: TP:1722
- Measurement SW: DASY52, Version 52.8 (5); SEMCAD X Version 14.6.6 (6824)

Pin=250mW/Area Scan (61x61x1): Measurement grid: dx=15mm, dy=15mm

Maximum value of SAR (interpolated) = 14.1 W/kg

Pin=250mW/Zoom Scan (5x5x7)/Cube 0: Measurement grid: dx=8mm, dy=8mm, dz=5mm

Reference Value = 98.709 V/m; Power Drift = -0.01 dB

Peak SAR (extrapolated) = 18.112 mW/g

SAR(1 g) = 10.2 mW/g; SAR(10 g) = 5.33 mW/g

Maximum value of SAR (measured) = 14.5 W/kg

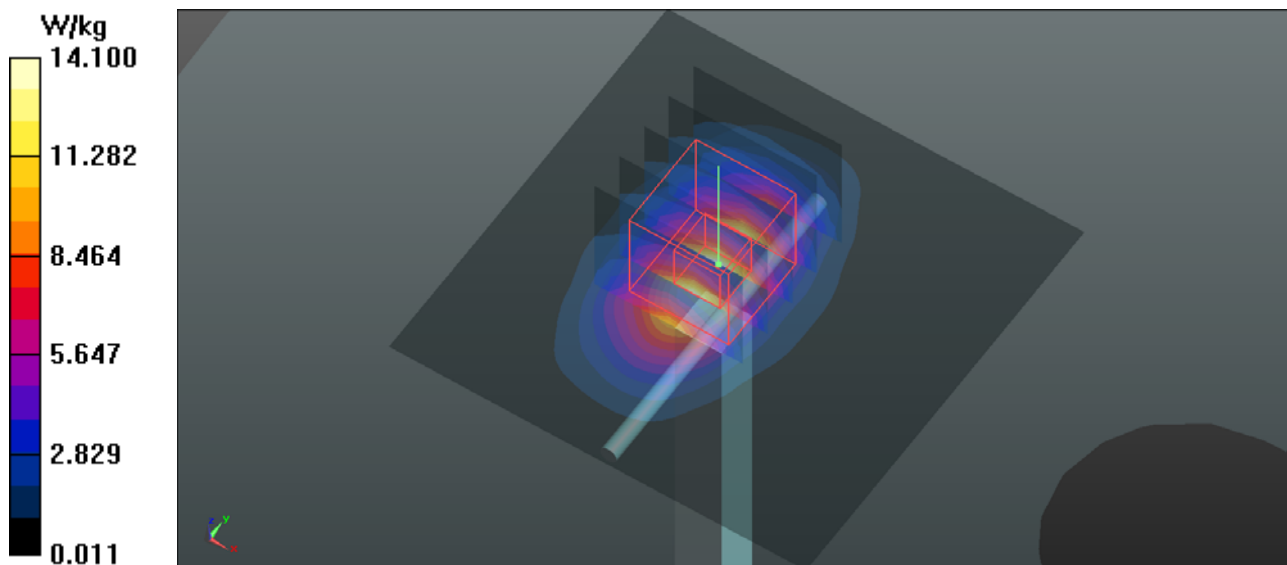

System Check_B2450_130806

DUT: Dipole 2450 MHz; Type: D2450V2; SN: 735

Communication System: CW; Frequency: 2450 MHz; Duty Cycle: 1:1

Medium: B2450-A_0806 Medium parameters used: $f = 2450$ MHz; $\sigma = 1.902$ mho/m; $\epsilon_r = 51.445$; $\rho = 1000$ kg/m³

Ambient Temperature : 21.2 °C ; Liquid Temperature : 20.5 °C

DASY5 Configuration:

- Probe: EX3DV4 - SN3753; ConvF(6.9, 6.9, 6.9); Calibrated: 2013/01/17;
- Sensor-Surface: 2mm (Mechanical Surface Detection)
- Electronics: DAE4 Sn915; Calibrated: 2013/06/11
- Phantom: Right Phantom with CRP v5.0; Type: QD000P40CD; Serial: TP:1722
- Measurement SW: DASY52, Version 52.8 (5); SEMCAD X Version 14.6.6 (6824)

Pin=250mW/Area Scan (61x61x1): Measurement grid: dx=15mm, dy=15mm

Maximum value of SAR (interpolated) = 18.6 W/kg

Pin=250mW/Zoom Scan (5x5x7)/Cube 0: Measurement grid: dx=5mm, dy=5mm, dz=5mm

Reference Value = 99.991 V/m; Power Drift = 0.06 dB

Peak SAR (extrapolated) = 26.801 mW/g

SAR(1 g) = 12.7 mW/g; SAR(10 g) = 5.81 mW/g

Maximum value of SAR (measured) = 19.5 W/kg

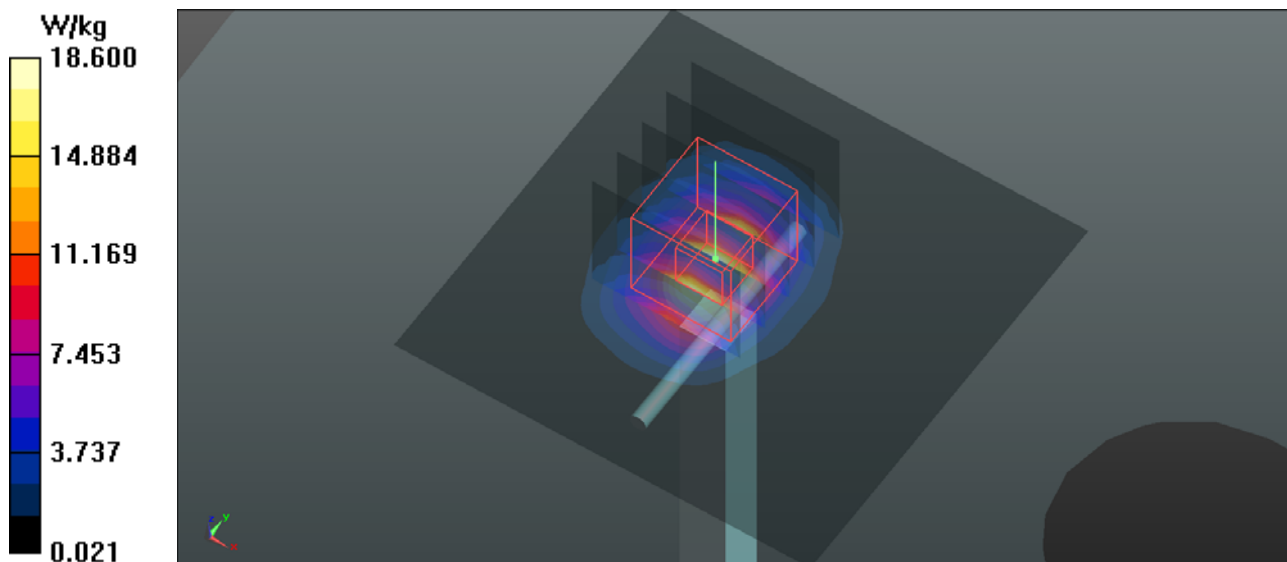



Appendix B. SAR Plots of SAR Measurement

The SAR plots for highest measured SAR in each exposure configuration, wireless mode and frequency band combination, and measured SAR > 1.5 W/kg are shown as follows.

P01 GSM850_GSM_Left Cheek_Ch251

DUT: 130723N027

Communication System: GSM ; Frequency: 848.8 MHz; Duty Cycle: 1:8.3

Medium: H850-A_0805 Medium parameters used: $f = 849$ MHz; $\sigma = 0.914$ mho/m; $\epsilon_r = 42.99$; $\rho = 1000$ kg/m³

Ambient Temperature : 21.7 °C ; Liquid Temperature : 20.5 °C

DASY5 Configuration:

- Probe: EX3DV4 - SN3753; ConvF(8.95, 8.95, 8.95); Calibrated: 2013/01/17;
- Sensor-Surface: 2mm (Mechanical Surface Detection)
- Electronics: DAE4 Sn915; Calibrated: 2013/06/11
- Phantom: Front Phantom with CRP v5.0; Type: QD000P40CD; Serial: TP:1695
- Measurement SW: DASY52, Version 52.8 (2); SEMCAD X Version 14.6.6 (6824)

-Area Scan (61x101x1): Interpolated grid: dx=1.500 mm, dy=1.500 mm

Maximum value of SAR (interpolated) = 0.609 W/kg

-Zoom Scan (5x5x7)/Cube 0: Measurement grid: dx=8mm, dy=8mm, dz=5mm

Reference Value = 7.517 V/m; Power Drift = 0.10 dB

Peak SAR (extrapolated) = 0.657 W/kg

SAR(1 g) = 0.546 W/kg; SAR(10 g) = 0.417 W/kg

Maximum value of SAR (measured) = 0.612 W/kg

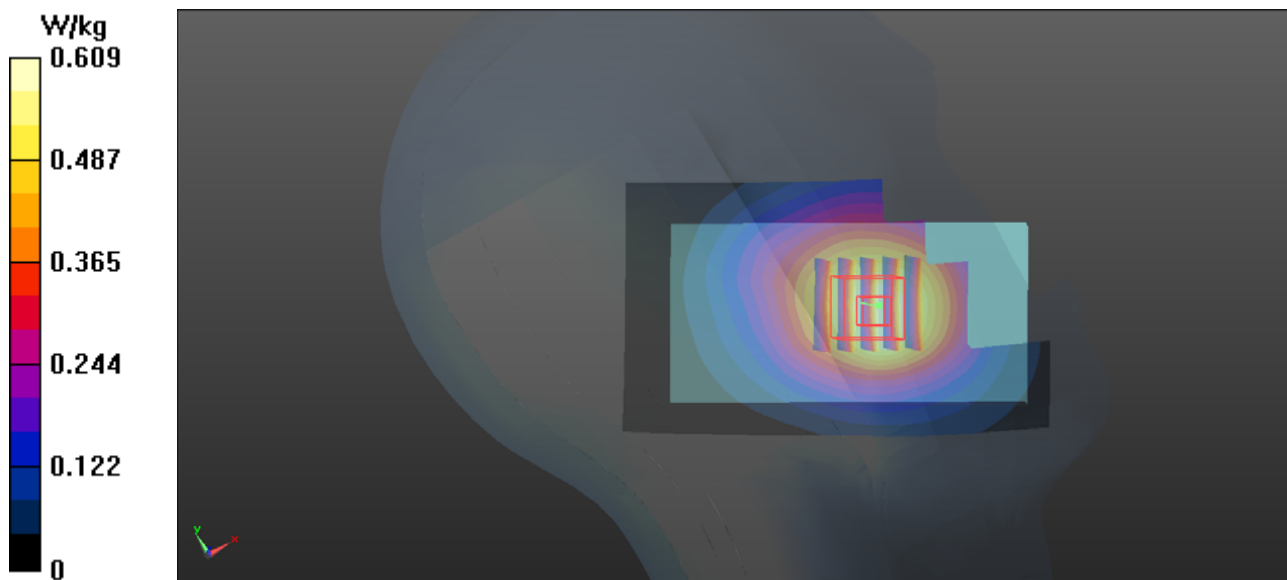

P02 GSM1900_GSM_Right Cheek_Ch661

DUT: 130723N027

Communication System: GSM ; Frequency: 1880 MHz; Duty Cycle: 1:8.3

Medium: H1900-A_0804 Medium parameters used: $f = 1880$ MHz; $\sigma = 1.434$ mho/m; $\epsilon_r = 40.411$; $\rho = 1000$ kg/m³

Ambient Temperature : 21.6 °C ; Liquid Temperature : 20.5 °C

DASY5 Configuration:

- Probe: EX3DV4 - SN3753; ConvF(7.63, 7.63, 7.63); Calibrated: 2013/01/17;
- Sensor-Surface: 2mm (Mechanical Surface Detection)
- Electronics: DAE4 Sn915; Calibrated: 2013/06/11
- Phantom: Right Phantom with CRP v5.0; Type: QD000P40CD; Serial: TP:1722
- Measurement SW: DASY52, Version 52.8 (2); SEMCAD X Version 14.6.6 (6824)

-Area Scan (61x101x1): Interpolated grid: dx=1.500 mm, dy=1.500 mm

Maximum value of SAR (interpolated) = 0.753 W/kg

-Zoom Scan (5x5x7)/Cube 0: Measurement grid: dx=8mm, dy=8mm, dz=5mm

Reference Value = 7.401 V/m; Power Drift = 0.18 dB

Peak SAR (extrapolated) = 0.895 mW/g

SAR(1 g) = 0.562 mW/g; SAR(10 g) = 0.329 mW/g

Maximum value of SAR (measured) = 0.743 W/kg

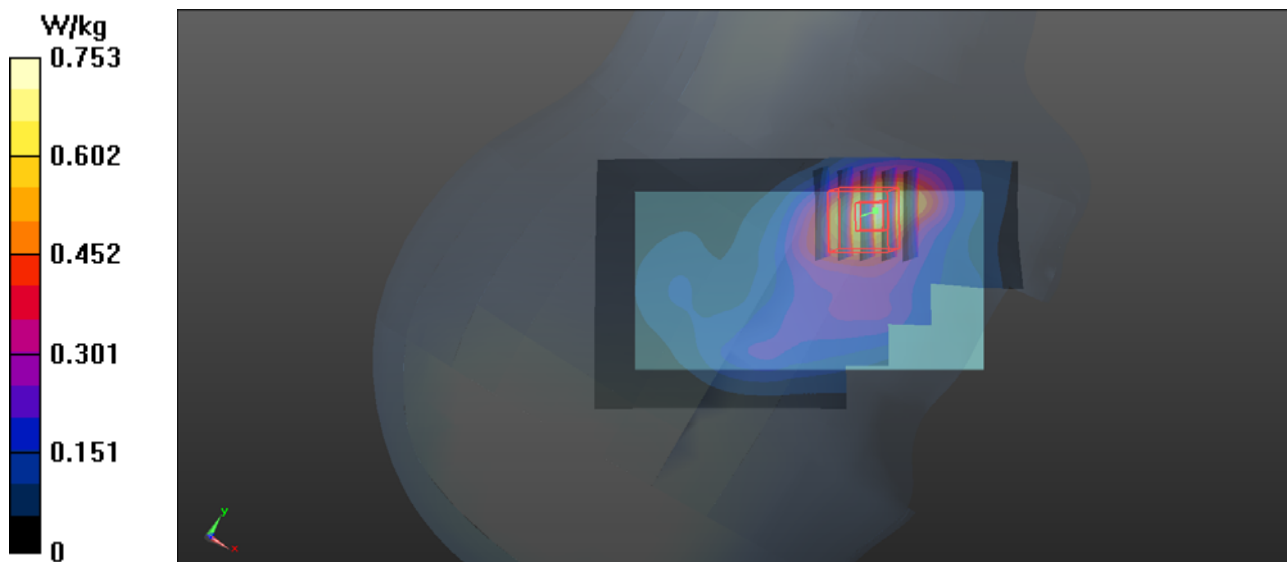

P03 WCDMA II_RMC12.2K_Right Cheek_Ch9262

DUT: 130723N027

Communication System: WCDMA; Frequency: 1852.4 MHz; Duty Cycle: 1:1

Medium: H1900-A_0804 Medium parameters used: $f = 1852.4$ MHz; $\sigma = 1.405$ mho/m; $\epsilon_r = 40.558$; $\rho = 1000$ kg/m³

Ambient Temperature : 21.6 °C; Liquid Temperature : 20.5 °C

DASY5 Configuration:

- Probe: EX3DV4 - SN3753; ConvF(7.63, 7.63, 7.63); Calibrated: 2013/01/17;
- Sensor-Surface: 2mm (Mechanical Surface Detection)
- Electronics: DAE4 Sn915; Calibrated: 2013/06/11
- Phantom: Right Phantom with CRP v5.0; Type: QD000P40CD; Serial: TP:1722
- Measurement SW: DASY52, Version 52.8 (2); SEMCAD X Version 14.6.6 (6824)

-Area Scan (61x101x1): Interpolated grid: dx=1.500 mm, dy=1.500 mm

Maximum value of SAR (interpolated) = 1.22 W/kg

-Zoom Scan (5x5x7)/Cube 0: Measurement grid: dx=8mm, dy=8mm, dz=5mm

Reference Value = 8.824 V/m; Power Drift = -0.03 dB

Peak SAR (extrapolated) = 1.489 mW/g

SAR(1 g) = 0.955 mW/g; SAR(10 g) = 0.567 mW/g

Maximum value of SAR (measured) = 1.22 W/kg

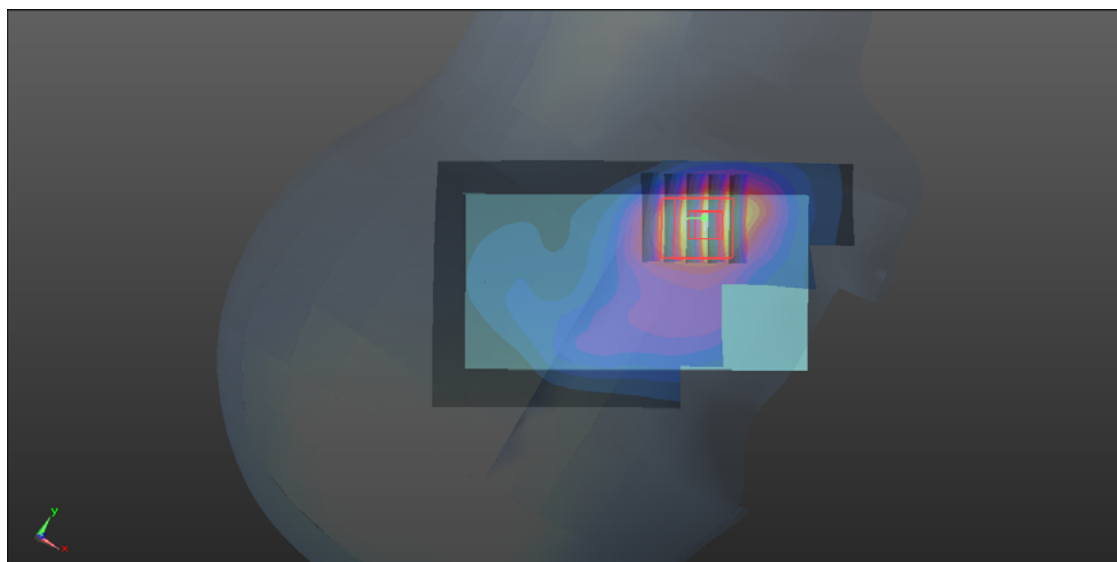
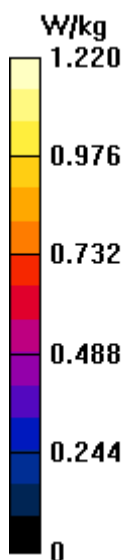

P04 WCDMA V_RMC12.2K_Left Cheek_Ch4233

DUT: 130723N027

Communication System: WCDMA; Frequency: 846.6 MHz; Duty Cycle: 1:1

Medium: H850-A_0805 Medium parameters used: $f = 847$ MHz; $\sigma = 0.912$ mho/m; $\epsilon_r = 43.013$; $\rho = 1000$ kg/m³

Ambient Temperature : 21.7 °C ; Liquid Temperature : 20.5 °C

DASY5 Configuration:

- Probe: EX3DV4 - SN3753; ConvF(8.95, 8.95, 8.95); Calibrated: 2013/01/17;
- Sensor-Surface: 2mm (Mechanical Surface Detection)
- Electronics: DAE4 Sn915; Calibrated: 2013/06/11
- Phantom: Front Phantom with CRP v5.0; Type: QD000P40CD; Serial: TP:1695
- Measurement SW: DASY52, Version 52.8 (2); SEMCAD X Version 14.6.6 (6824)

-Area Scan (61x101x1): Interpolated grid: dx=1.500 mm, dy=1.500 mm

Maximum value of SAR (interpolated) = 0.784 W/kg

-Zoom Scan (5x5x7)/Cube 0: Measurement grid: dx=8mm, dy=8mm, dz=5mm

Reference Value = 7.287 V/m; Power Drift = 0.11 dB

Peak SAR (extrapolated) = 0.839 W/kg

SAR(1 g) = 0.703 W/kg; SAR(10 g) = 0.540 W/kg

Maximum value of SAR (measured) = 0.786 W/kg

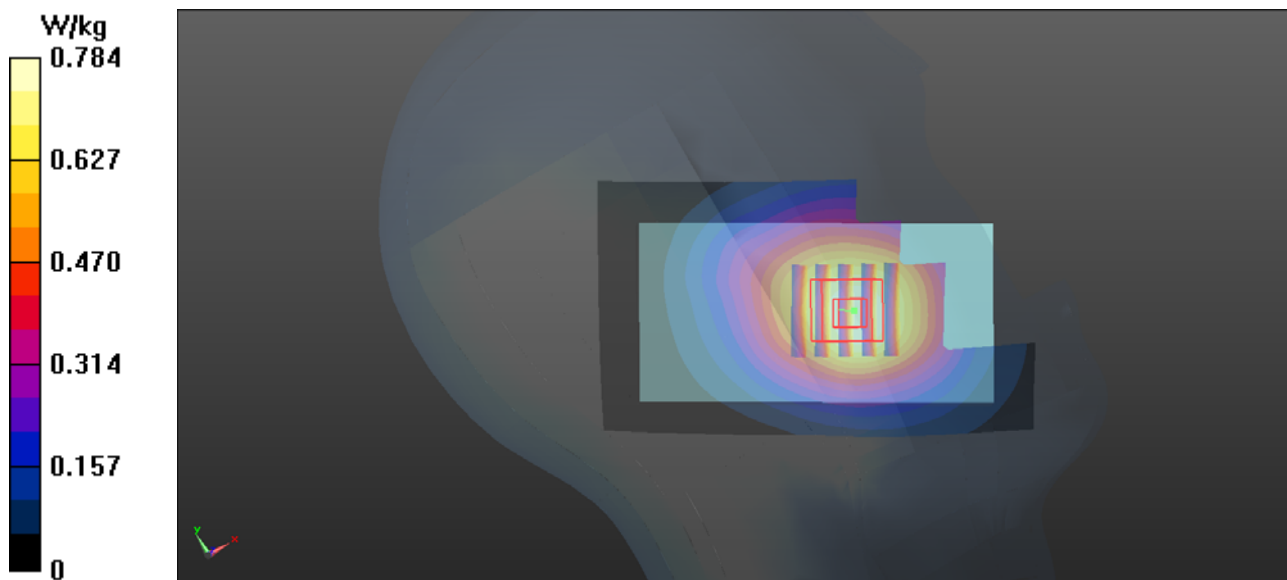

P05 802.11b_Left Cheek_Ch1

DUT: 130723N027

Communication System: 802.11b; Frequency: 2412 MHz; Duty Cycle: 1:1

Medium: H2450-A_0806 Medium parameters used: $f = 2412$ MHz; $\sigma = 1.786$ mho/m; $\epsilon_r = 38.87$; $\rho = 1000$ kg/m³

Ambient Temperature : 21.5 °C ; Liquid Temperature : 20.5 °C

DASY5 Configuration:

- Probe: EX3DV4 - SN3753; ConvF(6.86, 6.86, 6.86); Calibrated: 2013/01/17;
- Sensor-Surface: 2mm (Mechanical Surface Detection)
- Electronics: DAE4 Sn915; Calibrated: 2013/06/11
- Phantom: Front Phantom with CRP v5.0; Type: QD000P40CD; Serial: TP:1695
- Measurement SW: DASY52, Version 52.8 (5); SEMCAD X Version 14.6.6 (6824)

-Area Scan (71x121x1): Interpolated grid: dx=1.200 mm, dy=1.200 mm

Maximum value of SAR (interpolated) = 0.664 W/kg

-Zoom Scan (7x7x7)/Cube 0: Measurement grid: dx=5mm, dy=5mm, dz=5mm

Reference Value = 9.327 V/m; Power Drift = -0.08 dB

Peak SAR (extrapolated) = 0.952 mW/g

SAR(1 g) = 0.406 mW/g; SAR(10 g) = 0.197 mW/g

Maximum value of SAR (measured) = 0.642 W/kg

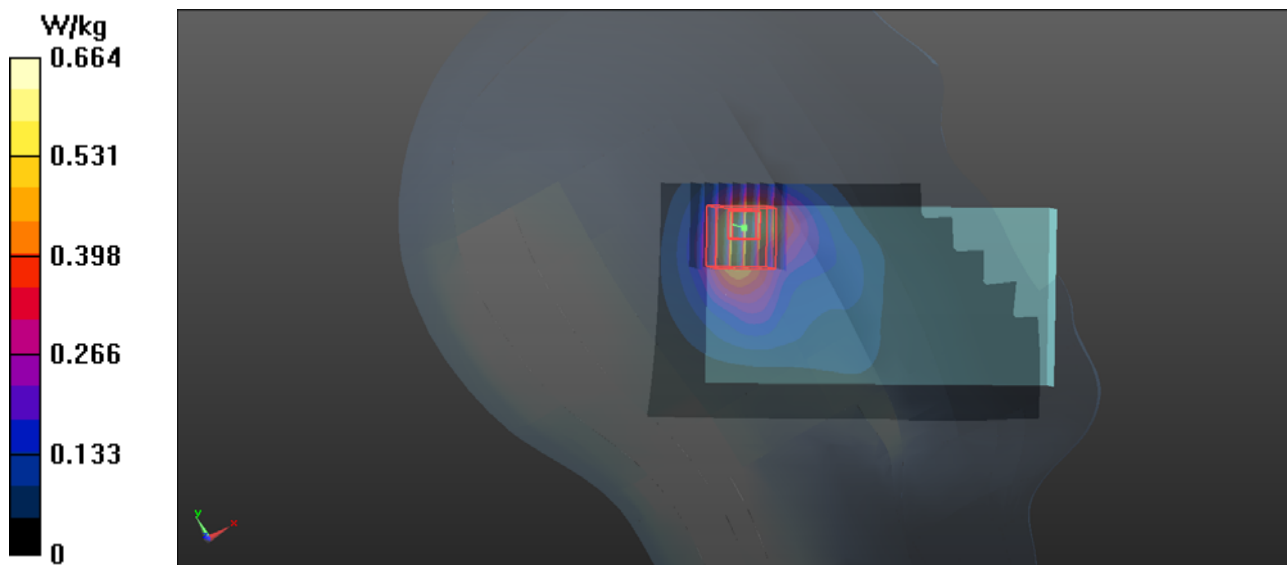

P06 GSM850_GPRS12_Rear Face_1cm_Ch128

DUT: 130723N027

Communication System: GPRS12; Frequency: 824.2 MHz; Duty Cycle: 1:2
Medium: B850-A_0802 Medium parameters used: $f = 824.2$ MHz; $\sigma = 0.944$ mho/m; $\epsilon_r = 57.368$; $\rho = 1000$ kg/m³
Ambient Temperature : 21.4 °C ; Liquid Temperature : 20.5 °C

DASY5 Configuration:

- Probe: EX3DV4 - SN3753; ConvF(9.05, 9.05, 9.05); Calibrated: 2013/01/17;
- Sensor-Surface: 2mm (Mechanical Surface Detection)
- Electronics: DAE4 Sn915; Calibrated: 2013/06/11
- Phantom: Front Phantom with CRP v5.0; Type: QD000P40CD; Serial: TP:1695
- Measurement SW: DASY52, Version 52.8 (5); SEMCAD X Version 14.6.6 (6824)

-Area Scan (61x101x1): Interpolated grid: dx=1.500 mm, dy=1.500 mm
Maximum value of SAR (interpolated) = 1.26 W/kg

-Zoom Scan (5x5x7)/Cube 0: Measurement grid: dx=8mm, dy=8mm, dz=5mm
Reference Value = 32.021 V/m; Power Drift = 0.01 dB
Peak SAR (extrapolated) = 1.43 W/kg
SAR(1 g) = 1.09 W/kg; SAR(10 g) = 0.811 W/kg
Maximum value of SAR (measured) = 1.27 W/kg

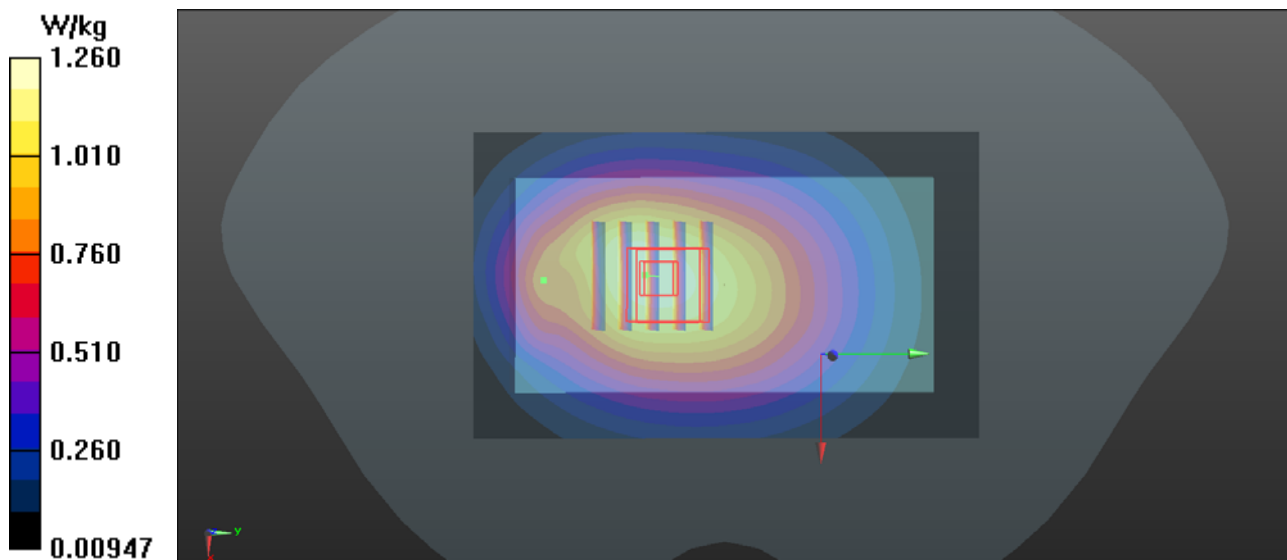

P07 GSM1900_GPRS12_Front Face_1cm_Ch512

DUT: 130723N027

Communication System: GPRS12; Frequency: 1850.2 MHz; Duty Cycle: 1:2

Medium: B1900-A_0805 Medium parameters used: $f = 1850.2$ MHz; $\sigma = 1.461$ mho/m; $\epsilon_r = 54.24$; $\rho = 1000$ kg/m³

Ambient Temperature : 21.3 °C ; Liquid Temperature : 20.5 °C

DASY5 Configuration:

- Probe: EX3DV4 - SN3753; ConvF(7.33, 7.33, 7.33); Calibrated: 2013/01/17;
- Sensor-Surface: 2mm (Mechanical Surface Detection)
- Electronics: DAE4 Sn915; Calibrated: 2013/06/11
- Phantom: Right Phantom with CRP v5.0; Type: QD000P40CD; Serial: TP:1722
- Measurement SW: DASY52, Version 52.8 (2); SEMCAD X Version 14.6.6 (6824)

-Area Scan (61x101x1): Interpolated grid: dx=1.500 mm, dy=1.500 mm

Maximum value of SAR (interpolated) = 1.03 W/kg

-Zoom Scan (5x5x7)/Cube 0: Measurement grid: dx=8mm, dy=8mm, dz=5mm

Reference Value = 8.265 V/m; Power Drift = -0.03 dB

Peak SAR (extrapolated) = 1.18 W/kg

SAR(1 g) = 0.739 W/kg; SAR(10 g) = 0.459 W/kg

Maximum value of SAR (measured) = 0.928 W/kg

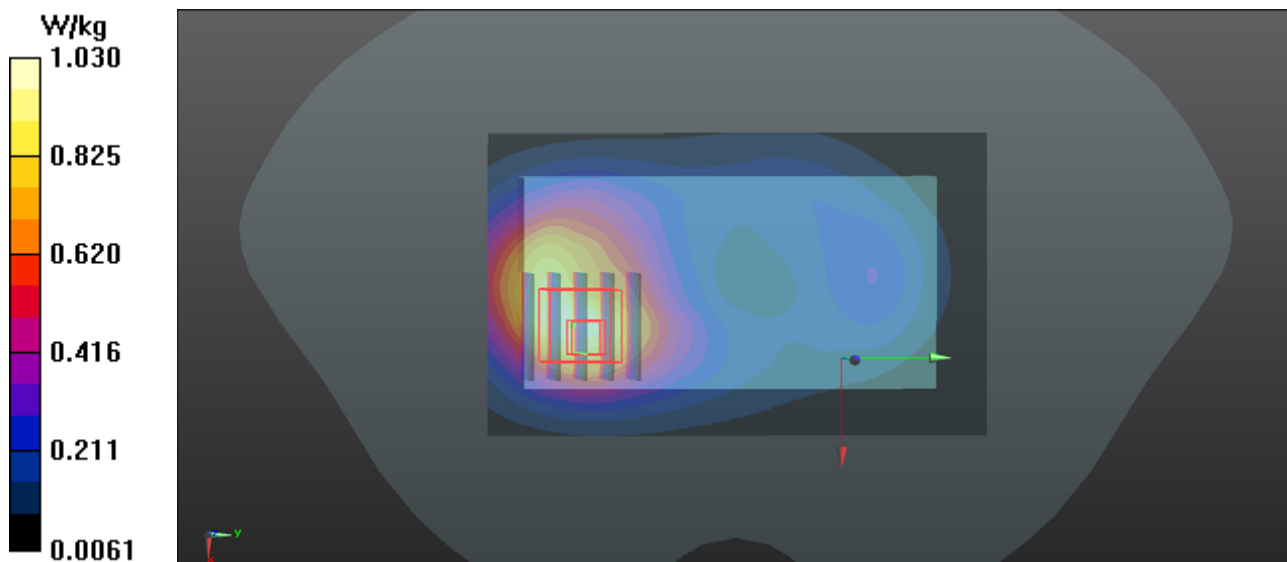

P08 WCDMA II_RMC12.2K_Front Face_1cm_Ch9400

DUT: 130723N027

Communication System: WCDMA; Frequency: 1880 MHz; Duty Cycle: 1:1
Medium: B1900-A_0805 Medium parameters used: $f = 1880$ MHz; $\sigma = 1.488$ mho/m; $\epsilon_r = 54.173$; $\rho = 1000$ kg/m³
Ambient Temperature : 21.3 °C; Liquid Temperature : 20.5 °C

DASY5 Configuration:

- Probe: EX3DV4 - SN3753; ConvF(7.33, 7.33, 7.33); Calibrated: 2013/01/17;
- Sensor-Surface: 2mm (Mechanical Surface Detection)
- Electronics: DAE4 Sn915; Calibrated: 2013/06/11
- Phantom: Right Phantom with CRP v5.0; Type: QD000P40CD; Serial: TP:1722
- Measurement SW: DASY52, Version 52.8 (2); SEMCAD X Version 14.6.6 (6824)

-Area Scan (61x101x1): Interpolated grid: dx=1.500 mm, dy=1.500 mm
Maximum value of SAR (interpolated) = 0.873 W/kg

-Zoom Scan (5x5x7)/Cube 0: Measurement grid: dx=8mm, dy=8mm, dz=5mm
Reference Value = 8.640 V/m; Power Drift = 0.08 dB
Peak SAR (extrapolated) = 0.979 W/kg
SAR(1 g) = 0.644 W/kg; SAR(10 g) = 0.400 W/kg
Maximum value of SAR (measured) = 0.827 W/kg

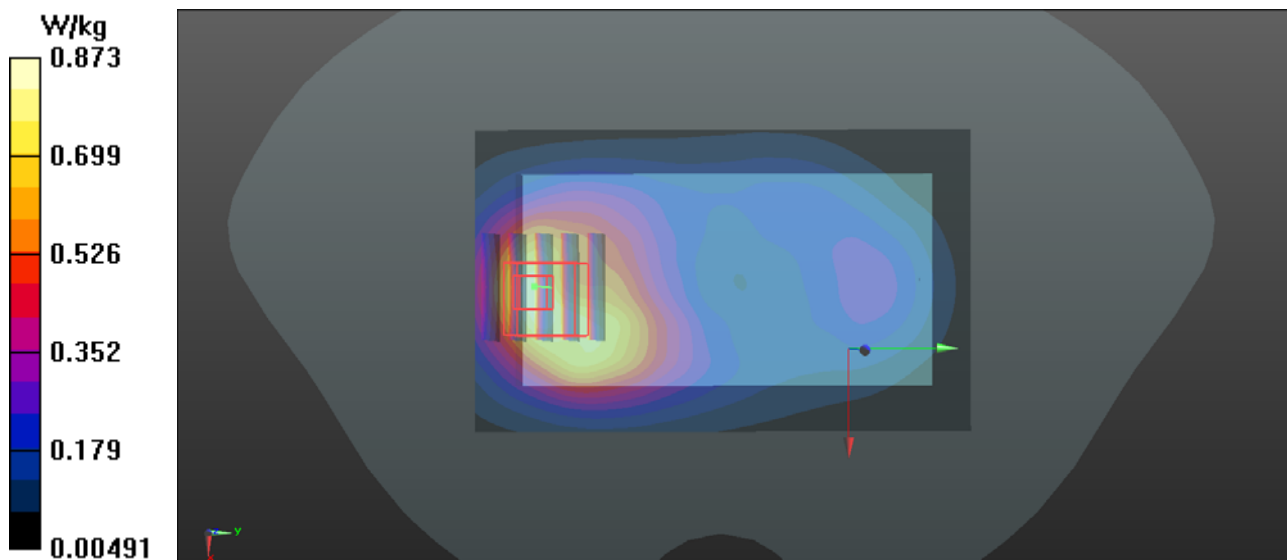

P09 WCDMA V_RMC12.2K_Rear Face_1cm_Ch4132

DUT: 130723N027

Communication System: WCDMA; Frequency: 826.4 MHz; Duty Cycle: 1:1

Medium: B850-A_0802 Medium parameters used: $f = 826.4$ MHz; $\sigma = 0.949$ mho/m; $\epsilon_r = 56.535$; $\rho = 1000$ kg/m³

Ambient Temperature : 21.4 °C ; Liquid Temperature : 20.5 °C

DASY5 Configuration:

- Probe: EX3DV4 - SN3753; ConvF(9.05, 9.05, 9.05); Calibrated: 2013/01/17;
- Sensor-Surface: 2mm (Mechanical Surface Detection)
- Electronics: DAE4 Sn915; Calibrated: 2013/06/11
- Phantom: Front Phantom with CRP v5.0; Type: QD000P40CD; Serial: TP:1695
- Measurement SW: DASY52, Version 52.8 (2); SEMCAD X Version 14.6.6 (6824)

-Area Scan (61x101x1): Interpolated grid: dx=1.500 mm, dy=1.500 mm

Maximum value of SAR (interpolated) = 1.14 W/kg

-Zoom Scan (5x5x7)/Cube 0: Measurement grid: dx=8mm, dy=8mm, dz=5mm

Reference Value = 29.409 V/m; Power Drift = -0.01 dB

Peak SAR (extrapolated) = 1.28 W/kg

SAR(1 g) = 0.957 W/kg; SAR(10 g) = 0.707 W/kg

Maximum value of SAR (measured) = 1.12 W/kg

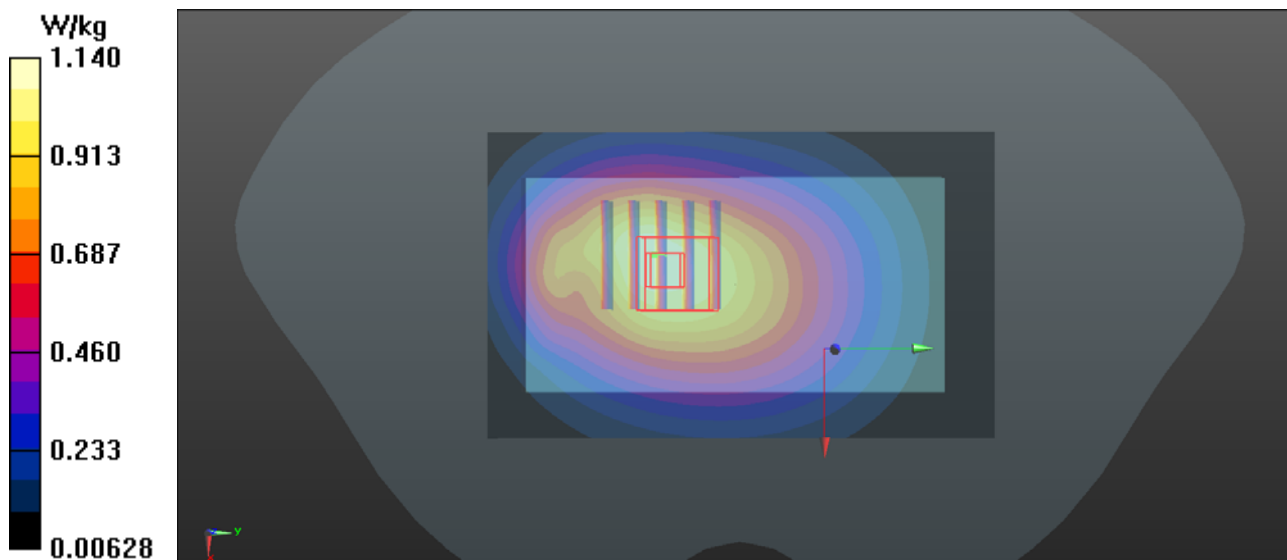

P10 802.11b_Rear Face_1cm_Ch1

DUT: 130723N027

Communication System: 802.11b; Frequency: 2412 MHz; Duty Cycle: 1:1

Medium: B2450-A_0806 Medium parameters used: $f = 2412$ MHz; $\sigma = 1.85$ mho/m; $\epsilon_r = 51.565$; $\rho = 1000$ kg/m³

Ambient Temperature : 21.2 °C; Liquid Temperature : 20.5 °C

DASY5 Configuration:

- Probe: EX3DV4 - SN3753; ConvF(6.9, 6.9, 6.9); Calibrated: 2013/01/17;
- Sensor-Surface: 2mm (Mechanical Surface Detection)
- Electronics: DAE4 Sn915; Calibrated: 2013/06/11
- Phantom: Right Phantom with CRP v5.0; Type: QD000P40CD; Serial: TP:1722
- Measurement SW: DASY52, Version 52.8 (5); SEMCAD X Version 14.6.6 (6824)

-Area Scan (71x131x1): Interpolated grid: dx=1.200 mm, dy=1.200 mm

Maximum value of SAR (interpolated) = 0.160 W/kg

-Zoom Scan (7x7x7)/Cube 0: Measurement grid: dx=5mm, dy=5mm, dz=5mm

Reference Value = 5.875 V/m; Power Drift = -0.10 dB

Peak SAR (extrapolated) = 0.216 mW/g

SAR(1 g) = 0.110 mW/g; SAR(10 g) = 0.058 mW/g

Maximum value of SAR (measured) = 0.159 W/kg

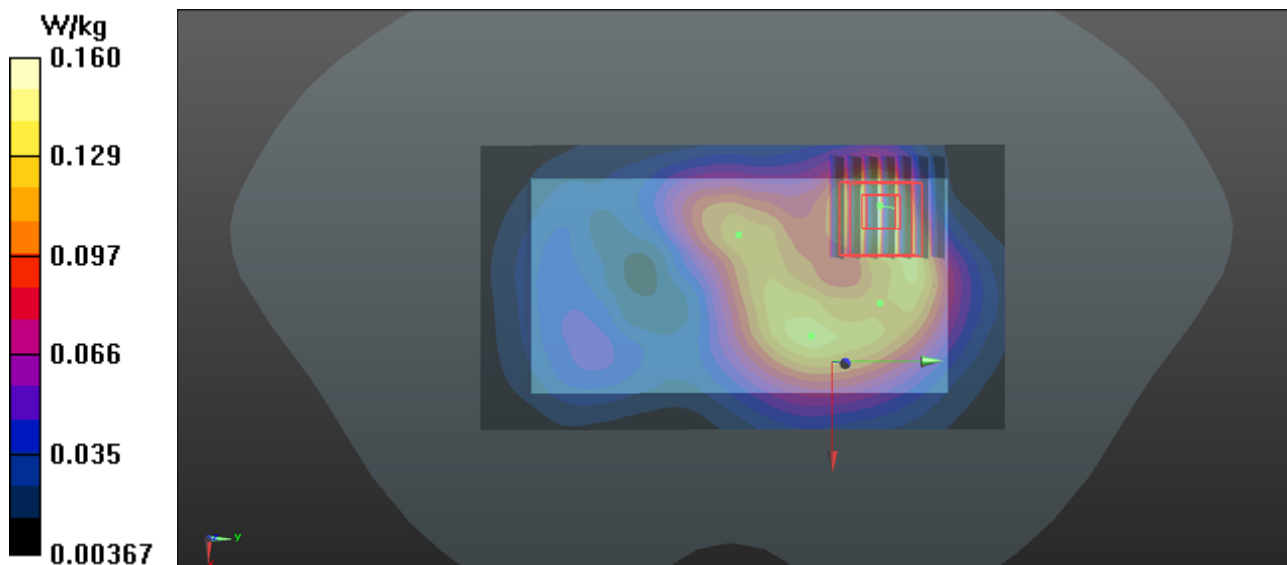

P11 GSM1900_GPRS12_Bottom Side_1cm_Ch661

DUT: 130723N027

Communication System: GPRS12; Frequency: 1880 MHz; Duty Cycle: 1:2

Medium: B1900-A_0805 Medium parameters used: $f = 1880$ MHz; $\sigma = 1.488$ mho/m; $\epsilon_r = 54.173$; $\rho = 1000$ kg/m³

Ambient Temperature : 21.3 °C; Liquid Temperature : 20.5 °C

DASY5 Configuration:

- Probe: EX3DV4 - SN3753; ConvF(7.33, 7.33, 7.33); Calibrated: 2013/01/17;
- Sensor-Surface: 2mm (Mechanical Surface Detection)
- Electronics: DAE4 Sn915; Calibrated: 2013/06/11
- Phantom: Right Phantom with CRP v5.0; Type: QD000P40CD; Serial: TP:1722
- Measurement SW: DASY52, Version 52.8 (2); SEMCAD X Version 14.6.6 (6824)

-Area Scan (61x101x1): Interpolated grid: dx=1.500 mm, dy=1.500 mm

Maximum value of SAR (interpolated) = 1.15 W/kg

-Zoom Scan (5x5x7)/Cube 0: Measurement grid: dx=8mm, dy=8mm, dz=5mm

Reference Value = 24.247 V/m; Power Drift = 0.14 dB

Peak SAR (extrapolated) = 1.44 W/kg

SAR(1 g) = 0.888 W/kg; SAR(10 g) = 0.504 W/kg

Maximum value of SAR (measured) = 1.20 W/kg

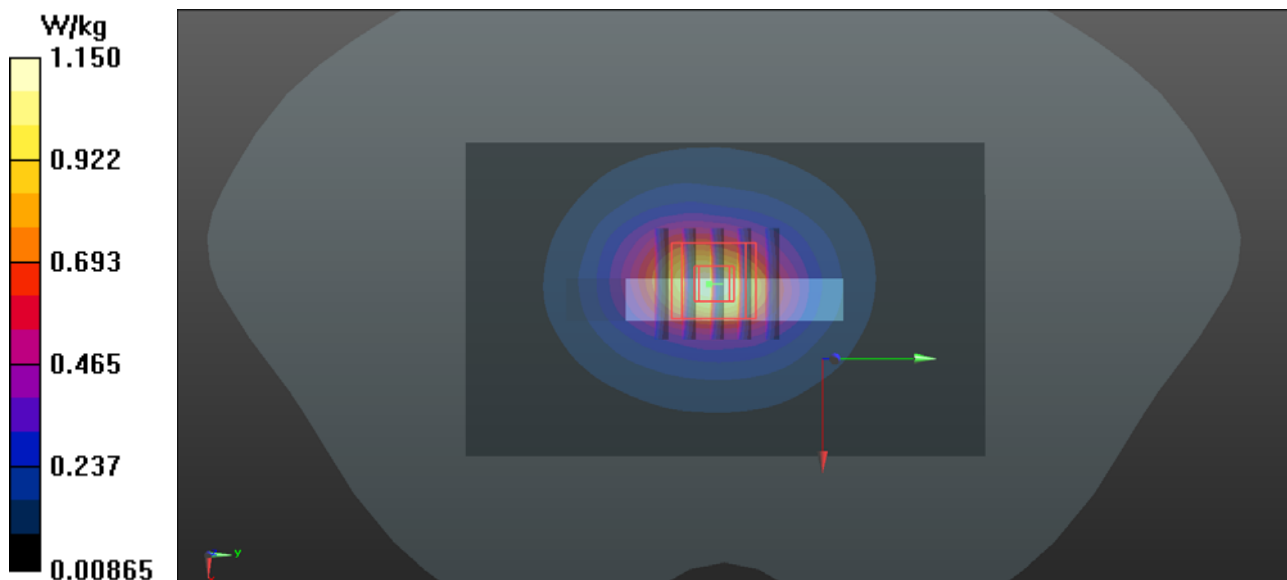

P12 WCDMA II_RMC12.2K_Bottom Side_1cm_Ch9538

DUT: 130723N027

Communication System: WCDMA; Frequency: 1907.6 MHz; Duty Cycle: 1:1

Medium: B1900-A_0805 Medium parameters used: $f = 1908$ MHz; $\sigma = 1.52$ mho/m; $\epsilon_r = 54.092$; $\rho = 1000$ kg/m³

Ambient Temperature : 21.3 °C ; Liquid Temperature : 20.5 °C

DASY5 Configuration:

- Probe: EX3DV4 - SN3753; ConvF(7.33, 7.33, 7.33); Calibrated: 2013/01/17;
- Sensor-Surface: 2mm (Mechanical Surface Detection)
- Electronics: DAE4 Sn915; Calibrated: 2013/06/11
- Phantom: Right Phantom with CRP v5.0; Type: QD000P40CD; Serial: TP:1722
- Measurement SW: DASY52, Version 52.8 (2); SEMCAD X Version 14.6.6 (6824)

-Area Scan (61x101x1): Interpolated grid: dx=1.500 mm, dy=1.500 mm

Maximum value of SAR (interpolated) = 1.01 W/kg

-Zoom Scan (5x5x7)/Cube 0: Measurement grid: dx=8mm, dy=8mm, dz=5mm

Reference Value = 23.172 V/m; Power Drift = 0.02 dB

Peak SAR (extrapolated) = 1.24 W/kg

SAR(1 g) = 0.758 W/kg; SAR(10 g) = 0.427 W/kg

Maximum value of SAR (measured) = 1.03 W/kg

