

**SGS-CSTC Standards
Technical Services
(Shanghai) Co., Ltd.**

588 West Jindu Road, Songjiang District, Shanghai, China

Telephone: +86 (0) 21 6191 5666
Fax: +86 (0) 21 6191 5655
Tino.Pan@sgs.com

Report No.:SHEMO10040047803
Page 1 of 38

TEST REPORT

Application No. : SHEMO10040047803
Applicant: Lenovo Mobile Communication Technology LTD.
FCC ID: YCNA332
Equipment Under Test (EUT):
Product Name: GSM Mobile
Brand Name: LENOVO
Model Name: A332
Standards: FCC part 2, 22H & 24E
Date of Receipt: April 29,2010
Date of Test: May 4,2010 to June 18,2010
Date of Issue: June 18,2010

Test Result :	PASS *
----------------------	---------------

* In the configuration tested, the EUT detailed in this report complied with the standards specified above. Please refer to section 2 of this report for further details.



Tino Pan
E&E Section Manager
SGS-CSTC(Shanghai) Co., Ltd.



San Yuan
Project Engineer
SGS-CSTC(Shanghai) Co., Ltd.

This document is issued by the Company subject to its General Conditions of Service printed overleaf, available on request or accessible at www.sgs.com/terms_and_conditions.htm and, for electronic format documents, subject to Terms and Conditions for Electronic Documents at www.sgs.com/terms_e-document.htm. Attention is drawn to the limitation of liability, indemnification and jurisdiction issues defined therein. Any holder of this document is advised that information contained hereon reflects the Company's findings at the time of its intervention only and within the limits of Client's instructions, if any. The Company's sole responsibility is to its Client and this document does not exonerate parties to a transaction from exercising all their rights and obligations under the transaction documents. This document cannot be reproduced except in full, without prior written approval of the Company. Any unauthorized alteration, forgery or falsification of the content or appearance of this document is unlawful and offenders may be prosecuted to the fullest extent of the law. Unless otherwise stated the results shown in this test report refer only to the sample(s) tested and such sample(s) are retained for 90 days only

**SGS-CSTC Standards
Technical Services
(Shanghai) Co., Ltd.**

ReportNo.: SHEMA10040047803
Page: 2 of 38

2 Test Summary

Description of Test	FCC Rules	Result
RF Power Output	2.1046(a) 22.913(a) 24.232(b)	Compliant
Occupied Bandwidth	2.1049(h)	Compliant
Effective Isotropic Radiated Power	2.1046(a) 22.913(a) 24.232(b)	Compliant
Out of Band Emissions at antenna Terminals and Band Edge	2.1051 22.917(a) 24.238(a)	Compliant
Field Strength of Spurious Emissions	2.1053 22.917(a) 24.238(a)	Compliant
Frequency Stability vs. Temperature and Voltage	2.1055	Compliant

3 Contents

	Page
1 COVER PAGE	1
2 TEST SUMMARY	2
3 CONTENTS	3
4 GENERAL INFORMATION	4
4.1 CLIENT INFORMATION	4
4.2 GENERAL DESCRIPTION OF E.U.T.	4
4.3 TEST LOCATION	4
4.4 TEST FACILITY	5
4.5 TEST METHODOLOGY	5
5 EQUIPMENTS USED DURING TEST	6
6 TEST RESULTS	8
6.1 E.U.T. TEST CONDITIONS	8
6.2 RF POWER OUTPUT	9
6.3 OCCUPIED BANDWIDTH	11
6.4 EFFECTIVE ISOTROPIC RADIATED POWER	15
6.5 OUT OF BAND EMISSIONS AT ANTENNA TERMINALS	18
6.5.1 <i>Band edges emissions</i>	18
6.6 FIELD STRENGTH OF RADIATED SPURIOUS EMISSIONS	27
6.7 FREQUENCY STABILITY V.S. TEMPERATURE MEASUREMENT	35
6.8 FREQUENCY STABILITY V.S. VOLTAGE MEASUREMENT	37

4 General Information

4.1 Client Information

Applicant: Lenovo Mobile Communication Technology LTD.
Address of Applicant: No.999,Qishan North 2nd Road,Information&Optoelectronics Park,Torch Hi-tech Industry Development Zone,Xiamen,P.R.China P.C:361006
Manufacturer: Lenovo Mobile Communication Technology LTD.
Address of Manufacturer: No.999,Qishan North 2nd Road,Information&Optoelectronics Park,Torch Hi-tech Industry Development Zone,Xiamen,P.R.China P.C:361006

4.2 General Description of E.U.T.

Product Name:	GSM Mobile
Brand Name:	LENOVO
Model Name:	A332
Power Supply:	3.7 V DC
Charger:	Model:C-P14 Input:AC100-240V 50/60Hz;Output:DC 5V,500mA

GSM:

	Operating frequency		Rated Power
Cellular phone standards Frequency Range and Power:	GSM 850	824.2MHz-848.8MHz	33dBm
	GSM 1900	1850.2MHz-1909.8MHz	30dBm
Hardware Version:	Q58_MB_V1.0		
Software Version:	a332_ve_s0003_100512		

4.3 Test Location

Tests were performed at:

SGS-CSTC Standards Technical Services Co., Ltd., Shanghai EMC Laboratory

588 West Jindu Road, Songjiang District, Shanghai, China

Tel: +86 21 61915666

Fax: +86 21 61915678

4.4 Test Facility

The test facility is recognized, certified, or accredited by the following organizations:

- **CNAS (No. CNAS L0599)**

CNAS has accredited SGS-CSTC Standards Technical Services (Shanghai) Co., Ltd. to ISO/IEC 17025:2005 General Requirements for the Competence of Testing and Calibration Laboratories (CNAS-CL01 Accreditation Criteria for the Competence of Testing and Calibration Laboratories) for the competence in the field of testing. Date of expiry: 2011-07-29.

- **FCC – Registration No.: 402683**

SGS-CSTC Standards Technical Services (Shanghai) Co., Ltd. has been registered and fully described in a report filed with the Federal Communications Commission (FCC). The acceptance letter from the FCC is maintained in our files. Registration No.: 402683, Expiry Date: 2012-03-17.

- **Industry Canada (IC) – IC Assigned Code: 8617A**

The 3m Semi-anechoic chamber of SGS-CSTC Standards Technical Services (Shanghai) Co., Ltd. has been registered by Certification and Engineering Bureau of Industry Canada for radio equipment testing with Registration No.: 8617A. Expiry Date: 2011-09-29.

- **VCCI (Member No.: 3061)**

The 3m Semi-anechoic chamber and Shielded Room of SGS-CSTC Standards Technical Services (Shanghai) Co., Ltd. has been registered in accordance with the Regulations for Voluntary Control Measures with Registration No.: R-3172 and C-3514 respectively. Date of Registration: 2009-11-30. Date of Expiry: 2012-03-17.

4.5 Test Methodology

Both conducted and radiated testing were performed according to the procedures document on TIA/EIA-603-C-2004 and FCC CFR 47 2.1046, 2.1047, 2.1049, 2.1051, 2.1053, 2.1055 and 2.1057.

**SGS-CSTC Standards
Technical Services
(Shanghai) Co., Ltd.**

ReportNo.: SHEMO10040047803
Page: 6 of 38

5 Equipments Used during Test

Item	Test Equipment	Manufacturer	Model No.	Serial No.	Cal. Date	Cal. Due date
1	Spectrum Analyzer	Rohde & Schwarz	FSP-30	100324	2010-4-19	2011-4-18
2	EMI test receiver	Rohde & Schwarz	ESU40	100109	2010-6-3	2011-6-2
4	Horn Antenna	Rohde & Schwarz	HF906	100284	2010-4-9	2011-4-8
5	Horn Antenna	Rohde & Schwarz	HF906	100285	2009-10-9	2010-10-8
6	ANTENNA	SCHWARZBECK	BBHA9120D	9120D-679	2010-6-3	2011-6-2
7	Ultra broadband antenna	Rohde & Schwarz	HL562	100227	2009-10-09	2010-10-08
8	Atmosphere pressure meter	Shanghai ZhongXuan Electronic Co;Ltd	BY—2003P	--	2009-10-15	2010-10-14
9	CLAMP METER	FLUKE	316	86080010	2010-04-28	2011-04-27
10	Thermo-Hygrometer	ZHICHEN	ZC1-2	01050033	2009-10-21	2010-10-20
11	Digital illuminance meter	TES electrical electronic Corp.	TES-1330A	050602219	2009-10-16	2010-10-15
12	TEMPERATURE& HUMIDITY BOX	KSON	THS-D2C-100	K40723	2009-11-18	2010-11-17
13	High-low temperature cabinet	Shanghai YuanZhen	GW2050	--	2009-6-27	2010-6-26
14	DC power	KIKUSUI	PMC35—3	NF100260	2010-1-16	2011-1-15
15	Power meter	Rohde & Schwarz	NRP	101641	2010-5-4	2011-5-3
16	UNIVERSAL RADIO COMMUNICATION TESTER	Rohde & Schwarz	CMU 200	112012	2009-08-25	2010-08-24
17	Tunable Notch Filter	WRCT800.0/880.0-0.2/40-5SSK	Wainwright instruments GmbH	9	2010-1-27	2011-1-26
18	Tunable Notch Filter	WRCT1800.0/2000.0-0.2/40-5SSK	Wainwright instruments GmbH	11	2010-1-27	2011-1-26

This document is issued by the Company subject to its General Conditions of Service printed overleaf, available on request or accessible at www.sgs.com/terms_and_conditions.htm and, for electronic format documents, subject to Terms and Conditions for Electronic Documents at www.sgs.com/terms_e-document.htm. Attention is drawn to the limitation of liability, indemnification and jurisdiction issues defined therein. Any holder of this document is advised that information contained hereon reflects the Company's findings at the time of its intervention only and within the limits of Client's instructions, if any. The Company's sole responsibility is to its Client and this document does not exonerate parties to a transaction from exercising all their rights and obligations under the transaction documents. This document cannot be reproduced except in full, without prior written approval of the Company. Any unauthorized alteration, forgery or falsification of the content or appearance of this document is unlawful and offenders may be prosecuted to the fullest extent of the law. Unless otherwise stated the results shown in this test report refer only to the sample(s) tested and such sample(s) are retained for 90 days only

**SGS-CSTC Standards
Technical Services
(Shanghai) Co., Ltd.**

ReportNo.: SHEMA10040047803

Page: 7 of 38

19	Band Reject Filter	WRCG 824/849-814/859-40/8SS	Amiden,Ireland	1	2010-1-27	2011-1-26
20	Band Reject Filter	WRCG 1850/1910-1835/1925-40/8SS	Amiden,Ireland	13	2010-1-27	2011-1-26

6 Test Results

6.1 E.U.T. test conditions

Power supply: DC 3.7V
Operating Environment:
Temperature: 20.0 -25.0 °C
Humidity: 38-48 % RH
Atmospheric Pressure: 992 -1006 mbar
Configuration of
Tested System:



Remote Side

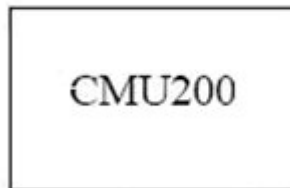

6.2 RF Power Output

Test Requirement: Part 2.1046
Part 22.913(a) Mobile station are limited to 7W
Part 24.232(b) Peak power measurement, Mobile station are limited to 2W

Test Setup

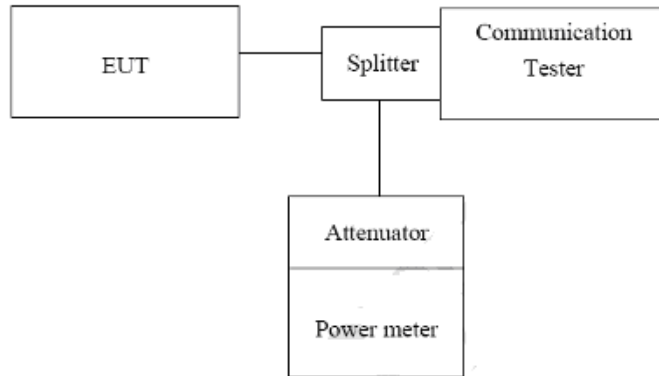

Measurement Setup for testing on Antenna connector.

Test Date: May 19,2010
Test Status: Test lowest, middle, highest channel.
Test Procedure:

The transmitter output was connected to calibrated attenuator, the other end of which was connected to a power meter. Transmitter output was read off the power in dBm. The power output at the transmitter antenna port was determined by adding the value of attenuator to the power meter reading.

**SGS-CSTC Standards
Technical Services
(Shanghai) Co., Ltd.**

ReportNo.: SHEMO10040047803
Page: 10 of 38

Measurement Result:

RF Conducted output power

Result:

EUT Mode	Frequency (MHz)	Ch	1 Time Slot		2 Time Slot	
			Peak power (dBm)	AV power (dBm)	Peak power (dBm)	AV power (dBm)
GSM 850 (GMSK)	824.2	128	31.9	31.8	31.9	31.8
	836.6	190	32.1	32.0	32.1	31.9
	848.8	251	31.8	31.5	31.8	31.5

EUT Mode	Frequency (MHz)	Ch	1 Time Slot		2 Time Slot	
			Peak power (dBm)	AV power (dBm)	Peak power (dBm)	AV power (dBm)
PCS 1900 (GMSK)	1850.2	512	29.1	29.0	29.1	29.0
	1880.0	661	29.3	29.2	29.3	29.1
	1909.8	810	29.2	29.1	29.2	29.0

6.3 Occupied Bandwidth

Test Requirement: Part 2.1049
 Test Date: May 20,2010
 Test Status: Test lowest, middle, highest channel.
 Test Procedure:

The EUT output RF connector was connected with a short a cable to the spectrum analyzer, RBW was set to about 1% of emission BW, VBW \geq 3 times RBW, 99% bandwidth were measured, the occupied bandwidth is the delta frequency between the two points where the display line intersects the signal trace.

Test result:

99% Occupied Bandwidth

EUT Mode	Frequency (MHz)	CH	99% Bandwidth (MHz)
GSM 850	824.2	128	0.2500
	836.6	190	0.2468
	848.8	251	0.2468

99% Occupied Bandwidth

EUT Mode	Frequency (MHz)	CH	99% Bandwidth (MHz)
PCS 1900	1850.2	512	0.2452
	1880.0	661	0.2468
	1909.8	810	0.2452

**SGS-CSTC Standards
Technical Services
(Shanghai) Co., Ltd.**

ReportNo.: SHEMO10040047803
Page: 12 of 38

99% Bandwidth

GSM 850 Channel Low

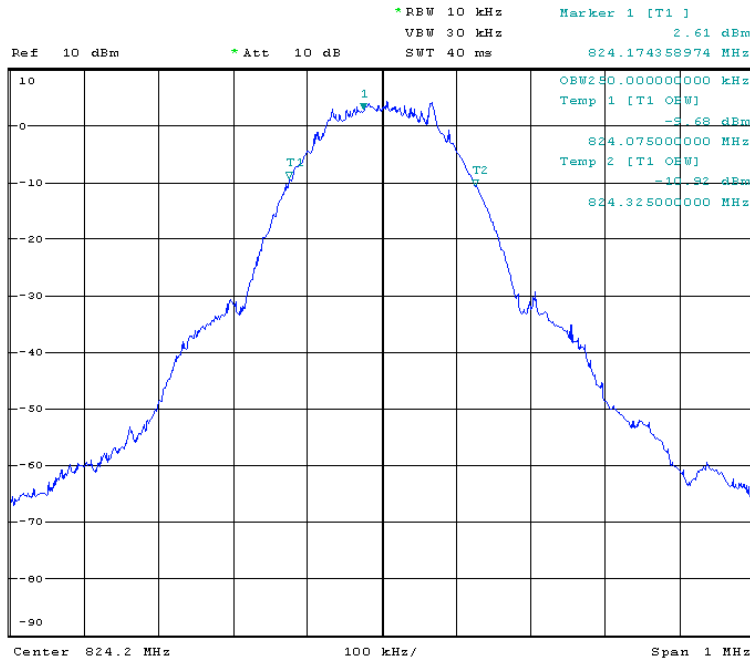

GSM 850 Channel Mid

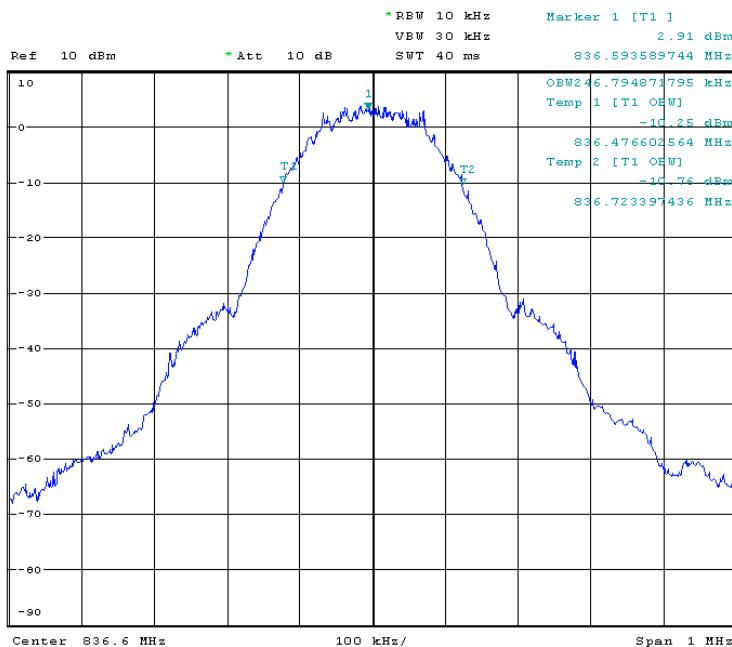

**SGS-CSTC Standards
Technical Services
(Shanghai) Co., Ltd.**

ReportNo.: SHEMA10040047803
Page: 13 of 38

GSM 850 Channel High

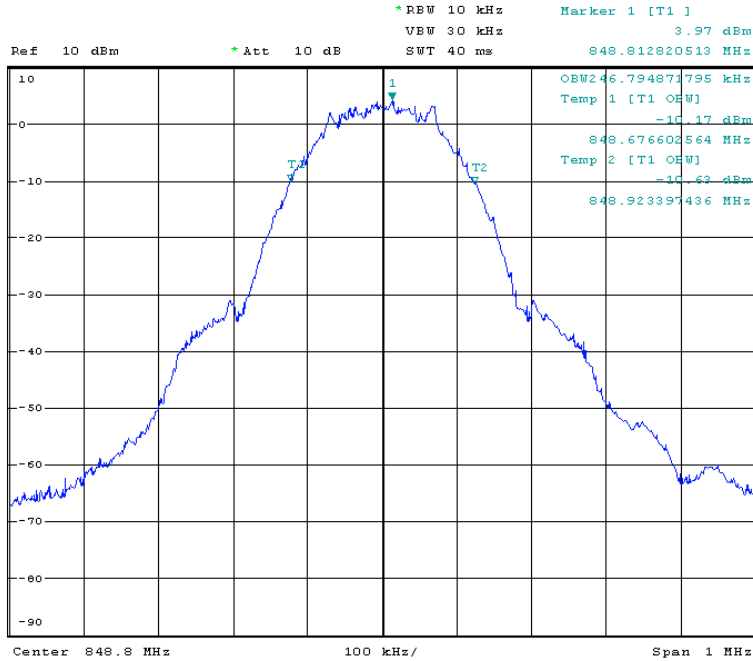

99% Bandwidth

PCS 1900 Channel Low

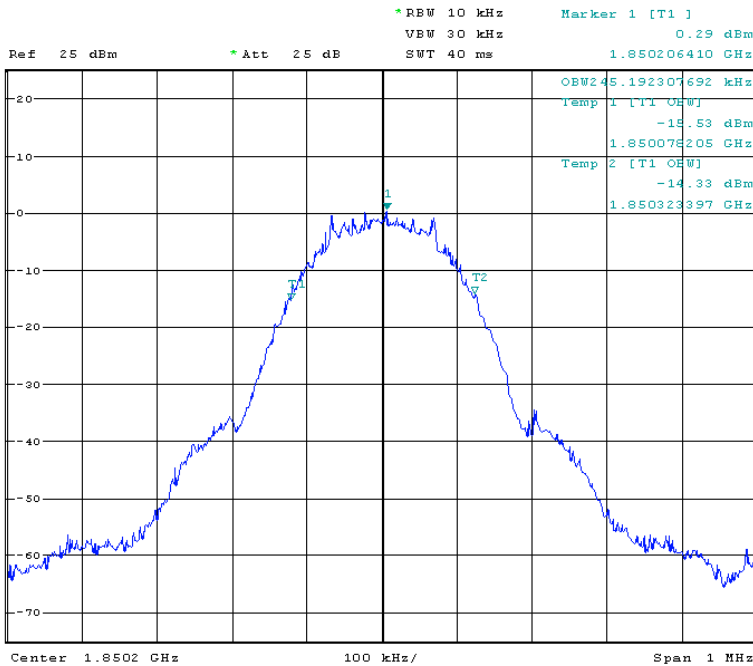

This document is issued by the Company subject to its General Conditions of Service printed overleaf, available on request or accessible at www.sgs.com/terms_and_conditions.htm and, for electronic format documents, subject to Terms and Conditions for Electronic Documents at www.sgs.com/terms_e-document.htm. Attention is drawn to the limitation of liability, indemnification and jurisdiction issues defined therein. Any holder of this document is advised that information contained hereon reflects the Company's findings at the time of its intervention only and within the limits of Client's instructions, if any. The Company's sole responsibility is to its Client and this document does not exonerate parties to a transaction from exercising all their rights and obligations under the transaction documents. This document cannot be reproduced except in full, without prior written approval of the Company. Any unauthorized alteration, forgery or falsification of the content or appearance of this document is unlawful and offenders may be prosecuted to the fullest extent of the law. Unless otherwise stated the results shown in this test report refer only to the sample(s) tested and such sample(s) are retained for 90 days only

**SGS-CSTC Standards
Technical Services
(Shanghai) Co., Ltd.**

ReportNo.: SHEMA10040047803
Page: 14 of 38

PCS 1900 Channel Mid

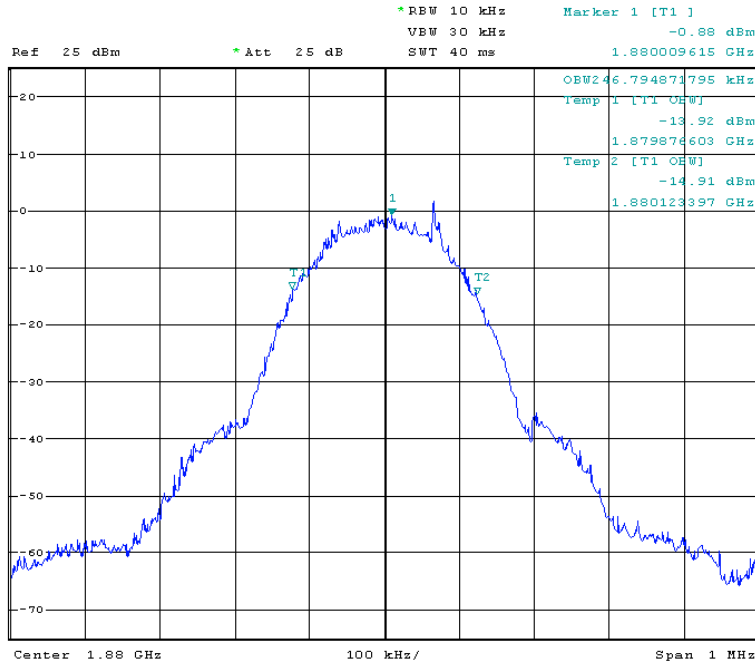

PCS 1900 Channel High

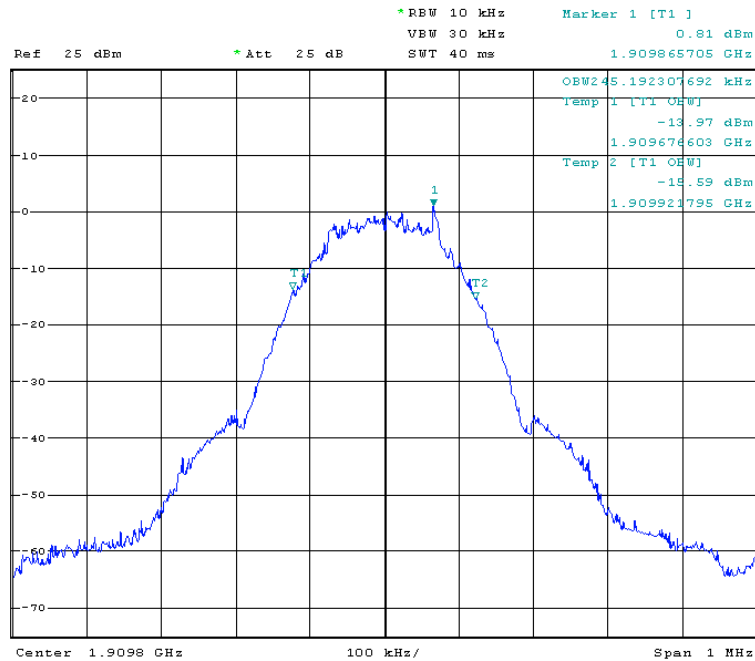

6.4 Effective Isotropic Radiated Power

Test Requirement: Part 2.1046
Part 22.913(a) Mobile station are limited to 7W ERP.
Part 24.232(b) Mobile station are Limited to 2W EIRP.

Test Date: June 18,2010

Test Setup:

(A) Radiated emission Test setup, Below Frequency 1000MHz:

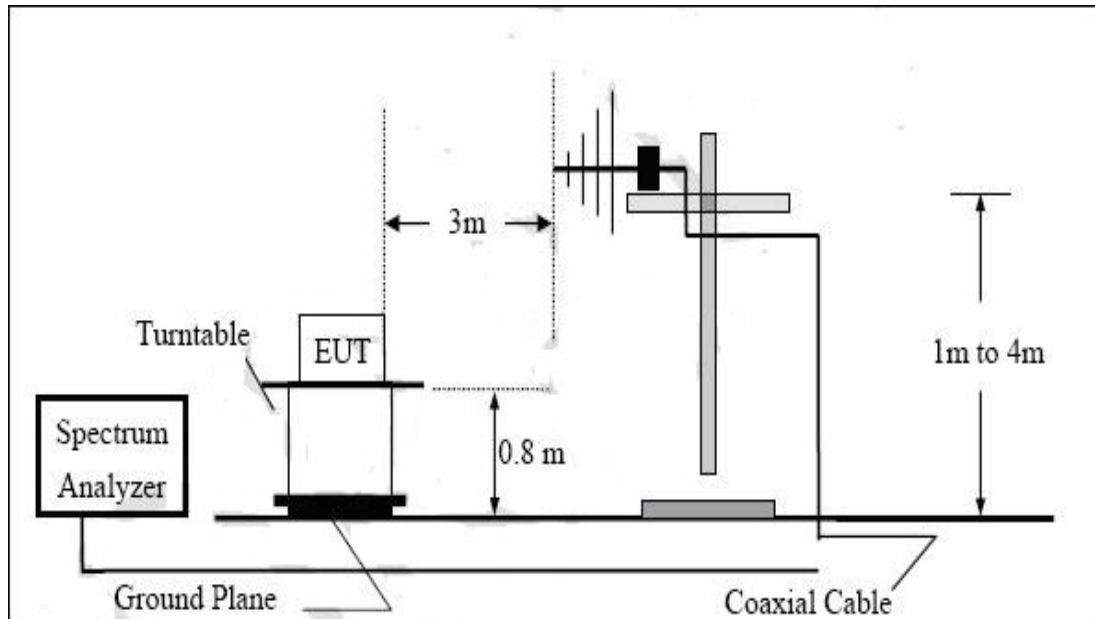

(B) Radiated emission Test setup frequency over 1GHz:

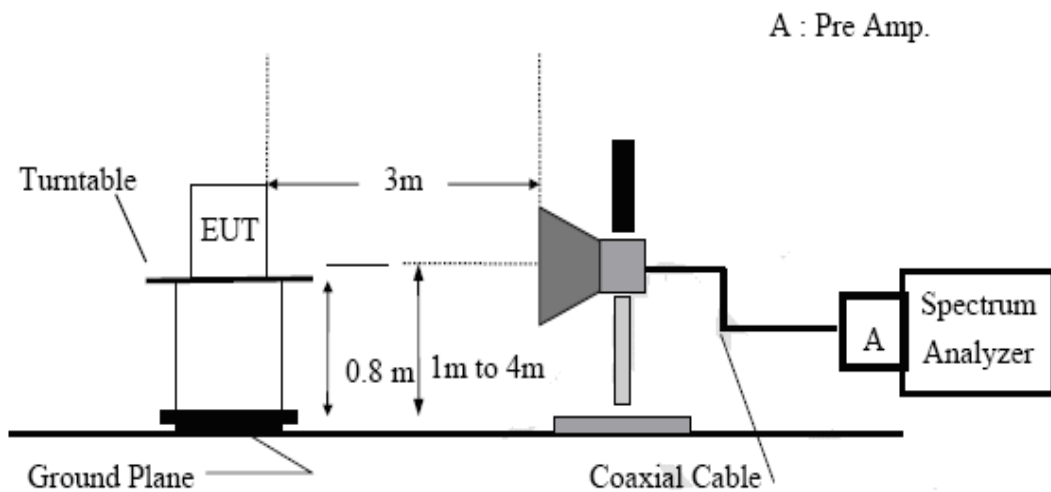

(C) Substituted Method Test setup:

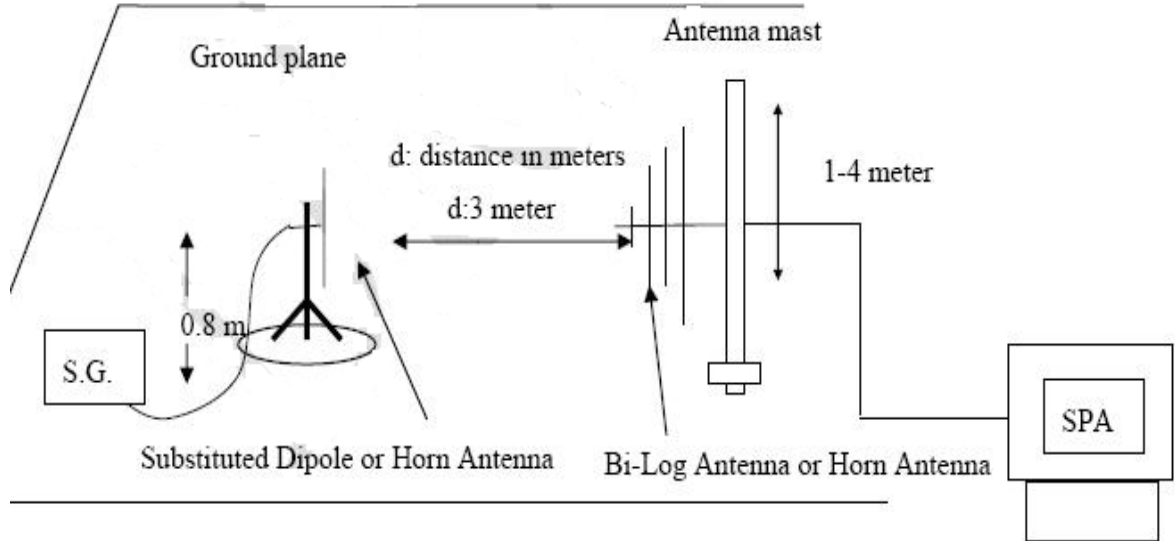

Test Procedure:

The EUT was placed on a non-conductive turntable using a non-conductive support. The radiated emission at the fundamental frequency was measured at 3 m with a test antenna and EMI spectrum analyzer. During the measurement, the EUT was communication with the station. The highest emission was recorded with the rotation of the turntable and lowering of the test antenna from 4m to 1m. The reading was recorded and the field strength(E in dBuV/m) was calculated.

ERP in frequency band 824.2-848.8MHz were measured using substitution method. The EUT was replaced by dipole antenna connected, the S.G. output was recorded and ERP was calculated as follow:

EIRP in frequency band 1850.2-1909.8MHz were measured using a substitution method. The EUT was replaced by a horn antenna connected, the S.G. output was recorded and EIRP was calculated as follows:

$$ERP = \text{S.G. output (dBm)} + \text{Antenna Gain (dBd)} - \text{Cable Loss (dB)}$$

$$EIRP = \text{S.G. output (dBm)} + \text{Antenna Gain (dBi)} - \text{Cable Loss (dB)}$$

**SGS-CSTC Standards
Technical Services
(Shanghai) Co., Ltd.**

ReportNo.: SHEMO10040047803
Page: 17 of 38

Measurement result:

- (1) The RBW, VBW of SPA for frequency
Below 1GHz was RBW=300KHz, VBW=1MHz;
Above 1GHz was RBW=1MHz, VBW=3MHz

EUT mode	Frequen cy(MHz)	CH	EUT Pol.	Antenna Pol.	SPA Reading (dBuV)	S.G. output (dBm)	Antenna Gain (dBd)	Cable loss (dB)	ERP (dBm)	Limit (dBm)
GSM 850	824.2	128	H	V	104.34	23.05	8.4	2.89	28.56	38.45
				H	102.82	21.6	8.4	2.89	27.11	38.45
	836.6	190	H	V	104.76	22.93	8.45	2.93	28.45	38.45
				H	103.11	22.03	8.45	2.93	27.55	38.45
	848.8	251	H	V	104.45	23.22	8.76	2.97	29.01	38.45
				H	102.55	21.07	8.76	2.97	26.86	38.45

EUT mode	Frequen cy(MHz)	CH	EUT Pol.	Antenna Pol.	SPA Reading (dBuV)	S.G. output (dBm)	Antenna Gain (dBi)	Cable loss (dB)	EIRP (dBm)	Limit (dBm)
PCS 1900	1850.2	512	H	V	100.33	24.28	7.05	4.45	26.88	33
				H	99.44	22.96	7.05	4.45	25.56	33
	1880.0	661	H	V	99.97	23.47	7.13	4.57	26.03	33
				H	98.53	22.68	7.13	4.57	25.24	33
	1909.8	810	H	V	100.11	24.01	7.25	4.48	26.78	33
				H	97.88	21.35	7.25	4.48	24.12	33

6.5 Out of band emissions at antenna Terminals

6.5.1 Band edges emissions

Test Requirement: Part 2.1051

FCC part 22.917(a), 24.238(a) the magnitude of each spurious and harmonic emission that can be detected when the equipment is operated under the conditions specification in the instruction manual and/or alignment procedure, shall not be less than $43+10\log(\text{Mean power in watts})$ dBc below the mean power output outside a license's frequency block(-13dBm).

Test Date: May 20,2010

Test Procedure:

The RF output of the transceiver was connected to a spectrum analyzer through appropriate attenuation. The resolution bandwidth of spectrum analyzer was set at 1MHz, sufficient scans were taken to show the out of band Emission is any up to 10th harmonic.

For the out of band: set RBW, VBW=1MHz, stat=30MHz, stop= 10 th harmonic. Limit= -13dBm

Band Edge requirements: In 1Mhz bands immediately outside and adjacent to the frequency block, a resolution bandwidth of at least 1 % of bandwidth of fundamental emission of the transmitter any be employed to measure the out of band emission. Limit=-13dBm.

SGS-CSTC Standards Technical Services (Shanghai) Co., Ltd.

ReportNo.: SHEMA10040047803
Page: 19 of 38

Measurement result: GSM 850 Channel Low

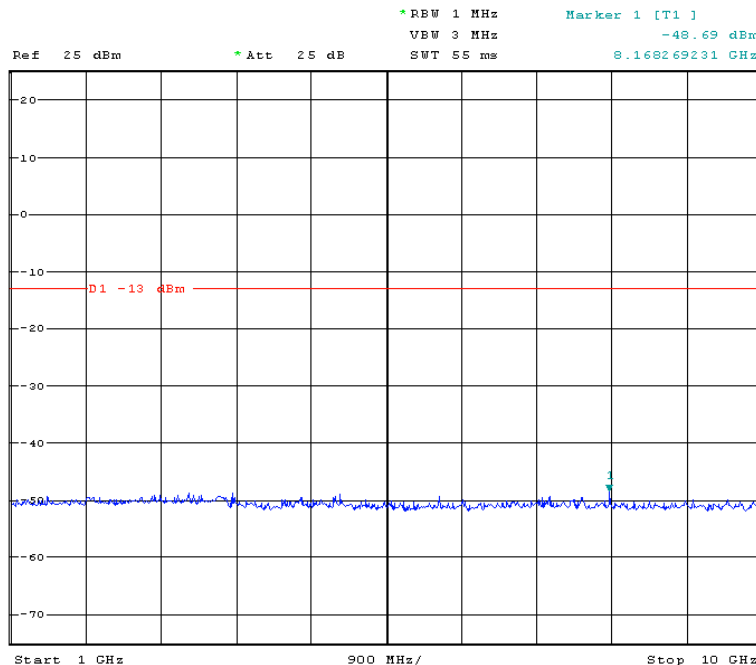
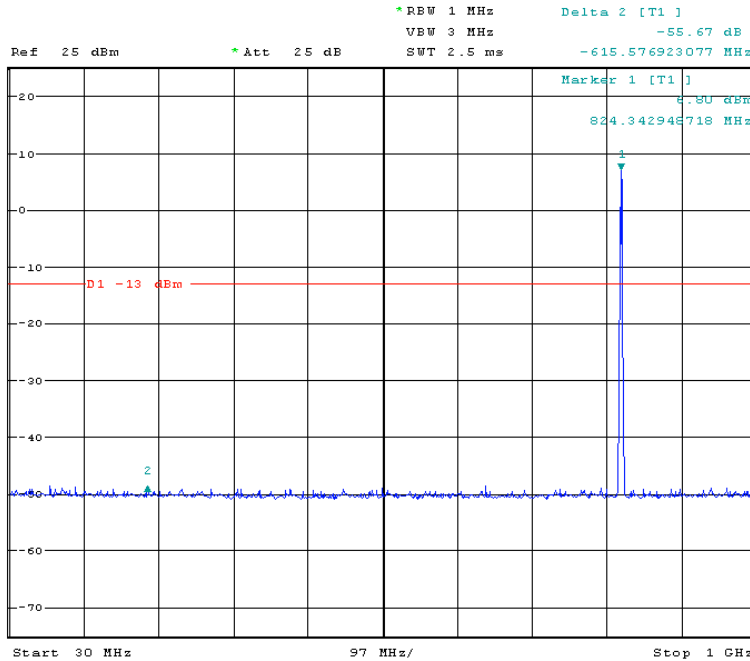

This document is issued by the Company subject to its General Conditions of Service printed overleaf, available on request or accessible at www.sgs.com/terms_and_conditions.htm and, for electronic format documents, subject to Terms and Conditions for Electronic Documents at www.sgs.com/terms_e-document.htm. Attention is drawn to the limitation of liability, indemnification and jurisdiction issues defined therein. Any holder of this document is advised that information contained hereon reflects the Company's findings at the time of its intervention only and within the limits of Client's instructions, if any. The Company's sole responsibility is to its Client and this document does not exonerate parties to a transaction from exercising all their rights and obligations under the transaction documents. This document cannot be reproduced except in full, without prior written approval of the Company. Any unauthorized alteration, forgery or falsification of the content or appearance of this document is unlawful and offenders may be prosecuted to the fullest extent of the law. Unless otherwise stated the results shown in this test report refer only to the sample(s) tested and such sample(s) are retained for 90 days only

**SGS-CSTC Standards
Technical Services
(Shanghai) Co., Ltd.**

ReportNo.: SHEMA10040047803
Page: 20 of 38

GSM 850 Channel Mid

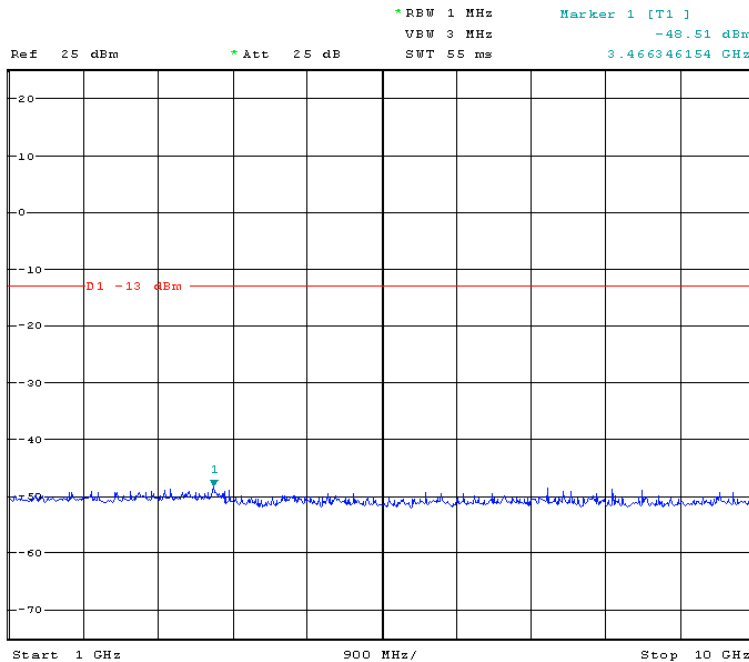
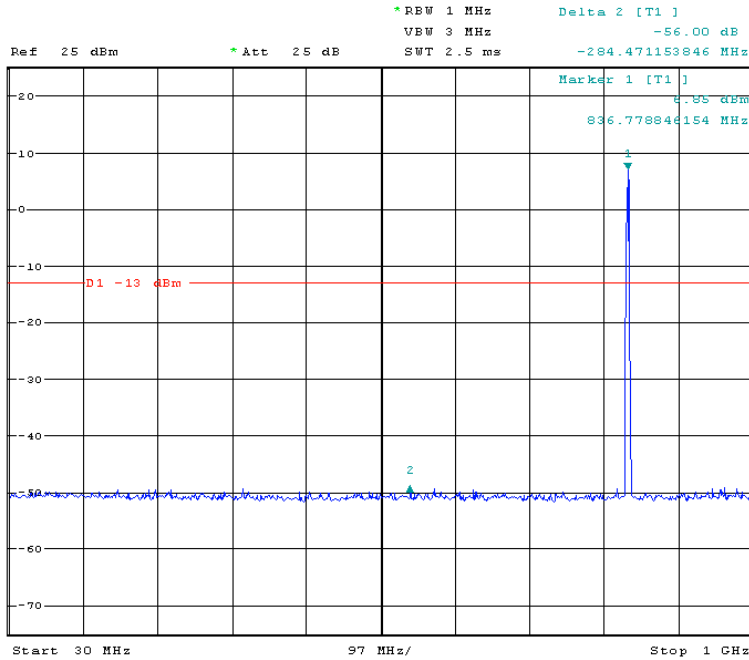

This document is issued by the Company subject to its General Conditions of Service printed overleaf, available on request or accessible at www.sgs.com/terms_and_conditions.htm and, for electronic format documents, subject to Terms and Conditions for Electronic Documents at www.sgs.com/terms_e-document.htm. Attention is drawn to the limitation of liability, indemnification and jurisdiction issues defined therein. Any holder of this document is advised that information contained hereon reflects the Company's findings at the time of its intervention only and within the limits of Client's instructions, if any. The Company's sole responsibility is to its Client and this document does not exonerate parties to a transaction from exercising all their rights and obligations under the transaction documents. This document cannot be reproduced except in full, without prior written approval of the Company. Any unauthorized alteration, forgery or falsification of the content or appearance of this document is unlawful and offenders may be prosecuted to the fullest extent of the law. Unless otherwise stated the results shown in this test report refer only to the sample(s) tested and such sample(s) are retained for 90 days only

SGS-CSTC Standards
Technical Services
(Shanghai) Co., Ltd.

ReportNo.: SHEMA10040047803
Page: 21 of 38

GSM 850 Channel High

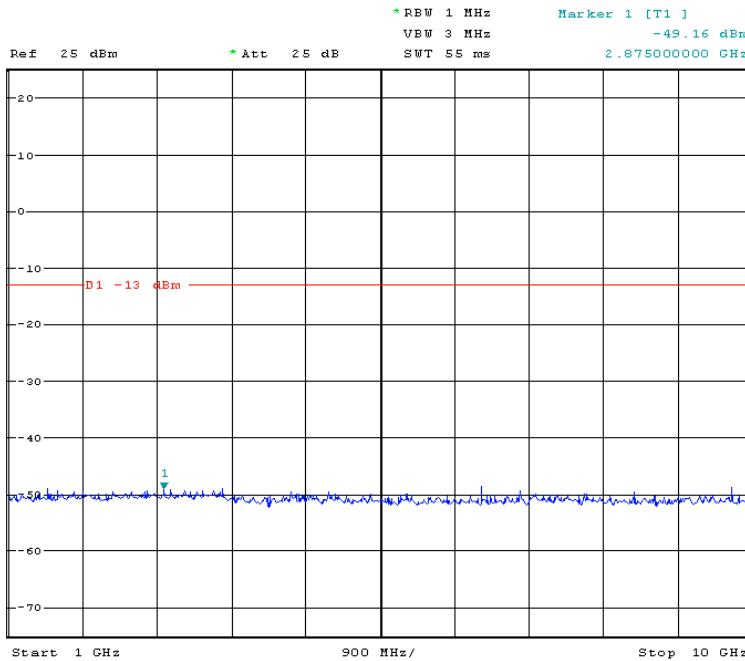
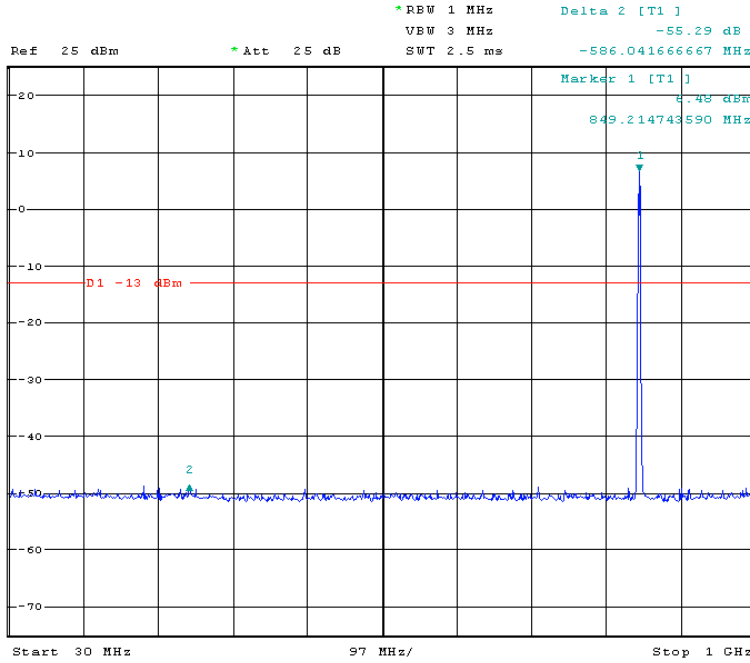

Band Edge emission GSM 850 Channel Low

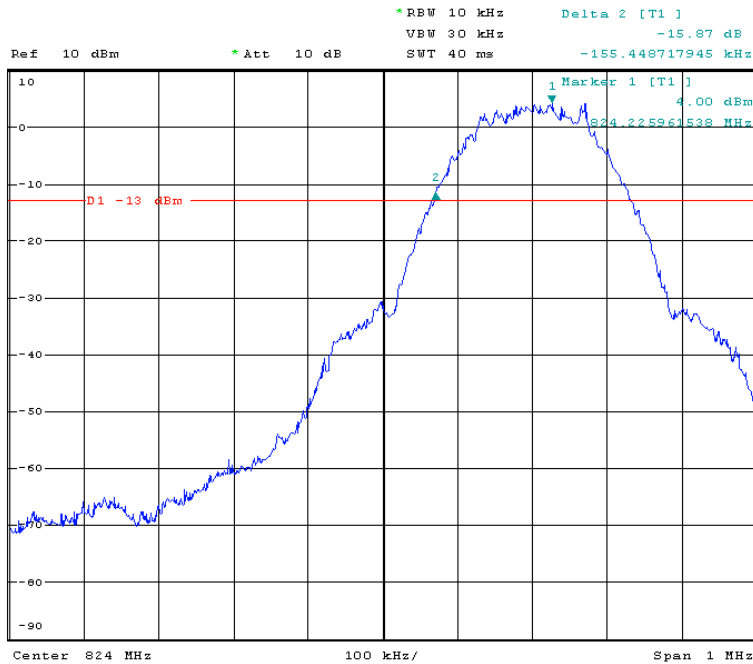

Band Edge emission GSM 850 Channel high

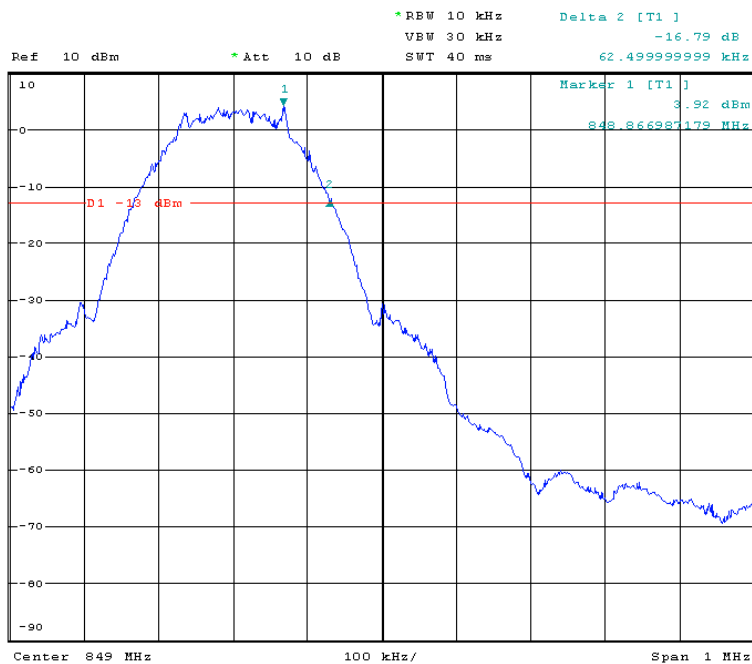

**SGS-CSTC Standards
Technical Services
(Shanghai) Co., Ltd.**

ReportNo.: SHEMA10040047803
Page: 23 of 38

PCS 1900 Channel Low

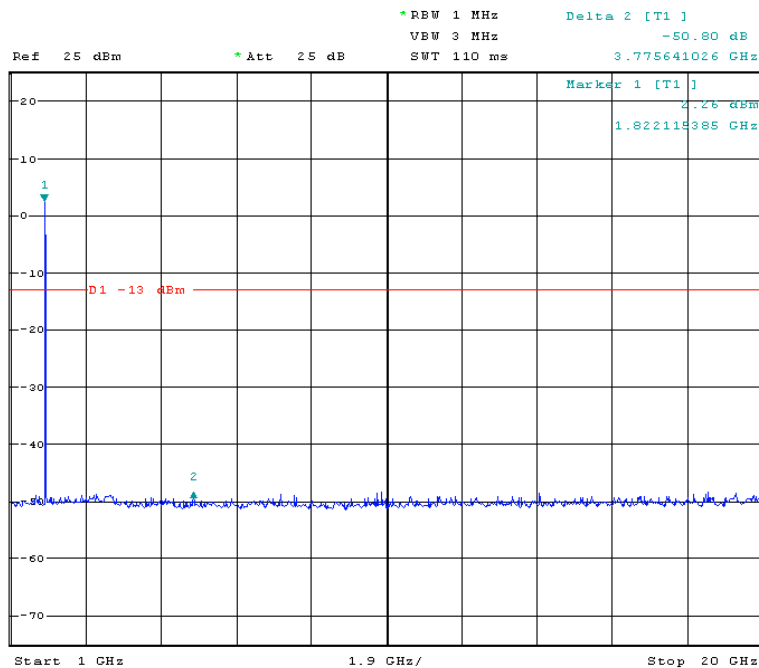
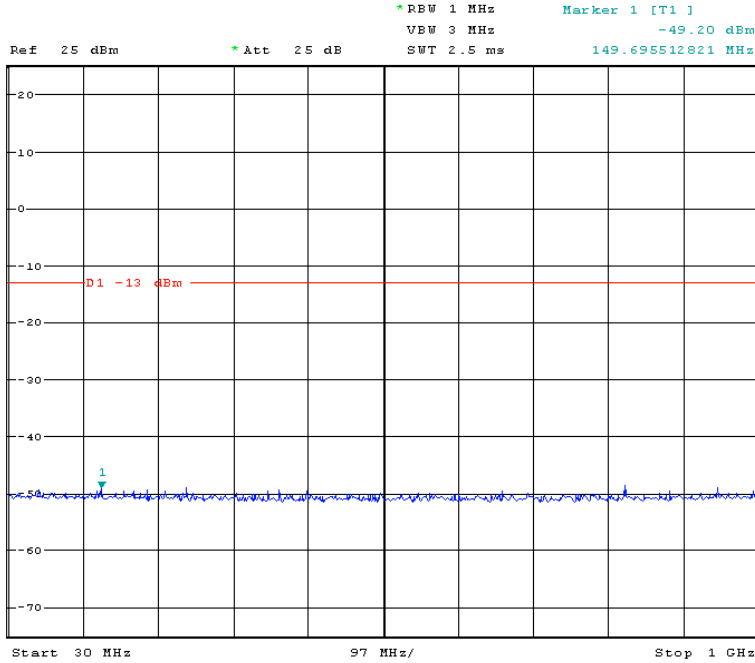

**SGS-CSTC Standards
Technical Services
(Shanghai) Co., Ltd.**

ReportNo.: SHEMO10040047803
Page: 25 of 38

PCS 1900 Channel High

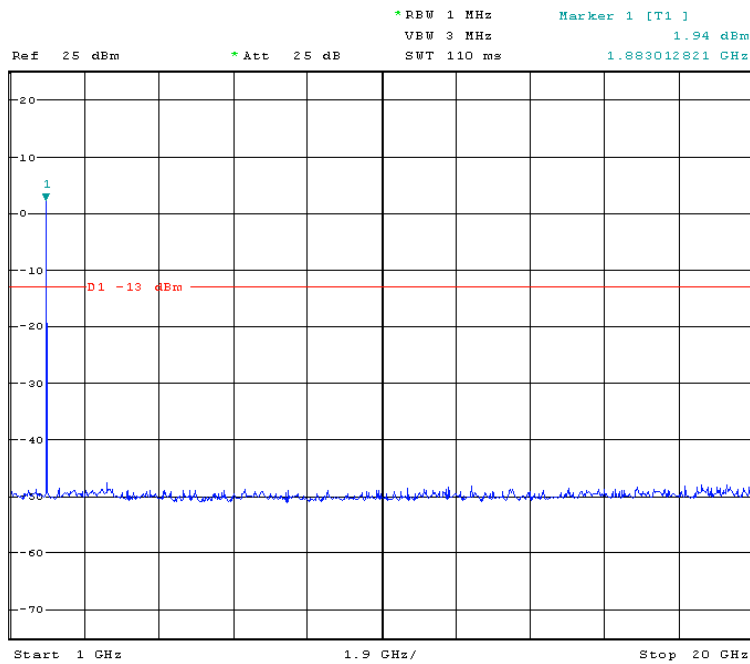
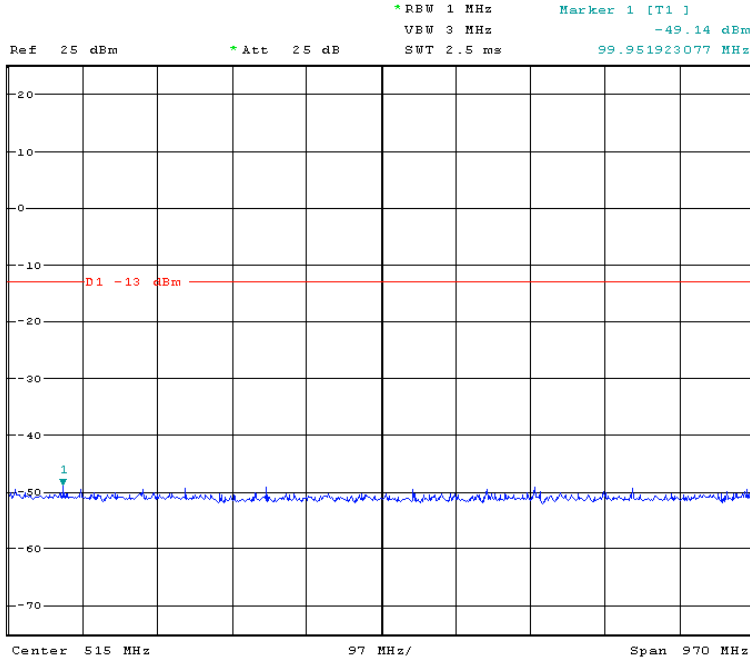

This document is issued by the Company subject to its General Conditions of Service printed overleaf, available on request or accessible at www.sgs.com/terms_and_conditions.htm and, for electronic format documents, subject to Terms and Conditions for Electronic Documents at www.sgs.com/terms_e-document.htm. Attention is drawn to the limitation of liability, indemnification and jurisdiction issues defined therein. Any holder of this document is advised that information contained hereon reflects the Company's findings at the time of its intervention only and within the limits of Client's instructions, if any. The Company's sole responsibility is to its Client and this document does not exonerate parties to a transaction from exercising all their rights and obligations under the transaction documents. This document cannot be reproduced except in full, without prior written approval of the Company. Any unauthorized alteration, forgery or falsification of the content or appearance of this document is unlawful and offenders may be prosecuted to the fullest extent of the law. Unless otherwise stated the results shown in this test report refer only to the sample(s) tested and such sample(s) are retained for 90 days only

Band Edge emission PCS 1900 Channel Low

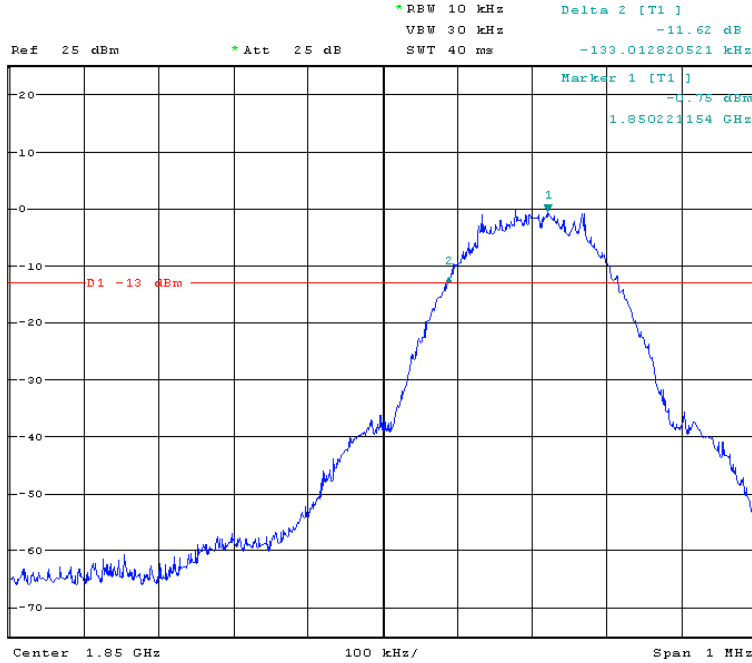

Band Edge emission PCS 1900 Channel high



6.6 Field Strength of Radiated Spurious Emissions

Test Requirement: Part 2.1053

FCC part 22.917(a), 24.238(a) the magnitude of each spurious and harmonic emission that can be detected when the equipment is operated under the conditions specification in the instruction manual and/or alignment procedure, shall not be less than $43+10\log(\text{Mean power in watts})$ dBc below the mean power output outside a license's frequency block(-13dBm).

Test Date: June 18,2010

Test Setup:

(A) Radiated emission Test setup, Below Frequency 1000MHz:

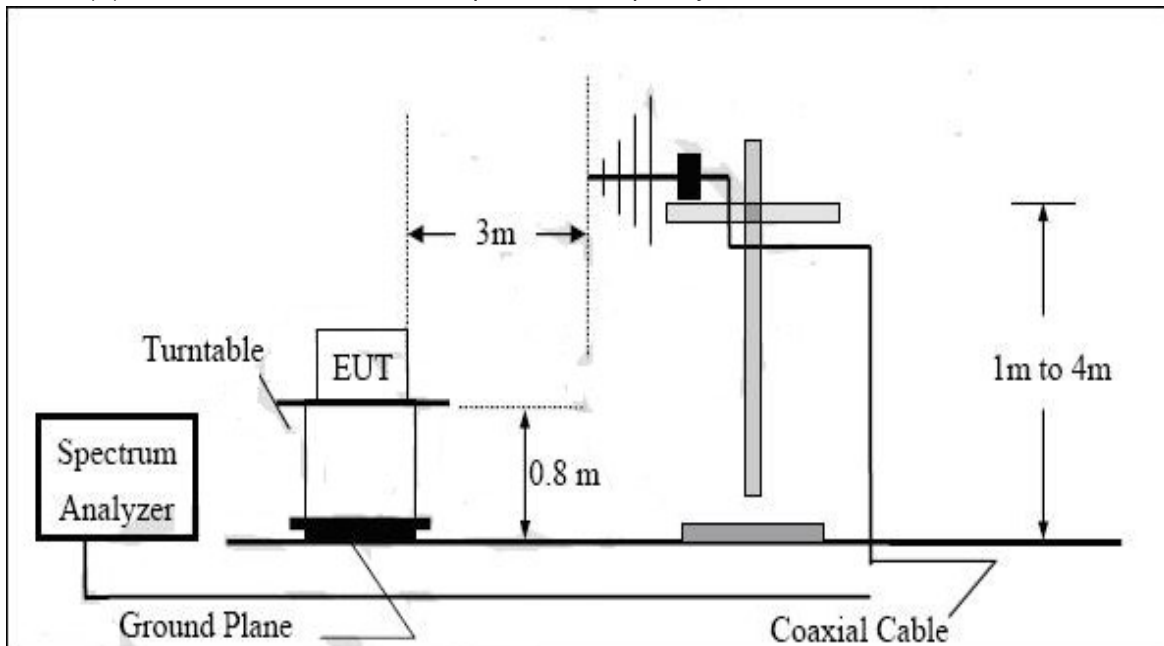

(B) Radiated emission Test setup frequency over 1GHz:

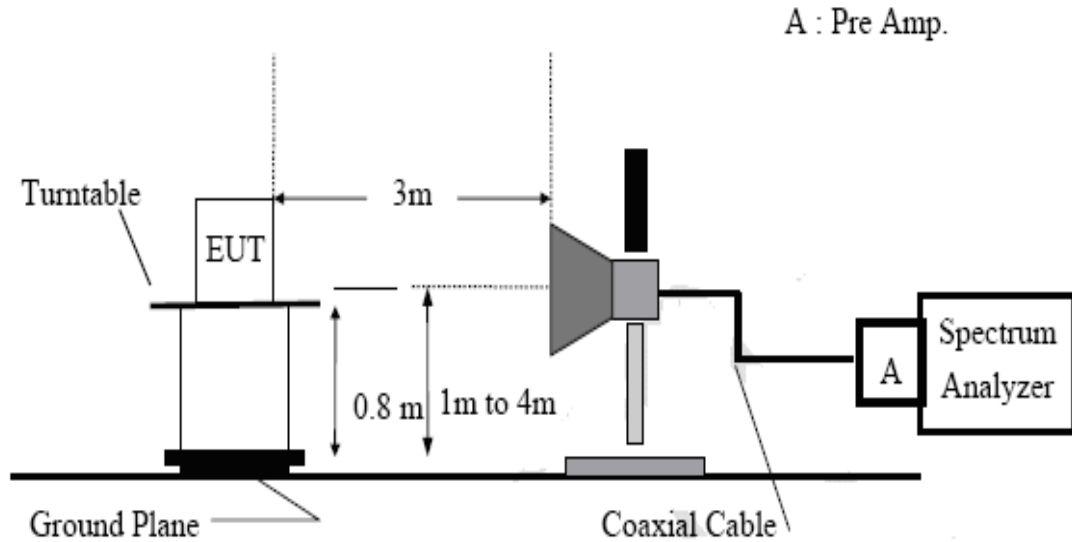

(C) Substituted Method Test setup:

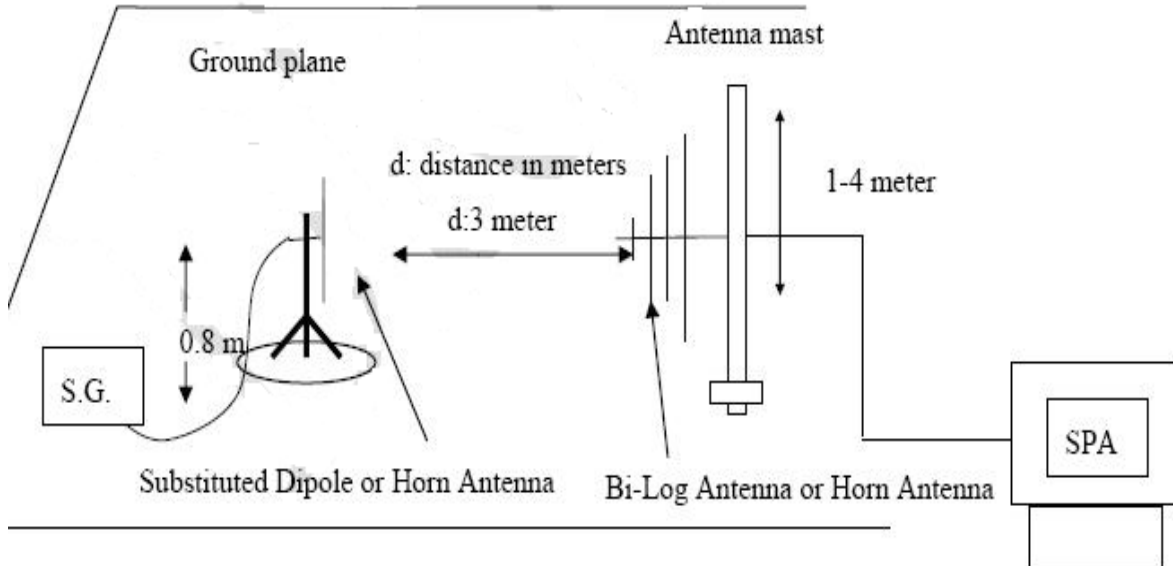

Test Procedure:

The EUT was placed on a non-conductive turntable using a non-conductive support. The radiated emission at the fundamental frequency was measured at 3 m with a test antenna and EMI spectrum analyzer. During the measurement, the EUT was communication with the station. The highest

**SGS-CSTC Standards
Technical Services
(Shanghai) Co., Ltd.**

ReportNo.: SHEMO10040047803
Page: 29 of 38

emission was recorded with the rotation of the turntable and lowering of the test antenna from 4m to 1m.

ERP in frequency band 824.2-848.8MHz were measured using substitution method. The EUT was replaced by dipole antenna connected, the S.G. output was recorded and ERP was calculated as follow:

EIRP in frequency band 1850.5-1909.8MHz were measured using a substitution method. The EUT was replaced by a horn antenna connected, the S.G. output was recorded and EIRP was calculated as follows:

$$\text{ERP} = \text{S.G. output (dBm)} + \text{Antenna Gain (dBd)} - \text{Cable Loss (dB)}$$

$$\text{EIRP} = \text{S.G. output (dBm)} + \text{Antenna Gain (dBi)} - \text{Cable Loss (dB)}$$

Radiated spurious Emission Measurement Result: GSM 850 mode

Operation mode: TX CH Low mode

Fundamental Frequency: 824.2MHz

Frequency (MHz)	Ant.Pol. H/V	S.G Output (dBm)	Antenna Gain (dBd)	Cable Loss (dB)	ERP (dBm)	Limit (dBm)	Safe Margin (dB)
100	H	-58.15	2.6	1	-56.55	-13	43.55
200	H	-64.86	9.1	1.42	-57.18	-13	44.18
800	H	-64.87	8.7	2.86	-59.03	-13	46.03
1648.4	H	-53.65	6.95	4.17	-50.87	-13	37.87
2472.6	H	-54.28	8.35	5.24	-51.17	-13	38.17
3201.7	H	-51.97	8.15	6.11	-49.93	-13	36.93
4147.1	H	-50.87	8.45	6.94	-49.36	-13	36.36
100	V	-57.72	2.6	1	-56.12	-13	43.12
200	V	-65.78	9.1	1.42	-58.1	-13	45.1
800	V	-65.72	8.7	2.86	-59.88	-13	46.88
1648.4	V	-53.9	6.95	4.17	-51.12	-13	38.12
2472.6	V	-53.16	8.35	5.24	-50.05	-13	37.05
3296.8	V	-50.31	8.15	6.11	-48.27	-13	35.27
3869.8	V	-49.18	8.35	6.64	-47.47	-13	34.47

Remark:

1 emission behaviors belong to narrowband spurious emission.

2 The result basic equation calculation is as follow:

$$\text{ERP (dBm)} = \text{S.G. Output(dBm)} + \text{Antenna Gain(dBd)} - \text{Cable Loss}$$

This document is issued by the Company subject to its General Conditions of Service printed overleaf, available on request or accessible at www.sgs.com/terms_and_conditions.htm and, for electronic format documents, subject to Terms and Conditions for Electronic Documents at www.sgs.com/terms_e-document.htm. Attention is drawn to the limitation of liability, indemnification and jurisdiction issues defined therein. Any holder of this document is advised that information contained hereon reflects the Company's findings at the time of its intervention only and within the limits of Client's instructions, if any. The Company's sole responsibility is to its Client and this document does not exonerate parties to a transaction from exercising all their rights and obligations under the transaction documents. This document cannot be reproduced except in full, without prior written approval of the Company. Any unauthorized alteration, forgery or falsification of the content or appearance of this document is unlawful and offenders may be prosecuted to the fullest extent of the law. Unless otherwise stated the results shown in this test report refer only to the sample(s) tested and such sample(s) are retained for 90 days only

**SGS-CSTC Standards
Technical Services
(Shanghai) Co., Ltd.**

ReportNo.: SHEMO10040047803
Page: 30 of 38

Radiated spurious Emission Measurement Result: GSM 850 mode

Operation mode: TX CH Mid mode

Fundamental Frequency: 836.60MHz

Frequency (MHz)	Ant.Pol. H/V	S.G Output (dBm)	Antenna Gain (dBd)	Cable Loss (dB)	ERP (dBm)	Limit (dBm)	Safe Margin (dB)
100	H	-59.26	2.6	1	-57.66	-13	44.66
200	H	-64.94	9.1	1.42	-57.26	-13	44.26
800	H	-64.51	8.7	2.86	-58.67	-13	45.67
1673.2	H	-56.44	6.95	4.2	-53.69	-13	40.69
2509.8	H	-55.34	8.35	5.36	-52.35	-13	39.35
3347.06	H	-48.43	8.15	6.25	-46.53	-13	33.53
4183	H	-49.65	8.45	6.98	-48.18	-13	35.18
100	V	-57.16	2.6	1	-55.56	-13	42.56
200	V	-65.36	9.1	1.42	-57.68	-13	44.68
800	V	-64.51	8.7	2.86	-58.67	-13	45.67
1673.2	V	-53.03	6.95	4.2	-50.28	-13	37.28
2509.8	V	-54.22	8.35	5.36	-51.23	-13	38.23
3347.2	V	-51.63	8.16	6.36	-49.83	-13	36.83
4183	V	-49.89	8.45	6.98	-48.42	-13	35.42

Remark:

1 emission behaviors belong to narrowband spurious emission.

2 The result basic equation calculation is as follow:

ERP (dBm)=S.G. Output(dBm) + Antenna Gain(dBd)-Cable Loss

**SGS-CSTC Standards
Technical Services
(Shanghai) Co., Ltd.**

ReportNo.: SHEMO10040047803
Page: 31 of 38

Radiated spurious Emission Measurement Result: GSM 850 mode

Operation mode: TX CH High mode

Fundamental Frequency: 848.8MHz

Frequency (MHz)	Ant.Pol. H/V	S.G Output (dBm)	Antenna Gain (dBd)	Cable Loss (dB)	ERP (dBm)	Limit (dBm)	Safe Margin (dB)
100	H	-58.26	2.6	1	-56.66	-13	43.66
200	H	-64.88	9.1	1.42	-57.2	-13	44.2
800	H	-63.73	8.7	2.86	-57.89	-13	44.89
1697.6	H	-54.29	6.95	4.22	-51.56	-13	38.56
2546.4	H	-53.19	8.35	5.39	-50.23	-13	37.23
3395.8	H	-48.77	8.15	6.35	-46.97	-13	33.97
4244	H	-51.97	8.45	7.04	-50.56	-13	37.56
100	V	-58.85	2.6	1	-57.25	-13	44.25
200	V	-66.22	9.1	1.42	-58.54	-13	45.54
800	V	-64.62	8.7	2.86	-58.78	-13	45.78
1697.6	V	-53.15	6.95	4.22	-50.42	-13	37.42
2546.4	V	-52.61	8.35	5.39	-49.65	-13	36.65
3394.8	V	-50.16	8.15	6.35	-48.36	-13	35.36
4244	V	-49.88	8.45	7.04	-48.47	-13	35.47

Remark:

1 emission behaviors belong to narrowband spurious emission.

2 The result basic equation calculation is as follow:

$$\text{ERP (dBm)} = \text{S.G. Output(dBm)} + \text{Antenna Gain(dBd)} - \text{Cable Loss}$$

**SGS-CSTC Standards
Technical Services
(Shanghai) Co., Ltd.**

ReportNo.: SHEMO10040047803
Page: 32 of 38

Radiated spurious Emission Measurement Result: PCS 1900 mode

Operation mode: TX CH Low mode

Fundamental Frequency: 1850.2MHz

Frequency (MHz)	Ant.Pol. H/V	S.G Output (dBm)	Antenna Gain (dBi)	Cable Loss (dB)	EIRP (dBm)	Limit (dBm)	Safe Margin (dB)
100	H	-58.16	2.6	1	-56.56	-13	43.56
200	H	-64.8	9.1	1.42	-57.12	-13	44.12
800	H	-63.72	8.7	2.86	-57.88	-13	44.88
1800	H	-52.48	7	4.38	-49.86	-13	36.86
3699.9	H	-44.2	8.35	6.77	-42.62	-13	29.62
5550.6	H	-49.67	9.55	8.1	-48.22	-13	35.22
7400.8	H	-51.45	9.75	9.51	-51.21	-13	38.21
9251	H	-54.71	10.55	11.08	-55.24	-13	42.24
100	V	-58.72	2.6	1	-57.12	-13	44.12
200	V	-65.55	9.1	1.42	-57.87	-13	44.87
800	V	-64.82	8.7	2.86	-58.98	-13	45.98
1800	V	-50.51	7	4.38	-47.89	-13	34.89
3700.4	V	-44.3	8.35	6.77	-42.72	-13	29.72
5550.6	V	-46.84	9.55	8.1	-45.39	-13	32.39
7400.8	V	-50.11	9.75	9.51	-49.87	-13	36.87
9251	V	-51.92	10.55	11.08	-52.45	-13	40.55

Remark:

1 emission behaviors belong to narrowband spurious emission.

2 The result basic equation calculation is as follow:

$$\text{EIRP(dBm)} = \text{S.G. Output(dBm)} + \text{Antenna Gain(dBi)} - \text{Cable Loss}$$

**SGS-CSTC Standards
Technical Services
(Shanghai) Co., Ltd.**

ReportNo.: SHEMO10040047803
Page: 33 of 38

Radiated spurious Emission Measurement Result: PCS 1900 mode

Operation mode: TX CH mid mode

Fundamental Frequency: 1880.0MHz

Frequency (MHz)	Ant.Pol. H/V	S.G Output (dBm)	Antenna Gain (dBi)	Cable Loss (dB)	EIRP (dBm)	Limit (dBm)	Safe Margin (dB)
100	H	-58.05	2.6	1	-56.45	-13	43.45
200	H	-67.07	9.1	1.42	-59.39	-13	46.39
800	H	-66.81	8.7	2.86	-60.97	-13	47.97
1800	H	-52.9	7	4.38	-50.28	-13	37.28
3760	H	-45.24	8.42	6.84	-43.66	-13	30.66
5640	H	-48.44	9.5	8.31	-47.25	-13	34.25
7520	H	-49.5	9.78	9.6	-49.32	-13	36.32
9400	H	-53.62	10.61	11.32	-54.33	-13	41.33
100	V	-59.47	2.6	1	-57.87	-13	44.87
200	V	-66.16	9.1	1.42	-58.48	-13	45.48
800	V	-64.62	8.7	2.86	-58.78	-13	45.78
1800	V	-54.77	7	4.38	-52.15	-13	39.15
3760	V	-45.14	8.42	6.84	-43.56	-13	30.56
5640	V	-48.75	9.5	8.31	-47.56	-13	34.56
7520	V	-52.3	9.78	9.6	-52.12	-13	39.12
9400	V	-53.76	10.61	11.32	-54.47	-13	41.47

Remark:

1 emission behaviors belong to narrowband spurious emission.

2 The result basic equation calculation is as follow:

$$\text{EIRP(dBm)} = \text{S.G. Output(dBm)} + \text{Antenna Gain(dBi)} - \text{Cable Loss}$$

**SGS-CSTC Standards
Technical Services
(Shanghai) Co., Ltd.**

ReportNo.: SHEMO10040047803
Page: 34 of 38

Radiated spurious Emission Measurement Result: PCS 1900 mode

Operation mode: TX CH High mode

Fundamental Frequency: 1909.8MHz

Frequency (MHz)	Ant.Pol. H/V	S.G Output (dBm)	Antenna Gain (dBi)	Cable Loss (dB)	EIRP (dBm)	Limit (dBm)	Safe Margin (dB)
100	H	-58.18	2.6	1	-56.58	-13	43.58
200	H	-64.8	9.1	1.42	-57.12	-13	44.12
800	H	-64.39	8.7	2.86	-58.55	-13	45.55
1800	H	-54.74	7	4.38	-52.12	-13	39.12
3819.9	H	-44.61	8.42	6.88	-43.07	-13	30.07
5729.8	H	-47.45	9.5	8.48	-46.43	-13	33.43
7639.2	H	-52.4	9.78	9.7	-52.32	-13	39.32
9549	H	-53.32	10.61	11.64	-54.35	-13	41.35
100	V	-59.14	2.6	1	-57.54	-13	44.54
200	V	-65.904	9.1	1.42	-58.224	-13	45.224
800	V	-64.29	8.7	2.86	-58.45	-13	45.45
1800	V	-54.84	7	4.38	-52.22	-13	39.22
3819.6	V	-42.03	8.42	6.88	-40.49	-13	27.49
5729.8	V	-47.54	9.5	8.48	-46.52	-13	33.52
7639.2	V	-52.2	9.78	9.7	-52.12	-13	39.12
9549	V	-54.62	10.61	11.64	-55.65	-13	42.65

Remark:

1 emission behaviors belong to narrowband spurious emission.

2 The result basic equation calculation is as follow:

$$\text{EIRP(dBm)} = \text{S.G. Output(dBm)} + \text{Antenna Gain(dBi)} - \text{Cable Loss}$$

6.7 Frequency Stability V.S. TEMPERATURE MEASUREMENT

Test Requirement: Part 2.1055(a)(1)
Test Date: May 21,2010
Test Status: Test mode
Test Setup:

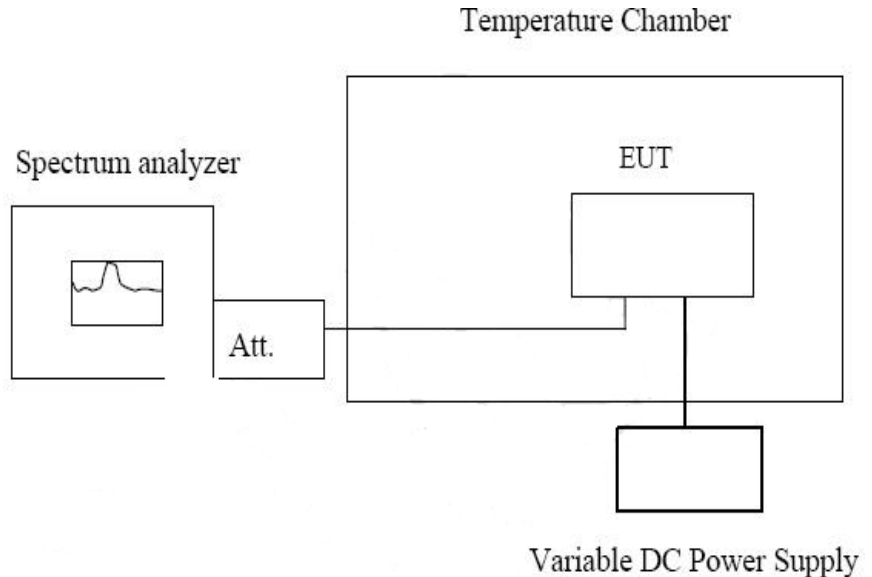

Note: Measurement setup for testing On antenna connector.

Test procedure:

The equipment under test was connected to an external DC power supply and input rated voltage. Reference power supply voltage for these tests is DC 4.0V. RF output was connected to a frequency counter or spectrum analyzer via feed through attenuators. The EUT was placed inside the temperature chamber. Set the Spectrum analyzer RBW low enough to obtain the desired frequency resolution and measure EUT 25 degree operating frequency as reference frequency. Turn EUT off and set the chamber temperature to -30 degree. After the temperature stabilized for approximately 30 minutes record the frequency. Repeat step measure with 10 degree per stage until the highest temperature of 50 degree reached.

Frequency Tolerance: +/-2.5ppm for 850MHz band
+/-2.5ppm for 1900MHz band

**SGS-CSTC Standards
Technical Services
(Shanghai) Co., Ltd.**

ReportNo.: SHEMO10040047803
Page: 36 of 38

Reference Frequency: GSM 850 Mid channel 836.6MHz@ 25 degree			
Limit: +/- 2.5ppm = 2091Hz			
Environment	Frequency	Delta	Limit
Temperature(degree)	(MHz)		
-30	836.599950	50	2091
-20	836.599971	29	2091
-10	836.599979	21	2091
10	836.599986	14	2091
20	836.599996	4	2091
30	836.600011	-11	2091
40	836.599978	22	2091
50	836.599965	35	2091

Reference Frequency: PCS 1900 Mid channel 1880MHz@ 25 degree			
Limit: +/- 2.5ppm = 4700Hz			
Environment	Frequency	Delta	Limit
Temperature(degree)	(MHz)		
-30	1879.999891	109	4700
-20	1879.999945	55	4700
-10	1879.999975	25	4700
10	1879.999989	11	4700
20	1879.999985	15	4700
30	1879.999973	27	4700
40	1879.999948	52	4700
50	1879.999935	65	4700

6.8 Frequency Stability V.S. VOLTAGE MEASUREMENT

Test Requirement: Part 2.1055(d)
Test Date: May 21,2010
Test Status: Test mode
Test Setup:

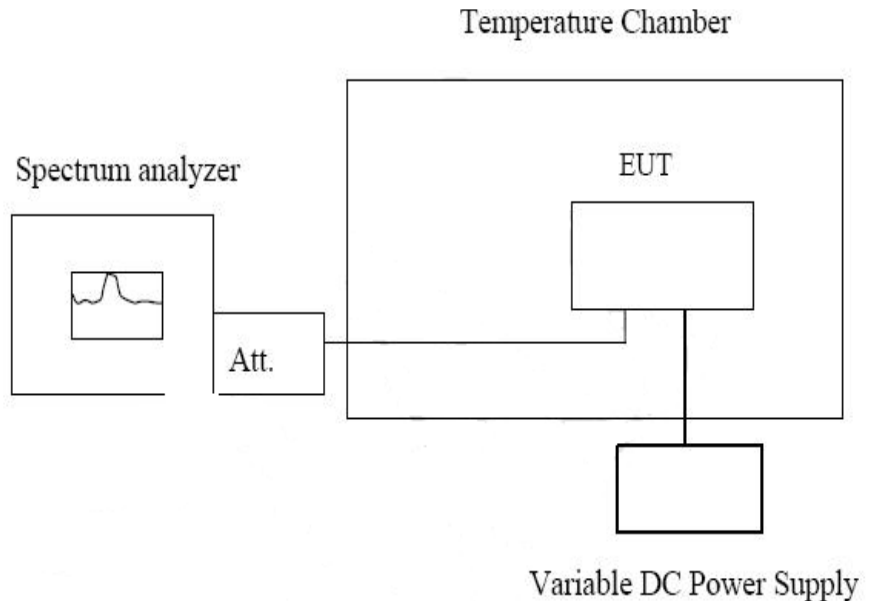

Note: Measurement setup for testing On antenna connector.

Test procedure:

Set chamber temperature to 25 degree. Use a variable DC power supply to power the EUT and set the Voltage to rated voltage. Reference power supply voltage for these tests is DC 3.7V. Set the spectrum analyzer RBW enough to obtain the desired frequency resolution and recorded the frequency.

Reduce the input voltage to specified extreme voltage variation(+/-15%) and endpoint, record the maximum frequency change.

Frequency Tolerance: +/-2.5ppm for 850MHz band
+/-2.5ppm for 1900MHz band

**SGS-CSTC Standards
Technical Services
(Shanghai) Co., Ltd.**

ReportNo.: SHEMO10040047803
Page: 38 of 38

Reference Frequency: GSM 850 Mid channel 836.6MHz@ 25 degree			
Limit: +/- 2.5ppm = 2091Hz			
Power Supply	Frequency	Delta	Limit
Vdc	(MHz)		
4.2	836.600054	-45	2091
3.7	836.600000	0	2091
3.6	836.599982	-87	2091

Reference Frequency: PCS 1900 Mid channel 1880MHz@ 25 degree			
Limit: +/- 2.5ppm = 4700Hz			
Power Supply	Frequency	Delta	Limit
Vdc	(MHz)		
4.2	1879.999980	30	4700
3.7	1880.000000	0	4700
3.6	1879.999994	-58	4700

~End of Report~