

FCC Test Report (PART 24)

Report No.: RF160624W002-5

FCC ID: YCNA2016B31

Test Model: Lenovo A2016b31

Received Date: Jun. 24, 2016

Test Date: Jun. 25, 2016~ Jun. 30, 2016

Issued Date: July 01, 2016

Applicant: Lenovo Mobile Communication Technology Ltd.

Address: No.999, Qishan North 2nd Road, Information & Optoelectronics Park, Torch Hi-tech Industry Development Zone, Xiamen, P.R.China

Issued By: Bureau Veritas Consumer Products Services (H.K.) Ltd., Taoyuan Branch

Lab Address: No. 47-2, 14th Ling, Chia Cau Vil., Lin Kou Dist., New Taipei City, Taiwan (R.O.C.)

Test Location: No. 19, Hwa Ya 2nd Rd., Wen Hwa Tsuen, Kwei Shan Hsiang, Taoyuan Hsien 333, Taiwan, R.O.C.

This report should not be used by the client to claim product certification, approval, or endorsement by TAF or any government agencies.



This report is for your exclusive use. Any copying or replication of this report to or for any other person or entity, or use of our name or trademark, is permitted only with our prior written permission. This report sets forth our findings solely with respect to the test samples identified herein. The results set forth in this report are not indicative or representative of the quality or characteristics of the lot from which a test sample was taken or any similar or identical product specifically and expressly noted. Our report includes all of the tests requested by you and the results thereof based upon the information that you provided to us. You have 60 days from date of issuance of this report to notify us of any material error or omission caused by our negligence, provided, however, that such notice shall be in writing and shall specifically address the issue you wish to raise. A failure to raise such issue within the prescribed time shall constitute your unqualified acceptance of the completeness of this report, the tests conducted and the correctness of the report contents. Unless specific mention, the uncertainty of measurement has been explicitly taken into account to declare the compliance or non-compliance to the specification. The report must not be used by the client to claim product certification, approval, or endorsement by TAF or any government agencies.

TABLE OF CONTENTS

RELEASE CONTROL RECORD	3
1 Certificate of Conformity.....	4
2 Summary of Test Results	5
2.1 Measurement Uncertainty	5
2.2 Test Site And Instruments	5
3 General Information.....	7
3.1 General Description of EUT	7
3.2 Configuration Of System Under Test.....	10
3.2.1 Description Of Support Units.....	11
3.3 Test Mode Applicability and Tested Channel Detail	11
3.4 EUT Operating Conditions	14
3.5 General Description of Applied Standards	14
4 Test Types and Results	15
4.1 Output Power Measurement	15
4.1.1 Limits of Output Power Measurement.....	15
4.1.2 Test Procedures.....	15
4.1.3 Test Setup.....	16
4.1.4 Test Results	17
4.2 Frequency Stability Measurement.....	26
4.2.1 Limits of Frequency Stability Measurement.....	26
4.2.2 Test Procedure	26
4.2.3 Test Setup.....	26
4.2.4 Test Results	27
4.3 Occupied Bandwidth Measurement	29
4.3.1 Test Procedure	29
4.3.2 Test Setup.....	29
4.3.3 Test Result.....	30
4.4 Band Edge Measurement	38
4.4.1 Limits of Band Edge Measurement	38
4.4.2 Test Setup.....	38
4.4.3 Test Procedures.....	38
4.4.4 Test Results	39
4.5 Peak To Average Ratio.....	46
4.5.1 Limits of Peak To Average Ratio Measurement	46
4.5.2 Test Setup.....	46
4.5.3 Test Procedures.....	46
4.5.4 Test Results	47
4.6 Conducted Spurious Emissions	51
4.6.1 Limits of Conducted Spurious Emissions Measurement.....	51
4.6.2 Test Setup.....	51
4.6.3 Test Procedure	51
4.6.4 Test Results	52
4.7 Radiated Emission Measurement	56
4.7.1 Limits of Radiated Emission Measurement.....	56
4.7.2 Test Procedure	56
4.7.3 Deviation from Test Standard	56
4.7.4 Test Setup.....	57
4.7.5 Test Results	58
5 Pictures of Test Arrangements.....	58
Appendix – Information on the Testing Laboratories	79



A D T

RELEASE CONTROL RECORD

Issue No.	Description	Date Issued
RF160624W002-5	Original release	July 01, 2016

1 Certificate of Conformity

Product: Mobile Phone

Brand: Lenovo

Test Model: Lenovo A2016b31

Sample Status: Identical Prototype

Applicant: Lenovo Mobile Communication Technology Ltd.

Test Date: Jun. 25, 2016~ Jun. 30, 2016

Standards: FCC Part 24, Subpart E

The above equipment has been tested by **Bureau Veritas Consumer Products Services (H.K.) Ltd., Taoyuan Branch**, and found compliance with the requirement of the above standards. The test record, data evaluation & Equipment Under Test (EUT) configurations represented herein are true and accurate accounts of the measurements of the sample's EMC characteristics under the conditions specified in this report.

Prepared by : , **Date:** July 01, 2016
Amyee Qian / Engineer

Approved by : , **Date:** July 01, 2016
William Chung / Manager

2 Summary of Test Results

Applied Standard: FCC Part 24 & Part 2			
FCC Clause	Test Item	Result	Remarks
2.1046 24.232	Effective Radiated Power	PASS	Meet the requirement of limit.
2.1046 24.232(d)	Peak To Average Ratio	PASS	Meet the requirement of limit.
2.1055 24.235	Frequency Stability	PASS	Meet the requirement of limit.
2.1049 24.238(b)	Occupied Bandwidth	PASS	Meet the requirement of limit.
24.238(b)	Band Edge Measurements	PASS	Meet the requirement of limit.
2.1051 24.238	Conducted Spurious Emissions	PASS	Meet the requirement of limit.
2.1053 24.238	Radiated Spurious Emissions	PASS	Meet the requirement of limit. Minimum passing margin is -6.18dB at 42.61MHz.

2.1 Measurement Uncertainty

Where relevant, the following measurement uncertainty levels have been estimated for tests performed on the EUT as specified in CISPR 16-4-2:

Measurement	Frequency	Expanded Uncertainty (k=2) (\pm)
Conducted Emissions at mains ports	150kHz ~ 30MHz	2.44 dB
Radiated Emissions up to 1 GHz	30MHz ~ 200MHz	2.93 dB
	200MHz ~ 1000MHz	2.95 dB
Radiated Emissions above 1 GHz	1GHz ~ 18GHz	2.26 dB
	18GHz ~ 40GHz	1.94 dB

This uncertainty represents an expanded uncertainty expressed at approximately the 95% confidence level using a coverage factor of k=2.

2.2 Test Site And Instruments

Equipment	Manufacturer	Model No.	Serial No.	Last Cal.	Next Cal.
EMI Test Receiver	Rohde&Schwarz	ESR7	101494	Apr. 05,16	Apr. 04,17
Signal and Spectrum Analyzer	Rohde&Schwarz	FSV40	101094	Apr. 05,16	Apr. 04,17
Bilog Antenna 1	Teseq	CBL 6111D	30643	Aug. 28,15	Aug. 27,16
Bilog Antenna 2	Teseq	CBL 6111D	27089	Aug. 28,15	Aug. 27,16
Horn Antenna	ETS-Lindgren	3117	00062558	May 30,14	May 29,17
Horn Antenna (15GHz-40GHz)	SCHWARZBECK	BBHA 9170	BBHA9170147	Jan. 21,14	Jan. 20,17
Amplifier	Burgeon	BPA-530	100220	Apr. 05,16	Apr. 04,17
Pre-Amplifier	HP	8449B	3008A00409	Apr. 24,16	Apr. 23,17
Pre-Amplifier (18GHz-40GHz)	EMCI	EMC 184045	980102	Nov. 11,15	Nov. 10,16
GPS Generator+ Antenna	TOJOIN	GNSS-5000A	E1-010119	Aug. 08, 14	Aug. 07, 16
3m Semi-anechoic Chamber	ETS-LINDGREN	9m*6m*6m	NSEMC003	Mar. 12,16	Mar. 11,18
Test Software	ADT	ADT_Radiated_V7.6.15.9.2	N/A	N/A	N/A
Power Meter	Anritsu	ML2495A	1139001	Feb.19,16	Feb. 18,17
Power Sensor	Anritsu	MA2411B	1126068	Feb.19,16	Feb. 18,17
Power Sensor	Keysight	U2021XA	MY55060016	May 27,15	May 26,17
Power Sensor	Keysight	U2021XA	MY55060018	May 27,15	May 26,17
Digital Multimeter	FLUKE	15B	A1220010DG	Oct. 12, 15	Oct. 11, 16
Humid & Temp Programmable Tester	Haida	HD-2257	110807201	Sep.07,15	Sep. 06,16
Oscilloscope	Agilent	DSO9254A	MY51260160	Nov. 09,15	Nov. 08,16
Signal Analyzer	Rohde & Schwarz	FSV7	102331	Nov. 09,15	Nov. 08,16
Signal Generator	Agilent	N5183A	MY50140980	Apr. 21, 16	Apr. 20, 17
ESG Vector Signal Generator	Agilent	E4438C	MY49072505	Sep. 01,15	Aug. 31,16
BLUETOOTH TESTER	Rohde&Schwarz	CBT32	100811	Oct. 12, 15	Oct. 11, 16

NOTE: 1. The calibration interval of the above test instruments is 12 months and the calibrations are traceable to NML/ROC and NIST/USA.

2. The calibration interval of the loop antenna is 24 months and the calibrations are traceable to NML/ROC and NIST/USA.

3. The test was performed in HwaYa Chamber 4.

4. The horn antenna and HP preamplifier (model: 8449B) are used only for the measurement of emission frequency above 1GHz if tested.

5. The FCC Site Registration No. is 460141.

6. The IC Site Registration No. is IC7450F-4.

3 General Information

3.1 General Description of EUT

PRODUCT	Mobile Phone	
BRAND	Lenovo	
MODEL NAME	Lenovo A2016b31	
POWER SUPPLY	5.0Vdc (adapter or host equipment) 3.8Vdc (battery)	
MODULATION TYPE	GSM, GPRS: GMSK EDGE: GMSK, 8PSK WCDMA : BPSK LTE Band 2: QPSK, 16QAM	
FREQUENCY RANGE	GSM, GPRS, EDGE: 1850.2MHz ~ 1909.8MHz	
	WCDMA: 1852.4MHz ~ 1907.6MHz	
	LTE Band 2 Channel Bandwidth: 1.4MHz	1850.7MHz ~ 1909.3MHz
	LTE Band 2 Channel Bandwidth: 3MHz	1851.5MHz ~ 1908.5MHz
	LTE Band 2 Channel Bandwidth: 5MHz	1852.5MHz ~ 1907.5MHz
	LTE Band 2 Channel Bandwidth: 10MHz	1855.0MHz ~ 1905.0MHz
	LTE Band 2 Channel Bandwidth: 15MHz	1857.5MHz ~ 1902.5MHz
	LTE Band 2 Channel Bandwidth: 20MHz	1860.0MHz ~ 1900.0MHz
MAX. EIRP POWER	GSM: 1091mW	
	EDGE: 556mW	
	WCDMA: 333mW	
	LTE Band 2 Channel Bandwidth: 1.4MHz	314mW
	LTE Band 2 Channel Bandwidth: 3MHz	310mW
	LTE Band 2 Channel Bandwidth: 5MHz	313mW
	LTE Band 2 Channel Bandwidth: 10MHz	318mW
	LTE Band 2 Channel Bandwidth: 15MHz	313mW
LTE Band 2 Channel Bandwidth: 20MHz	282mW	

EMISSION DESIGNATOR	GSM	247KGXW
	EDGE	250KG7W
	WCDMA	4M24F9W
	LTE Band 2 Channel Bandwidth: 1.4MHz	QPSK: 1M09G7D 16QAM: 1M09W7D
	LTE Band 2 Channel Bandwidth: 3MHz	QPSK: 2M69G7D 16QAM: 2M68W7D
	LTE Band 2 Channel Bandwidth: 5MHz	QPSK: 4M49G7D 16QAM: 4M49W7D
	LTE Band 2 Channel Bandwidth: 10MHz	QPSK: 8M94G7D 16QAM: 8M94W7D
	LTE Band 2 Channel Bandwidth: 15MHz	QPSK: 13M4G7D 16QAM: 13M5W7D
	LTE Band 2 Channel Bandwidth: 20MHz	QPSK: 17M9G7D 16QAM: 17M9W7D
	ANTENNA TYPE	GSM1900/ WCDMA B2
LTE B2		Fixed Internal antenna with -1.37dBi gain
HW VERSION	AL732_MB_PCB_V2.0	
SW VERSION	A2016b31_S_S107_160617_8G_LATAM	
ACCESSORY DEVICE	Refer to note as below	
DATA CABLE	USB cable: non-shielded, detachable, 0.7m Earphone: non-shielded, detachable, 1.3m	

Note:

- The above EUT information is declared by manufacturer and for more detailed features description, please refer to the manufacturer's specifications or User's Manual.
- There were Sample A and Sample B for this project, the difference is the color and configuration, as below:

SAMPLE	EUT CONFIGURATION INFORMATION
A (Black)	LCD panel 1+ Photo Camera 1+ Video Camera 1+ Main Broad 1
B (White)	LCD panel 2+ Photo Camera 2+ Video Camera 2+ Main Broad 2

- For the test results, the EUT had been tested with all conditions. But only the worst case was shown in test report.

LIST OF ACCESSORIES:

ACCESSORIES	BRAND	MANUFACTURER	MODEL	SPECIFICATION
AC Adapter 1	Lenovo	CHENYANG	C-P56	I/P:100-240Vac, 130mA O/P:5.0Vdc, 1000mA
AC Adapter 2	Lenovo	Acbel	C-P56	I/P:100-240Vac, 130mA O/P:5.0Vdc, 1000mA
Battery 1	Lenovo	ATL	BL253	Rating: 3.8Vdc, 2000mAh
Battery 2	Lenovo	VK	BL253	Rating: 3.8Vdc, 2000mAh
USB Cable 1	Lenovo	FUKANGYUAN	F16W-05100070L	0.7m non-shielded cable w/o core
USB Cable 2	Lenovo	LIQI	L16W-05100070L	0.7m non-shielded cable w/o core
Earphone 1	Lenovo	TIANZHI	TJ101247A	1.3m non-shielded cable w/o core
Earphone 2	Lenovo	LIANYUN	TS990B-28AMS05-M	1.3m non-shielded cable w/o core
LCD Panel 1	HELITAI	--	QTB4D543	--
LCD Panel 1	TONGXINGDA	--	TXDT450SKP-73V6	--
Photo Camera 1	BOLIXIN	--	BLX2355H-AL732-F	--
Photo Camera 2	HUAQUAN	--	G6P2-AL732FHQ	--
Video Camera 1	QUNHUI	--	SHT6029B1S-1P0J0	--
Video Camera 2	HUAQUAN	--	G7B5-AL732BHQ	--
Main Broad 1	HUASHEN	--	AL732_MB_PCB_V2.0	--
Main Broad 2	YILIANDA	--	AL732_MB_PCB_V2.0	--
BT/WLAN Module	MTK	--	MT6625L	--
WWAN Module	N/A	--	N/A	--

3.2 Configuration Of System Under Test

FOR RADIATION EMISSION TEST

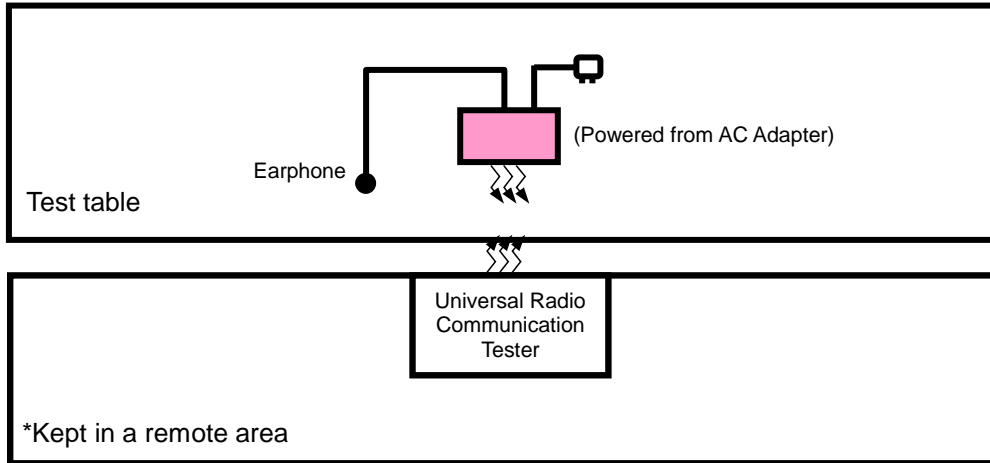

FOR E.R.P. TEST

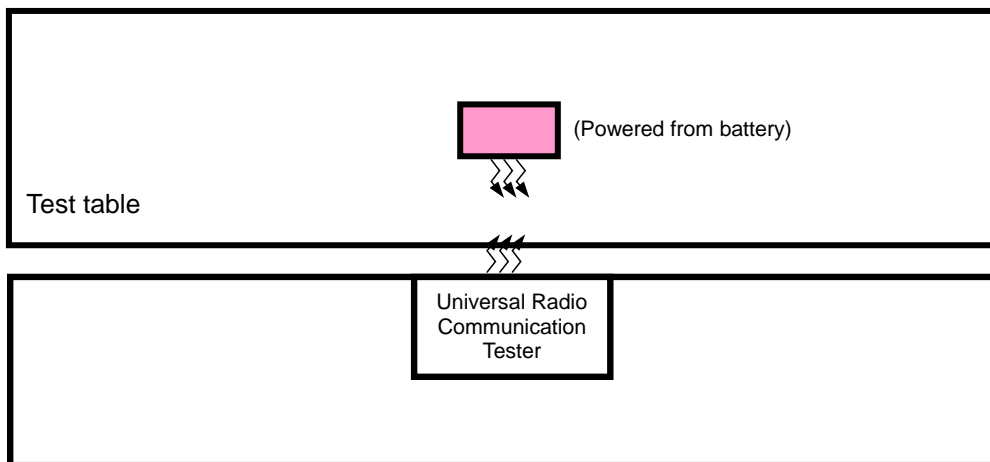

3.2.1 Description Of Support Units

The EUT has been tested as an independent unit together with other necessary accessories or support units. The following support units or accessories were used to form a representative test configuration during the tests.

NO.	PRODUCT	BRAND	MODEL NO.	SERIAL NO.	FCC ID
1	DC source	LONG WEI	PS-6403D	010934269	N/A
2	PC	HP	A6608CN	3CR83825X3	N/A

NO.	SIGNAL CABLE DESCRIPTION OF THE ABOVE SUPPORT UNITS
1	DC Line: Unshielded, Detachable 1.0m
2	AC Line: Unshielded, Detachable 1.5m

NOTE:

1. All power cords of the above support units are non shielded (1.8m).

3.3 Test Mode Applicability and Tested Channel Detail

Pre-Scan has been conducted to determine the worst-case mode from all possible combinations between available modulations, data rates, XYZ axis and antenna ports
The worst case was found when positioned on Z-plane. Following channel(s) was (were) selected for the final test as listed below:

Test results are presented in the report as below.

Test Mode	Test Condition
A	Power from adapter
B	Power from battery

GSM MODE

EUT Configure Mode	Test Item	Available Channel	Tested Channel	Mode
A	EIRP	512 to 810	512, 661, 810	GSM
B	Frequency Stability	512 to 810	661	GSM
A	Occupied Bandwidth	512 to 810	512, 661, 810	GSM, EDGE
A	Band Edge	512 to 810	512, 810	GSM, EDGE
A	Peak To Average Ratio	512 to 810	512, 661, 810	GSM, EDGE
A	Condcudeted Emission	512 to 810	512, 661, 810	GSM, EDGE
A	Radiated Emission Below 1GHz	512 to 810	512	GSM
A	Radiated Emission Above 1GHz	512 to 810	512, 661, 810	GSM

WCDMA MODE

EUT Configure Mode	Test Item	Available Channel	Tested Channel	Mode
A	EIRP	9262 to 9538	9262, 9400, 9538	WCDMA
B	Frequency Stability	9262 to 9538	9400	WCDMA
A	Occupied Bandwidth	9262 to 9538	9262, 9400, 9538	WCDMA
A	Band Edge	9262 to 9538	9262, 9538	WCDMA
A	Peak To Average Ratio	9262 to 9538	9262, 9400, 9538	WCDMA
A	Conducuted Emission	9262 to 9538	9262, 9400, 9538	WCDMA
A	Radiated Emission Below 1GHz	9262 to 9538	9262	WCDMA
A	Radiated Emission Above 1GHz	9262 to 9538	9262, 9400, 9538	WCDMA

LTE BAND 2

EUT CONFIGURE MODE	TEST ITEM	AVAILABLE CHANNEL	TESTED CHANNEL	CHANNEL BANDWIDTH	MODULATION	MODE
B	EIRP	18607 to 19193	18607, 18900, 19193	1.4MHz	QPSK, 16QAM	1 RB / 0 RB Offset
		18615 to 19185	18615, 18900, 19185	3MHz	QPSK, 16QAM	1 RB / 0 RB Offset
		18625 to 19175	18625, 18900, 19175	5MHz	QPSK, 16QAM	1 RB / 0 RB Offset
		18650 to 19150	18650, 18900, 19150	10MHz	QPSK, 16QAM	1 RB / 0 RB Offset
		18675 to 19125	18675, 18900, 19125	15MHz	QPSK, 16QAM	1 RB / 0 RB Offset
		18700 to 19100	18700, 18900, 19100	20MHz	QPSK, 16QAM	1 RB / 0 RB Offset
B	FREQUENCY STABILITY	18607 to 19193	18900	1.4MHz	QPSK	1 RB / 0 RB Offset
		18615 to 19185	18900	3MHz	QPSK	1 RB / 0 RB Offset
		18625 to 19175	18900	5MHz	QPSK	1 RB / 0 RB Offset
		18650 to 19150	18900	10MHz	QPSK	1 RB / 0 RB Offset
		18675 to 19125	18900	15MHz	QPSK	1 RB / 0 RB Offset
		18700 to 19100	18900	20MHz	QPSK	1 RB / 0 RB Offset
B	OCCUPIED BANDWIDTH	18607 to 19193	18607, 18900, 19193	1.4MHz	QPSK, 16QAM	6 RB / 0 RB Offset
		18615 to 19185	18615, 18900, 19185	3MHz	QPSK, 16QAM	15 RB / 0 RB Offset
		18625 to 19175	18625, 18900, 19175	5MHz	QPSK, 16QAM	25 RB / 0 RB Offset
		18650 to 19150	18650, 18900, 19150	10MHz	QPSK, 16QAM	50 RB / 0 RB Offset
		18675 to 19125	18675, 18900, 19125	15MHz	QPSK, 16QAM	75 RB / 0 RB Offset
		18700 to 19100	18700, 18900, 19100	20MHz	QPSK, 16QAM	100 RB / 0 RB Offset
B	PEAK TO AVERAGE RATIO	18607 to 19193	18607, 18900, 19193	1.4MHz	QPSK, 16QAM	1 RB / 0 RB Offset
		18615 to 19185	18615, 18900, 19185	3MHz	QPSK, 16QAM	1 RB / 0 RB Offset
		18625 to 19175	18625, 18900, 19175	5MHz	QPSK, 16QAM	1 RB / 0 RB Offset
		18650 to 19150	18650, 18900, 19150	10MHz	QPSK, 16QAM	1 RB / 0 RB Offset
		18675 to 19125	18675, 18900, 19125	15MHz	QPSK, 16QAM	1 RB / 0 RB Offset
		18700 to 19100	18700, 18900, 19100	20MHz	QPSK, 16QAM	1 RB / 0 RB Offset

B	BAND EDGE	18607 to 19193	18607	1.4MHz	QPSK	1 RB / 0 RB Offset		
			19193	1.4MHz	QPSK	6 RB / 0 RB Offset		
		18615 to 19185	18615	3MHz	QPSK	1 RB / 5 RB Offset		
			19185	3MHz	QPSK	6 RB / 0 RB Offset		
		18625 to 19175	18625	5MHz	QPSK	1 RB / 0 RB Offset		
			19175	5MHz	QPSK	15 RB / 0 RB Offset		
		18650 to 19150	18650	10MHz	QPSK	1 RB / 14 RB Offset		
			19150	10MHz	QPSK	15 RB / 0 RB Offset		
		18675 to 19125	18675	15MHz	QPSK	1 RB / 0 RB Offset		
			19125	15MHz	QPSK	25 RB / 0 RB Offset		
		18700 to 19100	18700	20MHz	QPSK	1 RB / 24 RB Offset		
			19100	20MHz	QPSK	25 RB / 0 RB Offset		
		B	CONDCUDED EMISSION	18607 to 19193	18900	1.4MHz	QPSK	1 RB / 0 RB Offset
				18615 to 19185	18900	3MHz	QPSK	1 RB / 0 RB Offset
				18625 to 19175	18900	5MHz	QPSK	1 RB / 0 RB Offset
				18650 to 19150	18900	10MHz	QPSK	1 RB / 0 RB Offset
18675 to 19125	18900			15MHz	QPSK	1 RB / 0 RB Offset		
18700 to 19100	18900			20MHz	QPSK	1 RB / 0 RB Offset		
A	RADIATED EMISSION	18607 to 19193	18900	1.4MHz	QPSK	1 RB / 0 RB Offset		
		18615 to 19185	18900	3MHz	QPSK	1 RB / 0 RB Offset		
		18625 to 19175	18900	5MHz	QPSK	1 RB / 0 RB Offset		
		18650 to 19150	18900	10MHz	QPSK	1 RB / 0 RB Offset		
		18675 to 19125	18900	15MHz	QPSK	1 RB / 0 RB Offset		
		18700 to 19100	18900	20MHz	QPSK	1 RB / 0 RB Offset		

Test Condition:

Test Item	Environmental Conditions	Input Power	Tested By
EIRP	21deg. C, 71%RH 22deg. C, 71%RH	DC 3.8V from battery	Yuqiang Yin
Frequency Stability	24deg. C, 64%RH	DC 3.8V from battery	Yuqiang Yin
Occupied Bandwidth	24deg. C, 64%RH	DC 3.8V from battery	Yuqiang Yin
Band Edge	24deg. C, 64%RH	DC 3.8V from battery	Yuqiang Yin
Peak To Average Ratio	24deg. C, 64%RH	DC 3.8V from battery	Yuqiang Yin
Condcudeted Emission	24deg. C, 64%RH	5.0Vdc from adapter	Yuqiang Yin
Radiated Emission	21deg. C, 71%RH	5.0Vdc from adapter	Alex Chen

3.4 EUT Operating Conditions

The EUT makes a call to the communication simulator. The communication simulator station system controlled a EUT to export maximum output power under transmission mode and specific channel frequency

3.5 General Description of Applied Standards

The EUT is a RF Product. According to the specifications of the manufacturer, it must comply with the requirements of the following standards:

FCC 47 CFR Part 2

FCC 47 CFR Part 24

KDB 971168 D01 Power Meas License Digital Systems v02r05

ANSI/TIA/EIA-603-D

NOTE: All test items have been performed and recorded as per the above standards.

4 Test Types and Results

4.1 Output Power Measurement

4.1.1 Limits of Output Power Measurement

Mobile / Portable station are limited to 2 watts e.i.r.p.

4.1.2 Test Procedures

EIRP / ERP Measurement:

- a. All measurements were done at low, middle and high operational frequency range. RBW and VBW is 1MHz for GSM, GPRS and 5MHz for WCDMA mode, and 10MHz for LTE mode.
- b. Substitution method is used for E.I.R.P measurement. In the semi-anechoic chamber, EUT placed on the 0.8m height of Turn Table, rotated the table around 360 degrees to search the maximum radiation power and receiver antenna shall be rotated vertical and horizontal polarization and moved height from 1m to 4m to find the maximum polar radiated power. The "Read Value" is the spectrum reading the maximum power value.
- c. The substitution horn antenna is substituted for EUT at the same position and signals generator export the CW signal to the substitution antenna via a tx cable. Rotated the Turn Table and moved receiving antenna to find the maximum radiation power. Adjust output power level of S.G to get a Value of spectrum reading equal to "Read Value" of step b. Record the power level of S.G
- d. $EIRP = \text{Output power level of S.G} - \text{TX cable loss} + \text{Antenna gain of substitution horn.}$

Conducted Power Measurement:

The EUT was set up for the maximum power with GSM, GPRS & WCDMA link data modulation and link up with simulator. Set the EUT to transmit under low, middle and high channel and record the power level shown on simulator.

4.1.3 Test Setup

EIRP / ERP MEASUREMENT:

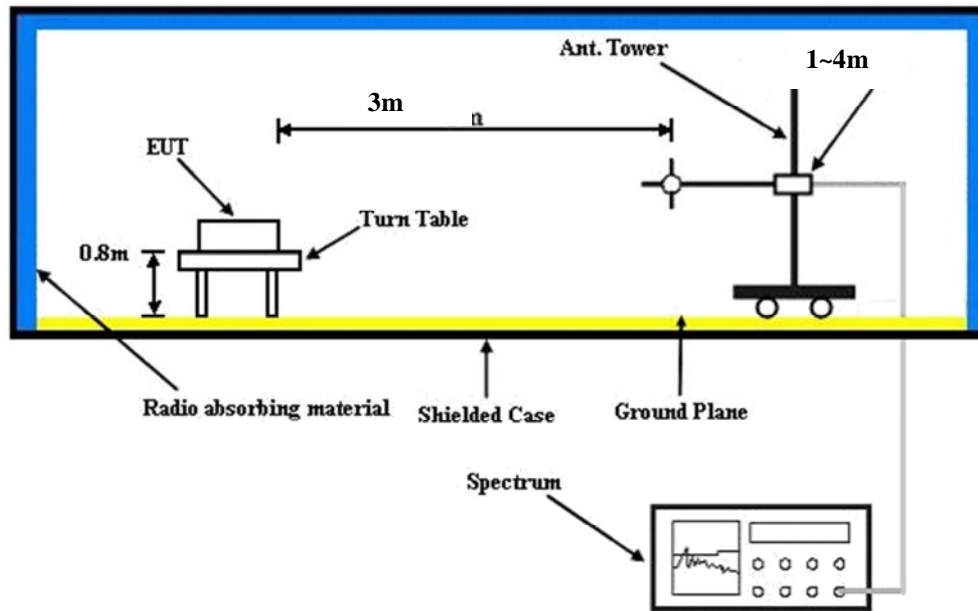

For the actual test configuration, please refer to the attached file (Test Setup Photo).

CONDUCTED POWER MEASUREMENT:



For the actual test configuration, please refer to the attached file (Test Setup Photo).

4.1.4 Test Results

CONDUCTED OUTPUT POWER (dBm)

Band	GSM1900		
Channel	512	661	810
Frequency (MHz)	1850.2	1880.0	1909.8
GSM	30.71	30.49	30.47
GPRS 8	30.69	30.49	30.46
GPRS 10	29.82	29.69	29.70
GPRS 11	27.84	27.79	28.02
GPRS 12	26.85	26.70	26.72
EDGE 8 (MCS1)	26.05	25.93	26.04
EDGE 10 (MCS1)	24.96	24.83	24.96
EDGE 11 (MCS9)	22.92	22.83	22.95
EDGE 12 (MCS9)	21.84	21.72	21.86

Band	WCDMA II		
Channel	9262	9400	9538
Frequency (MHz)	1852.4	1880.0	1907.6
RMC 12.2K	23.27	23.36	23.28
HSPA			
HSDPA Subtest-1	22.37	22.50	22.39
HSDPA Subtest-2	22.36	22.48	22.38
HSDPA Subtest-3	21.90	21.93	21.94
HSDPA Subtest-4	21.88	21.91	21.92
HSUPA Subtest-1	20.39	20.38	20.39
HSUPA Subtest-2	20.38	20.35	20.32
HSUPA Subtest-3	21.40	21.39	21.38
HSUPA Subtest-4	20.89	20.88	20.85
HSUPA Subtest-5	22.33	22.45	22.36

LTE Band 2							
BW	Modulation	RB Size	RB Offset	Low CH 18607	Mid CH 18900	High CH 19193	3GPP MPR (dB)
				Frequency 1850.7 MHz	Frequency 1880 MHz	Frequency 1909.3 MHz	
1.4MHz	QPSK	1	0	23.19	23.22	23.19	0
		1	2	23.06	23.02	22.97	0
		1	5	23.12	23.07	22.87	0
		3	0	23.18	23.21	23.18	0
		3	1	23.05	23.01	22.96	0
		3	3	23.11	23.06	22.86	0
		6	0	22.19	22.21	22.09	1
	16QAM	1	0	22.28	22.31	22.29	1
		1	2	22.25	22.24	22.07	1
		1	5	22.23	22.21	22.13	1
		3	0	22.26	22.29	22.27	1
		3	1	22.23	22.22	22.05	1
		3	3	22.21	22.19	22.11	1
		6	0	21.17	21.17	21.09	2

LTE Band 2							
BW	Modulation	RB Size	RB Offset	Low CH 18615	Mid CH 18900	High CH 19185	3GPP MPR (dB)
				Frequency 1851.5 MHz	Frequency 1880 MHz	Frequency 1908.5 MHz	
3 MHz	QPSK	1	0	23.22	23.25	23.22	0
		1	7	23.09	23.05	23.00	0
		1	14	23.15	23.10	22.90	0
		8	0	22.24	22.26	22.20	1
		8	3	22.21	22.18	22.13	1
		8	7	22.23	22.20	21.94	1
		15	0	22.22	22.24	22.12	1
	16QAM	1	0	22.31	22.34	22.32	1
		1	7	22.28	22.27	22.10	1
		1	14	22.26	22.24	22.16	1
		8	0	21.25	21.29	21.14	2
		8	3	21.16	21.15	21.07	2
		8	7	21.17	21.18	21.02	2
		15	0	21.20	21.20	21.12	2

				Frequency 1852.5 MHz	Frequency 1880 MHz	Frequency 1907.5 MHz	(dB)
5 MHz	QPSK	1	0	23.25	23.28	23.25	0
		1	12	23.12	23.08	23.03	0
		1	24	23.18	23.13	22.93	0
		12	0	22.27	22.29	22.23	1
		12	6	22.24	22.21	22.16	1
		12	13	22.26	22.23	21.97	1
		25	0	22.25	22.27	22.15	1
	16QAM	1	0	22.34	22.37	22.35	1
		1	12	22.31	22.30	22.13	1
		1	24	22.29	22.27	22.19	1
		12	0	21.28	21.32	21.17	2
		12	6	21.19	21.18	21.10	2
		12	13	21.20	21.21	21.05	2
		25	0	21.23	21.23	21.15	2
LTE Band 2							
BW	Modulation	RB Size	RB Offset	Low CH 18650	Mid CH 18900	High CH 19150	3GPP MPR (dB)
				Frequency 1855 MHz	Frequency 1880 MHz	Frequency 1905 MHz	
10 MHz	QPSK	1	0	23.27	23.30	23.27	0
		1	24	23.14	23.10	23.05	0
		1	49	23.20	23.15	22.95	0
		25	0	22.29	22.31	22.25	1
		25	12	22.26	22.23	22.18	1
		25	25	22.28	22.25	21.99	1
		50	0	22.27	22.29	22.17	1
	16QAM	1	0	22.36	22.39	22.37	1
		1	24	22.33	22.32	22.15	1
		1	49	22.31	22.29	22.21	1
		25	0	21.30	21.34	21.19	2
		25	12	21.21	21.20	21.12	2
		25	25	21.22	21.23	21.07	2
		50	0	21.25	21.25	21.17	2
BW	Modulation	RB Size	RB Offset	Low CH 18675	Mid CH 18900	High CH 19125	3GPP MPR (dB)
				Frequency 1857.5 MHz	Frequency 1880 MHz	Frequency 1902.5 MHz	
15 MHz	QPSK	1	0	23.30	23.33	23.30	0
		1	37	23.17	23.13	23.08	0

		1	74	23.23	23.18	22.98	0
		36	0	22.32	22.34	22.28	1
		36	19	22.29	22.26	22.21	1
		36	39	22.31	22.28	22.02	1
		75	0	22.30	22.32	22.20	1
	16QAM	1	0	22.39	22.42	22.40	1
		1	37	22.36	22.35	22.18	1
		1	74	22.34	22.32	22.24	1
		36	0	21.33	21.37	21.22	2
		36	19	21.24	21.23	21.15	2
		36	39	21.25	21.26	21.10	2
		75	0	21.28	21.28	21.20	2

LTE Band 2

BW	Modulation	RB Size	RB Offset	Low CH	Mid CH	High CH	3GPP MPR (dB)
				18700	18900	19100	
				Frequency	Frequency	Frequency	
				1860 MHz	1880 MHz	1900 MHz	
20MHz	QPSK	1	0	23.35	23.38	23.35	0
		1	50	23.22	23.18	23.13	0
		1	99	23.28	23.23	23.03	0
		50	0	22.37	22.39	22.33	1
		50	25	22.34	22.31	22.26	1
		50	50	22.36	22.33	22.07	1
		100	0	22.35	22.37	22.25	1
	16QAM	1	0	22.44	22.47	22.45	1
		1	50	22.41	22.40	22.23	1
		1	99	22.39	22.37	22.29	1
		50	0	21.38	21.42	21.27	2
		50	25	21.29	21.28	21.20	2
		50	50	21.30	21.31	21.15	2
		100	0	21.33	21.33	21.25	2

EIRP POWER (dBm)

GSM

Channel	Frequency (MHz)	LVL (dBm)	Correction Factor(dB)	EIRP(dBm)	EIRP(mW)	Polarization (H/V)
512	1850.2	-17.66	43.83	26.17	414.00	H
661	1880.0	-17.26	43.57	26.31	427.56	H
810	1909.8	-17.91	44.57	26.66	463.45	H
512	1850.2	-16.39	46.39	30.00	1000.00	V
661	1880.0	-16.72	47.10	30.38	1090.94	V
810	1909.8	-16.66	45.98	29.32	854.28	V

EDGE

Channel	Frequency (MHz)	LVL (dBm)	Correction Factor(dB)	EIRP(dBm)	EIRP(mW)	Polarization (H/V)
512	1850.2	-21.39	43.83	22.44	175.39	H
661	1880.0	-21.55	43.57	22.02	159.22	H
810	1909.8	-20.64	44.57	23.93	247.17	H
512	1850.2	-19.02	46.39	27.37	545.76	V
661	1880.0	-19.65	47.10	27.45	555.65	V
810	1909.8	-18.99	45.98	26.99	499.57	V

WCDMA

Channel	Frequency (MHz)	LVL (dBm)	Correction Factor(dB)	EIRP(dBm)	EIRP(mW)	Polarization (H/V)
9262	1852.4	-23.62	43.83	20.21	104.95	H
9400	1880.0	-23.89	43.57	19.68	92.90	H
9538	1907.6	-23.47	44.57	21.10	128.82	H
9262	1852.4	-21.49	46.39	24.90	309.03	V
9400	1880.0	-21.87	47.10	25.23	333.27	V
9538	1907.6	-21.01	45.98	24.97	313.76	V

REMARKS: 1. EIRP Output Power (dBm) = LVL (dBm) + Correction Factor (dB).
 2. Correction factor (dB) = Free Space Loss + Antenna Factor + Cable Loss

LTE BAND 2
CHANNEL BANDWIDTH: 1.4MHz QPSK

Channel	Frequency (MHz)	LVL (dBm)	Correction Factor(dB)	EIRP(dBm)	EIRP(mW)	Polarization (H/V)	LIMIT (W)
18607	1850.7	-22.84	43.83	20.99	125.72	H	2
18900	1880.0	-23.06	43.57	20.51	112.46	H	2
19193	1909.3	-23.40	44.32	20.92	123.57	H	2
18607	1850.7	-21.73	46.41	24.68	293.83	V	2
18900	1880.0	-22.10	47.07	24.97	314.05	V	2
19193	1909.3	-22.41	45.88	23.47	222.54	V	2

NOTE: EIRP (dBm) = LVL (dBm) + Correction Factor (dB)

CHANNEL BANDWIDTH: 1.4MHz 16QAM

Channel	Frequency (MHz)	LVL (dBm)	Correction Factor(dB)	EIRP(dBm)	EIRP(mW)	Polarization (H/V)	LIMIT (W)
18607	1850.7	-23.71	43.83	20.12	102.90	H	2
18900	1880.0	-23.99	43.57	19.58	90.78	H	2
19193	1909.3	-24.36	44.32	19.96	99.06	H	2
18607	1850.7	-22.60	46.41	23.81	240.49	V	2
18900	1880.0	-23.03	47.07	24.04	253.51	V	2
19193	1909.3	-23.37	45.88	22.51	178.40	V	2

NOTE: EIRP (dBm) = LVL (dBm) + Correction Factor (dB)

CHANNEL BANDWIDTH: 3MHz QPSK

Channel	Frequency (MHz)	LVL (dBm)	Correction Factor(dB)	EIRP(dBm)	EIRP(mW)	Polarization (H/V)	LIMIT (W)
18615	1851.5	-22.82	43.82	21.00	125.95	H	2
18900	1880.0	-23.12	43.57	20.45	110.92	H	2
19185	1908.5	-23.35	44.38	21.03	126.65	H	2
18615	1851.5	-21.71	46.45	24.74	297.92	V	2
18900	1880.0	-22.16	47.07	24.91	309.74	V	2
19185	1908.5	-22.36	45.88	23.52	224.91	V	2

NOTE: EIRP (dBm) = LVL (dBm) + Correction Factor (dB)

CHANNEL BANDWIDTH: 3MHz 16QAM

Channel	Frequency (MHz)	LVL (dBm)	Correction Factor(dB)	EIRP(dBm)	EIRP(mW)	Polarization (H/V)	LIMIT (W)
18615	1851.5	-23.89	43.82	19.93	98.45	H	2
18900	1880.0	-24.01	43.57	19.56	90.36	H	2
19185	1908.5	-24.34	44.38	20.04	100.83	H	2
18615	1851.5	-22.78	46.45	23.67	232.86	V	2
18900	1880.0	-23.05	47.07	24.02	252.35	V	2
19185	1908.5	-23.35	45.88	22.53	179.06	V	2

NOTE: EIRP (dBm) = LVL (dBm) + Correction Factor (dB)

CHANNEL BANDWIDTH: 5MHz QPSK

Channel	Frequency (MHz)	LVL (dBm)	Correction Factor(dB)	EIRP(dBm)	EIRP(mW)	Polarization (H/V)	LIMIT (W)
18625	1852.5	-22.88	43.83	20.95	124.39	H	2
18900	1880.0	-23.07	43.57	20.50	112.20	H	2
19175	1907.5	-23.30	44.19	20.89	122.69	H	2
18625	1852.5	-21.77	46.46	24.69	294.65	V	2
18900	1880.0	-22.11	47.07	24.96	313.33	V	2
19175	1907.5	-22.31	45.89	23.58	228.09	V	2

NOTE: EIRP (dBm) = LVL (dBm) + Correction Factor (dB)

CHANNEL BANDWIDTH: 5MHz 16QAM

Channel	Frequency (MHz)	LVL (dBm)	Correction Factor(dB)	EIRP(dBm)	EIRP(mW)	Polarization (H/V)	LIMIT (W)
18625	1852.5	-23.71	43.83	20.12	102.75	H	2
18900	1880.0	-24.09	43.57	19.48	88.72	H	2
19175	1907.5	-24.40	44.19	19.79	95.24	H	2
18625	1852.5	-22.60	46.46	23.86	243.39	V	2
18900	1880.0	-23.13	47.07	23.94	247.74	V	2
19175	1907.5	-23.41	45.89	22.48	177.05	V	2

NOTE: EIRP (dBm) = LVL (dBm) + Correction Factor (dB)

CHANNEL BANDWIDTH: 10MHz QPSK

Channel	Frequency (MHz)	LVL (dBm)	Correction Factor(dB)	EIRP(dBm)	EIRP(mW)	Polarization (H/V)	LIMIT (W)
18650	1855.0	-22.69	43.86	21.17	130.95	H	2
18900	1880.0	-23.20	43.57	20.37	108.89	H	2
19150	1905.0	-23.17	43.99	20.82	120.89	H	2
18650	1855.0	-21.58	46.28	24.70	294.99	V	2
18900	1880.0	-22.05	47.07	25.02	317.69	V	2
19150	1905.0	-22.18	45.92	23.74	236.70	V	2

NOTE: EIRP (dBm) = LVL (dBm) + Correction Factor (dB)

CHANNEL BANDWIDTH: 10MHz 16QAM

Channel	Frequency (MHz)	LVL (dBm)	Correction Factor(dB)	EIRP(dBm)	EIRP(mW)	Polarization (H/V)	LIMIT (W)
18650	1855.0	-23.84	43.86	20.02	100.48	H	2
18900	1880.0	-24.11	43.57	19.46	88.31	H	2
19150	1905.0	-24.33	43.99	19.66	92.56	H	2
18650	1855.0	-22.73	46.28	23.55	226.36	V	2
18900	1880.0	-23.15	47.07	23.92	246.60	V	2
19150	1905.0	-23.34	45.92	22.58	181.22	V	2

NOTE: EIRP (dBm) = LVL (dBm) + Correction Factor (dB)

CHANNEL BANDWIDTH: 15MHz QPSK

Channel	Frequency (MHz)	LVL (dBm)	Correction Factor(dB)	EIRP(dBm)	EIRP(mW)	Polarization (H/V)	LIMIT (W)
18675	1857.5	-22.70	43.99	21.29	134.65	H	2
18900	1880.0	-23.08	43.57	20.49	111.94	H	2
19125	1902.5	-23.24	43.66	20.42	110.03	H	2
18675	1857.5	-21.59	45.93	24.34	271.46	V	2
18900	1880.0	-22.12	47.07	24.95	312.61	V	2
19125	1902.5	-22.25	46.20	23.95	248.43	V	2

NOTE: EIRP (dBm) = LVL (dBm) + Correction Factor (dB)

CHANNEL BANDWIDTH: 15MHz 16QAM

Channel	Frequency (MHz)	LVL (dBm)	Correction Factor(dB)	EIRP(dBm)	EIRP(mW)	Polarization (H/V)	LIMIT (W)
18675	1857.5	-23.56	43.99	20.43	110.46	H	2
18900	1880.0	-23.95	43.57	19.62	91.62	H	2
19125	1902.5	-24.09	43.66	19.57	90.47	H	2
18675	1857.5	-22.45	45.93	23.48	222.69	V	2
18900	1880.0	-22.99	47.07	24.08	255.86	V	2
19125	1902.5	-23.10	46.20	23.10	204.27	V	2

NOTE: EIRP (dBm) = LVL (dBm) + Correction Factor (dB)

CHANNEL BANDWIDTH: 20MHz QPSK

Channel	Frequency (MHz)	LVL (dBm)	Correction Factor(dB)	EIRP(dBm)	EIRP(mW)	Polarization (H/V)	LIMIT (W)
18700	1860.0	-23.28	43.50	20.22	105.17	H	2
18900	1880.0	-23.53	43.57	20.04	100.93	H	2
19100	1900.0	-23.82	43.62	19.80	95.41	H	2
18700	1860.0	-22.17	45.57	23.40	218.78	V	2
18900	1880.0	-22.57	47.07	24.50	281.84	V	2
19100	1900.0	-22.83	46.26	23.43	220.34	V	2

NOTE: EIRP (dBm) = LVL (dBm) + Correction Factor (dB)

CHANNEL BANDWIDTH: 20MHz 16QAM

Channel	Frequency (MHz)	LVL (dBm)	Correction Factor(dB)	EIRP(dBm)	EIRP(mW)	Polarization (H/V)	LIMIT (W)
18700	1860.0	-24.21	43.50	19.29	84.90	H	2
18900	1880.0	-24.60	43.57	18.97	78.89	H	2
19100	1900.0	-24.65	43.62	18.97	78.81	H	2
18700	1860.0	-23.10	45.57	22.47	176.60	V	2
18900	1880.0	-23.64	47.07	23.43	220.29	V	2
19100	1900.0	-23.66	46.26	22.60	182.01	V	2

NOTE: EIRP (dBm) = LVL (dBm) + Correction Factor (dB)

4.2 Frequency Stability Measurement

4.2.1 Limits of Frequency Stability Measurement

The frequency stability shall be sufficient to ensure that the fundamental emission stays within the authorized frequency block.

4.2.2 Test Procedure

- Device is placed at the oven room. The oven room could control the temperatures and humidity. Power warm up is at least 15 min and power applied should perform before recording frequency error.
- EUT is connected the external power supply to control the DC input power. The test voltage range is from minimum to maximum working voltage. Each step shall be record the frequency error rate.
- The temperature range step is 10 degrees in this test items. All temperature levels shall be hold the $\pm 0.5^{\circ}\text{C}$ during the measurement testing. The each temperature step shall be at least 0.5 hours, consider the EUT could be test under the stability condition.

NOTE: The frequency error was recorded frequency error from the communication simulator.

4.2.3 Test Setup

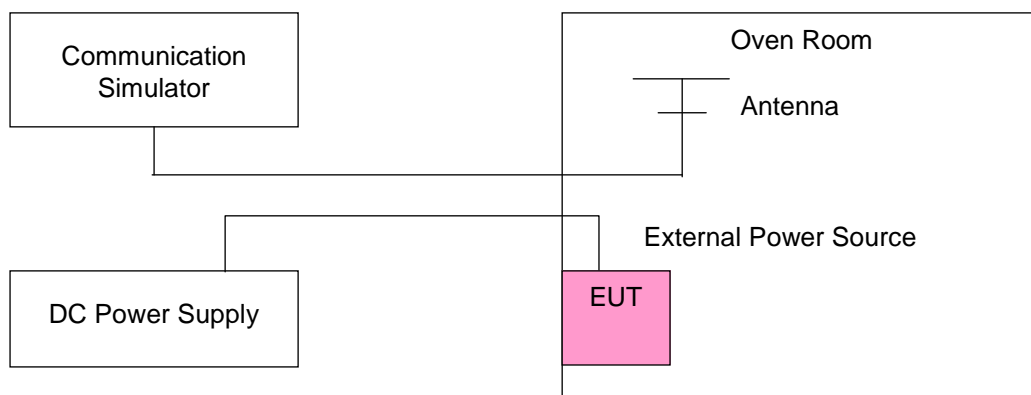

4.2.4 Test Results

FREQUENCY ERROR VS. VOLTAGE

VOLTAGE (Volts)	FREQUENCY ERROR (ppm)			LIMIT (ppm)
	GSM	EDGE	WCDMA	
3.8	0.0013	0.0015	0.0014	2.5
3.6	0.0012	0.0014	0.0011	2.5
4.35	0.0012	0.0012	0.0012	2.5

NOTE: The applicant defined the normal working voltage of the battery is from 3.6Vdc to 4.35Vdc.

FREQUENCY ERROR vs. TEMPERATURE.

TEMP. (°C)	FREQUENCY ERROR (ppm)			LIMIT (ppm)
	GSM	EDGE	WCDMA	
-30	0.0033	0.0038	0.0031	2.5
-20	0.0026	0.0033	0.0033	2.5
-10	0.0040	0.0028	0.0039	2.5
0	0.0034	0.0039	0.0025	2.5
10	0.0043	0.0036	0.0028	2.5
20	0.0033	0.0029	0.0041	2.5
30	0.0028	0.0031	0.0034	2.5
40	0.0034	0.0033	0.0040	2.5
50	0.0046	0.0040	0.0025	2.5
60	0.0025	0.0026	0.0044	2.5

LTE BAND 2

AFC FREQUENCY ERROR vs. VOLTAGE							
VOLTAGE (Volts)	FREQUENCY ERROR (ppm)						LIMIT (ppm)
	1.4MHz	3MHz	5MHz	10MHz	15MHz	20MHz	
3.8	0.0025	0.0029	0.0031	0.0027	0.0028	0.0028	2.5
3.6	0.0031	0.0030	0.0032	0.0028	0.0031	0.0029	2.5
4.35	0.0028	0.0029	0.0028	0.0029	0.0026	0.0031	2.5

NOTE: The applicant defined the normal working voltage of the battery is from 3.6Vdc to 4.35Vdc.

AFC FREQUENCY ERROR vs. TEMPERATURE							
TEMP. (°C)	FREQUENCY ERROR (ppm)						LIMIT (ppm)
	1.4MHz	3MHz	5MHz	10MHz	15MHz	20MHz	
-30	0.0034	0.0046	0.0031	0.0045	0.0044	0.0048	2.5
-20	0.0034	0.0041	0.0033	0.0032	0.0025	0.0041	2.5
-10	0.0051	0.0034	0.0034	0.0041	0.0044	0.0029	2.5
0	0.0030	0.0029	0.0029	0.0025	0.0025	0.0033	2.5
10	0.0025	0.0025	0.0030	0.0031	0.0028	0.0041	2.5
20	0.0045	0.0041	0.0039	0.0025	0.0022	0.0028	2.5
30	0.0038	0.0022	0.0043	0.0012	0.0035	0.0023	2.5
40	0.0034	0.0023	0.0040	0.0025	0.0026	0.0016	2.5
50	0.0028	0.0039	0.0025	0.0026	0.0052	0.0030	2.5
60	0.0022	0.0037	0.0028	0.0044	0.0037	0.0026	2.5

4.3 Occupied Bandwidth Measurement

4.3.1 Test Procedure

The EUT makes a call to the communication simulator. All measurements were done at low, middle and high operational frequency range. The communication simulator station system controlled a EUT to export maximum output power under transmission mode and specific channel frequency. Use OBW measurement function of Spectrum analyzer to measure 99 % occupied bandwidth.

4.3.2 Test Setup

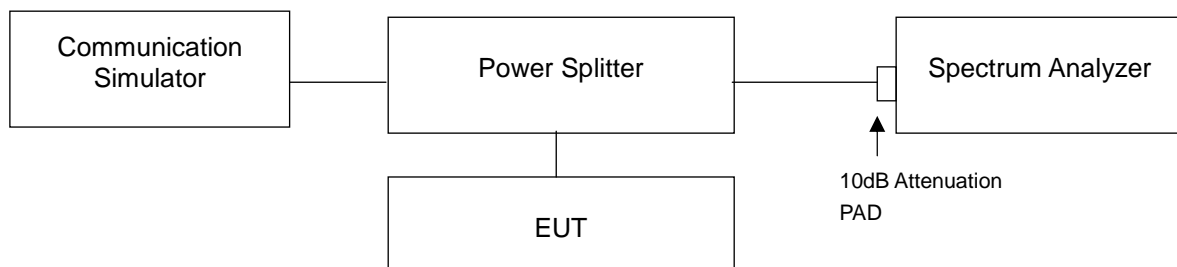

4.3.3 Test Result

CHANNEL	FREQUENCY (MHz)	99% OCCUPIED BANDWIDTH (kHz)		CHANNEL	FREQUENCY (MHz)	99% OCCUPIED BANDWIDTH (MHz)
		GSM	EDGE			WCDMA
512	1850.2	246.00	250.00	9262	1852.4	4.21
661	1880.0	247.00	248.00	9400	1880.0	4.21
810	1909.8	242.00	248.00	9538	1907.6	4.24

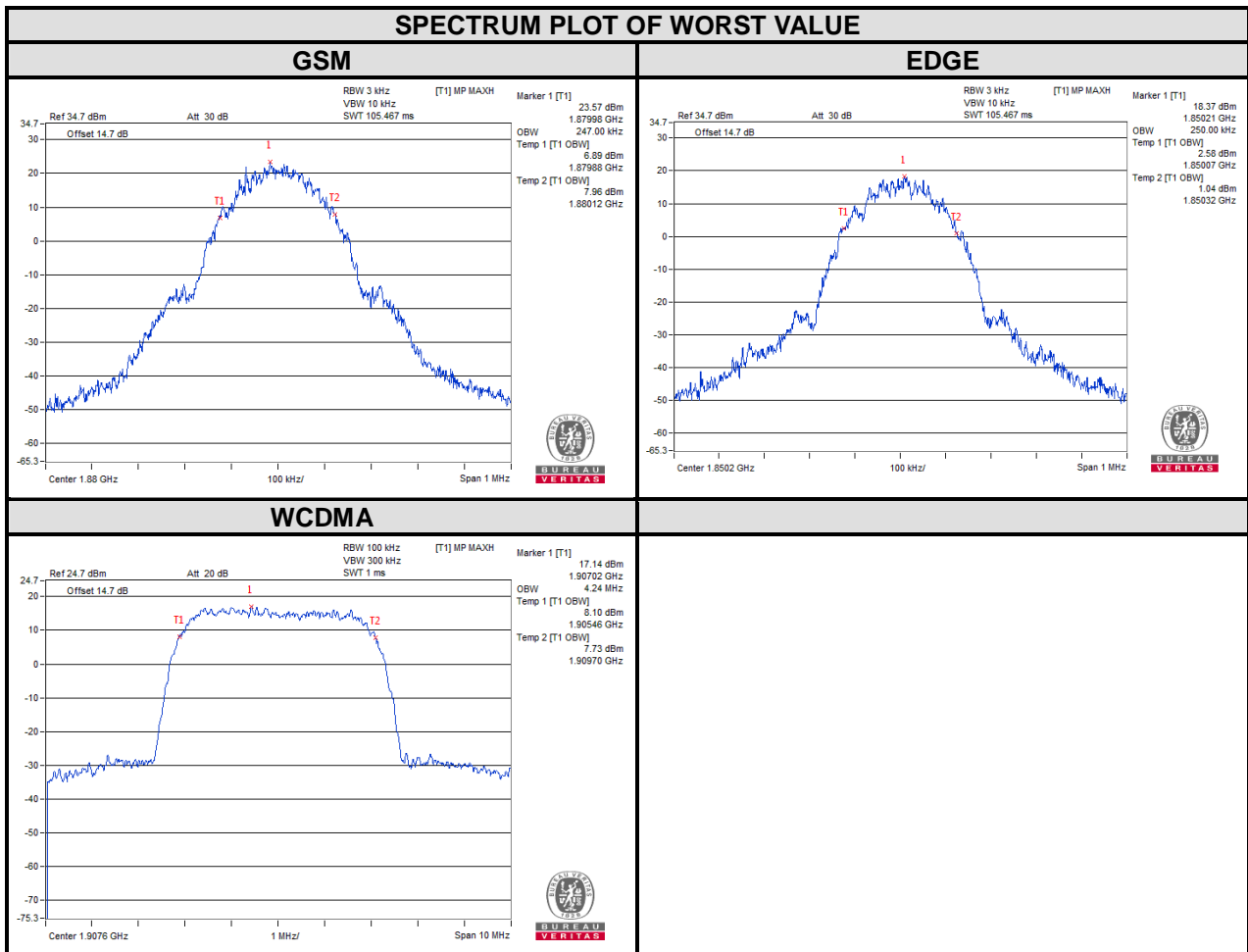

CHANNEL	FREQUENCY (MHz)	26dB BANDWIDTH (kHz)		CHANNEL	FREQUENCY (MHz)	26dB BANDWIDTH (MHz)
		GSM	EDGE			
512	1850.2	316.11	325.42	9262	1852.4	4.88
661	1880.0	321.30	321.91	9400	1880.0	4.88
810	1909.8	318.12	320.34	9538	1907.6	4.89

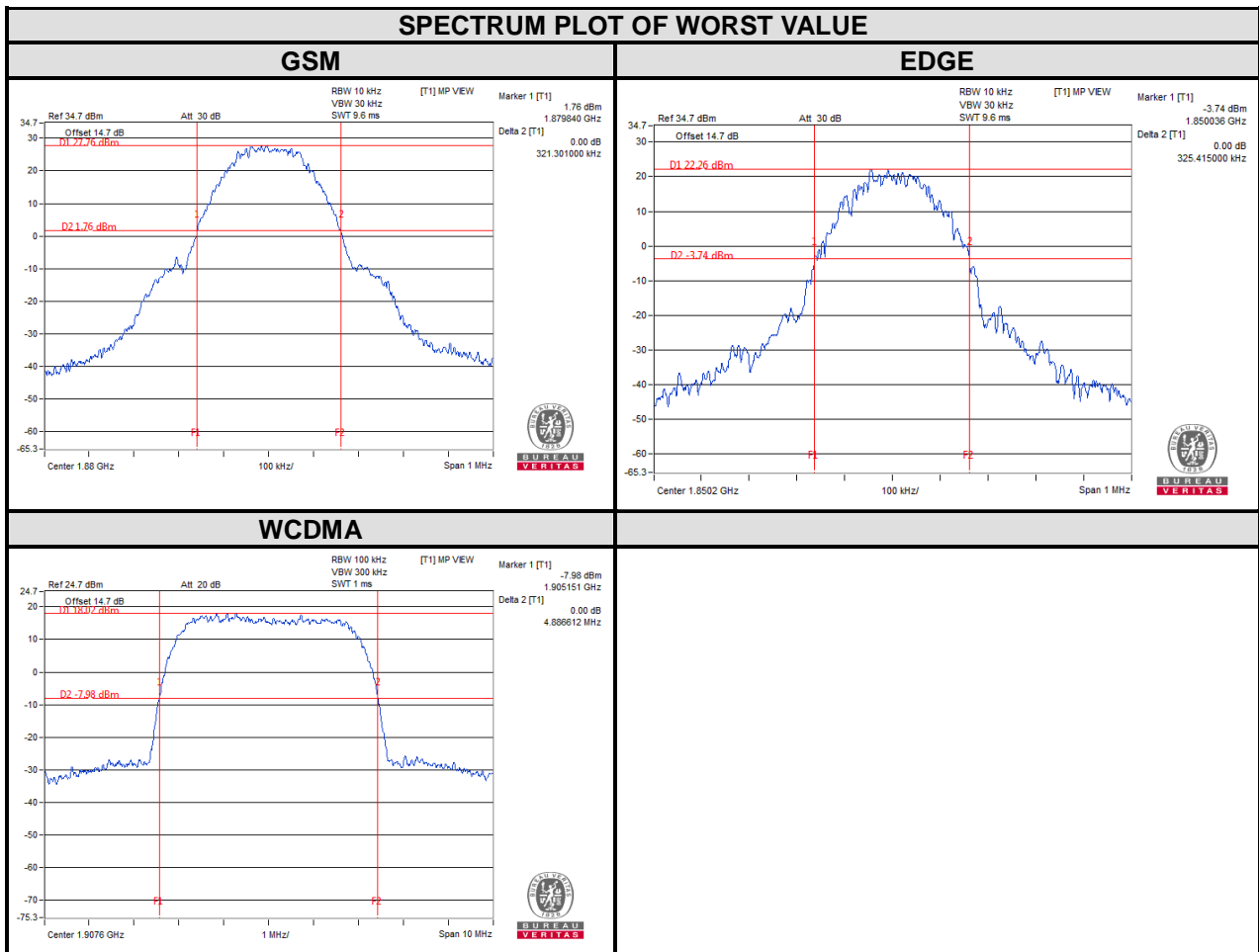

LTE band 2							
Channel Bandwidth : 1.4MHz							
Channel	Frequency (MHz)	99% Occupied bandwidth (MHz)		Channel	Frequency (MHz)	26 dB bandwidth (MHz)	
		QPSK	16QAM			QPSK	16QAM
18607	1850.7	1.09	1.08	18607	1850.7	1.24	1.25
18900	1880	1.09	1.08	18900	1880	1.24	1.24
19193	1909.3	1.09	1.09	19193	1909.3	1.25	1.24

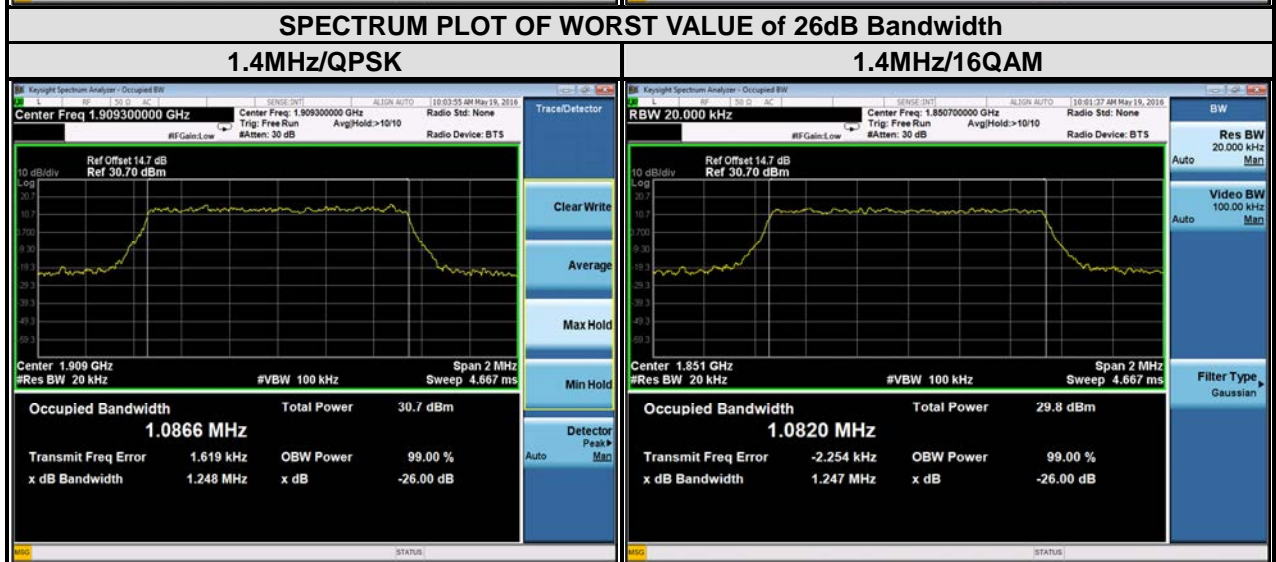
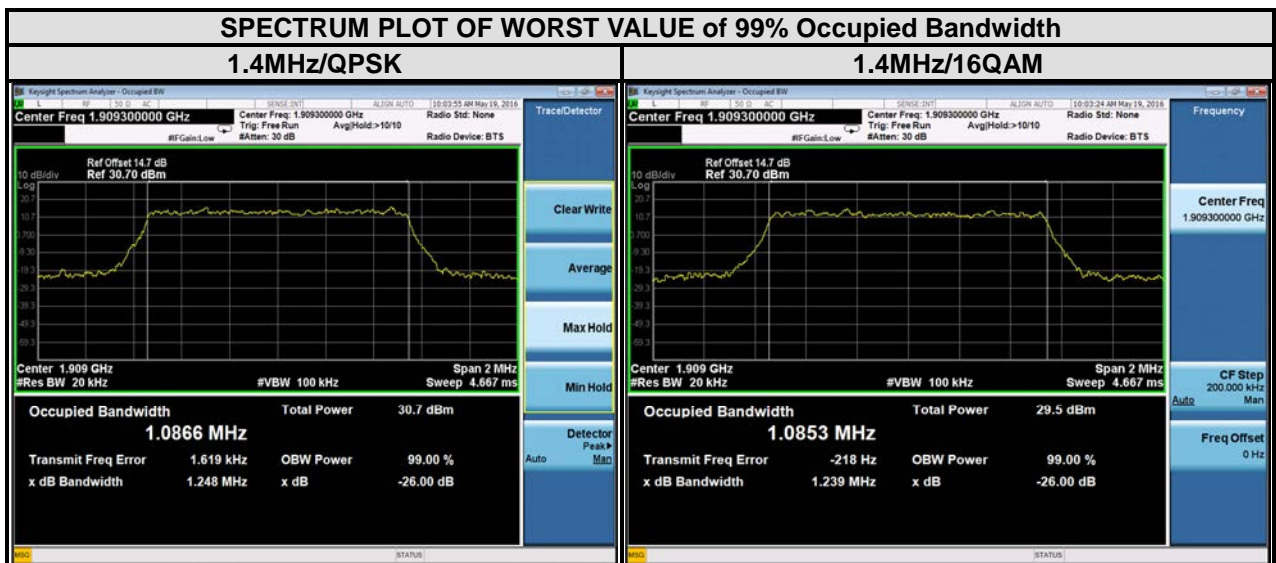

LTE band 2							
Channel Bandwidth : 3MHz							
Channel	Frequency (MHz)	99% Occupied bandwidth (MHz)		Channel	Frequency (MHz)	26 dB bandwidth (MHz)	
		QPSK	16QAM			QPSK	16QAM
18615	1851.5	2.69	2.68	18615	1851.5	2.93	2.90
18900	1880	2.69	2.68	18900	1880	2.90	2.91
19185	1908.5	2.69	2.68	19185	1908.5	2.93	2.91

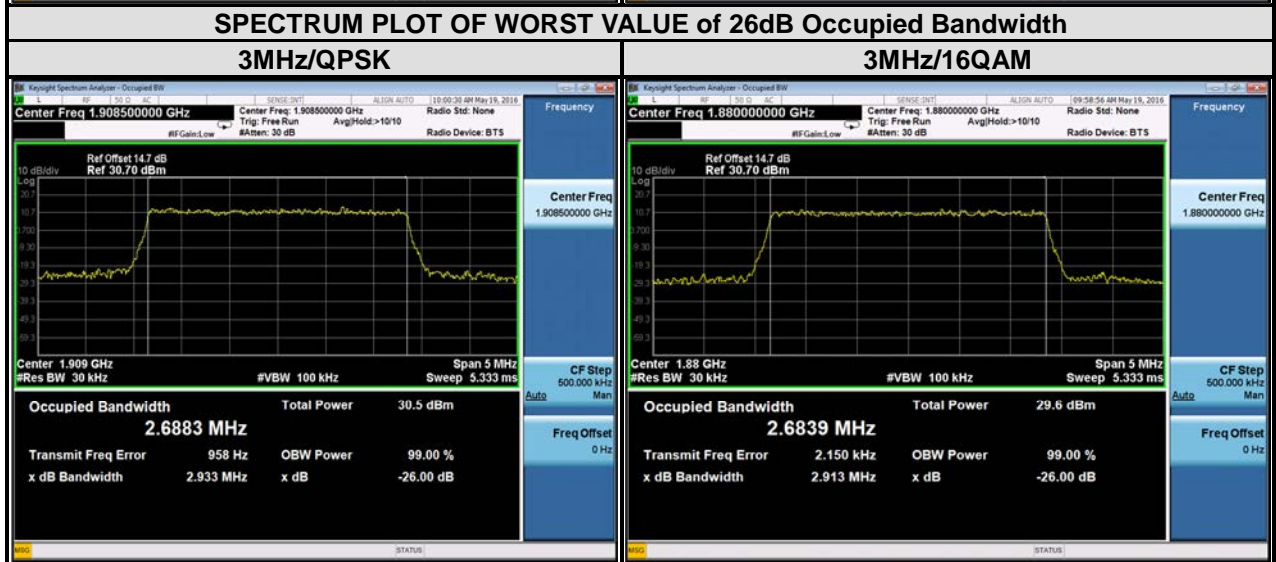
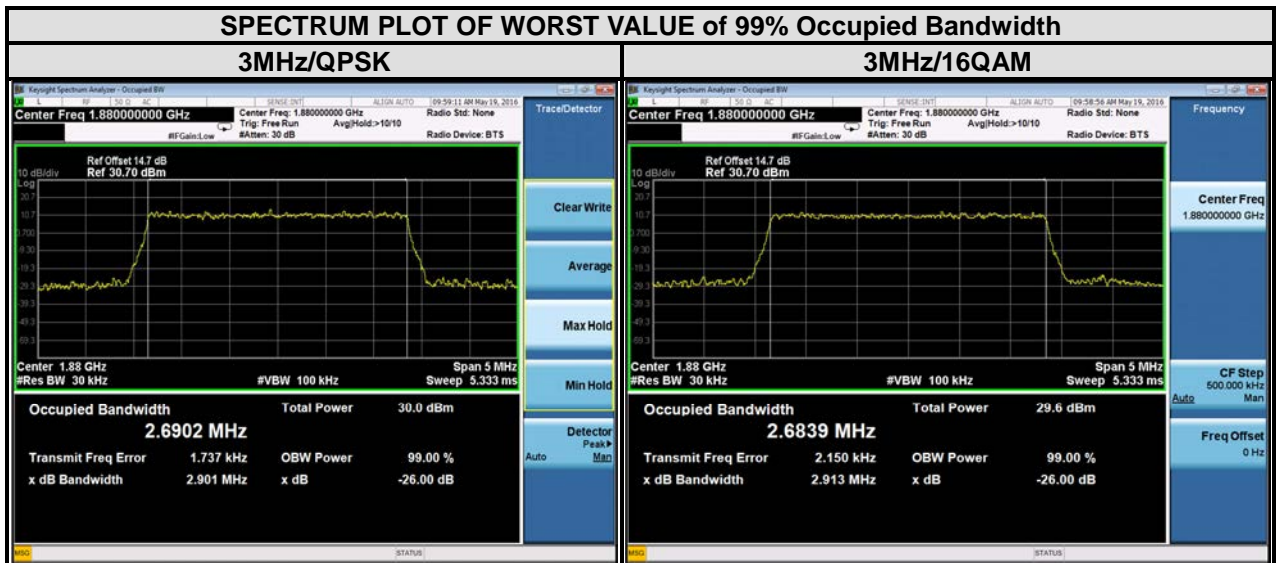

LTE band 2

Channel Bandwidth : 5 MHz

Channel	Frequency (MHz)	99% Occupied bandwidth (MHz)		Channel	Frequency (MHz)	26 dB bandwidth (MHz)	
		QPSK	16QAM			QPSK	16QAM
18625	1852.5	4.49	4.49	18625	1852.5	4.96	4.95
18900	1880	4.48	4.48	18900	1880	4.94	4.94
19175	1907.5	4.49	4.48	19175	1907.5	4.95	4.93

SPECTRUM PLOT OF WORST VALUE of 99% Occupied Bandwidth

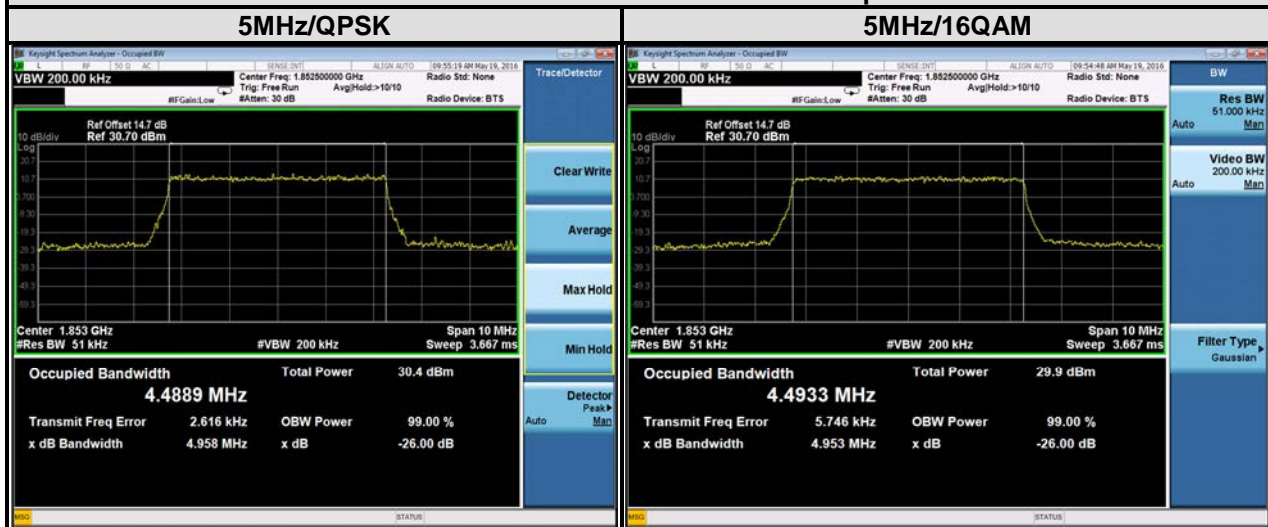

SPECTRUM PLOT OF WORST VALUE of 26dB Occupied Bandwidth

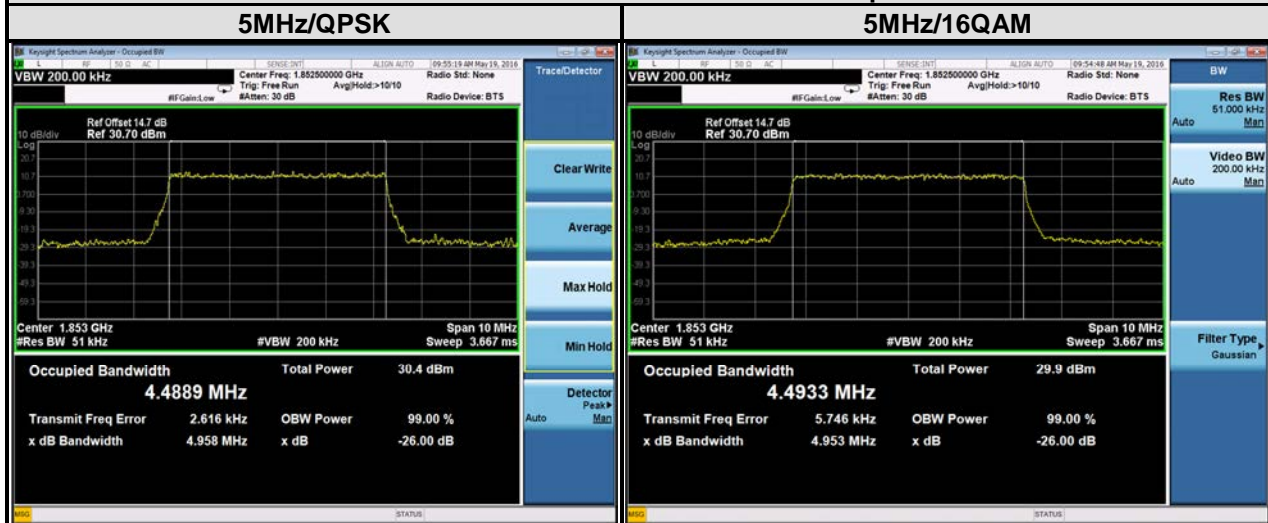

LTE band 2							
Channel Bandwidth : 10 MHz							
Channel	Frequency (MHz)	99% Occupied bandwidth (MHz)		Channel	Frequency (MHz)	26 dB bandwidth (MHz)	
		QPSK	16QAM			QPSK	16QAM
18650	1855	8.94	8.93	18650	1855	9.75	9.76
18900	1880	8.94	8.93	18900	1880	9.75	9.72
19150	1905	8.94	8.94	19150	1905	9.73	9.63

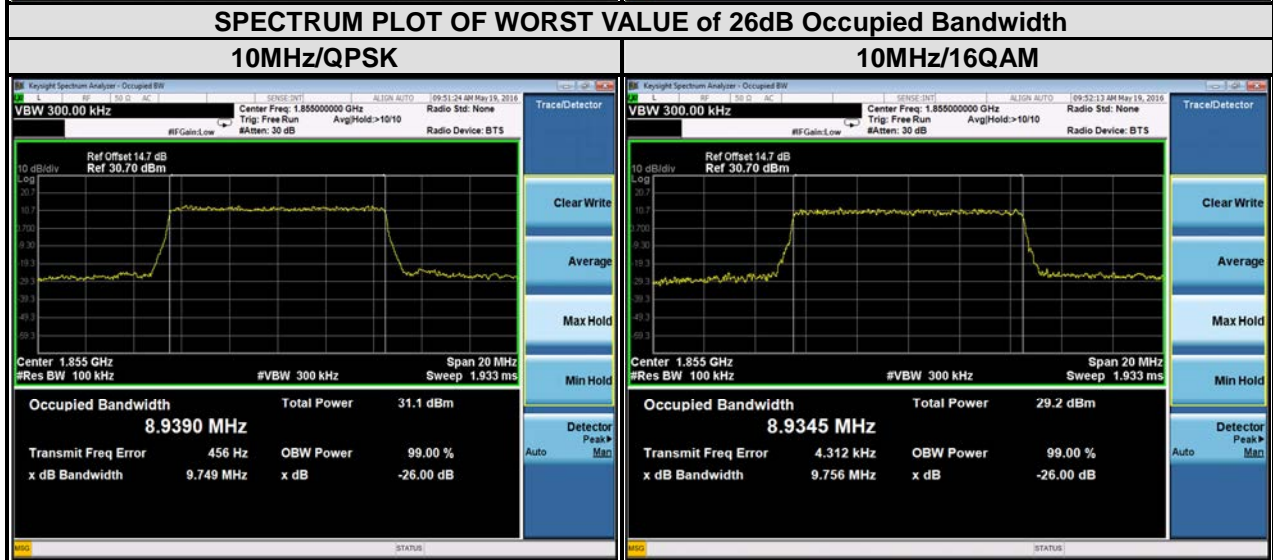
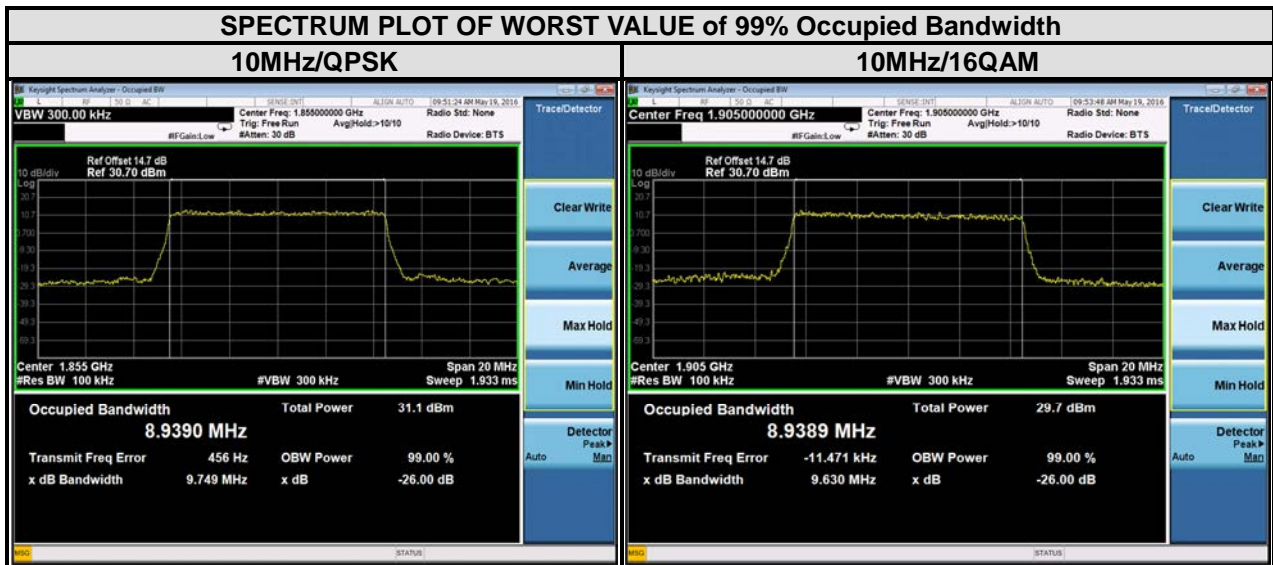

LTE band 2							
Channel Bandwidth : 15 MHz							
Channel	Frequency (MHz)	99% Occupied bandwidth (MHz)		Channel	Frequency (MHz)	26 dB bandwidth (MHz)	
		QPSK	16QAM			QPSK	16QAM
18675	1857.5	13.45	13.45	18675	1857.5	14.66	14.61
18900	1880	13.43	13.42	18900	1880	14.61	14.63
19125	1902.5	13.43	13.42	19125	1902.5	14.51	14.47

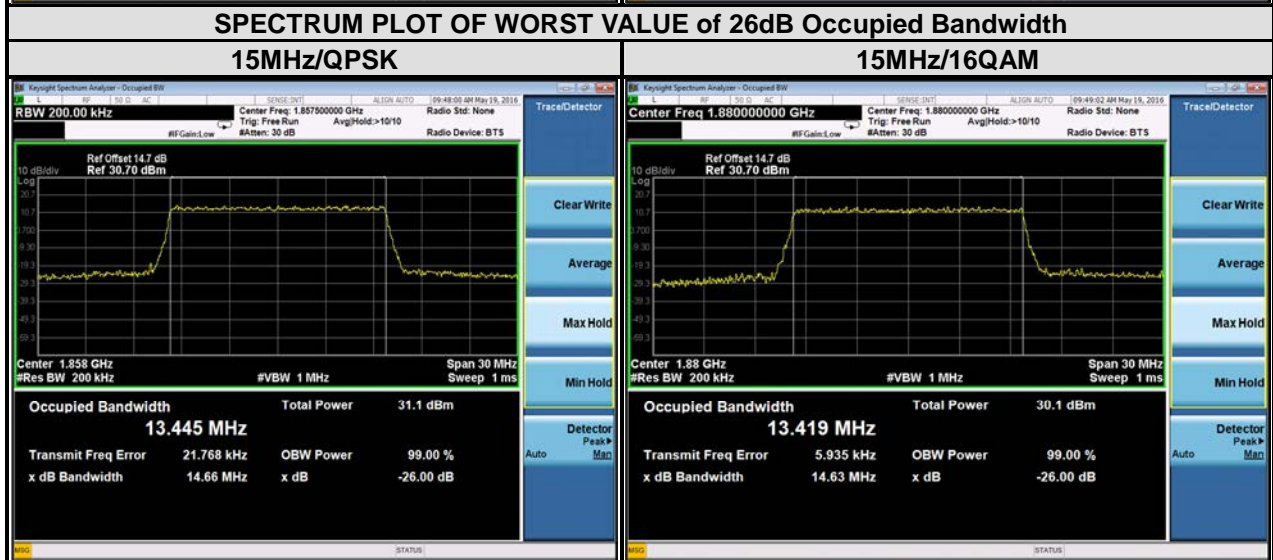
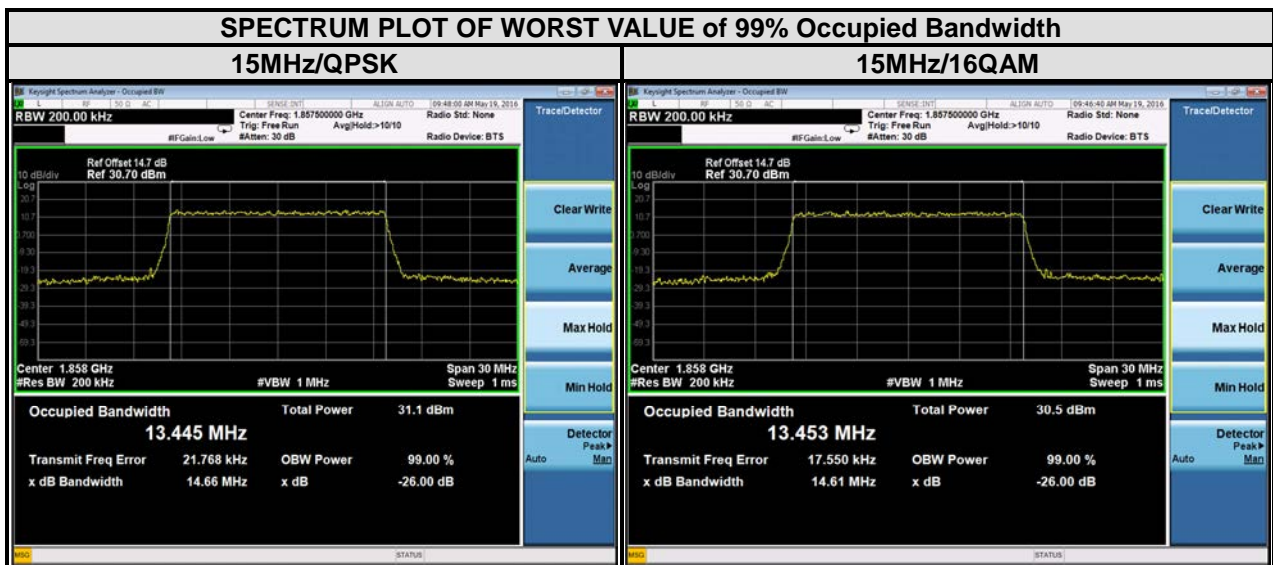

LTE band 2							
Channel Bandwidth : 20 MHz							
Channel	Frequency (MHz)	99% Occupied bandwidth (MHz)		Channel	Frequency (MHz)	26 dB bandwidth (MHz)	
		QPSK	16QAM			QPSK	16QAM
18700	1860	17.95	17.86	18700	1860	19.37	19.06
18900	1880	17.93	17.86	18900	1880	19.36	19.08
19100	1900	17.90	17.83	19100	1900	19.10	18.94

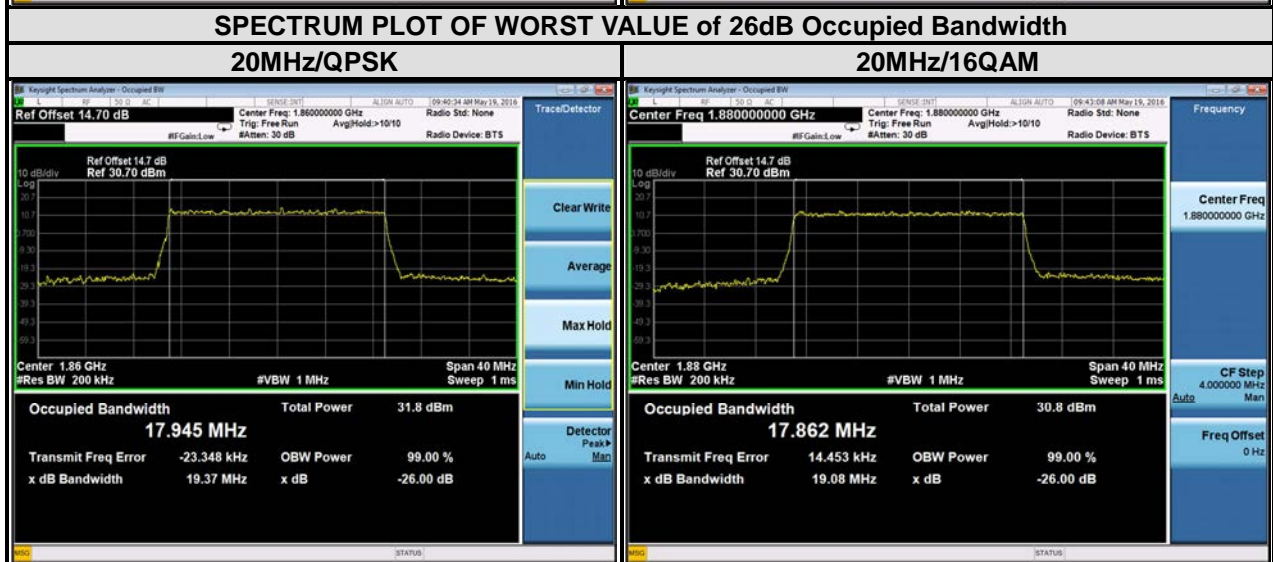
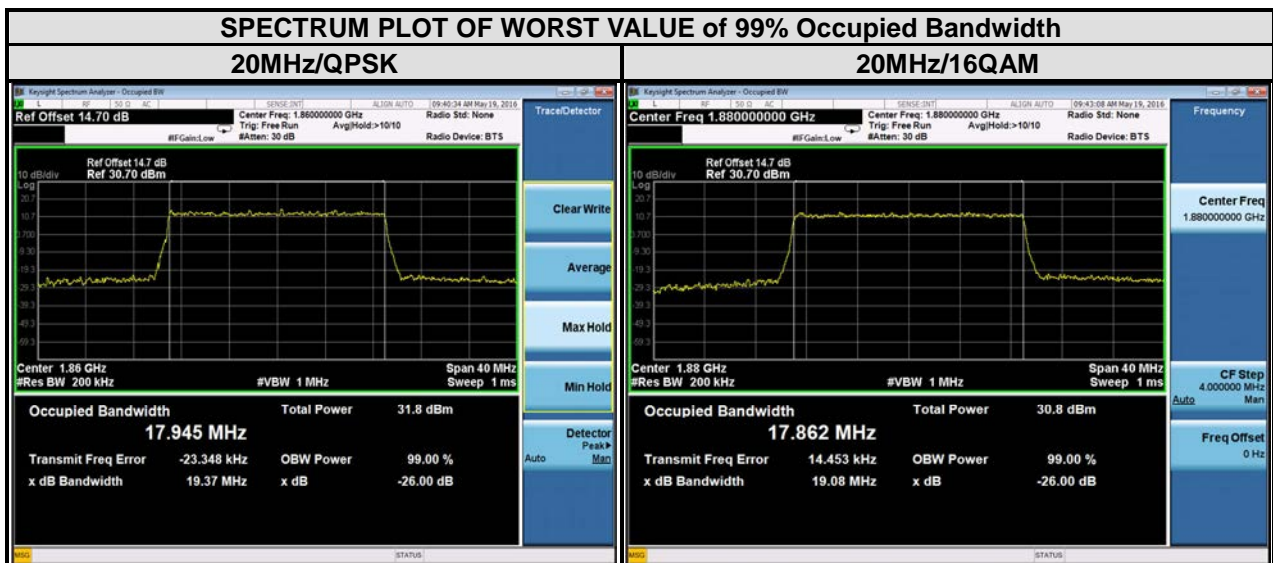

4.4 Band Edge Measurement

4.4.1 Limits of Band Edge Measurement

Power of any emission outside of the authorized operating frequency ranges must be attenuated below the transmitting power (P) by a factor of at least $43 + 10 \log(P)$ dB. In the 1 MHz bands immediately outside and adjacent to the frequency block a resolution bandwidth of at least one percent of the emission bandwidth of the fundamental emission of the transmitter may be employed.

4.4.2 Test Setup

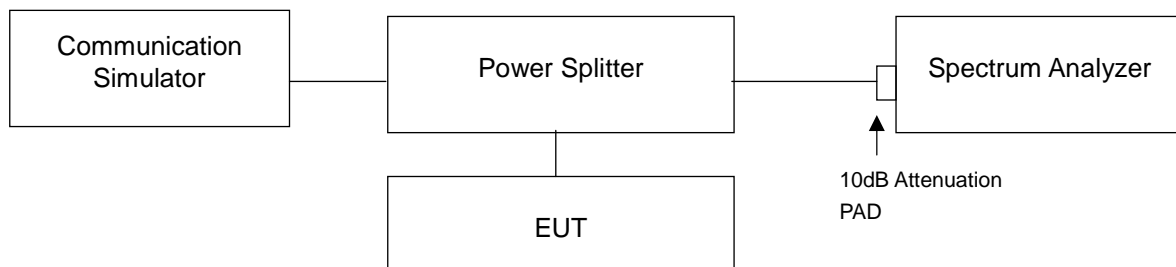

4.4.3 Test Procedures

- a. All measurements were done at low and high operational frequency range.
- b. The center frequency of spectrum is the band edge frequency and span is 1.5MHz. RB of the spectrum is 3kHz and VB of the spectrum is 10kHz (GSM/ GPRS/EDGE).
- c. The center frequency of spectrum is the band edge frequency and span is 10MHz. RB of the spectrum is 100kHz and VB of the spectrum is 300kHz (WCDMA).
- d. The center frequency of spectrum is the band edge frequency and span is 1~5 MHz. RB of the spectrum is 20kHz and VB of the spectrum is 100 kHz. (LTE bandwidth 1.4MHz)
- e. The center frequency of spectrum is the band edge frequency and span is 1~5 MHz. RB of the spectrum is 30kHz and VB of the spectrum is 100kHz. (LTE bandwidth 3MHz)
- f. The center frequency of spectrum is the band edge frequency and span is 1~5 MHz. RB of the spectrum is 50kHz and VB of the spectrum is 200kHz. (LTE bandwidth 5MHz)
- g. The center frequency of spectrum is the band edge frequency and span is 1~5 MHz. RB of the spectrum is 100kHz and VB of the spectrum is 300kHz. (LTE bandwidth 10MHz)
- h. The center frequency of spectrum is the band edge frequency and span is 1~5 MHz. RB of the spectrum is 200kHz and VB of the spectrum is 1MHz. (LTE bandwidth 15MHz)
- i. The center frequency of spectrum is the band edge frequency and span is 1~5 MHz. RB of the spectrum is 200kHz and VB of the spectrum is 1MHz. (LTE bandwidth 20MHz)
- j. Record the max trace plot into the test report.

4.4.4 Test Results

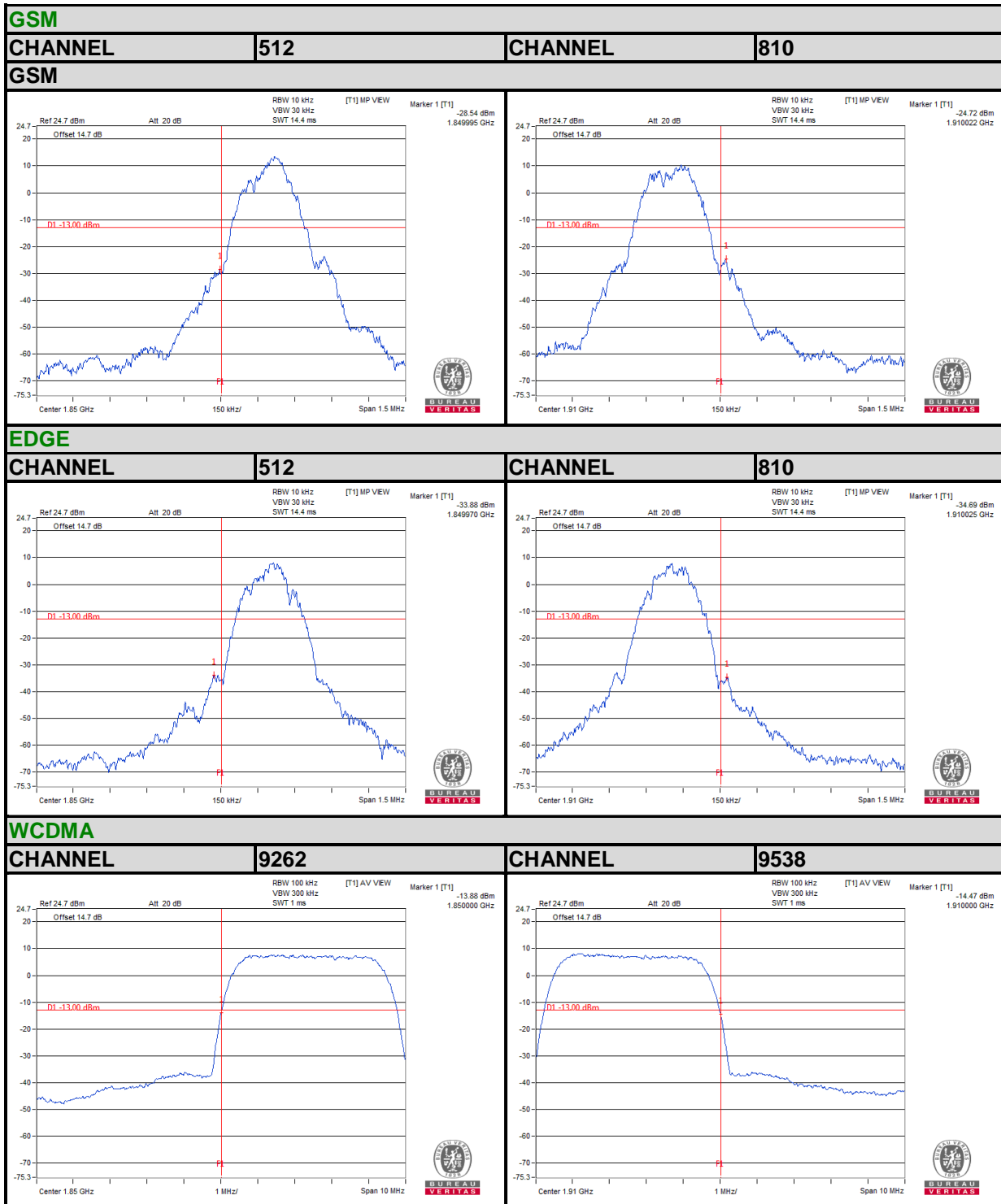

LTE BAND 2

Channel Bandwidth: 1.4MHz



LTE BAND 2

Channel Bandwidth: 3MHz

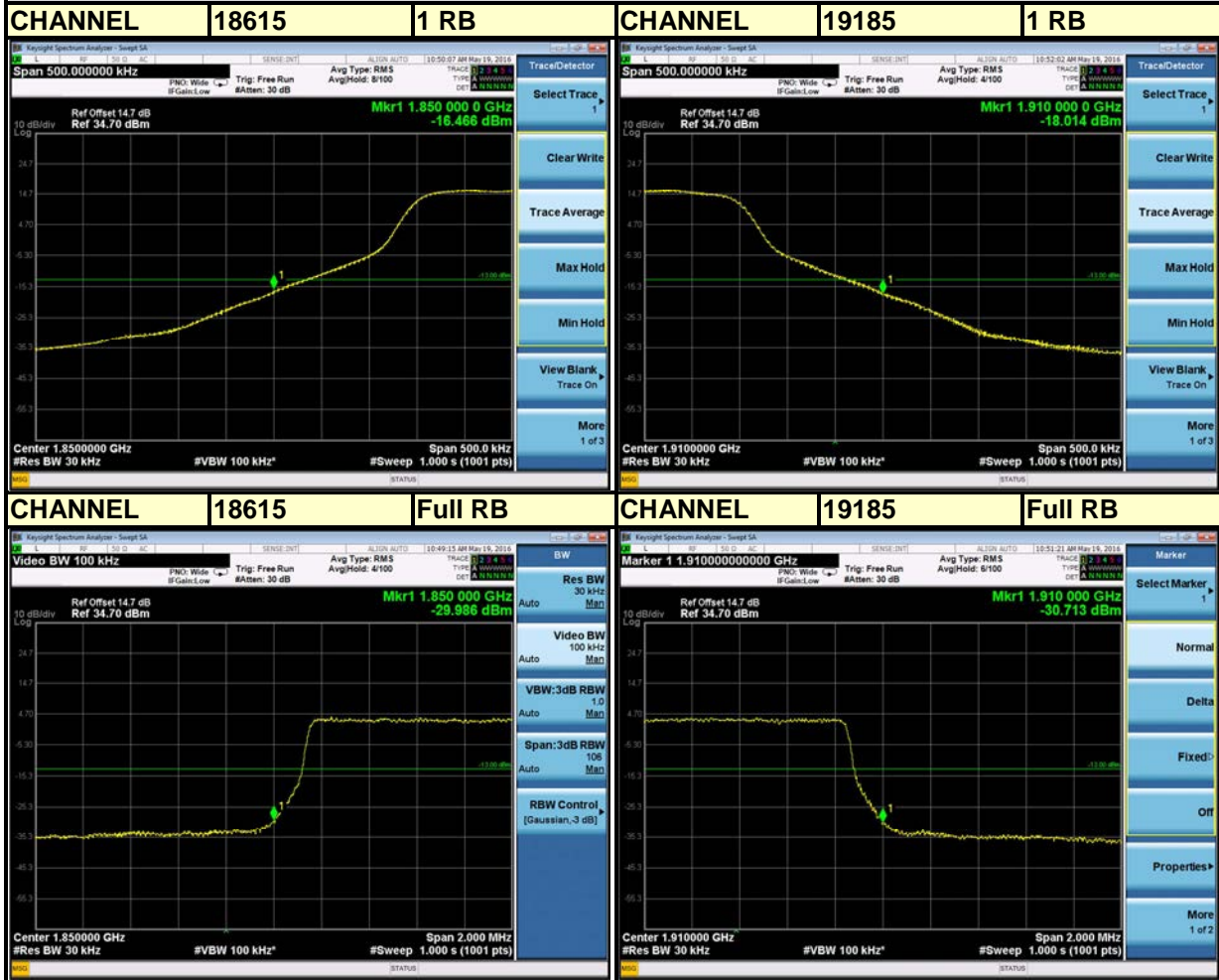

LTE BAND 2

Channel Bandwidth: 5MHz



LTE BAND 2

Channel Bandwidth: 10MHz

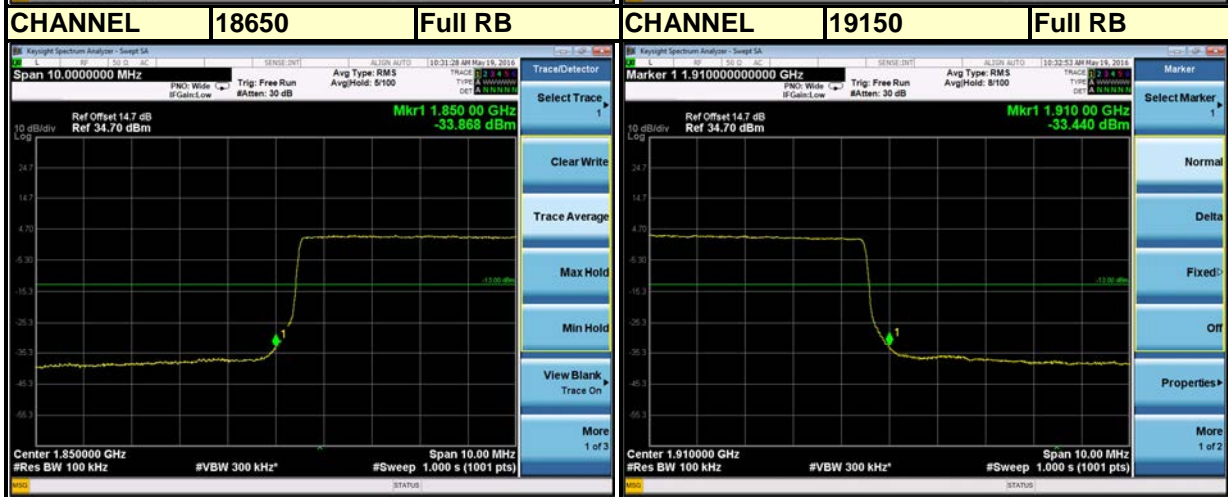
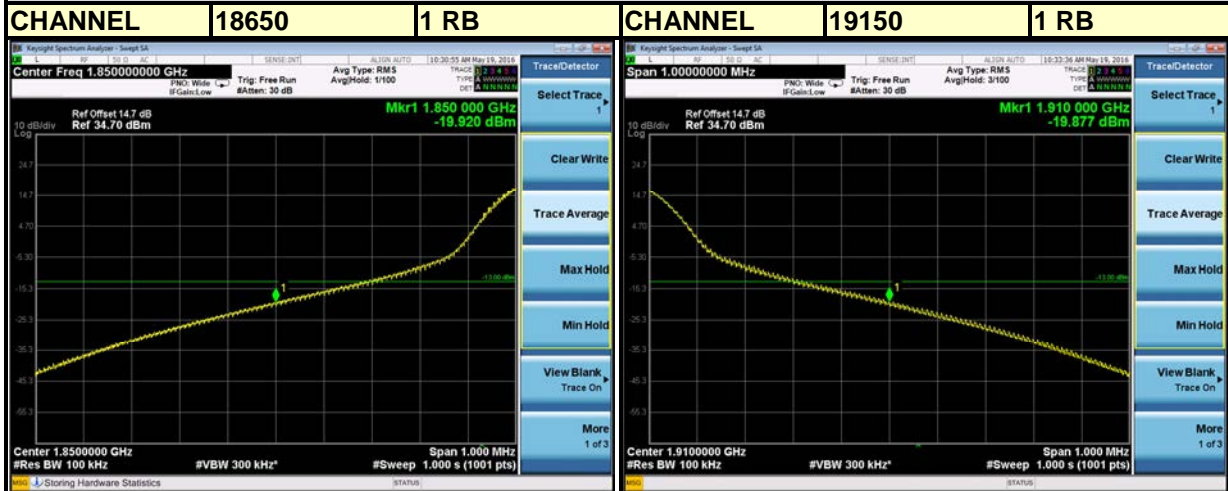

LTE BAND 2

Channel Bandwidth: 15MHz



LTE BAND 2

Channel Bandwidth: 20MHz



4.5 Peak To Average Ratio

4.5.1 Limits of Peak To Average Ratio Measurement

In measuring transmissions in this band using an average power technique, the peak to-average ratio (PAR) of the transmission may not exceed 13 dB.

4.5.2 Test Setup

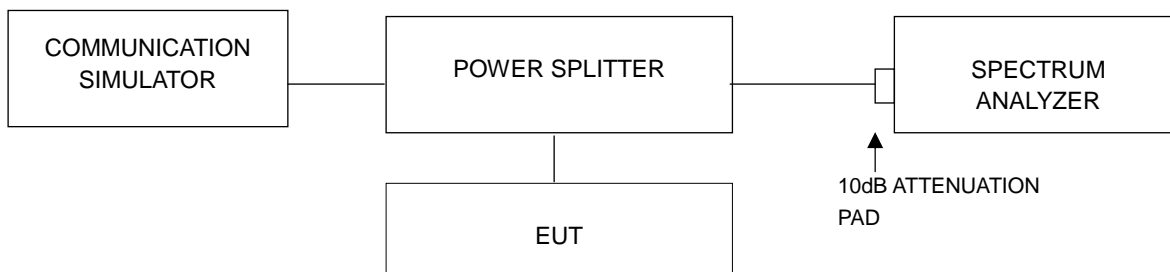

4.5.3 Test Procedures

1. Set resolution/measurement bandwidth \geq signal's occupied bandwidth;
2. Set the number of counts to a value that stabilizes the measured CCDF curve;
3. Record the maximum PAPR level associated with a probability of 0.1%.

4.5.4 Test Results

Channel	Frequency (MHz)	Peak To Average Ratio (dB)		Channel	Frequency (MHz)	Peak To Average Ratio (dB)
		GSM	EDGE			
661	1880.0	9.61	11.45	9400	1880.0	2.80

SPECTRUM PLOT OF WORST VALUE

GSM

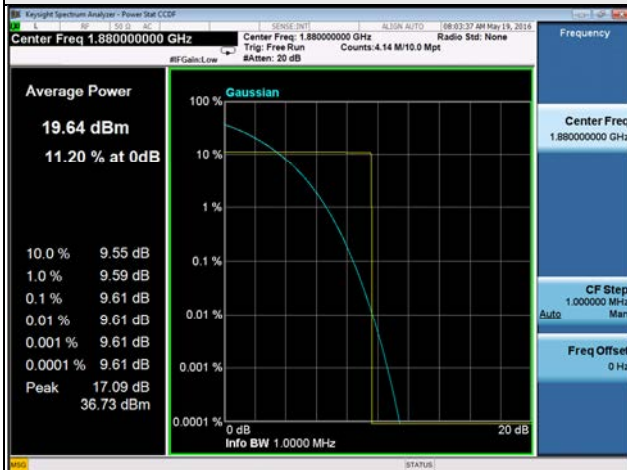

EDGE



WCDMA

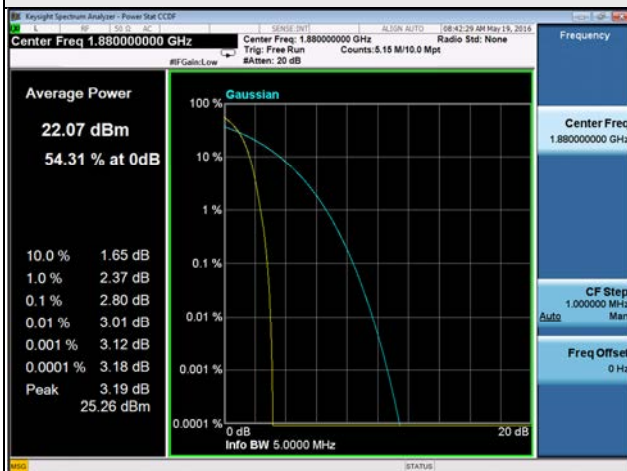

LTE BAND 2

CHANNEL BANDWIDTH: 1.4MHz				CHANNEL BANDWIDTH: 3MHz			
CHANNEL	FREQUENCY (MHz)	PEAK TO AVERAGE RATIO (dB)		CHANNEL	FREQUENCY (MHz)	PEAK TO AVERAGE RATIO (dB)	
		QPSK	16QAM			QPSK	16QAM
18607	1850.7	4.62	5.46	18615	1851.5	4.93	5.74
18900	1880	5.24	6.04	18900	1880	5.40	6.11
19193	1909.3	4.68	5.58	19185	1908.5	4.94	5.77

SPECTRUM PLOT OF WORST VALUE

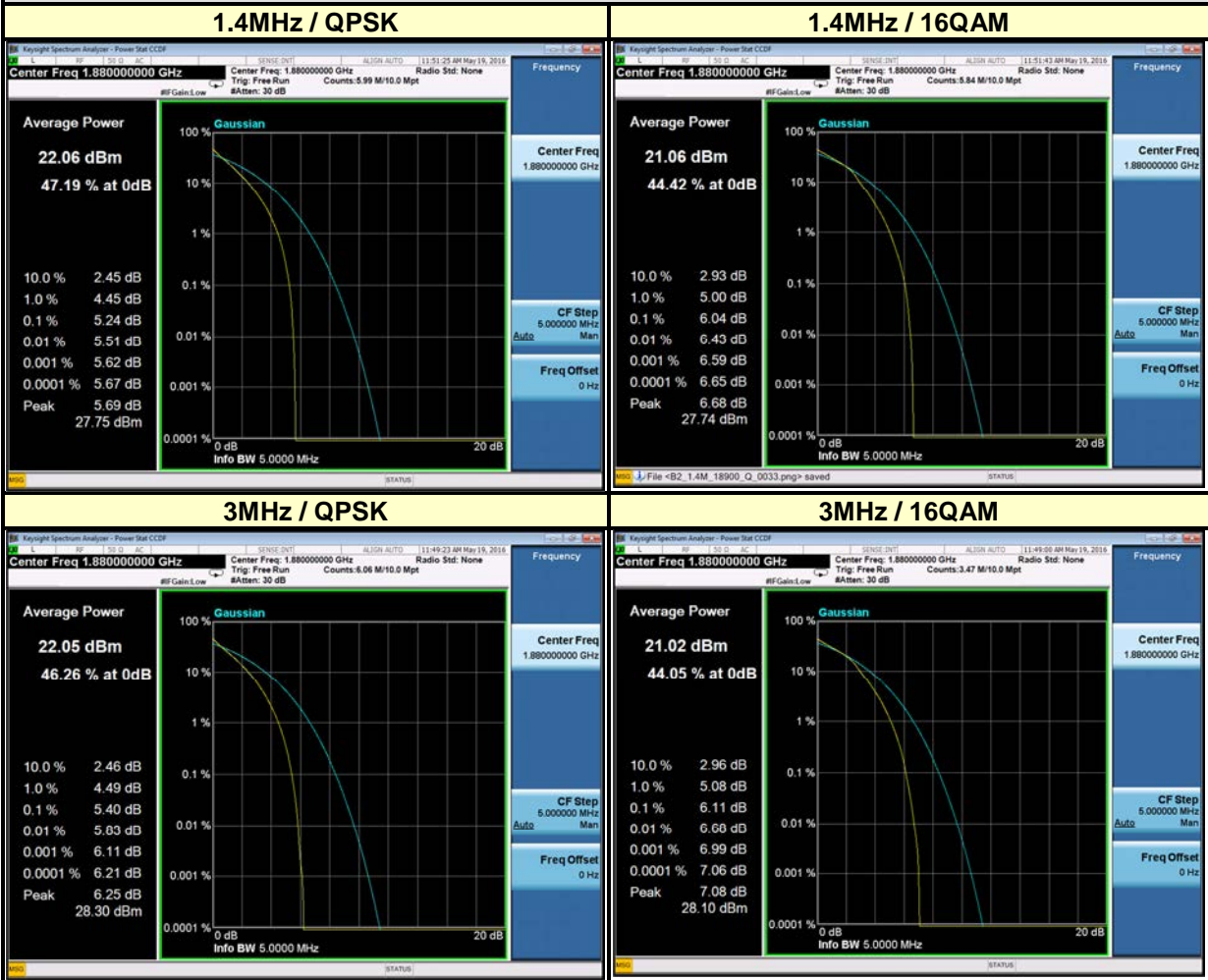

CHANNEL BANDWIDTH: 5MHz				CHANNEL BANDWIDTH: 10MHz			
CHANNEL	FREQUENCY (MHz)	PEAK TO AVERAGE RATIO (dB)		CHANNEL	FREQUENCY (MHz)	PEAK TO AVERAGE RATIO (dB)	
		QPSK	16QAM			QPSK	16QAM
18625	1852.5	5.38	6.05	18650	1855	5.31	6.03
18900	1880	5.53	6.23	18900	1880	5.38	6.13
19175	1907.5	5.26	5.99	19150	1905	4.94	5.71

SPECTRUM PLOT OF WORST VALUE

5MHz / QPSK

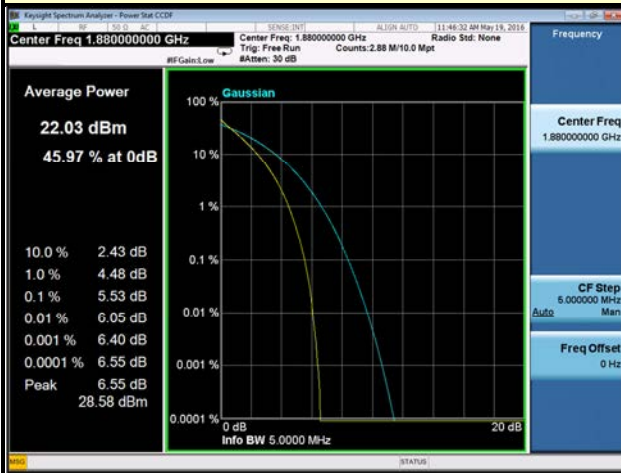

5MHz / 16QAM



10MHz / QPSK

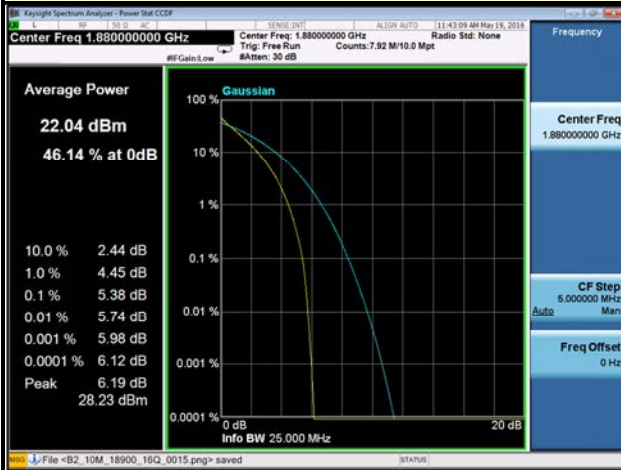

10MHz / 16QAM



CHANNEL BANDWIDTH: 15MHz				CHANNEL BANDWIDTH: 20MHz			
CHANNEL	FREQUENCY (MHz)	PEAK TO AVERAGE RATIO (dB)		CHANNEL	FREQUENCY (MHz)	PEAK TO AVERAGE RATIO (dB)	
		QPSK	16QAM			QPSK	16QAM
18675	1857.5	5.32	6.03	18700	1860	5.39	6.13
18900	1880	5.43	6.17	18900	1880	5.50	6.23
19125	1902.5	5.01	5.79	19100	1900	5.15	5.97

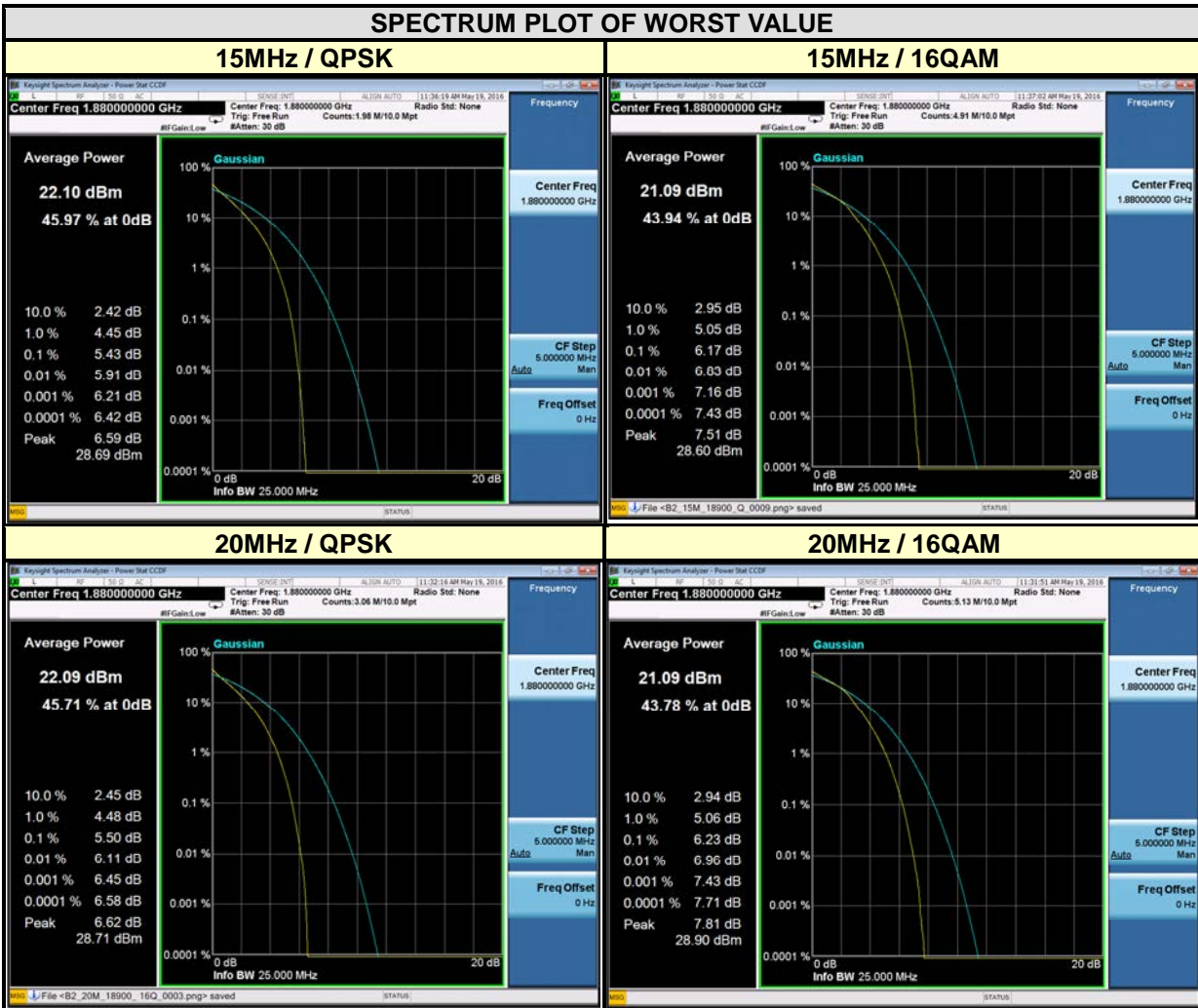

4.6 Conducted Spurious Emissions

4.6.1 Limits of Conducted Spurious Emissions Measurement

The power of any emission outside of the authorized operating frequency ranges must be attenuated below the transmitting power (P) by a factor of at least $43 + 10 \log(P)$ dB. The emission limit equal to -13dBm .

4.6.2 Test Setup

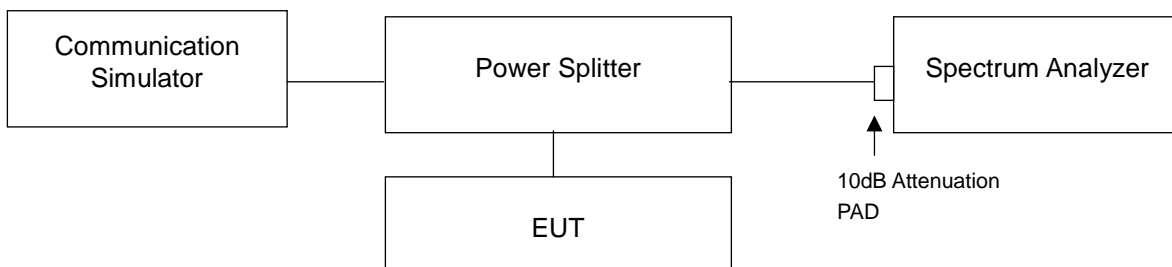

4.6.3 Test Procedure

- a. The EUT makes a phone call to the communication simulator. All measurements were done at low, middle and high operational frequency range.
- b. Measuring frequency range is from 9 kHz to 19.1GHz. 20dB attenuation pad is connected with spectrum. RBW=1MHz and VBW=3MHz is used for conducted emission measurement.

4.6.4 Test Results

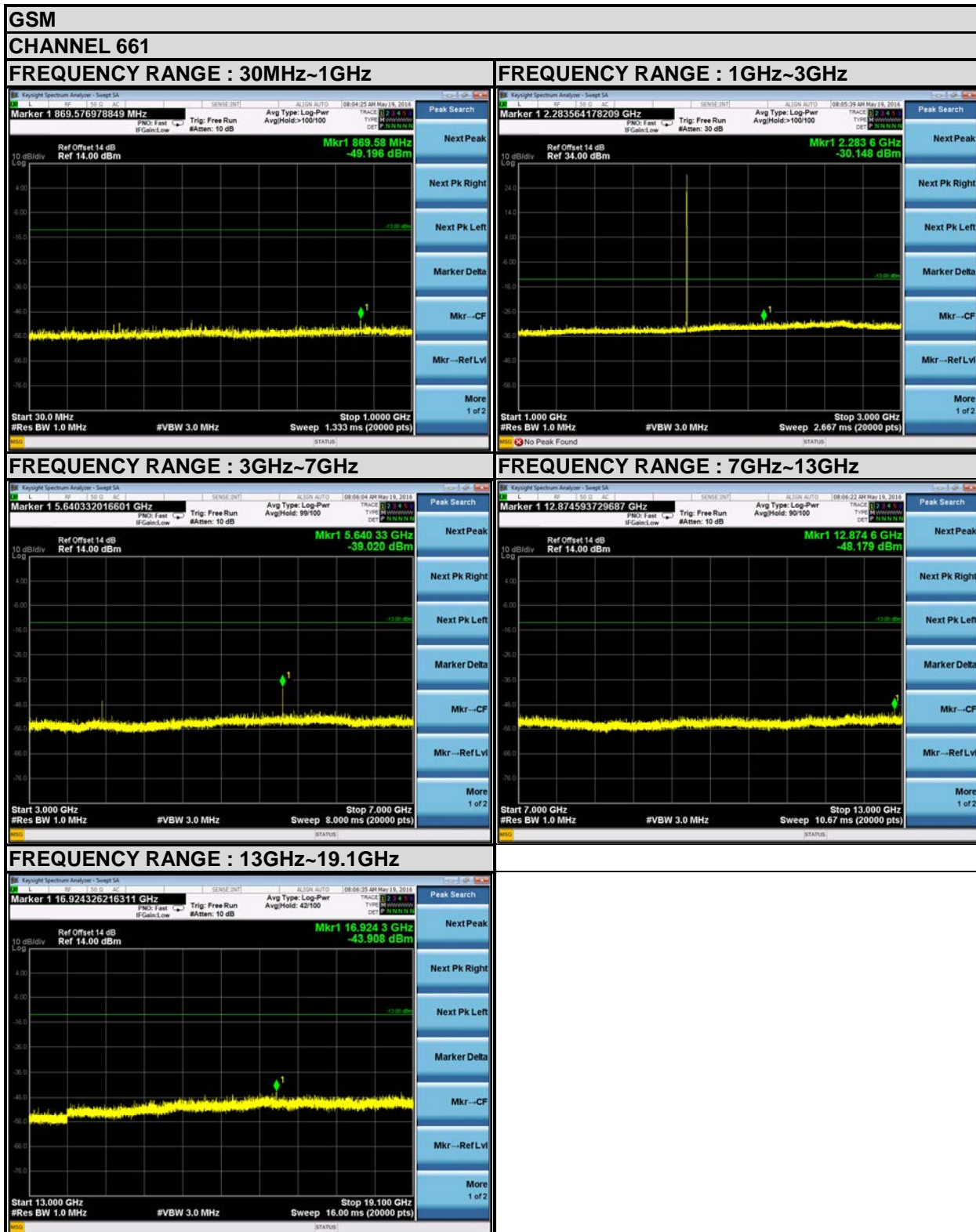

**EDGE
CHANNEL 512**

FREQUENCY RANGE : 30MHz~1GHz

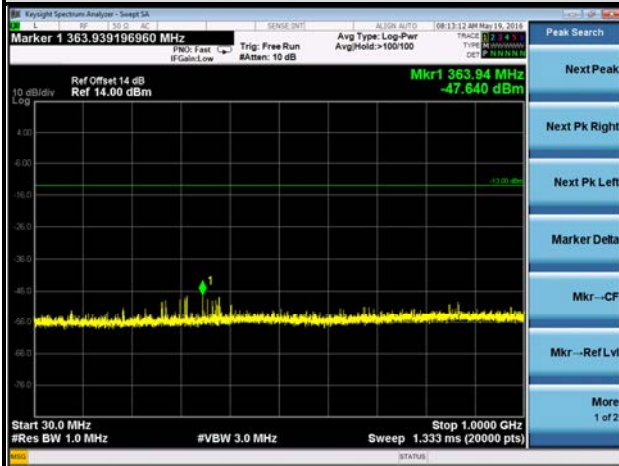

FREQUENCY RANGE : 1GHz~3GHz

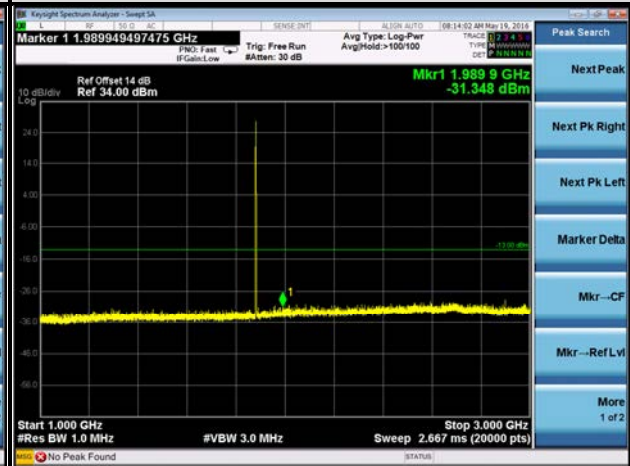

FREQUENCY RANGE : 3GHz~7GHz

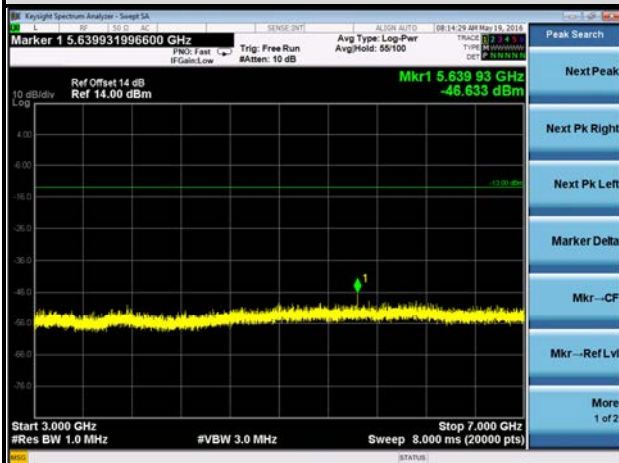

FREQUENCY RANGE : 7GHz~13GHz

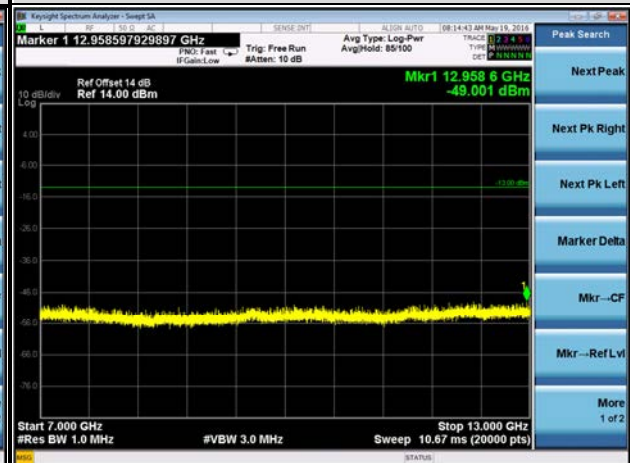

FREQUENCY RANGE : 13GHz~19.1GHz

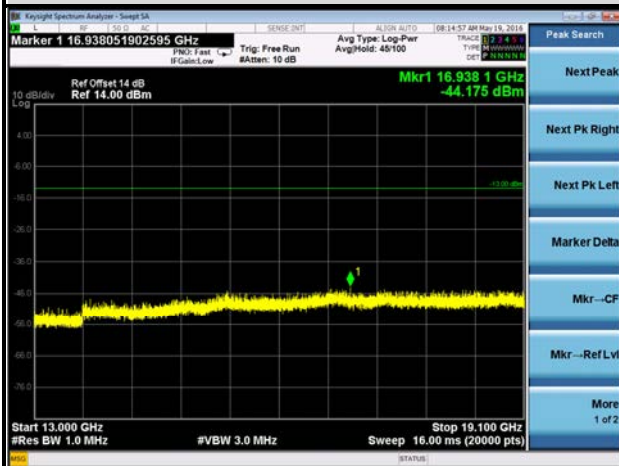

WCDMA
CHANNEL 9400

FREQUENCY RANGE : 30MHz~1GHz

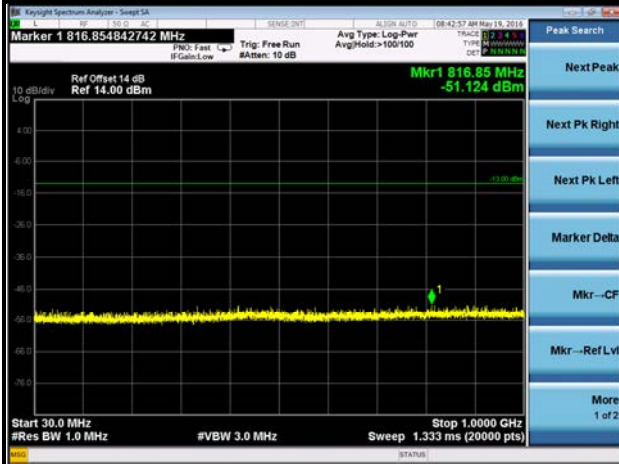

FREQUENCY RANGE : 1GHz~3GHz

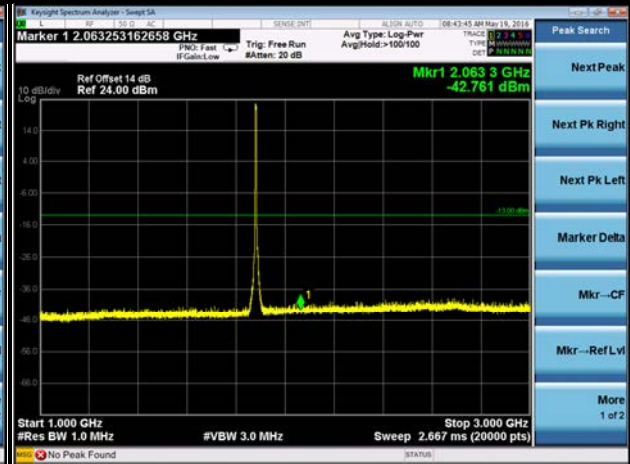

FREQUENCY RANGE : 3GHz~7GHz

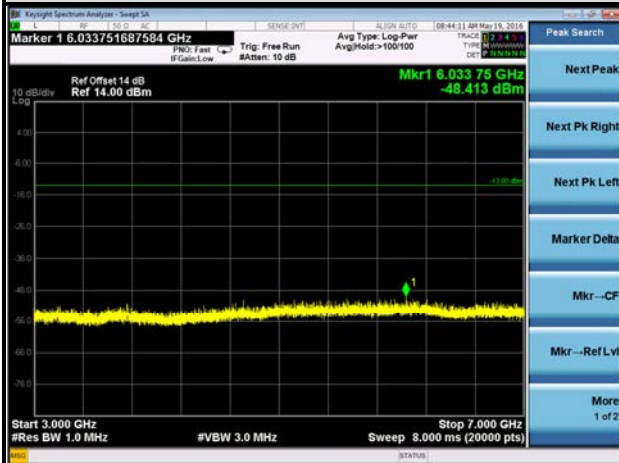

FREQUENCY RANGE : 7GHz~13GHz

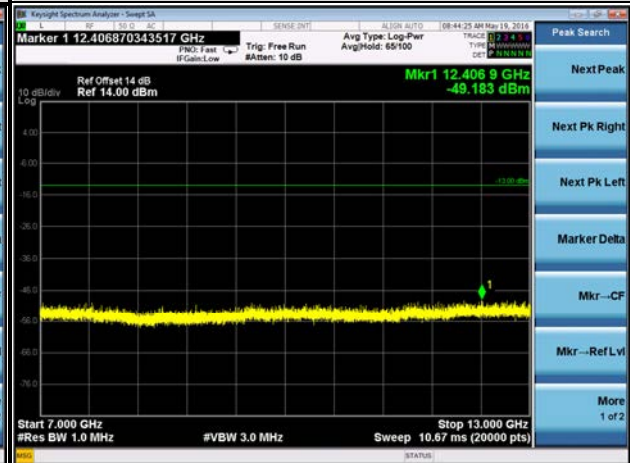

FREQUENCY RANGE : 13GHz~19.1GHz

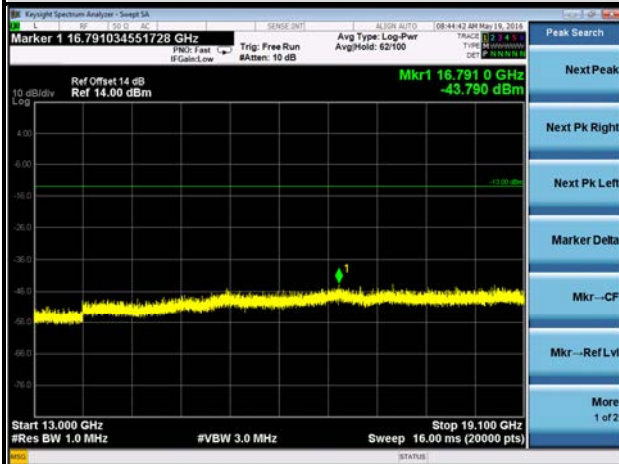

LTE BAND 2

CHANNEL 18900

1.4MHz / QPSK

FREQUENCY RANGE : 30MHz~19.1GHz

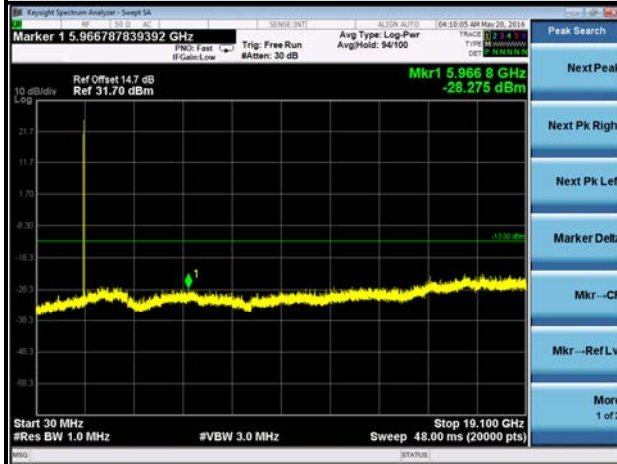

CHANNEL 18900

3MHz / QPSK

FREQUENCY RANGE : 30MHz~19.1GHz

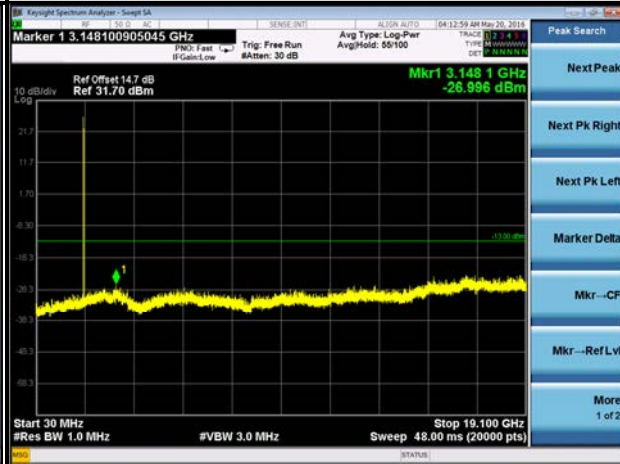

CHANNEL 18900

5MHz / QPSK

FREQUENCY RANGE : 30MHz~19.1GHz

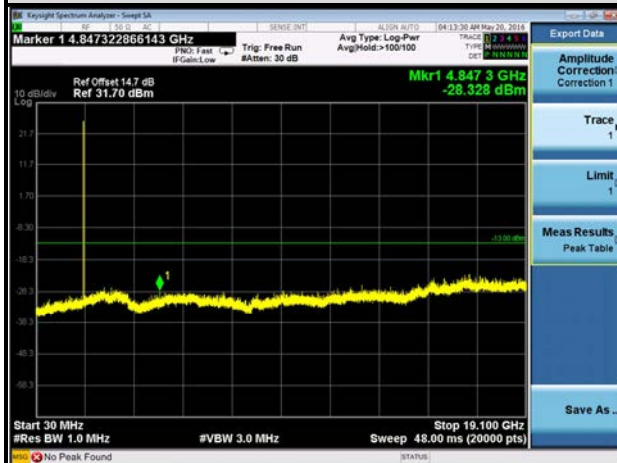

CHANNEL 18900

10MHz / QPSK

FREQUENCY RANGE : 30MHz~19.1GHz

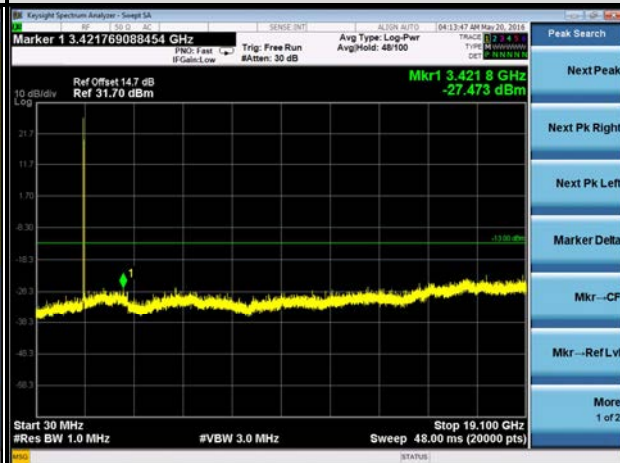

CHANNEL 18900

15MHz / QPSK

FREQUENCY RANGE : 30MHz~19.1GHz

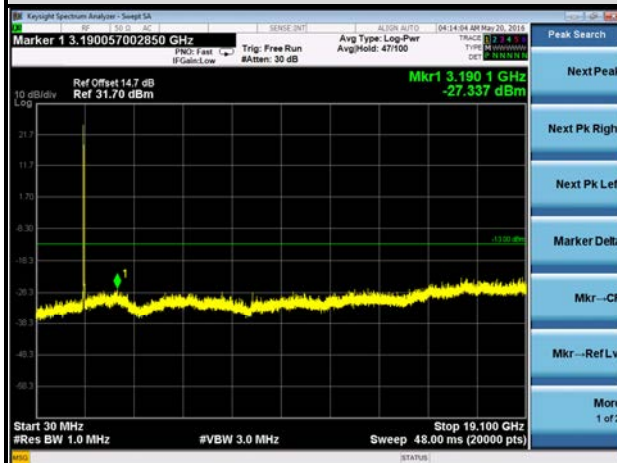

CHANNEL 18900

20MHz / QPSK

FREQUENCY RANGE : 30MHz~19.1GHz

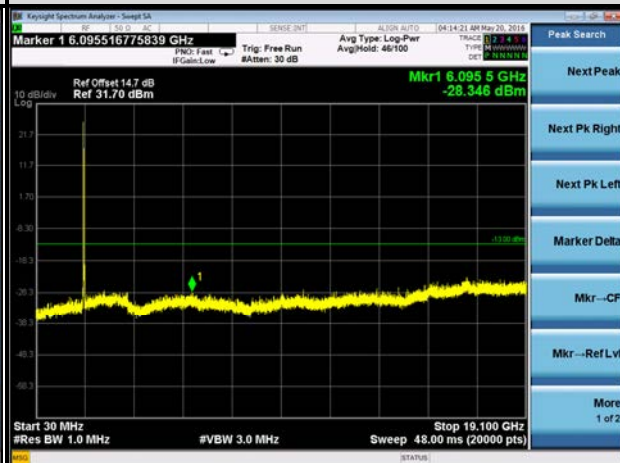

4.7 Radiated Emission Measurement

4.7.1 Limits of Radiated Emission Measurement

The power of any emission outside of the authorized operating frequency ranges must be attenuated below the transmitting power (P) by a factor of at least $43 + 10 \log(P)$ dB. The emission limit equal to -13dBm .

4.7.2 Test Procedure

- a. Substitution method is used for E.I.R.P measurement. In the semi-anechoic chamber, EUT placed on the 0.8m height of Turn Table, rotated the table around 360 degrees to search the maximum radiation power and receiver antenna shall be rotated vertical and horizontal polarization and moved height from 1m to 4m to find the maximum polar radiated power. The "Read Value" is the spectrum reading the maximum power value.
- b. The substitution horn antenna is substituted for EUT at the same position and signals generator export the CW signal to the substitution antenna via a TX cable. Rotated the Turn Table and moved receiving antenna to find the maximum radiation power. Adjust output power level of S.G to get a Value of spectrum reading equal to "Read Value " of step a. Record the power level of S.G
- c. $\text{EIRP} = \text{Output power level of S.G} - \text{TX cable loss} + \text{Antenna gain of substitution horn}$.
- d. E.R.P power can be calculated form E.I.R.P power by subtracting the gain of dipole, $\text{E.R.P power} = \text{E.I.P.R power} - 2.15\text{dBi}$.

NOTE: The resolution bandwidth and video bandwidth of test receiver/spectrum analyzer is 1MHz/3MHz.

4.7.3 Deviation from Test Standard

No deviation.

4.7.4 Test Setup

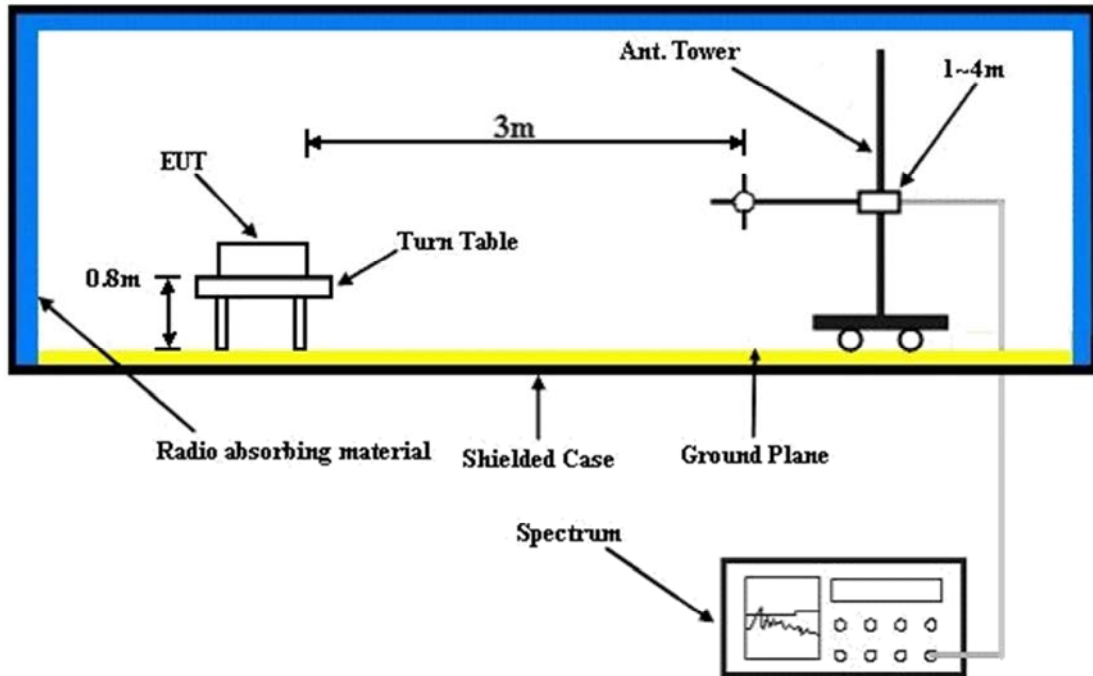

For the actual test configuration, please refer to the attached file (Test Setup Photo).

4.7.5 Test Results

BELOW 1GHz WORST-CASE DATA

GSM 1900:

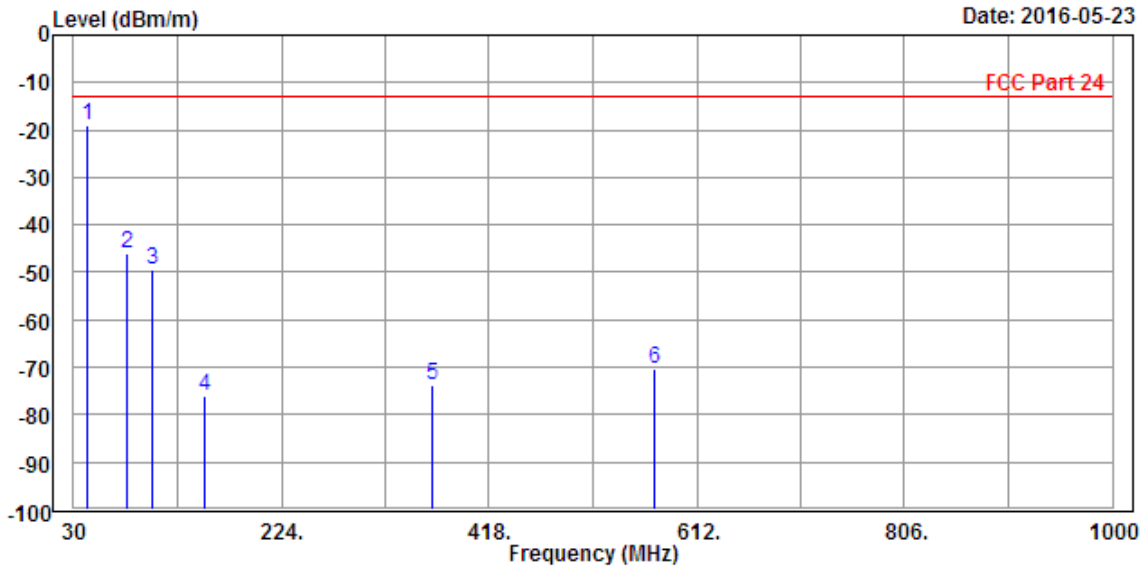

Condition: FCC Part 24 3m EIRP_26M-1GHz-20160505-EMC9135+3143B-FCC Horizontal
 EUT : Lenovo 2016b30
 Mode : PCS1900
 Test By : Alex Chen
 Remark : IMEI 861026030000312/320

	Freq	Level	Read Level	Limit Line	Over Limit	Factor	Remark	Pol/Phase
	MHz	dBm/m	dBm	dBm/m	dB	dB/m		
1 PP	42.610	-19.18	-28.96	-13.00	-6.18	9.78	Peak	Horizontal
2	79.470	-46.07	-38.18	-13.00	-33.07	-7.89	Peak	Horizontal
3	102.750	-49.28	-37.55	-13.00	-36.28	-11.73	Peak	Horizontal
4	152.220	-76.04	-57.06	-13.00	-63.04	-18.98	Peak	Horizontal
5	364.650	-73.89	-62.25	-13.00	-60.89	-11.64	Peak	Horizontal
6	573.200	-70.51	-61.36	-13.00	-57.51	-9.15	Peak	Horizontal

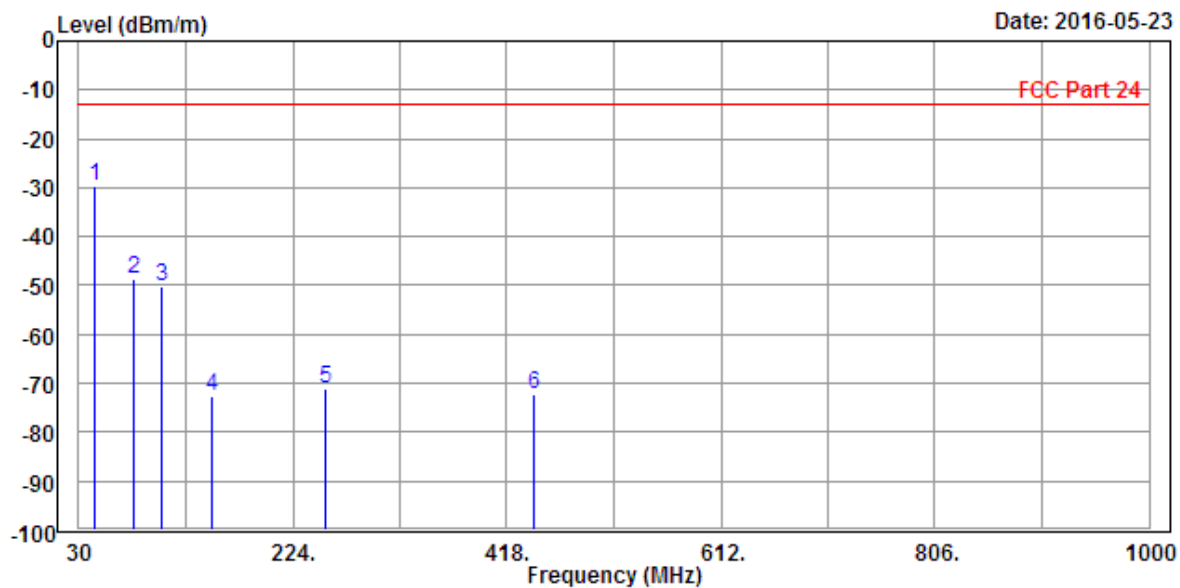

Condition: FCC Part 24 3m EIRP_26M-1GHz-20160505-EMC9135+3143B-FCC Vertical
 EUT : Lenovo 2016b30
 Mode : PCS1900
 Test By : Alex Chen
 Remark : IMEI 861026030000312/320

	Freq	Level	Read Level	Limit Line	Over Limit	Factor	Remark	Pol/Phase
	MHz	dBm/m	dBm	dBm/m	dB	dB/m		
1 PP	43.580	-29.69	-27.05	-13.00	-16.69	-2.64	Peak	Vertical
2	79.470	-48.51	-37.98	-13.00	-35.51	-10.53	Peak	Vertical
3	105.660	-50.04	-38.62	-13.00	-37.04	-11.42	Peak	Vertical
4	150.280	-72.65	-56.68	-13.00	-59.65	-15.97	Peak	Vertical
5	253.100	-71.04	-59.53	-13.00	-58.04	-11.51	Peak	Vertical
6	443.220	-72.12	-62.78	-13.00	-59.12	-9.34	Peak	Vertical

ABOVE 1GHz DATA

GSM 1900:

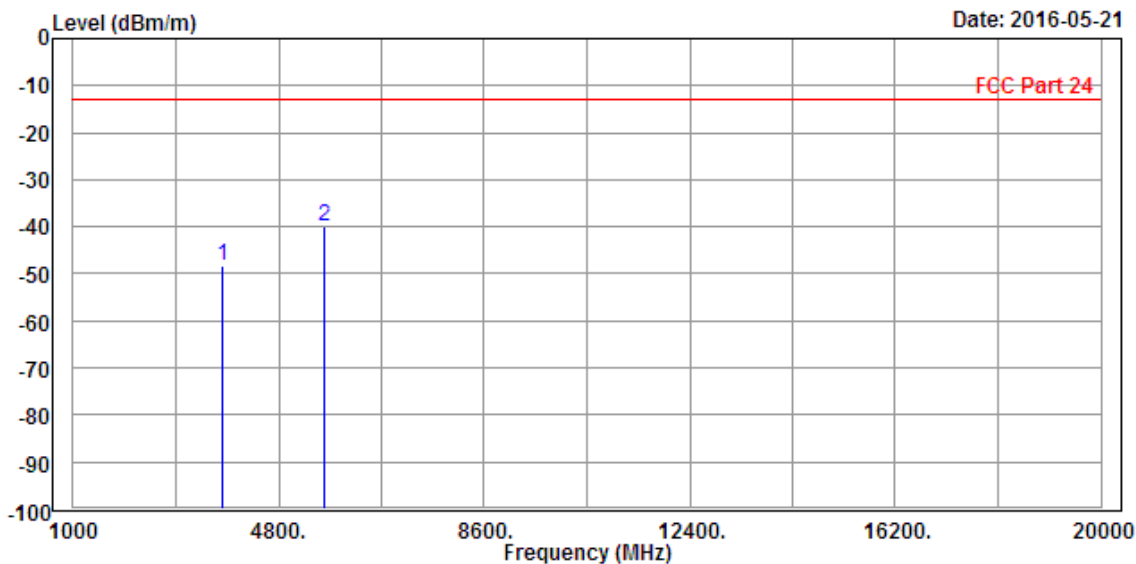

Condition: FCC Part 24 3m EIRP_1G-18G-_20160505-EMC012645B+3117-FCC Horizontal
 EUT : Lenovo 2016b30
 Mode : PCS1900
 PPlan : X-Plan
 Test By : Alex Chen
 Remark : IMEI 861026030000312/320

	Freq	Level	Read Level	Limit Line	Over Limit	Factor	Remark	Pol/Phase
	MHz	dBm/m	dBm	dBm/m	dB	dB/m		
1	3760.000	-48.40	-51.81	-13.00	-35.40	3.41	Peak	Horizontal
2 PP	5636.000	-39.89	-49.01	-13.00	-26.89	9.12	Peak	Horizontal

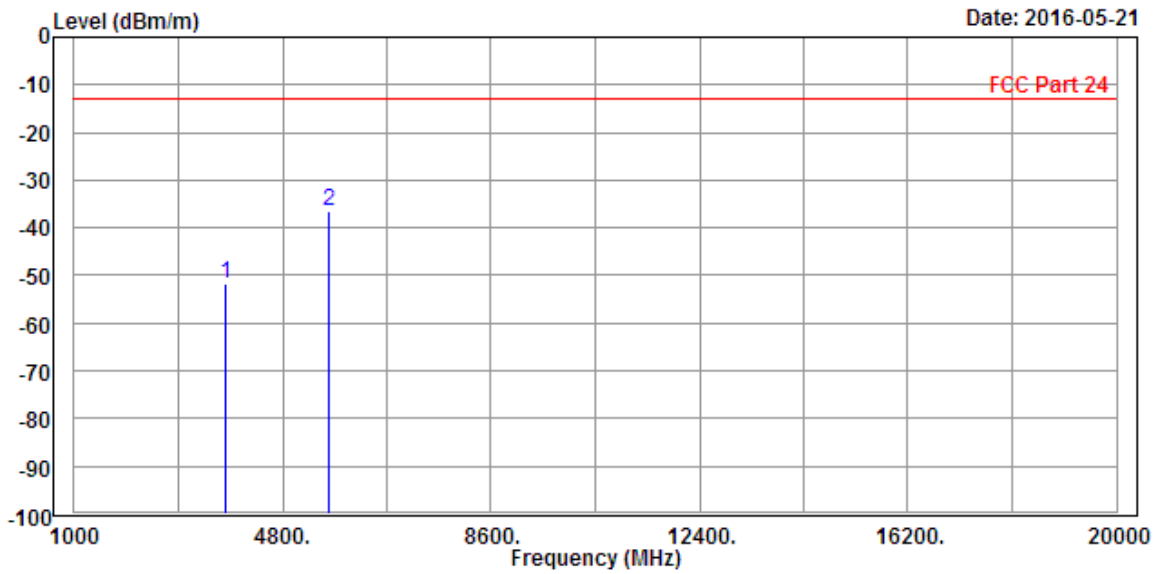

Condition: FCC Part 24 3m EIRP_1G-18G-_20160505-EMC012645B+3117-FCC Vertical
 EUT : Lenovo 2016b30
 Mode : PCS1900
 PPlan : X-Plan
 Test By : Alex Chen
 Remark : IMEI 861026030000312/320

	Freq	Level	Read Level	Limit Line	Over Limit	Factor	Remark	Pol/Phase
	MHz	dBm/m	dBm	dBm/m	dB	dB/m		
1	3755.000	-51.53	-55.38	-13.00	-38.53	3.85	Peak	Vertical
2 PP	5640.000	-36.65	-44.91	-13.00	-23.65	8.26	Peak	Vertical



EDGE 1900:

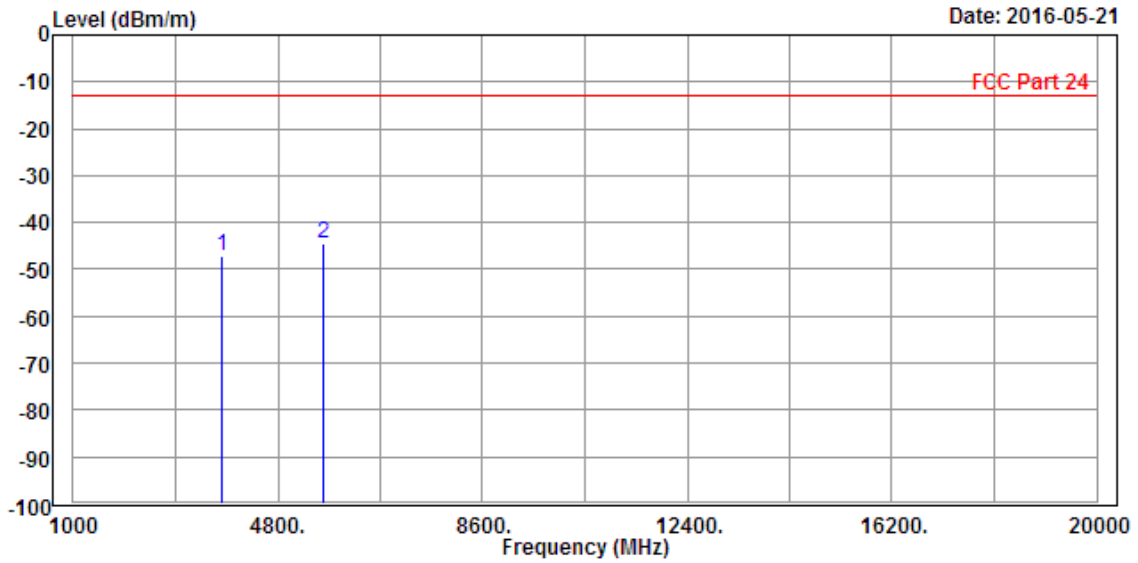

Condition: FCC Part 24 3m EIRP_1G-18G-_20160505-EMC012645B+3117-FCC Horizontal
EUT : Lenovo 2016b30
Mode : Edge1900
PLan : X-Plan
Test By : Alex Chen
Remark : IMEI 861026030000312/320

	Freq	Level	Read Level	Limit Line	Over Limit	Factor	Remark	Pol/Phase
	MHz	dBm/m	dBm	dBm/m	dB	dB/m		
1	3755.000	-47.21	-50.60	-13.00	-34.21	3.39	Peak	Horizontal
2 PP	5640.000	-44.41	-53.53	-13.00	-31.41	9.12	Peak	Horizontal

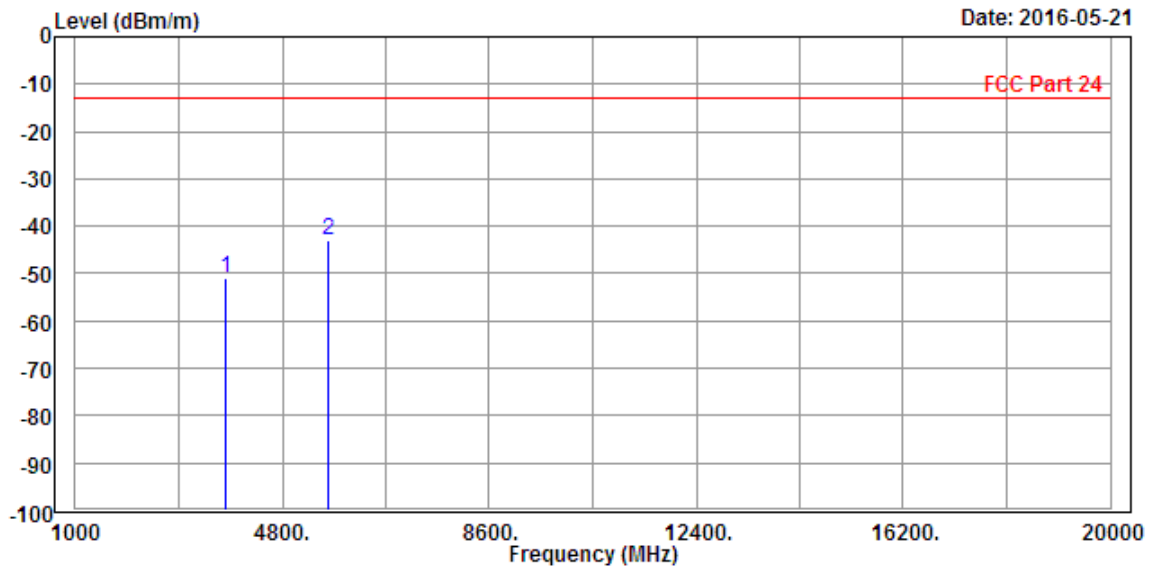

Condition: FCC Part 24 3m EIRP_1G-18G-_20160505-EMC012645B+3117-FCC Vertical
 EUT : Lenovo 2016b30
 Mode : Edge1900
 PPlan : X-Plan
 Test By : Alex Chen
 Remark : IMEI 861026030000312/320

	Freq	Level	Read Level	Limit Line	Over Limit	Factor	Remark	Pol/Phase
	MHz	dBm/m	dBm	dBm/m	dB	dB/m		
1	3755.000	-50.82	-54.67	-13.00	-37.82	3.85	Peak	Vertical
2 PP	5640.000	-43.08	-51.34	-13.00	-30.08	8.26	Peak	Vertical

WCDMA Band II:

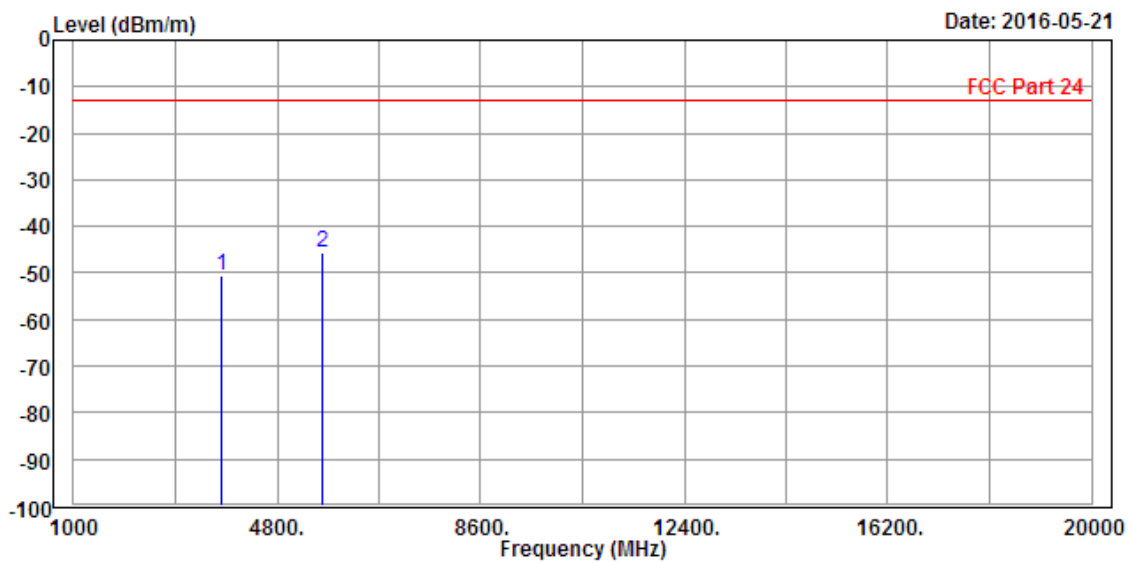

Condition: FCC Part 24 3m EIRP_1G-18G-_20160505-EMC012645B+3117-FCC Horizontal
 EUT : Lenovo 2016b30
 Mode : WCDMA Band2
 PPlan : X-Plan
 Test By : Alex Chen
 Remark : IMEI 861026030000312/320

	Freq	Level	Read Level	Limit Line	Over Limit	Factor	Remark	Pol/Phase
	MHz	dBm/m	dBm	dBm/m	dB	dB/m		
1	3755.000	-50.71	-54.10	-13.00	-37.71	3.39	Peak	Horizontal
2 PP	5640.000	-45.81	-54.93	-13.00	-32.81	9.12	Peak	Horizontal

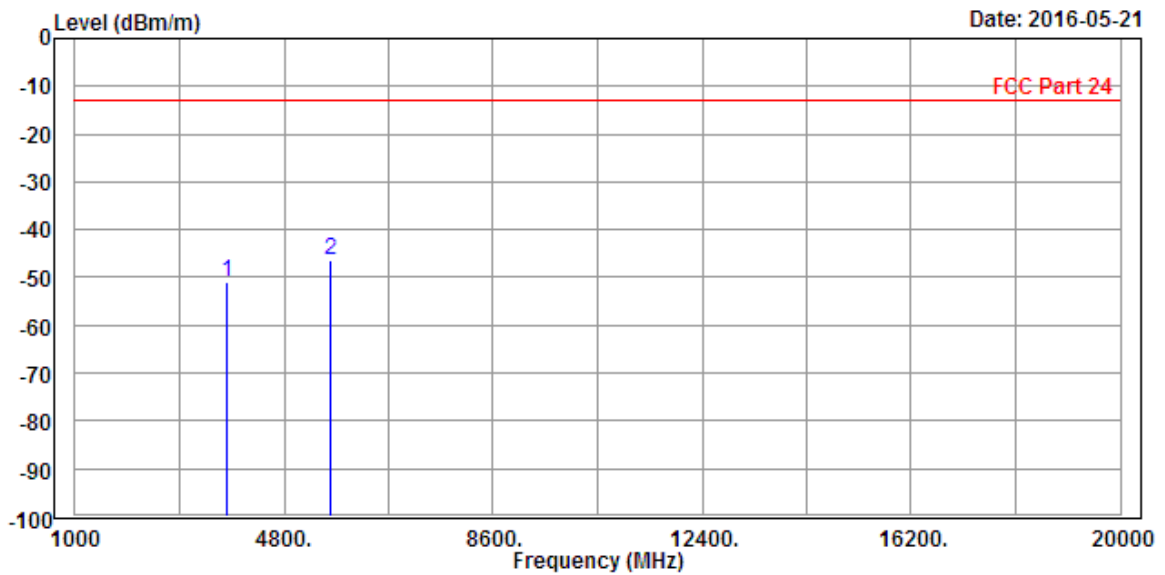

Condition: FCC Part 24 3m EIRP_1G-18G-_20160505-EMC012645B+3117-FCC Vertical
 EUT : Lenovo 2016b30
 Mode : WCDMA Band2
 Plan : X-Plan
 Test By : Alex Chen
 Remark : IMEI 861026030000312/320

	Freq	Level	Read Level	Limit Line	Over Limit	Factor	Remark	Pol/Phase
	MHz	dBm/m	dBm	dBm/m	dB	dB/m		
1	3755.000	-51.14	-54.99	-13.00	-38.14	3.85	Peak	Vertical
2 PP	5640.000	-46.38	-54.64	-13.00	-33.38	8.26	Peak	Vertical

LTE Band 2

CHANNEL BANDWIDTH: 1.4MHz / QPSK

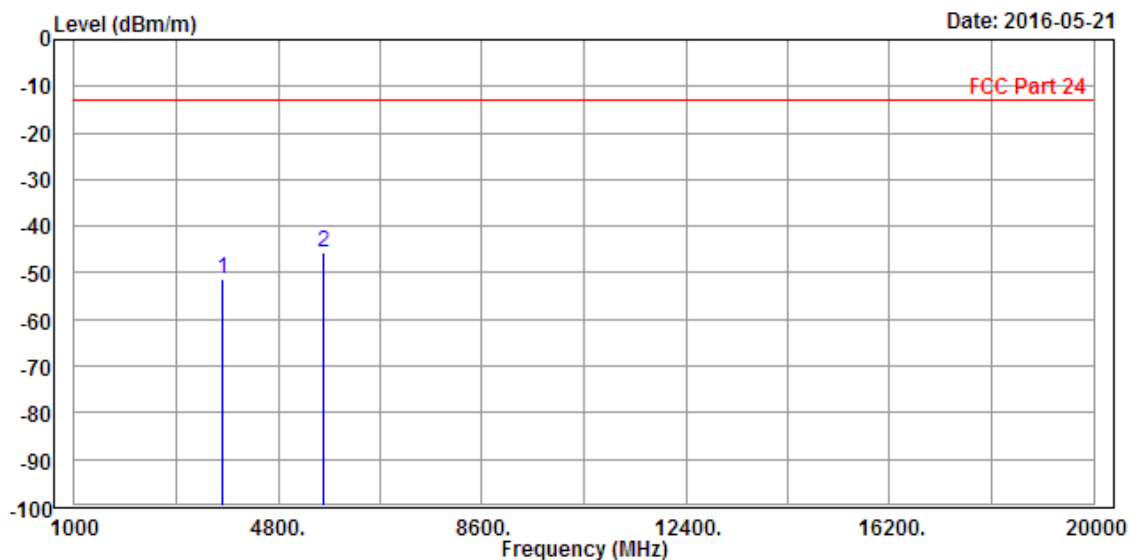

Condition: FCC Part 24 3m EIRP_1G-18G-_20160505-EMC012645B+3117-FCC Horizontal
 EUT : Lenovo 2016b30
 Mode : LTE Band2(1.4M)
 PPlan : Z-Plan
 Test By : Alex Chen
 Remark : IMEI 861026030000312/320

	Read	Limit	Over				
Freq	Level	Level	Line	Limit	Factor	Remark	Pol/Phase
MHz	dBm/m	dBm	dBm/m	dB	dB/m		
1	3755.000	-51.17	-54.56	-13.00	-38.17	3.39 Peak	Horizontal
2 PP	5640.000	-45.58	-54.70	-13.00	-32.58	9.12 Peak	Horizontal

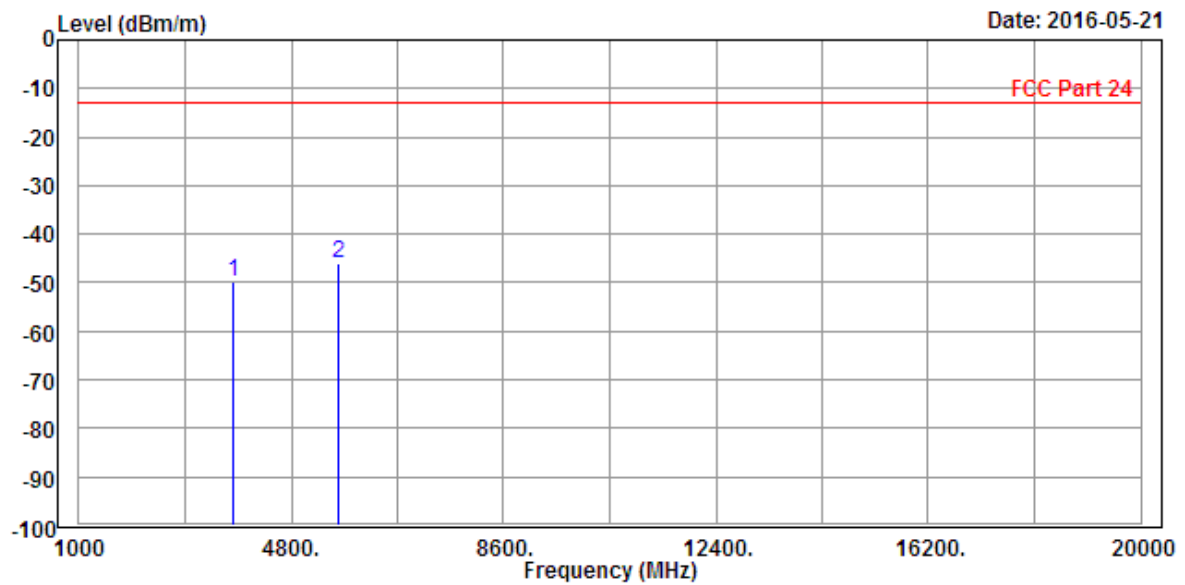

Condition: FCC Part 24 3m EIRP_1G-18G-_20160505-EMC012645B+3117-FCC Vertical
EUT : Lenovo 2016b30
Mode : LTE Band2(1.4M)
Plan : Z-Plan
Test By : Alex Chen
Remark : IMEI 861026030000312/320

	Freq	Level	Read Level	Limit Line	Over Limit	Factor	Remark	Pol/Phase
	MHz	dBm/m	dBm	dBm/m	dB	dB/m		
1	3755.000	-49.66	-53.51	-13.00	-36.66	3.85	Peak	Vertical
2 PP	5640.000	-46.08	-54.34	-13.00	-33.08	8.26	Peak	Vertical

CHANNEL BANDWIDTH: 3MHz / QPSK

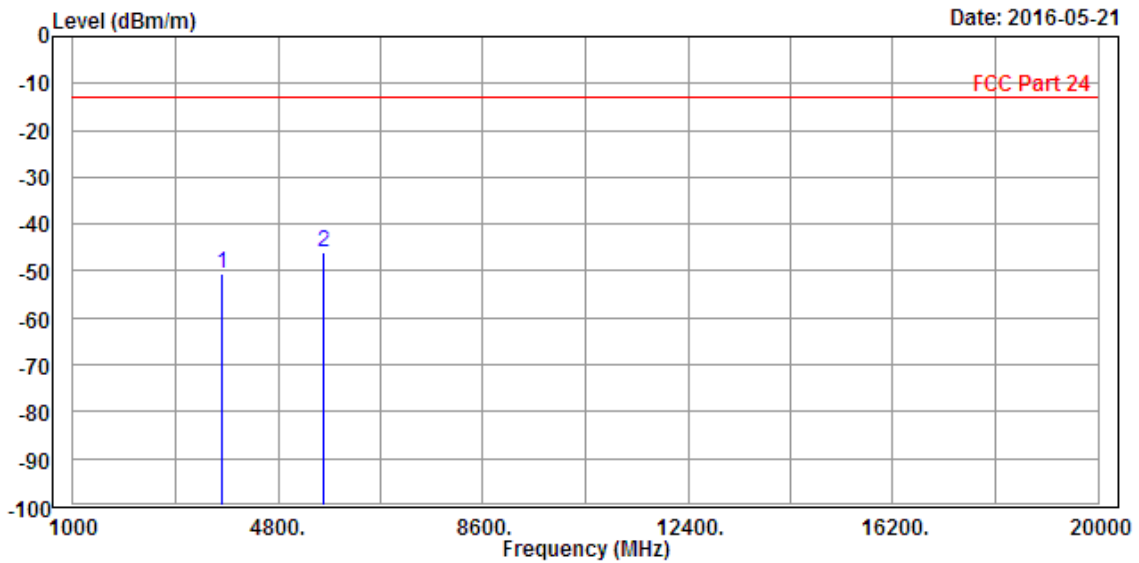

Condition: FCC Part 24 3m EIRP_1G-18G-_20160505-EMC012645B+3117-FCC Horizontal
 EUT : Lenovo 2016b30
 Mode : LTE Band2(3M)
 PPlan : Z-Plan
 Test By : Alex Chen
 Remark : IMEI 861026030000312/320

	Freq	Level	Read Level	Limit Line	Over Limit	Factor	Remark	Pol/Phase
	MHz	dBm/m	dBm	dBm/m	dB	dB/m		
1	3755.000	-50.53	-53.92	-13.00	-37.53	3.39	Peak	Horizontal
2 PP	5640.000	-46.07	-55.19	-13.00	-33.07	9.12	Peak	Horizontal

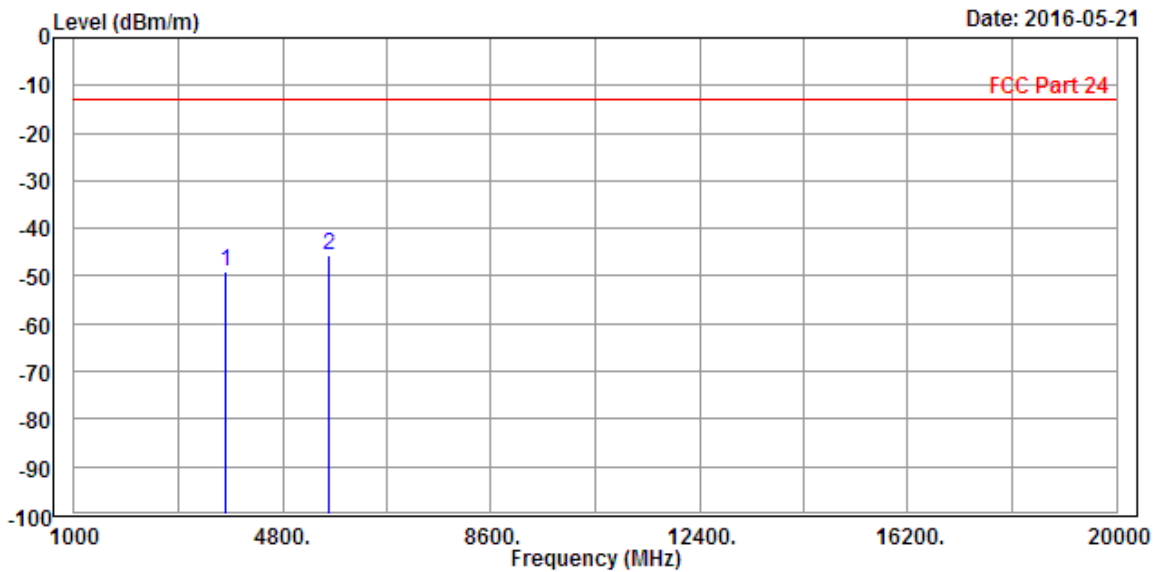

Condition: FCC Part 24 3m EIRP_1G-18G-_20160505-EMC012645B+3117-FCC Vertical
 EUT : Lenovo 2016b30
 Mode : LTE Band2(3M)
 PPlan : Z-Plan
 Test By : Alex Chen
 Remark : IMEI 861026030000312/320

	Freq	Level	Read Level	Limit Line	Over Limit	Factor	Remark	Pol/Phase
	MHz	dBm/m	dBm	dBm/m	dB	dB/m		
1	3755.000	-49.03	-52.88	-13.00	-36.03	3.85	Peak	Vertical
2 PP	5640.000	-45.77	-54.03	-13.00	-32.77	8.26	Peak	Vertical



CHANNEL BANDWIDTH: 5MHz / QPSK

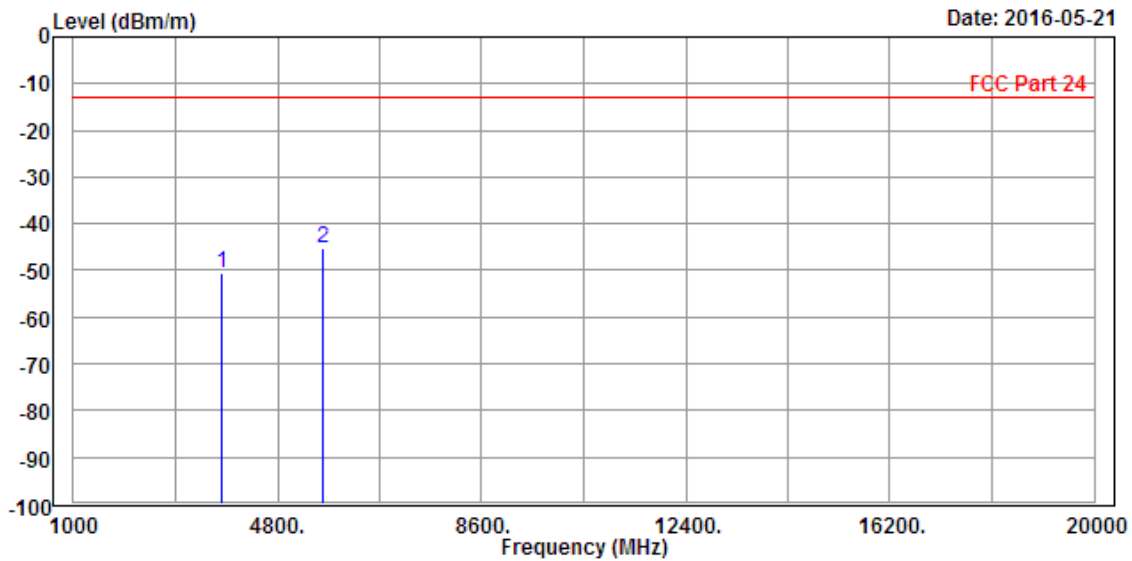

Condition: FCC Part 24 3m EIRP_1G-18G-_20160505-EMC012645B+3117-FCC Horizontal
 EUT : Lenovo 2016b30
 Mode : LTE Band2(5M)
 PPlan : Z-Plan
 Test By : Alex Chen
 Remark : IMEI 861026030000312/320

	Freq	Level	Read Level	Limit Line	Over Limit	Factor	Remark	Pol/Phase
	MHz	dBm/m	dBm	dBm/m	dB	dB/m		
1	3755.000	-50.52	-53.91	-13.00	-37.52	3.39	Peak	Horizontal
2 PP	5640.000	-45.24	-54.36	-13.00	-32.24	9.12	Peak	Horizontal

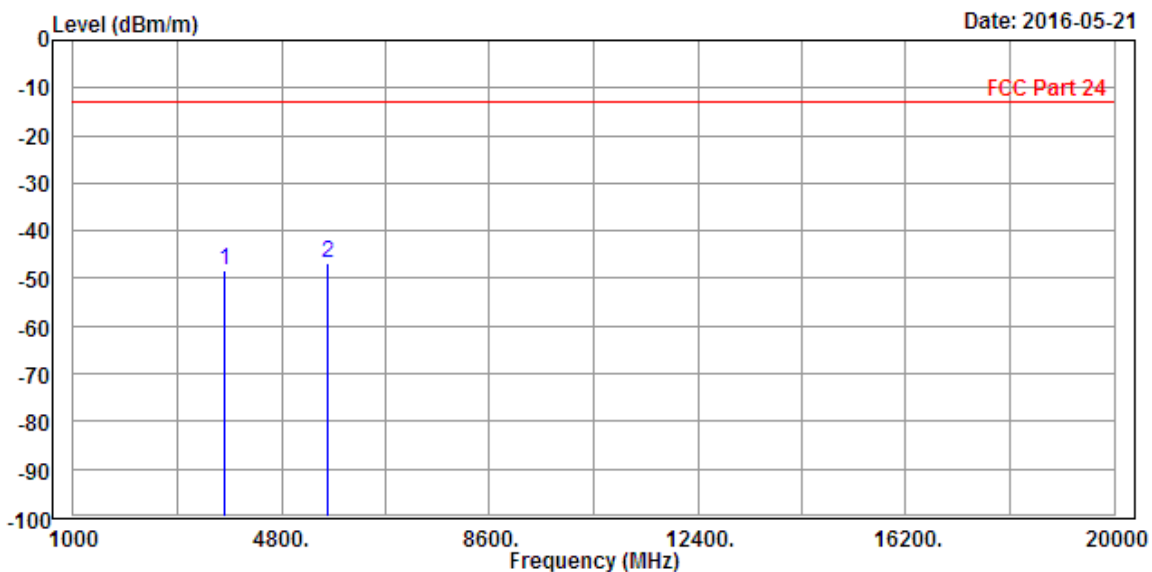

Condition: FCC Part 24 3m EIRP_1G-18G-_20160505-EMC012645B+3117-FCC Vertical
 EUT : Lenovo 2016b30
 Mode : LTE Band2(5M)
 PPlan : Z-Plan
 Test By : Alex Chen
 Remark : IMEI 861026030000312/320

	Freq	Level	Read Level	Limit Line	Over Limit	Factor	Remark	Pol/Phase
	MHz	dBm/m	dBm	dBm/m	dB	dB/m		
1	3755.000	-48.23	-52.08	-13.00	-35.23	3.85	Peak	Vertical
2 PP	5640.000	-46.96	-55.22	-13.00	-33.96	8.26	Peak	Vertical

CHANNEL BANDWIDTH: 10MHz / QPSK

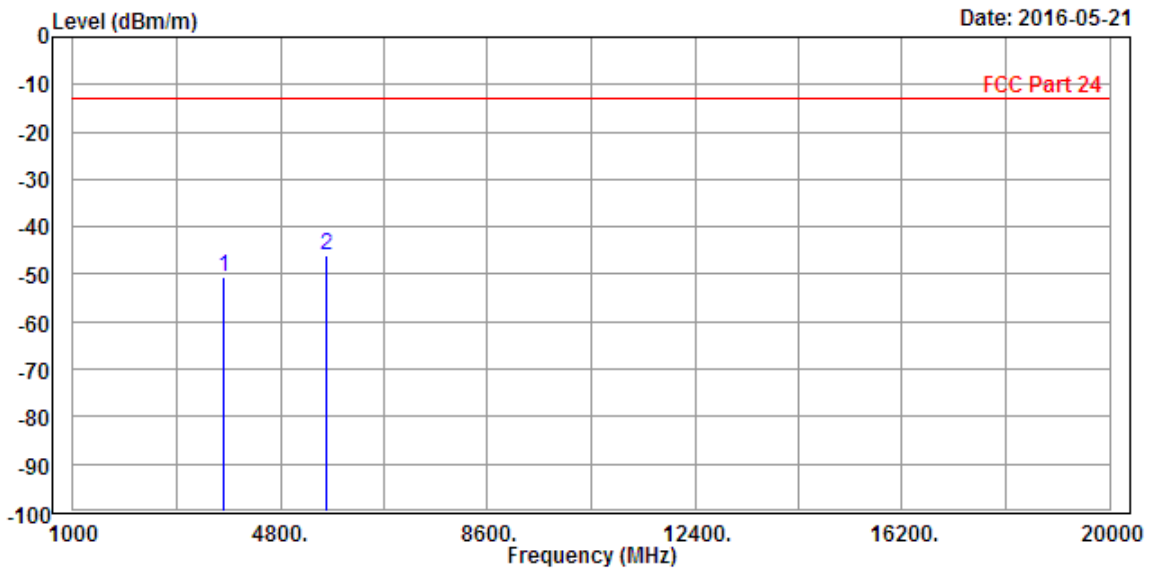

Date: 2016-05-21

Condition: FCC Part 24 3m EIRP_1G-18G-_20160505-EMC012645B+3117-FCC Horizontal
 EUT : Lenovo 2016b30
 Mode : LTE Band2(10M)
 Plan : X-Plan
 Test By : Alex Chen
 Remark : IMEI 861026030000312/320

	Freq	Level	Read Level	Limit Line	Over Limit	Factor	Remark	Pol/Phase
	MHz	dBm/m	dBm	dBm/m	dB	dB/m		
1	3755.000	-50.52	-53.91	-13.00	-37.52	3.39	Peak	Horizontal
2	5640.000	-46.18	-55.30	-13.00	-33.18	9.12	Peak	Horizontal

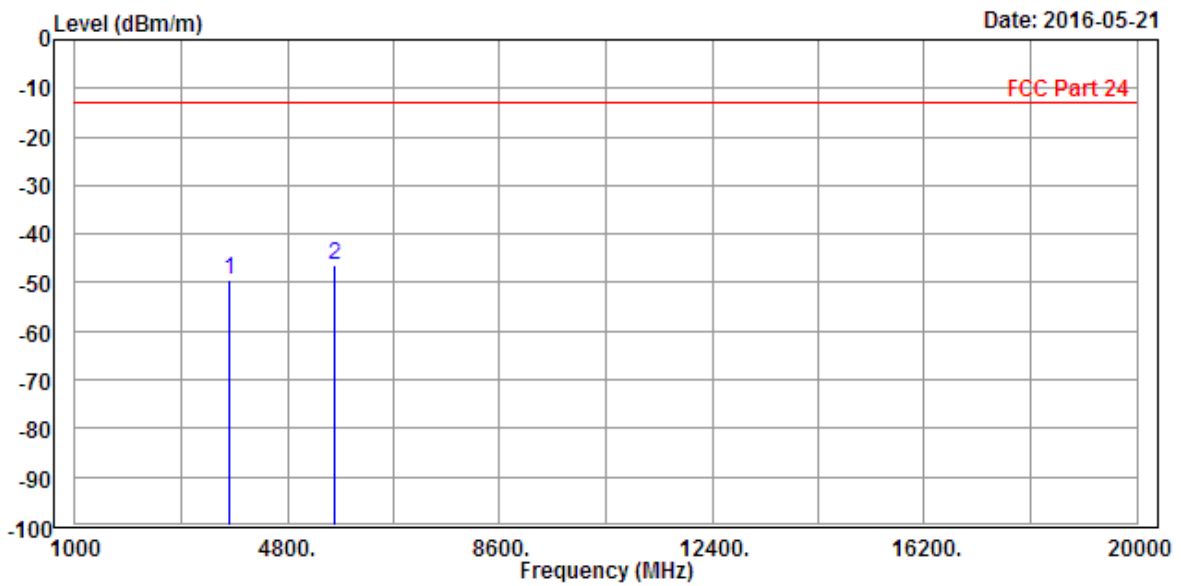

Condition: FCC Part 24 3m EIRP_1G-18G-_20160505-EMC012645B+3117-FCC Vertical
 EUT : Lenovo 2016b30
 Mode : LTE Band2(10M)
 PPlan : X-Plan
 Test By : Alex Chen
 Remark : IMEI 861026030000312/320

	Freq	Level	Read Level	Limit Line	Over Limit	Factor	Remark	Pol/Phase
	MHz	dBm/m	dBm	dBm/m	dB	dB/m		
1	3755.000	-49.50	-53.35	-13.00	-36.50	3.85	Peak	Vertical
2 PP	5640.000	-46.48	-54.74	-13.00	-33.48	8.26	Peak	Vertical

CHANNEL BANDWIDTH: 15MHz / QPSK

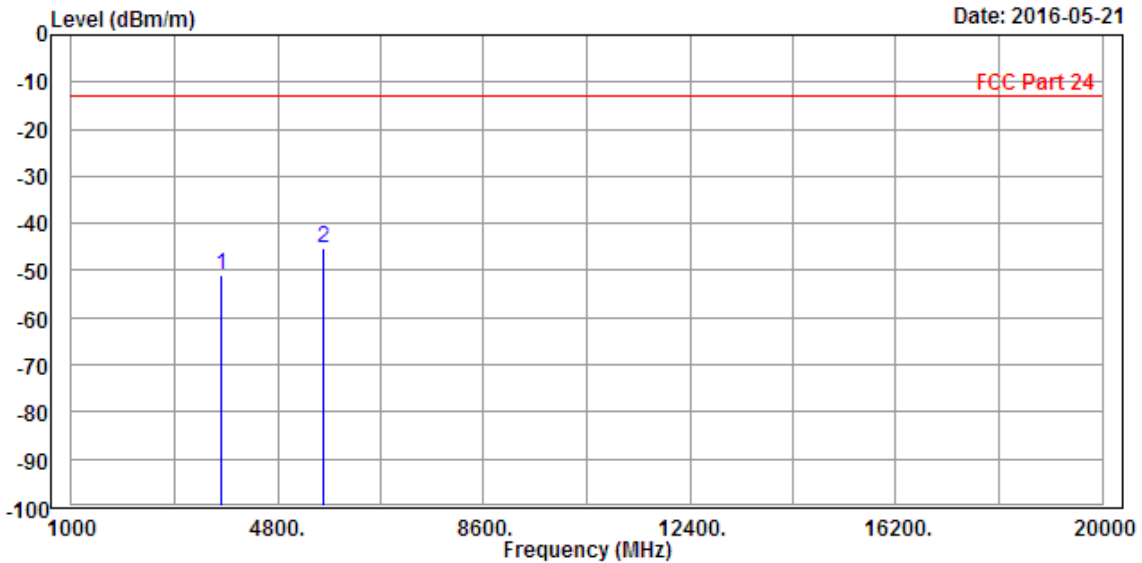

Condition: FCC Part 24 3m EIRP_1G-18G-_20160505-EMC012645B+3117-FCC Horizontal
 EUT : Lenovo 2016b30
 Mode : LTE Band2(15M)
 PPlan : Z-Plan
 Test By : Alex Chen
 Remark : IMEI 861026030000312/320

	Freq	Level	Read Level	Limit Line	Over Limit	Factor	Remark	Pol/Phase
	MHz	dBm/m	dBm	dBm/m	dB	dB/m		
1	3755.000	-51.00	-54.39	-13.00	-38.00	3.39	Peak	Horizontal
2 PP	5640.000	-45.30	-54.42	-13.00	-32.30	9.12	Peak	Horizontal

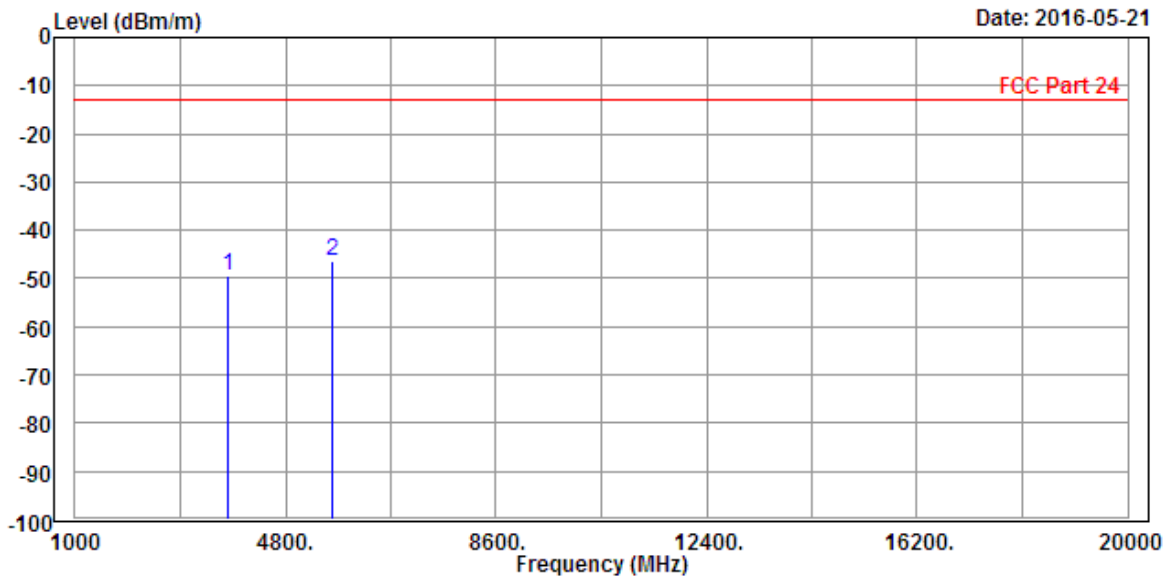

Condition: FCC Part 24 3m EIRP_1G-18G-_20160505-EMC012645B+3117-FCC Vertical
 EUT : Lenovo 2016b30
 Mode : LTE Band2(15M)
 PPlan : Z-Plan
 Test By : Alex Chen
 Remark : IMEI 861026030000312/320

	Freq	Level	Read Level	Limit Line	Over Limit	Factor	Remark	Pol/Phase
	MHz	dBm/m	dBm	dBm/m	dB	dB/m		
1	3755.000	-49.54	-53.39	-13.00	-36.54	3.85	Peak	Vertical
2 PP	5640.000	-46.45	-54.71	-13.00	-33.45	8.26	Peak	Vertical

CHANNEL BANDWIDTH: 20MHz / QPSK

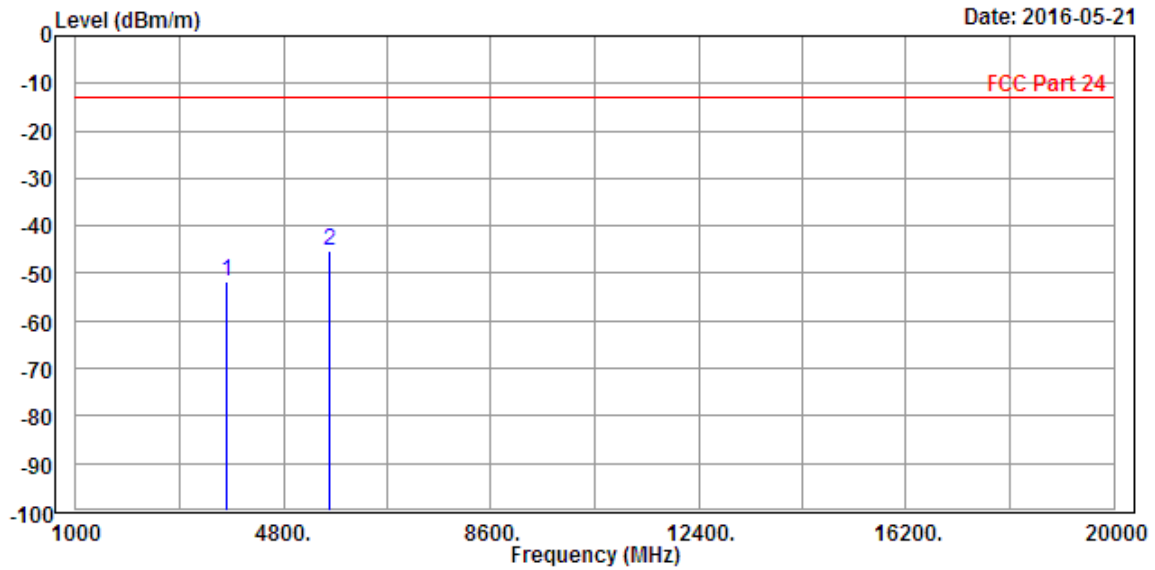

Condition: FCC Part 24 3m EIRP_1G-18G-_20160505-EMC012645B+3117-FCC Horizontal
 EUT : Lenovo 2016b30
 Mode : LTE Band2(20M)
 PPlan : Z-Plan
 Test By : Alex Chen
 Remark : IMEI 861026030000312/320

	Freq	Level	Read Level	Limit Line	Over Limit	Factor	Remark	Pol/Phase
	MHz	dBm/m	dBm	dBm/m	dB	dB/m		
1	3755.000	-51.87	-55.26	-13.00	-38.87	3.39	Peak	Horizontal
2 PP	5640.000	-45.23	-54.35	-13.00	-32.23	9.12	Peak	Horizontal

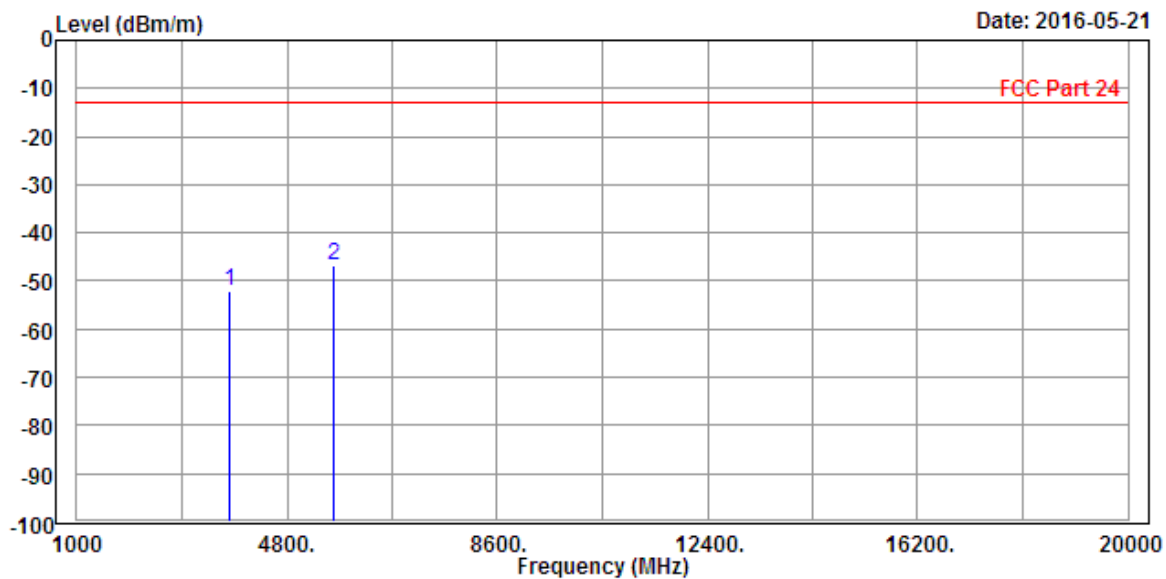

Condition: FCC Part 24 3m EIRP_1G-18G-_20160505-EMC012645B+31117-FCC Vertical
 EUT : Lenovo 2016b30
 Mode : LTE Band2(20M)
 PPlan : Z-Plan
 Test By : Alex Chen
 Remark : IMEI 861026030000312/320

	Freq	Level	Read Level	Limit Line	Over Limit	Factor	Remark	Pol/Phase
	MHz	dBm/m	dBm	dBm/m	dB	dB/m		
1	3755.000	-52.25	-56.10	-13.00	-39.25	3.85	Peak	Vertical
2 PP	5640.000	-46.79	-55.05	-13.00	-33.79	8.26	Peak	Vertical

5 Pictures of Test Arrangements

Please refer to the attached file (Test Setup Photo).

Appendix – Information on the Testing Laboratories

We, Bureau Veritas Consumer Products Services (H.K.) Ltd., Taoyuan Branch, were founded in 1988 to provide our best service in EMC, Radio, Telecom and Safety consultation. Our laboratories are accredited and approved according to ISO/IEC 17025.

If you have any comments, please feel free to contact us at the following:

Linko EMC/RF Lab

Tel: 886-2-26052180

Fax: 886-2-26051924

Hsin Chu EMC/RF Lab/Telecom Lab

Tel: 886-3-5935343

Fax: 886-3-5935342

Hwa Ya EMC/RF/Safety

Tel: 886-3-3183232

Fax: 886-3-3270892

Email: service.adt@tw.bureauveritas.com

Web Site: www.bureauveritas-adt.com

The address and road map of all our labs can be found in our web site also.

--- END ---