

FCC TEST REPORT (Bluetooth EDR)

Report No.: RF160624W002-1

FCC ID: YCNA2016B31

Test Model: Lenovo A2016b31

Received Date: Jun. 24, 2016

Test Date: Jun. 25, 2016~ Jun. 30, 2016

Issued Date: July 01, 2016

Applicant: Lenovo Mobile Communication Technology Ltd.

Address: No.999, Qishan North 2nd Road, Information & Optoelectronics Park, Torch Hi-tech Industry Development Zone, Xiamen, P.R.China

Issued By: Bureau Veritas Consumer Products Services (H.K.) Ltd., Taoyuan Branch

Lab Address: No. 47-2, 14th Ling, Chia Cau Vil., Lin Kou Dist., New Taipei City, Taiwan (R.O.C.)

Test Location: No. 19, Hwa Ya 2nd Rd., Wen Hwa Tsuen, Kwei Shan Hsiang, Taoyuan Hsien 333, Taiwan, R.O.C.

This report should not be used by the client to claim product certification, approval, or endorsement by TAF or any government agencies.



This report is for your exclusive use. Any copying or replication of this report to or for any other person or entity, or use of our name or trademark, is permitted only with our prior written permission. This report sets forth our findings solely with respect to the test samples identified herein. The results set forth in this report are not indicative or representative of the quality or characteristics of the lot from which a test sample was taken or any similar or identical product specifically and expressly noted. Our report includes all of the tests requested by you and the results thereof based upon the information that you provided to us. You have 60 days from date of issuance of this report to notify us of any material error or omission caused by our negligence, provided, however, that such notice shall be in writing and shall specifically address the issue you wish to raise. A failure to raise such issue within the prescribed time shall constitute your unqualified acceptance of the completeness of this report, the tests conducted and the correctness of the report contents. Unless specific mention, the uncertainty of measurement has been explicitly taken into account to declare the compliance or non-compliance to the specification. The report must not be used by the client to claim product certification, approval, or endorsement by TAF or any government agencies.

TABLE OF CONTENTS

RELEASE CONTROL RECORD	4
1 Certificate of Conformity.....	5
2 Summary of Test Results	6
2.1 Measurement Uncertainty	7
3 General Information.....	8
3.1 General Description of EUT	8
3.2 Description of Test Modes.....	10
3.2.1 Test Mode Applicability and Tested Channel Detail.....	11
3.3 Description of Support Units	13
3.3.1 Configuration of System under Test	13
3.4 General Description of Applied Standards	13
4 Test Types and Results(For BT EDR)	14
4.1 Radiated Emission and Bandedge Measurement.....	14
4.1.1 Limits of Radiated Emission and Bandedge Measurement	14
4.1.2 Test Instruments	15
4.1.3 Test Procedures.....	16
4.1.4 Deviation from Test Standard	16
4.1.5 Test Set Up	17
4.1.6 EUT Operating Conditions.....	17
4.1.7 Test Results	18
4.2 Conducted Emission Measurement	23
4.2.1 Limits of Conducted Emission Measurement.....	23
4.2.2 Test Instruments	23
4.2.3 Test Procedures.....	24
4.2.4 Deviation From Test Standard	24
4.2.5 Test Setup.....	24
4.2.6 EUT Operating Condition	24
4.2.7 Test Results	25
4.3 Number of Hopping Frequency Used.....	27
4.3.1 Limits of Hopping Frequency Used Measurement	27
4.3.2 Test Setup.....	27
4.3.3 Test Instruments	27
4.3.4 Test Procedure	27
4.3.5 Deviation from Test Standard	27
4.3.6 Test Results	28
4.4 Dwell Time on Each Channel	29
4.4.1 Limits of Dwell Time on Each Channel Measurement.....	29
4.4.2 Test Setup.....	29
4.4.3 Test Instruments	29
4.4.4 Test Procedures.....	29
4.4.5 Deviation from Test Standard	29
4.4.6 Test Results	30
4.5 Channel Bandwidth	32
4.5.1 Limits of Channel Bandwidth Measurement.....	32
4.5.2 Test Setup.....	32
4.5.3 Test Instruments	32
4.5.4 Test Procedure	32
4.5.5 Deviation from Test Standard	32
4.5.6 EUT Operating Condition	32
4.5.7 Test Results	33
4.6 Hopping Channel Separation	34
4.6.1 Limits of Hopping Channel Separation Measurement.....	34
4.6.2 Test Setup.....	34

4.6.3	Test Instruments	34
4.6.4	Test Procedure	34
4.6.5	Deviation From Test Standard	34
4.6.6	Test Results	35
4.7	Maximum Output Power	37
4.7.1	Limits of Maximum Output Power Measurement	37
4.7.2	Test Setup	37
4.7.3	Test Instruments	37
4.7.4	Test Procedure	37
4.7.5	Deviation from Test Standard	37
4.7.6	EUT Operating Condition	37
4.7.7	Test Results	38
4.8	Conducted Out of Band Emission Measurement	39
4.8.1	Limits Of Conducted Out Of Band Emission Measurement	39
4.8.2	Test Instruments	39
4.8.3	Test Procedure	39
4.8.4	Deviation From Test Standard	39
4.8.5	Eut Operating Condition	39
4.8.6	Test Results	39
5	Pictures of Test Arrangements	42
	Appendix – Information on the Testing Laboratories	43



A D T

RELEASE CONTROL RECORD

ISSUE NO.	REASON FOR CHANGE	DATE ISSUED
RF160624W002-1	Original release	July 01, 2016

1 Certificate of Conformity

Product: Mobile Phone
Brand: Lenovo
Test Model: Lenovo A2016b31
Sample Status: Identical Prototype
Applicant: Lenovo Mobile Communication Technology Ltd.
Test Date: Jun. 25, 2016~ Jun. 30, 2016
Standards: FCC Part 15, Subpart C (Section 15.247)
ANSI C63.10: 2013

The above equipment has been tested by **Bureau Veritas Consumer Products Services (H.K.) Ltd., Taoyuan Branch**, and found compliance with the requirement of the above standards. The test record, data evaluation & Equipment Under Test (EUT) configurations represented herein are true and accurate accounts of the measurements of the sample's EMC characteristics under the conditions specified in this report.

Prepared by :  , Date: July 01, 2016
Amyee Qian / Engineer

Approved by :  , Date: July 01, 2016
William Chung / Manager

2 Summary of Test Results

FCC Part 15, Subpart C (SECTION 15.247) (BT EDR)			
FCC Clause	Test Item	Result	Remarks
15.207	AC Power Conducted Emission	PASS	Meet the requirement of limit. Minimum passing margin is 7.03dB at 0.158000MHz.
15.247(a)(1)(iii)	Number of Hopping Frequency Used	PASS	Meet the requirement of limit.
15.247(a)(1)(iii)	Dwell Time on Each Channel	PASS	Meet the requirement of limit.
15.247(a)(1)	1. Hopping Channel Separation 2. Spectrum Bandwidth of a Frequency Hopping Sequence Spread Spectrum System	PASS	Meet the requirement of limit.
15.247(b)	Maximum Peak Output Power	PASS	Meet the requirement of limit.
15.205 & 209	Radiated Emissions	PASS	Meet the requirement of limit. Minimum passing margin is -4.53dB at 44.55MHz.
15.247(d)	Band Edge Measurement	PASS	Meet the requirement of limit.
15.203	Antenna Requirement	PASS	No antenna connector is used.

NOTE: If The Frequency Hopping System operating in 2400-2483.5MHz band and the output power less than 125mW. The hopping channel carrier frequencies separated by a minimum of 25kHz or two-thirds of the 20dB bandwidth of hopping channel whichever is greater.

2.1 Measurement Uncertainty

Where relevant, the following measurement uncertainty levels have been estimated for tests performed on the EUT as specified in CISPR 16-4-2:

Measurement	Frequency	Expanded Uncertainty (k=2) (\pm)
Conducted Emissions at mains ports	9kHz ~ 30MHz	2.44 dB
Radiated Emissions up to 1 GHz	9KHZ ~ 30MHZ	2.74 dB
	30MHz ~ 200MHz	2.93 dB
	200MHz ~ 1000MHz	2.95 dB
Radiated Emissions above 1 GHz	1GHz ~ 18GHz	2.26 dB
	18GHz ~ 40GHz	1.94 dB

This uncertainty represents an expanded uncertainty expressed at approximately the 95% confidence level using a coverage factor of k=2.

3 General Information

3.1 General Description of EUT

Product	Mobile Phone	
Brand	Lenovo	
Test Model	Lenovo A2016b31	
Power Supply Rating	5.0Vdc (adapter or host equipment) 3.8Vdc (battery)	
Modulation Technology	BT EDR	FHSS
Modulation Type	BT EDR	GFSK, 8DPSK, $\pi/4$ DQPSK
Transfer Rate	BT EDR	1/2/3 Mbps
Operating Frequency	2402MHz ~ 2480MHz	
Number of Channel	BT EDR	79
Output Power	BT EDR	4.395mW
Antenna Type	PIFA Antenna with -2.13dBi gain	
Accessory Device	Refer to note as below	
Data Cable Supplied	USB cable: non-shielded, detachable, 0.7m Earphone: non-shielded, detachable, 1.3m	

Note:

1. The above EUT information is declared by manufacturer and for more detailed features description, please refer to the manufacturer's specifications or User's Manual.
2. There were Sample A and Sample B for this project, the difference is the color and configuration, as below:

SAMPLE	EUT CONFIGURATION INFORMATION
A (Black)	LCD panel 1+ Photo Camera 1+ Video Camera 1+ Main Broad 1
B (White)	LCD panel 2+ Photo Camera 2+ Video Camera 2+ Main Broad 2

3. For the test results, the EUT had been tested with all conditions. But only the worst case was shown in test report.

LIST OF ACCESSORIES:

ACCESSORIES	BRAND	MANUFACTURER	MODEL	SPECIFICATION
AC Adapter 1	Lenovo	CHENYANG	C-P56	I/P:100-240Vac, 130mA O/P:5.0Vdc, 1000mA
AC Adapter 2	Lenovo	Acbel	C-P56	I/P:100-240Vac, 130mA O/P:5.0Vdc, 1000mA
Battery 1	Lenovo	ATL	BL253	Rating: 3.8Vdc, 2000mAh
Battery 2	Lenovo	VK	BL253	Rating: 3.8Vdc, 2000mAh
USB Cable 1	Lenovo	FUKANGYUAN	F16W-05100070L	0.7m non-shielded cable w/o core
USB Cable 2	Lenovo	LIQI	L16W-05100070L	0.7m non-shielded cable w/o core
Earphone 1	Lenovo	TIANZHI	TJ101247A	1.3m non-shielded cable w/o core
Earphone 2	Lenovo	LIANYUN	TS990B-28AMS05-M	1.3m non-shielded cable w/o core
LCD Panel 1	HELITAI	--	QTB4D543	--
LCD Panel 1	TONGXINGDA	--	TXDT450SKP-73V6	--
Photo Camera 1	BOLIXIN	--	BLX2355H-AL732-F	--
Photo Camera 2	HUAQUAN	--	G6P2-AL732FHQ	--
Video Camera 1	QUNHUI	--	SHT6029B1S-1P0J0	--
Video Camera 2	HUAQUAN	--	G7B5-AL732BHQ	--
Main Broad 1	HUASHEN	--	AL732_MB_PCB_V2.0	--
Main Broad 2	YILIANDA	--	AL732_MB_PCB_V2.0	--
BT/WLAN Module	MTK	--	MT6625L	--
WWAN Module	N/A	--	N/A	--

3.2 Description of Test Modes

79 channels are provided for BT-EDR mode:

Channel	Freq. (MHz)	Channel	Freq. (MHz)	Channel	Freq. (MHz)	Channel	Freq. (MHz)
0	2402	20	2422	40	2442	60	2462
1	2403	21	2423	41	2443	61	2463
2	2404	22	2424	42	2444	62	2464
3	2405	23	2425	43	2445	63	2465
4	2406	24	2426	44	2446	64	2466
5	2407	25	2427	45	2447	65	2467
6	2408	26	2428	46	2448	66	2468
7	2409	27	2429	47	2449	67	2469
8	2410	28	2430	48	2450	68	2470
9	2411	29	2431	49	2451	69	2471
10	2412	30	2432	50	2452	70	2472
11	2413	31	2433	51	2453	71	2473
12	2414	32	2434	52	2454	72	2474
13	2415	33	2435	53	2455	73	2475
14	2416	34	2436	54	2456	74	2476
15	2417	35	2437	55	2457	75	2477
16	2418	36	2438	56	2458	76	2478
17	2419	37	2439	57	2459	77	2479
18	2420	38	2440	58	2460	78	2480
19	2421	39	2441	59	2461		

3.2.1 Test Mode Applicability and Tested Channel Detail

BT EDR

EUT CONFIGURE MODE	APPLICABLE TO				DESCRIPTION
	RE≥1G	RE<1G	PLC	APCM	
-	√	√	√	√	-

Where **RE≥1G**: Radiated Emission above 1GHz **RE<1G**: Radiated Emission below 1GHz
PLC: Power Line Conducted Emission **APCM**: Antenna Port Conducted Measurement

NOTE:

1. The EUT had been pre-tested on the positioned of each 3 axis. The worst case was found when positioned on **X-plane**.
2. "-" means no effect.

Radiated Emission Test (Above 1GHz):

- Pre-Scan has been conducted to determine the worst-case mode from all possible combinations between available modulations, data rates and antenna ports (if EUT with antenna diversity architecture).
- Following channel(s) was (were) selected for the final test as listed below.

EUT CONFIGURE MODE	AVAILABLE CHANNEL	TESTED CHANNEL	MODULATION TECHNOLOGY	MODULATION TYPE	PACKET TYPE
-	0 to 78	0, 39, 78	FHSS	GFSK	DH5

Radiated Emission Test (Below 1GHz):

- Pre-Scan has been conducted to determine the worst-case mode from all possible combinations between available modulations, data rates and antenna ports (if EUT with antenna diversity architecture).
- Following channel(s) was (were) selected for the final test as listed below.

EUT CONFIGURE MODE	AVAILABLE CHANNEL	TESTED CHANNEL	MODULATION TECHNOLOGY	MODULATION TYPE	PACKET TYPE
-	0 to 78	78	FHSS	GFSK	DH5

Power Line Conducted Emission Test:

- Pre-Scan has been conducted to determine the worst-case mode from all possible combinations between available modulations, data rates and antenna ports (if EUT with antenna diversity architecture).
- Following channel(s) was (were) selected for the final test as listed below.

EUT CONFIGURE MODE	AVAILABLE CHANNEL	TESTED CHANNEL	MODULATION TECHNOLOGY	MODULATION TYPE	PACKET TYPE
-	0 to 78	78	FHSS	8DPSK	DH5

Antenna Port Conducted Measurement:

- This item includes all test value of each mode, but only includes spectrum plot of worst value of each mode.
- Pre-Scan has been conducted to determine the worst-case mode from all possible combinations between available modulations, data rates and antenna ports (if EUT with antenna diversity architecture).
- Following channel(s) was (were) selected for the final test as listed below.

EUT CONFIGURE MODE	AVAILABLE CHANNEL	TESTED CHANNEL	MODULATION TECHNOLOGY	MODULATION TYPE	PACKET TYPE
-	0 to 78	0, 39, 78	FHSS	GFSK	DH5
-	0 to 78	0, 39, 78	FHSS	$\pi/4$ DQPSK	DH5
-	0 to 78	0, 39, 78	FHSS	8DPSK	DH5

Test Condition:

APPLICABLE TO	ENVIRONMENTAL CONDITIONS	INPUT POWER	TESTED BY
RE\geq1G	25deg. C, 65%RH	120Vac, 60Hz	Alex Chen
RE<1G	25deg. C, 65%RH	120Vac, 60Hz	Alex Chen
PLC	25deg. C, 68%RH	120Vac, 60Hz	Yuqiang Yin
APCM	21deg. C, 60%RH	120Vac, 60Hz	Wenliang Wu

3.3 Description of Support Units

The EUT has been tested as an independent unit together with other necessary accessories or support units. The following support units or accessories were used to form a representative test configuration during the tests.

NO.	PRODUCT	BRAND	MODEL NO.	SERIAL NO.	FCC ID
1	DC source	LONG WEI	PS-6403D	010934269	N/A
2	PC	HP	A6608CN	3CR83825X3	N/A

NO.	SIGNAL CABLE DESCRIPTION OF THE ABOVE SUPPORT UNITS
1	DC Line: Unshielded, Detachable 1.0m
2	AC Line: Unshielded, Detachable 1.5m

3.3.1 Configuration of System under Test

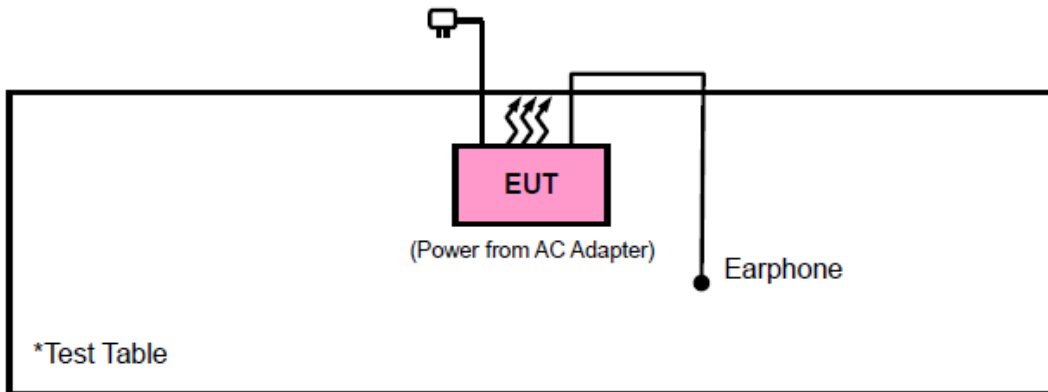

3.4 General Description of Applied Standards

The EUT is a RF Product. According to the specifications of the manufacturer, it must comply with the requirements of the following standards:

- FCC Part 15, Subpart C (15.247)**
- FCC Public Notice DA 00-705**
- 558074 D01 DTS Meas Guidance v03r05**
- ANSI C63.10-2013

All test items have been performed and recorded as per the above standards.

NOTE: The EUT is also considered as a kind of computer peripheral, because the connection to computer is necessary for typical use. It has been verified to comply with the requirements of FCC Part 15, Subpart B, Class B (Doc). The test report has been issued separately.

4 Test Types and Results(For BT EDR)

4.1 Radiated Emission and Bandedge Measurement

4.1.1 Limits of Radiated Emission and Bandedge Measurement

Radiated emissions which fall in the restricted bands must comply with the radiated emission limits specified as below table. Other emissions shall be at least 20dB below the highest level of the desired power:

Frequencies (MHz)	Field Strength (microvolts/meter)	Measurement Distance (meters)
0.009 ~ 0.490	2400/F(kHz)	300
0.490 ~ 1.705	24000/F(kHz)	30
1.705 ~ 30.0	30	30
30 ~ 88	100	3
88 ~ 216	150	3
216 ~ 960	200	3
Above 960	500	3

NOTE:

1. The lower limit shall apply at the transition frequencies.
2. Emission level (dBuV/m) = 20 log Emission level (uV/m).
3. For frequencies above 1000MHz, the field strength limits are based on average detector, however, the peak field strength of any emission shall not exceed the maximum permitted average limits, specified above by more than 20dB under any condition of modulation.

4.1.2 Test Instruments

Equipment	Manufacturer	Model No.	Serial No.	Last Cal.	Next Cal.
EMI Test Receiver	Rohde&Schwarz	ESR7	101494	Apr. 05,16	Apr. 04,17
Bilog Antenna	Teseq	CBL 6111D	30643	Jul. 16, 15	Jul. 15, 16
Loop Antenna	Daze	ZN30900A	0708	Dec. 30, 15	Dec. 29, 16
Horn Antenna (1GHz -18GHz)	ETS -Lindgren	3117	00062558	May 30, 14	May 29, 17
Amplifier	Burgeon	BPA-530	100220	Apr. 05,16	Apr. 04,17
Pre-Amplifier (18GHz-40GHz)	EMCI	EMC 184045	980102	Nov. 20,15	Nov. 19,17
Pre-Amplifier	HP	8449B	3008A00409	Apr. 25,15	Apr. 24,17
GPS Generator+ Antenna	TOJOIN	GNSS-5000A	E1-010119	Aug. 08, 14	Aug. 07, 16
3m Semi-anechoic Chamber	ETS-LINDGREN	9m*6m*6m	NSEMC003	Mar. 12,16	Mar. 11,18
Test Software	ADT	ADT_Radiated _V7.6.15.9.2	N/A	N/A	N/A

- NOTE:**
1. The calibration interval of the above test instruments is 12 months and the calibrations are traceable to NML/ROC and NIST/USA.
 2. The calibration interval of the loop antenna is 24 months and the calibrations are traceable to NML/ROC and NIST/USA.
 3. The test was performed in HwaYa Chamber 4.
 4. The horn antenna and HP preamplifier (model: 8449B) are used only for the measurement of emission frequency above 1GHz if tested.
 5. The FCC Site Registration No. is 460141.
 6. The IC Site Registration No. is IC7450F-4.

4.1.3 Test Procedures

- a. The EUT was placed on the top of a rotating table 0.8 meters (for below 1GHz) / 1.5 meters (for above 1GHz) above the ground at 3 meter chamber room for test. The table was rotated 360 degrees to determine the position of the highest radiation.
- b. The EUT was set 3 meters away from the interference-receiving antenna, which was mounted on the top of a variable-height antenna tower.
- c. The height of antenna is varied from one meter to four meters above the ground to determine the maximum value of the field strength. Both horizontal and vertical polarizations of the antenna are set to make the measurement.
- d. For each suspected emission, the EUT was arranged to its worst case and then the antenna was tuned to heights from 1 meter to 4 meters and the rotatable table was turned from 0 degrees to 360 degrees to find the maximum reading.
- e. The test-receiver system was set to quasi-peak detect function and specified bandwidth with maximum hold mode when the test frequency is below 1 GHz.
- f. The test-receiver system was set to peak detect function and specified bandwidth with maximum hold mode when the test frequency is above 1 GHz.

Note:

1. The resolution bandwidth and video bandwidth of test receiver/spectrum analyzer is 120kHz for Quasi-peak detection (QP) at frequency below 1GHz.
2. The resolution bandwidth of test receiver/spectrum analyzer is 1 MHz and the video bandwidth is 3 MHz for Peak detection (PK) at frequency above 1GHz.
3. For Average measurement, due to the DH5 packet was the worse case duty cycle for a transmit dwell time on a channel, based upon bluetooth theory the transmitter is on $0.625 * 5$ per 296.25 ms per channel. Therefore, the duty cycle correlation factor be equal to: $20\log(3.125 / 100) = -30.1$ dB, therefore Average value = peak reading + $20\log(\text{duty cycle})$.
4. All modes of operation were investigated and the worst-case emissions are reported.

4.1.4 Deviation from Test Standard

No deviation.

4.1.5 Test Set Up

<Frequency Range below 1GHz>

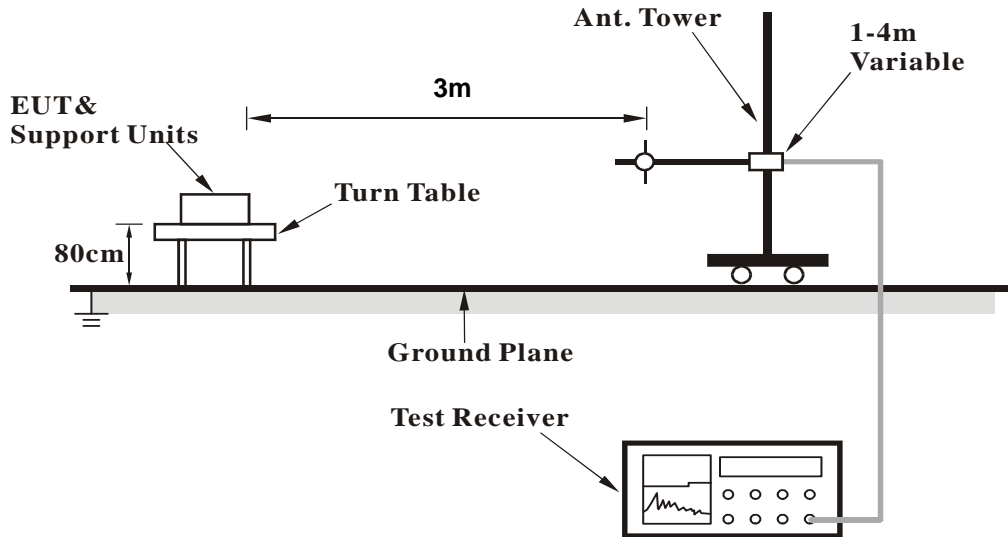

<Frequency Range above 1GHz>

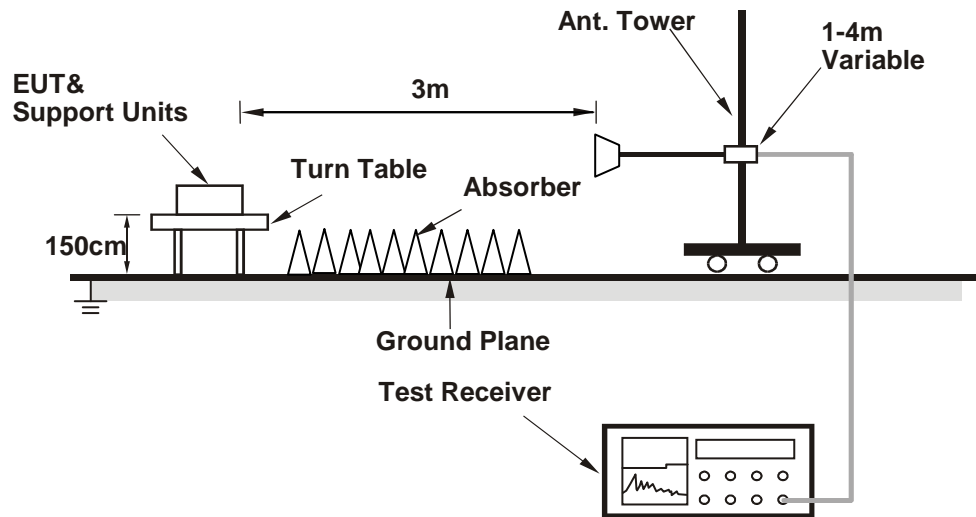

For the actual test configuration, please refer to the attached file (Test Setup Photo).

4.1.6 EUT Operating Conditions

Set the EUT under transmission condition continuously at specific channel frequency.

4.1.7 Test Results

BELOW 1GHz WORST-CASE DATA:

9 KHz – 30 KHz data: the amplitude of spurious emissions attenuated more than 20 dB below the permissible value is not required in the report.

30 MHz – 1GHz data:

CHANNEL	TX Channel 0	DETECTOR FUNCTION	Quasi-Peak (QP)
FREQUENCY RANGE	30MHz ~ 1GHz		

ANTENNA POLARITY & TEST DISTANCE: HORIZONTAL AT 3 M									
FREQ. (MHz)	EMISSION LEVEL (dBuV/m)	READ LEVEL (dBuV)	LIMIT (dBuV/m)	MARGIN (dB)	ANTENNA FACTOR (dB /m)	CABLE LOSS (dB)	ANTENNA HEIGHT (cm)	TABLE ANGLE (Degree)	REMARK
45.52	20.28	47.26	40.00	-19.72	8.16	-35.14	101	35	QP
99.84	24.63	51.19	43.50	-18.87	7.98	-34.54	101	167	QP
169.68	21.53	45.47	43.50	-21.97	10.05	-33.99	101	221	QP
230.79	23.12	45.35	46.00	-22.88	11.52	-33.75	101	268	QP
368.53	15.89	33.33	46.00	-30.11	15.88	-33.32	101	111	QP
672.14	22.11	32.64	46.00	-23.89	22.32	-32.85	101	58	QP

REMARKS:

1. Emission Level(dBuV/m) = Raw Value(dBuV) + Correction Factor(dB/m)
2. Correction Factor(dB/m) = Antenna Factor(dB/m) + Cable Factor(dB) – Pre-Amplifier Factor(dB)
3. The other emission levels were very low against the limit.
4. Margin value = Emission Level – Limit value

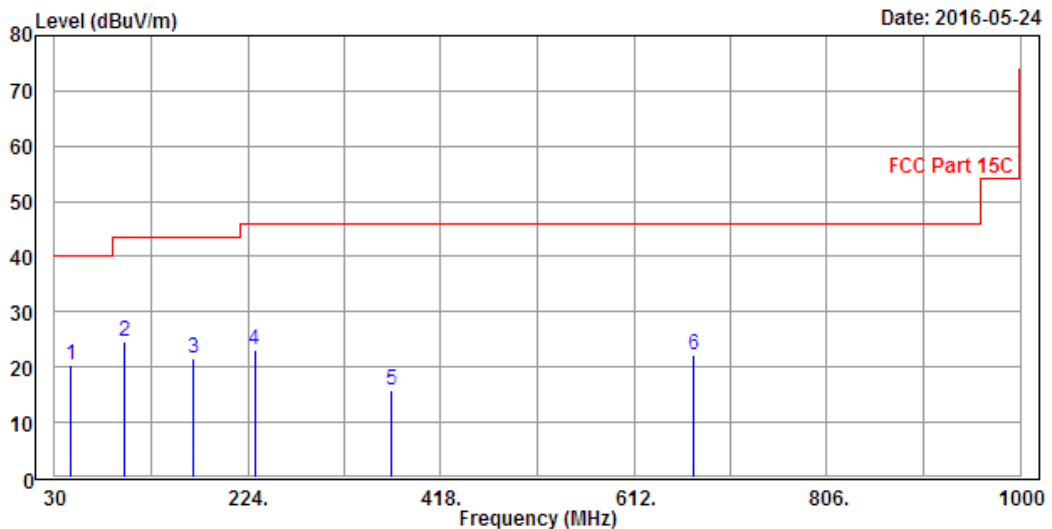

CHANNEL	TX Channel 0	DETECTOR FUNCTION	Quasi-Peak (QP)
FREQUENCY RANGE	30MHz ~ 1GHz		

ANTENNA POLARITY & TEST DISTANCE: VERTICAL AT 3 M									
FREQ. (MHz)	EMISSION LEVEL (dBuV/m)	READ LEVEL (dBuV)	MARGIN (dB)	LIMIT (dBuV/m)	ANTENNA FACTOR (dB /m)	CABLE LOSS (dB)	ANTENNA HEIGHT (cm)	TABLE ANGLE (Degree)	REMARK
44.55	35.47	62.10	-4.53	40.00	8.52	-35.15	200	213	QP
58.13	30.44	58.91	-9.56	40.00	6.42	-34.89	200	234	QP
98.87	22.64	49.31	-20.86	43.50	7.88	-34.55	200	86	QP
164.83	13.39	37.27	-30.11	43.50	10.13	-34.01	200	154	QP
215.27	16.38	39.40	-27.12	43.50	10.80	-33.82	200	76	QP
485.9	18.00	32.99	-28.00	46.00	18.23	-33.22	200	302	QP

REMARKS:

1. Emission Level(dBuV/m) = Raw Value(dBuV) + Correction Factor(dB/m)
2. Correction Factor(dB/m) = Antenna Factor(dB/m) + Cable Factor(dB) – Pre-Amplifier Factor(dB)
3. The other emission levels were very low against the limit.
4. Margin value = Emission Level – Limit value

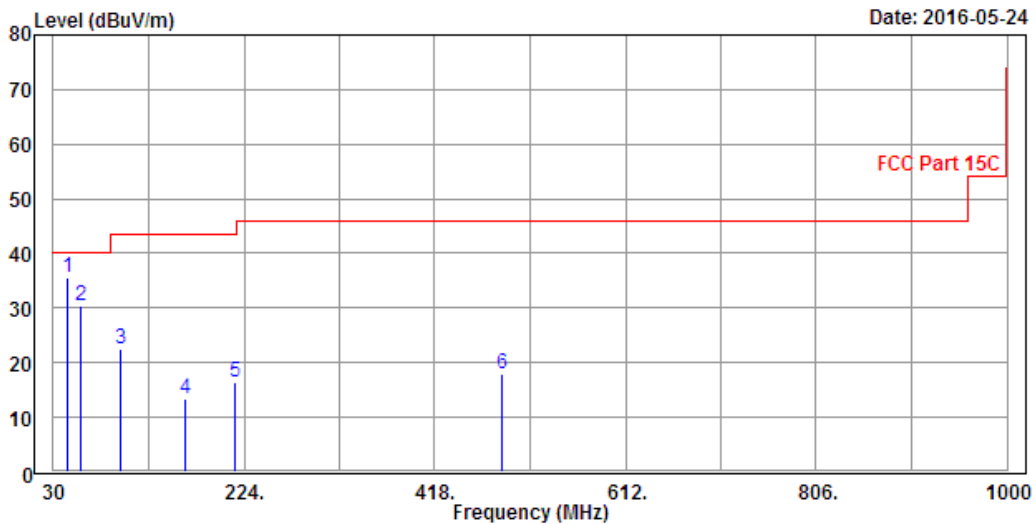

**ABOVE 1GHz WORST-CASE DATA:
GFSK DH5**

CHANNEL	TX Channel 0	DETECTOR FUNCTION	Peak (PK)
FREQUENCY RANGE	1GHz ~ 25GHz		Average (AV)

ANTENNA POLARITY & TEST DISTANCE: HORIZONTAL AT 3 M									
FREQ. (MHz)	EMISSION LEVEL (dBuV/m)	READ LEVEL (dBuV)	MARGIN (dB)	LIMIT (dBuV/m)	ANTENNA FACTOR (dB /m)	CABLE LOSS (dB)	ANTENNA HEIGHT (cm)	TABLE ANGLE (Degree)	REMARK
2390	33.32	41.19	-20.68	54.00	32.29	8.15	130	125	Average
2390	43.86	51.73	-30.14	74.00	32.29	8.15	130	125	Peak
2402	85.01	92.85			32.30	8.17	130	125	Average
2402	95.12	102.96			32.30	8.17	130	125	Peak
4804	39.30	41.34	-14.70	54.00	34.30	12.55	130	268	Average
4804	50.04	52.08	-23.96	74.00	34.30	12.55	130	268	Peak
ANTENNA POLARITY & TEST DISTANCE: VERTICAL AT 3 M									
FREQ. (MHz)	EMISSION LEVEL (dBuV/m)	READ LEVEL (dBuV)	MARGIN (dB)	LIMIT (dBuV/m)	ANTENNA FACTOR (dB /m)	CABLE LOSS (dB)	ANTENNA HEIGHT (cm)	TABLE ANGLE (Degree)	REMARK
2390	33.30	41.17	-20.70	54.00	32.29	8.15	100	85	Average
2390	43.35	51.22	-30.65	74.00	32.29	8.15	100	85	Peak
2402	83.83	91.67			32.30	8.17	100	85	Average
2402	94.84	102.68			32.30	8.17	100	85	Peak
4804	39.22	41.26	-14.78	54.00	34.30	12.55	100	175	Average
4804	50.23	52.27	-23.77	74.00	34.30	12.55	100	175	Peak

REMARKS:

- Emission Level = Read Level+ Antenna Factor + Cable Loss- Preamp Factor
Margin value = Emission level – Limit value.
- 2402MHz: Fundamental frequency.

CHANNEL	TX Channel 39	DETECTOR FUNCTION	Peak (PK)
FREQUENCY RANGE	1GHz ~ 25GHz		Average (AV)

ANTENNA POLARITY & TEST DISTANCE: HORIZONTAL AT 3 M									
FREQ. (MHz)	EMISSION LEVEL (dBuV/m)	READ LEVEL (dBuV)	MARGIN (dB)	LIMIT (dBuV/m)	ANTENNA FACTOR (dB /m)	CABLE LOSS (dB)	ANTENNA HEIGHT (cm)	TABLE ANGLE (Degree)	REMARK
2441	88.16	95.89			32.34	8.24	130	120	Average
2441	99.72	107.45			32.34	8.24	130	120	Peak
4882	40.63	42.41	-13.37	54.00	34.30	12.84	130	205	Average
4882	51.68	53.46	-22.32	74.00	34.30	12.84	130	205	Peak
7322	43.83	41.07	-10.17	54.00	36.16	15.35	130	64	Average
7322	54.73	51.97	-19.27	74.00	36.16	15.35	130	64	Peak
ANTENNA POLARITY & TEST DISTANCE: VERTICAL AT 3 M									
FREQ. (MHz)	EMISSION LEVEL (dBuV/m)	READ LEVEL (dBuV)	MARGIN (dB)	LIMIT (dBuV/m)	ANTENNA FACTOR (dB /m)	CABLE LOSS (dB)	ANTENNA HEIGHT (cm)	TABLE ANGLE (Degree)	REMARK
2441	89.81	97.54			32.34	8.24	100	85	Average
2441	99.37	107.10			32.34	8.24	100	85	Peak
4882	40.40	42.18	-13.60	54.00	34.30	12.84	100	175	Average
4882	51.68	53.46	-22.32	74.00	34.30	12.84	100	175	Peak
7323	43.78	41.02	-10.22	54.00	36.16	15.35	100	234	Average
7323	55.97	53.21	-18.03	74.00	36.16	15.35	100	234	Peak

REMARKS:

- Emission Level = Read Level+ Antenna Factor + Cable Loss- Preamp Factor
Margin value = Emission level – Limit value.
- 2441MHz: Fundamental frequency.

CHANNEL	TX Channel 78	DETECTOR FUNCTION	Peak (PK)
FREQUENCY RANGE	1GHz ~ 25GHz		Average (AV)

ANTENNA POLARITY & TEST DISTANCE: HORIZONTAL AT 3 M									
FREQ. (MHz)	EMISSION LEVEL (dBuV/m)	READ LEVEL (dBuV)	MARGIN (dB)	LIMIT (dBuV/m)	ANTENNA FACTOR (dB /m)	CABLE LOSS (dB)	ANTENNA HEIGHT (cm)	TABLE ANGLE (Degree)	REMARK
2480	85.41	93.02			32.38	8.31	130	130	Average
2480	98.34	105.95			32.38	8.31	130	130	Peak
2483.5	33.69	41.29	-20.31	54.00	32.38	8.32	130	130	Average
2483.5	43.89	51.49	-30.11	74.00	32.38	8.32	130	130	Peak
4960	40.12	41.64	-13.88	54.00	34.30	13.13	130	58	Average
4960	50.76	52.28	-23.24	74.00	34.30	13.13	130	58	Peak
7440	43.85	40.89	-10.15	54.00	36.25	15.39	130	231	Average
7440	55.37	52.41	-18.63	74.00	36.25	15.39	130	231	Peak
ANTENNA POLARITY & TEST DISTANCE: VERTICAL AT 3 M									
FREQ. (MHz)	EMISSION LEVEL (dBuV/m)	READ LEVEL (dBuV)	MARGIN (dB)	LIMIT (dBuV/m)	ANTENNA FACTOR (dB /m)	CABLE LOSS (dB)	ANTENNA HEIGHT (cm)	TABLE ANGLE (Degree)	REMARK
2480	88.40	96.01			32.38	8.31	100	90	Average
2480	98.68	106.29			32.38	8.31	100	90	Peak
2483.5	33.87	41.47	-20.13	54.00	32.38	8.32	100	90	Average
2483.5	49.02	56.62	-24.98	74.00	32.38	8.32	100	90	Peak
4960	39.91	41.43	-14.09	54.00	34.30	13.13	100	212	Average
4960	51.31	52.83	-22.69	74.00	34.30	13.13	100	212	Peak
7440	43.73	40.77	-10.27	54.00	36.25	15.39	100	286	Average
7440	54.22	51.26	-19.78	74.00	36.25	15.39	100	286	Peak

REMARKS:

- Emission Level = Read Level+ Antenna Factor + Cable Loss- Preamp Factor
Margin value = Emission level – Limit value.
- 2480MHz: Fundamental frequency.

4.2 Conducted Emission Measurement

4.2.1 Limits of Conducted Emission Measurement

Frequency (MHz)	Conducted Limit (dBuV)	
	Quasi-peak	Average
0.15 - 0.5	66 - 56	56 - 46
0.50 - 5.0	56	46
5.0 - 30.0	60	50

NOTE: 1. The lower limit shall apply at the transition frequencies.

2. The limit decreases in line with the logarithm of the frequency in the range of 0.15 to 0.50MHz.

3. All emanations from a class A/B digital device or system, including any network of conductors and apparatus connected thereto, shall not exceed the level of field strengths specified above.

4.2.2 Test Instruments

Equipment	Manufacturer	Model No.	Serial No.	Last Cal.	Next Cal.
EMI Test Receiver	Rohde&Schwarz	ESCS30	100340	May 11,15	May 10,17
Artificial Mains Network	Rohde&Schwarz	ENV216	101173	Mar. 04,16	Mar. 03,17
Artificial Mains Network	Rohde&Schwarz	ESH3-Z5	100317	Apr. 05,16	Apr. 04,17
Voltage probe	SCHWARZBECK	TK 9421	TK 9421-176	Jan. 08,16	Jan. 07,17
Test software	ADT	ADT_Cond_V7.3.7	N/A	N/A	N/A

NOTE: 1. The calibration interval of the above test instruments is 12 months and the calibrations are traceable to NML/ROC and NIST/USA.

2. The test was performed in HwaYa Shielded Room 1.

3. The VCCI Site Registration No. is C-2040.

4.2.3 Test Procedures

- a. The EUT was placed 0.4 meters from the conducting wall of the shielded room with EUT being connected to the power mains through a line impedance stabilization network (LISN). Other support units were connected to the power mains through another LISN. The two LISNs provide 50 ohm/ 50uH of coupling impedance for the measuring instrument.
- b. Both lines of the power mains connected to the EUT were checked for maximum conducted interference.
- c. The frequency range from 150kHz to 30MHz was searched. Emission levels under (Limit - 20dB) was not recorded.

NOTE: All modes of operation were investigated and the worst-case emissions are reported.

4.2.4 Deviation From Test Standard

No deviation.

4.2.5 Test Setup

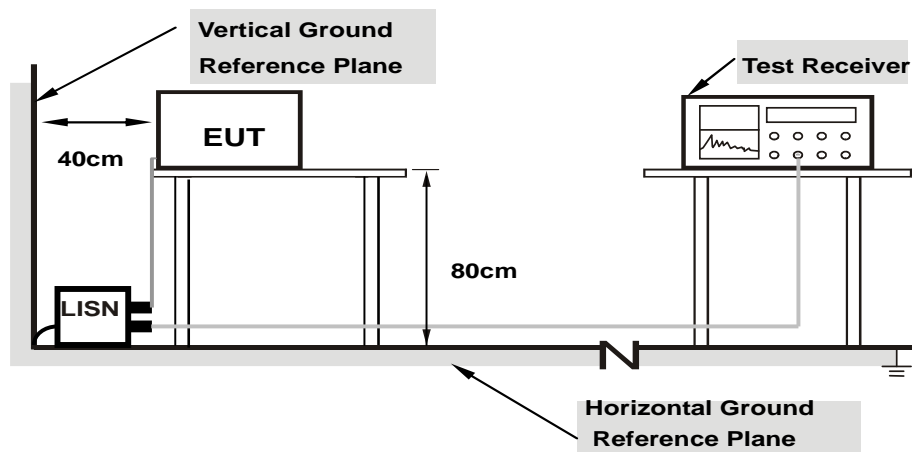

- Note:**
1. Support units were connected to second LISN.
 2. Both of LISNs (AMN) are 80 cm from EUT and at least 80 from other units and other metal planes

For the actual test configuration, please refer to the attached file (Test Setup Photo).

4.2.6 EUT Operating Condition

Same as 4.1.6.

4.2.7 Test Results

CONDUCTED WORST-CASE DATA

TEST VOLTAGE	DC 5.0V From Adapter Input 230 Vac, 50 Hz	6dB BANDWIDTH	9 kHz
ENVIRONMENTAL CONDITIONS	24deg. C, 55RH	TESTED BY	Eric

Frequency (MHz)	QuasiPeak (dB μ V)	CAverage (dB μ V)	Limit (dB μ V)	Margin (dB)	Line	Filter	Corr. (dB)
0.158000	---	46.39	55.57	9.18	L	ON	9.6
0.158000	58.54	---	65.57	7.03	L	ON	9.6
0.188000	---	38.64	54.12	15.48	L	ON	9.7
0.188000	52.63	---	64.12	11.49	L	ON	9.7
0.364000	---	25.37	48.64	23.27	L	ON	9.7
0.364000	36.86	---	58.64	21.78	L	ON	9.7
0.972000	---	26.17	46.00	19.83	L	ON	9.7
0.972000	35.99	---	56.00	20.01	L	ON	9.7
3.608000	---	22.00	46.00	24.00	L	ON	9.7
3.608000	33.77	---	56.00	22.23	L	ON	9.7
4.734000	---	24.32	46.00	21.68	L	ON	9.7
4.734000	37.29	---	56.00	18.71	L	ON	9.7

- REMARKS:**
1. Q.P. and AV. are abbreviations of quasi-peak and average individually.
 2. "-": The Quasi-peak reading value also meets average limit and measurement with the average detector is unnecessary.
 3. The emission levels of other frequencies were very low against the limit.
 4. Margin value = Emission level - Limit value
 5. Correction factor = Insertion loss + Cable loss
 6. Emission Level = Correction Factor + Reading Value.

Full Spectrum

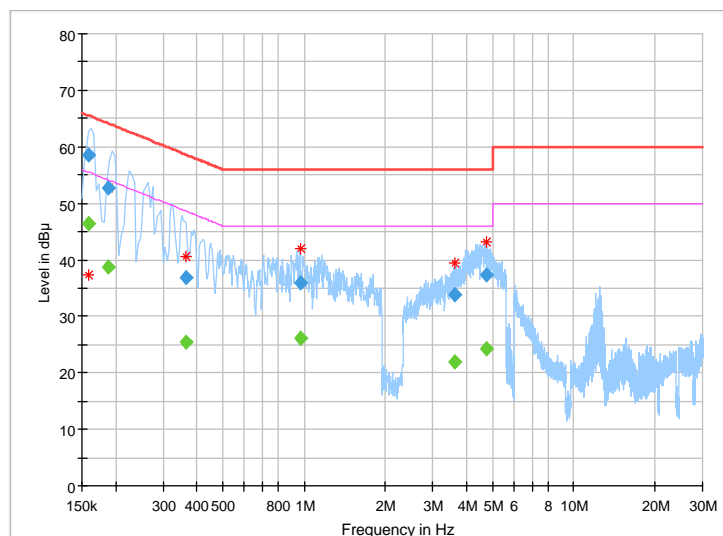

TEST VOLTAGE	DC 5.0V From Adapter Input 230 Vac, 50 Hz	6dB BANDWIDTH	9 kHz
ENVIRONMENTAL CONDITIONS	24deg. C, 55RH	TESTED BY	Eric

Frequency (MHz)	QuasiPeak (dBuV)	CAverage (dBuV)	Limit (dBuV)	Margin (dB)	Line	Filter	Corr. (dB)
0.158000	---	44.78	55.57	10.79	N	ON	10.1
0.158000	55.71	---	65.57	9.86	N	ON	10.1
0.284000	---	39.44	50.70	11.26	N	ON	10.0
0.284000	46.99	---	60.70	13.71	N	ON	10.0
0.708000	---	30.69	46.00	15.31	N	ON	10.0
0.708000	41.45	---	56.00	14.55	N	ON	10.0
0.932000	---	30.84	46.00	15.16	N	ON	9.9
0.932000	41.72	---	56.00	14.28	N	ON	9.9
1.308000	---	27.46	46.00	18.54	N	ON	9.9
1.308000	37.97	---	56.00	18.03	N	ON	9.9
4.600000	---	24.15	46.00	21.85	N	ON	9.8
4.600000	37.91	---	56.00	18.09	N	ON	9.8

- REMARKS:**
1. Q.P. and AV. are abbreviations of quasi-peak and average individually.
 2. "-": The Quasi-peak reading value also meets average limit and measurement with the average detector is unnecessary.
 3. The emission levels of other frequencies were very low against the limit.
 4. Margin value = Emission level - Limit value
 5. Correction factor = Insertion loss + Cable loss
 6. Emission Level = Correction Factor + Reading Value.

Full Spectrum

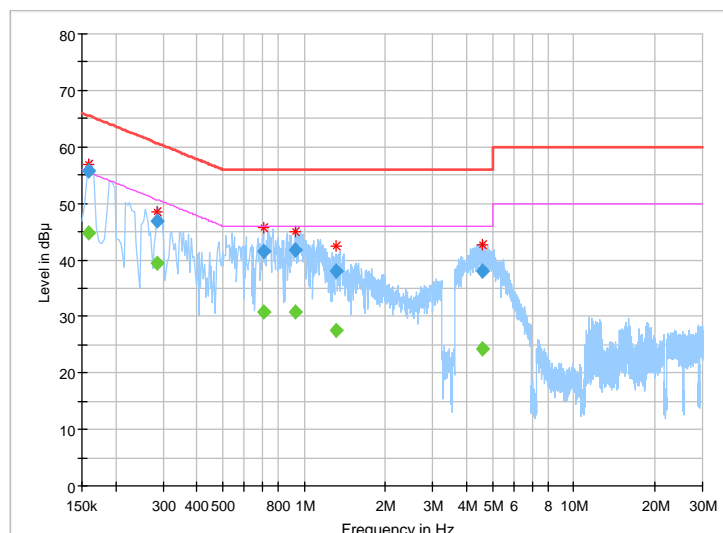

4.3 Number of Hopping Frequency Used

4.3.1 Limits of Hopping Frequency Used Measurement

At least 15 channels frequencies, and should be equally spaced.

4.3.2 Test Setup

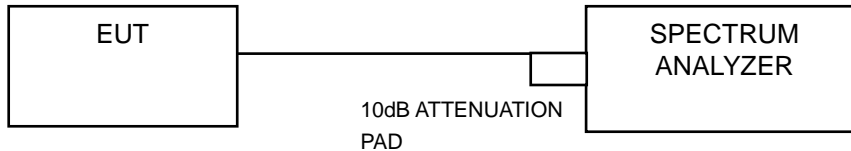

4.3.3 Test Instruments

Equipment	Manufacturer	Model No.	Serial No.	Last Cal.	Next Cal.
Spectrum Analyzer (10Hz–40GHz)	Rohde&Schwarz	FSV40	101003	Apr. 05,16	Apr. 04,17
Power Meter	Anritsu	ML2495A	1139001	Feb.19,16	Feb. 18,17
Power Sensor	Anritsu	MA2411B	1126068	Feb.19,16	Feb. 18,17
Power Sensor	Keysight	U2021XA	MY55060016	May 27,15	May 26,17
Power Sensor	Keysight	U2021XA	MY55060018	May 27,15	May 26,17
Digital Multimeter	FLUKE	15B	A1220010DG	Oct. 12, 15	Oct.11, 16

NOTE:

1. The calibration interval of the above test instruments is 12 months and the calibrations are traceable to CEPREI/CHINA, GRGT/CHINA and NIM/CHINA.
2. The test was performed in RF Oven room.

4.3.4 Test Procedure

- a. Check the calibration of the measuring instrument (SA) using either an internal calibrator or a known signal from an external generator.
- b. Turn on the EUT and connect its antenna terminal to measurement via a low loss cable. Then set it to any one measured frequency within its operating range and make sure the instrument is operated in its linear range.
- c. Set the SA on MaxHold Mode, and then keep the EUT in hopping mode. Record all the signals from each channel until each one has been recorded.
- d. Set the SA on View mode and then plot the result on SA screen.
- e. Repeat above procedures until all frequencies measured were complete.

4.3.5 Deviation from Test Standard

No deviation.

4.3.6 Test Results

There are 79 hopping frequencies in the hopping mode. Please refer to next page for the test result. On the plots, it shows that the hopping frequencies are equally spaced.



4.4 Dwell Time on Each Channel

4.4.1 Limits of Dwell Time on Each Channel Measurement

The average time of occupancy on any channel shall not be greater than 0.4 seconds within a period of 0.4 seconds multiplied by the number of hopping channels employed.

4.4.2 Test Setup

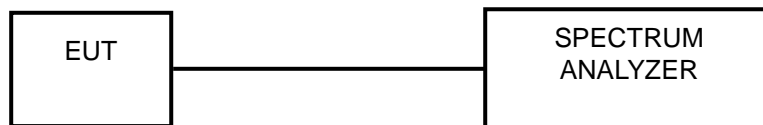

4.4.3 Test Instruments

Refer to section 4.3.3 to get information of above instrument.

4.4.4 Test Procedures

- a. Check the calibration of the measuring instrument (SA) using either an internal calibrator or a known signal from an external generator.
- b. Turn on the EUT and connect its antenna terminal to measurement via a low loss cable. Then set it to any one measured frequency within its operating range and make sure the instrument is operated in its linear range.
- c. Adjust the center frequency of SA on any frequency to be measured and set SA to zero span mode. And then, set RBW and VBW of spectrum analyzer to proper value.
- d. Measure the time duration of one transmission on the measured frequency. And then plot the result with time difference of this time duration.
- e. Repeat above procedures until all different time-slot modes have been completed.

4.4.5 Deviation from Test Standard

No deviation.

4.4.6 Test Results

GFSK

Mode	Number of Hopping Channel	Number of transmission in a period(channel number*0.4 sec)				Length of transmission time (msec)	Result (msec)	Limit (msec)	PASS / FAIL
		period (sec)	sweep time (sec)	times in a sweep	times in a period				
DH1	79	31.6	5	48	303.36	0.417	126.5	400	PASS
DH3	79	31.6	5	25	158	1.675	264.65	400	PASS
DH5	79	31.6	5	17	107.44	2.915	313.19	400	PASS

NOTE: Test plots of the transmitting time slot are shown on next 3 pages.

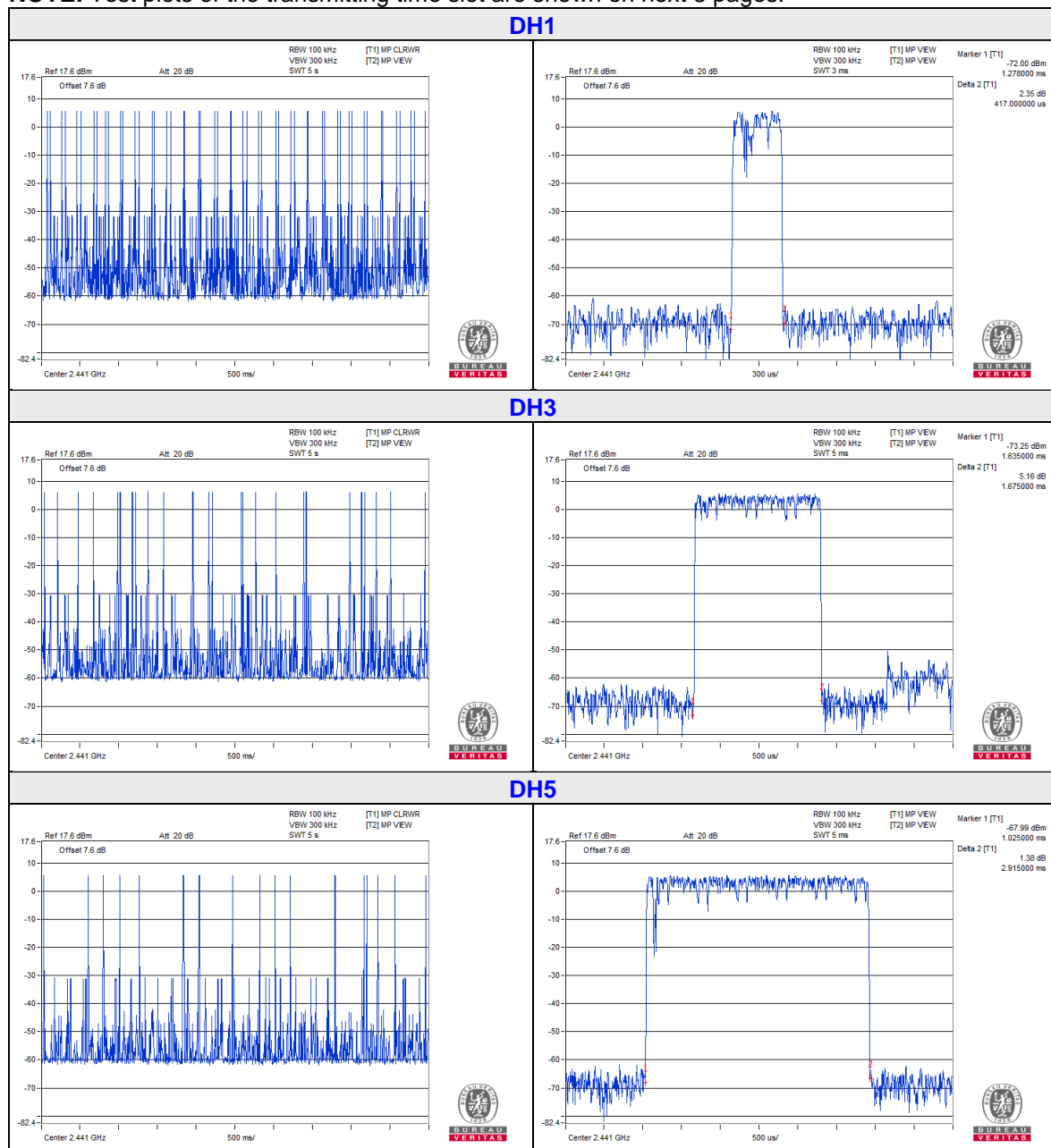

8DPSK

Mode	Number of Hopping Channel	Number of transmission in a period(channel number*0.4 sec)				Length of transmission time (msec)	Result (msec)	Limit (msec)	PASS / FAIL
		period (sec)	sweep time (sec)	times in a sweep	times in a period				
DH1	79	31.6	5	49	309.68	0.423	130.99	400	PASS
DH3	79	31.6	5	25	158	1.66	262.28	400	PASS
DH5	79	31.6	5	16	101.12	2.92	295.27	400	PASS

NOTE: Test plots of the transmitting time slot are shown on next 3 pages.



4.5 Channel Bandwidth

4.5.1 Limits of Channel Bandwidth Measurement

For frequency hopping system operating in the 2400-2483.5MHz, If the 20dB bandwidth of hopping channel is greater than 25kHz, two-thirds 20dB bandwidth of hopping channel shall be a minimum limit for the hopping channel separation.

4.5.2 Test Setup

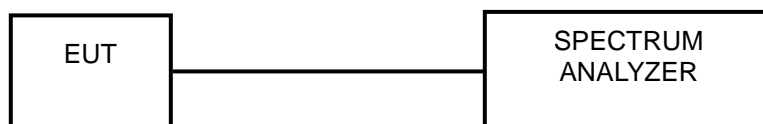

4.5.3 Test Instruments

Refer to section 4.3.3 to get information of above instrument.

4.5.4 Test Procedure

- Check the calibration of the measuring instrument using either an internal calibrator or a known signal from an external generator.
- Turn on the EUT and connect it to measurement instrument. Then set it to any one convenient frequency within its operating range. Set a reference level on the measuring instrument equal to the highest peak value.
- Measure the frequency difference of two frequencies that were attenuated 20dB from the reference level. Record the frequency difference as the emission bandwidth.
- Repeat above procedures until all frequencies measured were complete.

4.5.5 Deviation from Test Standard

No deviation.

4.5.6 EUT Operating Condition

The software provided by client enabled the EUT to transmit and receive data at lowest, middle and highest channel frequencies individually.

4.5.7 Test Results

Channel	Frequency (MHz)	20dB Bandwidth (MHz)		
		GFSK	$\pi/4$ DQPSK	8DPSK
0	2402	1.02	1.27	1.28
39	2441	0.95	1.27	1.27
78	2480	0.95	1.27 <td>1.28</td>	1.28

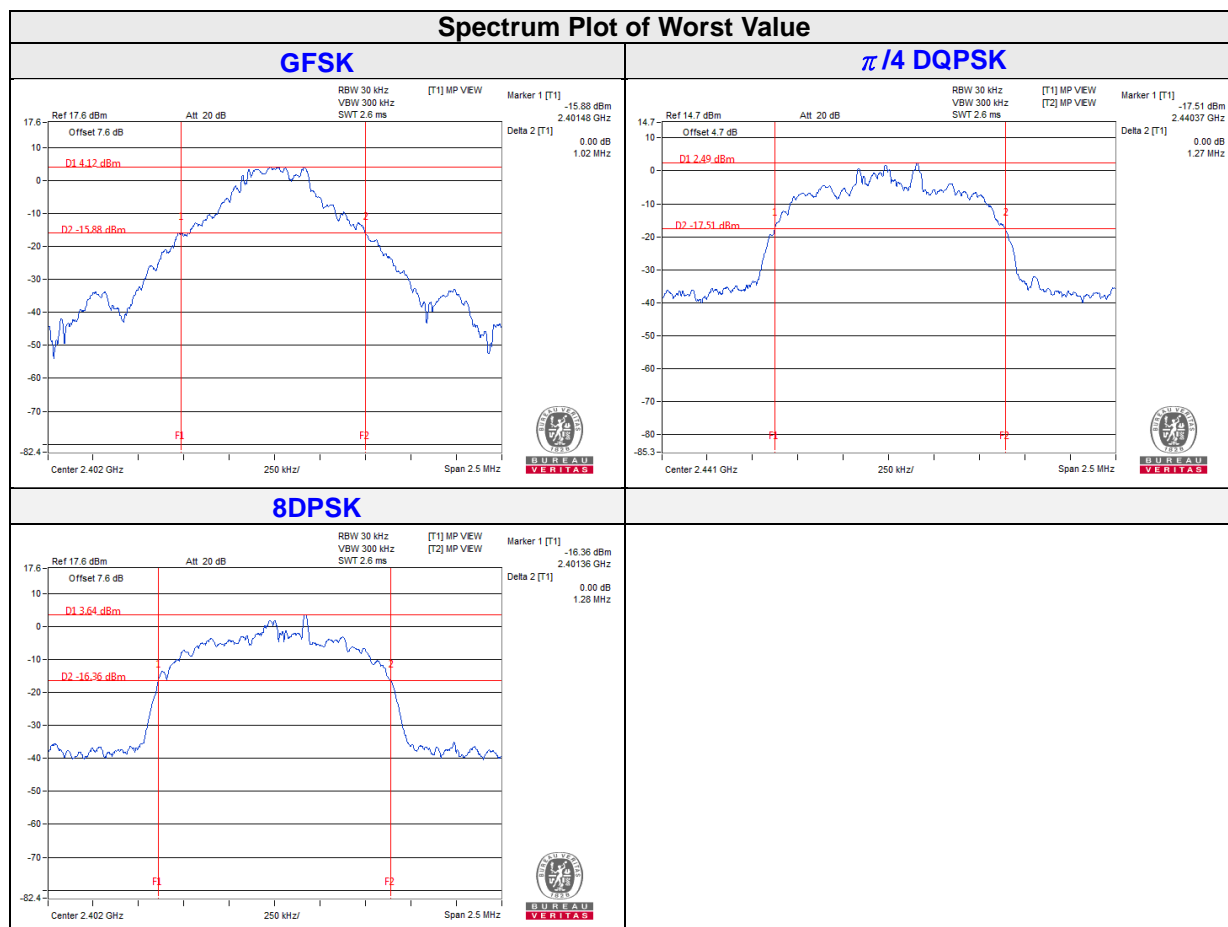

4.6 Hopping Channel Separation

4.6.1 Limits of Hopping Channel Separation Measurement

At least 25kHz or two-third of 20dB hopping channel bandwidth (whichever is greater).

4.6.2 Test Setup

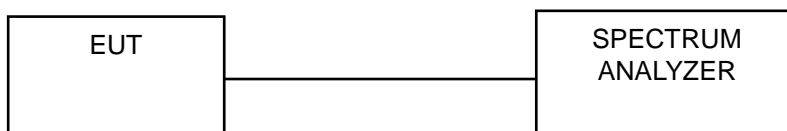

4.6.3 Test Instruments

Refer to section 4.3.3 to get information of above instrument.

4.6.4 Test Procedure

Measurement Procedure REF

- a. Check the calibration of the measuring instrument using either an internal calibrator or a known signal from an external generator.
- b. Turn on the EUT and connect it to measurement instrument. Then set it to any one convenient frequency within its operating range.
- c. By using the MaxHold function record the separation of two adjacent channels.
- d. Measure the frequency difference of these two adjacent channels by SA MARK function. And then plot the result on SA screen.
- e. Repeat above procedures until all frequencies measured were complete.

4.6.5 Deviation From Test Standard

No deviation.

4.6.6 Test Results

Channel	Frequency (MHz)	Adjacent Channel Separation (MHz)		20dB Bandwidth (MHz)		Minimum Limit (MHz)		Pass / Fail
		GFSK	8DPSK	GFSK	8DPSK	GFSK	8DPSK	
0	2402	1.00	1.01	1.02	1.28	0.68	0.85	Pass
39	2441	1.00	1.00	0.95	1.27	0.64	0.85	Pass
78	2480	1.00	1.00	0.95	1.28	0.63	0.85	Pass

NOTE: The minimum limit is two-third 20dB bandwidth.

GFSK

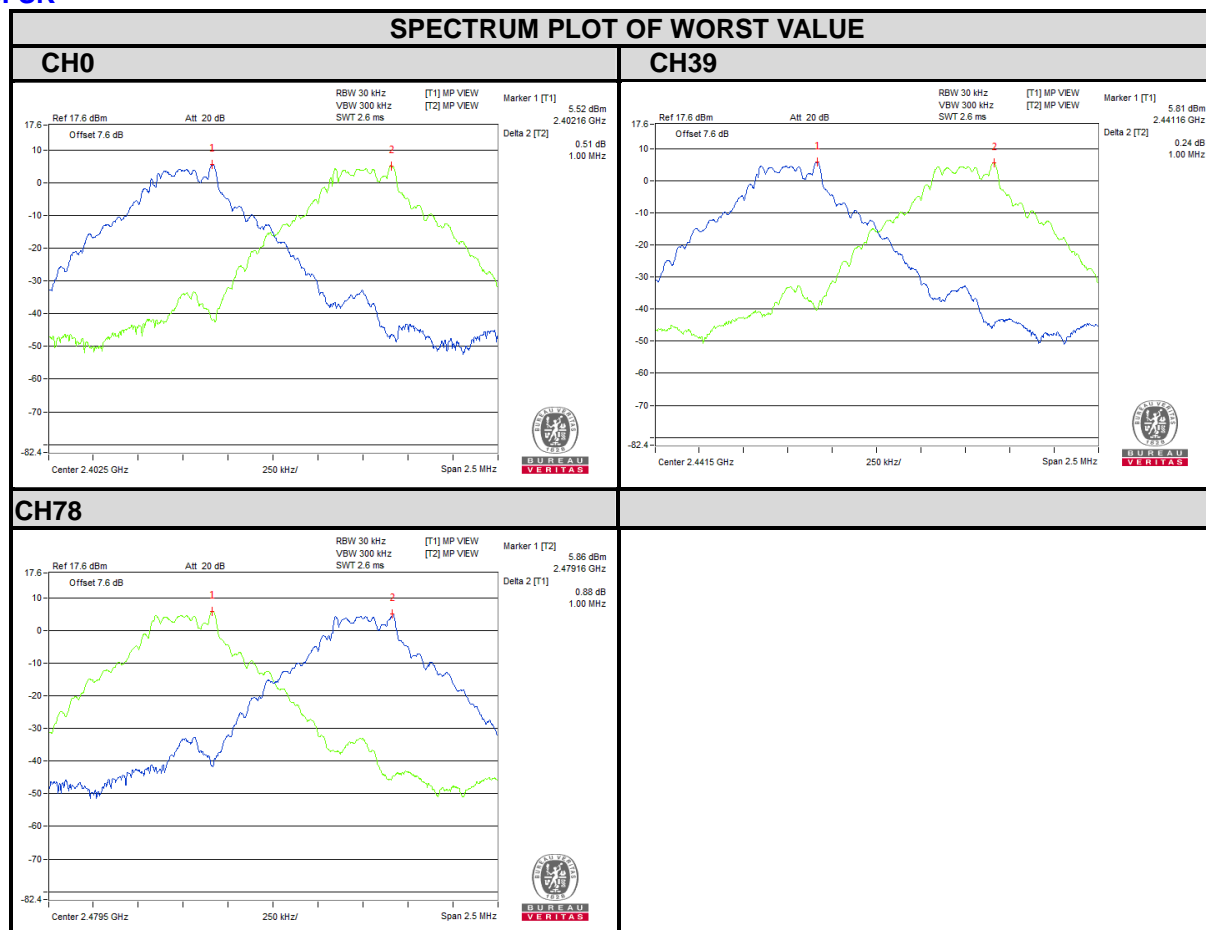

8DPSK

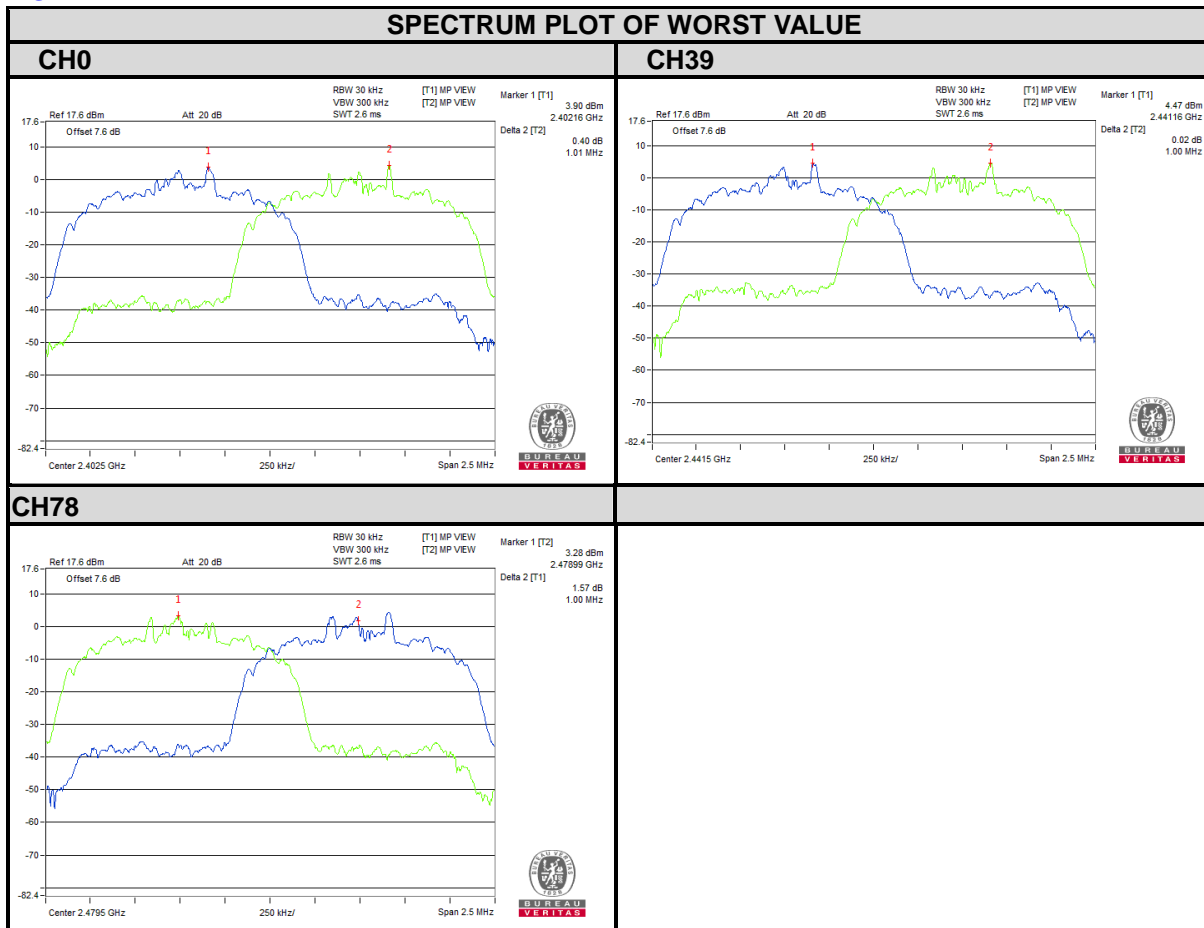

4.7 Maximum Output Power

4.7.1 Limits of Maximum Output Power Measurement

The Maximum Output Power Measurement is 125mW.

4.7.2 Test Setup

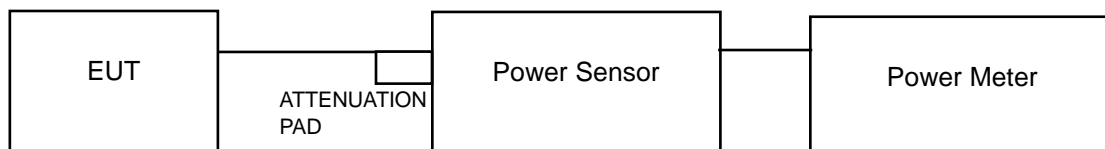

4.7.3 Test Instruments

Refer to section 4.3.3 to get information of above instrument.

4.7.4 Test Procedure

A peak / average power sensor was used on the output port of the EUT. A power meter was used to read the response of the peak / average power sensor. Record the power level.

4.7.5 Deviation from Test Standard

No deviation.

4.7.6 EUT Operating Condition

The software provided by client enabled the EUT to transmit and receive data at lowest, middle and highest channel frequencies individually.

4.7.7 Test Results

Channel	Frequency (MHZ)	Output Power (mW)			Output Power (dBm)			Power Limit (mW)	Pass / Fail
		GFSK	$\pi/4$ DQPSK	8DPSK	GFSK	$\pi/4$ DQPSK	8DPSK		
0	2402	3.532	2.606	2.630	5.48	4.16	4.20	125	Pass
39	2441	4.395	3.251	3.296	6.43	5.12	5.18	125	Pass
78	2480	3.597	2.624	2.667	5.56	4.19	4.26	125	Pass

4.8 Conducted Out of Band Emission Measurement

4.8.1 Limits Of Conducted Out Of Band Emission Measurement

Below -20dB of the highest emission level of operating band (in 100kHz RBW).

4.8.2 Test Instruments

Refer to section 4.3.3 to get information of above instrument.

4.8.3 Test Procedure

The transmitter output was connected to the spectrum analyzer via a low loss cable. of Spectrum Analyzer was set RBW to 100 kHz and VBW to 100 kHz with suitable frequency span including 100 MHz bandwidth from band edge. Detector = PEAK and Trace mode = Max Hold. The band edges was measured and recorded.

4.8.4 Deviation From Test Standard

No deviation.

4.8.5 Eut Operating Condition

The software provided by client enabled the EUT to transmit and receive data at lowest, middle and highest channel frequencies individually.

4.8.6 Test Results

The spectrum plots are attached on the following images. D1 line indicates the highest level, D2 line indicates the 20dB offset below D1. It shows compliance with the requirement.

GFSK

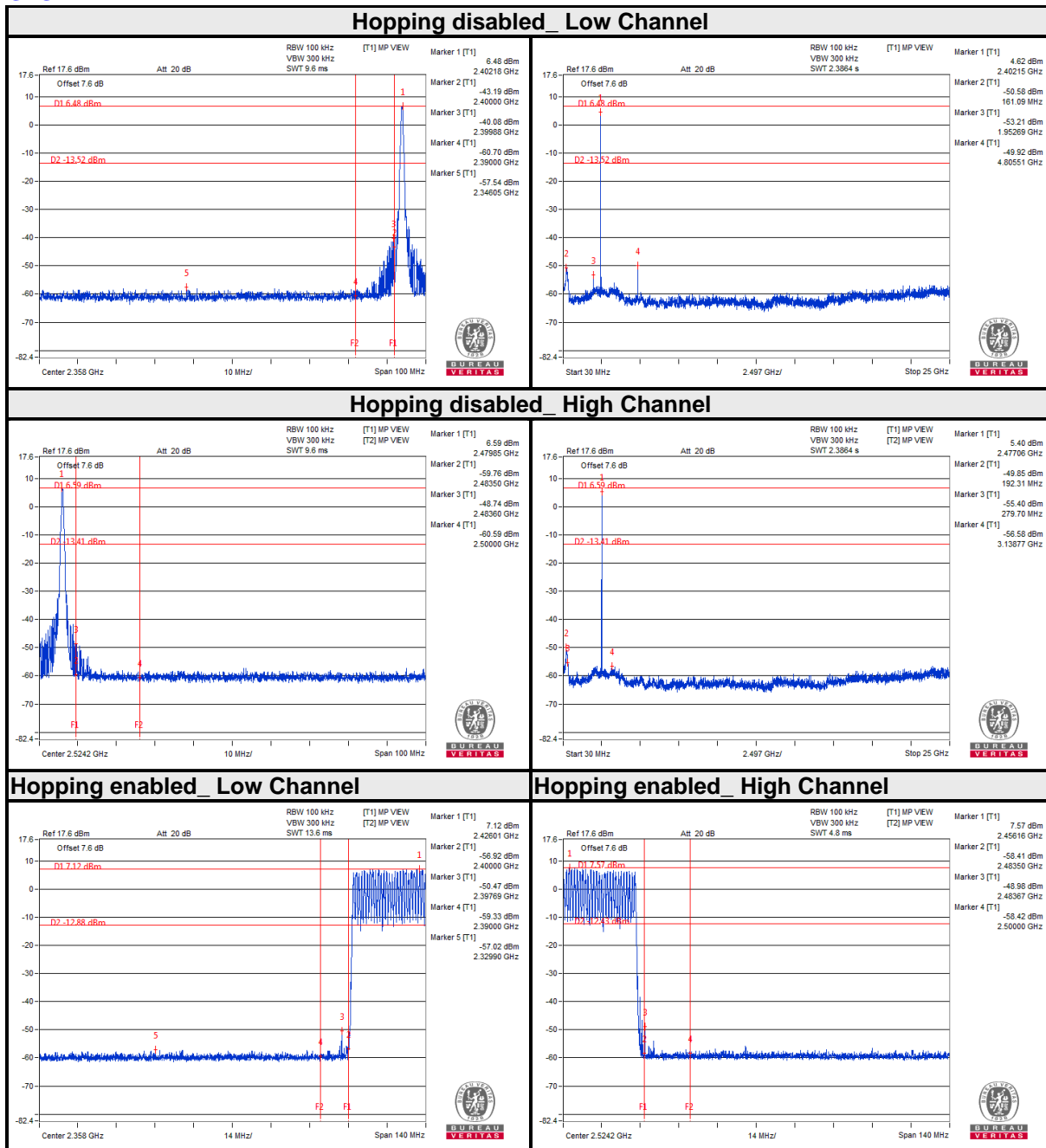

8DPSK

Hopping disabled_Low Channel

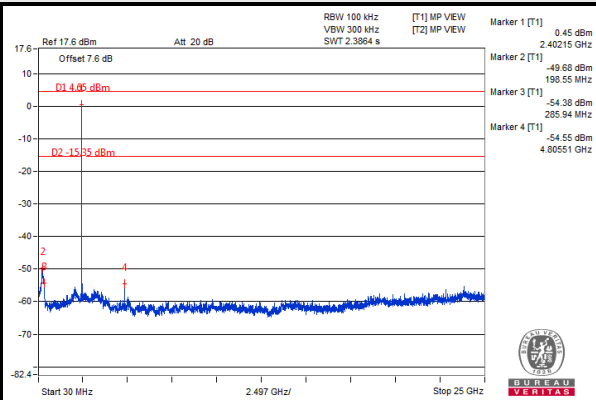
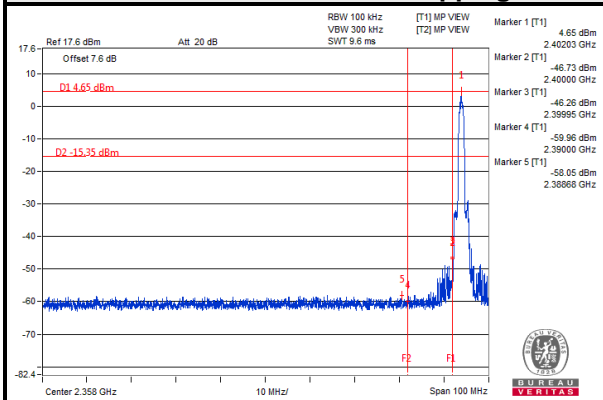

Hopping disabled_High Channel

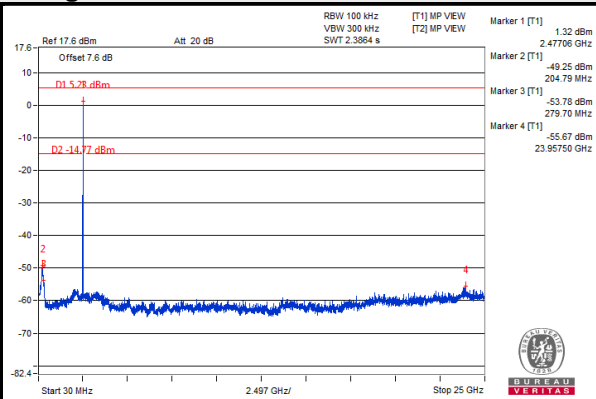
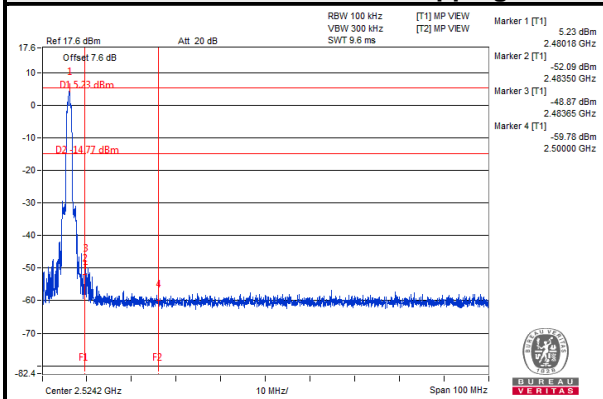

Hopping enabled_Low Channel

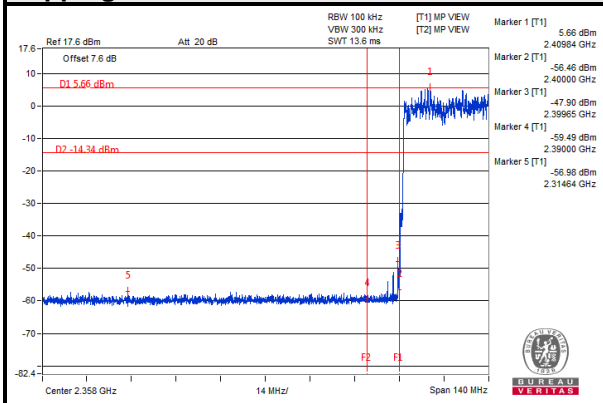

Hopping enabled_High Channel

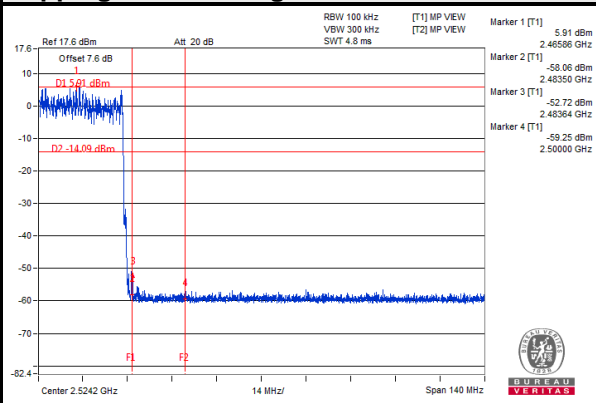

5 Pictures of Test Arrangements

Please refer to the attached file (Test Setup Photo).

Appendix – Information on the Testing Laboratories

We, Bureau Veritas Consumer Products Services (H.K.) Ltd., Taoyuan Branch, were founded in 1988 to provide our best service in EMC, Radio, Telecom and Safety consultation. Our laboratories are accredited and approved according to ISO/IEC 17025.

If you have any comments, please feel free to contact us at the following:

Linko EMC/RF Lab

Tel: 886-2-26052180

Fax: 886-2-26051924

Hsin Chu EMC/RF Lab/Telecom Lab

Tel: 886-3-5935343

Fax: 886-3-5935342

Hwa Ya EMC/RF/Safety

Tel: 886-3-3183232

Fax: 886-3-3270892

Email: service.adt@tw.bureauveritas.com

Web Site: www.bureauveritas-adt.com

The address and road map of all our labs can be found in our web site also.

--- END ---