

# FCC Test Report (PART 27)

**Report No.:** RF160512W002-5

**FCC ID:** YCNA2016B30

**Test Model:** Lenovo A2016b30

**Received Date:** May 18, 2016

**Test Date:** May 21, 2016 ~ Jun. 21, 2016

**Issued Date:** Jun. 23, 2016

**Applicant:** Lenovo Mobile Communication Technology Ltd.

**Address:** No.999, Qishan North 2nd Road, Information & Optoelectronics Park, Torch Hi-tech Industry Development Zone, Xiamen, P.R.China

**Issued By:** Bureau Veritas Consumer Products Services (H.K.) Ltd., Taoyuan Branch

**Lab Address:** No. 47-2, 14th Ling, Chia Cau Vil., Lin Kou Dist., New Taipei City, Taiwan (R.O.C.)

**Test Location:** No. 19, Hwa Ya 2nd Rd., Wen Hwa Tsuen, Kwei Shan Hsiang, Taoyuan Hsien 333, Taiwan, R.O.C.

This report should not be used by the client to claim product certification, approval, or endorsement by TAF or any government agencies.



This report is for your exclusive use. Any copying or replication of this report to or for any other person or entity, or use of our name or trademark, is permitted only with our prior written permission. This report sets forth our findings solely with respect to the test samples identified herein. The results set forth in this report are not indicative or representative of the quality or characteristics of the lot from which a test sample was taken or any similar or identical product specifically and expressly noted. Our report includes all of the tests requested by you and the results thereof based upon the information that you provided to us. You have 60 days from date of issuance of this report to notify us of any material error or omission caused by our negligence, provided, however, that such notice shall be in writing and shall specifically address the issue you wish to raise. A failure to raise such issue within the prescribed time shall constitute your unqualified acceptance of the completeness of this report, the tests conducted and the correctness of the report contents. Unless specific mention, the uncertainty of measurement has been explicitly taken into account to declare the compliance or non-compliance to the specification. The report must not be used by the client to claim product certification, approval, or endorsement by TAF or any government agency

**Table of Contents**

<b>RELEASE CONTROL RECORD .....</b>	<b>3</b>
<b>1 Certificate of Conformity.....</b>	<b>4</b>
<b>2 Summary of Test Results .....</b>	<b>5</b>
2.1 Measurement Uncertainty .....	5
2.2 Test Site And Instruments .....	6
<b>3 General Information.....</b>	<b>7</b>
3.1 General Description of EUT .....	7
3.2 Configuration of System Under Test .....	10
3.2.1 Description Of Support Units.....	10
3.3 Test Mode Applicability and Tested Channel Detail .....	11
3.4 EUT Operating Conditions .....	13
3.5 General Description of Applied Standards .....	13
<b>4 Test Types and Results .....</b>	<b>14</b>
4.1 Output Power Measurement .....	14
4.1.1 Limits of Output Power Measurement.....	14
4.1.2 Test Procedures.....	14
4.1.3 Test Setup.....	15
4.1.4 Test Results .....	16
4.2 Frequency Stability Measurement.....	26
4.2.1 Limits of Frequency Stabiliity Measurement.....	26
4.2.2 Test Procedure .....	26
4.2.3 Test Setup.....	26
4.2.4 Test Results .....	27
4.3 Occupied Bandwidth Measurement .....	28
4.3.1 Limits Of Occupied Bandwidth Measurement .....	28
4.3.2 Test Setup.....	28
4.3.3 Test Procedures.....	28
4.3.4 Test Result.....	29
4.4 Peak To Average Ratio.....	33
4.4.1 Limits of Peak To Average Ratio Measurement .....	33
4.4.2 Test Setup.....	33
4.4.3 Test Procedures.....	33
4.4.4 Test Results .....	34
4.5 Band Edge Measurement .....	38
4.5.1 Limits of Band Edge Measurement .....	38
4.5.2 Test Setup.....	38
4.5.3 Test Procedures.....	38
4.5.4 Test Results .....	39
4.6 Conducted Spurious Emissions .....	46
4.6.1 Limits of Conducted Spurious Emissions Measurement.....	46
4.6.2 Test Procedure .....	46
4.6.3 Test Setup.....	46
4.6.4 Test Results .....	47
4.7 Radiated Emission Measurement .....	49
4.7.1 Limits of Radiated Emission Measurement.....	49
4.7.2 Test Procedure .....	49
4.7.3 Deviation from Test Standard .....	49
4.7.4 Test Setup.....	50
4.7.5 Test Results .....	51
<b>5 Pictures of Test Arrangements.....</b>	<b>67</b>
<b>Appendix – Information on the Testing Laboratories .....</b>	<b>68</b>



A D T

### RELEASE CONTROL RECORD

Issue No.	Description	Date Issued
RF160512W002-5	Original release	Jun. 23, 2016

## 1 Certificate of Conformity

**Product:** Mobile Phone

**Brand:** Lenovo

**Test Model:** Lenovo A2016b30

**Sample Status:** Identical Prototype

**Applicant:** Lenovo Mobile Communication Technology Ltd.

**Test Date:** May 21, 2016 ~ Jun. 21, 2016

**Standards:** **FCC Part 27, Subpart C, L**  
**FCC Part 2**  
**ANSI/TIE/EIA-603-D**

The above equipment has been tested by **Bureau Veritas Consumer Products Services (H.K.) Ltd., Taoyuan Branch**, and found compliance with the requirement of the above standards. The test record, data evaluation & Equipment Under Test (EUT) configurations represented herein are true and accurate accounts of the measurements of the sample's EMC characteristics under the conditions specified in this report.

**Prepared by :** , **Date:** Jun. 23, 2016  
Amyee Qian / Engineer

**Approved by :** , **Date:** Jun. 23, 2016  
William Chung / Manager

## 2 Summary of Test Results

Applied Standard: FCC Part 27 & Part 2			
FCC Clause	Test Item	Result	Remarks
2.1046 27.50(d)(4)	Maximum Peak Output Power	PASS	Meet the requirement of limit.
2.1055 27.54	Frequency Stability	PASS	Meet the requirement of limit.
2.1049 27.53(h)	Occupied Bandwidth	PASS	Meet the requirement of limit.
27.50(d)(5)	Peak to average ratio	PASS	Meet the requirement of limit.
27.53(h)	Band Edge Measurements	PASS	Meet the requirement of limit.
2.1051 27.53(h)	Conducted Spurious Emissions	PASS	Meet the requirement of limit.
2.1053 27.53(h)	Radiated Spurious Emissions	PASS	Meet the requirement of limit. Minimum passing margin is -16.55dB at 43.58MHz.

### 2.1 Measurement Uncertainty

Where relevant, the following measurement uncertainty levels have been estimated for tests performed on the EUT as specified in CISPR 16-4-2:

Measurement	Frequency	Expanded Uncertainty (k=2) (±)
Conducted Emissions at mains ports	150kHz ~ 30MHz	2.44 dB
Radiated Emissions up to 1 GHz	30MHz ~ 200MHz	2.93 dB
	200MHz ~ 1000MHz	2.95 dB
Radiated Emissions above 1 GHz	1GHz ~ 18GHz	2.26 dB
	18GHz ~ 40GHz	1.94 dB

This uncertainty represents an expanded uncertainty expressed at approximately the 95% confidence level using a coverage factor of k=2.

## 2.2 Test Site And Instruments

Equipment	Manufacturer	Model No.	Serial No.	Last Cal.	Next Cal.
EMI Test Receiver	Rohde&Schwarz	ESR7	101494	Apr. 05,16	Apr. 04,17
Signal and Spectrum Analyzer	Rohde&Schwarz	FSV40	101094	Apr. 05,16	Apr. 04,17
Bilog Antenna 1	Teseq	CBL 6111D	30643	Jun. 25,15	Jun. 24,16
Bilog Antenna 2	Teseq	CBL 6111D	27089	Jun. 25,15	Jun. 24,16
Horn Antenna	ETS-Lindgren	3117	00062558	May 30,14	May 29,17
Horn Antenna (15GHz-40GHz)	SCHWARZBECK	BBHA 9170	BBHA9170147	Jan. 21,14	Jan. 20,17
Amplifier	Burgeon	BPA-530	100220	Apr. 05,16	Apr. 04,17
Pre-Amplifier	HP	8449B	3008A00409	Apr. 24,16	Apr. 23,17
Pre-Amplifier (18GHz-40GHz)	EMCI	EMC 184045	980102	Nov. 11,15	Nov. 10,16
GPS Generator+ Antenna	TOJOIN	GNSS-5000A	E1-010119	Aug. 08, 14	Aug. 07, 16
3m Semi-anechoic Chamber	ETS-LINDGREN	9m*6m*6m	NSEMC003	Mar. 12,16	Mar. 11,18
Test Software	ADT	ADT_Radiated_V7.6.15.9.2	N/A	N/A	N/A
Power Meter	Anritsu	ML2495A	1139001	Feb.19,16	Feb. 18,17
Power Sensor	Anritsu	MA2411B	1126068	Feb.19,16	Feb. 18,17
Power Sensor	Keysight	U2021XA	MY55060016	May 27,15	May 26,17
Power Sensor	Keysight	U2021XA	MY55060018	May 27,15	May 26,17
Digital Multimeter	FLUKE	15B	A1220010DG	Oct. 12, 15	Oct. 11, 16
Humid & Temp Programmable Tester	Haida	HD-2257	110807201	Sep.07,15	Sep. 06,16
Oscilloscope	Agilent	DSO9254A	MY51260160	Nov. 09,15	Nov. 08,16
Signal Analyzer	Rohde & Schwarz	FSV7	102331	Nov. 09,15	Nov. 08,16
Signal Generator	Agilent	N5183A	MY50140980	Apr. 21, 16	Apr. 20, 17
ESG Vector Signal Generator	Agilent	E4438C	MY49072505	Sep. 01,15	Aug. 31,16
BLUETOOTH TESTER	Rohde&Schwarz	CBT32	100811	Oct. 12, 15	Oct. 11, 16

**NOTE:** 1. The calibration interval of the above test instruments is 12 months and the calibrations are traceable to NML/ROC and NIST/USA.

2. The calibration interval of the loop antenna is 24 months and the calibrations are traceable to NML/ROC and NIST/USA.

3. The test was performed in HwaYa Chamber 4.

4. The horn antenna and HP preamplifier (model: 8449B) are used only for the measurement of emission frequency above 1GHz if tested.

5. The FCC Site Registration No. is 460141.

6. The IC Site Registration No. is IC7450F-4.

### 3 General Information

#### 3.1 General Description of EUT

<b>PRODUCT</b>	Mobile Phone	
<b>BRAND</b>	Lenovo	
<b>MODEL NAME</b>	Lenovo A2016b30	
<b>POWER SUPPLY</b>	5.0Vdc (adapter or host equipment) 3.8Vdc (battery)	
<b>MODULATION TECHNOLOGY</b>	<b>WCDMA</b>	BPSK
	<b>LTE Band 4</b>	QPSK, 16QAM
<b>FREQUENCY RANGE</b>	<b>WCDMA</b>	1712.4MHz ~ 1752.6MHz
	<b>LTE Band 4 Channel Bandwidth: 1.4MHz</b>	1710.7MHz ~ 1754.3MHz
	<b>LTE Band 4 Channel Bandwidth: 3MHz</b>	1711.5MHz ~ 1753.5MHz
	<b>LTE Band 4 Channel Bandwidth: 5MHz</b>	1712.5MHz ~ 1752.5MHz
	<b>LTE Band 4 Channel Bandwidth: 10MHz</b>	1715.0MHz ~ 1750.0MHz
	<b>LTE Band 4 Channel Bandwidth: 15MHz</b>	1717.5MHz ~ 1747.5MHz
	<b>LTE Band 4 Channel Bandwidth: 20MHz</b>	1720.0MHz ~ 1745.0MHz
	<b>EMISSION DESIGNATOR</b>	<b>WCDMA</b>
<b>LTE Band 4 Channel Bandwidth: 1.4MHz</b>		QPSK: 1M09G7D
		16QAM: 1M09W7D
<b>LTE Band 4 Channel Bandwidth: 3MHz</b>		QPSK: 2M69G7D
		16QAM: 2M68W7D
<b>LTE Band 4 Channel Bandwidth: 5MHz</b>		QPSK: 4M49G7D
		16QAM: 4M49W7D
<b>LTE Band 4 Channel Bandwidth: 10MHz</b>		QPSK: 8M95G7D
	16QAM: 8M95W7D	
<b>LTE Band 4 Channel Bandwidth: 15MHz</b>	QPSK: 13M4G7D	
	16QAM: 13M4W7D	
<b>LTE Band 4 Channel Bandwidth: 20MHz</b>	QPSK: 17M9G7D	
	16QAM: 17M9W7D	
<b>MAX. ERP/EIRP POWER</b>	<b>WCDMA</b>	299mW
	<b>LTE Band 4 Channel Bandwidth: 1.4MHz</b>	266mW
	<b>LTE Band 4 Channel Bandwidth: 3MHz</b>	272mW
	<b>LTE Band 4 Channel Bandwidth: 5MHz</b>	282mW
	<b>LTE Band 4 Channel Bandwidth: 10MHz</b>	296mW

	<b>LTE Band 4 Channel Bandwidth: 15MHz</b>	278mW
	<b>LTE Band 4 Channel Bandwidth: 20MHz</b>	234mW
<b>ANTENNA TYPE</b>	Fixed External antenna with -1.71dBi for WCDMA B4 Fixed Internal antenna with -1.39dBi for LTE B4	
<b>HW VERSION</b>	AL732_MB_PCB_V2.0	
<b>SW VERSION</b>	A2016b30_ENG_S109_1606011240_MP3V1_8G_LATAM	
<b>ACCESSORY DEVICE</b>	Refer to note as below	
<b>DATA CABLE</b>	USB cable: non-shielded, detachable, 0.7m Earphone: non-shielded, detachable, 1.3m	

Note:

1. The above EUT information is declared by manufacturer and for more detailed features description, please refer to the manufacturer's specifications or User's Manual.
2. There were Sample A and Sample B for this project, the difference is the coulor and configuration, as below:

<b>SAMPLE</b>	<b>EUT CONFIGURATION INFORMATION</b>
<b>A (Black)</b>	LCD panel 1+ Photo Camera 1+ Video Camera 1+ Main Broad 1
<b>B (White)</b>	LCD panel 2+ Photo Camera 2+ Video Camera 2+ Main Broad 2

3. For the test results, the EUT had been tested with all conditions. But only the worst case was shown in test report.



**LIST OF ACCESSORIES:**

ACCESSORIES	BRAND	MANUFACTURER	MODEL	SPECIFICATION
AC Adapter 1	Lenovo	CHENYANG	C-P56	I/P:100-240Vac, 130mA O/P:5.0Vdc, 1000mA
AC Adapter 2	Lenovo	Acbel	C-P56	I/P:100-240Vac, 130mA O/P:5.0Vdc, 1000mA
Battery 1	Lenovo	ATL	BL253	Rating: 3.8Vdc, 2000mAh
Battery 2	Lenovo	VK	BL253	Rating: 3.8Vdc, 2000mAh
USB Cable 1	Lenovo	FUKANGYUAN	F16W-05100070L	0.7m non-shielded cable w/o core
USB Cable 2	Lenovo	LIQI	L16W-05100070L	0.7m non-shielded cable w/o core
Earphone 1	Lenovo	TIANZHI	TJ101247A	1.3m non-shielded cable w/o core
Earphone 2	Lenovo	LIANYUN	TS990B-28AMS05-M	1.3m non-shielded cable w/o core
LCD Panel 1	HELITAI	--	QTB4D543	--
LCD Panel 1	TONGXINGDA	--	TXDT450SKP-73V6	--
Photo Camera 1	BOLIXIN	--	BLX2355H-AL732-F	--
Photo Camera 2	HUAQUAN	--	G6P2-AL732FHQ	--
Video Camera 1	QUNHUI	--	SHT6029B1S-1P0J0	--
Video Camera 2	HUAQUAN	--	G7B5-AL732BHQ	--
Main Broad 1	HUASHEN	--	AL732_MB_PCB_V2.0	--
Main Broad 2	YILIANDA	--	AL732_MB_PCB_V2.0	--
BT/WLAN Module	MTK	--	MT6625L	--
WWAN Module	N/A	--	N/A	--

### 3.2 Configuration of System Under Test

#### FOR RADIATION EMISSION TEST

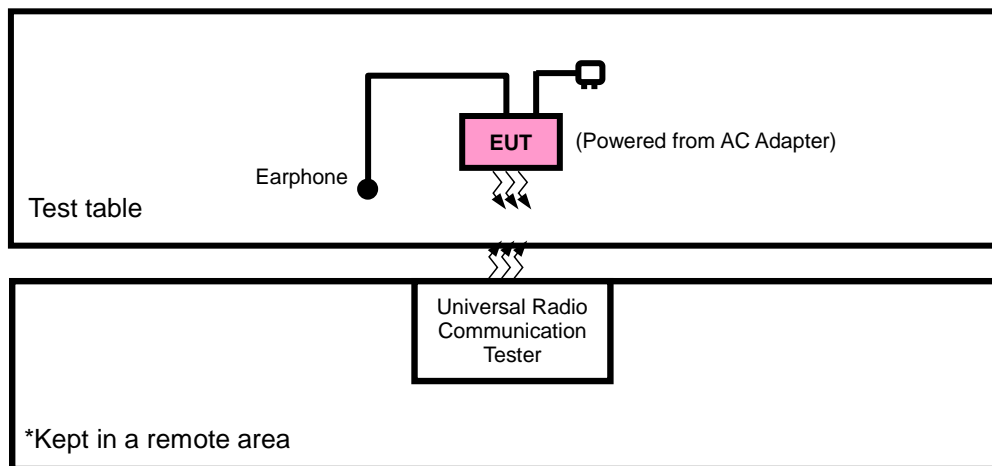

#### FOR E.R.P./E.I.R.P TEST

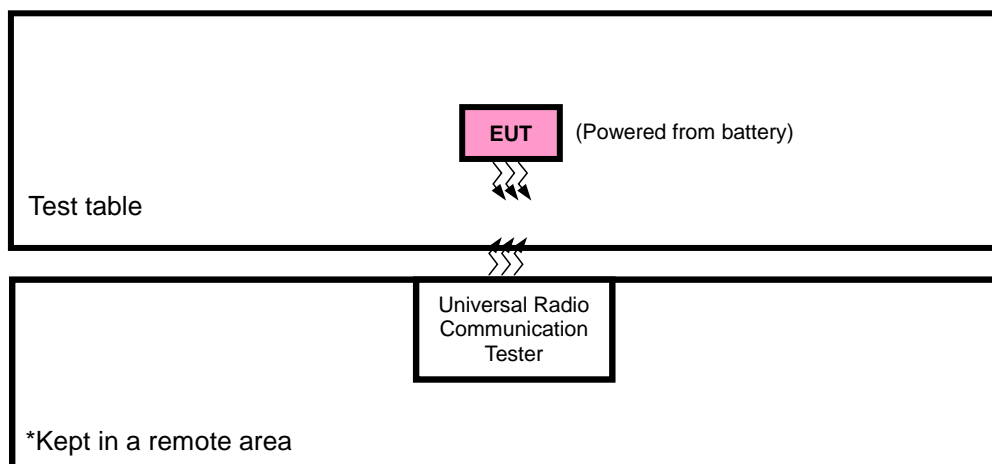

#### 3.2.1 Description Of Support Units

The EUT has been tested as an independent unit together with other necessary accessories or support units. The following support units or accessories were used to form a representative test configuration during the tests.

NO.	PRODUCT	BRAND	MODEL NO.	SERIAL NO.	FCC ID
1	DC source	LONG WEI	PS-6403D	010934269	N/A
2	PC	HP	A6608CN	3CR83825X3	N/A

NO.	SIGNAL CABLE DESCRIPTION OF THE ABOVE SUPPORT UNITS
1	DC Line: Unshielded, Detachable 1.0m
2	AC Line: Unshielded, Detachable 1.5m

**NOTE:**

1. All power cords of the above support units are non shielded (1.8m).

### 3.3 Test Mode Applicability and Tested Channel Detail

Pre-Scan has been conducted to determine the worst-case mode from all possible combinations between available modulations, data rates, XYZ axis and antenna ports  
 The worst case was found when positioned on X-plane. Following channel(s) was (were) selected for the final test as listed below:

EUT CONFIGURE MODE	DESCRIPTION
A	EUT + Adapter + USB Cable with LTE link
B	EUT + Battery + USB Cable with LTE link

#### WCDMA MODE

EUT Configure Mode	Test Item	Available Channel	Tested Channel	Mode
A	EIRP	1312 to 1513	1312, 1413, 1513	WCDMA
B	Frequency Stability	1312 to 1513	1413	WCDMA
A	Occupied Bandwidth	1312 to 1513	1312, 1413, 1513	WCDMA
A	Band Edge	1312 to 1513	1312, 1513	WCDMA
A	Peak To Average Ratio	1312 to 1513	1312, 1413, 1513	WCDMA
A	Condcudeted Emission	1312 to 1513	1312, 1413, 1513	WCDMA
A	Radiated Emission Below 1GHz	1312 to 1513	1312	WCDMA
A	Radiated Emission Above 1GHz	1312 to 1513	1312, 1413, 1513	WCDMA

**LTE BAND 4**

EUT CONFIGURE MODE	TEST ITEM	AVAILABLE CHANNEL	TESTED CHANNEL	CHANNEL BANDWIDTH	MODULATION	MODE		
B	EIRP	19957 to 20393	19957, 20175, 20393	1.4MHz	QPSK, 16QAM	1 RB / 0 RB Offset		
		19965 to 20385	19965, 20175, 20385	3MHz	QPSK, 16QAM	1 RB / 0 RB Offset		
		19975 to 20375	19975, 20175, 20375	5MHz	QPSK, 16QAM	1 RB / 0 RB Offset		
		20000 to 20350	20000, 20175, 20350	10MHz	QPSK, 16QAM	1 RB / 0 RB Offset		
		20025 to 20325	20025, 20175, 20325	15MHz	QPSK, 16QAM	1 RB / 0 RB Offset		
		20050 to 20300	20050, 20175, 20300	20MHz	QPSK, 16QAM	1 RB / 0 RB Offset		
B	FREQUENCY STABILITY	19957 to 20393	20175	1.4MHz	QPSK	1 RB / 0 RB Offset		
		19965 to 20385	20175	3MHz	QPSK	1 RB / 0 RB Offset		
		19975 to 20375	20175	5MHz	QPSK	1 RB / 0 RB Offset		
		20000 to 20350	20175	10MHz	QPSK	1 RB / 0 RB Offset		
		20025 to 20325	20175	15MHz	QPSK	1 RB / 0 RB Offset		
		20050 to 20300	20175	20MHz	QPSK	1 RB / 0 RB Offset		
B	OCCUPIED BANDWIDTH	19957 to 20393	19957, 20175, 20393	1.4MHz	QPSK, 16QAM	6 RB / 0 RB Offset		
		19965 to 20385	19965, 20175, 20385	3MHz	QPSK, 16QAM	15 RB / 0 RB Offset		
		19975 to 20375	19975, 20175, 20375	5MHz	QPSK, 16QAM	25 RB / 0 RB Offset		
		20000 to 20350	20000, 20175, 20350	10MHz	QPSK, 16QAM	50 RB / 0 RB Offset		
		20025 to 20325	20025, 20175, 20325	15MHz	QPSK, 16QAM	75 RB / 0 RB Offset		
		20050 to 20300	20050, 20175, 20300	20MHz	QPSK, 16QAM	100 RB / 0 RB Offset		
B	PEAK TO AVERAGE RATIO	19957 to 20393	19957, 20175, 20393	1.4MHz	QPSK, 16QAM	1 RB / 0 RB Offset		
		19965 to 20385	19965, 20175, 20385	3MHz	QPSK, 16QAM	1 RB / 0 RB Offset		
		19975 to 20375	19975, 20175, 20375	5MHz	QPSK, 16QAM	1 RB / 0 RB Offset		
		20000 to 20350	20000, 20175, 20350	10MHz	QPSK, 16QAM	1 RB / 0 RB Offset		
		20025 to 20325	20025, 20175, 20325	15MHz	QPSK, 16QAM	1 RB / 0 RB Offset		
		20050 to 20300	20050, 20175, 20300	20MHz	QPSK, 16QAM	1 RB / 0 RB Offset		
B	BAND EDGE	19957 to 20393	19957	1.4MHz	QPSK	1 RB / 0 RB Offset 6 RB / 0 RB Offset		
			20393	1.4MHz	QPSK	1 RB / 5 RB Offset 6 RB / 0 RB Offset		
		19965 to 20385	19965	3MHz	QPSK	1 RB / 0 RB Offset 15 RB / 0 RB Offset		
			20385	3MHz	QPSK	1 RB / 14 RB Offset 15 RB / 0 RB Offset		
		19975 to 20375	19975	5MHz	QPSK	1 RB / 0 RB Offset 25 RB / 0 RB Offset		
			20375	5MHz	QPSK	1 RB / 24 RB Offset 25 RB / 0 RB Offset		
		20000 to 20350	20000	10MHz	QPSK	1 RB / 0 RB Offset 50 RB / 0 RB Offset		
			20350	10MHz	QPSK	1 RB / 49 RB Offset 50 RB / 0 RB Offset		
		B	BAND EDGE	20025 to 20325	20025	15MHz	QPSK	1 RB / 0 RB Offset 75 RB / 0 RB Offset
					20325	15MHz	QPSK	1 RB / 74 RB Offset 75 RB / 0 RB Offset
				20050 to 20300	20050	20MHz	QPSK	1 RB / 0 RB Offset 100 RB / 0 RB Offset
					20300	20MHz	QPSK	1 RB / 99 RB Offset

						100 RB / 0 RB Offset
B	CONDCUDED EMISSION	19957 to 20393	20175	1.4MHz	QPSK	1 RB / 0 RB Offset
		19965 to 20385	20175	3MHz	QPSK	1 RB / 0 RB Offset
		19975 to 20375	20175	5MHz	QPSK	1 RB / 0 RB Offset
		20000 to 20350	20175	10MHz	QPSK	1 RB / 0 RB Offset
		20025 to 20325	20175	15MHz	QPSK	1 RB / 0 RB Offset
		20050 to 20300	20175	20MHz	QPSK	1 RB / 0 RB Offset
A	RADIATED EMISSION	19957 to 20393	20175	1.4MHz	QPSK	1 RB / 0 RB Offset
		19965 to 20385	20175	3MHz	QPSK	1 RB / 0 RB Offset
		19975 to 20375	20175	5MHz	QPSK	1 RB / 0 RB Offset
		20000 to 20350	20175	10MHz	QPSK	1 RB / 0 RB Offset
		20025 to 20325	20175	15MHz	QPSK	1 RB / 0 RB Offset
		20050 to 20300	20175	20MHz	QPSK	1 RB / 0 RB Offset

**Note:** This device was tested under all bandwidths, RB configurations and modulations. The worst case was found in QPSK modulation.

#### **Test Condition:**

Test Item	Environmental Conditions	Input Power	Tested By
ERP	21deg. C, 71%RH 22deg. C, 71%RH	DC 3.8V from battery	Yuqiang Yin
Frequency Stability	24deg. C, 64%RH	DC 3.8V from battery	Yuqiang Yin
Occupied Bandwidth	24deg. C, 64%RH	DC 3.8V from battery	Yuqiang Yin
Band Edge	24deg. C, 64%RH	DC 3.8V from battery	Yuqiang Yin
Condcudeted Emission	24deg. C, 64%RH	DC 3.8V from battery	Yuqiang Yin
Radiated Emission	21deg. C, 71%RH	5Vdc from adapter	Alex Chen

### **3.4 EUT Operating Conditions**

The EUT makes a call to the communication simulator. The communication simulator station system controlled a EUT to export maximum output power under transmission mode and specific channel frequency

### **3.5 General Description of Applied Standards**

The EUT is a RF Product. According to the specifications of the manufacturer, it must comply with the requirements of the following standards:

**FCC 47 CFR Part 2**

**FCC 47 CFR Part 27**

**KDB Publication 971168 D02**

**ANSI/TIA/EIA-603-D**

**NOTE:** All test items have been performed and recorded as per the above standards.

## 4 Test Types and Results

### 4.1 Output Power Measurement

#### 4.1.1 Limits of Output Power Measurement

Fixed, mobile, and portable (hand-held) stations operating in the 1710–1755 MHz band are limited to 1 watt EIRP.

#### 4.1.2 Test Procedures

EIRP / ERP Measurement:

- a. All measurements were done at low, middle and high operational frequency range. RBW and VBW is 5MHz for WCDMA mode, and 10MHz for LTE mode.
- b. E.I.R.P power measurement. In the semi-anechoic chamber, EUT placed on the 0.8m height of Turn Table, rotated the table around 360 degrees to search the maximum radiation power and receiver antenna shall be rotated vertical and horizontal polarization and moved height from 1m to 4m to find the maximum polar radiated power. The “Read Value” is the spectrum reading the maximum power value.
- c. The substitution horn antenna is substituted for EUT at the same position and signals generator export the CW signal to the substitution antenna via a TX cable. Rotated the Turn Table and moved receiving antenna to find the maximum radiation power. Adjust output power level of S.G to get a Value of spectrum reading equal to “Read Value” of step a. Record the power level of S.G
- d.  $EIRP = \text{Output power level of S.G} - \text{TX cable loss} + \text{Antenna gain of substitution horn}$
- e.  $E.R.P = E.I.R.P - 2.15 \text{ dB}$

Conducted Power Measurement:

- a. The EUT was set up for the maximum power with WCDMA & LTE link data modulation and link up with simulator.
- b. Set the EUT to transmit under low, middle and high channel and record the power level shown on simulator.

4.1.3 Test Setup  
EIRP / ERP MEASUREMENT:

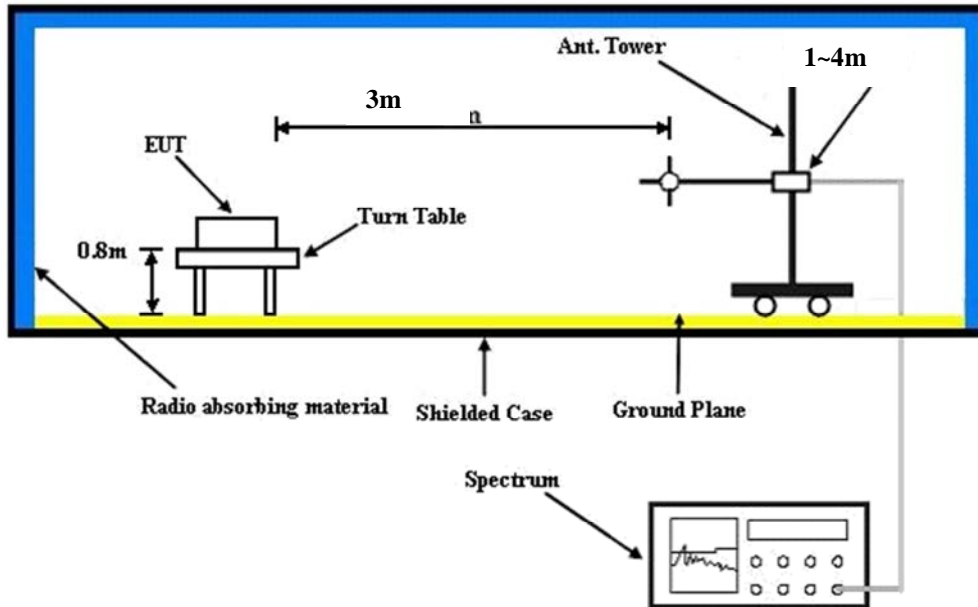

For the actual test configuration, please refer to the attached file (Test Setup Photo).

CONDUCTED POWER MEASUREMENT:



For the actual test configuration, please refer to the attached file (Test Setup Photo).

#### 4.1.4 Test Results

#### **AVERAGE CONDUCTED OUTPUT POWER (dBm)**

<b>Band</b>	<b>WCDMA IV</b>		
<b>Channel</b>	<b>1312</b>	<b>1413</b>	<b>1513</b>
<b>Frequency (MHz)</b>	<b>1712.4</b>	<b>1732.6</b>	<b>1752.6</b>
<b>RMC 12.2K</b>	22.33	22.30	<b>22.42</b>
<b>HSPA</b>			
<b>HSDPA Subtest-1</b>	21.48	21.36	21.47
<b>HSDPA Subtest-2</b>	21.47	21.34	21.46
<b>HSDPA Subtest-3</b>	20.98	20.86	21.02
<b>HSDPA Subtest-4</b>	20.97	20.84	21.00
<b>HSUPA Subtest-1</b>	19.46	19.42	19.52
<b>HSUPA Subtest-2</b>	19.37	19.33	19.48
<b>HSUPA Subtest-3</b>	20.39	20.34	20.47
<b>HSUPA Subtest-4</b>	19.88	19.83	19.93
<b>HSUPA Subtest-5</b>	21.40	21.32	21.42



LTE Band 4							
BW	Modulation	RB Size	RB Offset	Low CH 19957	Mid CH 20175	High CH 20393	MPR
				Frequency 1710.7 MHz	Frequency 1732.5 MHz	Frequency 1754.3 MHz	
1.4MHz	QPSK	1	0	23.16	23.10	23.02	0
		1	2	22.85	22.89	22.78	0
		1	5	22.85	22.89	22.66	0
		3	0	23.14	23.08	23.00	0
		3	1	22.83	22.87	22.76	0
		3	3	22.83	22.87	22.64	0
	16QAM	6	0	21.98	21.88	21.89	1
		1	0	22.21	22.31	22.30	1
		1	2	22.14	22.17	22.01	1
		1	5	22.13	22.16	21.90	1
		3	0	22.20	22.30	22.29	1
		3	1	22.13	22.16	22.00	1
		3	3	22.12	22.15	21.89	1
		6	0	20.94	20.93	20.83	2
LTE Band 4							
BW	Modulation	RB Size	RB Offset	Low CH 19965	Mid CH 20175	High CH 20385	MPR
				Frequency 1711.5 MHz	Frequency 1732.5 MHz	Frequency 1753.5 MHz	
3 MHz	QPSK	1	0	23.17	23.11	23.03	0
		1	7	22.86	22.90	22.79	0
		1	14	22.86	22.90	22.67	0
		8	0	22.08	22.06	22.02	1
		8	3	21.97	21.94	21.89	1
		8	7	21.95	21.96	21.78	1
		15	0	21.99	21.89	21.90	1
	16QAM	1	0	22.22	22.32	22.31	1
		1	7	22.15	22.18	22.02	1
		1	14	22.14	22.17	21.91	1
		8	0	21.01	21.01	20.96	2
		8	3	20.91	20.91	20.84	2
		8	7	20.88	20.90	20.71	2
		15	0	20.95	20.94	20.84	2
BW	Modulation	RB Size	RB Offset	Low CH 19975	Mid CH 20175	High CH 20375	MPR

				Frequency 1712.5 MHz	Frequency 1732.5 MHz	Frequency 1752.5 MHz	
<b>5 MHz</b>	<b>QPSK</b>	1	0	23.20	23.14	23.06	0
		1	12	22.89	22.93	22.82	0
		1	24	22.89	22.93	22.70	0
		12	0	22.11	22.09	22.05	1
		12	6	22.00	21.97	21.92	1
		12	13	21.98	21.99	21.81	1
		25	0	22.02	21.92	21.93	1
	<b>16QAM</b>	1	0	22.25	22.35	22.34	1
		1	12	22.18	22.21	22.05	1
		1	24	22.17	22.20	21.94	1
		12	0	21.04	21.04	20.99	2
		12	6	20.94	20.94	20.87	2
		12	13	20.91	20.93	20.74	2
		25	0	20.98	20.97	20.87	2

LTE Band 4							
BW	Modulation	RB Size	RB Offset	Low CH 20000	Mid CH 20175	High CH 20350	MPR
				Frequency 1715 MHz	Frequency 1732.5 MHz	Frequency 1750 MHz	
10 MHz	QPSK	1	0	23.24	23.18	23.10	0
		1	24	22.93	22.97	22.86	0
		1	49	22.93	22.97	22.74	0
		25	0	22.15	22.13	22.09	1
		25	12	22.04	22.01	21.96	1
		25	25	22.02	22.03	21.85	1
		50	0	22.06	21.96	21.97	1
	16QAM	1	0	22.29	22.39	22.38	1
		1	24	22.22	22.25	22.09	1
		1	49	22.21	22.24	21.98	1
		25	0	21.08	21.08	21.03	2
		25	12	20.98	20.98	20.91	2
		25	25	20.95	20.97	20.78	2
		50	0	21.02	21.01	20.91	2
BW	Modulation	RB Size	RB Offset	Low CH 20025	Mid CH 20175	High CH 20325	MPR
				Frequency 1717.5 MHz	Frequency 1732.5 MHz	Frequency 1747.5 MHz	
15 MHz	QPSK	1	0	23.30	23.24	23.16	0
		1	37	22.99	23.03	22.92	0
		1	74	22.99	23.03	22.80	0
		36	0	22.21	22.19	22.15	1
		36	19	22.10	22.07	22.02	1
		36	39	22.08	22.09	21.91	1
		75	0	22.12	22.02	22.03	1
	16QAM	1	0	22.35	22.45	22.44	1
		1	37	22.28	22.31	22.15	1
		1	74	22.27	22.30	22.04	1
		36	0	21.14	21.14	21.09	2
		36	19	21.04	21.04	20.97	2
		36	39	21.01	21.03	20.84	2
		75	0	21.08	21.07	20.97	2

LTE Band 4

BW	Modulation	RB Size	RB Offset	Low CH 20050	Mid CH 20175	High CH 20300	MPR
				Frequency 1720 MHz	Frequency 1732.5 MHz	Frequency 1745 MHz	
20MHz	QPSK	1	0	<b>23.33</b>	23.27	23.19	0
		1	50	23.02	23.06	22.95	0
		1	99	23.02	23.06	22.83	0
		50	0	22.24	22.22	22.18	1
		50	25	22.13	22.10	22.05	1
		50	50	22.11	22.12	21.94	1
		100	0	22.15	22.05	22.06	1
	16QAM	1	0	22.38	22.48	22.47	1
		1	50	22.31	22.34	22.18	1
		1	99	22.30	22.33	22.07	1
		50	0	21.17	21.17	21.12	2
		50	25	21.07	21.07	21.00	2
		50	50	21.04	21.06	20.87	2
		100	0	21.11	21.10	21.00	2

**EIRP**

**WCDMA**

Channel	Frequency (MHz)	LVL (dBm)	Correction Factor(dB)	ERP(dBm)	ERP(mW)	Polarization (H/V)
1312	1712.4	-17.33	41.39	24.06	254.62	H
1413	1732.6	-17.47	41.36	23.89	244.91	H
1513	1752.6	-17.87	42.63	24.76	<b>299.16</b>	H
1312	1712.4	-23.12	44.17	21.05	127.23	V
1413	1732.6	-23.36	44.20	20.84	121.34	V
1513	1752.6	-23.49	44.35	20.86	121.76	V

**LTE BAND 4**

**CHANNEL BANDWIDTH: 1.4MHz QPSK**

Channel	Frequency (MHz)	LVL (dBm)	Correction Factor(dB)	EIRP(dBm)	EIRP(mW)	Polarization (H/V)	LIMIT (W)
19957	1710.7	-23.42	41.29	17.87	61.29	H	1
20175	1732.5	-22.70	41.36	18.66	73.45	H	1
20393	1754.3	-22.92	42.74	19.82	95.90	H	1
19957	1710.7	-20.00	44.25	24.25	<b>265.77</b>	V	1
20175	1732.5	-20.42	44.20	23.78	238.78	V	1
20393	1754.3	-19.94	44.09	24.15	259.72	V	1

**NOTE:** EIRP (dBm) = LVL (dBm) + Correction Factor (dB)

**CHANNEL BANDWIDTH: 1.4MHz 16QAM**

Channel	Frequency (MHz)	LVL (dBm)	Correction Factor(dB)	EIRP(dBm)	EIRP(mW)	Polarization (H/V)	LIMIT (W)
19957	1710.7	-24.29	41.29	17.00	50.16	H	1
20175	1732.5	-23.63	41.36	17.73	59.29	H	1
20393	1754.3	-23.88	42.74	18.86	76.88	H	1
19957	1710.7	-20.87	44.25	23.38	217.52	V	1
20175	1732.5	-21.35	44.20	22.85	192.75	V	1
20393	1754.3	-20.90	44.09	23.19	208.21	V	1

**NOTE:** EIRP (dBm) = LVL (dBm) + Correction Factor (dB)

**LTE BAND 4**

**CHANNEL BANDWIDTH: 3MHz QPSK**

Channel	Frequency (MHz)	LVL (dBm)	Correction Factor(dB)	EIRP(dBm)	EIRP(mW)	Polarization (H/V)	LIMIT (W)
19965	1711.5	-23.40	41.27	17.87	61.19	H	1
20175	1732.5	-22.76	41.36	18.60	72.44	H	1
20385	1753.5	-22.87	42.76	19.89	97.43	H	1
19965	1711.5	-19.98	44.26	24.28	268.04	V	1
20175	1732.5	-20.48	44.20	23.72	235.50	V	1
20385	1753.5	-19.89	44.23	24.34	<b>271.77</b>	V	1

**NOTE:** EIRP (dBm) = LVL (dBm) + Correction Factor (dB)

**CHANNEL BANDWIDTH: 3MHz 16QAM**

Channel	Frequency (MHz)	LVL (dBm)	Correction Factor(dB)	EIRP(dBm)	EIRP(mW)	Polarization (H/V)	LIMIT (W)
19965	1711.5	-24.47	41.27	16.80	47.83	H	1
20175	1732.5	-23.65	41.36	17.71	59.02	H	1
20385	1753.5	-23.86	42.76	18.90	77.57	H	1
19965	1711.5	-21.05	44.26	23.21	209.51	V	1
20175	1732.5	-21.37	44.20	22.83	191.87	V	1
20385	1753.5	-20.88	44.23	23.35	216.37	V	1

**NOTE:** EIRP (dBm) = LVL (dBm) + Correction Factor (dB)

**LTE BAND 4**

**CHANNEL BANDWIDTH: 5MHz QPSK**

Channel	Frequency (MHz)	LVL (dBm)	Correction Factor(dB)	EIRP(dBm)	EIRP(mW)	Polarization (H/V)	LIMIT (W)
19975	1712.5	-23.46	41.39	17.93	62.07	H	1
20175	1732.5	-22.71	41.36	18.65	73.28	H	1
20375	1752.5	-22.82	42.63	19.81	95.70	H	1
19975	1712.5	-20.04	44.17	24.13	258.58	V	1
20175	1732.5	-20.43	44.20	23.77	238.23	V	1
20375	1752.5	-19.84	44.35	24.51	<b>282.16</b>	V	1

**NOTE:** EIRP (dBm) = LVL (dBm) + Correction Factor (dB)

**CHANNEL BANDWIDTH: 5MHz 16QAM**

Channel	Frequency (MHz)	LVL (dBm)	Correction Factor(dB)	EIRP(dBm)	EIRP(mW)	Polarization (H/V)	LIMIT (W)
19975	1712.5	-24.29	41.39	17.10	51.27	H	1
20175	1732.5	-23.73	41.36	17.63	57.94	H	1
20375	1752.5	-23.92	42.63	18.71	74.28	H	1
19975	1712.5	-20.87	44.17	23.30	213.60	V	1
20175	1732.5	-21.45	44.20	22.75	188.36	V	1
20375	1752.5	-20.94	44.35	23.41	219.03	V	1

**NOTE:** EIRP (dBm) = LVL (dBm) + Correction Factor (dB)

**LTE BAND 4**

**CHANNEL BANDWIDTH: 10MHz QPSK**

Channel	Frequency (MHz)	LVL (dBm)	Correction Factor(dB)	EIRP(dBm)	EIRP(mW)	Polarization (H/V)	LIMIT (W)
20000	1715.0	-23.27	41.49	18.22	66.31	H	1
20175	1732.5	-22.65	41.36	18.71	74.30	H	1
20350	1750.0	-22.69	42.28	19.59	91.05	H	1
20000	1715.0	-19.85	44.06	24.21	263.82	V	1
20175	1732.5	-20.37	44.20	23.83	241.55	V	1
20350	1750.0	-19.71	44.43	24.72	<b>296.48</b>	V	1

**NOTE:** EIRP (dBm) = LVL (dBm) + Correction Factor (dB)

**CHANNEL BANDWIDTH: 10MHz 16QAM**

Channel	Frequency (MHz)	LVL (dBm)	Correction Factor(dB)	EIRP(dBm)	EIRP(mW)	Polarization (H/V)	LIMIT (W)
20000	1715.0	-24.42	41.49	17.07	50.89	H	1
20175	1732.5	-23.75	41.36	17.61	57.68	H	1
20350	1750.0	-23.85	42.28	18.43	69.71	H	1
20000	1715.0	-21.00	44.06	23.06	202.44	V	1
20175	1732.5	-21.47	44.20	22.73	187.50	V	1
20350	1750.0	-20.87	44.43	23.56	226.99	V	1

**NOTE:** EIRP (dBm) = LVL (dBm) + Correction Factor (dB)

**LTE BAND 4**

**CHANNEL BANDWIDTH: 15MHz QPSK**

Channel	Frequency (MHz)	LVL (dBm)	Correction Factor(dB)	EIRP(dBm)	EIRP(mW)	Polarization (H/V)	LIMIT (W)
20025	1717.5	-23.28	41.34	18.06	63.94	H	1
20175	1732.5	-22.72	41.36	18.64	73.11	H	1
20325	1747.5	-22.76	42.09	19.33	85.62	H	1
20025	1717.5	-19.86	44.04	24.18	262.06	V	1
20175	1732.5	-20.44	44.20	23.76	237.68	V	1
20325	1747.5	-19.78	44.22	24.44	<b>277.65</b>	V	1

**NOTE:** EIRP (dBm) = LVL (dBm) + Correction Factor (dB)

**CHANNEL BANDWIDTH: 15MHz 16QAM**

Channel	Frequency (MHz)	LVL (dBm)	Correction Factor(dB)	EIRP(dBm)	EIRP(mW)	Polarization (H/V)	LIMIT (W)
20025	1717.5	-24.14	41.34	17.20	52.46	H	1
20175	1732.5	-23.59	41.36	17.77	59.84	H	1
20325	1747.5	-23.61	42.09	18.48	70.40	H	1
20025	1717.5	-20.72	44.04	23.32	214.98	V	1
20175	1732.5	-21.31	44.20	22.89	194.54	V	1
20325	1747.5	-20.63	44.22	23.59	228.30	V	1

**NOTE:** EIRP (dBm) = LVL (dBm) + Correction Factor (dB)

**LTE BAND 4**

**CHANNEL BANDWIDTH: 20MHz QPSK**

Channel	Frequency (MHz)	LVL (dBm)	Correction Factor(dB)	EIRP(dBm)	EIRP(mW)	Polarization (H/V)	LIMIT (W)
20050	1720.0	-23.86	41.28	17.42	55.22	H	1
20175	1732.5	-23.17	41.36	18.19	65.93	H	1
20300	1745.0	-23.34	41.96	18.62	72.73	H	1
20050	1720.0	-20.44	44.14	23.70	<b>234.15</b>	V	1
20175	1732.5	-20.89	44.20	23.31	214.09	V	1
20300	1745.0	-20.36	43.88	23.52	225.01	V	1

**NOTE:** EIRP (dBm) = LVL (dBm) + Correction Factor (dB)



**CHANNEL BANDWIDTH: 20MHz 16QAM**

Channel	Frequency (MHz)	LVL (dBm)	Correction Factor(dB)	EIRP(dBm)	EIRP(mW)	Polarization (H/V)	LIMIT (W)
20050	1720.0	-24.79	41.28	16.49	44.58	H	1
20175	1732.5	-24.24	41.36	17.12	51.53	H	1
20300	1745.0	-24.17	41.96	17.79	60.08	H	1
20050	1720.0	-21.37	44.14	22.77	189.02	V	1
20175	1732.5	-21.96	44.20	22.24	167.34	V	1
20300	1745.0	-21.19	43.88	22.69	185.87	V	1

**NOTE:** EIRP (dBm) = LVL (dBm) + Correction Factor (dB)

## 4.2 Frequency Stability Measurement

### 4.2.1 Limits of Frequency Stability Measurement

The frequency stability shall be sufficient to ensure that the fundamental emissions stay within the authorized bands of operation.

### 4.2.2 Test Procedure

- a. Device is placed at the oven room. The oven room could control the temperatures and humidity. Power warm up is at least 15 min and power applied should perform before recording frequency error.
- b. EUT is connected the external power supply to control the DC input power. The test voltage range is from minimum to maximum working voltage. Each step shall be record the frequency error rate.
- c. The temperature range step is 10 degrees in this test items. All temperature levels shall be hold the  $\pm 0.5^{\circ}\text{C}$  during the measurement testing. The each temperature step shall be at least 0.5 hours, consider the EUT could be test under the stability condition.

**NOTE:** The frequency error was recorded frequency error from the communication simulator.

### 4.2.3 Test Setup

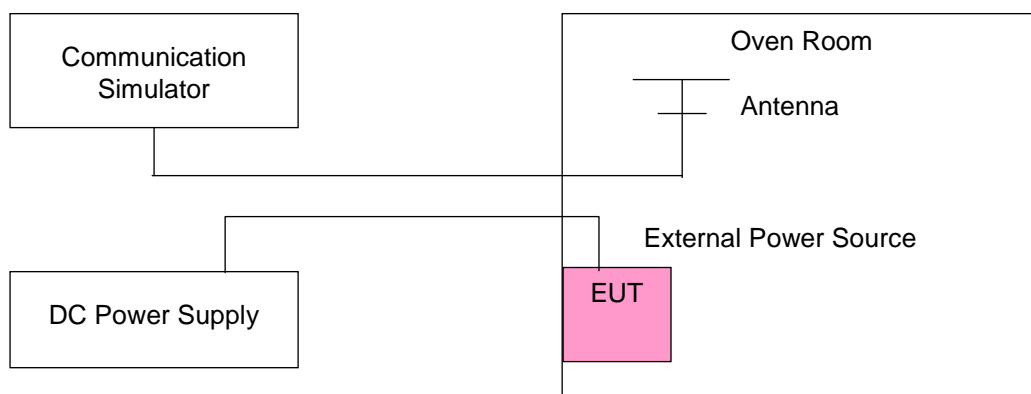

4.2.4 Test Results

**FREQUENCY ERROR VS. VOLTAGE**

		FREQUENCY ERROR (PPM)						
VOLTAGE (Volts)	WCDMA	LTE Band 4						LIMIT (ppm)
		1.4MHz	3MHz	5MHz	10MHz	15MHz	20MHz	
3.8	0.0014	0.0012	0.0013	0.0013	0.0012	0.0014	0.0014	2.5
3.6	0.0013	0.0014	0.0013	0.0012	0.0014	0.0016	0.0014	2.5
4.35	0.0012	0.0014	0.0013	0.0014	0.0015	0.0014	0.0012	2.5

**NOTE:** The applicant defined the normal working voltage of the battery is from 3.6Vdc to 4.35Vdc.

**FREQUENCY ERROR vs. TEMPERATURE.**

		Frequency Error (PPM)						
TEMP. (°C)	WCDMA	LTE Band 4						LIMIT (ppm)
		1.4MHz	3MHz	5MHz	10MHz	15MHz	20MHz	
-30	0.0028	0.0048	0.0050	0.0034	0.0031	0.0023	0.0052	2.5
-20	0.0034	0.0031	0.0027	0.0034	0.0037	0.0037	0.0049	2.5
-10	0.0039	0.0029	0.0034	0.0025	0.0044	0.0037	0.0046	2.5
0	0.0045	0.0028	0.0029	0.0044	0.0045	0.0042	0.0055	2.5
10	0.0040	0.0044	0.0033	0.0045	0.0031	0.0031	0.0039	2.5
20	0.0029	0.0037	0.0037	0.0049	0.0035	0.0035	0.0027	2.5
30	0.0033	0.0046	0.0028	0.0036	0.0048	0.0029	0.0050	2.5
40	0.0016	0.0027	0.0040	0.0028	0.0047	0.0049	0.0049	2.5
50	0.0017	0.0054	0.0046	0.0053	0.0031	0.0036	0.0045	2.5
60	0.0040	0.0049	0.0029	0.0045	0.0037	0.0044	0.0036	2.5

### 4.3 Occupied Bandwidth Measurement

#### 4.3.1 Limits Of Occupied Bandwidth Measurement

The width of a frequency band such that, below the lower and above the upper frequency limits, the mean powers emitted are each equal to a specified percentage 0.5 %of the total mean power of a given emission.

#### 4.3.2 Test Setup

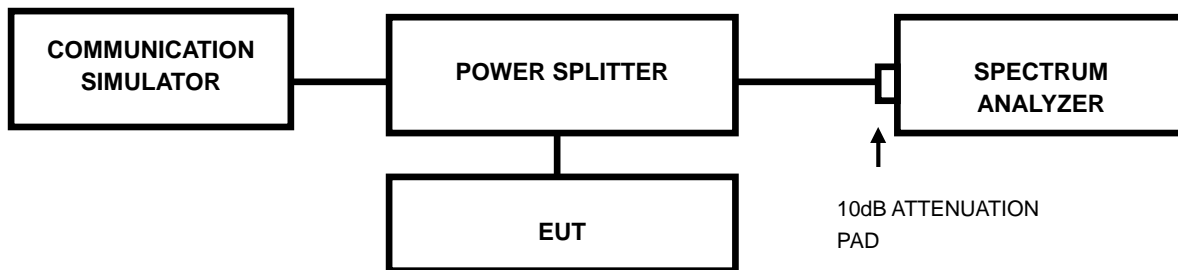

#### 4.3.3 Test Procedures

- a. The conducted occupied bandwidth used the power splitter via EUT RF power connector between simulation base station and spectrum analyzer.
- b. Use OBW measurement function of Spectrum analyzer to measure 99 % occupied bandwidth.

4.3.4 Test Result

Channel	FREQ. (MHz)	99% Occupied Bandwidth (MHz)	Channel	FREQ. (MHz)	26dB Bandwidth (MHz)
		WCDMA			WCDMA
1312	1712.40	4.21	1312	1712.40	4.85
1413	1732.60	4.19	1413	1732.60	4.87
1513	1752.60	4.21	1513	1752.60	4.86

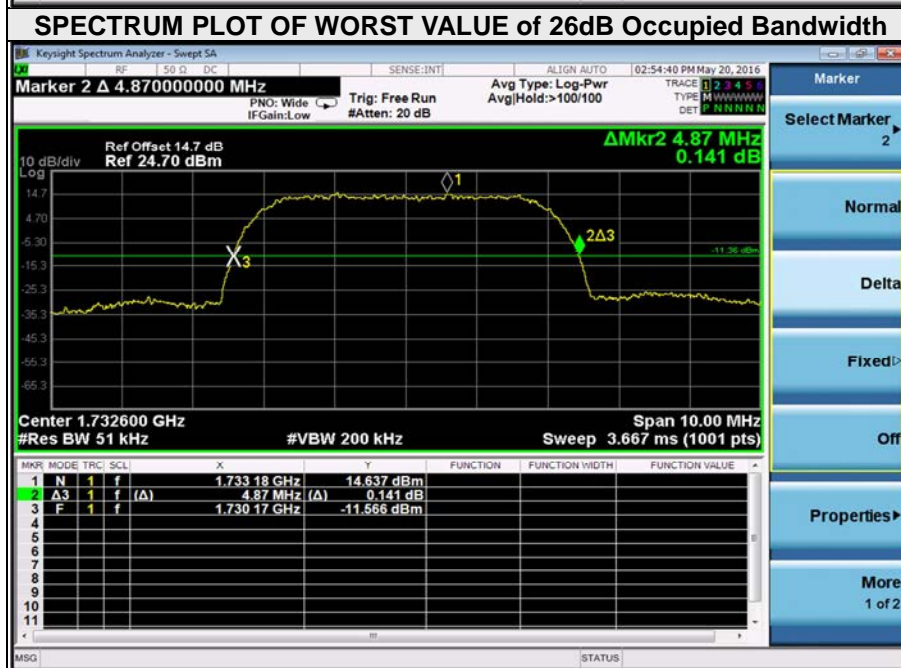
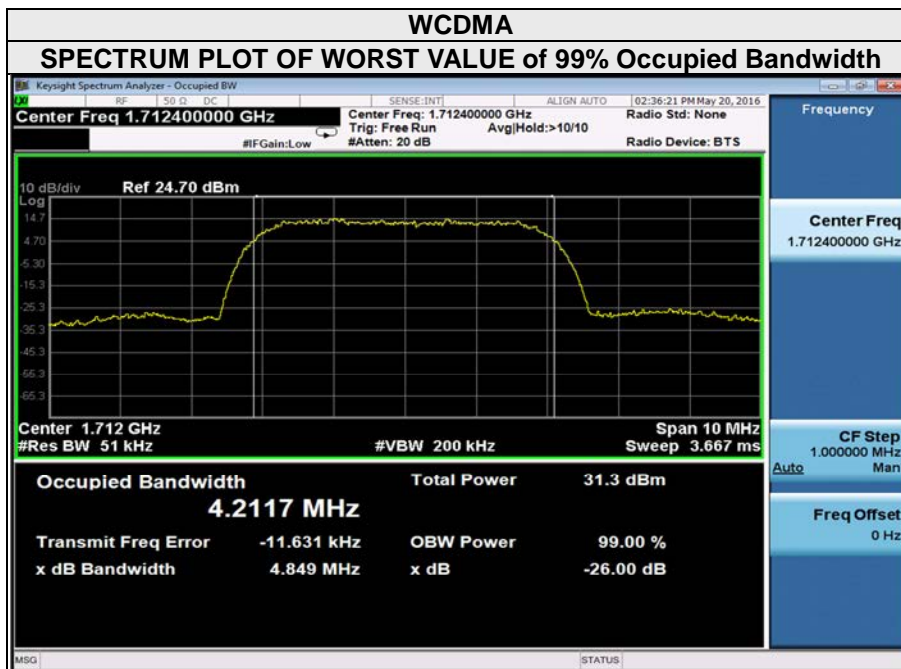

**LTE BAND 4**

CHANNEL BANDWIDTH: 1.4MHz				CHANNEL BANDWIDTH: 3MHz			
CHANNEL	Frequency (MHz)	99% OCCUPIED Bandwidth (MHz)		CHANNEL	Frequency (MHz)	99% OCCUPIED Bandwidth (MHz)	
		QPSK	16QAM			QPSK	16QAM
19957	1710.7	1.09	1.09	19965	1711.5	2.68	2.68
20175	1732.5	1.09	1.08	20175	1732.5	2.68	2.68
20393	1754.3	1.09	1.08	20385	1753.5	2.69	2.68

**SPECTRUM PLOT OF WORST VALUE**



CHANNEL BANDWIDTH: 5MHz				CHANNEL BANDWIDTH: 10MHz			
CHANNEL	Frequency (MHz)	99% OCCUPIED Bandwidth (MHz)		CHANNEL	Frequency (MHz)	99% OCCUPIED Bandwidth (MHz)	
		QPSK	16QAM			QPSK	16QAM
19975	1712.5	4.48	4.49	20000	1715	8.94	8.94
20175	1732.5	4.49	4.48	20175	1732.5	8.95	8.95
20375	1752.5	4.49	4.48	20350	1750	8.93	8.94

**SPECTRUM PLOT OF WORST VALUE**





CHANNEL BANDWIDTH: 15MHz				CHANNEL BANDWIDTH: 20MHz			
CHANNEL	FREQUENCY (MHz)	99% OCCUPIED BANDWIDTH (MHz)		CHANNEL	FREQUENCY (MHz)	99% OCCUPIED BANDWIDTH (MHz)	
		QPSK	16QAM			QPSK	16QAM
20025	1717.5	13.42	13.43	20050	1720	17.95	17.89
20175	1732.5	13.44	13.44	20175	1732.5	17.94	17.88
20325	1747.5	13.43	13.41	20300	1745	17.91	17.83

**SPECTRUM PLOT OF WORST VALUE**





## 4.4 Peak To Average Ratio

### 4.4.1 Limits of Peak To Average Ratio Measurement

In measuring transmissions in this band using an average power technique, the peak to-average ratio (PAR) of the transmission may not exceed 13 dB

### 4.4.2 Test Setup

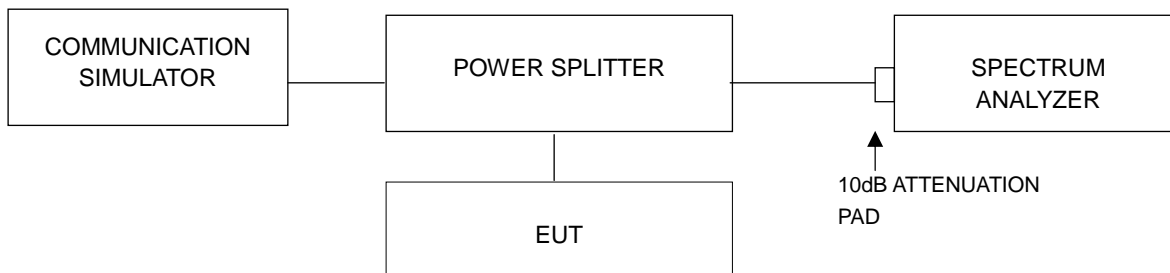

### 4.4.3 Test Procedures

1. Set resolution/measurement bandwidth  $\geq$  signal's occupied bandwidth;
2. Set the number of counts to a value that stabilizes the measured CCDF curve;
3. Record the maximum PAPR level associated with a probability of 0.1%.

#### 4.4.4 Test Results

Channel	Frequency (MHz)	Peak To Average Ratio (dB)
		WCDMA
1413	1732.6	2.87

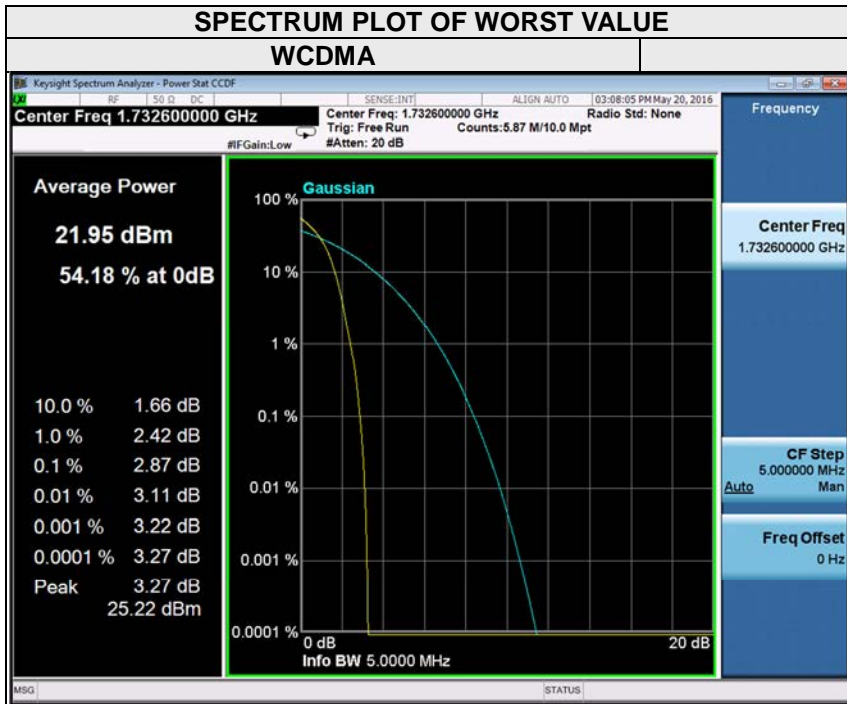

**LTE BAND 4**

CHANNEL BANDWIDTH: 1.4MHz				CHANNEL BANDWIDTH: 3MHz			
CHANNEL	FREQUENCY (MHz)	PEAK TO AVERAGE RATIO (dB)		CHANNEL	FREQUENCY (MHz)	PEAK TO AVERAGE RATIO (dB)	
		QPSK	16QAM			QPSK	16QAM
19957	1710.7	5.09	5.86	19965	1711.5	5.28	5.97
20175	1732.5	5.66	6.35	20175	1732.5	5.78	6.30
20393	1754.3	5.54	6.24	20385	1753.5	5.63	6.25

**SPECTRUM PLOT OF WORST VALUE**

**1.4MHz / QPSK**

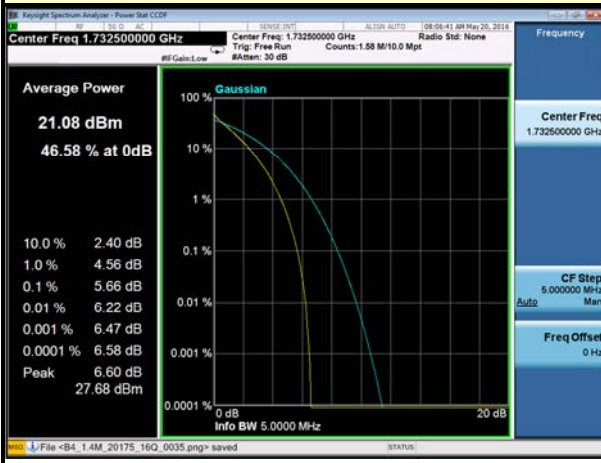

**1.4MHz / 16QAM**

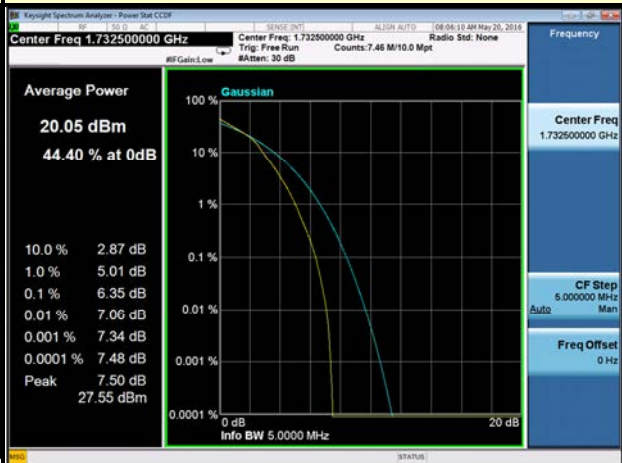

**3MHz / QPSK**

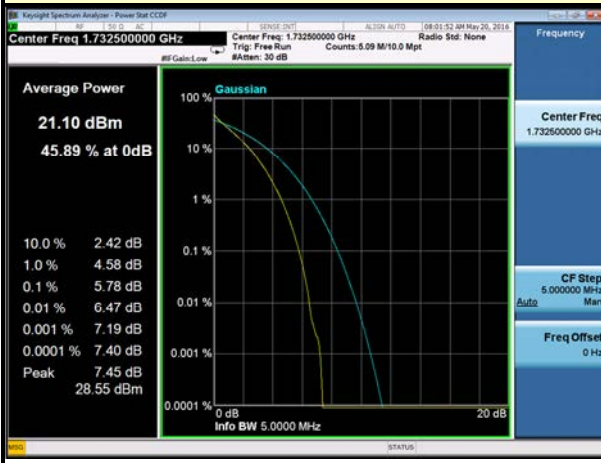

**3MHz / 16QAM**

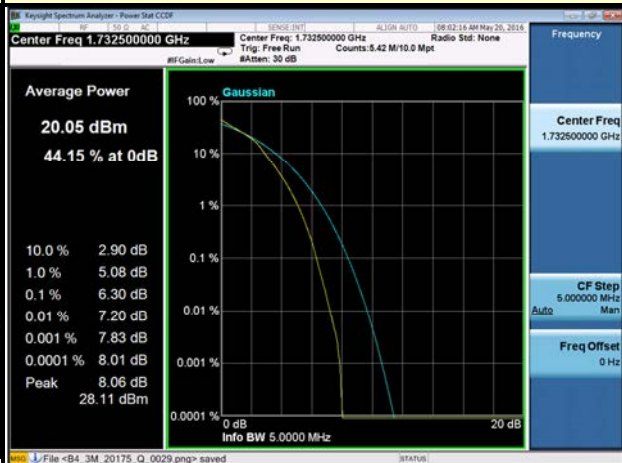

CHANNEL BANDWIDTH: 5MHz				CHANNEL BANDWIDTH: 10MHz			
CHANNEL	FREQUENCY (MHz)	PEAK TO AVERAGE RATIO (dB)		CHANNEL	FREQUENCY (MHz)	PEAK TO AVERAGE RATIO (dB)	
		QPSK	16QAM			QPSK	16QAM
19975	1712.5	5.43	6.04	20000	1715	5.41	6.06
20175	1732.5	5.74	6.39	20175	1732.5	5.71	6.30
20375	1752.5	5.71	6.37	20350	1750	5.51	6.16

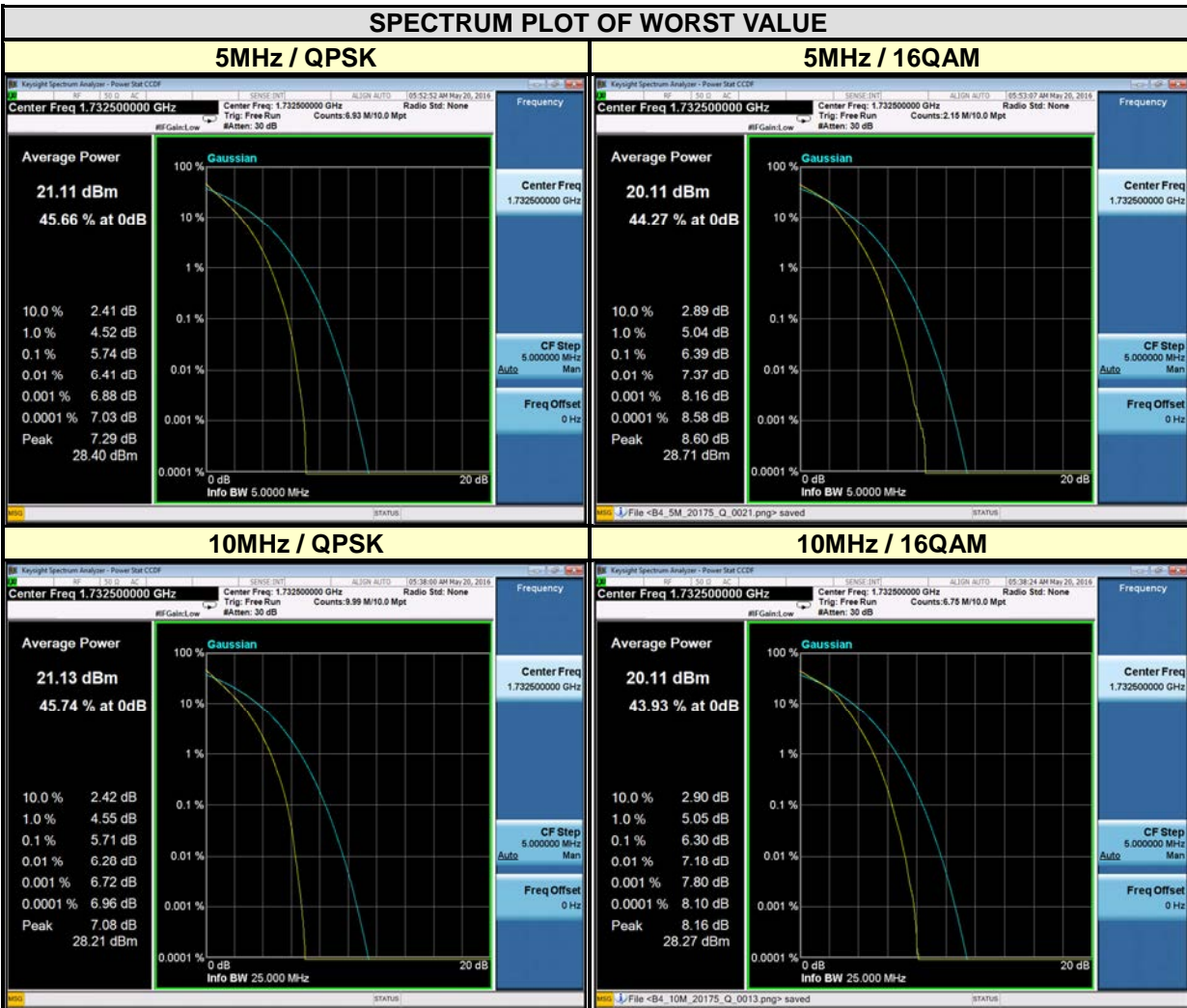

CHANNEL BANDWIDTH: 15MHz				CHANNEL BANDWIDTH: 20MHz			
CHANNEL	FREQUENCY (MHz)	PEAK TO AVERAGE RATIO (dB)		CHANNEL	FREQUENCY (MHz)	PEAK TO AVERAGE RATIO (dB)	
		QPSK	16QAM			QPSK	16QAM
20025	1717.5	5.57	6.17	20050	1720	5.66	6.33
20175	1732.5	5.70	6.35	20175	1732.5	5.70	6.42
20325	1747.5	5.46	6.11	20300	1745	5.42	6.14

**SPECTRUM PLOT OF WORST VALUE**

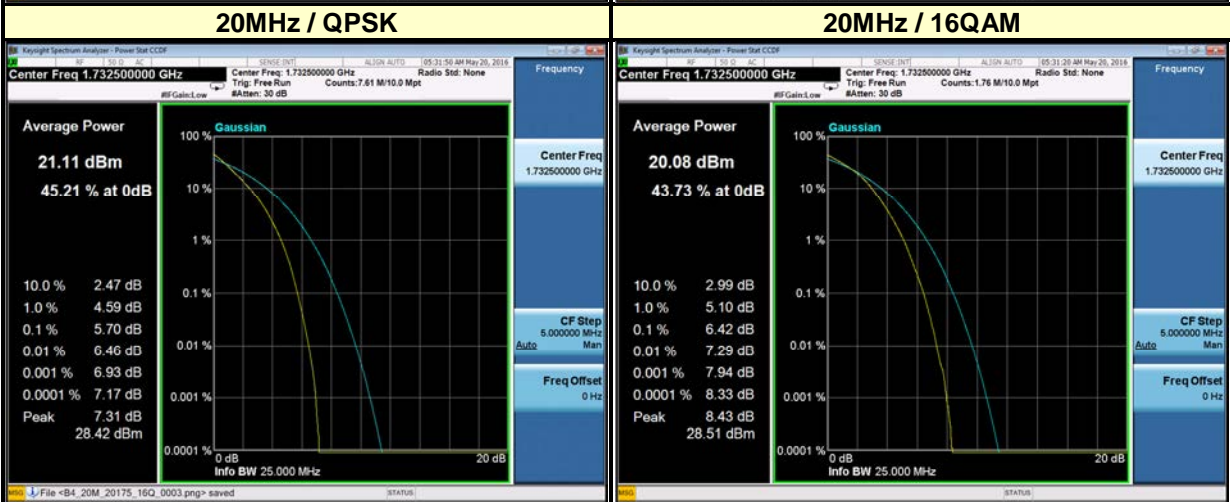
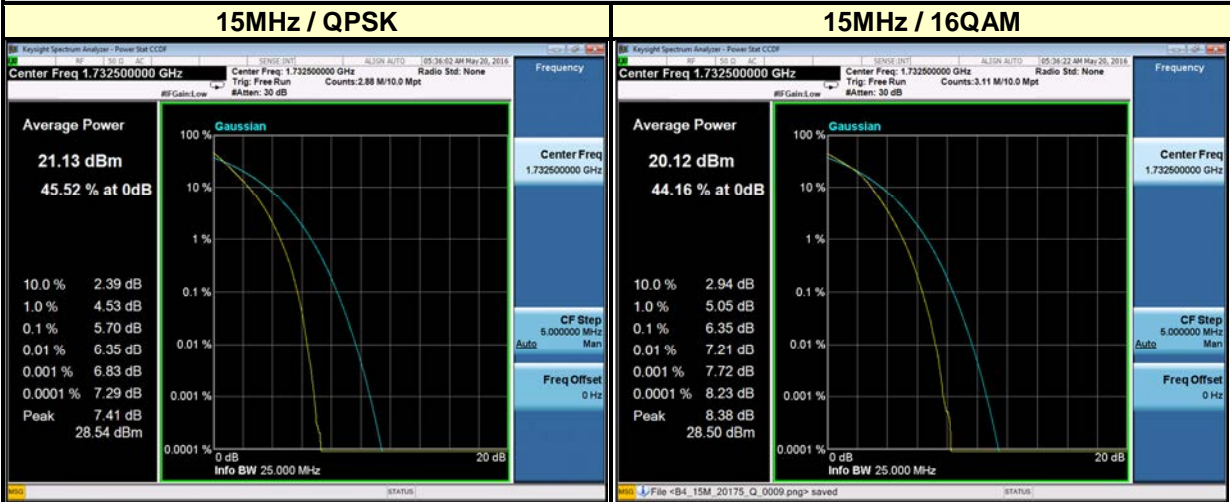

## 4.5 Band Edge Measurement

### 4.5.1 Limits of Band Edge Measurement

The power of any emission outside a licensee's frequency band(s) of operation shall be attenuated below the transmitter power (P) within the licensed band(s) of operation, measured in watts, by at least  $43 + 10 \log (P)$  dB. Compliance with this provision is based on the use of measurement instrumentation employing a resolution bandwidth of 100 kilohertz or greater.

However, in the 100 kilohertz bands immediately outside and adjacent to a licensee's frequency block, a resolution bandwidth of at least 30 kHz may be employed.

### 4.5.2 Test Setup

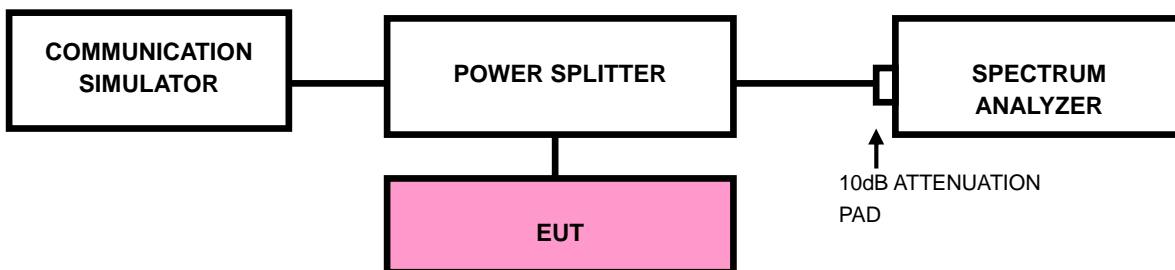

### 4.5.3 Test Procedures

- a. The EUT was set up for the maximum peak power with WCDMA & LTE link data modulation. The power was measured with R&S Spectrum Analyzer. All measurements were done at 2 channels (low and high operational frequency range.).
- b. The center frequency of spectrum is the band edge frequency and span is 10MHz. RB of the spectrum is 100kHz and VB of the spectrum is 300kHz (WCDMA).
- c. The band edge measurement used the power splitter via EUT RF power connector between simulation base station and spectrum analyzer.
- d. The center frequency of spectrum is the band edge frequency and span is 1~5 MHz. RB of the spectrum is 20kHz and VB of the spectrum is 100 kHz. (LTE bandwidth 1.4MHz)
- e. The center frequency of spectrum is the band edge frequency and span is 1~5 MHz. RB of the spectrum is 30kHz and VB of the spectrum is 100kHz. (LTE bandwidth 3MHz)
- f. The center frequency of spectrum is the band edge frequency and span is 1~5 MHz. RB of the spectrum is 50kHz and VB of the spectrum is 200kHz. (LTE bandwidth 5MHz)
- g. The center frequency of spectrum is the band edge frequency and span is 1~5 MHz. RB of the spectrum is 100kHz and VB of the spectrum is 300kHz. (LTE bandwidth 10MHz)
- h. The center frequency of spectrum is the band edge frequency and span is 1~5 MHz. RB of the spectrum is 200kHz and VB of the spectrum is 1MHz. (LTE bandwidth 15MHz)
- i. The center frequency of spectrum is the band edge frequency and span is 1~5 MHz. RB of the spectrum is 200kHz and VB of the spectrum is 1MHz. (LTE bandwidth 20MHz)
- j. Record the max trace plot into the test report.



### 4.5.4 Test Results

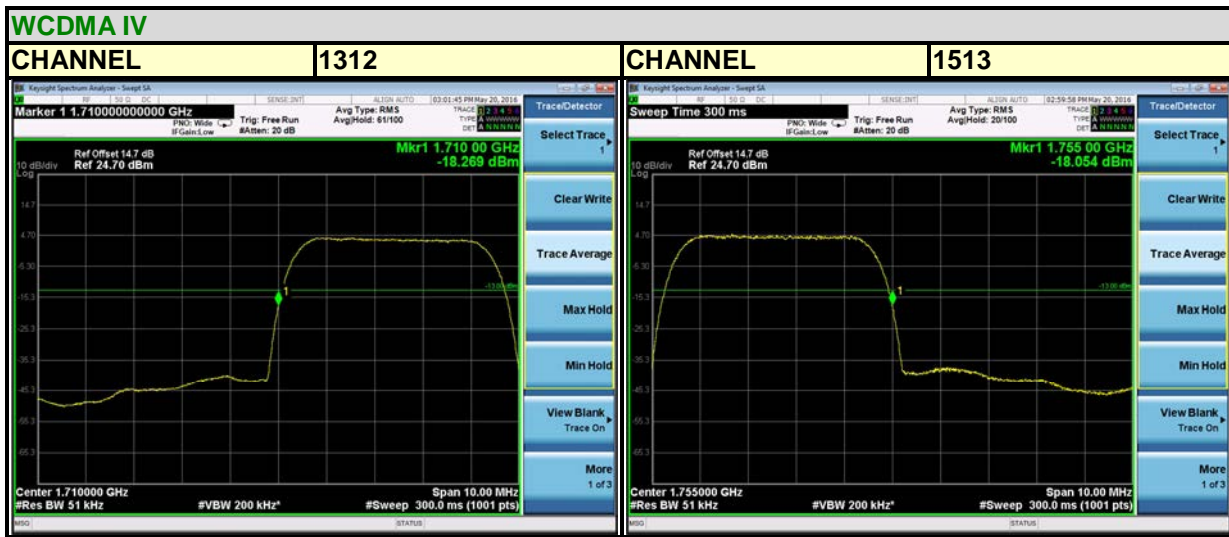

LTE BAND 4

Channel Bandwidth: 1.4MHz

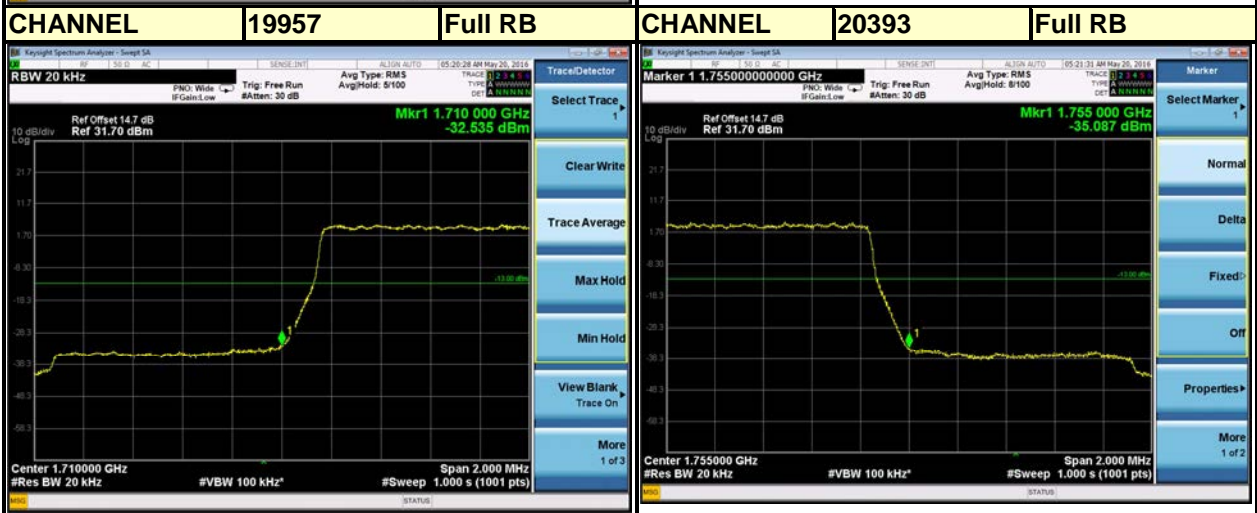
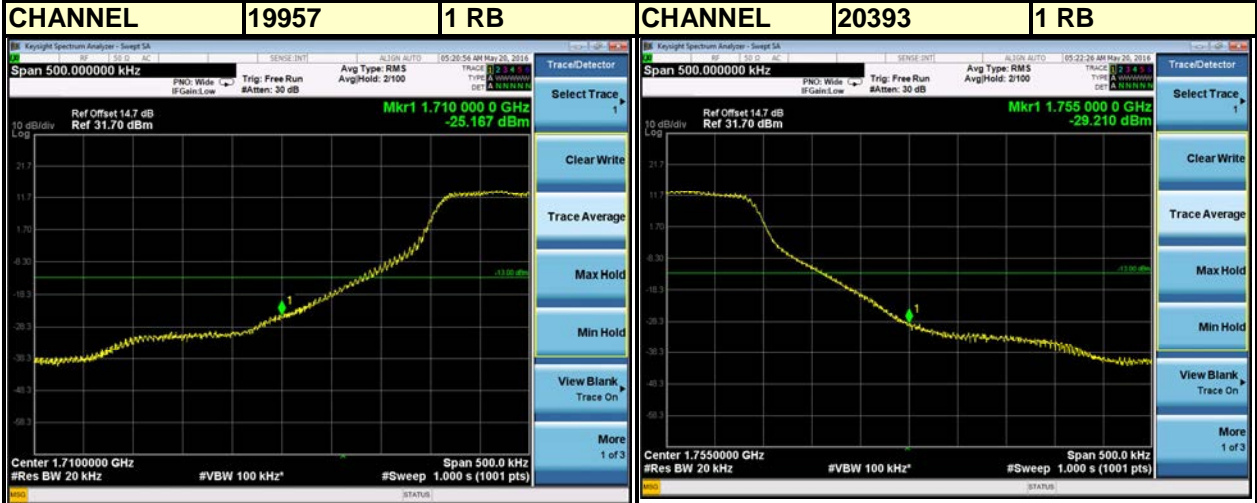



**Channel Bandwidth: 3MHz**

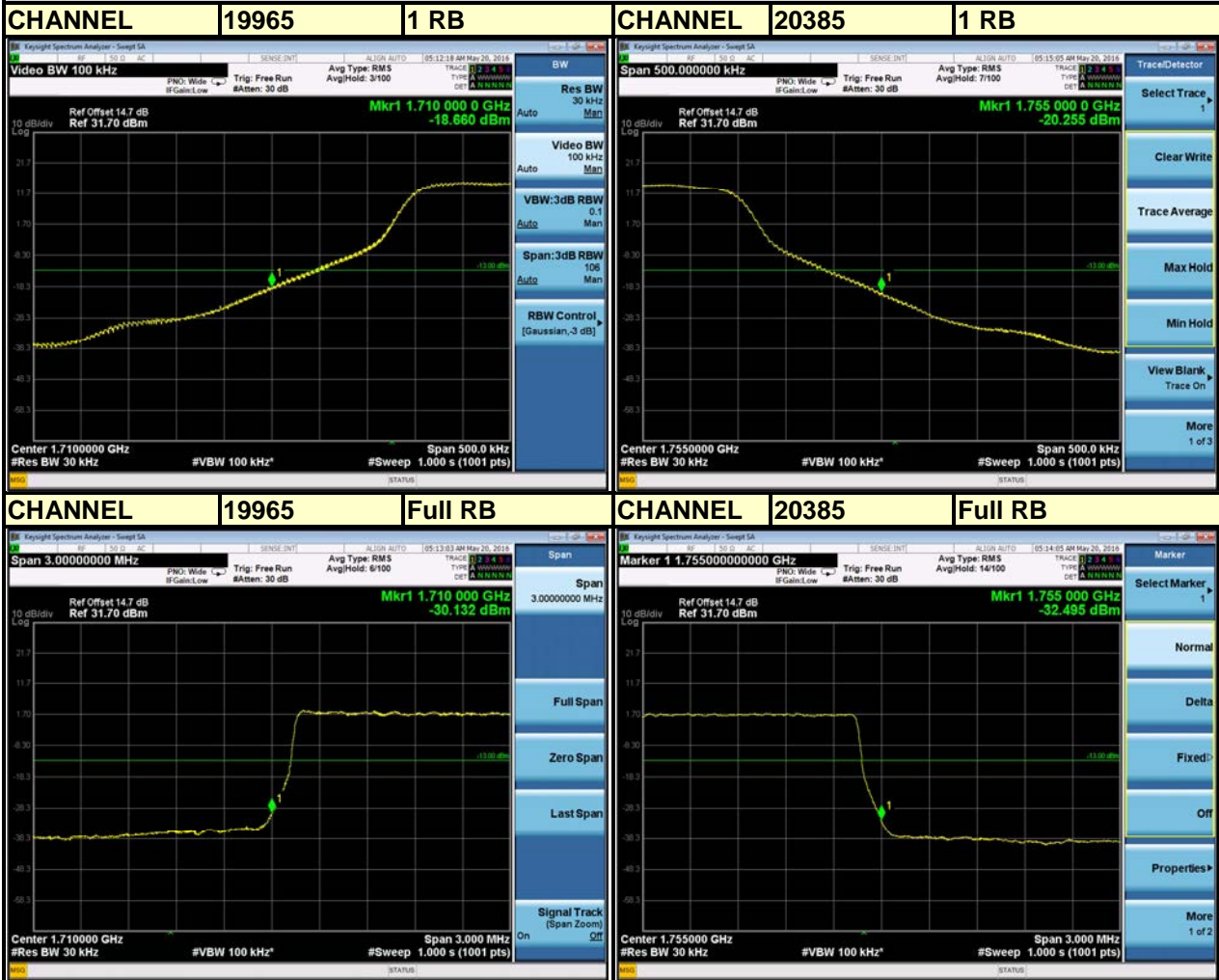

**Channel Bandwidth: 5MHz**

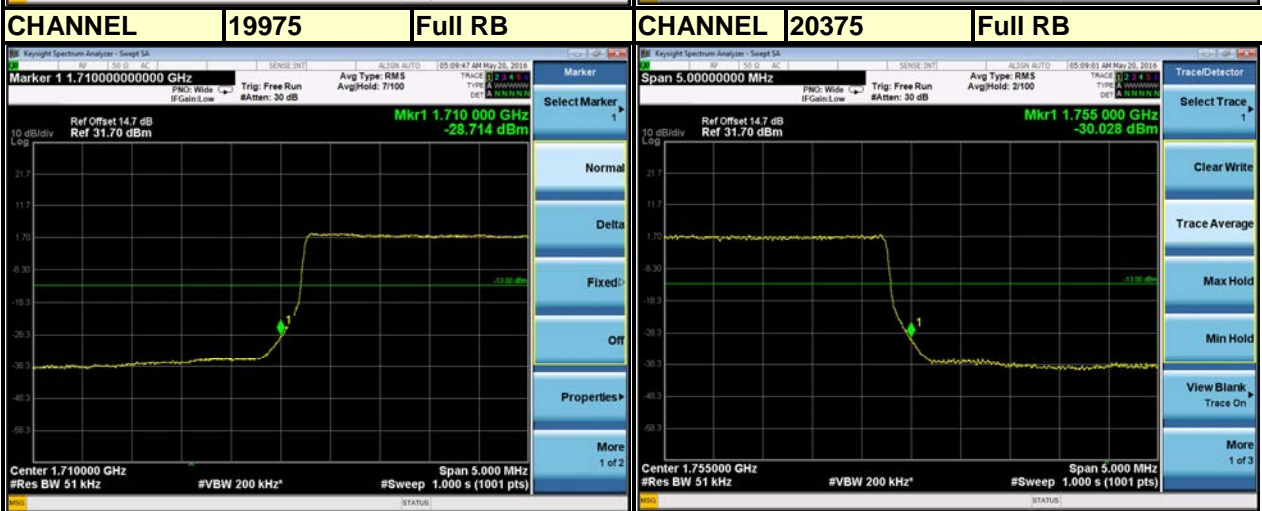
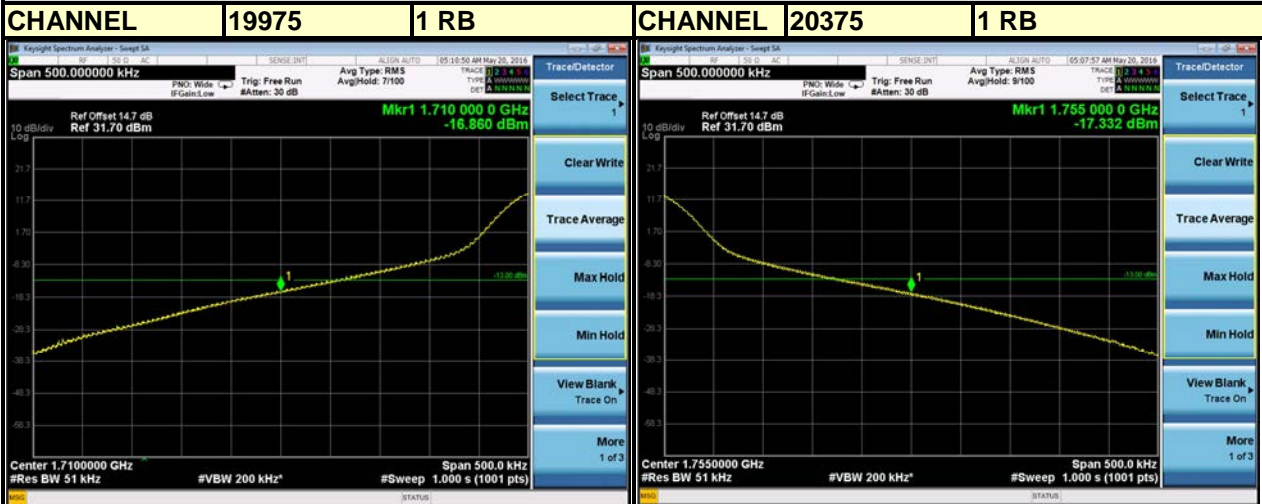

**Channel Bandwidth: 10MHz**

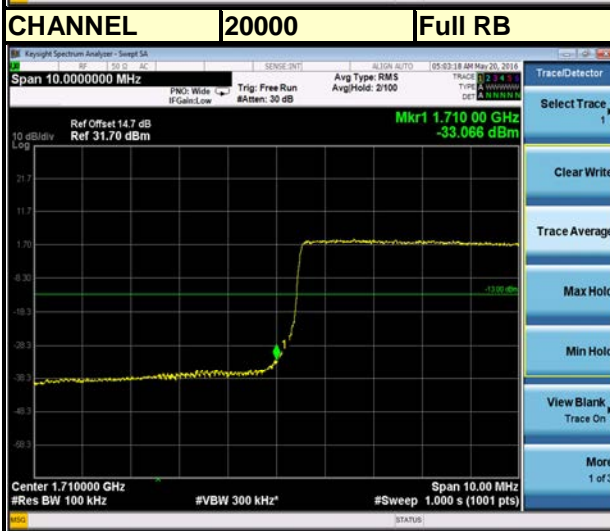
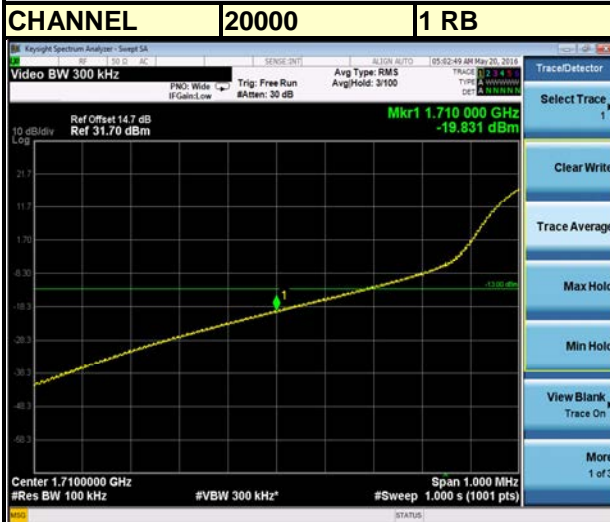

**Channel Bandwidth: 15MHz**

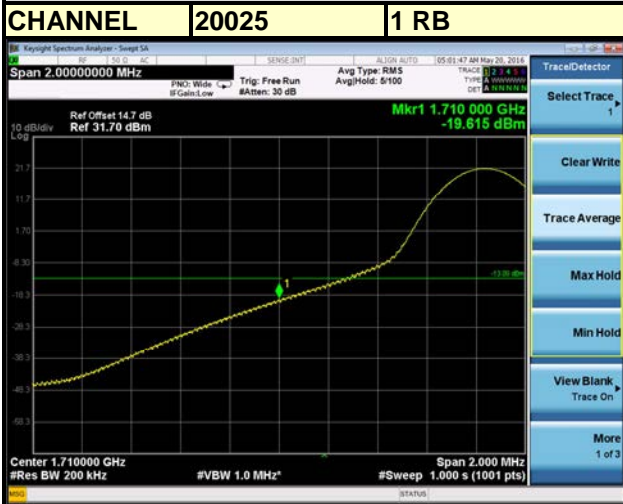

**Channel Bandwidth: 20MHz**

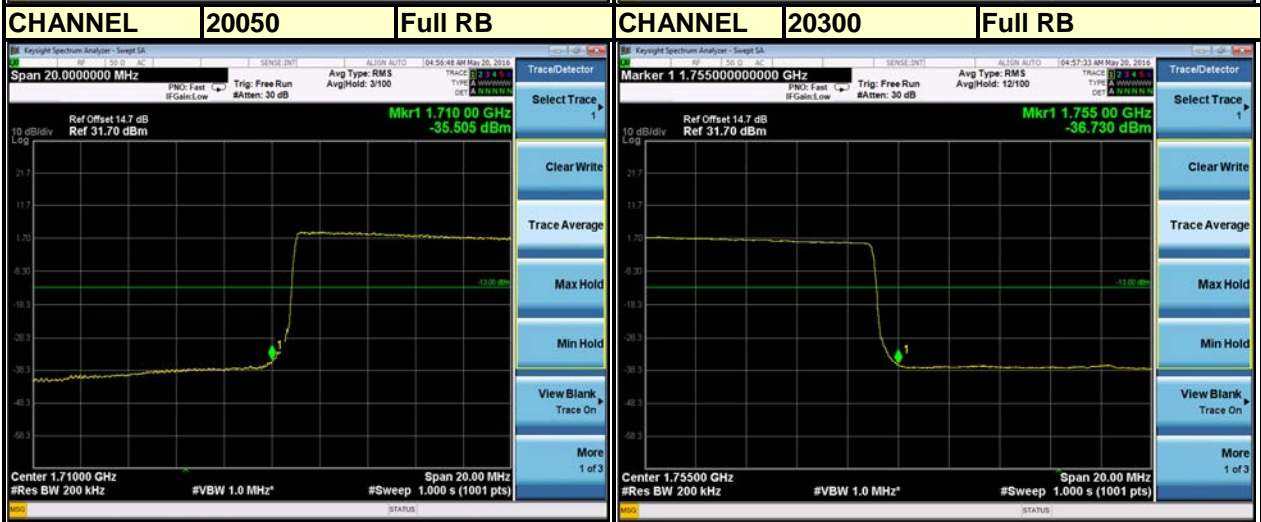
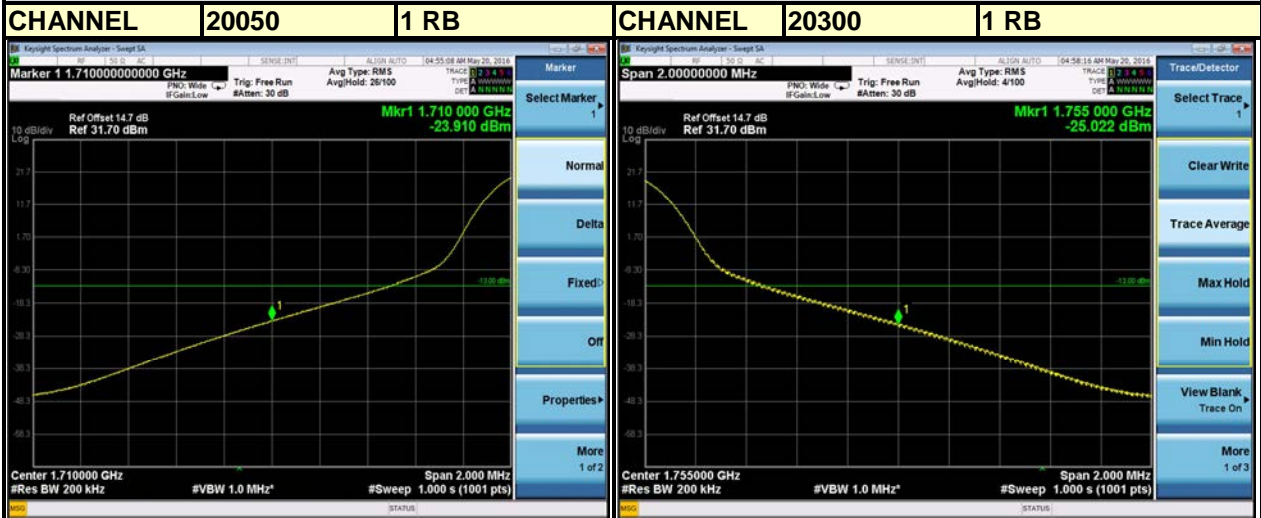



## 4.6 Conducted Spurious Emissions

### 4.6.1 Limits of Conducted Spurious Emissions Measurement

The power of any emission outside a licensee's frequency block shall be attenuated below the transmitter power (P) by at least  $43 + 10 \log_{10}(P)$  dB. The limit of emission is equal to -13dBm.

### 4.6.2 Test Procedure

- a. The EUT makes a phone call to the communication simulator. All measurements were done at low, middle and high operational frequency range.
- b. Measuring frequency range is from 30MHz to 19.1GHz for WCDMA IV and LTE Band 4. 10dB attenuation pad is connected with spectrum. RBW=1MHz and VBW=3MHz are used for conducted emission measurement.

### 4.6.3 Test Setup

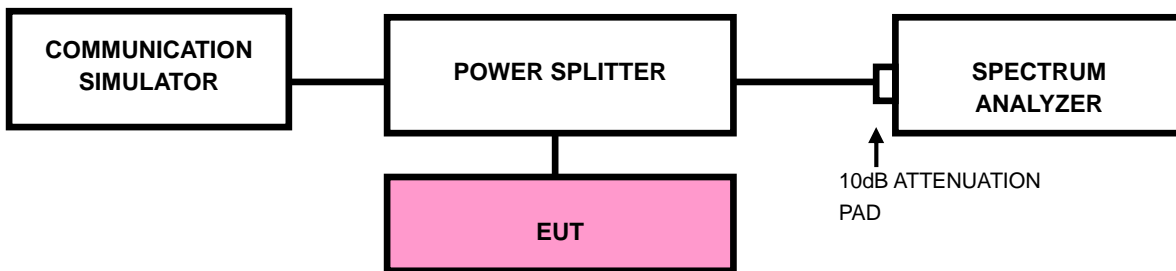

4.6.4 Test Results



**LTE BAND 4**

**CHANNEL 20175**

**1.4MHz / QPSK**

**FREQUENCY RANGE : 30MHz~19.1GHz**

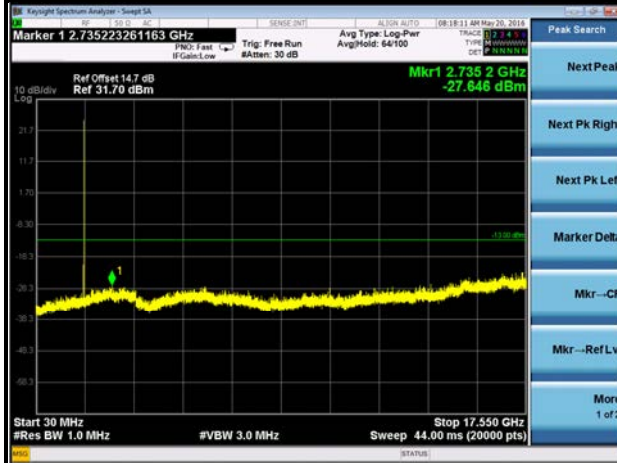

**CHANNEL 20175**

**3MHz / QPSK**

**FREQUENCY RANGE : 30MHz~19.1GHz**



**5MHz / QPSK**

**FREQUENCY RANGE : 30MHz~19.1GHz**

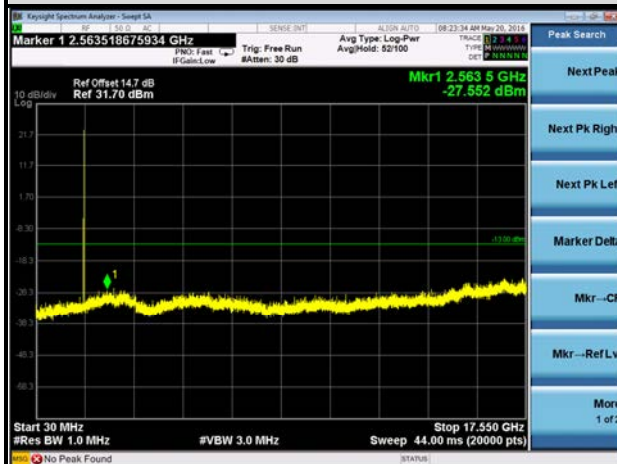

**10MHz / QPSK**

**FREQUENCY RANGE : 30MHz~19.1GHz**

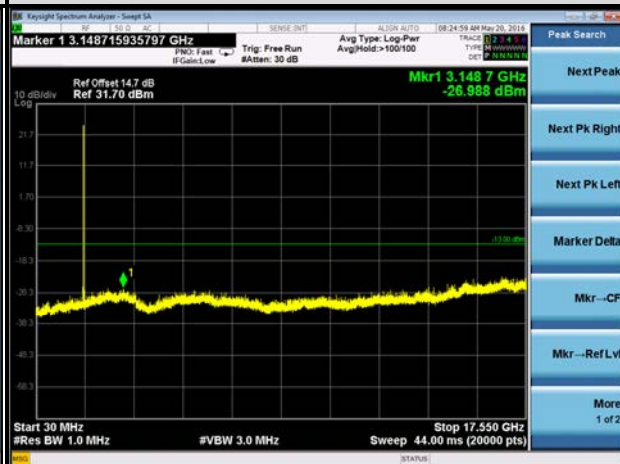

**15MHz / QPSK**

**FREQUENCY RANGE : 30MHz~19.1GHz**

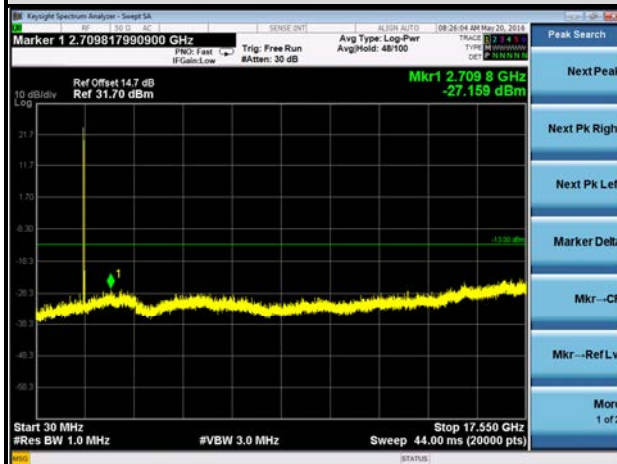

**20MHz / QPSK**

**FREQUENCY RANGE : 30MHz~19.1GHz**

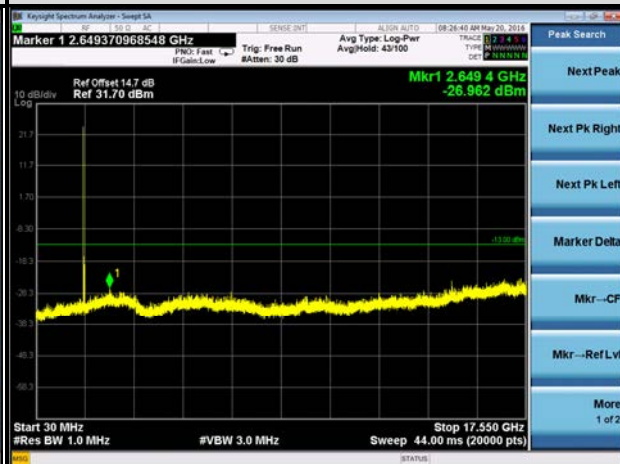



## 4.7 Radiated Emission Measurement

### 4.7.1 Limits of Radiated Emission Measurement

In the FCC 27.53(m) (4), On any frequency outside a licensee's frequency block, The power of any emission shall be attenuated below the transmitter power (P) by at least  $43 + 10 \log (P)$  dB. The emission limit equal to -13dBm.

### 4.7.2 Test Procedure

- a. Substitution method is used for E.I.R.P measurement. In the semi-anechoic chamber, EUT placed on the 0.8m height of Turn Table, rotated the table around 360 degrees to search the maximum radiation power and receiver antenna shall be rotated vertical and horizontal polarization and moved height from 1m to 4m to find the maximum polar radiated power. The "Read Value" is the spectrum reading the maximum power value.
- b. The substitution horn antenna is substituted for EUT at the same position and signals generator export the CW signal to the substitution antenna via a TX cable. Rotated the Turn Table and moved receiving antenna to find the maximum radiation power. Adjust output power level of S.G to get a Value of spectrum reading equal to "Read Value " of step a. Record the power level of S.G.
- c.  $EIRP = \text{Output power level of S.G} - \text{TX cable loss} + \text{Antenna gain of substitution horn}$ .
- d. E.R.P power can be calculated form E.I.R.P power by subtracting the gain of dipole,  $E.R.P \text{ power} = E.I.P.R \text{ power} - 2.15\text{dBi}$ .

**NOTE:** The resolution bandwidth of spectrum analyzer is 1 MHz and the video bandwidth is 3 MHz.

### 4.7.3 Deviation from Test Standard

No deviation.

#### 4.7.4 Test Setup

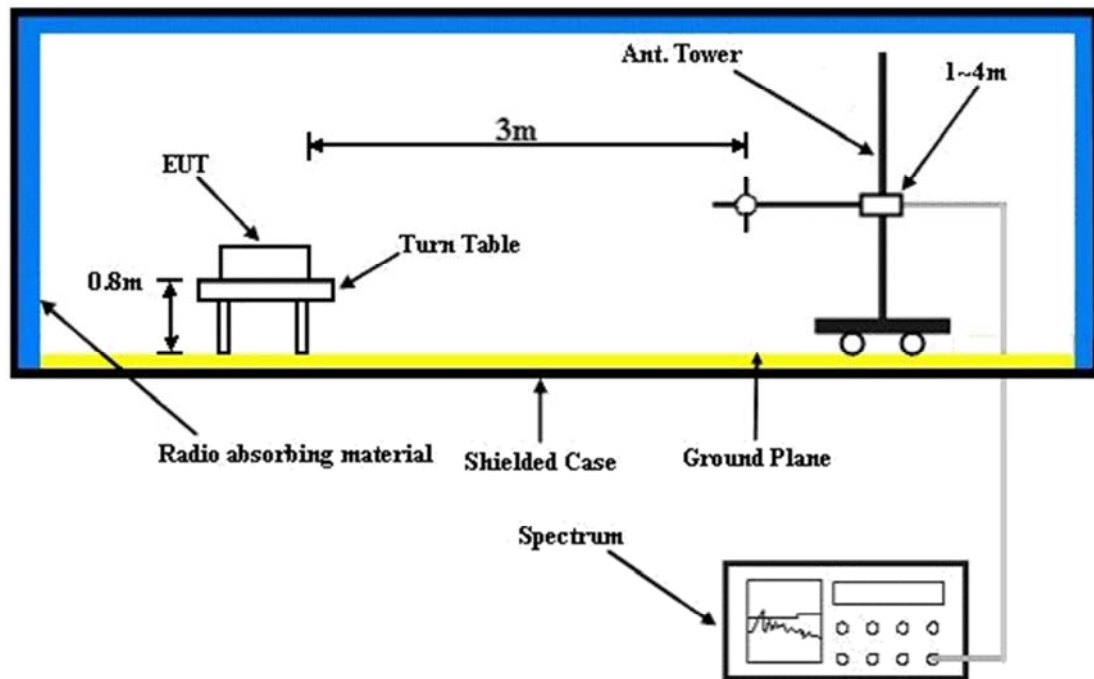

For the actual test configuration, please refer to the attached file (Test Setup Photo).

4.7.5 Test Results

**BELOW 1GHz WORST-CASE DATA**

**LTE Band 4:**

<b>MODE</b>	TX channel20175	<b>FREQUENCY RANGE</b>	Below 1000MHz
<b>ENVIRONMENTAL CONDITIONS</b>	26deg. C, 56%RH	<b>INPUT POWER</b>	DC 5V from adapter
<b>TESTED BY</b>	Alex Chen		
<b>ANTENNA POLARITY &amp; TEST DISTANCE: HORIZONTAL AT 3 M</b>			

	Freq	Level	Read Level	Limit Line	Over Limit	Factor	Remark	Pol/Phase
	MHz	dBm/m	dBm	dBm/m	dB	dB/m		
1 PP	43.580	-33.22	-42.16	-13.00	-20.22	8.94	Peak	Horizontal
2	107.600	-60.22	-47.48	-13.00	-47.22	-12.74	Peak	Horizontal
3	183.260	-75.17	-57.49	-13.00	-62.17	-17.68	Peak	Horizontal
4	230.790	-72.28	-55.63	-13.00	-59.28	-16.65	Peak	Horizontal
5	353.010	-74.33	-62.30	-13.00	-61.33	-12.03	Peak	Horizontal
6	559.620	-73.71	-64.34	-13.00	-60.71	-9.37	Peak	Horizontal

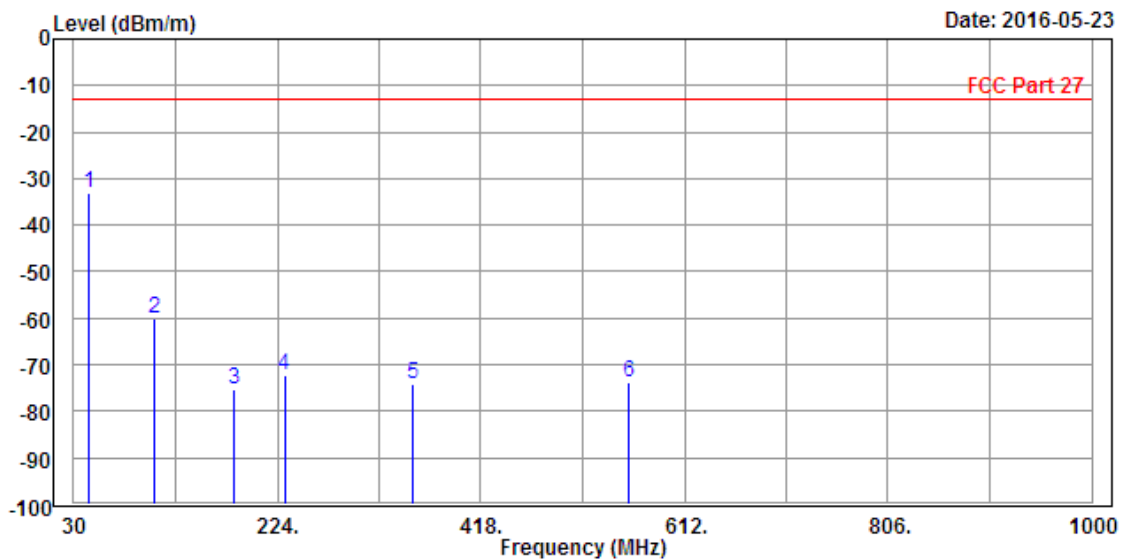

<b>MODE</b>	TX channel20175	<b>FREQUENCY RANGE</b>	Below 1000MHz
<b>ENVIRONMENTAL CONDITIONS</b>	26deg. C, 56%RH	<b>INPUT POWER</b>	DC 5V from adapter
<b>TESTED BY</b>	Alex Chen		
<b>ANTENNA POLARITY &amp; TEST DISTANCE: VERTICAL AT 3 M</b>			

	Freq	Level	Read Level	Limit Line	Over Limit	Factor	Remark	Pol/Phase	
	MHz	dBm/m	dBm	dBm/m	dB	dB/m			
1	PP	43.580	-29.55	-26.91	-13.00	-16.55	-2.64	Peak	Vertical
2		78.500	-49.46	-38.41	-13.00	-36.46	-11.05	Peak	Vertical
3		106.630	-52.18	-40.63	-13.00	-39.18	-11.55	Peak	Vertical
4		182.290	-69.83	-56.95	-13.00	-56.83	-12.88	Peak	Vertical
5		353.010	-70.45	-59.35	-13.00	-57.45	-11.10	Peak	Vertical
6		578.050	-68.20	-60.88	-13.00	-55.20	-7.32	Peak	Vertical

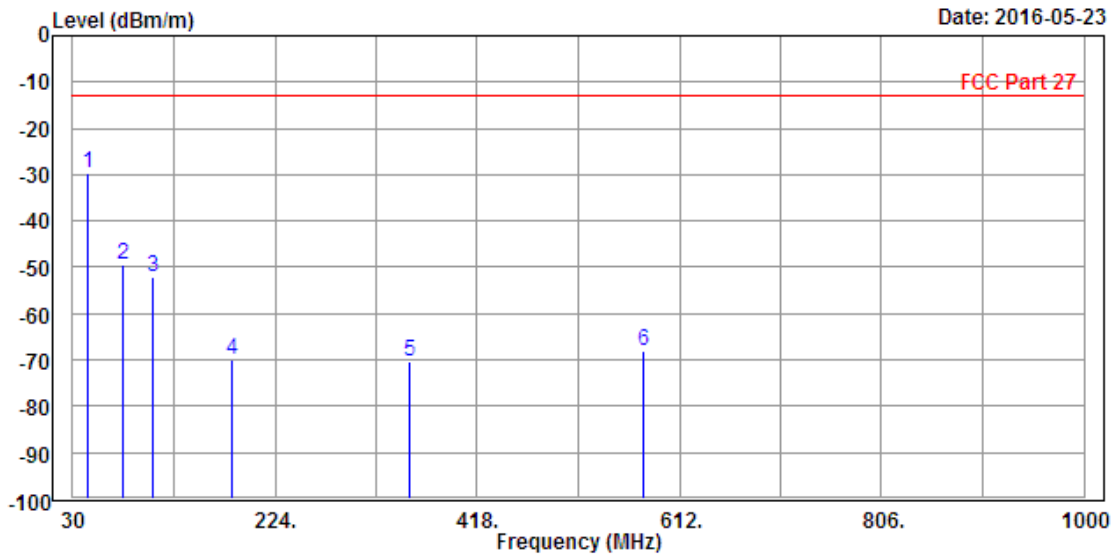



ABOVE 1GHz DATA

WCDMA Band IV:

<b>MODE</b>	TX channel 1413	<b>FREQUENCY RANGE</b>	Above 1000MHz
<b>ENVIRONMENTAL CONDITIONS</b>	26deg. C, 56%RH	<b>INPUT POWER</b>	DC 5V from adapter
<b>TESTED BY</b>	Alex Chen		
<b>ANTENNA POLARITY &amp; TEST DISTANCE: HORIZONTAL AT 3 M</b>			

	Freq	Level	Read Level	Limit Line	Over Limit	Factor	Remark	Pol/Phase
	MHz	dBm/m	dBm	dBm/m	dB	dB/m		
1	3470.000	-51.95	-54.00	-13.00	-38.95	2.05	Peak	Horizontal
2 PP	5186.000	-45.65	-54.24	-13.00	-32.65	8.59	Peak	Horizontal

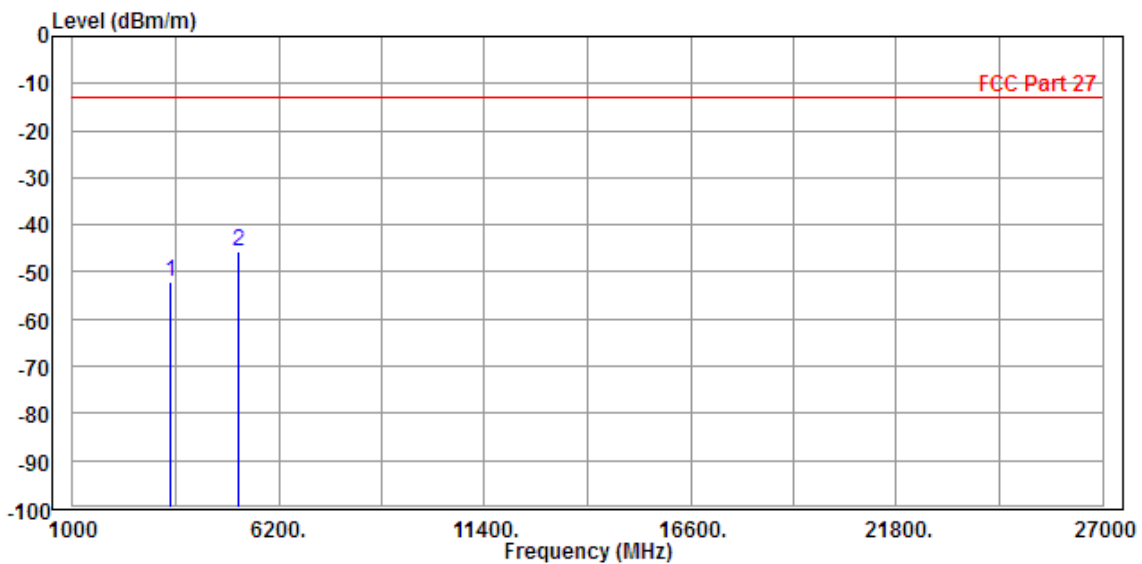



<b>MODE</b>	TX channel 1413	<b>FREQUENCY RANGE</b>	Above 1000MHz
<b>ENVIRONMENTAL CONDITIONS</b>	26deg. C, 56%RH	<b>INPUT POWER</b>	DC 5V from adapter
<b>TESTED BY</b>	Alex Chen		
<b>ANTENNA POLARITY &amp; TEST DISTANCE: VERTICAL AT 3 M</b>			

	Freq	Level	Read Level	Limit Line	Over Limit	Factor	Remark	Pol/Phase
	MHz	dBm/m	dBm	dBm/m	dB	dB/m		
1	3470.000	-52.42	-54.95	-13.00	-39.42	2.53	Peak	Vertical
2	PP 5197.500	-47.26	-55.24	-13.00	-34.26	7.98	Peak	Vertical

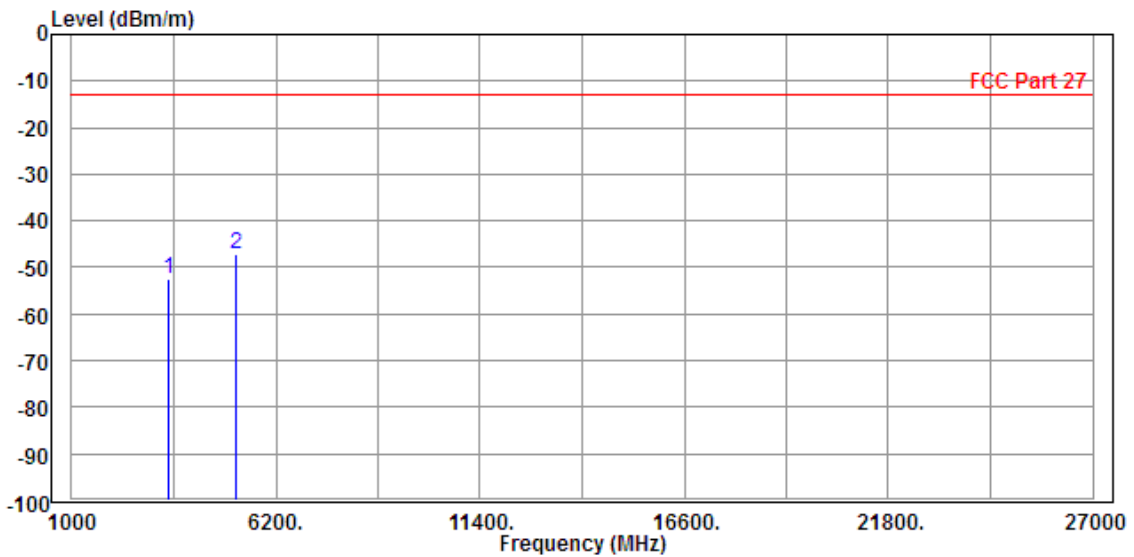

**LTE BAND 4**

**CHANNEL BANDWIDTH: 1.4MHz / QPSK**

<b>MODE</b>	TX channel 20175	<b>FREQUENCY RANGE</b>	Above 1000MHz
<b>ENVIRONMENTAL CONDITIONS</b>	26deg. C, 56%RH	<b>INPUT POWER</b>	DC 5V from adapter
<b>TESTED BY</b>	Alex Chen		
<b>ANTENNA POLARITY &amp; TEST DISTANCE: HORIZONTAL AT 3 M</b>			

	Freq	Level	Read Level	Limit Line	Over Limit	Factor	Remark	Pol/Phase
	MHz	dBm/m	dBm	dBm/m	dB	dB/m		
1	3465.000	-53.62	-55.65	-13.00	-40.62	2.03	Peak	Horizontal
2	PP 5197.500	-46.86	-55.47	-13.00	-33.86	8.61	Peak	Horizontal

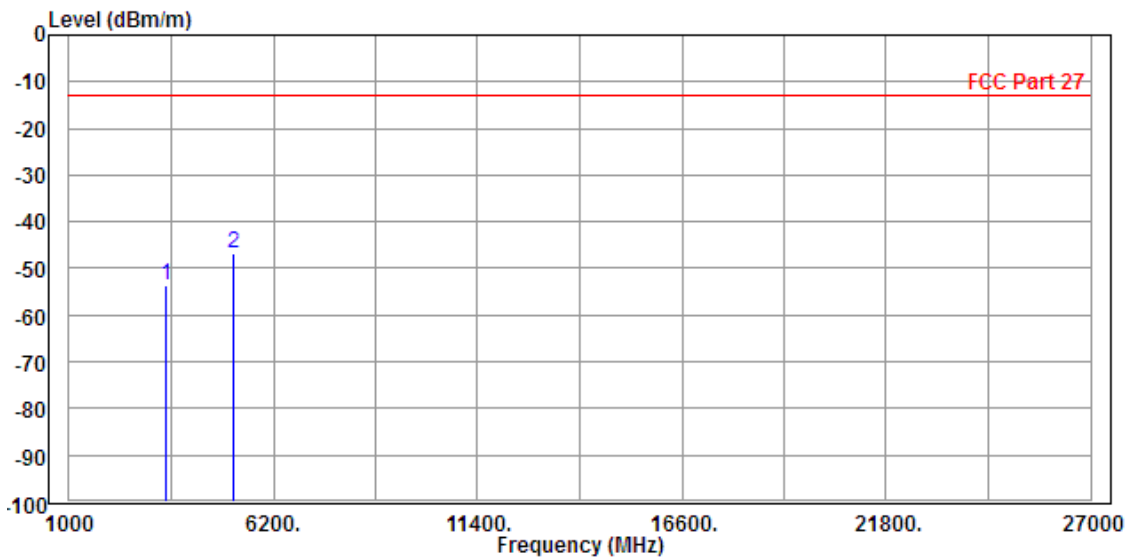



<b>MODE</b>	TX channel 20175	<b>FREQUENCY RANGE</b>	Above 1000MHz
<b>ENVIRONMENTAL CONDITIONS</b>	26deg. C, 56%RH	<b>INPUT POWER</b>	DC 5V from adapter
<b>TESTED BY</b>	Alex Chen		
<b>ANTENNA POLARITY &amp; TEST DISTANCE: VERTICAL AT 3 M</b>			

	Freq	Level	Read Level	Limit Line	Over Limit	Factor	Remark	Pol/Phase
	MHz	dBm/m	dBm	dBm/m	dB	dB/m		
1	3470.000	-53.96	-56.49	-13.00	-40.96	2.53	Peak	Vertical
2 PP	5197.500	-48.52	-56.50	-13.00	-35.52	7.98	Peak	Vertical

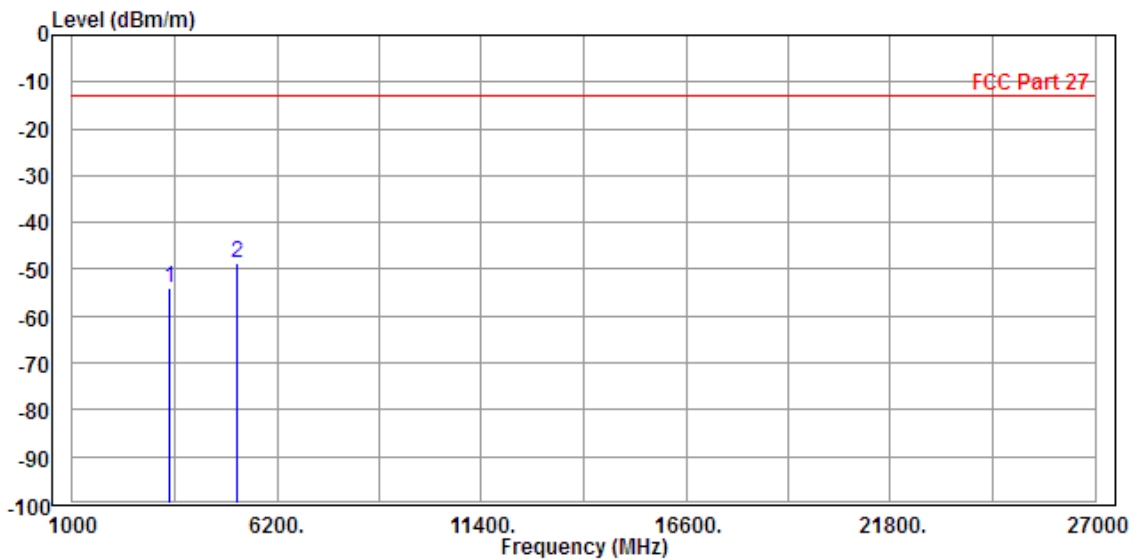



**CHANNEL BANDWIDTH: 3MHz / QPSK**

<b>MODE</b>	TX channel 20175	<b>FREQUENCY RANGE</b>	Above 1000MHz
<b>ENVIRONMENTAL CONDITIONS</b>	26deg. C, 56%RH	<b>INPUT POWER</b>	DC 5V from adapter
<b>TESTED BY</b>	Alex Chen		
<b>ANTENNA POLARITY &amp; TEST DISTANCE: HORIZONTAL AT 3 M</b>			

	Freq	Level	Read Level	Limit Line	Over Limit	Factor	Remark	Pol/Phase
	MHz	dBm/m	dBm	dBm/m	dB	dB/m		
1	3470.000	-53.76	-55.81	-13.00	-40.76	2.05	Peak	Horizontal
2 PP	5197.500	-46.19	-54.80	-13.00	-33.19	8.61	Peak	Horizontal

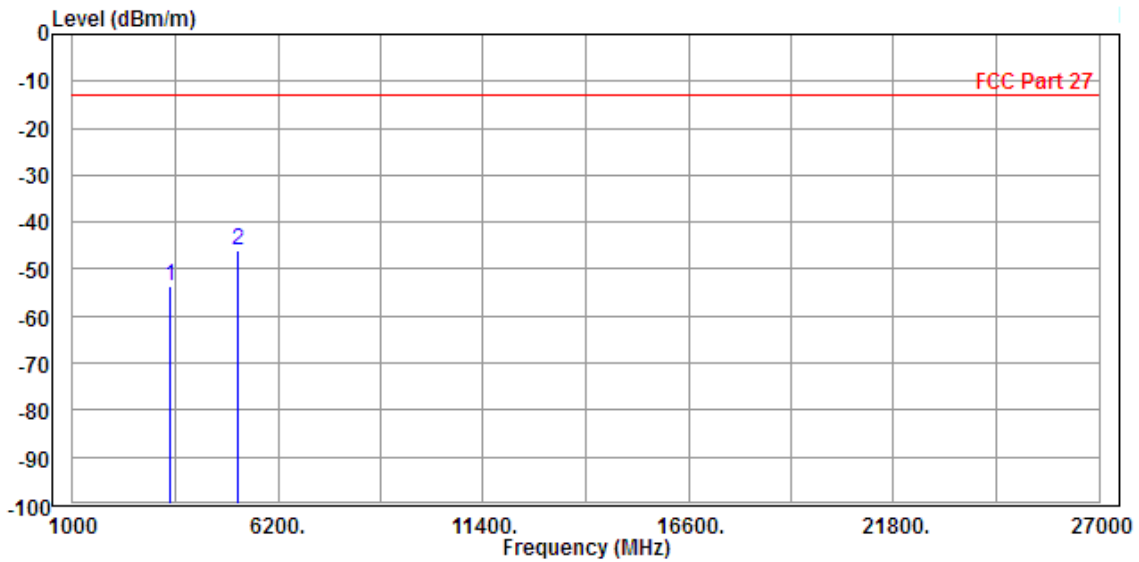

<b>MODE</b>	TX channel 20175	<b>FREQUENCY RANGE</b>	Above 1000MHz
<b>ENVIRONMENTAL CONDITIONS</b>	26deg. C, 56%RH	<b>INPUT POWER</b>	DC 5V from adapter
<b>TESTED BY</b>	Alex Chen		
<b>ANTENNA POLARITY &amp; TEST DISTANCE: VERTICAL AT 3 M</b>			

	Freq	Level	Read Level	Limit Line	Over Limit	Factor	Remark	Pol/Phase
	MHz	dBm/m	dBm	dBm/m	dB	dB/m		
1	3465.000	-51.81	-54.34	-13.00	-38.81	2.53	Peak	Vertical
2 PP	5197.500	-44.34	-52.32	-13.00	-31.34	7.98	Peak	Vertical

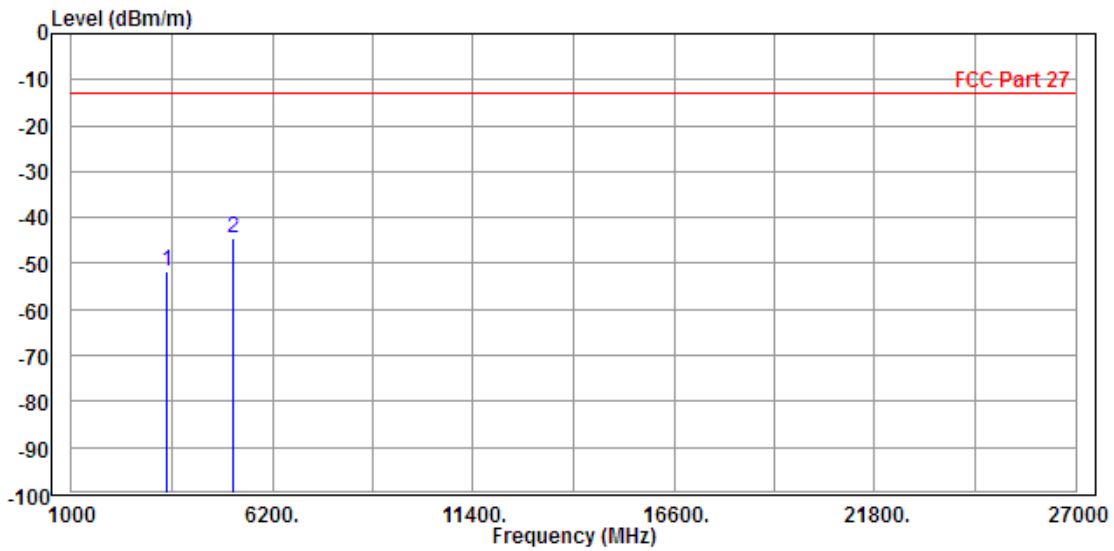

**CHANNEL BANDWIDTH: 5MHz / QPSK**

<b>MODE</b>	TX channel 20175	<b>FREQUENCY RANGE</b>	Above 1000MHz
<b>ENVIRONMENTAL CONDITIONS</b>	26deg. C, 56%RH	<b>INPUT POWER</b>	DC 5V from adapter
<b>TESTED BY</b>	Alex Chen		
<b>ANTENNA POLARITY &amp; TEST DISTANCE: HORIZONTAL AT 3 M</b>			

	Freq	Level	Read Level	Limit Line	Over Limit	Factor	Remark	Pol/Phase
	MHz	dBm/m	dBm	dBm/m	dB	dB/m		
1	3465.000	-54.94	-56.97	-13.00	-41.94	2.03	Peak	Horizontal
2 PP	5197.500	-48.15	-56.76	-13.00	-35.15	8.61	Peak	Horizontal

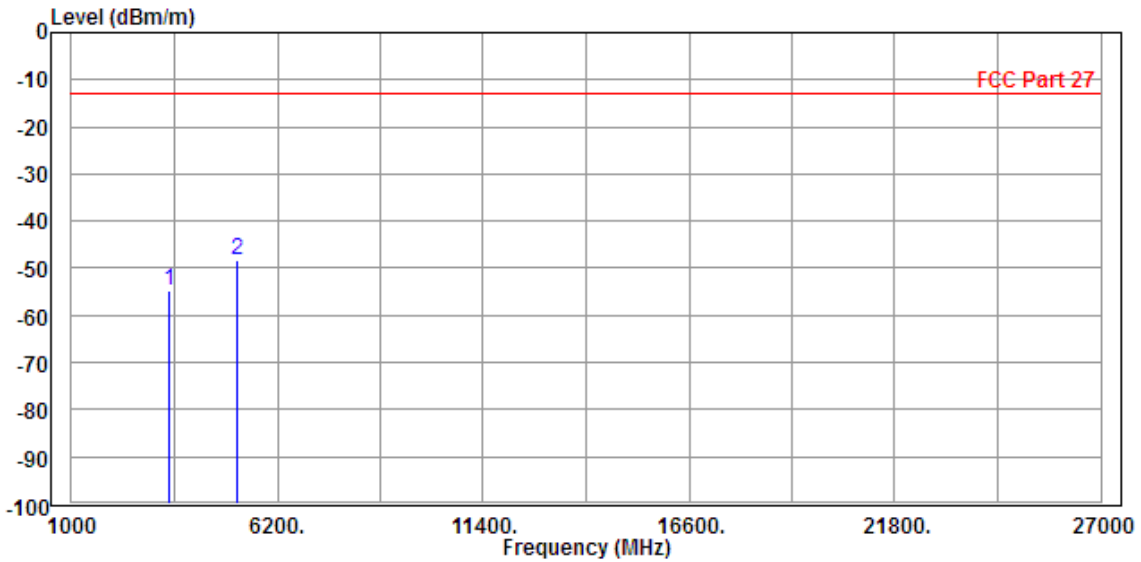

<b>MODE</b>	TX channel 20175	<b>FREQUENCY RANGE</b>	Above 1000MHz
<b>ENVIRONMENTAL CONDITIONS</b>	26deg. C, 56%RH	<b>INPUT POWER</b>	DC 5V from adapter
<b>TESTED BY</b>	Alex Chen		
<b>ANTENNA POLARITY &amp; TEST DISTANCE: VERTICAL AT 3 M</b>			

	Freq	Level	Read Level	Limit Line	Over Limit	Factor	Remark	Pol/Phase
	MHz	dBm/m	dBm	dBm/m	dB	dB/m		
1	3470.000	-54.50	-57.03	-13.00	-41.50	2.53	Peak	Vertical
2 PP	5197.500	-48.74	-56.72	-13.00	-35.74	7.98	Peak	Vertical

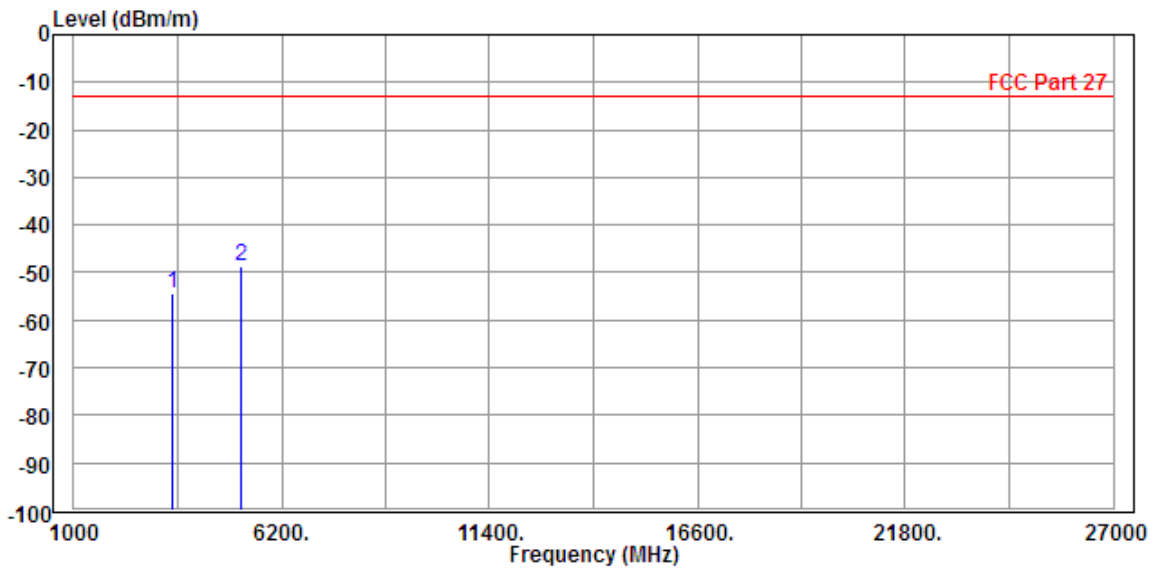

**CHANNEL BANDWIDTH: 10MHz / QPSK**

<b>MODE</b>	TX channel 20175	<b>FREQUENCY RANGE</b>	Above 1000MHz
<b>ENVIRONMENTAL CONDITIONS</b>	26deg. C, 56%RH	<b>INPUT POWER</b>	DC 5V from adapter
<b>TESTED BY</b>	Alex Chen		
<b>ANTENNA POLARITY &amp; TEST DISTANCE: HORIZONTAL AT 3 M</b>			

	Freq	Level	Read Level	Limit	Over Limit	Factor	Remark	Pol/Phase
	MHz	dBm/m	dBm	dBm/m	dB	dB/m		
1	3470.000	-57.18	-59.23	-13.00	-44.18	2.05	Peak	Horizontal
2 PP	5197.500	-49.23	-57.84	-13.00	-36.23	8.61	Peak	Horizontal

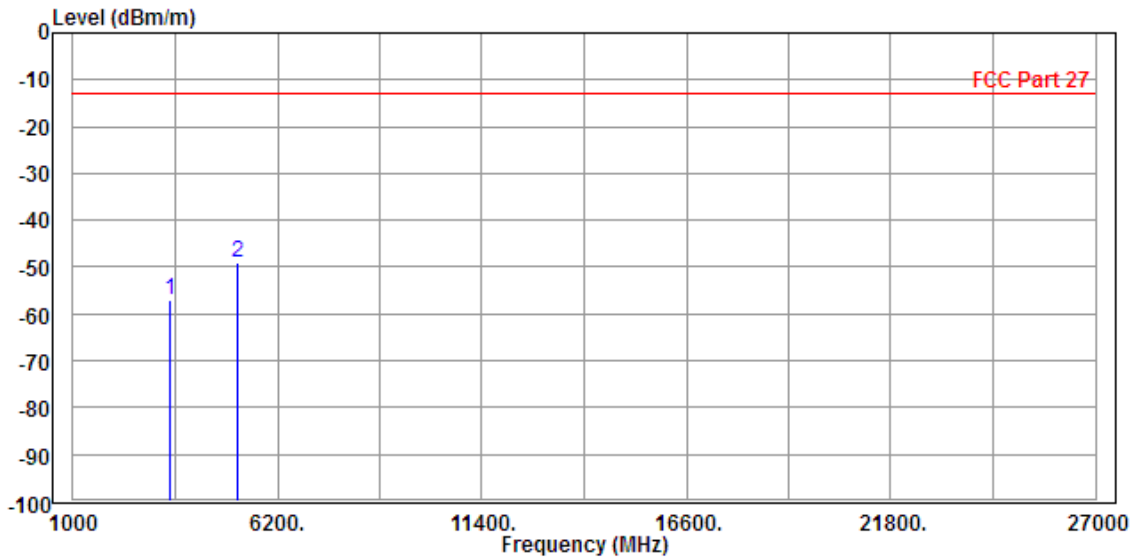

<b>MODE</b>	TX channel 20175	<b>FREQUENCY RANGE</b>	Above 1000MHz
<b>ENVIRONMENTAL CONDITIONS</b>	26deg. C, 56%RH	<b>INPUT POWER</b>	DC 5V from adapter
<b>TESTED BY</b>	Alex Chen		
<b>ANTENNA POLARITY &amp; TEST DISTANCE: VERTICAL AT 3 M</b>			

	Freq	Level	Read Level	Limit Line	Over Limit	Factor	Remark	Pol/Phase
	MHz	dBm/m	dBm	dBm/m	dB	dB/m		
1	3470.000	-53.43	-55.96	-13.00	-40.43	2.53	Peak	Vertical
2	PP 5197.500	-47.06	-55.04	-13.00	-34.06	7.98	Peak	Vertical

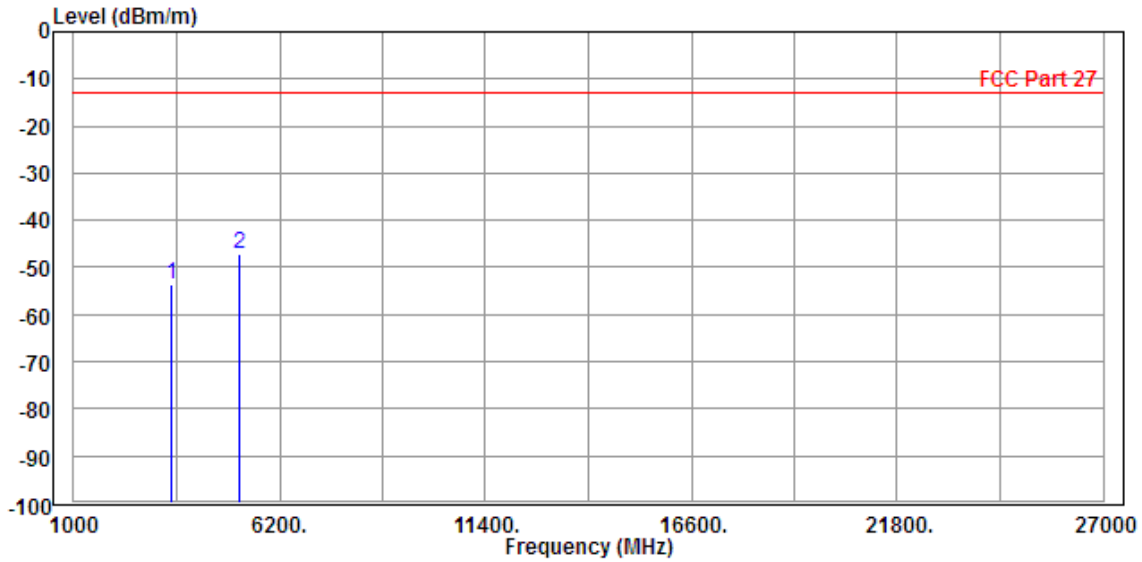

**CHANNEL BANDWIDTH: 15MHz / QPSK**

<b>MODE</b>	TX channel 20175	<b>FREQUENCY RANGE</b>	Above 1000MHz
<b>ENVIRONMENTAL CONDITIONS</b>	26deg. C, 56%RH	<b>INPUT POWER</b>	DC 5V from adapter
<b>TESTED BY</b>	Alex Chen		
<b>ANTENNA POLARITY &amp; TEST DISTANCE: HORIZONTAL AT 3 M</b>			

	Freq	Level	Read Level	Limit Line	Over Limit	Factor	Remark	Pol/Phase
	MHz	dBm/m	dBm	dBm/m	dB	dB/m		
1	3470.000	-54.08	-56.13	-13.00	-41.08	2.05	Peak	Horizontal
2 PP	5197.500	-47.83	-56.44	-13.00	-34.83	8.61	Peak	Horizontal

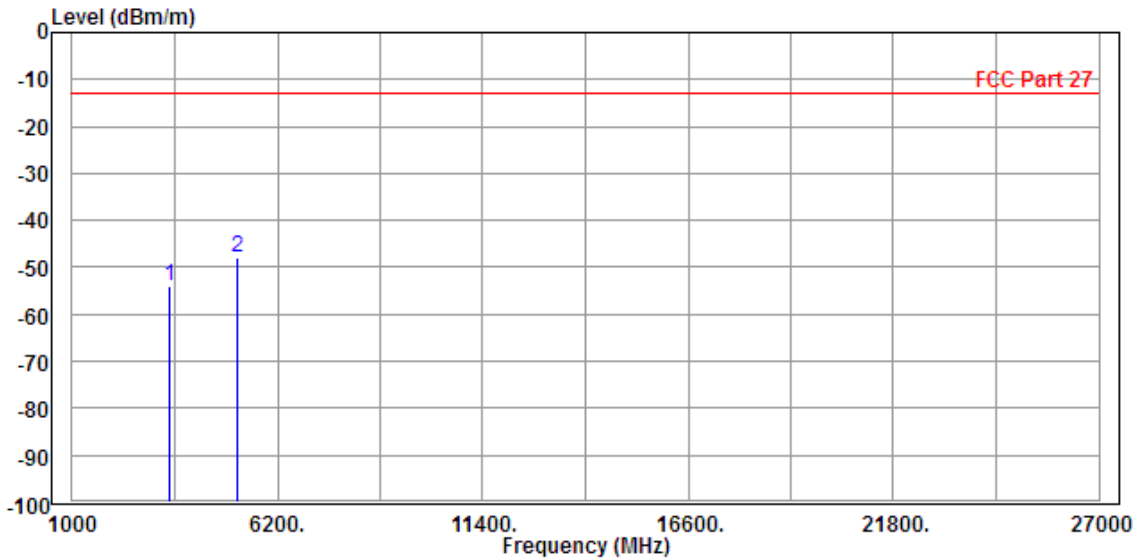

<b>MODE</b>	TX channel 20175	<b>FREQUENCY RANGE</b>	Above 1000MHz
<b>ENVIRONMENTAL CONDITIONS</b>	26deg. C, 56%RH	<b>INPUT POWER</b>	DC 5V from adapter
<b>TESTED BY</b>	Alex Chen		
<b>ANTENNA POLARITY &amp; TEST DISTANCE: VERTICAL AT 3 M</b>			

	Freq	Level	Read Level	Limit Line	Over Limit	Factor	Remark	Pol/Phase
	MHz	dBm/m	dBm	dBm/m	dB	dB/m		
1	3470.000	-52.30	-54.83	-13.00	-39.30	2.53	Peak	Vertical
2 PP	5197.500	-46.45	-54.43	-13.00	-33.45	7.98	Peak	Vertical

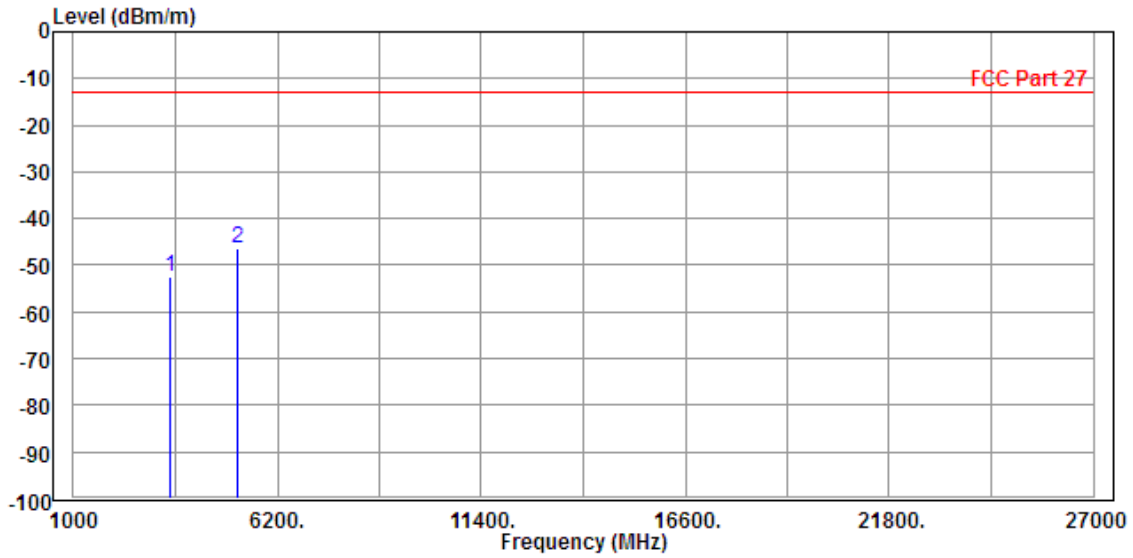



**CHANNEL BANDWIDTH: 20MHz / QPSK**

<b>MODE</b>	TX channel 20175	<b>FREQUENCY RANGE</b>	Above 1000MHz
<b>ENVIRONMENTAL CONDITIONS</b>	26deg. C, 56%RH	<b>INPUT POWER</b>	DC 5V from adapter
<b>TESTED BY</b>	Alex Chen		
<b>ANTENNA POLARITY &amp; TEST DISTANCE: HORIZONTAL AT 3 M</b>			

	Freq	Level	Read Level	Limit Line	Over Limit	Factor	Remark	Pol/Phase
	MHz	dBm/m	dBm	dBm/m	dB	dB/m		
1	3470.000	-54.95	-57.00	-13.00	-41.95	2.05	Peak	Horizontal
2 PP	5197.500	-45.84	-54.45	-13.00	-32.84	8.61	Peak	Horizontal

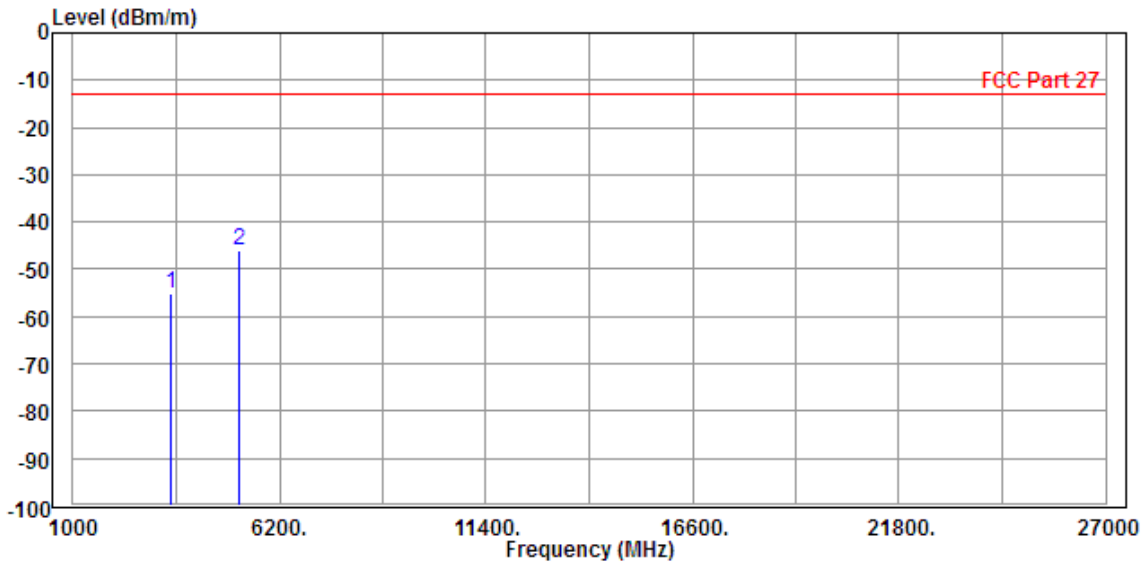

<b>MODE</b>	TX channel 20175	<b>FREQUENCY RANGE</b>	Above 1000MHz
<b>ENVIRONMENTAL CONDITIONS</b>	26deg. C, 56%RH	<b>INPUT POWER</b>	DC 5V from adapter
<b>TESTED BY</b>	Alex Chen		
<b>ANTENNA POLARITY &amp; TEST DISTANCE: VERTICAL AT 3 M</b>			

	Freq	Level	Read Level	Limit Line	Over Limit	Factor	Remark	Pol/Phase
	MHz	dBm/m	dBm	dBm/m	dB	dB/m		
1	3470.000	-56.19	-58.72	-13.00	-43.19	2.53	Peak	Vertical
2 PP	5197.500	-50.39	-58.37	-13.00	-37.39	7.98	Peak	Vertical

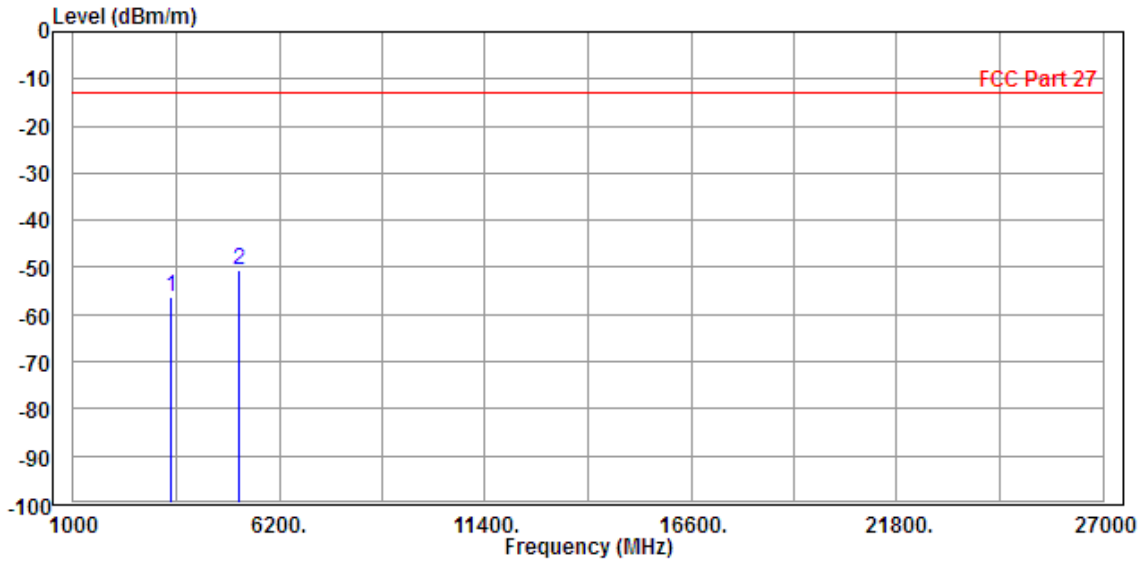



## 5 Pictures of Test Arrangements

Please refer to the attached file (Test Setup Photo).

## Appendix – Information on the Testing Laboratories

We, Bureau Veritas Consumer Products Services (H.K.) Ltd., Taoyuan Branch, were founded in 1988 to provide our best service in EMC, Radio, Telecom and Safety consultation. Our laboratories are accredited and approved according to ISO/IEC 17025.

If you have any comments, please feel free to contact us at the following:

**Linko EMC/RF Lab**

Tel: 886-2-26052180

Fax: 886-2-26051924

**Hsin Chu EMC/RF Lab/Telecom Lab**

Tel: 886-3-5935343

Fax: 886-3-5935342

**Hwa Ya EMC/RF/Safety**

Tel: 886-3-3183232

Fax: 886-3-3270892

**Email:** [service.adt@tw.bureauveritas.com](mailto:service.adt@tw.bureauveritas.com)

**Web Site:** [www.bureauveritas-adt.com](http://www.bureauveritas-adt.com)

The address and road map of all our labs can be found in our web site also.

--- END ---