

FCC TEST REPORT (WLAN)

Report No.: RF160512W002-2

FCC ID: YCNA2016B30

Test Model: Lenovo A2016b30

Received Date: May 18, 2016

Test Date: May 21, 2016 ~ Jun. 21, 2016

Issued Date: Jun. 23, 2016

Applicant: Lenovo Mobile Communication Technology Ltd.

Address: No.999, Qishan North 2nd Road, Information & Optoelectronics Park, Torch Hi-tech Industry Development Zone, Xiamen, P.R.China

Issued By: Bureau Veritas Consumer Products Services (H.K.) Ltd., Taoyuan Branch

Lab Address: No. 47-2, 14th Ling, Chia Cau Vil., Lin Kou Dist., New Taipei City, Taiwan (R.O.C.)

Test Location: No. 19, Hwa Ya 2nd Rd., Wen Hwa Tsuen, Kwei Shan Hsiang, Taoyuan Hsien 333, Taiwan, R.O.C.

This report should not be used by the client to claim product certification, approval, or endorsement by TAF or any government agencies.



This report is for your exclusive use. Any copying or replication of this report to or for any other person or entity, or use of our name or trademark, is permitted only with our prior written permission. This report sets forth our findings solely with respect to the test samples identified herein. The results set forth in this report are not indicative or representative of the quality or characteristics of the lot from which a test sample was taken or any similar or identical product specifically and expressly noted. Our report includes all of the tests requested by you and the results thereof based upon the information that you provided to us. You have 60 days from date of issuance of this report to notify us of any material error or omission caused by our negligence, provided, however, that such notice shall be in writing and shall specifically address the issue you wish to raise. A failure to raise such issue within the prescribed time shall constitute your unqualified acceptance of the completeness of this report, the tests conducted and the correctness of the report contents. Unless specific mention, the uncertainty of measurement has been explicitly taken into account to declare the compliance or non-compliance to the specification. The report must not be used by the client to claim product certification, approval, or endorsement by TAF or any government agencies.

TABLE OF CONTENTS

RELEASE CONTROL RECORD	4
1 Certificate of Conformity.....	5
2 Summary of Test Results	6
2.1 Measurement Uncertainty	6
3 General Information.....	7
3.1 General Description of EUT	7
3.2 Description of Test Modes	9
3.2.1 Test Mode Applicability and Tested Channel Detail.....	10
3.3 Duty Cycle of Test Signal	12
3.4 Description of Support Units	13
3.4.1 Configuration of System under Test	13
3.5 General Description of Applied Standards	13
4 Test Types and Results	14
4.1 Radiated Emission and Bandedge Measurement.....	14
4.1.1 Limits of Radiated Emission and Bandedge Measurement	14
4.1.2 Test Instruments	15
4.1.3 Test Procedures.....	16
4.1.4 Deviation from Test Standard	16
4.1.5 Test Set Up	17
4.1.6 EUT Operating Conditions.....	17
4.1.7 Test Results	18
4.2 Conducted Emission Measurement	31
4.2.1 Limits of Conducted Emission Measurement	31
4.2.2 Test Instruments	31
4.2.3 Test Procedures.....	32
4.2.4 Deviation from Test Standard	32
4.2.5 Test Setup.....	32
4.2.6 EUT Operating Conditions.....	32
4.2.7 Test Results	33
4.3 6dB Bandwidth Measurement	35
4.3.1 Limits of 6dB Bandwidth Measurement.....	35
4.3.2 Test Setup.....	35
4.3.3 Test Instruments	35
4.3.4 Test Procedure	35
4.3.5 Deviation from Test Standard	35
4.3.6 EUT Operating Conditions.....	35
4.3.7 Test Result.....	36
4.4 Conducted Output Power Measurement.....	38
4.4.1 Limits of Conducted Output Power Measurement	38
4.4.2 Test Setup.....	38
4.4.3 Test Instruments	38
4.4.4 Test Procedures.....	38
4.4.5 Deviation from Test Standard	38
4.4.6 EUT Operating Conditions.....	38
4.4.7 Test Results	39
4.4.7.1 Maximum Peak Output Power	39
4.4.7.2 Average Output Power (For Reference)	40
4.5 Power Spectral Density Measurement.....	41
4.5.1 Limits of Power Spectral Density Measurement	41
4.5.2 Test Setup.....	41
4.5.3 Test Instruments	41
4.5.4 Test Procedure	41
4.5.5 Deviation from Test Standard	41

4.5.6 EUT Operating Condition	41
4.5.7 Test Results	42
4.6 Conducted Out of Band Emission Measurement	44
4.6.1 Limits of Conducted Out of Band Emission Measurement.....	44
4.6.2 Test Setup.....	44
4.6.3 Test Instruments	44
4.6.4 Test Procedure	44
4.6.5 Deviation from Test Standard	44
4.6.6 EUT Operating Condition	44
4.6.7 Test Results	45
5 Pictures of Test Arrangements.....	49
Appendix – Information on the Testing Laboratories	50



A D T

RELEASE CONTROL RECORD

ISSUE NO.	REASON FOR CHANGE	DATE ISSUED
RF160512W002-2	Original release	Jun. 23, 2016

1 Certificate of Conformity

Product: Mobile Phone
Brand: Lenovo
Test Model: Lenovo A2016b30
Sample Status: Identical Prototype
Applicant: Lenovo Mobile Communication Technology Ltd.
Test Date: May 21, 2016 ~ Jun. 21, 2016
Standards: **FCC Part 15, Subpart C (Section 15.247)**
ANSI C63.10: 2013

The above equipment has been tested by **Bureau Veritas Consumer Products Services (H.K.) Ltd., Taoyuan Branch**, and found compliance with the requirement of the above standards. The test record, data evaluation & Equipment Under Test (EUT) configurations represented herein are true and accurate accounts of the measurements of the sample's EMC characteristics under the conditions specified in this report.

Prepared by :  _____, **Date:** Jun. 23, 2016
Amyee Qian / Engineer

Approved by :  _____, **Date:** Jun. 23, 2016
William Chung / Manager

2 Summary of Test Results

FCC Part 15, Subpart C (SECTION 15.247)			
FCC Clause	Test Item	Result	Remarks
15.207	AC Power Conducted Emission	PASS	Meet the requirement of limit. Minimum passing margin is 7.03dB at 0.158000MHz.
15.205 & 15.209	Band Edge Emission Measurement	PASS	Meet the requirement of limit. Minimum passing margin is -4.24dB at 44.55MHz.
15.247(d)	Antenna Port Emission	PASS	Meet the requirement of limit.
15.247(a)(2)	6dB bandwidth	PASS	Meet the requirement of limit.
15.247(b)	Conducted power	PASS	Meet the requirement of limit.
15.247(e)	Power Spectral Density	PASS	Meet the requirement of limit.
15.203	Antenna Requirement	PASS	No antenna connector is used.

2.1 Measurement Uncertainty

Where relevant, the following measurement uncertainty levels have been estimated for tests performed on the EUT as specified in CISPR 16-4-2:

Measurement	Frequency	Expanded Uncertainty (k=2) (\pm)
Conducted Emissions at mains ports	9kHz ~ 30MHz	2.44 dB
Radiated Emissions up to 1 GHz	9KHZ ~ 30MHZ	2.74 dB
	30MHz ~ 200MHz	2.93 dB
	200MHz ~ 1000MHz	2.95 dB
Radiated Emissions above 1 GHz	1GHz ~ 18GHz	2.26 dB
	18GHz ~ 40GHz	1.94 dB

This uncertainty represents an expanded uncertainty expressed at approximately the 95% confidence level using a coverage factor of $k = 2$.

3 General Information

3.1 General Description of EUT

Product	Mobile Phone
Brand	Lenovo
Test Model	Lenovo A2016b30
Power Supply Rating	5.0Vdc (adapter or host equipment) 3.8Vdc (battery)
Modulation Technology	DSSS, OFDM
Modulation Type	CCK, DQPSK, DBPSK for DSSS 64QAM, 16QAM, QPSK, BPSK for OFDM
Transfer Rate	802.11b: 11/ 5.5/ 2.0 / 1.0 Mbps 802.11g: 54/ 48/ 36 / 24 / 18 / 9/ 6 Mbps 802.11n: up to 135 Mbps
Operating Frequency	2412 ~ 2462MHz for 11b/g/n(HT20) 2422 ~ 2452MHz for 11b/g/n(HT40)
Number of Channel	11 for 802.11b, 802.11g, 802.11n(20MHz) 7 for 802.11n(40MHz)
Output Power	106.905mW
Antenna Type	PIFA Antenna with -2.13dBi gain
Accessory Device	Refer to note as below
Data Cable Supplied	USB cable: non-shielded, detachable, 0.7m Earphone: non-shielded, detachable, 1.3m

Note:

1. The above EUT information is declared by manufacturer and for more detailed features description, please refer to the manufacturer's specifications or User's Manual.
2. There were Sample A and Sample B for this project, the difference is the color and configuration, as below:

SAMPLE	EUT CONFIGURATION INFORMATION
A (Black)	LCD panel 1+ Photo Camera 1+ Video Camera 1+ Main Broad 1
B (White)	LCD panel 2+ Photo Camera 2+ Video Camera 2+ Main Broad 2

3. For the test results, the EUT had been tested with all conditions. But only the worst case was shown in test report.

LIST OF ACCESSORIES:

ACCESSORIES	BRAND	MANUFACTURER	MODEL	SPECIFICATION
AC Adapter 1	Lenovo	CHENYANG	C-P56	I/P:100-240Vac, 130mA O/P:5.0Vdc, 1000mA
AC Adapter 2	Lenovo	Acbel	C-P56	I/P:100-240Vac, 130mA O/P:5.0Vdc, 1000mA
Battery 1	Lenovo	ATL	BL253	Rating: 3.8Vdc, 2000mAh
Battery 2	Lenovo	VK	BL253	Rating: 3.8Vdc, 2000mAh
USB Cable 1	Lenovo	FUKANGYUAN	F16W-05100070L	0.7m non-shielded cable w/o core
USB Cable 2	Lenovo	LIQI	L16W-05100070L	0.7m non-shielded cable w/o core
Earphone 1	Lenovo	TIANZHI	TJ101247A	1.3m non-shielded cable w/o core
Earphone 2	Lenovo	LIANYUN	TS990B-28AMS05-M	1.3m non-shielded cable w/o core
LCD Panel 1	HELITAI	--	QTB4D543	--
LCD Panel 1	TONGXINGDA	--	TXDT450SKP-73V6	--
Photo Camera 1	BOLIXIN	--	BLX2355H-AL732-F	--
Photo Camera 2	HUAQUAN	--	G6P2-AL732FHQ	--
Video Camera 1	QUNHUI	--	SHT6029B1S-1P0J0	--
Video Camera 2	HUAQUAN	--	G7B5-AL732BHQ	--
Main Broad 1	HUASHEN	--	AL732_MB_PCB_V2.0	--
Main Broad 2	YILIANDA	--	AL732_MB_PCB_V2.0	--
BT/WLAN Module	MTK	--	MT6625L	--
WWAN Module	N/A	--	N/A	--

3.2 Description of Test Modes

11 channels are provided for 802.11b, 802.11g and 802.11n (HT20):

Channel	Frequency	Channel	Frequency
1	2412MHz	7	2442MHz
2	2417MHz	8	2447MHz
3	2422MHz	9	2452MHz
4	2427MHz	10	2457MHz
5	2432MHz	11	2462MHz
6	2437MHz		

7 channels are provided for 802.11n (HT40):

Channel	Frequency	Channel	Frequency
3	2422MHz	7	2442MHz
4	2427MHz	8	2447MHz
5	2432MHz	9	2452MHz
6	2437MHz		

3.2.1 Test Mode Applicability and Tested Channel Detail

EUT CONFIGURE MODE	APPLICABLE TO				DESCRIPTION
	RE≥1G	RE<1G	PLC	APCM	
-	√	√	√	√	-

Where **RE≥1G**: Radiated Emission above 1GHz & Bandedge Measurement
RE<1G: Radiated Emission below 1GHz
PLC: Power Line Conducted Emission
APCM: Antenna Port Conducted Measurement

NOTE: The EUT had been pre-tested on the positioned of each 3 axis. The worst case was found when positioned on **Y-plane**.
NOTE: “-” means no effect.

Radiated Emission Test (Above 1GHz):

- Pre-Scan has been conducted to determine the worst-case mode from all possible combinations between available modulations, data rates and antenna ports (if EUT with antenna diversity architecture).
- Following channel(s) was (were) selected for the final test as listed below.

EUT CONFIGURE MODE	MODE	AVAILABLE CHANNEL	TESTED CHANNEL	MODULATION TECHNOLOGY	MODULATION TYPE	DATA RATE (Mbps)
-	802.11b	1 to 11	1, 6, 11	DSSS	DBPSK	1.0
-	802.11g	1 to 11	1, 6, 11	OFDM	BPSK	6.0
-	802.11n (HT20)	1 to 11	1, 6, 11	OFDM	BPSK	7.2
-	802.11n (HT40)	3 to 9	3, 6, 9	OFDM	BPSK	15.0

Radiated Emission Test (Below 1GHz):

- Pre-Scan has been conducted to determine the worst-case mode from all possible combinations between available modulations, data rates and antenna ports (if EUT with antenna diversity architecture).
- Following channel(s) was (were) selected for the final test as listed below.

EUT CONFIGURE MODE	MODE	AVAILABLE CHANNEL	TESTED CHANNEL	MODULATION TECHNOLOGY	MODULATION TYPE	DATA RATE (Mbps)
-	802.11n (20MHz)	1 to 11	6	OFDM	BPSK	7.2

Power Line Conducted Emission Test:

- Pre-Scan has been conducted to determine the worst-case mode from all possible combinations between available modulations, data rates and antenna ports (if EUT with antenna diversity architecture).
- Following channel(s) was (were) selected for the final test as listed below.

EUT CONFIGURE MODE	MODE	AVAILABLE CHANNEL	TESTED CHANNEL	MODULATION TECHNOLOGY	MODULATION TYPE	DATA RATE (Mbps)
-	802.11b	1 to 11	1	DSSS	DBPSK	1.0

BANDEDGE MEASUREMENT:

Pre-Scan has been conducted to determine the worst-case mode from all possible combinations between available modulations, data rates and antenna ports (if EUT with antenna diversity architecture).

Following channel(s) was (were) selected for the final test as listed below.

EUT CONFIGURE MODE	MODE	AVAILABLE CHANNEL	TESTED CHANNEL	MODULATION TECHNOLOGY	MODULATION TYPE	DATA RATE (Mbps)
-	802.11b	1 to 11	1, 6, 11	DSSS	DBPSK	1.0
-	802.11g	1 to 11	1, 6, 11	OFDM	BPSK	6.0
-	802.11n (HT20)	1 to 11	1, 6, 11	OFDM	BPSK	7.2
-	802.11n (HT40)	3 to 9	3, 6, 9	OFDM	BPSK	15.0

Antenna Port Conducted Measurement:

This item includes all test value of each mode, but only includes spectrum plot of worst value of each mode.

Pre-Scan has been conducted to determine the worst-case mode from all possible combinations between available modulations, data rates and antenna ports (if EUT with antenna diversity architecture).

Following channel(s) was (were) selected for the final test as listed below.

EUT CONFIGURE MODE	MODE	AVAILABLE CHANNEL	TESTED CHANNEL	MODULATION TECHNOLOGY	MODULATION TYPE	DATA RATE (Mbps)
-	802.11b	1 to 11	1, 6, 11	DSSS	DBPSK	1.0
-	802.11g	1 to 11	1, 6, 11	OFDM	BPSK	6.0
-	802.11n (HT20)	1 to 11	1, 6, 11	OFDM	BPSK	7.2
-	802.11n (HT40)	3 to 9	3, 6, 9	OFDM	BPSK	15.0

Test Condition:

APPLICABLE TO	ENVIRONMENTAL CONDITIONS	INPUT POWER	TESTED BY
RE≥1G	25deg. C, 65%RH	120Vac, 60Hz	Alex Chen
RE<1G	25deg. C, 65%RH	120Vac, 60Hz	Alex Chen
PLC	25deg. C, 68%RH	120Vac, 60Hz	Yuqiang Yin
APCM	21deg. C, 60%RH	120Vac, 60Hz	Wenliang Wu

3.3 Duty Cycle of Test Signal

WIFI 2.4GHz

802.11b: Duty cycle = $0.079/0.085 = 0.929 < 98\%$, Duty factor = $10 * \log(1/0.929) = 0.320$

802.11g: Duty cycle = $0.078/0.093 = 0.839 < 98\%$, Duty factor = $10 * \log(1/0.839) = 0.762$

802.11n (HT20): Duty cycle = $0.040/0.047 = 0.851 < 98\%$, Duty factor = $10 * \log(1/0.851) = 0.701$

802.11n (HT40): Duty cycle = $0.006/0.011 = 0.545 < 98\%$, Duty factor = $10 * \log(1/0.545) = 2.636$

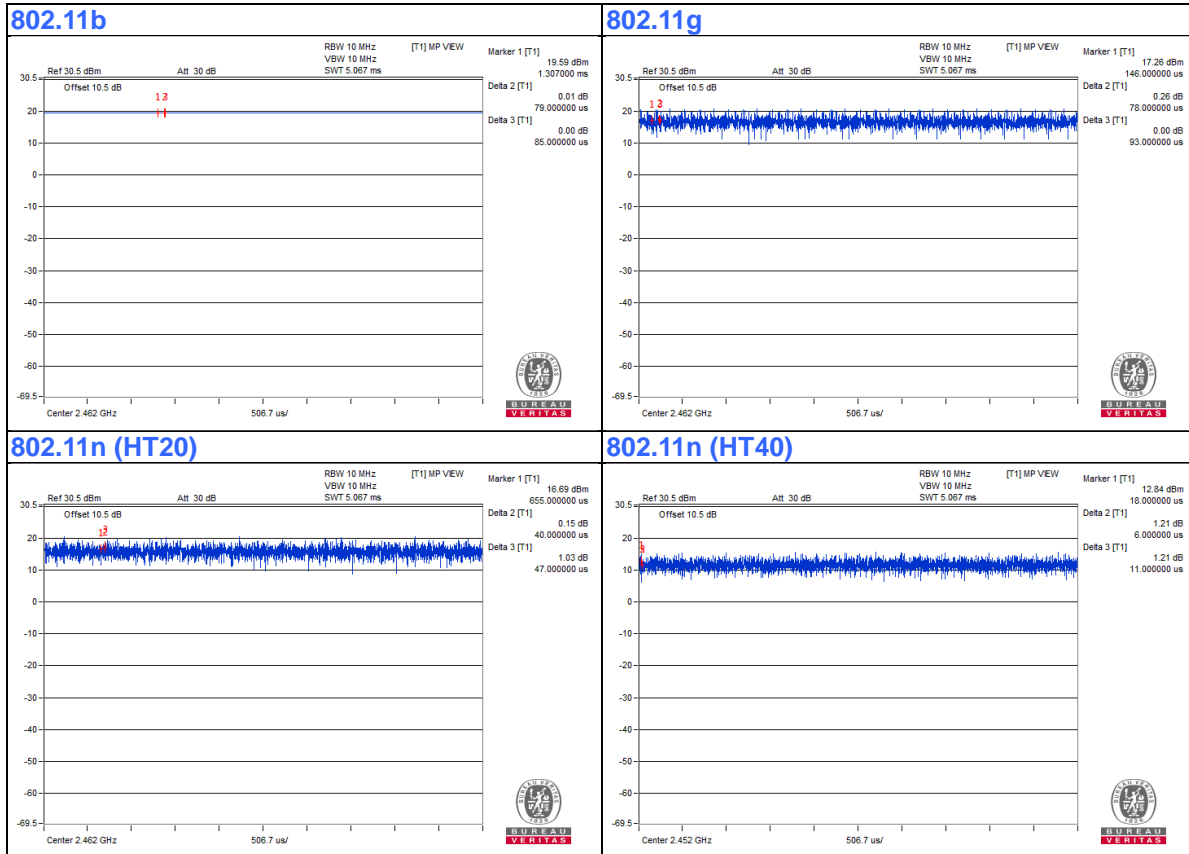

3.4 Description of Support Units

The EUT has been tested as an independent unit together with other necessary accessories or support units. The following support units or accessories were used to form a representative test configuration during the tests.

NO.	PRODUCT	BRAND	MODEL NO.	SERIAL NO.	FCC ID
1	DC source	LONG WEI	PS-6403D	010934269	N/A
2	PC	HP	A6608CN	3CR83825X3	N/A

NO.	SIGNAL CABLE DESCRIPTION OF THE ABOVE SUPPORT UNITS
1	DC Line: Unshielded, Detachable 1.0m
2	AC Line: Unshielded, Detachable 1.5m

3.4.1 Configuration of System under Test

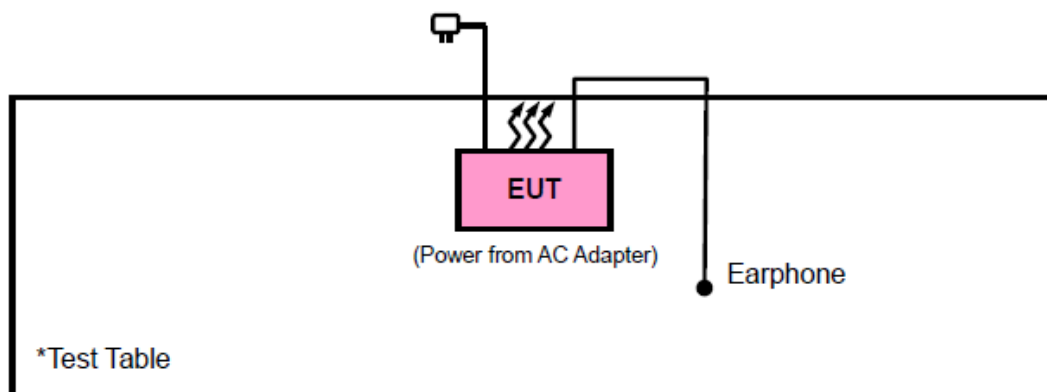

3.5 General Description of Applied Standards

The EUT is a RF Product. According to the specifications of the manufacturer, it must comply with the requirements of the following standards:

FCC Part 15, Subpart C (15.247)

KDB 558074 D01 DTS Meas Guidance v03r05

ANSI C63.10-2013

All test items have been performed and recorded as per the above standards.

NOTE: The EUT has been verified to comply with the requirements of FCC Part 15, Subpart B, Class B (Doc). The test report has been issued separately.

4 Test Types and Results

4.1 Radiated Emission and Bandedge Measurement

4.1.1 Limits of Radiated Emission and Bandedge Measurement

Radiated emissions which fall in the restricted bands must comply with the radiated emission limits specified as below table. Other emissions shall be at least 20dB below the highest level of the desired power:

Frequencies (MHz)	Field Strength (microvolts/meter)	Measurement Distance (meters)
0.009 ~ 0.490	2400/F(kHz)	300
0.490 ~ 1.705	24000/F(kHz)	30
1.705 ~ 30.0	30	30
30 ~ 88	100	3
88 ~ 216	150	3
216 ~ 960	200	3
Above 960	500	3

NOTE:

1. The lower limit shall apply at the transition frequencies.
2. Emission level (dBuV/m) = 20 log Emission level (uV/m).
3. For frequencies above 1000MHz, the field strength limits are based on average detector, however, the peak field strength of any emission shall not exceed the maximum permitted average limits, specified above by more than 20dB under any condition of modulation.

4.1.2 Test Instruments

Equipment	Manufacturer	Model No.	Serial No.	Last Cal.	Next Cal.
EMI Test Receiver	Rohde&Schwarz	ESR7	101494	Apr. 05,16	Apr. 04,17
Bilog Antenna	Teseq	CBL 6111D	30643	Jul. 16, 15	Jul. 15, 16
Loop Antenna	Daze	ZN30900A	0708	Dec. 30, 15	Dec. 29, 16
Horn Antenna (1GHz -18GHz)	ETS -Lindgren	3117	00062558	May 30, 14	May 29, 17
Amplifier	Burgeon	BPA-530	100220	Apr. 05,16	Apr. 04,17
Pre-Amplifier (18GHz-40GHz)	EMCI	EMC 184045	980102	Nov. 20,15	Nov. 19,17
Pre-Amplifier	HP	8449B	3008A00409	Apr. 25,15	Apr. 24,17
GPS Generator+ Antenna	TOJOIN	GNSS-5000A	E1-010119	Aug. 08, 14	Aug. 07, 16
3m Semi-anechoic Chamber	ETS-LINDGREN	9m*6m*6m	NSEMC003	Mar. 12,16	Mar. 11,18
Test Software	ADT	ADT_Radiated _V7.6.15.9.2	N/A	N/A	N/A

NOTE: 1. The calibration interval of the above test instruments is 12 months and the calibrations are traceable to NML/ROC and NIST/USA.

2. The calibration interval of the loop antenna is 24 months and the calibrations are traceable to NML/ROC and NIST/USA.

3. The test was performed in HwaYa Chamber 4.

4. The horn antenna and HP preamplifier (model: 8449B) are used only for the measurement of emission frequency above 1GHz if tested.

5. The FCC Site Registration No. is 460141.

6. The IC Site Registration No. is IC7450F-4.

4.1.3 Test Procedures

- a. The EUT was placed on the top of a rotating table 0.8 meters (for below 1GHz) / 1.5 meters (for above 1GHz) above the ground at 3 meter chamber room for test. The table was rotated 360 degrees to determine the position of the highest radiation.
- b. The EUT was set 3 meters away from the interference-receiving antenna, which was mounted on the top of a variable-height antenna tower.
- c. The height of antenna is varied from one meter to four meters above the ground to determine the maximum value of the field strength. Both horizontal and vertical polarizations of the antenna are set to make the measurement.
- d. For each suspected emission, the EUT was arranged to its worst case and then the antenna was tuned to heights from 1 meter to 4 meters and the rotatable table was turned from 0 degrees to 360 degrees to find the maximum reading.
- e. The test-receiver system was set to quasi-peak detect function and specified bandwidth with maximum hold mode when the test frequency is below 1 GHz.
- f. The test-receiver system was set to peak and average detect function and specified bandwidth with maximum hold mode when the test frequency is above 1 GHz. If the peak reading value also meets average limit, measurement with the average detector is unnecessary.

Note:

1. The resolution bandwidth and video bandwidth of test receiver/spectrum analyzer is 120kHz for Quasi-peak detection (QP) at frequency below 1GHz.
2. The resolution bandwidth of test receiver/spectrum analyzer is 1 MHz and the video bandwidth is 3 MHz for Peak detection (PK) at frequency above 1GHz.
3. The resolution bandwidth of test receiver/spectrum analyzer is 1MHz and the video bandwidth is 3MHz for RMS Average (Duty cycle < 98%) for Average detection (AV) at frequency above 1GHz, then the measurement results was added to a correction factor ($10 \log(1/\text{duty cycle})$).
4. The resolution bandwidth of test receiver/spectrum analyzer is 1MHz and the video bandwidth is 10Hz (Duty cycle $\geq 98\%$) for Average detection (AV) at frequency above 1GHz.
5. All modes of operation were investigated and the worst-case emissions are reported.

4.1.4 Deviation from Test Standard

No deviation.

4.1.5 Test Set Up

<Frequency Range below 1GHz>

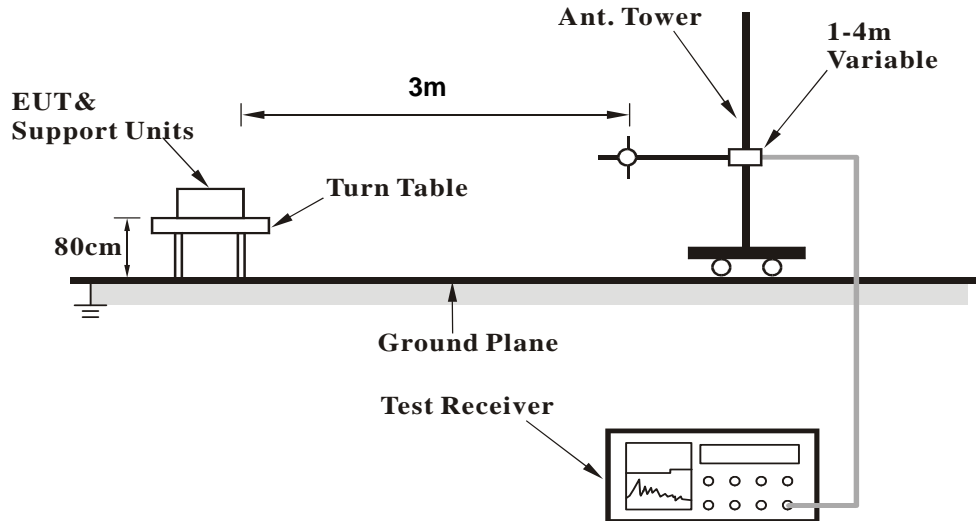

<Frequency Range above 1GHz>

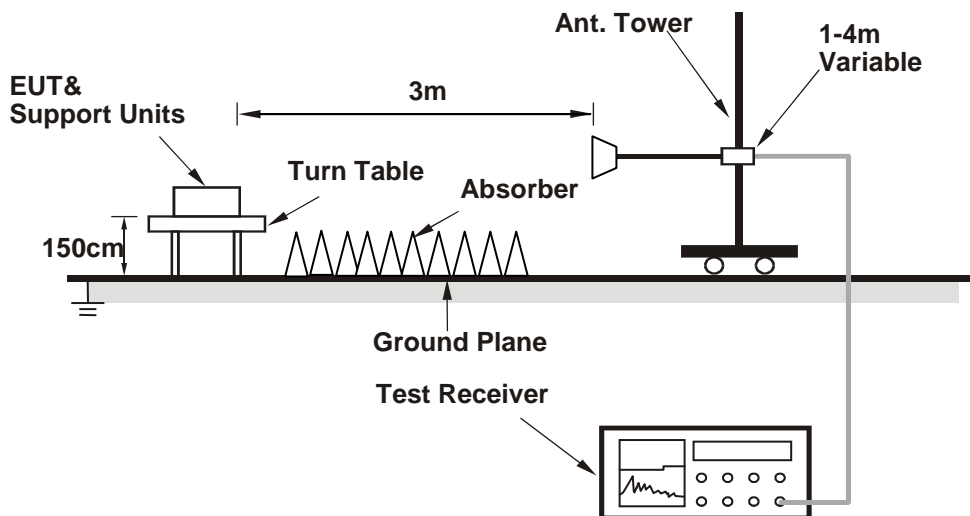

For the actual test configuration, please refer to the attached file (Test Setup Photo).

4.1.6 EUT Operating Conditions

- a. Placed the EUT on the testing table.
- b. Use the software to control the EUT under transmission condition continuously at specific channel frequency.

4.1.7 Test Results

BELOW 1GHz WORST-CASE DATA:

9 KHz – 30 MHz data: the amplitude of spurious emissions attenuated more than 20 dB below the permissible value is not required in the report.

30 MHz – 1GHz data:

CHANNEL	TX Channel 0	DETECTOR FUNCTION	Quasi-Peak (QP)
FREQUENCY RANGE	30MHz ~ 1GHz		

ANTENNA POLARITY & TEST DISTANCE: HORIZONTAL AT 3 M

FREQ. (MHz)	EMISSION LEVEL (dBuV/m)	READ LEVEL (dBuV)	MARGIN (dB)	LIMIT (dBuV/m)	ANTENNA FACTOR (dB /m)	CABLE LOSS (dB)	ANTENNA HEIGHT (cm)	TABLE ANGLE (Degree)	REMARK
30.00	21.14	39.35	-18.86	40.00	17.10	-35.31	101	312	QP
101.78	25.05	51.63	-18.45	43.50	7.94	-34.52	101	265	QP
167.74	21.83	45.75	-21.67	43.50	10.08	-34.00	101	224	QP
259.89	22.75	43.86	-23.25	46.00	12.52	-33.63	101	175	QP
377.26	16.93	33.99	-29.07	46.00	16.24	-33.30	101	98	QP
614.91	21.30	33.56	-24.70	46.00	20.72	-32.98	101	42	QP

ANTENNA POLARITY & TEST DISTANCE: VERTICAL AT 3 M

FREQ. (MHz)	EMISSION LEVEL (dBuV/m)	READ LEVEL (dBuV)	MARGIN (dB)	LIMIT (dBuV/m)	ANTENNA FACTOR (dB /m)	CABLE LOSS (dB)	ANTENNA HEIGHT (cm)	TABLE ANGLE (Degree)	REMARK
44.55	35.76	62.39	-4.24	40.00	8.52	-35.15	101	55	QP
98.87	23.91	50.58	-19.59	43.50	7.88	-34.55	101	89	QP
165.80	14.94	38.84	-28.56	43.50	10.11	-34.01	101	123	QP
220.12	16.80	39.57	-29.20	46.00	11.03	-33.80	101	267	QP
394.72	17.02	33.30	-28.98	46.00	16.98	-33.26	101	305	QP
681.84	23.82	34.06	-22.18	46.00	22.59	-32.83	101	112	QP

REMARKS:

- Emission Level = Read Level+ Antenna Factor + Cable Loss- Preamp Factor
Margin value = Emission level – Limit value.

ABOVE 1GHz WORST-CASE DATA:

802.11b

CHANNEL	TX Channel 1	DETECTOR FUNCTION	Peak (PK)
FREQUENCY RANGE	1GHz ~ 25GHz		Average (AV)

ANTENNA POLARITY & TEST DISTANCE: HORIZONTAL AT 3 M

FREQ. (MHz)	EMISSION LEVEL (dBuV/m)	READ LEVEL (dBuV)	LIMIT (dBuV/m)	MARGIN (dB)	ANTENNA FACTOR (dB /m)	CABLE LOSS (dB)	ANTENNA HEIGHT (cm)	TABLE ANGLE (Degree)	REMARK
2390	38.07	45.94	-15.93	54.00	32.29	8.15	130	125	Average
2390	49.34	57.21	-24.66	74.00	32.29	8.15	130	125	Peak
#2400	55.45	63.29	-21.92	77.37	32.30	8.17	130	125	Average
#2400	60.85	68.69	-18.56	79.41	32.30	8.17	130	125	Peak
2412	97.37	105.18			32.31	8.19	130	125	Average
2412	99.41	107.22			32.31	8.19	130	125	Peak
4824	46.04	48.01	-7.96	54.00	34.30	12.63	315	200	Average
4824	53.34	55.31	-20.66	74.00	34.30	12.63	315	200	Peak

ANTENNA POLARITY & TEST DISTANCE: VERTICAL AT 3 M

FREQ. (MHz)	EMISSION LEVEL (dBuV/m)	READ LEVEL (dBuV)	MARGIN (dB)	LIMIT (dBuV/m)	ANTENNA FACTOR (dB /m)	CABLE LOSS (dB)	ANTENNA HEIGHT (cm)	TABLE ANGLE (Degree)	REMARK
2390	37.76	45.63	-16.24	54.00	32.29	8.15	100	280	Average
2390	48.27	56.14	-25.73	74.00	32.29	8.15	100	280	Peak
#2400	53.89	61.73	-22.53	76.42	32.30	8.17	100	280	Average
#2400	58.81	66.65	-19.82	78.63	32.30	8.17	100	280	Peak
2412	96.42	104.23			32.31	8.19	100	280	Average
2412	98.63	106.44			32.31	8.19	100	280	Peak
4824	46.36	48.33	-7.64	54.00	34.30	12.63	100	40	Average
4824	53.21	55.18	-20.79	74.00	34.30	12.63	100	40	Peak

REMARKS:

1. Emission Level = Read Level+ Antenna Factor + Cable Loss- Preamp Factor
Margin value = Emission level – Limit value.
2. 2412MHz: Fundamental frequency.
3. " # ": The radiated frequency is out of the restricted band.

CHANNEL	TX Channel 6	DETECTOR FUNCTION	Peak (PK)
FREQUENCY RANGE	1GHz ~ 25GHz		Average (AV)

ANTENNA POLARITY & TEST DISTANCE: HORIZONTAL AT 3 M

FREQ. (MHz)	EMISSION LEVEL (dBuV/m)	READ LEVEL (dBuV)	LIMIT (dBuV/m)	MARGIN (dB)	ANTENNA FACTOR (dB /m)	CABLE LOSS (dB)	ANTENNA HEIGHT (cm)	TABLE ANGLE (Degree)	REMARK
2437	96.98	104.71			32.34	8.24	130	128	Average
2437	98.96	106.69			32.34	8.24	130	128	Peak
4874	41.78	43.59	-12.22	54.00	34.30	12.81	100	78	Average
4874	52.76	54.57	-21.24	74.00	34.30	12.81	100	78	Peak
7311	45.31	42.56	-8.69	54.00	36.15	15.35	100	300	Average
7311	55.37	52.62	-18.63	74.00	36.15	15.35	100	300	Peak

ANTENNA POLARITY & TEST DISTANCE: VERTICAL AT 3 M

FREQ. (MHz)	EMISSION LEVEL (dBuV/m)	READ LEVEL (dBuV)	MARGIN (dB)	LIMIT (dBuV/m)	ANTENNA FACTOR (dB /m)	CABLE LOSS (dB)	ANTENNA HEIGHT (cm)	TABLE ANGLE (Degree)	REMARK
2437	98.33	106.06			32.34	8.24	100	280	Average
2437	100.35	108.08			32.34	8.24	100	280	Peak
4874	40.84	42.65	-13.16	54.00	34.30	12.81	100	45	Average
4874	53.61	55.42	-20.39	74.00	34.30	12.81	100	45	Peak
7311	44.20	41.45	-9.80	54.00	36.15	15.35	100	168	Average
7311	56.32	53.57	-17.68	74.00	36.15	15.35	100	168	Peak

REMARKS:

- Emission Level = Read Level+ Antenna Factor + Cable Loss- Preamp Factor
Margin value = Emission level – Limit value.
- 2437MHz: Fundamental frequency.

CHANNEL	TX Channel 11	DETECTOR FUNCTION	Peak (PK)
FREQUENCY RANGE	1GHz ~ 25GHz		Average (AV)

ANTENNA POLARITY & TEST DISTANCE: HORIZONTAL AT 3 M

FREQ. (MHz)	EMISSION LEVEL (dBuV/m)	READ LEVEL (dBuV)	MARGIN (dB)	LIMIT (dBuV/m)	ANTENNA FACTOR (dB /m)	CABLE LOSS (dB)	ANTENNA HEIGHT (cm)	TABLE ANGLE (Degree)	REMARK
2462	98.62	106.28			32.36	8.28	130	125	Average
2462	100.93	108.59			32.36	8.28	130	125	Peak
2483.5	36.55	44.15	-17.45	54.00	32.38	8.32	130	125	Average
2483.5	46.71	54.31	-27.29	74.00	32.38	8.32	130	125	Peak
4924	41.45	43.09	-12.55	54.00	34.30	13.00	100	40	Average
4924	53.63	55.27	-20.37	74.00	34.30	13.00	100	40	Peak
7386	44.61	41.74	-9.39	54.00	36.21	15.37	100	40	Average
7386	55.05	52.18	-18.95	74.00	36.21	15.37	100	40	Peak

ANTENNA POLARITY & TEST DISTANCE: VERTICAL AT 3 M

FREQ. (MHz)	EMISSION LEVEL (dBuV/m)	READ LEVEL (dBuV)	MARGIN (dB)	LIMIT (dBuV/m)	ANTENNA FACTOR (dB /m)	CABLE LOSS (dB)	ANTENNA HEIGHT (cm)	TABLE ANGLE (Degree)	REMARK
2462	97.49	105.15			32.36	8.28	100	230	Average
2462	100.33	107.99			32.36	8.28	100	230	Peak
2483.5	37.01	44.61	-16.99	54.00	32.38	8.32	100	230	Average
2483.5	46.78	54.38	-27.22	74.00	32.38	8.32	100	230	Peak
4924	46.07	47.71	-7.93	54.00	34.30	13.00	100	312	Average
4924	56.34	57.98	-17.66	74.00	34.30	13.00	100	312	Peak
7386	45.03	42.16	-8.97	54.00	36.21	15.37	100	198	Average
7386	55.58	52.71	-18.42	74.00	36.21	15.37	100	198	Peak

REMARKS:

- Emission Level = Read Level+ Antenna Factor + Cable Loss- Preamp Factor
Margin value = Emission level – Limit value.
- 2462MHz: Fundamental frequency.

802.11g

CHANNEL	TX Channel 1	DETECTOR FUNCTION	Peak (PK)
FREQUENCY RANGE	1GHz ~ 25GHz		Average (AV)

ANTENNA POLARITY & TEST DISTANCE: HORIZONTAL AT 3 M

FREQ. (MHz)	EMISSION LEVEL (dBuV/m)	READ LEVEL (dBuV)	MARGIN (dB)	LIMIT (dBuV/m)	ANTENNA FACTOR (dB /m)	CABLE LOSS (dB)	ANTENNA HEIGHT (cm)	TABLE ANGLE (Degree)	REMARK
2390	44.25	52.12	-9.75	54.00	32.29	8.15	130	130	Average
2390	59.65	67.52	-14.35	74.00	32.29	8.15	130	130	Peak
#2400	62.94	70.78	-10.60	73.54	32.30	8.17	130	130	Average
#2400	74.00	81.84	-6.92	80.92	32.30	8.17	130	130	Peak
2412	93.54	101.35			32.31	8.19	130	130	Average
2412	100.92	108.73			32.31	8.19	130	130	Peak
4824	41.23	43.20	-12.77	54.00	34.30	12.63	100	247	Average
4824	51.52	53.49	-22.48	74.00	34.30	12.63	100	247	Peak

ANTENNA POLARITY & TEST DISTANCE: VERTICAL AT 3 M

FREQ. (MHz)	EMISSION LEVEL (dBuV/m)	READ LEVEL (dBuV)	MARGIN (dB)	LIMIT (dBuV/m)	ANTENNA FACTOR (dB /m)	CABLE LOSS (dB)	ANTENNA HEIGHT (cm)	TABLE ANGLE (Degree)	REMARK
2390	41.34	49.21	-12.66	54.00	32.29	8.15	100	300	Average
2390	54.74	62.61	-19.26	74.00	32.29	8.15	100	300	Peak
#2400	60.07	67.91	-11.84	71.91	32.30	8.17	100	300	Average
#2400	71.11	78.95	-8.16	79.27	32.30	8.17	100	300	Peak
2412	91.91	99.72			32.31	8.19	100	300	Average
2412	99.27	107.08			32.31	8.19	100	300	Peak
4824	40.88	42.85	-13.12	54.00	34.30	12.63	100	56	Average
4824	52.61	54.58	-21.39	74.00	34.30	12.63	100	56	Peak

REMARKS:

1. Emission Level = Read Level+ Antenna Factor + Cable Loss- Preamp Factor
Margin value = Emission level – Limit value.
2. 2412MHz: Fundamental frequency.
3. " # ": The radiated frequency is out of the restricted band.

CHANNEL	TX Channel 6	DETECTOR FUNCTION	Peak (PK)
FREQUENCY RANGE	1GHz ~ 25GHz		Average (AV)

ANTENNA POLARITY & TEST DISTANCE: HORIZONTAL AT 3 M

FREQ. (MHz)	EMISSION LEVEL (dBuV/m)	READ LEVEL (dBuV)	MARGIN (dB)	LIMIT (dBuV/m)	ANTENNA FACTOR (dB /m)	CABLE LOSS (dB)	ANTENNA HEIGHT (cm)	TABLE ANGLE (Degree)	REMARK
2437	92.63	100.36			32.34	8.24	130	120	Average
2437	100.88	108.61			32.34	8.24	130	120	Peak
4874	41.54	43.35	-12.46	54.00	34.30	12.81	100	78	Average
4874	53.10	54.91	-20.90	74.00	34.30	12.81	100	78	Peak
7311	45.14	42.39	-8.86	54.00	36.15	15.35	100	298	Average
7311	56.28	53.53	-17.72	74.00	36.15	15.35	100	298	Peak

ANTENNA POLARITY & TEST DISTANCE: VERTICAL AT 3 M

FREQ. (MHz)	EMISSION LEVEL (dBuV/m)	READ LEVEL (dBuV)	MARGIN (dB)	LIMIT (dBuV/m)	ANTENNA FACTOR (dB /m)	CABLE LOSS (dB)	ANTENNA HEIGHT (cm)	TABLE ANGLE (Degree)	REMARK
2437	91.86	99.59			32.34	8.24	100	300	Average
2437	99.79	107.52			32.34	8.24	100	300	Peak
4874	41.54	43.35	-12.46	54.00	34.30	12.81	100	256	Average
4874	52.58	54.39	-21.42	74.00	34.30	12.81	100	256	Peak
7311	45.15	42.40	-8.85	54.00	36.15	15.35	100	146	Average
7311	56.09	53.34	-17.91	74.00	36.15	15.35	100	146	Peak

REMARKS:

1. Emission Level = Read Level+ Antenna Factor + Cable Loss- Preamp Factor
Margin value = Emission level – Limit value.
2. 2437MHz: Fundamental frequency.

CHANNEL	TX Channel 11	DETECTOR FUNCTION	Peak (PK)
FREQUENCY RANGE	1GHz ~ 25GHz		Average (AV)

ANTENNA POLARITY & TEST DISTANCE: HORIZONTAL AT 3 M

FREQ. (MHz)	EMISSION LEVEL (dBuV/m)	READ LEVEL (dBuV)	MARGIN (dB)	LIMIT (dBuV/m)	ANTENNA FACTOR (dB /m)	CABLE LOSS (dB)	ANTENNA HEIGHT (cm)	TABLE ANGLE (Degree)	REMARK
2462	93.37	101.03			32.36	8.28	130	120	Average
2462	100.86	108.52			32.36	8.28	130	120	Peak
2483.5	40.92	48.52	-13.08	54.00	32.38	8.32	130	120	Average
2483.5	51.98	59.58	-22.02	74.00	32.38	8.32	130	120	Peak
4924	40.54	42.18	-13.46	54.00	34.30	13.00	100	86	Average
4924	52.88	54.52	-21.12	74.00	34.30	13.00	100	86	Peak
7386	45.01	42.14	-8.99	54.00	36.21	15.37	100	236	Average
7386	56.96	54.09	-17.04	74.00	36.21	15.37	100	236	Peak

ANTENNA POLARITY & TEST DISTANCE: VERTICAL AT 3 M

FREQ. (MHz)	EMISSION LEVEL (dBuV/m)	READ LEVEL (dBuV)	MARGIN (dB)	LIMIT (dBuV/m)	ANTENNA FACTOR (dB /m)	CABLE LOSS (dB)	ANTENNA HEIGHT (cm)	TABLE ANGLE (Degree)	REMARK
2462	92.82	100.48			32.36	8.28	100	305	Average
2462	101.05	108.71			32.36	8.28	100	305	Peak
2483.5	39.96	47.56	-14.04	54.00	32.38	8.32	100	305	Average
2483.5	51.32	58.92	-22.68	74.00	32.38	8.32	100	305	Peak
4924	41.04	42.68	-12.96	54.00	34.30	13.00	100	222	Average
4924	52.03	53.67	-21.97	74.00	34.30	13.00	100	222	Peak
7386	44.05	41.18	-9.95	54.00	36.21	15.37	100	162	Average
7386	55.81	52.94	-18.19	74.00	36.21	15.37	100	162	Peak

REMARKS:

- Emission Level = Read Level+ Antenna Factor + Cable Loss- Preamp Factor
Margin value = Emission level – Limit value.
- 2462MHz: Fundamental frequency.

802.11n (20MHz)

CHANNEL	TX Channel 1	DETECTOR FUNCTION	Peak (PK)
FREQUENCY RANGE	1GHz ~ 25GHz		Average (AV)

ANTENNA POLARITY & TEST DISTANCE: HORIZONTAL AT 3 M

FREQ. (MHz)	EMISSION LEVEL (dBuV/m)	READ LEVEL (dBuV)	MARGIN (dB)	LIMIT (dBuV/m)	ANTENNA FACTOR (dB /m)	CABLE LOSS (dB)	ANTENNA HEIGHT (cm)	TABLE ANGLE (Degree)	REMARK
2390	41.36	49.23	-12.64	54.00	32.29	8.15	100	298	Average
2390	58.34	66.21	-15.66	74.00	32.29	8.15	100	298	Peak
#2400	56.92	64.76	-13.99	70.91	32.30	8.17	100	298	Average
#2400	67.19	75.03	-11.53	78.72	32.30	8.17	100	298	Peak
2412	90.91	98.72			32.31	8.19	100	298	Average
2412	98.72	106.53			32.31	8.19	100	298	Peak
4824	41.42	43.39	-12.58	54.00	34.30	12.63	100	124	Average
4824	51.86	53.83	-22.14	74.00	34.30	12.63	100	124	Peak

ANTENNA POLARITY & TEST DISTANCE: VERTICAL AT 3 M

FREQ. (MHz)	EMISSION LEVEL (dBuV/m)	READ LEVEL (dBuV)	MARGIN (dB)	LIMIT (dBuV/m)	ANTENNA FACTOR (dB /m)	CABLE LOSS (dB)	ANTENNA HEIGHT (cm)	TABLE ANGLE (Degree)	REMARK
2390	42.76	50.63	-11.24	54.00	32.29	8.15	130	120	Average
2390	59.72	67.59	-14.28	74.00	32.29	8.15	130	120	Peak
#2400	58.20	66.04	-13.29	71.49	32.30	8.17	130	120	Average
#2400	70.32	78.16	-8.96	79.28	32.30	8.17	130	120	Peak
2412	91.49	99.30			32.31	8.19	130	120	Average
2412	99.28	107.09			32.31	8.19	130	120	Peak
4824	41.32	43.29	-12.68	54.00	34.30	12.63	100	278	Average
4824	51.40	53.37	-22.60	74.00	34.30	12.63	100	278	Peak

REMARKS:

- Emission Level = Read Level+ Antenna Factor + Cable Loss- Preamp Factor
Margin value = Emission level – Limit value.
- 2412MHz: Fundamental frequency.
- " # ": The radiated frequency is out of the restricted band.

CHANNEL	TX Channel 6	DETECTOR FUNCTION	Peak (PK)
FREQUENCY RANGE	1GHz ~ 25GHz		Average (AV)

ANTENNA POLARITY & TEST DISTANCE: HORIZONTAL AT 3 M

FREQ. (MHz)	EMISSION LEVEL (dBuV/m)	READ LEVEL (dBuV)	MARGIN (dB)	LIMIT (dBuV/m)	ANTENNA FACTOR (dB /m)	CABLE LOSS (dB)	ANTENNA HEIGHT (cm)	TABLE ANGLE (Degree)	REMARK
2437	91.80	99.53			32.34	8.24	130	130	Average
2437	99.25	106.98			32.34	8.24	130	130	Peak
4874	40.60	42.41	-13.40	54.00	34.30	12.81	130	228	Average
4874	52.27	54.08	-21.73	74.00	34.30	12.81	130	228	Peak
7311	45.16	42.41	-8.84	54.00	36.15	15.35	130	86	Average
7311	54.22	51.47	-19.78	74.00	36.15	15.35	130	86	Peak

ANTENNA POLARITY & TEST DISTANCE: VERTICAL AT 3 M

FREQ. (MHz)	EMISSION LEVEL (dBuV/m)	READ LEVEL (dBuV)	MARGIN (dB)	LIMIT (dBuV/m)	ANTENNA FACTOR (dB /m)	CABLE LOSS (dB)	ANTENNA HEIGHT (cm)	TABLE ANGLE (Degree)	REMARK
2437	90.03	97.76			32.34	8.24	100	286	Average
2437	99.10	106.83			32.34	8.24	100	286	Peak
4874	40.63	42.44	-13.37	54.00	34.30	12.81	100	268	Average
4874	51.40	53.21	-22.60	74.00	34.30	12.81	100	268	Peak
7311	44.21	41.46	-9.79	54.00	36.15	15.35	100	142	Average
7311	55.62	52.87	-18.38	74.00	36.15	15.35	100	142	Peak

REMARKS:

1. Emission Level = Read Level+ Antenna Factor + Cable Loss- Preamp Factor
Margin value = Emission level – Limit value.
2. 2437MHz: Fundamental frequency.

CHANNEL	TX Channel 11	DETECTOR FUNCTION	Peak (PK)
FREQUENCY RANGE	1GHz ~ 25GHz		Average (AV)

ANTENNA POLARITY & TEST DISTANCE: HORIZONTAL AT 3 M

FREQ. (MHz)	EMISSION LEVEL (dBuV/m)	READ LEVEL (dBuV)	MARGIN (dB)	LIMIT (dBuV/m)	ANTENNA FACTOR (dB /m)	CABLE LOSS (dB)	ANTENNA HEIGHT (cm)	TABLE ANGLE (Degree)	REMARK
2462	91.87	99.53			32.36	8.28	130	120	Average
2462	99.77	107.43			32.36	8.28	130	120	Peak
2483.5	37.99	45.59	-16.01	54.00	32.38	8.32	130	120	Average
2483.5	50.23	57.83	-23.77	74.00	32.38	8.32	130	120	Peak
4924	40.57	42.21	-13.43	54.00	34.30	13.00	130	268	Average
4924	52.87	54.51	-21.13	74.00	34.30	13.00	130	268	Peak
7386	44.11	41.24	-9.89	54.00	36.21	15.37	130	58	Average
7386	56.02	53.15	-17.98	74.00	36.21	15.37	130	58	Peak

ANTENNA POLARITY & TEST DISTANCE: VERTICAL AT 3 M

FREQ. (MHz)	EMISSION LEVEL (dBuV/m)	READ LEVEL (dBuV)	MARGIN (dB)	LIMIT (dBuV/m)	ANTENNA FACTOR (dB /m)	CABLE LOSS (dB)	ANTENNA HEIGHT (cm)	TABLE ANGLE (Degree)	REMARK
2462	91.75	99.41			32.36	8.28	100	286	Average
2462	99.51	107.17			32.36	8.28	100	286	Peak
2483.5	39.07	46.67	-14.93	54.00	32.38	8.32	100	286	Average
2483.5	51.75	59.35	-22.25	74.00	32.38	8.32	100	286	Peak
4924	40.44	42.08	-13.56	54.00	34.30	13.00	100	305	Average
4924	52.14	53.78	-21.86	74.00	34.30	13.00	100	305	Peak
7386	45.05	42.18	-8.95	54.00	36.21	15.37	100	112	Average
7386	55.45	52.58	-18.55	74.00	36.21	15.37	100	112	Peak

REMARKS:

- Emission Level = Read Level+ Antenna Factor + Cable Loss- Preamp Factor
Margin value = Emission level – Limit value.
- 2462MHz: Fundamental frequency.

802.11n (40MHz)

CHANNEL	TX Channel 3	DETECTOR FUNCTION	Peak (PK)
FREQUENCY RANGE	1GHz ~ 25GHz		Average (AV)

ANTENNA POLARITY & TEST DISTANCE: HORIZONTAL AT 3 M

FREQ. (MHz)	EMISSION LEVEL (dBuV/m)	READ LEVEL (dBuV)	MARGIN (dB)	LIMIT (dBuV/m)	ANTENNA FACTOR (dB /m)	CABLE LOSS (dB)	ANTENNA HEIGHT (cm)	TABLE ANGLE (Degree)	REMARK
2390	47.00	54.87	-7.00	54.00	32.29	8.15	130	128	Average
2390	58.28	66.15	-15.72	74.00	32.29	8.15	130	128	Peak
#2400	54.44	62.28	-16.05	70.49	32.30	8.17	130	128	Average
#2400	66.27	74.11	-12.29	78.56	32.30	8.17	130	128	Peak
2422	90.49	98.27			32.32	8.21	130	128	Average
2422	98.56	106.34			32.32	8.21	130	128	Peak
4844	41.31	43.22	-12.69	54.00	34.30	12.70	130	265	Average
4844	50.44	52.35	-23.56	74.00	34.30	12.70	130	265	Peak

ANTENNA POLARITY & TEST DISTANCE: VERTICAL AT 3 M

FREQ. (MHz)	EMISSION LEVEL (dBuV/m)	READ LEVEL (dBuV)	MARGIN (dB)	LIMIT (dBuV/m)	ANTENNA FACTOR (dB /m)	CABLE LOSS (dB)	ANTENNA HEIGHT (cm)	TABLE ANGLE (Degree)	REMARK
2390	44.30	52.17	-9.70	54.00	32.29	8.15	100	300	Average
2390	56.34	64.21	-17.66	74.00	32.29	8.15	100	300	Peak
#2400	52.08	59.92	-16.98	69.06	32.30	8.17	100	300	Average
#2400	62.37	70.21	-15.37	77.74	32.30	8.17	100	300	Peak
2422	89.06	96.84			32.32	8.21	100	300	Average
2422	97.74	105.52			32.32	8.21	100	300	Peak
4844	40.37	42.28	-13.63	54.00	34.30	12.70	100	187	Average
4844	51.91	53.82	-22.09	74.00	34.30	12.70	100	187	Peak

REMARKS:

- Emission Level = Read Level+ Antenna Factor + Cable Loss- Preamp Factor
Margin value = Emission level – Limit value.
- 2422MHz: Fundamental frequency.
- " # ": The radiated frequency is out of the restricted band.

CHANNEL	TX Channel 6	DETECTOR FUNCTION	Peak (PK)
FREQUENCY RANGE	1GHz ~ 25GHz		Average (AV)

ANTENNA POLARITY & TEST DISTANCE: HORIZONTAL AT 3 M

FREQ. (MHz)	EMISSION LEVEL (dBuV/m)	READ LEVEL (dBuV)	MARGIN (dB)	LIMIT (dBuV/m)	ANTENNA FACTOR (dB /m)	CABLE LOSS (dB)	ANTENNA HEIGHT (cm)	TABLE ANGLE (Degree)	REMARK
2437	91.32	99.05			32.34	8.24	130	130	Average
2437	99.73	107.46			32.34	8.24	130	130	Peak
4874	40.78	42.59	-13.22	54.00	34.30	12.81	130	268	Average
4874	52.16	53.97	-21.84	74.00	34.30	12.81	130	268	Peak
7311	45.31	42.56	-8.69	54.00	36.15	15.35	130	95	Average
7311	55.93	53.18	-18.07	74.00	36.15	15.35	130	95	Peak

ANTENNA POLARITY & TEST DISTANCE: VERTICAL AT 3 M

FREQ. (MHz)	EMISSION LEVEL (dBuV/m)	READ LEVEL (dBuV)	MARGIN (dB)	LIMIT (dBuV/m)	ANTENNA FACTOR (dB /m)	CABLE LOSS (dB)	ANTENNA HEIGHT (cm)	TABLE ANGLE (Degree)	REMARK
2437	89.76	97.49			32.34	8.24	100	305	Average
2437	98.21	105.94			32.34	8.24	100	305	Peak
4874	40.74	42.55	-13.26	54.00	34.30	12.81	100	126	Average
4874	51.98	53.79	-22.02	74.00	34.30	12.81	100	126	Peak
7311	44.30	41.55	-9.70	54.00	36.15	15.35	100	208	Average
7311	55.80	53.05	-18.20	74.00	36.15	15.35	100	208	Peak

REMARKS:

1. Emission Level = Read Level+ Antenna Factor + Cable Loss- Preamp Factor
Margin value = Emission level – Limit value.
2. 2437MHz: Fundamental frequency.

CHANNEL	TX Channel 9	DETECTOR FUNCTION	Peak (PK)
FREQUENCY RANGE	1GHz ~ 25GHz		Average (AV)

ANTENNA POLARITY & TEST DISTANCE: HORIZONTAL AT 3 M

FREQ. (MHz)	EMISSION LEVEL (dBuV/m)	READ LEVEL (dBuV)	MARGIN (dB)	LIMIT (dBuV/m)	ANTENNA FACTOR (dB /m)	CABLE LOSS (dB)	ANTENNA HEIGHT (cm)	TABLE ANGLE (Degree)	REMARK
2452	90.34	98.03			32.35	8.26	130	125	Average
2452	98.33	106.02			32.35	8.26	130	125	Peak
2483.5	46.97	54.57	-7.03	54.00	32.38	8.32	130	125	Average
2483.5	57.38	64.98	-16.62	74.00	32.38	8.32	130	125	Peak
4904	40.57	42.28	-13.43	54.00	34.30	12.92	130	65	Average
4904	51.88	53.59	-22.12	74.00	34.30	12.92	130	65	Peak
7356	44.10	41.29	-9.90	54.00	36.18	15.36	130	248	Average
7356	56.10	53.29	-17.90	74.00	36.18	15.36	130	248	Peak

ANTENNA POLARITY & TEST DISTANCE: VERTICAL AT 3 M

FREQ. (MHz)	EMISSION LEVEL (dBuV/m)	READ LEVEL (dBuV)	MARGIN (dB)	LIMIT (dBuV/m)	ANTENNA FACTOR (dB /m)	CABLE LOSS (dB)	ANTENNA HEIGHT (cm)	TABLE ANGLE (Degree)	REMARK
2452	89.78	97.47			32.35	8.26	100	295	Average
2452	97.83	105.52			32.35	8.26	100	295	Peak
2483.5	46.96	54.56	-7.04	54.00	32.38	8.32	100	295	Average
2483.5	57.51	65.11	-16.49	74.00	32.38	8.32	100	295	Peak
4904	40.55	42.26	-13.45	54.00	34.30	12.92	100	222	Average
4904	52.56	54.27	-21.44	74.00	34.30	12.92	100	222	Peak
7356	44.11	41.30	-9.89	54.00	36.18	15.36	100	123	Average
7356	55.24	52.43	-18.76	74.00	36.18	15.36	100	123	Peak

REMARKS:

- Emission Level = Read Level+ Antenna Factor + Cable Loss- Preamp Factor
Margin value = Emission level – Limit value.
- 2452MHz: Fundamental frequency.

4.2 Conducted Emission Measurement

4.2.1 Limits of Conducted Emission Measurement

Frequency (MHz)	Conducted Limit (dBuV)	
	Quasi-peak	Average
0.15 - 0.5	66 - 56	56 - 46
0.50 - 5.0	56	46
5.0 - 30.0	60	50

NOTE: 1. The lower limit shall apply at the transition frequencies.

2. The limit decreases in line with the logarithm of the frequency in the range of 0.15 to 0.50MHz.

3. All emanations from a class A/B digital device or system, including any network of conductors and apparatus connected thereto, shall not exceed the level of field strengths specified above.

4.2.2 Test Instruments

Equipment	Manufacturer	Model No.	Serial No.	Last Cal.	Next Cal.
EMI Test Receiver	Rohde&Schwarz	ESCS30	100340	May 11,15	May 10,17
Artificial Mains Network	Rohde&Schwarz	ENV216	101173	Mar. 04,16	Mar. 03,17
Artificial Mains Network	Rohde&Schwarz	ESH3-Z5	100317	Apr. 05,16	Apr. 04,17
Voltage probe	SCHWARZBECK	TK 9421	TK 9421-176	Jan. 08,16	Jan. 07,17
Test software	ADT	ADT_Cond_V7.3.7	N/A	N/A	N/A

NOTE: 1. The calibration interval of the above test instruments is 12 months and the calibrations are traceable to NML/ROC and NIST/USA.

2. The test was performed in HwaYa Shielded Room 1.

3. The VCCI Site Registration No. is C-2040.

4.2.3 Test Procedures

- a. The EUT was placed 0.4 meters from the conducting wall of the shielded room with EUT being connected to the power mains through a line impedance stabilization network (LISN). Other support units were connected to the power mains through another LISN. The two LISNs provide 50 ohm/ 50uH of coupling impedance for the measuring instrument.
- b. Both lines of the power mains connected to the EUT were checked for maximum conducted interference.
- c. The frequency range from 150kHz to 30MHz was searched. Emission levels under (Limit - 20dB) was not recorded.

NOTE: All modes of operation were investigated and the worst-case emissions are reported.

4.2.4 Deviation from Test Standard

No deviation.

4.2.5 Test Setup

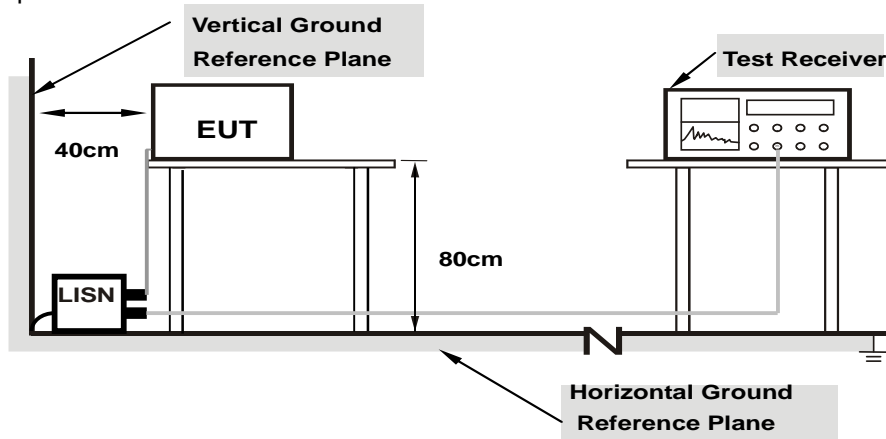

Note: 1. Support units were connected to second LISN.

For the actual test configuration, please refer to the attached file (Test Setup Photo).

4.2.6 EUT Operating Conditions

Same as 4.1.6.

4.2.7 Test Results

TEST VOLTAGE	DC 5.0V From Adapter Input 230 Vac, 50 Hz	6dB BANDWIDTH	9 kHz
ENVIRONMENTAL CONDITIONS	24deg. C, 55RH	TESTED BY	Eric

Frequency (MHz)	QuasiPeak (dBµV)	CAverage (dBµV)	Limit (dBµV)	Margin (dB)	Line	Filter	Corr. (dB)
0.158000	---	46.39	55.57	9.18	L	ON	9.6
0.158000	58.54	---	65.57	7.03	L	ON	9.6
0.188000	---	38.64	54.12	15.48	L	ON	9.7
0.188000	52.63	---	64.12	11.49	L	ON	9.7
0.364000	---	25.37	48.64	23.27	L	ON	9.7
0.364000	36.86	---	58.64	21.78	L	ON	9.7
0.972000	---	26.17	46.00	19.83	L	ON	9.7
0.972000	35.99	---	56.00	20.01	L	ON	9.7
3.608000	---	22.00	46.00	24.00	L	ON	9.7
3.608000	33.77	---	56.00	22.23	L	ON	9.7
4.734000	---	24.32	46.00	21.68	L	ON	9.7
4.734000	37.29	---	56.00	18.71	L	ON	9.7

- REMARKS:**
1. Q.P. and AV. are abbreviations of quasi-peak and average individually.
 2. "-": The Quasi-peak reading value also meets average limit and measurement with the average detector is unnecessary.
 3. The emission levels of other frequencies were very low against the limit.
 4. Margin value = Emission level - Limit value
 5. Correction factor = Insertion loss + Cable loss
 6. Emission Level = Correction Factor + Reading Value.

Full Spectrum

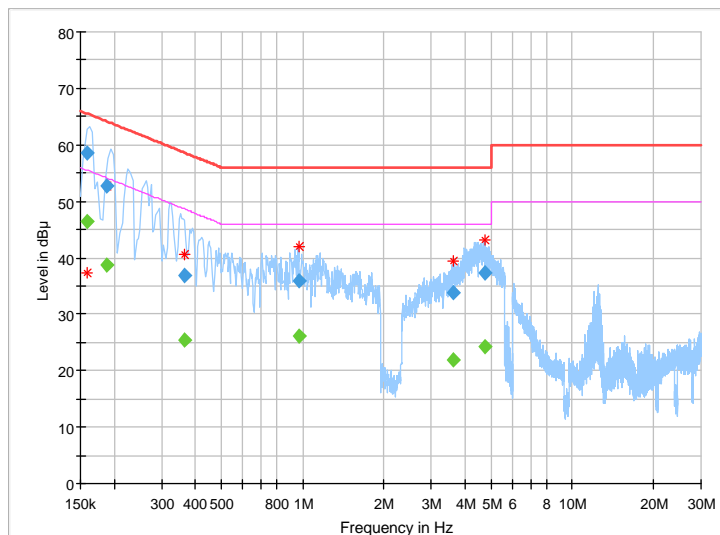

TEST VOLTAGE	DC 5.0V From Adapter Input 230 Vac, 50 Hz	6dB BANDWIDTH	9 kHz
ENVIRONMENTAL CONDITIONS	24deg. C, 55RH	TESTED BY	Eric

Frequency (MHz)	QuasiPeak (dBuV)	CAverage (dBuV)	Limit (dBuV)	Margin (dB)	Line	Filter	Corr. (dB)
0.158000	---	44.78	55.57	10.79	N	ON	10.1
0.158000	55.71	---	65.57	9.86	N	ON	10.1
0.284000	---	39.44	50.70	11.26	N	ON	10.0
0.284000	46.99	---	60.70	13.71	N	ON	10.0
0.708000	---	30.69	46.00	15.31	N	ON	10.0
0.708000	41.45	---	56.00	14.55	N	ON	10.0
0.932000	---	30.84	46.00	15.16	N	ON	9.9
0.932000	41.72	---	56.00	14.28	N	ON	9.9
1.308000	---	27.46	46.00	18.54	N	ON	9.9
1.308000	37.97	---	56.00	18.03	N	ON	9.9
4.600000	---	24.15	46.00	21.85	N	ON	9.8
4.600000	37.91	---	56.00	18.09	N	ON	9.8

- REMARKS:**
1. Q.P. and AV. are abbreviations of quasi-peak and average individually.
 2. "-": The Quasi-peak reading value also meets average limit and measurement with the average detector is unnecessary.
 3. The emission levels of other frequencies were very low against the limit.
 4. Margin value = Emission level - Limit value
 5. Correction factor = Insertion loss + Cable loss
 6. Emission Level = Correction Factor + Reading Value.

Full Spectrum

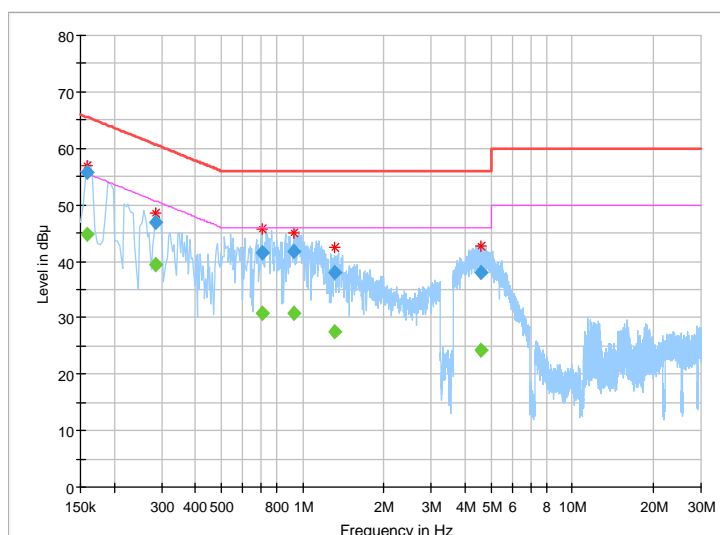

4.3 6dB Bandwidth Measurement

4.3.1 Limits of 6dB Bandwidth Measurement

The minimum of 6dB Bandwidth Measurement is 0.5 MHz.

4.3.2 Test Setup

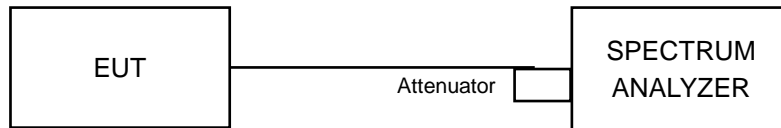

4.3.3 Test Instruments

Equipment	Manufacturer	Model No.	Serial No.	Last Cal.	Next Cal.
Spectrum Analyzer (10Hz-40GHz)	Rohde&Schwarz	FSV40	101003	Apr. 05,16	Apr. 04,17
Power Meter	Anritsu	ML2495A	1139001	Feb.19,16	Feb. 18,17
Power Sensor	Anritsu	MA2411B	1126068	Feb.19,16	Feb. 18,17
Power Sensor	Keysight	U2021XA	MY55060016	May 27,15	May 26,17
Power Sensor	Keysight	U2021XA	MY55060018	May 27,15	May 26,17
Digital Multimeter	FLUKE	15B	A1220010DG	Oct. 12, 15	Oct.11, 16

NOTE:

1. The calibration interval of the above test instruments is 12 months and the calibrations are traceable to CEPREI/CHINA, GRGT/CHINA and NIM/CHINA.
2. The test was performed in RF Oven room.

4.3.4 Test Procedure

- a. Set resolution bandwidth (RBW) = 100kHz
- b. Set the video bandwidth (VBW) ≥ 3 x RBW, Detector = Peak.
- c. Trace mode = max hold.
- d. Sweep = auto couple.
- e. Measure the maximum width of the emission that is constrained by the frequencies associated with the two amplitude points (upper and lower) that are attenuated by 6 dB relative to the maximum level measured in the fundamental emission

4.3.5 Deviation from Test Standard

No deviation.

4.3.6 EUT Operating Conditions

The software provided by client to enable the EUT under transmission condition continuously at lowest, middle and highest channel frequencies individually.

4.3.7 Test Result

802.11b

Channel	Frequency (MHz)	6db Bandwidth (MHz)	Minimum Limit (MHz)	Pass / Fail
1	2412	9.27	0.5	PASS
6	2437	9.26	0.5	PASS
11	2462	9.12	0.5	PASS

802.11g

Channel	Frequency (MHz)	6db Bandwidth (MHz)	Minimum Limit (MHz)	Pass / Fail
1	2412	16.35	0.5	PASS
6	2437	16.10	0.5	PASS
11	2462	16.33	0.5	PASS

802.11n (HT20)

Channel	Frequency (MHz)	6db Bandwidth (MHz)	Minimum Limit (MHz)	Pass / Fail
1	2412	17.58	0.5	Pass
6	2437	17.23	0.5	Pass
11	2462	17.20	0.5	Pass

802.11n (HT40)

Channel	Frequency (MHz)	6db Bandwidth (MHz)	Minimum Limit (MHz)	Pass / Fail
3	2422	36.06	0.5	Pass
6	2437	36.09	0.5	Pass
9	2452	35.76	0.5	Pass

Spectrum Plot of Worst Value

802.11b

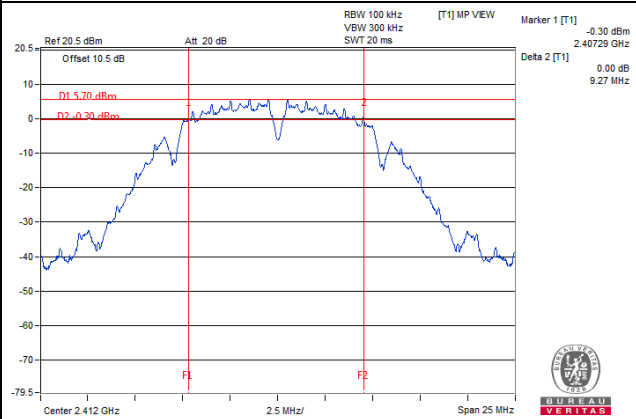

802.11g

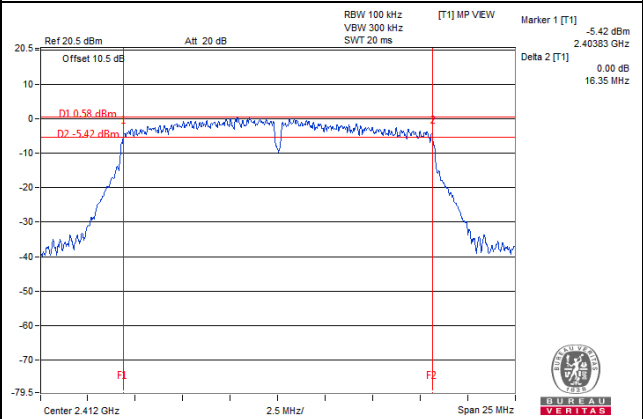

802.11n (HT20)

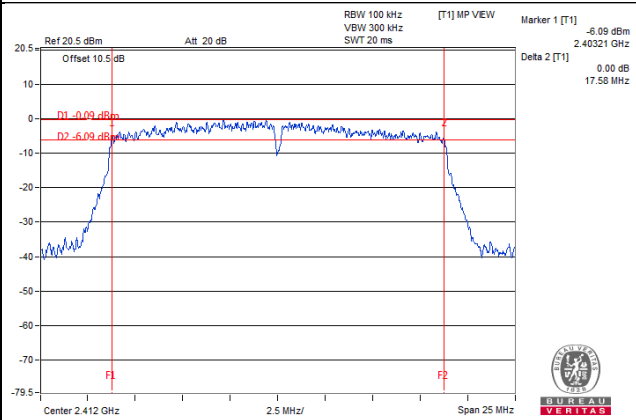

802.11n (HT40)

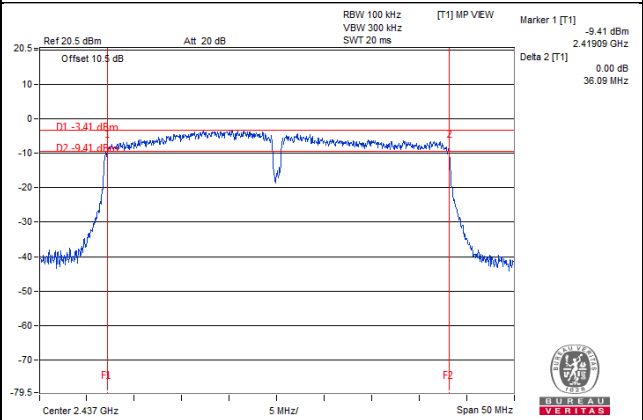

4.4 Conducted Output Power Measurement

4.4.1 Limits of Conducted Output Power Measurement

For systems using digital modulation in the 2400–2483.5 MHz bands: 1 Watt (30dBm)

4.4.2 Test Setup

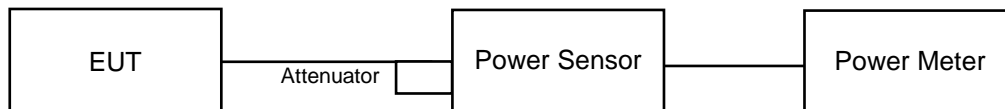

4.4.3 Test Instruments

Refer to section 4.3.3 to get information of above instrument.

4.4.4 Test Procedures

A peak / average power sensor was used on the output port of the EUT. A power meter was used to read the response of the peak / average power sensor. Record the power level.

4.4.5 Deviation from Test Standard

No deviation.

4.4.6 EUT Operating Conditions

Same as Item 4.3.6.

4.4.7 Test Results

4.4.7.1 Maximum Peak Output Power

802.11b

CHANNEL	CHANNEL FREQUENCY (MHz)	PEAK POWER (dBm)	PEAK POWER (mW)	PEAK POWER LIMIT (W)	PASS/FAIL
1	2412	18.34	68.234	1	PASS
6	2437	18.34	68.234	1	PASS
11	2462	18.50	70.795	1	PASS

802.11g

CHANNEL	CHANNEL FREQUENCY (MHz)	PEAK POWER (dBm)	PEAK POWER (mW)	PEAK POWER LIMIT (W)	PASS/FAIL
1	2412	19.36	86.298	1	PASS
6	2437	19.57	90.573	1	PASS
11	2462	20.29	106.905	1	PASS

802.11n (20MHz)

CHANNEL	CHANNEL FREQUENCY (MHz)	PEAK POWER (dBm)	PEAK POWER (mW)	PEAK POWER LIMIT (W)	PASS/FAIL
1	2412	18.86	76.913	1	PASS
6	2437	19.16	82.414	1	PASS
11	2462	19.55	90.157	1	PASS

802.11n (40MHz)

CHANNEL	CHANNEL FREQUENCY (MHz)	PEAK POWER (dBm)	PEAK POWER (mW)	PEAK POWER LIMIT (W)	PASS/FAIL
3	2422	18.78	75.509	1	PASS
6	2437	18.96	78.705	1	PASS
9	2452	19.51	89.331	1	PASS

4.4.7.2 Average Output Power (For Reference)

The average power sensor was used on the output port of the EUT. A power meter was used to read the response of the power sensor. Record the power level.

802.11b

CHANNEL	CHANNEL FREQUENCY (MHz)	AVERAGE POWER (dBm)	PASS/FAIL
1	2412	15.16	N/A
6	2437	15.42	N/A
11	2462	15.73	N/A

802.11g

CHANNEL	CHANNEL FREQUENCY (MHz)	AVERAGE POWER (dBm)	PASS/FAIL
1	2412	13.19	N/A
6	2437	13.44	N/A
11	2462	13.86	N/A

802.11n (20MHz)

CHANNEL	CHANNEL FREQUENCY (MHz)	AVERAGE POWER (dBm)	PASS/FAIL
1	2412	11.82	N/A
6	2437	12.39	N/A
11	2462	12.74	N/A

802.11n (40MHz)

CHANNEL	CHANNEL FREQUENCY (MHz)	AVERAGE POWER (dBm)	PASS/FAIL
3	2422	11.84	N/A
6	2437	12.24	N/A
9	2452	12.25	N/A

4.5 Power Spectral Density Measurement

4.5.1 Limits of Power Spectral Density Measurement

The Maximum of Power Spectral Density Measurement is 8dBm.

4.5.2 Test Setup

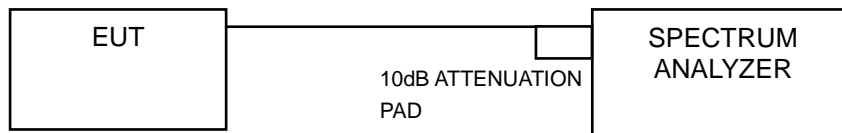

4.5.3 Test Instruments

Refer to section 4.3.3 to get information of above instrument.

4.5.4 Test Procedure

- a. Set analyzer center frequency to DTS channel center frequency.
- b. Set the span to 1.5 times the DTS bandwidth.
- c. Set the RBW to: $3 \text{ kHz} \leq \text{RBW} \leq 100 \text{ kHz}$.
- d. Set the VBW $\geq 3 \times \text{RBW}$.
- e. Detector = peak.
- f. Sweep time = auto couple.
- g. Trace mode = max hold.
- h. Allow trace to fully stabilize.
- i. Use the peak marker function to determine the maximum amplitude level within the RBW.

4.5.5 Deviation from Test Standard

No deviation.

4.5.6 EUT Operating Condition

Same as Item 4.3.6

4.5.7 Test Results

802.11b

Channel	Freq. (MHz)	PSD (dBm/3kHz)	Limit (dBm)	Pass /Fail
1	2412	-12.62	8	Pass
6	2437	-12.55	8	Pass
11	2462	-12.06	8	Pass

802.11g

Channel	Freq. (MHz)	PSD (dBm/3kHz)	Limit (dBm)	Pass /Fail
1	2412	-13.29	8	Pass
6	2437	-12.91	8	Pass
11	2462	-13.06	8	Pass

802.11n (HT20)

Channel	Freq. (MHz)	PSD (dBm/3kHz)	Limit (dBm)	Pass /Fail
1	2412	-14.16	8	Pass
6	2437	-13.94	8	Pass
11	2462	-13.55	8	Pass

802.11n (HT40)

Channel	Freq. (MHz)	PSD (dBm/3kHz)	Limit (dBm)	PASS /FAIL
3	2422	-17.19	8	PASS
6	2437	-15.11	8	PASS
9	2452	-15.16	8	PASS

Spectrum Plot of Worst Value

802.11b

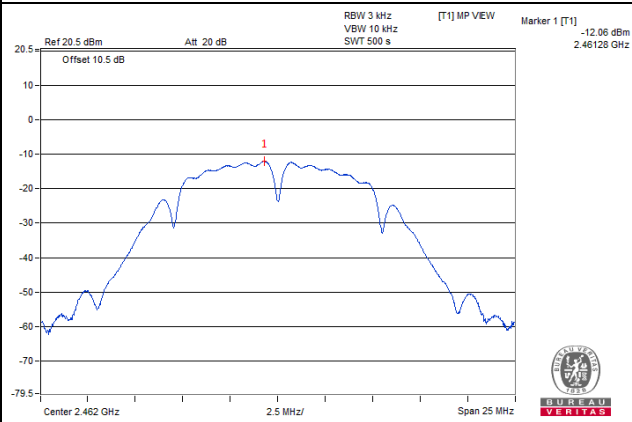

802.11g

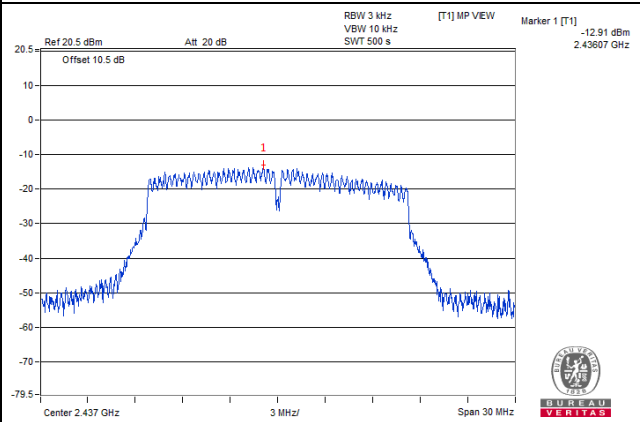

802.11n (HT20)

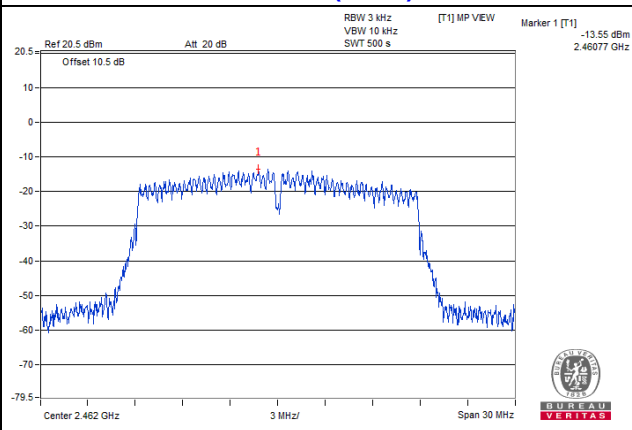

802.11n (HT40)

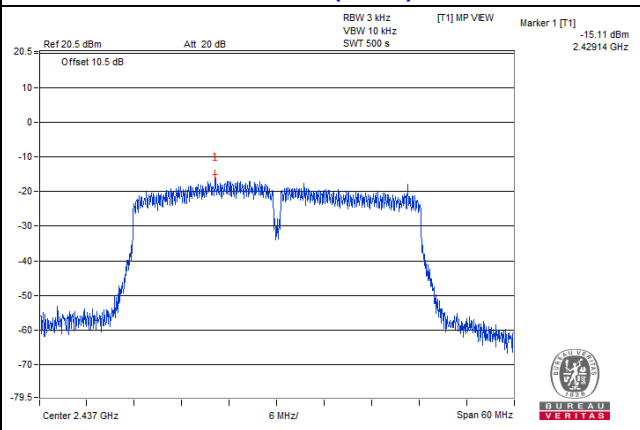

4.6 Conducted Out of Band Emission Measurement

4.6.1 Limits of Conducted Out of Band Emission Measurement

Below 20dB of the highest emission level of operating band (in 100kHz Resolution Bandwidth).

4.6.2 Test Setup

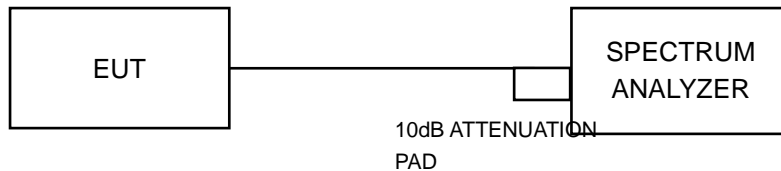

4.6.3 Test Instruments

Refer to section 4.3.3 to get information of above instrument.

4.6.4 Test Procedure

MEASUREMENT PROCEDURE REF

1. Set the RBW = 100 kHz.
2. Set the VBW \geq 300 kHz.
3. Detector = peak.
4. Sweep time = auto couple.
5. Trace mode = max hold.
6. Allow trace to fully stabilize.
7. Use the peak marker function to determine the maximum power level in any 100 kHz band segment within the fundamental EBW.

MEASUREMENT PROCEDURE OOB

1. Set RBW = 100 kHz.
2. Set VBW \geq 300 kHz.
3. Detector = peak.
4. Sweep = auto couple.
5. Trace Mode = max hold.
6. Allow trace to fully stabilize.
7. Use the peak marker function to determine the maximum amplitude level.

4.6.5 Deviation from Test Standard

No deviation.

4.6.6 EUT Operating Condition

Same as Item 4.3.6

4.6.7 Test Results

The spectrum plots are attached on the following pages. D1 line indicates the highest level, and D2 line indicates the 20dB offset below D1. It shows compliance with the requirement.

802.11b

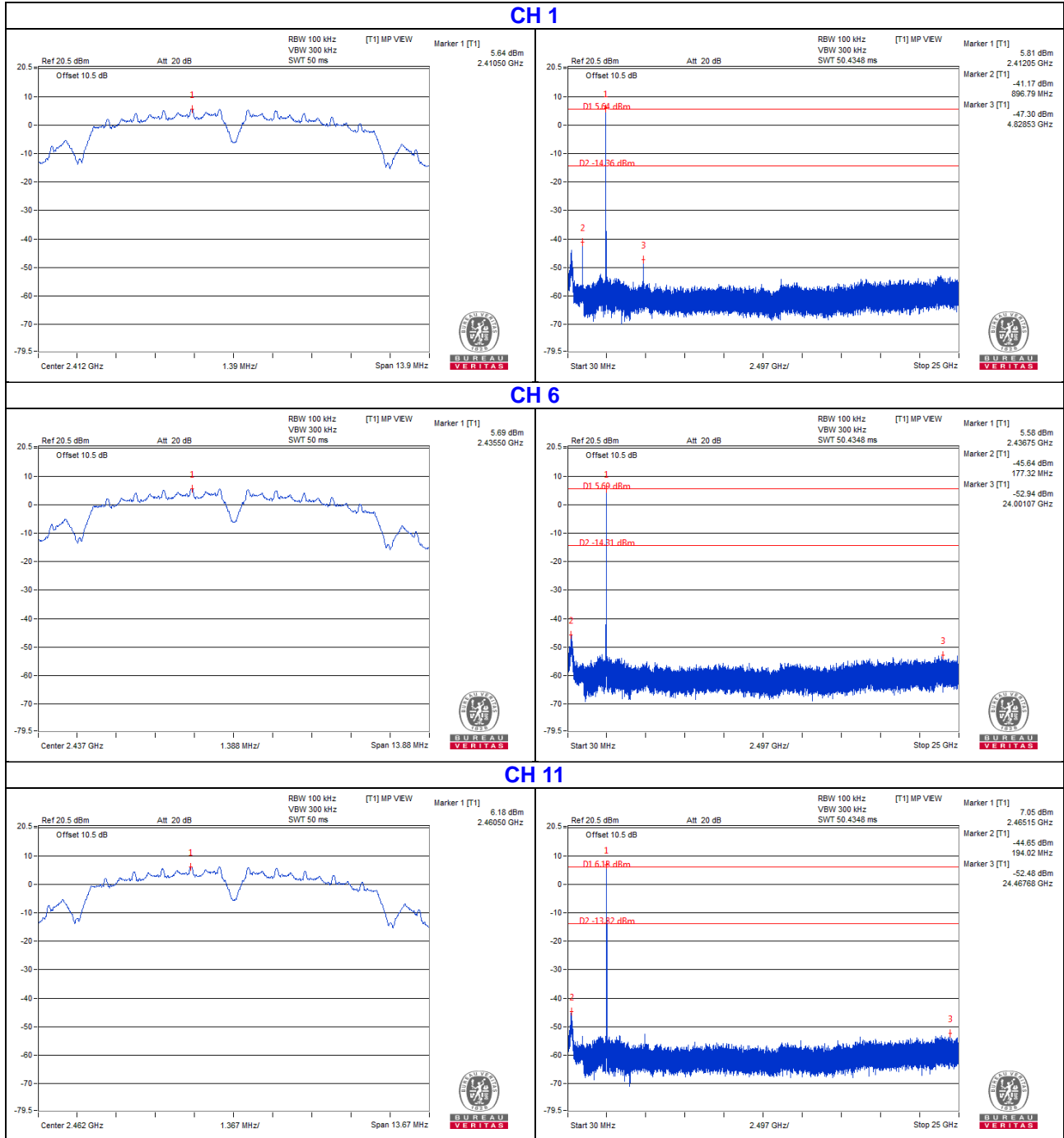

802.11g

CH 1

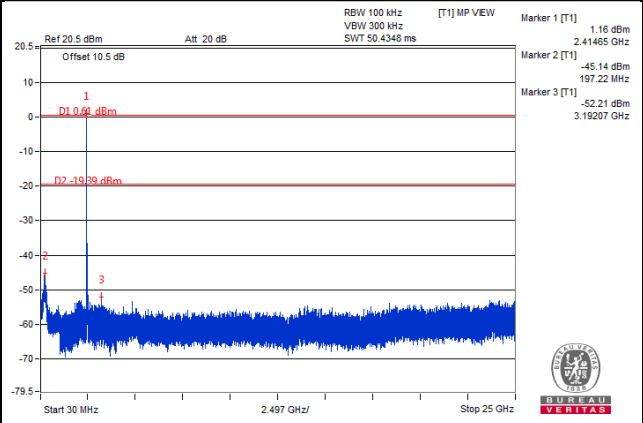
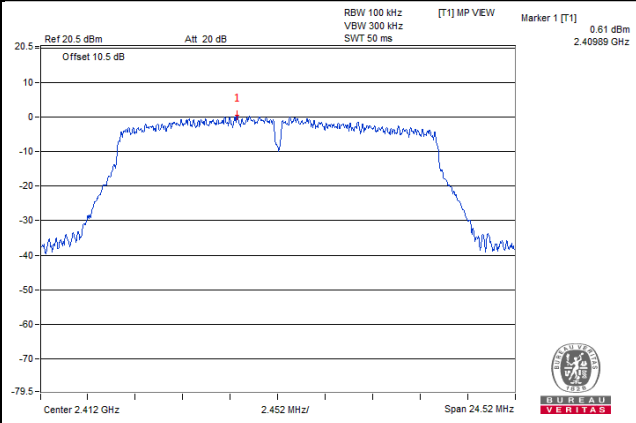

CH 6

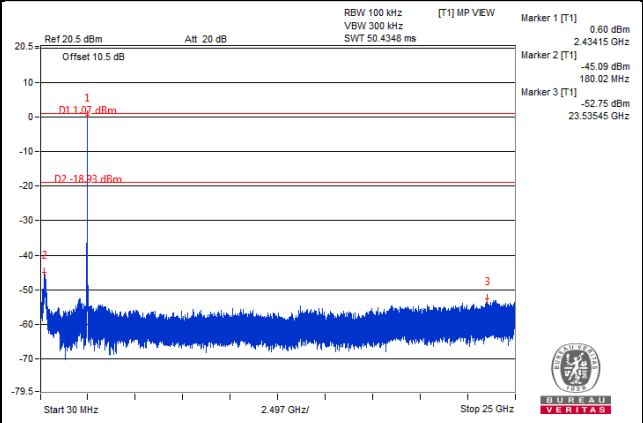
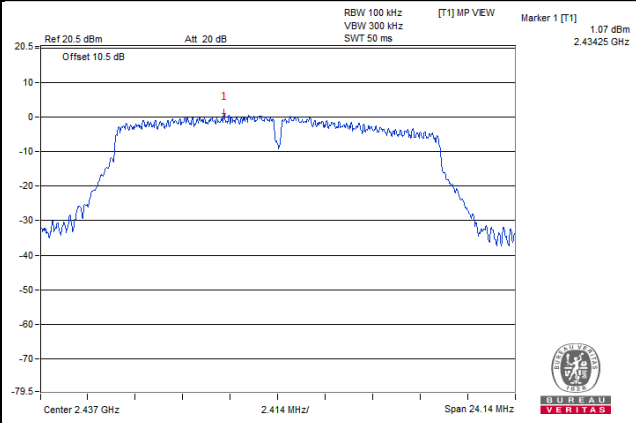

CH 11

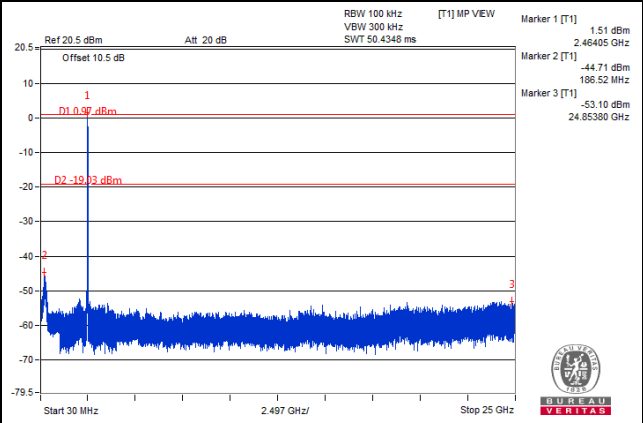
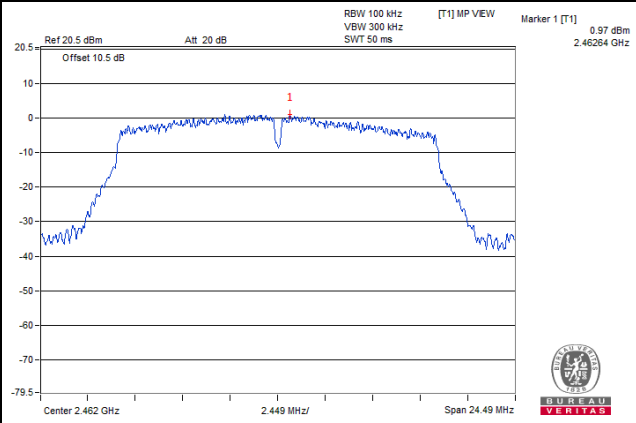

802.11n (HT20)

CH 1

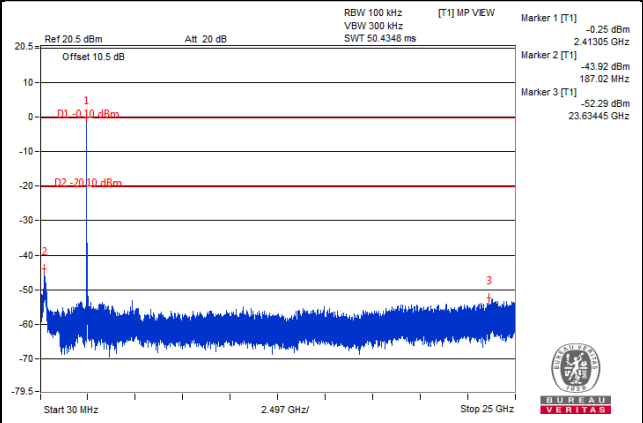
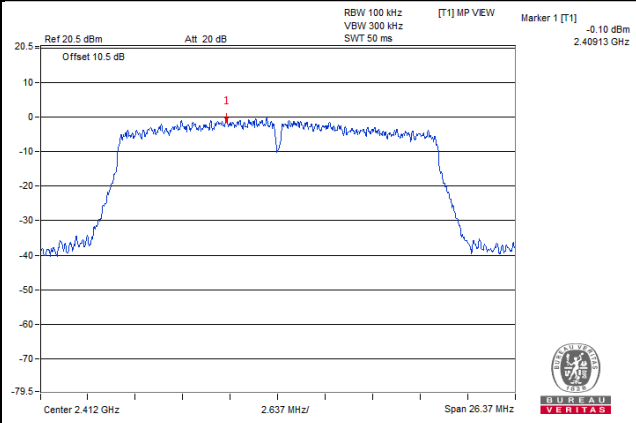

CH 6

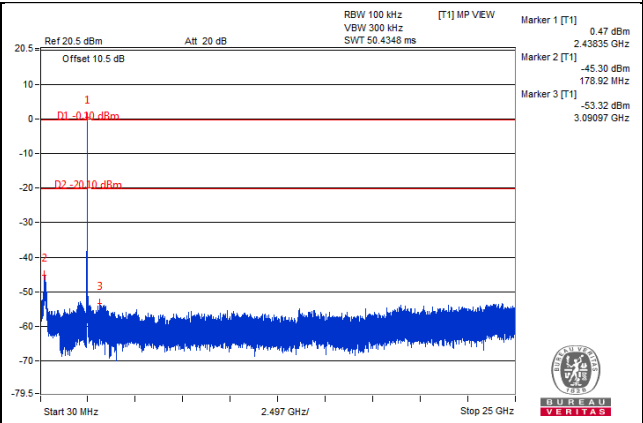
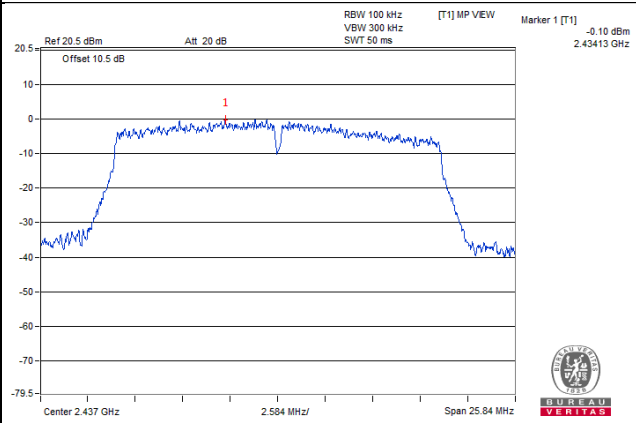

CH 11

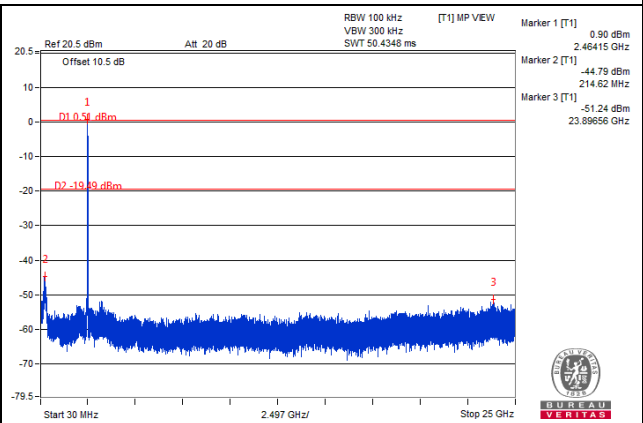
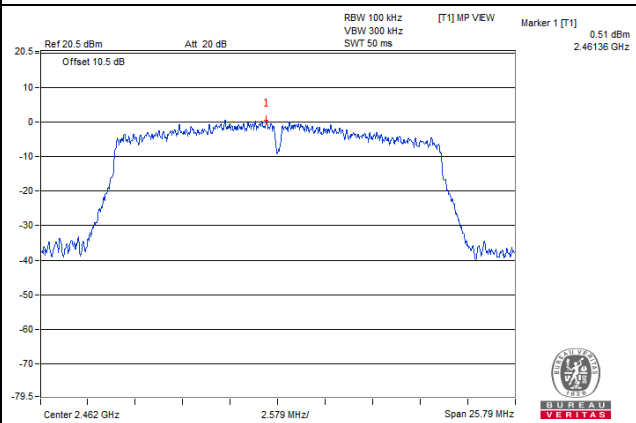

802.11n (HT40)

CH 3

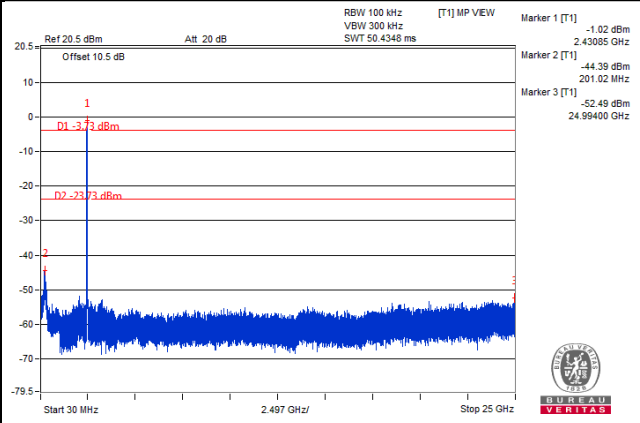
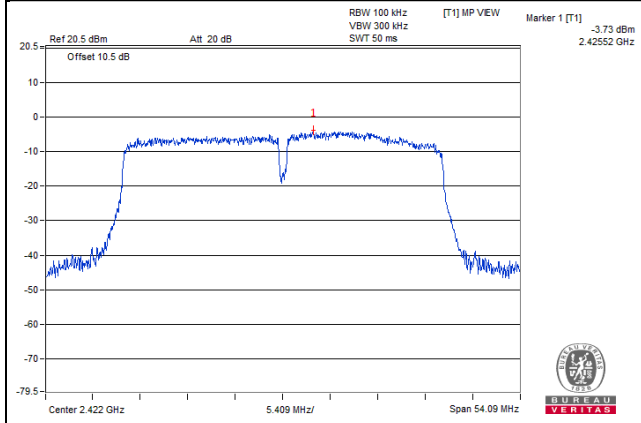

CH 6

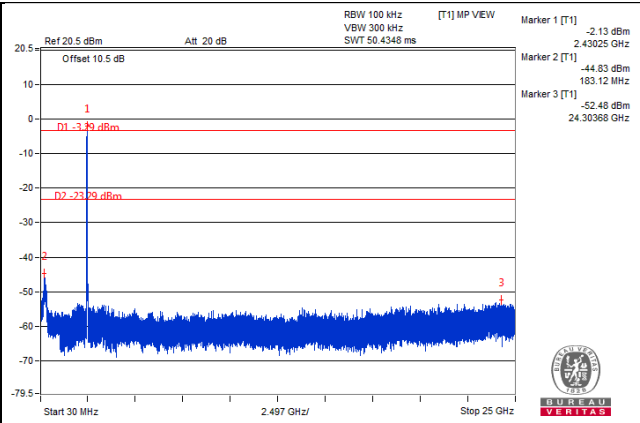
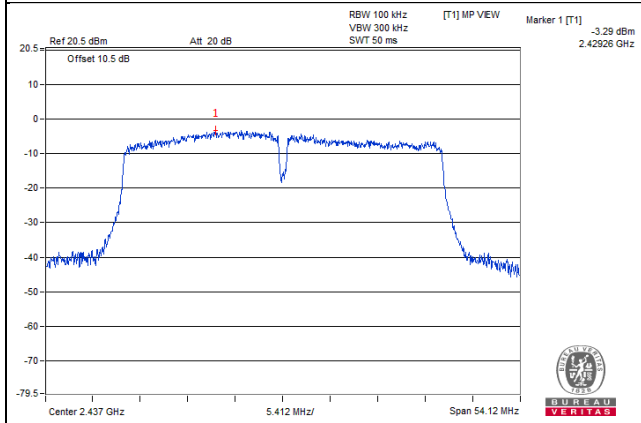

CH 9

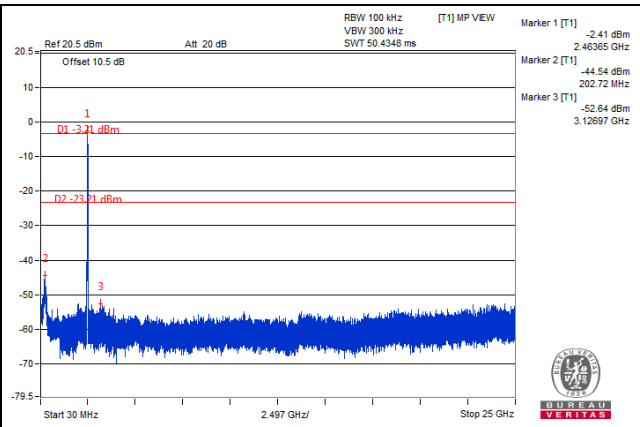
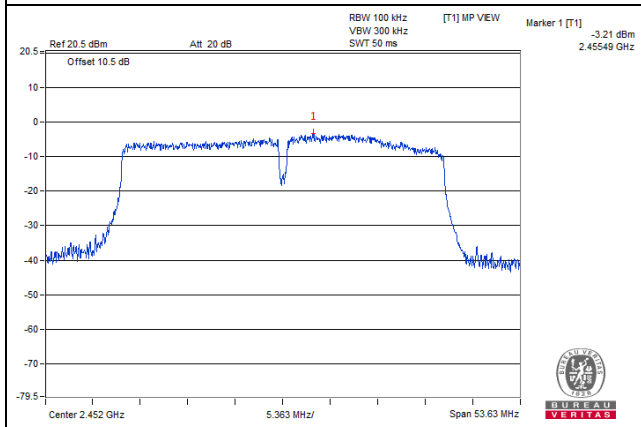



5 Pictures of Test Arrangements

Please refer to the attached file (Test Setup Photo).

Appendix – Information on the Testing Laboratories

We, Bureau Veritas Consumer Products Services (H.K.) Ltd., Taoyuan Branch, were founded in 1988 to provide our best service in EMC, Radio, Telecom and Safety consultation. Our laboratories are accredited and approved according to ISO/IEC 17025.

If you have any comments, please feel free to contact us at the following:

Linko EMC/RF Lab

Tel: 886-2-26052180

Fax: 886-2-26051924

Hsin Chu EMC/RF/Telecom Lab

Tel: 886-3-5935343

Fax: 886-3-5935342

Hwa Ya EMC/RF/Safety Lab

Tel: 886-3-3183232

Fax: 886-3-3270892

Email: service.adt@tw.bureauveritas.com

Web Site: www.bureauveritas-adt.com

The address and road map of all our labs can be found in our web site also.

--- END ---