



BUREAU  
VERITAS

Test Report No.: RF160316W001-4



# FCC TEST REPORT (PART 24)

**Product:** Mobile Phone  
**Model Name:** Lenovo A2016a40  
**FCC ID:** YCNA2016A40  
**Applicant:** Lenovo Mobile Communication Technology Ltd.  
**Address:** No.999, Qishan North 2nd Road, Information & Optoelectronics Park, Torch Hi-tech Industry Development Zone, Xiamen, P.R.China  
**Manufacturer 1:** Lenovo PC HK Limited  
**Address:** 23/F, Lincoln House, Taikoo Place 979 King's Road, Quarry Bay, Hong Kong  
**Manufacturer 2:** Motorola Mobility LLC  
**Address:** 222 W. Merchandise Mart Plaza, Chicago IL 60654 USA  
**Prepared by:** Bureau Veritas Shenzhen Co., Ltd. Dongguan Branch  
**Lab Location:** No. 34, Chenwulu Section, Guantai Rd., Houjie Town, Dongguan City, Guangdong 523942, China  
**TEL:** +86 769 8593 5656  
**FAX:** +86 769 8593 1080  
**E-MAIL:** [customerservice.dg@cn.bureauveritas.com](mailto:customerservice.dg@cn.bureauveritas.com)  
**Report No.:** RF160316W001-4  
**Received Date:** Apr. 15, 2016  
**Test Date:** Apr. 17, 2016 ~ May 17, 2016  
**Issued Date:** May 18, 2016

This report should not be used by the client to claim product certification, approval, or endorsement by A2LA or any government agencies.

Any copying or replication of this report to or for any other person or entity, or use of our name or trademark, is permitted only with our prior written permission. This report sets forth our findings solely with respect to the test samples identified herein. The results set forth in this report are not indicative or representative of the quality or characteristics of the lot from which a test sample was taken or any similar or identical product unless specifically and expressly noted. Our report includes all of the tests requested by you and the results thereof based upon the information that you provided to us. You have 60 days from date of issuance of this report to notify us of any material error or omission caused by our negligence, provided, however, that such notice shall be in writing and shall specifically address the issue you wish to raise. A failure to raise such issue within the prescribed time shall constitute your unqualified acceptance of the completeness of this report, the tests conducted and the correctness of the report contents. Unless specific mention, the uncertainty of measurement has been explicitly taken into account to declare the compliance or non-compliance to the specification.

Bureau Veritas Shenzhen Co., Ltd.  
Dongguan Branch

No. 34, Chenwulu Section, Guantai Rd.,  
Houjie Town, Dongguan City,  
Guangdong 523942, China

Tel: +86 769 8593 5656  
Fax: +86 769 8593 1080  
Email: [customerservice.dg@cn.bureauveritas.com](mailto:customerservice.dg@cn.bureauveritas.com)



## TABLE OF CONTENTS

<b>RELEASE CONTROL RECORD .....</b>	<b>4</b>
<b>1 CERTIFICATION .....</b>	<b>5</b>
<b>2 SUMMARY OF TEST RESULTS.....</b>	<b>6</b>
2.1 MEASUREMENT UNCERTAINTY .....	6
2.2 TEST SITE AND INSTRUMENTS.....	7
<b>3 GENERAL INFORMATION.....</b>	<b>8</b>
3.1 GENERAL DESCRIPTION OF EUT .....	8
3.2 CONFIGURATION OF SYSTEM UNDER TEST .....	8
3.3 DESCRIPTION OF SUPPORT UNITS.....	11
3.4 TEST ITEM AND TEST CONFIGURATION .....	11
3.5 EUT OPERATING CONDITIONS.....	13
3.6 GENERAL DESCRIPTION OF APPLIED STANDARDS .....	13
<b>4 TEST TYPES AND RESULTS.....</b>	<b>14</b>
4.1 OUTPUT POWER MEASUREMENT .....	14
4.1.1 LIMITS OF OUTPUT POWER MEASUREMENT .....	14
4.1.2 TEST PROCEDURES .....	14
4.1.3 TEST SETUP.....	15
4.1.4 TEST RESULTS .....	16
4.2 FREQUENCY STABILITY MEASUREMENT .....	18
4.2.1 LIMITS OF FREQUENCY STABILITY MEASUREMENT .....	18
4.2.2 TEST PROCEDURE.....	18
4.2.3 TEST SETUP.....	18
4.2.4 TEST RESULTS .....	19
4.3 OCCUPIED BANDWIDTH MEASUREMENT .....	20
4.3.1 TEST PROCEDURES .....	20
4.3.2 TEST SETUP .....	20
4.3.3 TEST RESULTS .....	21
4.4 BAND EDGE MEASUREMENT .....	23
4.4.1 LIMITS OF BAND EDGE MEASUREMENT .....	23
4.4.2 TEST SETUP.....	23
4.4.3 TEST PROCEDURES .....	23
4.4.4 TEST RESULTS.....	24
4.5 CONDUCTED SPURIOUS EMISSIONS .....	25
4.5.1 LIMITS OF CONDUCTED SPURIOUS EMISSIONS MEASUREMENT .....	25
4.5.2 TEST PROCEDURE.....	25
4.5.3 TEST SETUP.....	25
4.5.4 TEST RESULTS .....	26
4.6 RADIATED EMISSION MEASUREMENT.....	29
4.6.1 LIMITS OF RADIATED EMISSION MEASUREMENT .....	29
4.6.2 TEST PROCEDURES .....	29
4.6.3 DEVIATION FROM TEST STANDARD .....	29
4.6.4 TEST SETUP.....	30
4.6.5 TEST RESULTS .....	31
4.7 PEAK TO AVERAGE RATIO .....	39
4.7.1 LIMITS OF PEAK TO AVERAGE RATIO MEASUREMENT.....	39
4.7.2 TEST SETUP.....	39



4.7.3	TEST PROCEDURES .....	39
4.7.4	TEST RESULTS .....	40
<b>5</b>	<b>INFORMATION ON THE TESTING LABORATORIES.....</b>	<b>43</b>
<b>6</b>	<b>APPENDIX A – MODIFICATIONS RECORDERS FOR ENGINEERING CHANGES TO THE EUT BY THE LAB.....</b>	<b>44</b>



## RELEASE CONTROL RECORD

ISSUE NO.	REASON FOR CHANGE	DATE ISSUED
RF160316W001-4	Original release	May 18, 2016



## 1 CERTIFICATION

**PRODUCT:** Mobile Phone  
**BRAND NAME:** Lenovo  
**MODEL NAME:** Lenovo A2016a40  
**APPLICANT:** Lenovo Mobile Communication Technology Ltd.  
**TESTED:** Apr. 17, 2016 ~ May 17, 2016  
**TEST SAMPLE:** Identical Prototype  
**STANDARDS:** **FCC Part 24, Subpart E**

The above equipment has been tested by **Bureau Veritas Shenzhen Co., Ltd. Dongguan Branch**, and found compliance with the requirement of the above standards. The test record, data evaluation & Equipment Under Test (EUT) configurations represented herein are true and accurate accounts of the measurements of the sample's EMC characteristics under the conditions specified in this report.

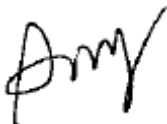
**PREPARED BY :** , **DATE:** May 18, 2016  
( Amyee Qian / Engineer)

**APPROVED BY :** , **DATE:** May 18, 2016  
( William Chung / Manager)



## 2 SUMMARY OF TEST RESULTS

The EUT has been tested according to the following specifications:

APPLIED STANDARD: FCC Part 24 & Part 2			
STANDARD SECTION	TEST TYPE	RESULT	REMARK
2.1046 24.232	Equivalent Isotropic Radiated Power	PASS	Meet the requirement of limit.
2.1055 24.235	Frequency Stability	PASS	Meet the requirement of limit.
2.1049 24.238(b)	Occupied Bandwidth	PASS	Meet the requirement of limit.
24.232(d)	Peak to average ratio	PASS	Meet the requirement of limit.
24.238(b)	Band Edge Measurements	PASS	Meet the requirement of limit.
2.1051 24.238	Conducted Spurious Emissions	PASS	Meet the requirement of limit.
2.1053 24.238	Radiated Spurious Emissions	PASS	Meet the requirement of limit. Minimum passing margin is -30.35dB at 5640.00MHz.

### 2.1 MEASUREMENT UNCERTAINTY

Where relevant, the following measurement uncertainty levels have been estimated for tests performed on the EUT as specified in CISPR 16-4-2:

MEASUREMENT	FREQUENCY	UNCERTAINTY
Conducted emissions	9kHz~30MHz	2.66dB
Radiated emissions	9KHz ~ 30MHz	2.74dB
	30MHz ~ 1GHz	3.55dB
	1GHz ~ 18GHz	4.84dB
	18GHz ~ 40GHz	1.94dB

This uncertainty represents an expanded uncertainty expressed at approximately the 95% confidence level using a coverage factor of k=2.



## 2.2 TEST SITE AND INSTRUMENTS

Equipment	Manufacturer	Model No.	Serial No.	Last Cal.	Next Cal.
EMI Test Receiver	Rohde&Schwarz	ESR7	101494	Apr. 05,16	Apr. 04,17
Signal and Spectrum Analyzer	Rohde&Schwarz	FSV40	101094	Apr. 05,16	Apr. 04,17
Bilog Antenna 1	Teseq	CBL 6111D	30643	Jun. 25,15	Jun. 24,16
Bilog Antenna 2	Teseq	CBL 6111D	27089	Jun. 25,15	Jun. 24,16
Horn Antenna	ETS-Lindgren	3117	00062558	May 30,14	May 29,16
Horn Antenna (15GHz-40GHz)	SCHWARZBECK	BBHA 9170	BBHA9170147	Jan. 21,14	Jan. 20,17
Amplifier	Burgeon	BPA-530	100220	Apr. 05,16	Apr. 04,17
Pre-Amplifier	HP	8449B	3008A00409	Apr. 25,15	Apr. 24,16
Pre-Amplifier (18GHz-40GHz)	EMCI	EMC 184045	980102	Nov. 11,15	Nov. 10,16
GPS Generator+ Antenna	TOJOIN	GNSS-5000A	E1-010119	Aug. 08, 14	Aug. 07, 16
3m Semi-anechoic Chamber	ETS-LINDGREN	9m*6m*6m	NSEMC003	Mar. 12,16	Mar. 11,18
Test Software	ADT	ADT_Radiated_V7.6.15.9.2	N/A	N/A	N/A
Power Meter	Anritsu	ML2495A	1139001	Feb.19,16	Feb. 18,17
Power Sensor	Anritsu	MA2411B	1126068	Feb.19,16	Feb. 18,17
Power Sensor	Keysight	U2021XA	MY55060016	May 27,15	May 26,16
Power Sensor	Keysight	U2021XA	MY55060018	May 27,15	May 26,16
Digital Multimeter	FLUKE	15B	A1220010DG	Oct. 12, 15	Oct.11, 16
Humid & Temp Programmable Tester	Haida	HD-2257	110807201	Sep.07,15	Sep. 06,16
Oscilloscope	Agilent	DSO9254A	MY51260160	Nov. 09,15	Nov. 08,16
Signal Analyzer	Rohde & Schwarz	FSV7	102331	Nov. 09,15	Nov. 08,16
Signal Generator	Agilent	N5183A	MY50140980	Apr. 21, 16	Apr. 20, 17
ESG Vector Signal Generator	Agilent	E4438C	MY49072505	Sep. 01,15	Aug. 31,16
BLUETOOTH TESTER	Rohde&Schwarz	CBT32	100811	Oct. 12, 15	Oct.11, 16

**NOTE:** 1. The calibration interval of the above test instruments is 12 months or 24 months and the calibrations are traceable to CEPREI/CHINA, GRGT/CHINA and NIM/CHINA.

2. The test was performed in Dongguan 966 Chamber and RF Oven.

3. The horn antenna are used only for the measurement of emission frequency above 1GHz if tested.

4. The FCC Site Registration No. is 502831.



### 3 GENERAL INFORMATION

#### 3.1 GENERAL DESCRIPTION OF EUT

<b>PRODUCT</b>	Mobile Phone	
<b>MODEL NAME</b>	Lenovo A2016a40	
<b>POWER SUPPLY</b>	5.0Vdc (adapter or host equipment) 3.8Vdc (Li-ion, battery)	
<b>MODULATION TYPE</b>	<b>GSM, GPRS:</b> GMSK <b>EDGE:</b> GMSK, 8PSK <b>WCDMA :</b> BPSK	
<b>FREQUENCY RANGE</b>	<b>GSM, GPRS, EDGE:</b> 1850.2MHz ~ 1909.8MHz	
	<b>WCDMA:</b> 1852.4MHz ~ 1907.6MHz	
<b>MAX. EIRP POWER</b>	<b>GSM:</b> 520mW	
	<b>EDGE:</b> 336mW	
	<b>WCDMA:</b> 222mW	
<b>EMISSION DESIGNATOR</b>	<b>GSM</b>	252KGXW
	<b>EDGE</b>	253KG7W
	<b>WCDMA</b>	4M22F9W
<b>ANTENNA TYPE</b>	Fixed Internal antenna with -0.4dBi gain	
<b>HW VERSION</b>	AL732_MB_PCB_V2.0_160220	
<b>SW VERSION</b>	A2016a40_S106_160308_8G_ROW	
<b>I/O PORTS</b>	Refer to user's manual	
<b>CABLE SUPPLIED</b>	USB cable: shielded, detachable, 0.7meter Earphone cable: Unshielded, detachable, 1.3meter	

**NOTE:**

1. For a more detailed features description, please refer to the manufacturer's specifications or the user's manual.
2. For the test results, the EUT had been tested with all conditions. But only the worst case was shown in test report.



**LIST OF ACCESSORIES:**

<b>ACCESSORIES</b>	<b>BRAND</b>	<b>MANUFACTURER</b>	<b>MODEL</b>	<b>SPECIFICATION</b>
AC Adapter 1	Lenovo	CHENYANG	C-P56	I/P:100-240Vac, 130mA O/P:5Vdc, 1000mA
AC Adapter 2	Lenovo	Acbel	C-P56	I/P:100-240Vac, 130mA O/P:5Vdc, 1000mA
Battery 1	Lenovo	ATL	BL253	Rating: 3.8Vdc, 2000mAh
Battery 2	Lenovo	VK	BL253	Rating: 3.8Vdc, 2000mAh
Earphone 1	Lenovo	TIANZHI	TJ101247A	1.3m non-shielded cable w/o core
Earphone 2	Lenovo	LIANYUN	TS990B-28AMS05-M	1.3m non-shielded cable w/o core
USB Cable 1	Lenovo	FUKANGYUAN	F16W-05100070L	0.7m non-shielded cable w/o core
USB Cable 2	Lenovo	LIQI	L16W-05100070L	0.7m non-shielded cable w/o core
LCD Panel 1	HELITAI	--	QTB4D543	--
LCD Panel 2	TONGXING DA	--	TXDT450SKP-73V6	--
Photo Camera 1	BOLIXIN	--	BLX2355H-AL732-F	--
Photo Camera 2	HUAQUAN	--	G6P2-AL732FHQ	--
Video Camera 1	QUNHUI	--	SHT6029B1S-1P0J0	--
Video Camera 2	HUAQUAN	--	G7B5-AL732BHQ	--
Main Broad 1	HUASHEN	--	AL732_MB_PCB_V2.0	--
Main Broad 2	YILIANDA	--	AL732_MB_PCB_V2.0	--
BT/WLAN Module	MTK	--	MT6625L	--
WWAN Module	NA	--	NA	--



### 3.2 CONFIGURATION OF SYSTEM UNDER TEST

#### FOR RADIATION EMISSION TEST

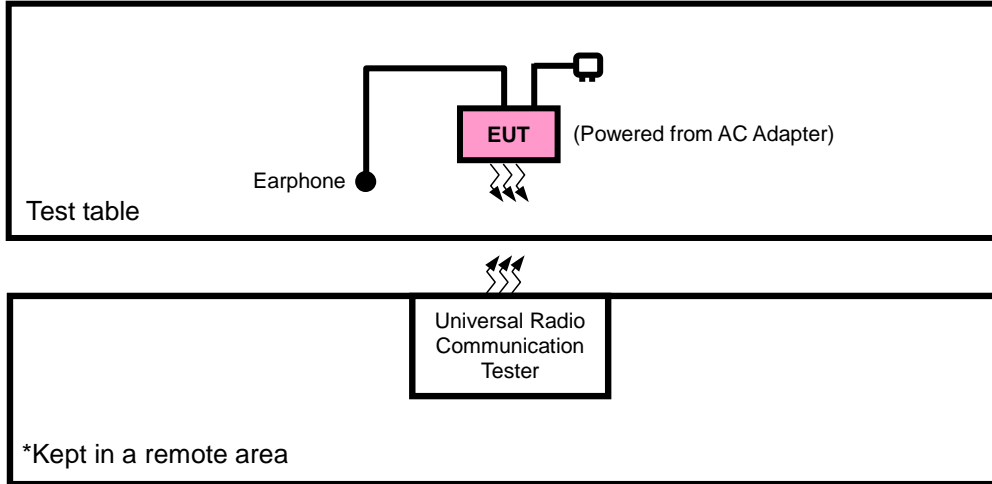

#### FOR E.I.R.P. TEST

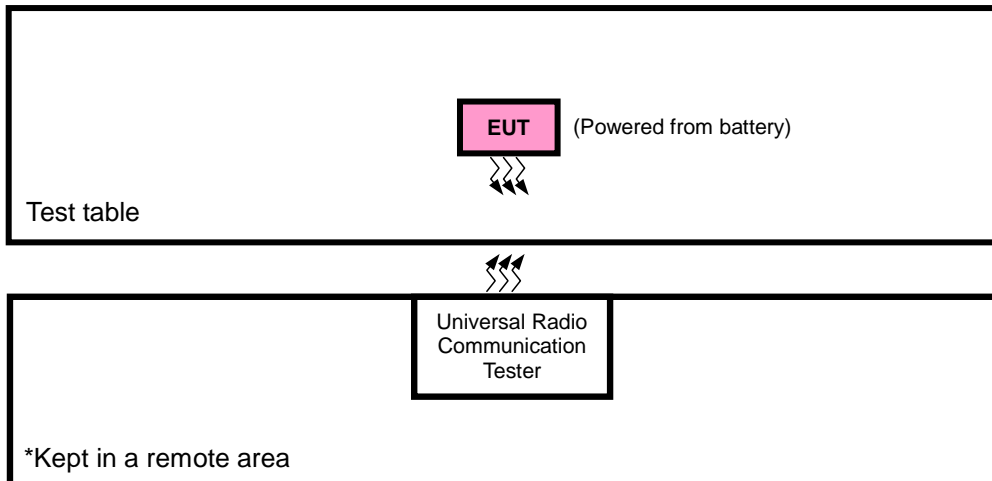



### 3.3 DESCRIPTION OF SUPPORT UNITS

The EUT has been tested as an independent unit together with other necessary accessories or support units. The following support units or accessories were used to form a representative test configuration during the tests.

NO.	PRODUCT	BRAND	MODEL NO.	SERIAL NO.	FCC ID
1	DC source	LONG WEI	PS-6403D	010934269	N/A
2	PC	HP	A6608CN	3CR83825X3	N/A

NO.	SIGNAL CABLE DESCRIPTION OF THE ABOVE SUPPORT UNITS
1	DC Line: Unshielded, Detachable 1.0m
2	AC Line :Unshielded, Detachable 1.5m

### 3.4 TEST ITEM AND TEST CONFIGURATION

Pre-Scan has been conducted to determine the worst-case mode from all possible combinations between available modulations, data rates, XYZ axis and antenna ports. The worst case was found when positioned on Y-plane for EIRP and X-axis for radiated emission. Following channel(s) was (were) selected for the final test as listed below:

EUT CONFIGURE MODE	DESCRIPTION
A	EUT + Adapter + USB Cable + Earphone with GSM, WCDMA
B	EUT + Battery + USB Cable + Earphone with GSM, WCDMA

#### GSM MODE

EUT CONFIGURE MODE	TEST ITEM	AVAILABLE CHANNEL	TESTED CHANNEL	MODE
B	EIRP	512 to 810	512, 661, 810	GSM, EDGE
B	FREQUENCY STABILITY	512 to 810	661	GSM, EDGE
B	OCCUPIED BANDWIDTH	512 to 810	512, 661, 810	GSM, EDGE
B	PEAK TO AVERAGE RATIO	512 to 810	661	GSM, EDGE
B	BAND EDGE	512 to 810	512, 810	GSM, EDGE
B	CONDCUDED EMISSION	512 to 810	661	GSM, EDGE
A	RADIATED EMISSION	512 to 810	661	GSM, EDGE



**WCDMA MODE**

EUT CONFIGURE MODE	TEST ITEM	AVAILABLE CHANNEL	TESTED CHANNEL	MODE
B	EIRP	9262 to 9538	9262, 9400, 9538	WCDMA
B	FREQUENCY STABILITY	9262 to 9538	9400	WCDMA
B	OCCUPIED BANDWIDTH	9262 to 9538	9262, 9400, 9538	WCDMA
B	PEAK TO AVERAGE RATIO	9262 to 9538	9400	WCDMA
B	BAND EDGE	9262 to 9538	9262, 9538	WCDMA
B	CONDCUDED EMISSION	9262 to 9538	9400	WCDMA
A	RADIATED EMISSION	9262 to 9538	9400	WCDMA

**TEST CONDITION:**

TEST ITEM	ENVIRONMENTAL CONDITIONS	INPUT POWER	TESTED BY
EIRP	25deg. C, 57%RH	DC 3.8V from battery	Alex Chen
FREQUENCY STABILITY	23deg. C, 61%RH	DC 3.8V from battery	Yuqiang Yin
OCCUPIED BANDWIDTH	23deg. C, 61%RH	DC 3.8V from battery	Yuqiang Yin
PEAK TO AVERAGE RATIO	23deg. C, 61%RH	DC 3.8V from battery	Yuqiang Yin
BAND EDGE	23deg. C, 61%RH	DC 3.8V from battery	Yuqiang Yin
CONDCUDED EMISSION	23deg. C, 61%RH	DC 3.8V from battery	Yuqiang Yin
RADIATED EMISSION	25deg. C, 57%RH	5Vdc from adapter	Alex Chen



### 3.5 EUT OPERATING CONDITIONS

The EUT makes a call to the communication simulator. The communication simulator station system controlled a EUT to export maximum output power under transmission mode and specific channel frequency

### 3.6 GENERAL DESCRIPTION OF APPLIED STANDARDS

The EUT is a RF product. According to the specifications of the manufacturer, it must comply with the requirements of the following standards:

**FCC 47 CFR Part 2**

**FCC 47 CFR Part 24**

**KDB 971168 D01 Power Meas License Digital Systems v02r02**

**ANSI/TIA/EIA-603-D**

**NOTE:** All test items have been performed and recorded as per the above standards.



## 4 TEST TYPES AND RESULTS

### 4.1 OUTPUT POWER MEASUREMENT

#### 4.1.1 LIMITS OF OUTPUT POWER MEASUREMENT

Mobile and portable stations are limited to 2 watts EIRP

#### 4.1.2 TEST PROCEDURES

##### **EIRP MEASUREMENT:**

- a. All measurements were done at low, middle and high operational frequency range. RBW and VBW is 1MHz for GSM, GPRS & EDGE ; 5MHz for WCDMA mode and 10MHz for LTE mode.
- b. Substitution method is used for E.I.R.P measurement. In the semi-anechoic chamber, EUT placed on the 0.8m height of Turn Table, rotated the table around 360 degrees to search the maximum radiation power and receiver antenna shall be rotated vertical and horizontal polarization and moved height from 1m to 4m to find the maximum polar radiated power. The “Read Value” is the spectrum reading the maximum power value.
- c. The substitution horn antenna is substituted for EUT at the same position and signals generator export the CW signal to the substitution antenna via a tx cable. Rotated the Turn Table and moved receiving antenna to find the maximum radiation power. Adjust output power level of S.G to get a Value of spectrum reading equal to “Read Value “ of step b. Record the power level of S.G
- d.  $EIRP = \text{Output power level of S.G} - \text{TX cable loss} + \text{Antenna gain of substitution horn.}$

##### **CONDUCTED POWER MEASUREMENT:**

The EUT was set up for the maximum power with GSM, GPRS, EDGE & WCDMA link data modulation and link up with simulator. Set the EUT to transmit under low, middle and high channel and record the power level shown on simulator.



### 4.1.3 TEST SETUP

#### EIRP MEASUREMENT:

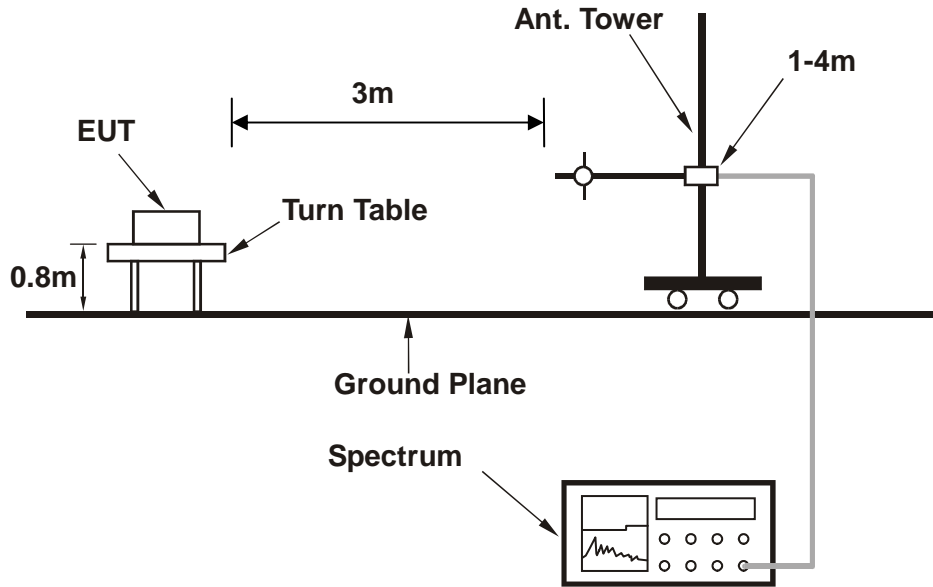

For the actual test configuration, please refer to the attached file (Test Setup Photo).

#### CONDUCTED POWER MEASUREMENT:

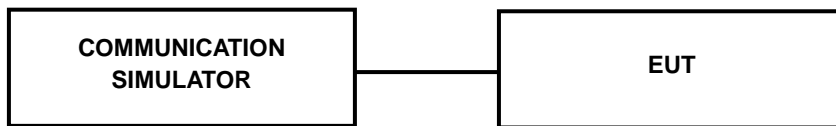

For the actual test configuration, please refer to the attached file (Test Setup Photo).



#### 4.1.4 TEST RESULTS

##### CONDUCTED OUTPUT POWER (dBm)

Band	GSM1900		
Channel	512	661	810
Frequency (MHz)	1850.2	1880.0	1909.8
GSM	30.58	30.39	30.35
GPRS 8	30.57	30.38	30.34
GPRS 10	29.72	29.59	29.57
GPRS 11	27.70	27.71	27.90
GPRS 12	26.88	26.64	26.72
EDGE 8 (MCS9)	26.29	26.08	26.20
EDGE 10 (MCS9)	25.16	25.02	25.08
EDGE 11 (MCS9)	23.13	23.01	23.08
EDGE 12 (MCS9)	22.01	21.93	22.01

Band	WCDMA II		
Channel	9262	9400	9538
Frequency (MHz)	1852.4	1880.0	1907.6
RMC 12.2K	23.15	23.33	23.16
HSPA			
HSDPA Subtest-1	22.11	22.24	22.23
HSDPA Subtest-2	22.10	22.21	22.18
HSDPA Subtest-3	21.62	21.75	21.72
HSDPA Subtest-4	21.60	21.74	21.71
HSUPA Subtest-1	22.10	22.08	22.07
HSUPA Subtest-2	20.16	20.07	20.06
HSUPA Subtest-3	21.11	21.05	21.03
HSUPA Subtest-4	20.13	20.05	20.01
HSUPA Subtest-5	22.14	22.27	22.25





EIRP POWER (dBm)

GSM

Channel	Frequency (MHz)	LVL (dBm)	Correction Factor(dB)	EIRP(dBm)	EIRP(mW)	Polarization (H/V)
512	1850.2	-21.47	43.83	22.36	172.19	H
661	1880.0	-21.34	43.57	22.23	167.11	H
810	1909.8	-22.08	44.57	22.49	177.42	H
512	1850.2	-19.42	46.39	26.97	497.74	V
661	1880.0	-19.94	47.10	27.16	<b>519.76</b>	V
810	1909.8	-19.53	45.98	26.45	441.16	V

EDGE

Channel	Frequency (MHz)	LVL (dBm)	Correction Factor(dB)	EIRP(dBm)	EIRP(mW)	Polarization (H/V)
512	1850.2	-23.47	43.83	20.36	108.64	H
661	1880.0	-22.69	43.57	20.88	122.46	H
810	1909.8	-22.23	44.57	22.34	171.40	H
512	1850.2	-21.92	46.39	24.47	279.90	V
661	1880.0	-21.83	47.10	25.27	<b>336.36</b>	V
810	1909.8	-21.66	45.98	24.32	270.15	V

WCDMA

Channel	Frequency (MHz)	LVL (dBm)	Correction Factor(dB)	EIRP(dBm)	EIRP(mW)	Polarization (H/V)
9262	1852.4	-25.87	43.83	17.96	62.52	H
9400	1880.0	-24.69	43.57	18.88	77.27	H
9538	1907.6	-25.75	44.57	18.82	76.21	H
9262	1852.4	-22.95	46.39	23.44	220.80	V
9400	1880.0	-23.64	47.10	23.46	<b>221.72</b>	V
9538	1907.6	-23.97	45.98	22.01	158.71	V

- REMARKS:** 1. EIRP Output Power (dBm) = LVL (dBm) + Correction Factor (dB).  
2. Correction factor (dB) = Free Space Loss + Antenna Factor + Cable Loss



## 4.2 FREQUENCY STABILITY MEASUREMENT

### 4.2.1 LIMITS OF FREQUENCY STABILITY MEASUREMENT

The frequency stability shall be sufficient to ensure that the fundamental emission stays within the authorized frequency block.

### 4.2.2 TEST PROCEDURE

- Device is placed at the oven room. The oven room could control the temperatures and humidity. Power warm up is at least 15 min and power applied should perform before recording frequency error.
- EUT is connected the external power supply to control the DC input power. The test voltage range is from minimum to maximum working voltage. Each step shall be record the frequency error rate.
- The temperature range step is 10 degrees in this test items. All temperature levels shall be hold the  $\pm 0.5^{\circ}\text{C}$  during the measurement testing. The each temperature step shall be at least 0.5 hours, consider the EUT could be test under the stability condition.

**NOTE:** The frequency error was recorded frequency error from the communication simulator.

### 4.2.3 TEST SETUP

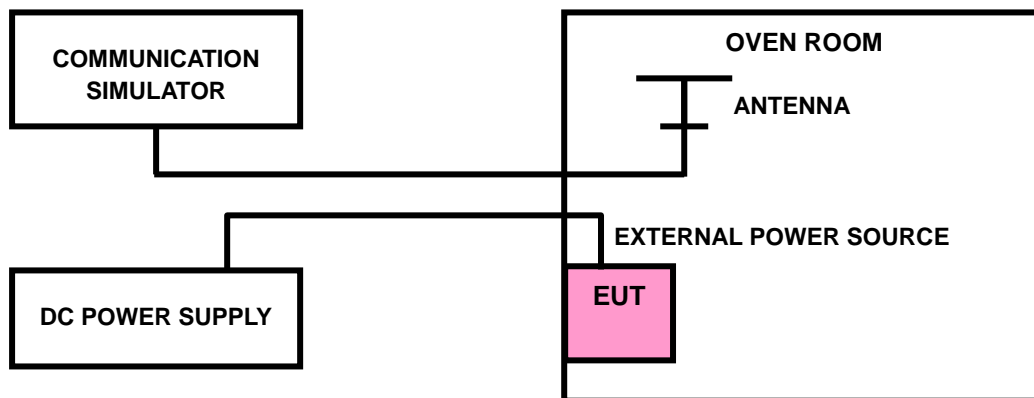



#### 4.2.4 TEST RESULTS

##### FREQUENCY ERROR VS. VOLTAGE

VOLTAGE (Volts)	FREQUENCY ERROR (ppm)			LIMIT (ppm)
	GSM	EDGE	WCDMA	
3.8	0.0011	0.0012	0.0014	2.5
3.45	-0.0019	-0.0016	-0.0018	2.5
4.4	-0.0015	-0.0015	-0.0015	2.5

**NOTE:** The applicant defined the normal working voltage of the battery is from 3.45Vdc to 4.4Vdc.

##### FREQUENCY ERROR vs. TEMPERATURE.

TEMP. (°C)	FREQUENCY ERROR (ppm)			LIMIT (ppm)
	GSM	EDGE	WCDMA	
-30	-0.0056	-0.0059	-0.0049	2.5
-20	-0.0049	-0.0053	-0.0043	2.5
-10	-0.0042	-0.0047	-0.0033	2.5
0	-0.0036	-0.0038	-0.0026	2.5
10	-0.0031	-0.0031	-0.0019	2.5
20	-0.0024	-0.0024	-0.0012	2.5
30	-0.0017	-0.0017	-0.0006	2.5
40	-0.0011	-0.0011	0.0000	2.5
50	-0.0005	-0.0004	0.0005	2.5
60	0.0002	0.0003	0.0007	2.5



## 4.3 OCCUPIED BANDWIDTH MEASUREMENT

### 4.3.1 TEST PROCEDURES

The EUT makes a call to the communication simulator. All measurements were done at low, middle and high operational frequency range. The communication simulator station system controlled a EUT to export maximum output power under transmission mode and specific channel frequency. Use OBW measurement function of Spectrum analyzer to measure 99 % occupied bandwidth.

### 4.3.2 TEST SETUP

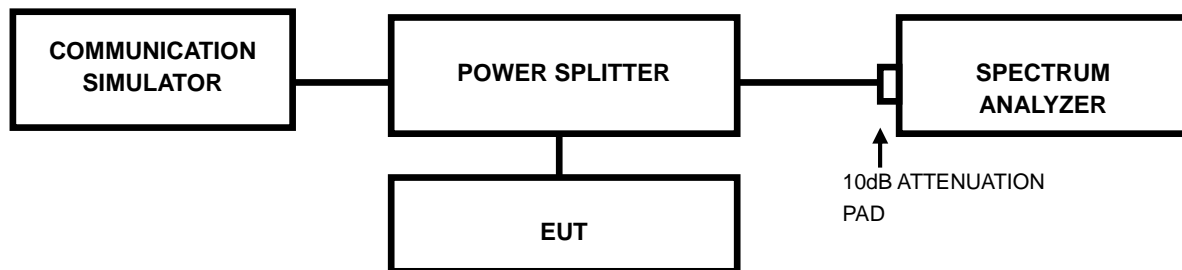



**4.3.3 TEST RESULTS**

CHANNEL	FREQUENCY (MHz)	99% OCCUPIED BANDWIDTH (kHz)		CHANNEL	FREQUENCY (MHz)	99% OCCUPIED BANDWIDTH (MHz)
		GSM	EDGE			WCDMA
512	1850.2	245.00	244.00	9262	1852.4	4.21
661	1880.0	249.00	245.00	9400	1880.0	4.21
810	1909.8	252.00	253.00	9538	1907.6	4.22

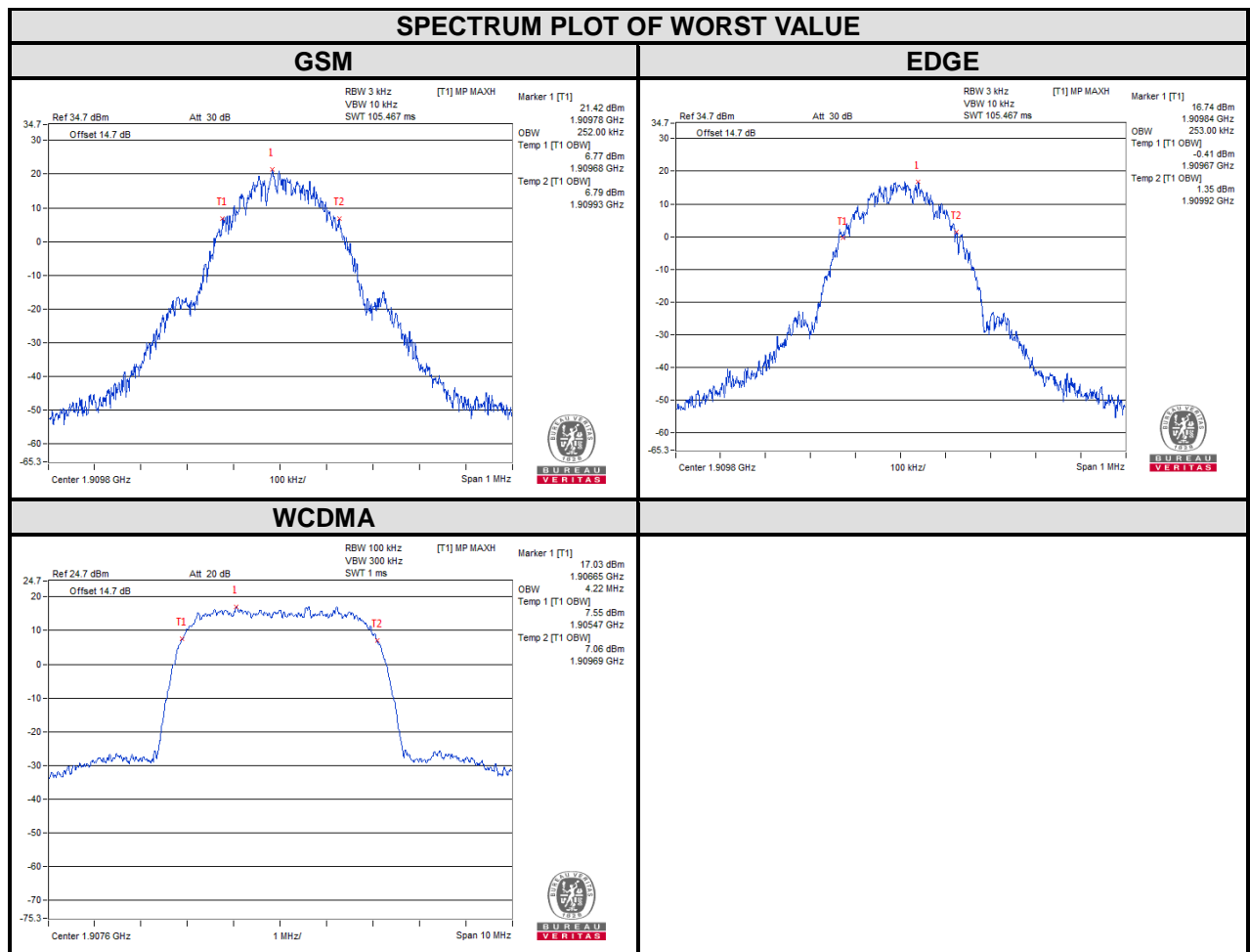



CHANNEL	FREQUENCY (MHz)	26dB BANDWIDTH (kHz)		CHANNEL	FREQUENCY (MHz)	26dB BANDWIDTH (MHz)
		GSM	EDGE			WCDMA
512	1850.2	320.86	319.97	9262	1852.4	4.89
661	1880.0	322.69	325.11	9400	1880.0	4.87
810	1909.8	316.87	322.66	9538	1907.6	4.86

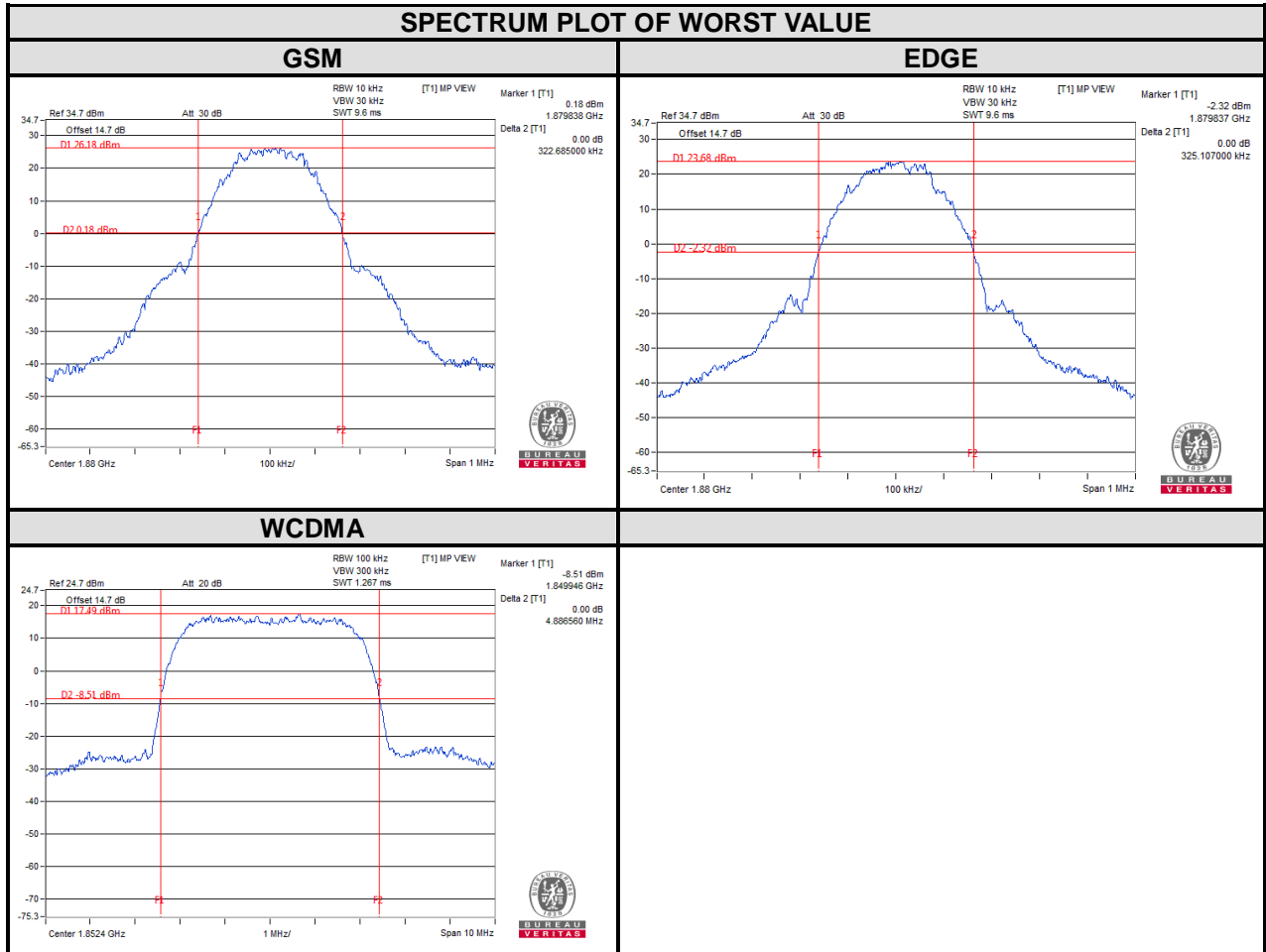



## 4.4 BAND EDGE MEASUREMENT

### 4.4.1 LIMITS OF BAND EDGE MEASUREMENT

Power of any emission outside of the authorized operating frequency ranges must be attenuated below the transmitting power (P) by a factor of at least  $43 + 10 \log(P)$  dB. In the 1 MHz bands immediately outside and adjacent to the frequency block a resolution bandwidth of at least one percent of the emission bandwidth of the fundamental emission of the transmitter may be employed.

### 4.4.2 TEST SETUP

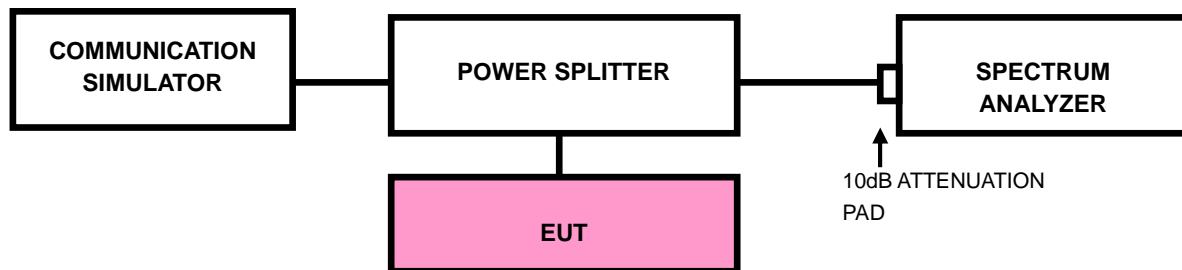

### 4.4.3 TEST PROCEDURES

- All measurements were done at low and high operational frequency range.
- The center frequency of spectrum is the band edge frequency and span is 1.5 MHz. RBW of the spectrum is 10kHz and VBW of the spectrum is 30kHz (GSM/GPRS/EDGE).
- The center frequency of spectrum is the band edge frequency and span is 10MHz. RB of the spectrum is 100kHz and VB of the spectrum is 300kHz (WCDMA).
- Record the max trace plot into the test report.



### 4.4.4. TEST RESULTS

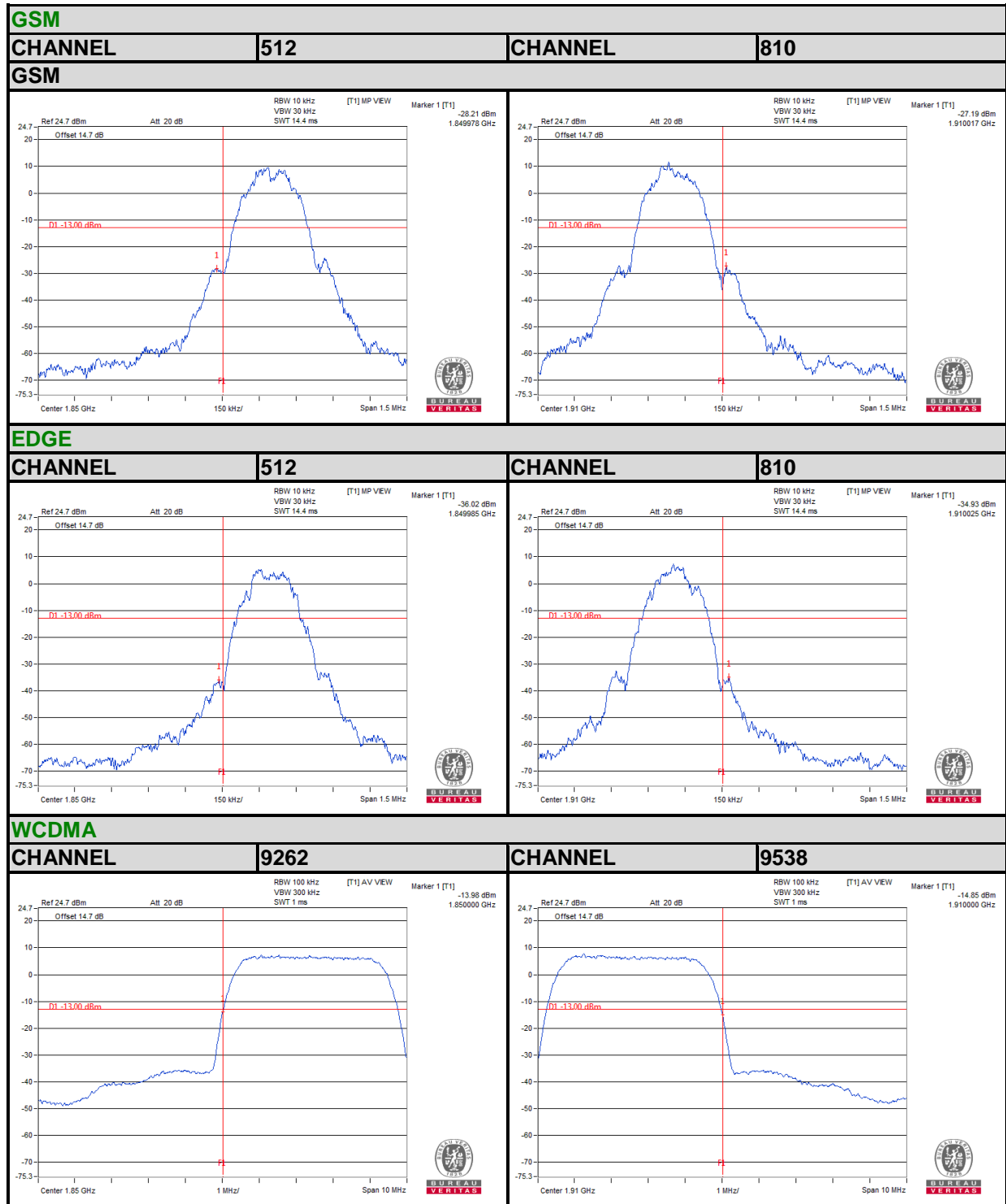





## 4.5 CONDUCTED SPURIOUS EMISSIONS

### 4.5.1 LIMITS OF CONDUCTED SPURIOUS EMISSIONS MEASUREMENT

The power of any emission outside of the authorized operating frequency ranges must be attenuated below the transmitting power (P) by a factor of at least  $43 + 10 \log(P)$  dB. The emission limit equal to  $-13$ dBm.

### 4.5.2 TEST PROCEDURE

- a. The EUT makes a phone call to the communication simulator. All measurements were done at low, middle and high operational frequency range.
- b. Measuring frequency range is from 9 kHz to 19.1GHz. 20dB attenuation pad is connected with spectrum. RBW=1MHz and VBW=3MHz is used for conducted emission measurement.

### 4.5.3 TEST SETUP

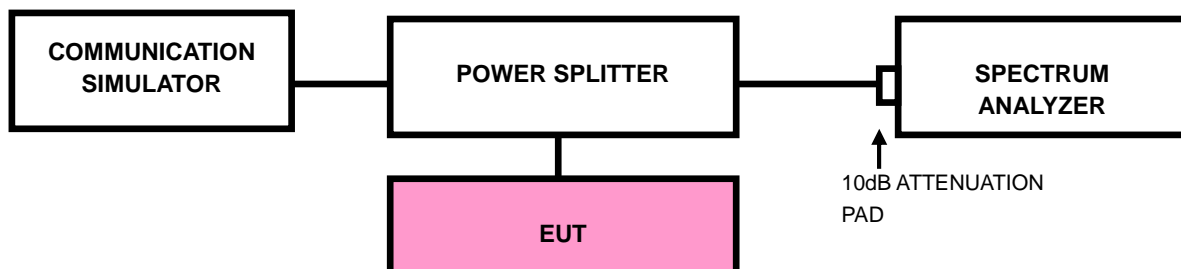



### 4.5.4 TEST RESULTS

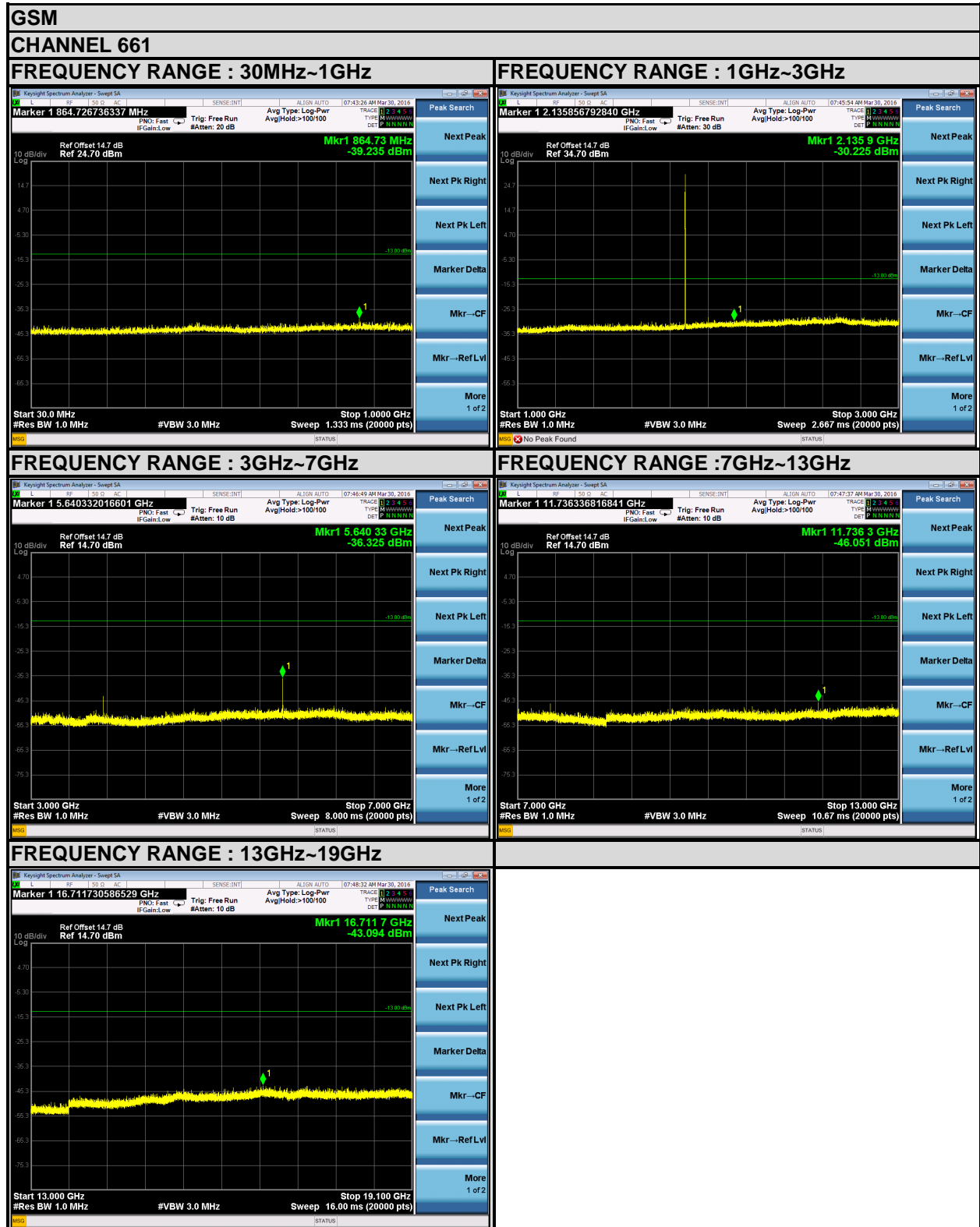

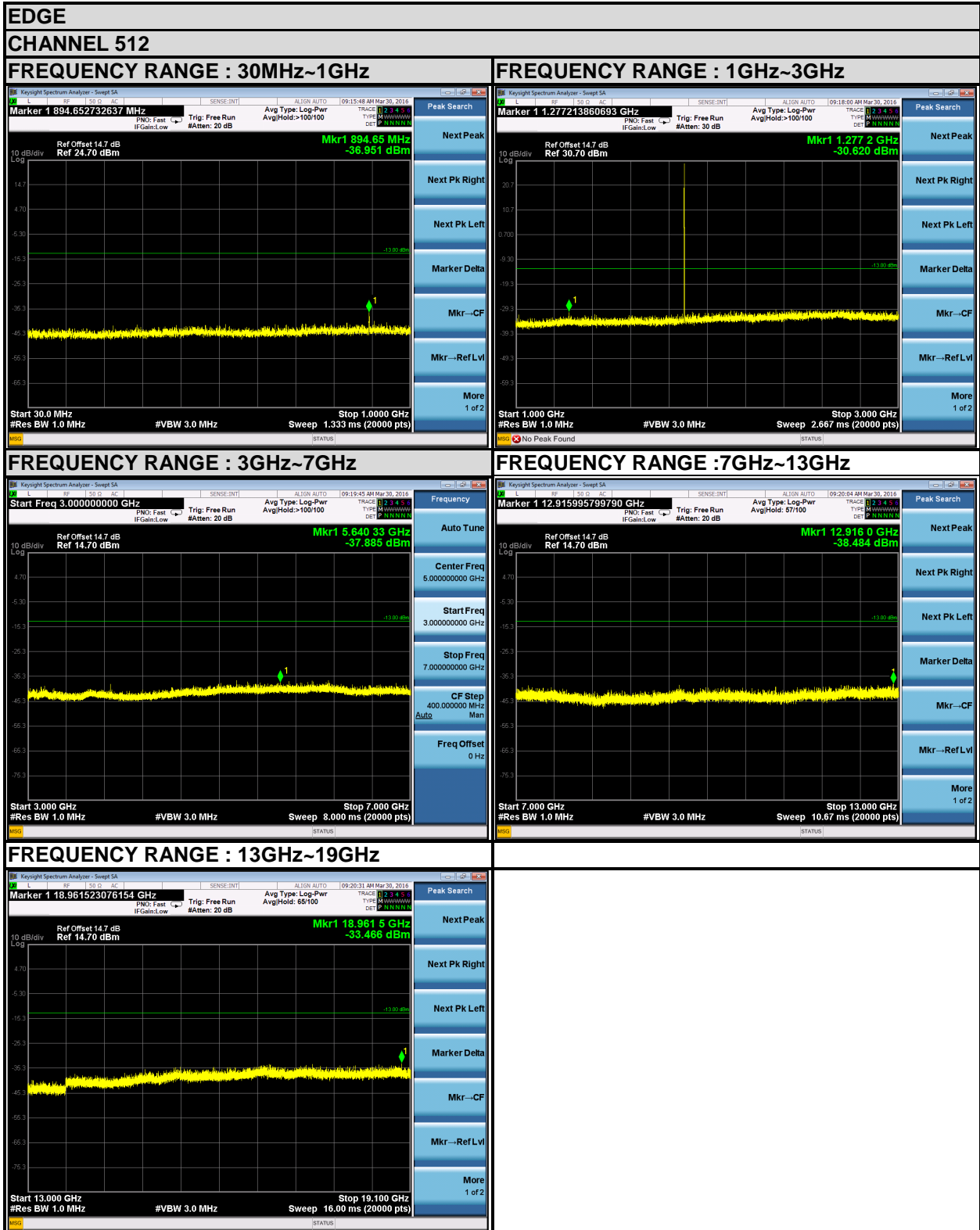

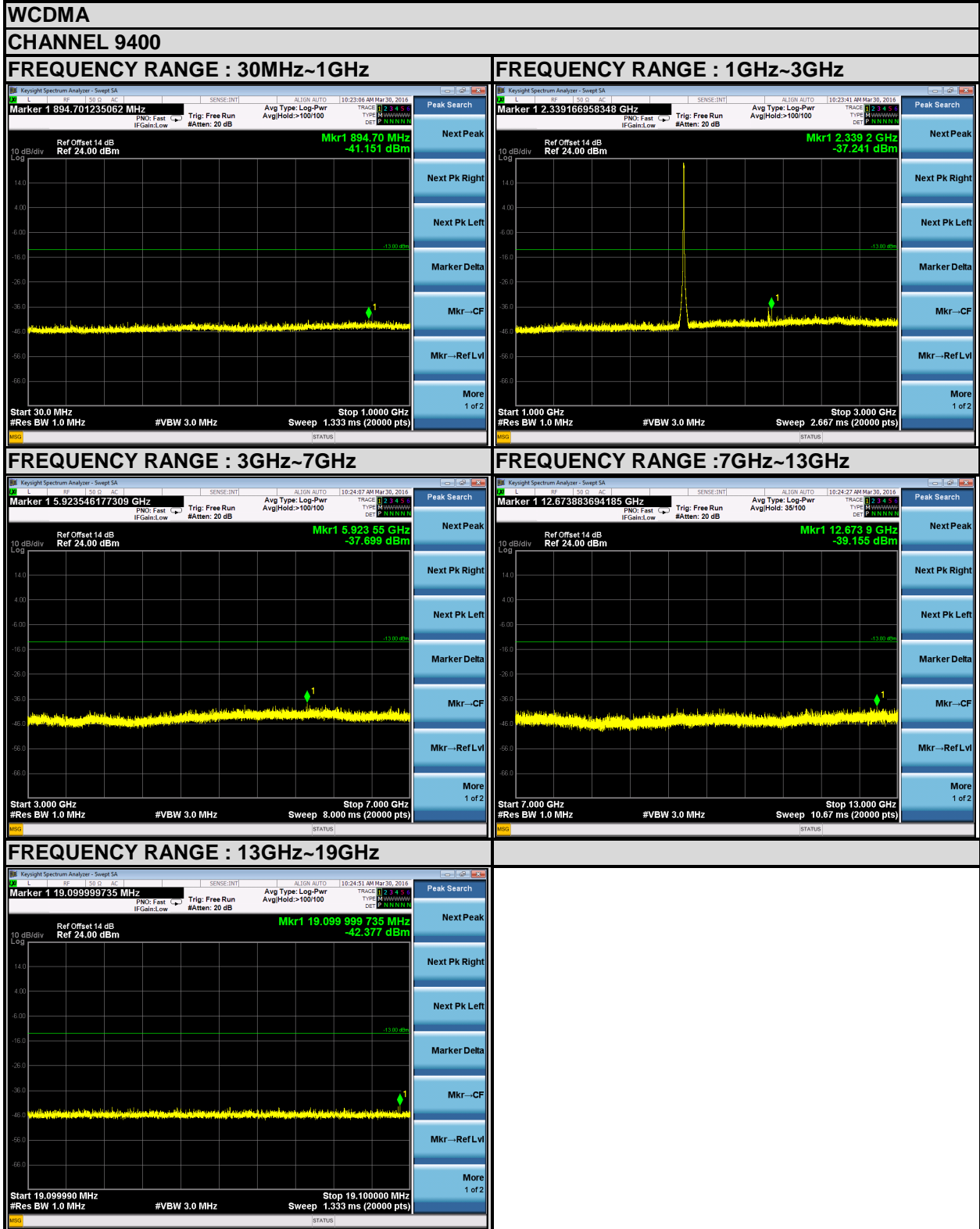



## 4.6 RADIATED EMISSION MEASUREMENT

### 4.6.1 LIMITS OF RADIATED EMISSION MEASUREMENT

The power of any emission outside of the authorized operating frequency ranges must be attenuated below the transmitting power (P) by a factor of at least  $43 + 10 \log(P)$  dB. The emission limit equal to  $-13\text{dBm}$ .

### 4.6.2 TEST PROCEDURES

- a. Substitution method is used for E.I.R.P measurement. In the semi-anechoic chamber, EUT placed on the 0.8m height of Turn Table, rotated the table around 360 degrees to search the maximum radiation power and receiver antenna shall be rotated vertical and horizontal polarization and moved height from 1m to 4m to find the maximum polar radiated power. The “Read Value” is the spectrum reading the maximum power value.
- b. The substitution horn antenna is substituted for EUT at the same position and signals generator export the CW signal to the substitution antenna via a TX cable. Rotated the Turn Table and moved receiving antenna to find the maximum radiation power. Adjust output power level of S.G to get a Value of spectrum reading equal to “Read Value “ of step a. Record the power level of S.G
- c.  $\text{EIRP} = \text{Output power level of S.G} - \text{TX cable loss} + \text{Antenna gain of substitution horn}$ .

**NOTE:** The resolution bandwidth and video bandwidth of test receiver/spectrum analyzer is 1MHz/3MHz.

### 4.6.3 DEVIATION FROM TEST STANDARD

No deviation



#### 4.6.4 TEST SETUP

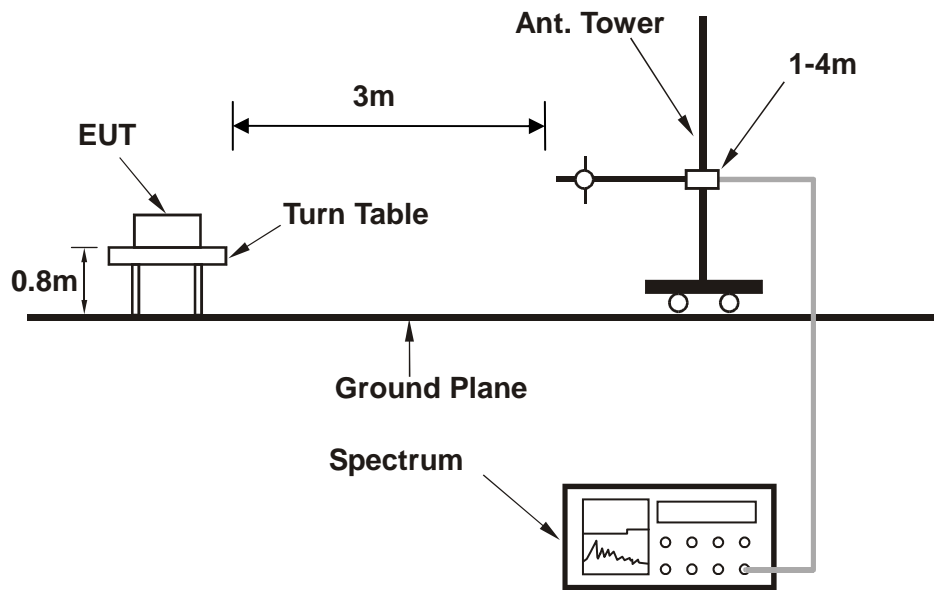

For the actual test configuration, please refer to the attached file (Test Setup Photo).



### 4.6.5 TEST RESULTS

#### BELOW 1GHz WORST-CASE DATA

#### PCS1900

<b>MODE</b>	TX channel 661	<b>FREQUENCY RANGE</b>	Below 1000MHz
<b>ENVIRONMENTAL CONDITIONS</b>	26deg. C, 56%RH	<b>INPUT POWER</b>	DC 5V from adapter
<b>TESTED BY</b>	Alex Chen		
<b>ANTENNA POLARITY &amp; TEST DISTANCE: HORIZONTAL AT 3 M</b>			

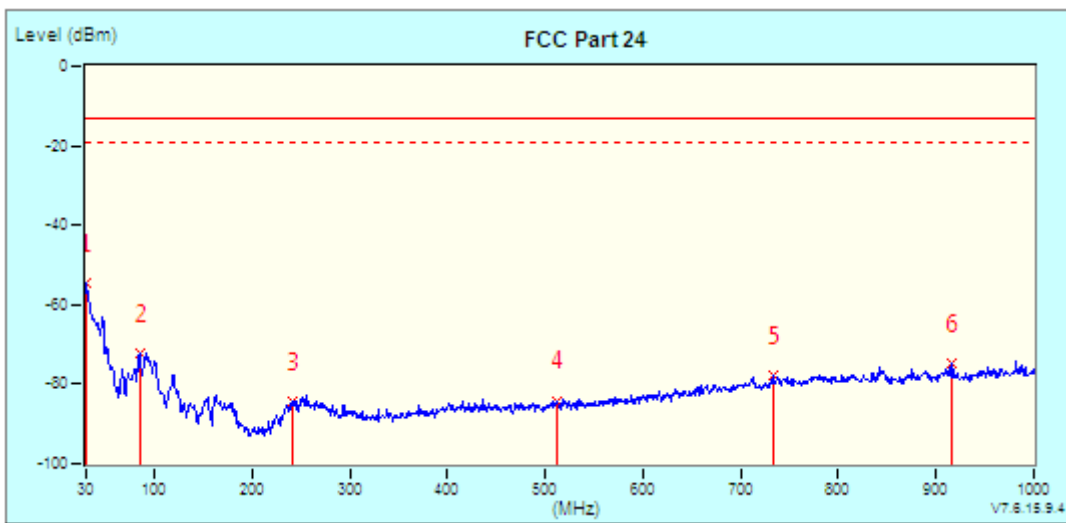

No.	Frequency MHz	Factor dB	Reading dBm	Emission dBm	Limit dBm	Margin dB	Tower / Table cm deg
*	1	19.34	-73.69	-54.35	-13.00	-41.35	-- --
	2	-8.38	-63.74	-72.12	-13.00	-59.12	-- --
	3	-16.46	-67.94	-84.40	-13.00	-71.40	-- --
	4	-10.18	-73.91	-84.09	-13.00	-71.09	-- --
	5	-4.92	-73.04	-77.96	-13.00	-64.96	-- --
	6	-3.39	-71.40	-74.79	-13.00	-61.79	-- --



<b>MODE</b>	TX channel 661	<b>FREQUENCY RANGE</b>	Below 1000MHz
<b>ENVIRONMENTAL CONDITIONS</b>	26deg. C, 56%RH	<b>INPUT POWER</b>	DC 5V from adapter
<b>TESTED BY</b>	Alex Chen		
<b>ANTENNA POLARITY &amp; TEST DISTANCE: VERTICAL AT 3 M</b>			

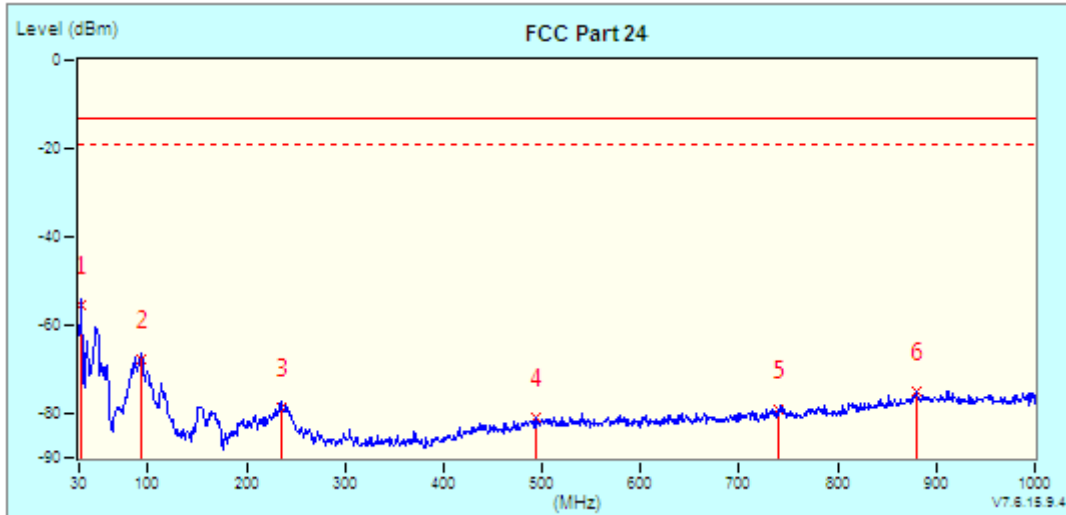

No.	Frequency MHz	Factor dB	Reading dBm	Emission dBm	Limit dBm	Margin dB	Tower / Table cm deg	
*	1	1.46	-56.72	-55.26	-13.00	-42.26	--	--
	2	-10.58	-57.11	-67.69	-13.00	-54.69	--	--
	3	-11.25	-67.17	-78.42	-13.00	-65.42	--	--
	4	-7.48	-73.42	-80.90	-13.00	-67.90	--	--
	5	-5.85	-73.08	-78.93	-13.00	-65.93	--	--
	6	-2.99	-72.16	-75.15	-13.00	-62.15	--	--





**ABOVE 1GHz DATA**

**PCS 1900:**

<b>MODE</b>	TX channel 661	<b>FREQUENCY RANGE</b>	Above 1000MHz
<b>ENVIRONMENTAL CONDITIONS</b>	26deg. C, 56%RH	<b>INPUT POWER</b>	DC 5V from adapter
<b>TESTED BY</b>	Alex Chen		
<b>ANTENNA POLARITY &amp; TEST DISTANCE: HORIZONTAL AT 3 M</b>			

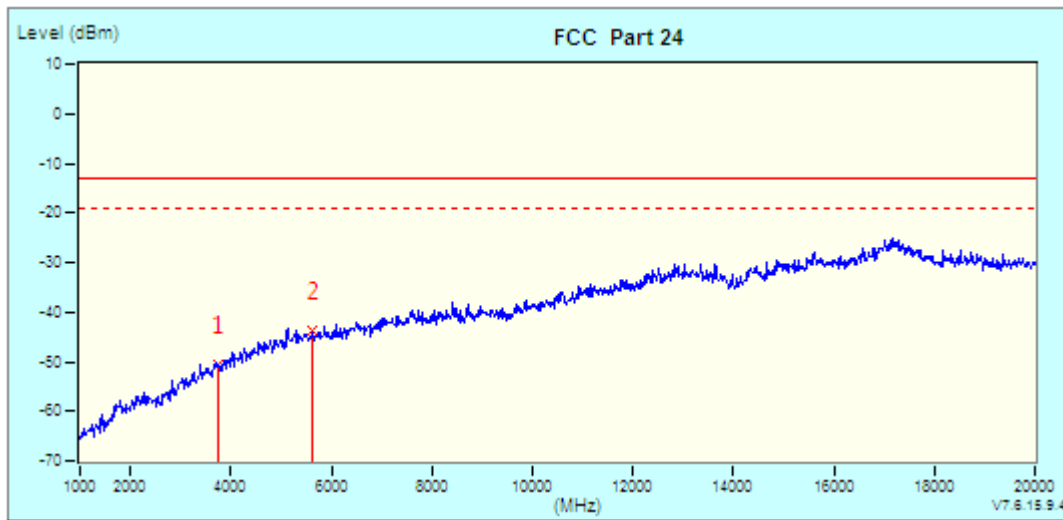

No.	Frequency MHz	Factor dB	Reading dBm	Emission dBm	Limit dBm	Margin dB	Tower / Table	
							cm	deg
1	3760.00 (PK)	3.41	-54.08	-50.67	-13.00	-37.67	100	360
* 2	5640.00 (PK)	9.12	-52.75	-43.63	-13.00	-30.63	100	360



<b>MODE</b>	TX channel 661	<b>FREQUENCY RANGE</b>	Above 1000MHz
<b>ENVIRONMENTAL CONDITIONS</b>	26deg. C, 56%RH	<b>INPUT POWER</b>	DC 5V from adapter
<b>TESTED BY</b>	Alex Chen		
<b>ANTENNA POLARITY &amp; TEST DISTANCE: VERTICAL AT 3 M</b>			

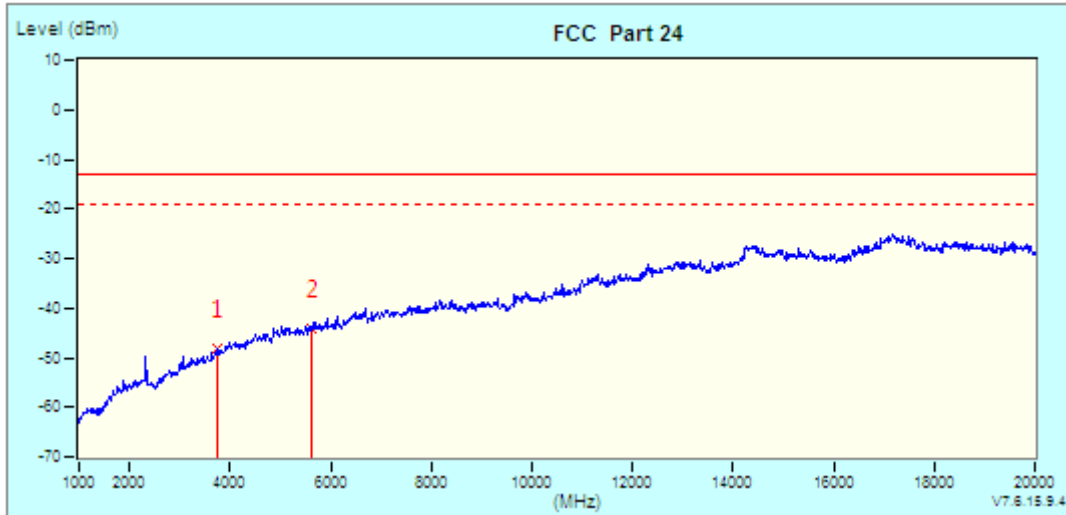

No.	Frequency MHz	Factor dB	Reading dBm	Emission dBm	Limit dBm	Margin dB	Tower / Table cm deg
1	3760.00 (PK)	3.88	-52.23	-48.35	-13.00	-35.35	100 0
* 2	5640.00 (PK)	8.26	-52.42	-44.16	-13.00	-31.16	100 0



**EDGE 1900:**

<b>MODE</b>	TX channel 661	<b>FREQUENCY RANGE</b>	Above 1000MHz
<b>ENVIRONMENTAL CONDITIONS</b>	26deg. C, 56%RH	<b>INPUT POWER</b>	DC 5V from adapter
<b>TESTED BY</b>	Alex Chen		
<b>ANTENNA POLARITY &amp; TEST DISTANCE: HORIZONTAL AT 3 M</b>			

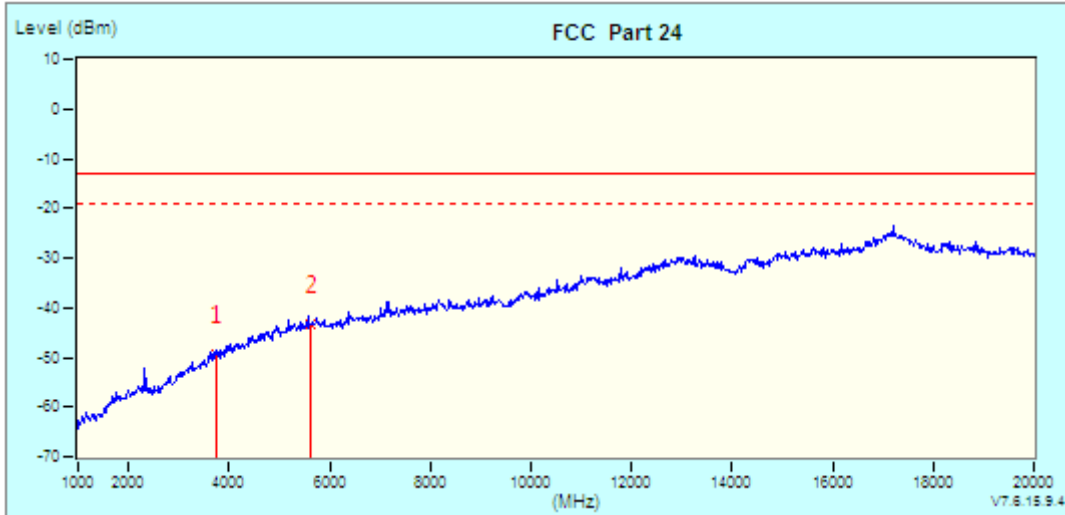

No.	Frequency MHz	Factor dB	Reading dBm	Emission dBm	Limit dBm	Margin dB	Tower / Table cm deg
1	3760.00 (PK)	3.41	-52.72	-49.31	-13.00	-36.31	100 0
* 2	5640.00 (PK)	9.12	-52.47	-43.35	-13.00	-30.35	100 0



<b>MODE</b>	TX channel 661	<b>FREQUENCY RANGE</b>	Above 1000MHz
<b>ENVIRONMENTAL CONDITIONS</b>	26deg. C, 56%RH	<b>INPUT POWER</b>	DC 5V from adapter
<b>TESTED BY</b>	Alex Chen		
<b>ANTENNA POLARITY &amp; TEST DISTANCE: VERTICAL AT 3 M</b>			

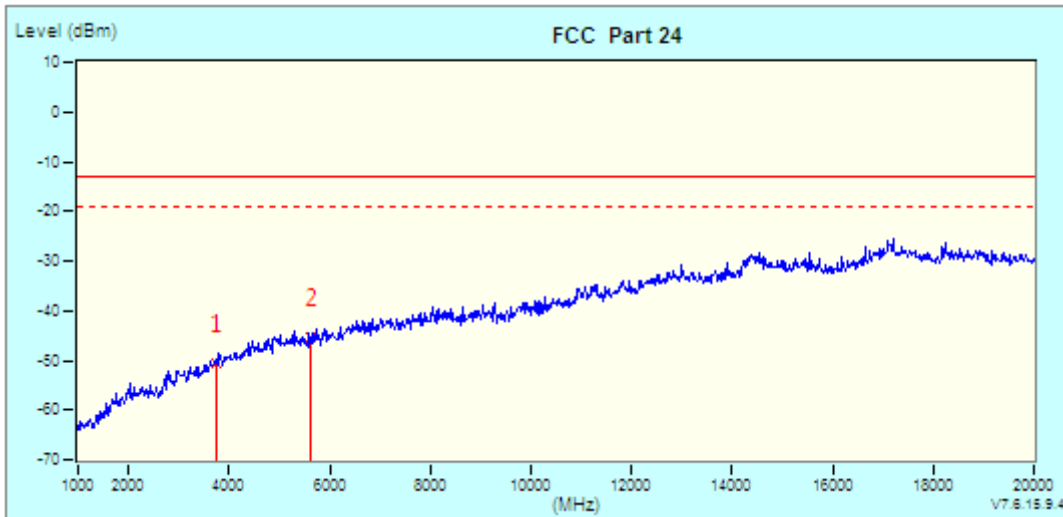

No.	Frequency MHz	Factor dB	Reading dBm	Emission dBm	Limit dBm	Margin dB	Tower / Table cm deg	
1	3760.00 (PK)	3.88	-54.67	-50.79	-13.00	-37.79	100	360
*	2	5640.00 (PK)	-53.75	-45.49	-13.00	-32.49	100	360



**WCDMA Band II:**

<b>MODE</b>	TX channel 9400	<b>FREQUENCY RANGE</b>	Above 1000MHz
<b>ENVIRONMENTAL CONDITIONS</b>	26deg. C, 56%RH	<b>INPUT POWER</b>	DC 5V from adapter
<b>TESTED BY</b>	Alex Chen		
<b>ANTENNA POLARITY &amp; TEST DISTANCE: HORIZONTAL AT 3 M</b>			

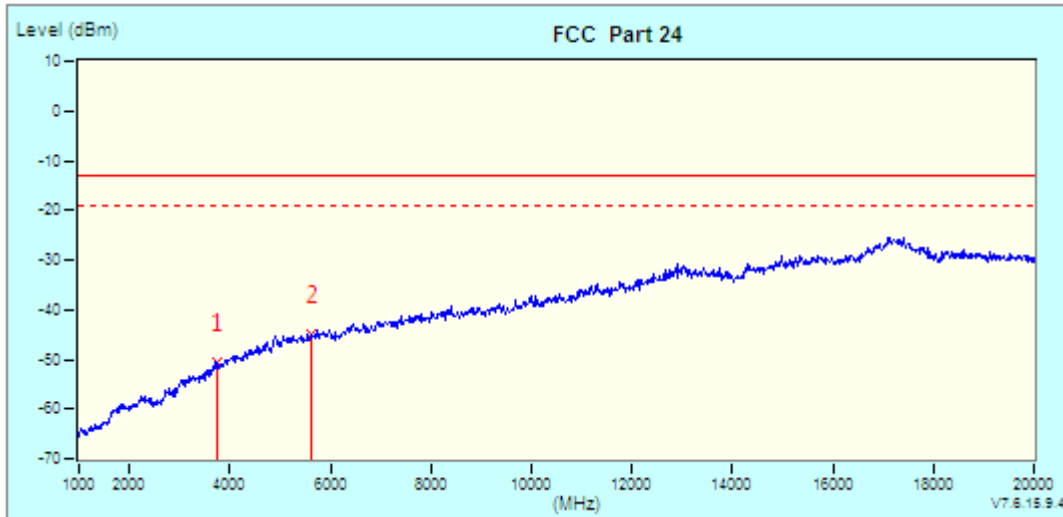

No.	Frequency MHz	Factor dB	Reading dBm	Emission dBm	Limit dBm	Margin dB	Tower / Table cm deg	
1	3760.00 (PK)	3.41	-53.93	-50.52	-13.00	-37.52	100	0
*	5640.00 (PK)	9.12	-54.10	-44.98	-13.00	-31.98	100	0



<b>MODE</b>	TX channel 9400	<b>FREQUENCY RANGE</b>	Above 1000MHz
<b>ENVIRONMENTAL CONDITIONS</b>	26deg. C, 56%RH	<b>INPUT POWER</b>	DC 5V from adapter
<b>TESTED BY</b>	Alex Chen		
<b>ANTENNA POLARITY &amp; TEST DISTANCE: VERTICAL AT 3 M</b>			

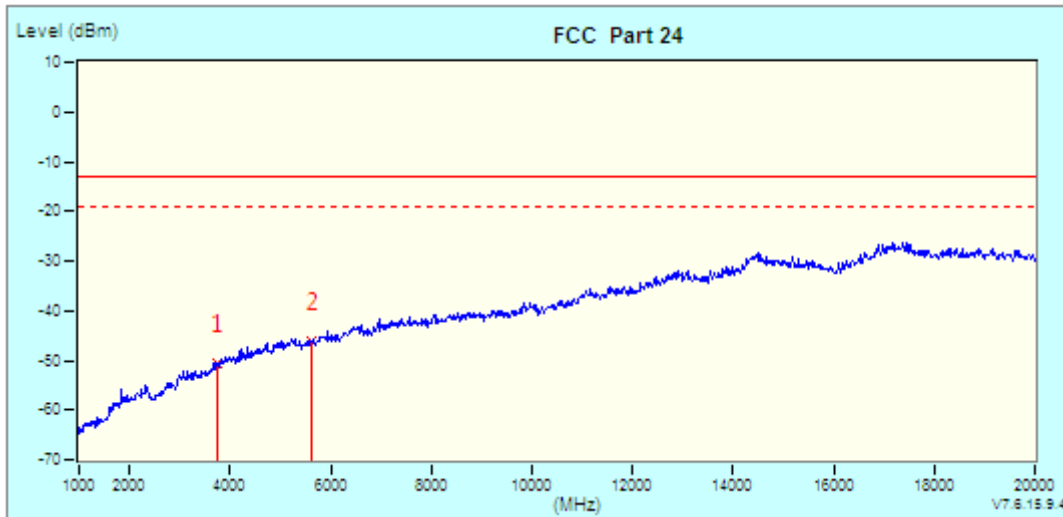

No.	Frequency MHz	Factor dB	Reading dBm	Emission dBm	Limit dBm	Margin dB	Tower / Table cm deg	
1	3760.00 (PK)	3.88	-54.49	-50.61	-13.00	-37.61	100	360
*	2	8.26	-54.60	-46.34	-13.00	-33.34	100	360



## 4.7 PEAK TO AVERAGE RATIO

### 4.7.1 LIMITS OF PEAK TO AVERAGE RATIO MEASUREMENT

In measuring transmissions in this band using an average power technique, the peak to-average ratio (PAR) of the transmission may not exceed 13 dB

### 4.7.2 TEST SETUP

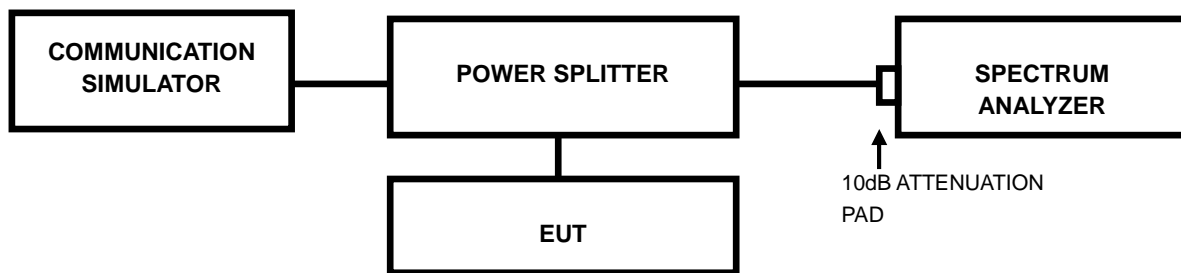

### 4.7.3 TEST PROCEDURES

1. Set resolution/measurement bandwidth  $\geq$  signal's occupied bandwidth;
2. Set the number of counts to a value that stabilizes the measured CCDF curve;
3. Record the maximum PAPR level associated with a probability of 0.1%.



### 4.7.4 TEST RESULTS

#### GSM

CHANNEL	FREQUENCY (MHz)	PEAK TO AVERAGE RATIO (dB)
661	1880	9.58

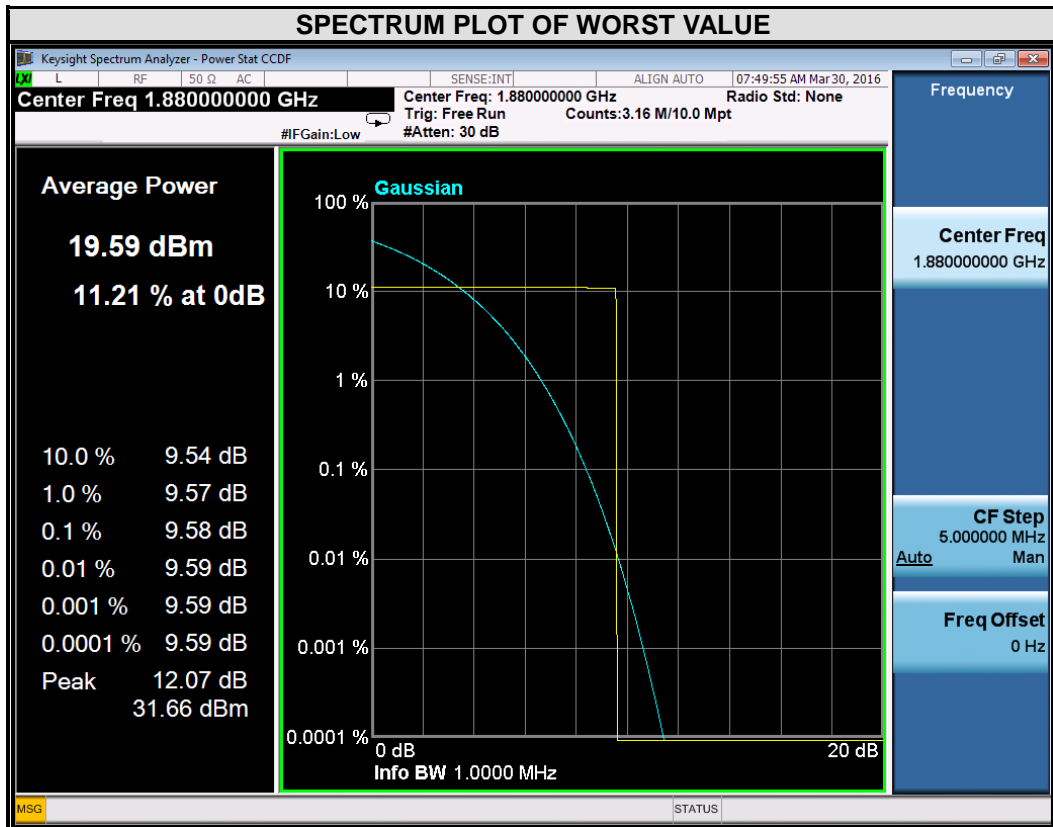





EDGE

CHANNEL	FREQUENCY (MHz)	PEAK TO AVERAGE RATIO (dB)
661	1880	9.09

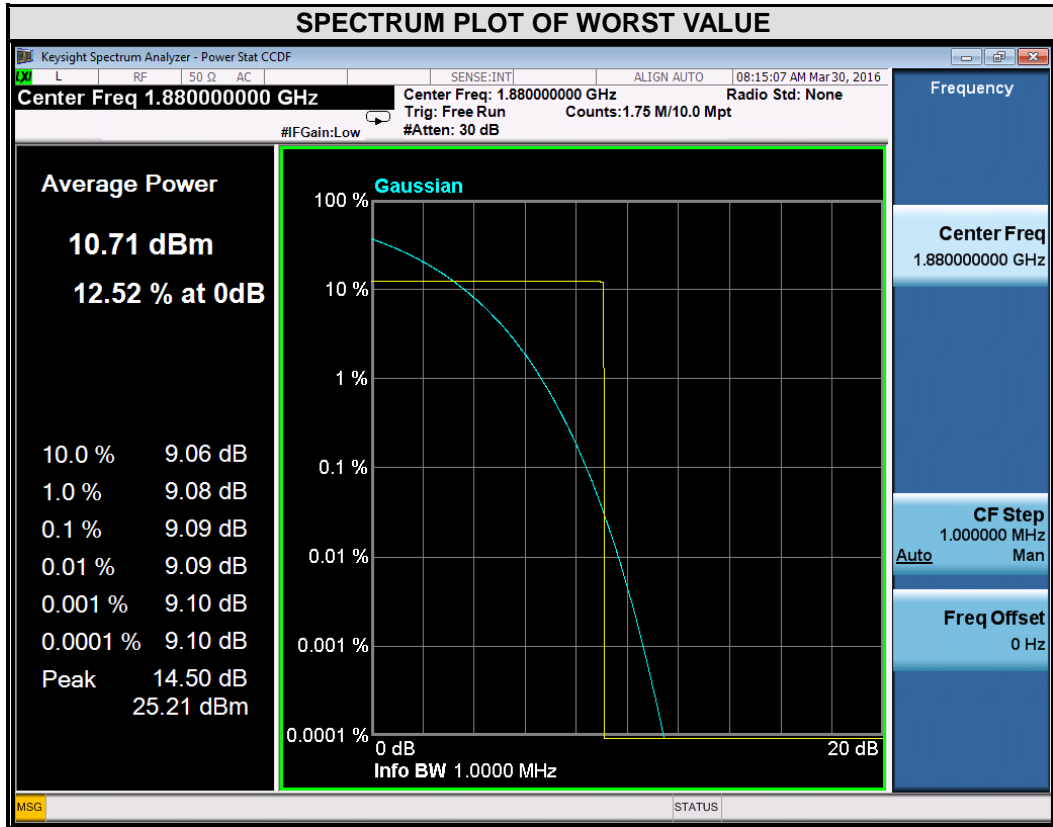



WCDMA

CHANNEL	FREQUENCY (MHz)	PEAK TO AVERAGE RATIO (dB)
9400	1880	2.71

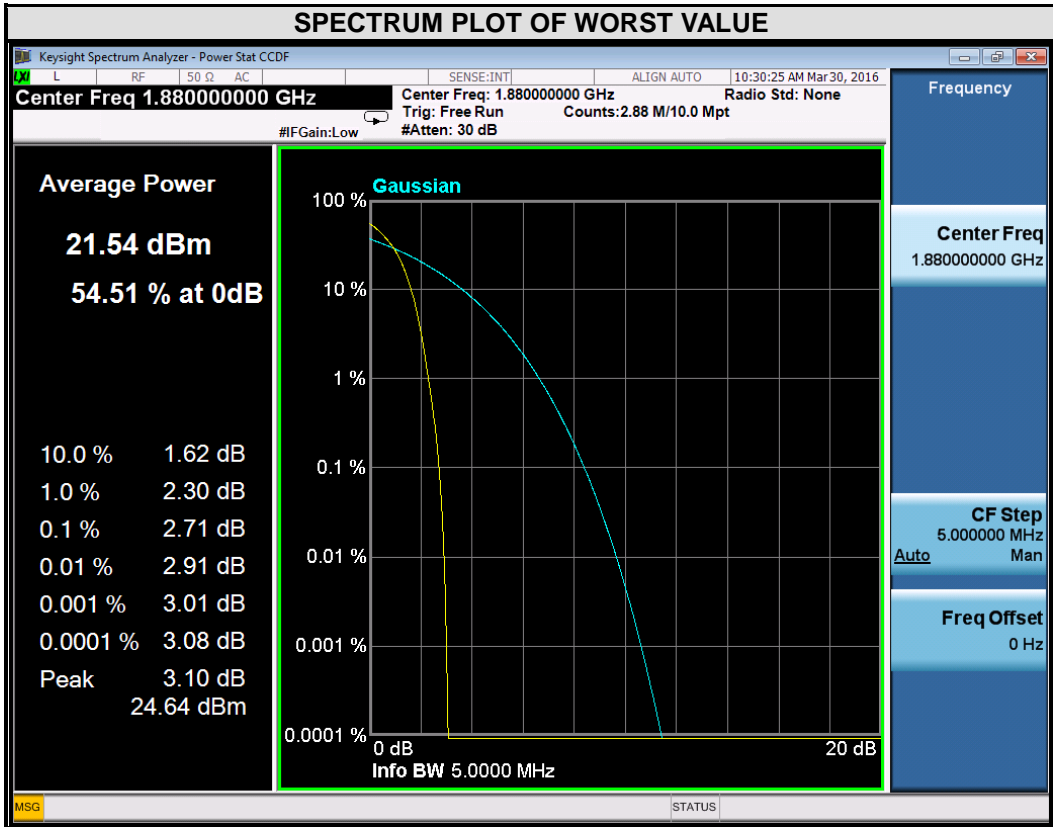



## 5 INFORMATION ON THE TESTING LABORATORIES

We, Bureau Veritas Shenzhen Co., Ltd. Dongguan Branch, were founded in 2002 to provide our best service in EMC, Radio, Telecom and Safety consultation. Our laboratories are accredited and approved according to ISO/IEC 17025.

If you have any comments, please feel free to contact us at the following:

**Dongguan EMC/RF Lab:**

Tel: +86-769-85935656

Fax: +86-769-85931080

**Email:** [customerservice.dg@cn.bureauveritas.com](mailto:customerservice.dg@cn.bureauveritas.com)

**Web Site:** [www.adt.com.tw](http://www.adt.com.tw)

The address and road map of all our labs can be found in our web site also.



## 6 APPENDIX A – MODIFICATIONS RECORDERS FOR ENGINEERING CHANGES TO THE EUT BY THE LAB

No any modifications are made to the EUT by the lab during the test.

---END---