

FCC TEST REPORT (PART 27)

Report No.: RF150915W002-5

FCC ID: YCNA2010L36

Test Model: Lenovo A2010I36

Received Date: Sep. 15, 2015

Test Date: Sep. 16, 2015 ~ Oct. 12, 2015

Issued Date: Oct. 13, 2015

Applicant: Lenovo Mobile Communication Technology Ltd.

Address: No.999, Qishan North 2nd Road, Information & Optoelectronics Park, Torch Hi-tech Industry Development Zone, Xiamen, P.R. China

Issued By: Bureau Veritas Consumer Products Services (H.K.) Ltd., Taoyuan Branch

Lab Address: No. 47-2, 14th Ling, Chia Cau Vil., Lin Kou Dist., New Taipei City, Taiwan (R.O.C.)

Test Location: No. 19, Hwa Ya 2nd Rd., Wen Hwa Tsuen, Kwei Shan Hsiang, Taoyuan Hsien 333, Taiwan, R.O.C.

This report should not be used by the client to claim product certification, approval, or endorsement by TAF or any government agencies.



This report is for your exclusive use. Any copying or replication of this report to or for any other person or entity, or use of our name or trademark, is permitted only with our prior written permission. This report sets forth our findings solely with respect to the test samples identified herein. The results set forth in this report are not indicative or representative of the quality or characteristics of the lot from which a test sample was taken or any similar or identical product specifically and expressly noted. Our report includes all of the tests requested by you and the results thereof based upon the information that you provided to us. You have 60 days from date of issuance of this report to notify us of any material error or omission caused by our negligence, provided, however, that such notice shall be in writing and shall specifically address the issue you wish to raise. A failure to raise such issue within the prescribed time shall constitute your unqualified acceptance of the completeness of this report, the tests conducted and the correctness of the report contents. Unless specific mention, the uncertainty of measurement has been explicitly taken into account to declare the compliance or non-compliance to the specification. The report must not be used by the client to claim product certification, approval, or endorsement by TAF or any government agency

Table of Contents

RELEASE CONTROL RECORD	3
1 Certificate of Conformity.....	4
2 Summary of Test Results	5
2.1 Measurement Uncertainty	5
2.2 Test Site And Instruments	6
3 General Information.....	7
3.1 General Description of EUT	7
3.2 Configuration of System Under Test	9
3.2.1 Description Of Support Units.....	9
3.3 Test Mode Applicability and Tested Channel Detail	10
3.4 EUT Operating Conditions	11
3.5 General Description of Applied Standards	12
4 Test Types and Results	13
4.1 Output Power Measurement	13
4.1.1 Limits of Output Power Measurement.....	13
4.1.2 Test Procedures.....	13
4.1.3 Test Setup.....	14
4.1.4 Test Results	15
4.2 Frequency Stability Measurement.....	22
4.2.1 Limits of Frequency Stability Measurement.....	22
4.2.2 Test Procedure	22
4.2.3 Test Setup.....	22
4.2.4 Test Results	23
4.3 Occupied Bandwidth Measurement	24
4.3.1 Limits Of Occupied Bandwidth Measurement	24
4.3.2 Test Setup.....	24
4.3.3 Test Procedures.....	24
4.3.4 Test Result.....	25
4.4 Peak To Average Ratio.....	28
4.4.1 Limits of Peak To Average Ratio Measurement	28
4.4.2 Test Setup.....	28
4.4.3 Test Procedures.....	28
4.4.4 Test Results	29
4.5 Band Edge Measurement	32
4.5.1 Limits of Band Edge Measurement	32
4.5.2 Test Setup.....	32
4.5.3 Test Procedures.....	32
4.5.4 Test Results	33
4.6 Conducted Spurious Emissions	39
4.6.1 Limits of Conducted Spurious Emissions Measurement.....	39
4.6.2 Test Procedure	39
4.6.3 Test Setup.....	39
4.6.4 Test Results	40
4.7 Radiated Emission Measurement	41
4.7.1 Limits of Radiated Emission Measurement.....	41
4.7.2 Test Procedure	41
4.7.3 Deviation from Test Standard	41
4.7.4 Test Setup.....	42
4.7.5 Test Results	43
5 Pictures of Test Arrangements.....	57
Appendix – Information on the Testing Laboratories	58



RELEASE CONTROL RECORD

Issue No.	Description	Date Issued
RF150915W002-5	Original release	Oct. 13, 2015

1 Certificate of Conformity

Product: Lenovo Mobile Phone
Brand: Lenovo
Test Model: Lenovo A2010I36
Sample Status: Production unit
Applicant: Lenovo Mobile Communication Technology Ltd.
Test Date: Sep. 16, 2015 ~ Oct. 12, 2015
Standards: **FCC Part 27, Subpart C, L**
FCC Part 2
ANSI C63.4-2003

The above equipment has been tested by **Bureau Veritas Consumer Products Services (H.K.) Ltd., Taoyuan Branch**, and found compliance with the requirement of the above standards. The test record, data evaluation & Equipment Under Test (EUT) configurations represented herein are true and accurate accounts of the measurements of the sample's EMC characteristics under the conditions specified in this report.

Prepared by :  _____, **Date:** _____ Oct. 13, 2015
Amyee Qian / Engineer

Approved by :  _____, **Date:** _____ Oct. 13, 2015
William Chung / Manager

2 Summary of Test Results

Applied Standard: FCC Part 27 & Part 2			
FCC Clause	Test Item	Result	Remarks
2.1046 27.50(d)(4)	Maximum Peak Output Power	PASS	Meet the requirement of limit.
2.1055 27.54	Frequency Stability	PASS	Meet the requirement of limit.
2.1049 27.53(h)	Occupied Bandwidth	PASS	Meet the requirement of limit.
27.50(d)(5)	Peak to average ratio	PASS	Meet the requirement of limit.
27.53(h)	Band Edge Measurements	PASS	Meet the requirement of limit.
2.1051 27.53(h)	Conducted Spurious Emissions	PASS	Meet the requirement of limit.
2.1053 27.53(h)	Radiated Spurious Emissions	PASS	Meet the requirement of limit. Minimum passing margin is -32.92dB at 5197.50MHz.

2.1 Measurement Uncertainty

Where relevant, the following measurement uncertainty levels have been estimated for tests performed on the EUT as specified in CISPR 16-4-2:

Measurement	Frequency	Expanded Uncertainty (k=2) (±)
Conducted Emissions at mains ports	150kHz ~ 30MHz	2.44 dB
Radiated Emissions up to 1 GHz	30MHz ~ 200MHz	2.93 dB
	200MHz ~ 1000MHz	2.95 dB
Radiated Emissions above 1 GHz	1GHz ~ 18GHz	2.26 dB
	18GHz ~ 40GHz	1.94 dB

This uncertainty represents an expanded uncertainty expressed at approximately the 95% confidence level using a coverage factor of k=2.

2.2 Test Site And Instruments

Description & Manufacturer	Model No.	Serial No.	Date Of Calibration	Due Date Of Calibration
Spectrum Analyzer Agilent Technologies	N9038A	MY52260177	May 19, 2015	May 18, 2016
Spectrum Analyzer ROHDE & SCHWARZ	FSU43	101261	Dec. 10, 2014	Dec. 09, 2015
BILOG Antenna ETS-Lindgren	3142E	117536	Feb. 23, 2015	Feb. 22, 2016
HORN Antenna ETS-Lindgren	3117	00143293	Aug. 27, 2015	Aug. 26, 2016
Bluetooth Tester	CBT	100980	Apr. 27, 2015	Apr. 26, 2016
Agilent Communications Tester-Wireless	8960 Series 10	MY53201073	Jul. 06, 2015	Jul. 05, 2017
Preamplifier Agilent	310N	187226	Jun. 29, 2015	Jun. 28, 2016
Preamplifier Agilent	83017A	980116	Jan. 09, 2015	Jan. 08, 2016
Power Meter Anritsu	ML2495A	1232002	Sep. 16, 2015	Sep. 15, 2016
Power Sensor Anritsu	MA2411B	1207325	Sep. 16, 2015	Sep. 15, 2016
RF signal cable ETS-LINDGREN	5D-FB	Cable-CH1-01(RFC-S MS-100-SMS-120+RF C-SMS-100-SMS-400)	Jun. 27, 2015	Jun. 26, 2016
RF signal cable ETS-LINDGREN	8D-FB	Cable-CH1-02(RFC-S MS-100-SMS-24)	Jun. 27, 2015	Jun. 26, 2016
Software BV ADT	E38.130425b	NA	NA	NA
Antenna Tower MF	NA	NA	NA	NA
Turn Table MF	NA	NA	NA	NA
Antenna Tower & Turn Table Controller MF	MF-7802	NA	NA	NA

- NOTE:**
1. The calibration interval of the above test instruments is 12 months and the calibrations are traceable to NML/ROC and NIST/USA.
 2. The calibration interval of the loop antenna is 24 months and the calibrations are traceable to NML/ROC and NIST/USA.
 3. The test was performed in HwaYa Chamber 4.
 4. The horn antenna and HP preamplifier (model: 8449B) are used only for the measurement of emission frequency above 1GHz if tested.
 5. The FCC Site Registration No. is 460141.
 6. The IC Site Registration No. is IC7450F-4.

3 General Information

3.1 General Description of EUT

PRODUCT	Lenovo Mobile Phone	
BRAND	Lenovo	
MODEL NAME	Lenovo A2010I36	
POWER SUPPLY	5.0Vdc (adapter or host equipment) 3.8Vdc (battery)	
MODULATION TECHNOLOGY	LTE Band 4	QPSK, 16QAM
FREQUENCY RANGE	LTE Band 4 Channel Bandwidth: 1.4MHz	1710.7MHz ~ 1754.3MHz
	LTE Band 4 Channel Bandwidth: 3MHz	1711.5MHz ~ 1753.5MHz
	LTE Band 4 Channel Bandwidth: 5MHz	1712.5MHz ~ 1752.5MHz
	LTE Band 4 Channel Bandwidth: 10MHz	1715.0MHz ~ 1750.0MHz
	LTE Band 4 Channel Bandwidth: 15MHz	1717.5MHz ~ 1747.5MHz
	LTE Band 4 Channel Bandwidth: 20MHz	1720.0MHz ~ 1745.0MHz
EMISSION DESIGNATOR	LTE Band 4 Channel Bandwidth: 1.4MHz	QPSK: 1M09G7D 16QAM: 1M09W7D
	LTE Band 4 Channel Bandwidth: 3MHz	QPSK: 2M69G7D 16QAM: 2M69W7D
	LTE Band 4 Channel Bandwidth: 5MHz	QPSK: 4M48G7D 16QAM: 4M48W7D
	LTE Band 4 Channel Bandwidth: 10MHz	QPSK: 8M94G7D 16QAM: 8M95W7D
	LTE Band 4 Channel Bandwidth: 15MHz	QPSK: 13M4G7D 16QAM: 13M5W7D
	LTE Band 4 Channel Bandwidth: 20MHz	QPSK: 17M9G7D 16QAM: 17M9W7D
MAX. ERP/EIRP POWER	LTE Band 4 Channel Bandwidth: 1.4MHz	316mW
	LTE Band 4 Channel Bandwidth: 3MHz	321mW
	LTE Band 4 Channel Bandwidth: 5MHz	315mW
	LTE Band 4 Channel Bandwidth: 10MHz	300mW
	LTE Band 4 Channel Bandwidth: 15MHz	282mW
	LTE Band 4 Channel Bandwidth: 20MHz	240mW
ANTENNA TYPE	Fixed Internal antenna with -1.7dBi gain	

HW VERSION	AL713_MB_PCB_V1.0
SW VERSION	A2010I36_USR_S203_1508251800_MP3V1_8G_TELEFONICA
ACCESSORY DEVICE	Refer to note as below
DATA CABLE	USB cable: Unshielded, detachable, 0.7m Earphone cable: Unshielded, detachable, 1.3m

Note:

1. The above EUT information is declared by manufacturer and for more detailed features description, please refer to the manufacturer's specifications or User's Manual.
2. The EUT was powered by the following adapter:

ADAPTER	
BRAND:	Lenovo
MODEL:	C-P56
INPUT:	AC 100-240V, 0.13A
OUTPUT:	DC 5V, 1.0A
MANUFACTURER:	chenyang

3. The EUT matched the following USB Cable and Earphone.

USB CABLE	
BRAND:	lenovo
MODEL:	L16W-05100070L
SIGNAL LINE:	0.7 METER

EARPHONE	
BRAND:	Lenovo
MODEL:	TS990B-28AMS05-M
SIGNAL LINE:	1.3 METER

4. For the test results, the EUT had been tested with all conditions. But only the worst case was shown in test report.

3.2 Configuration of System Under Test

FOR RADIATION EMISSION TEST

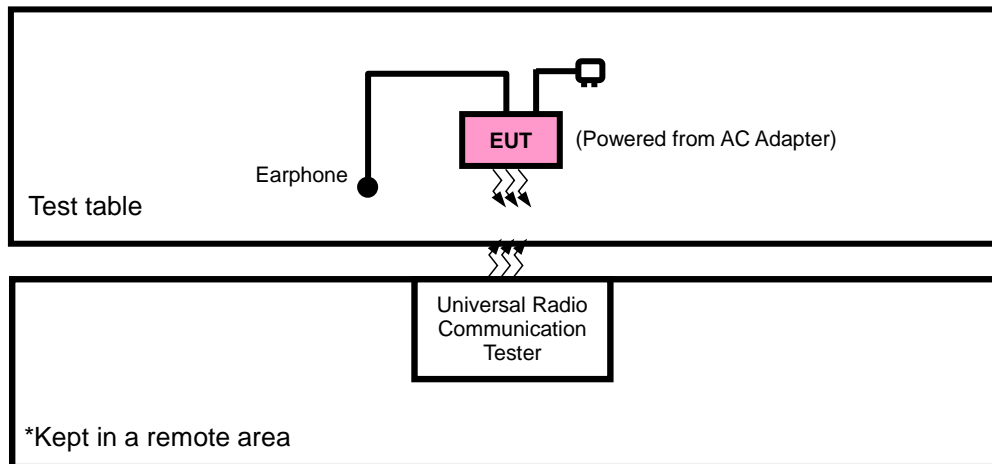

FOR E.R.P./E.I.R.P TEST

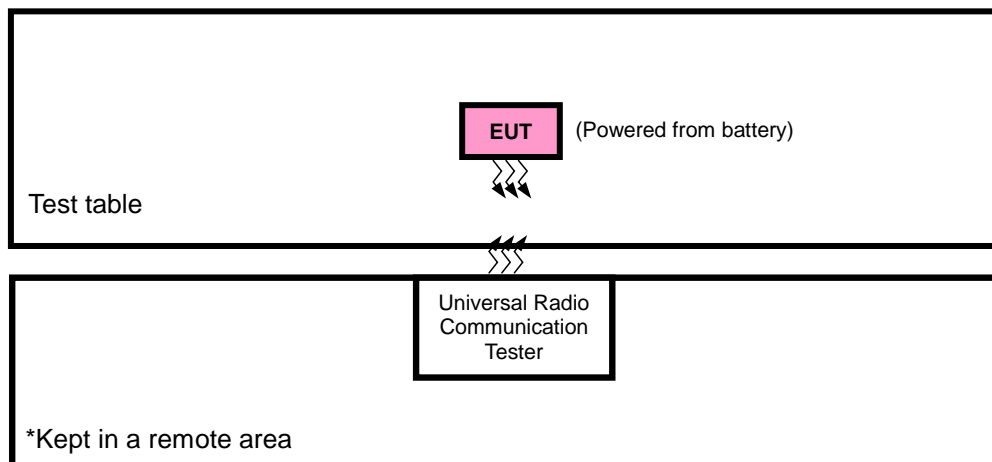

3.2.1 Description Of Support Units

The EUT has been tested as an independent unit together with other necessary accessories or support units. The following support units or accessories were used to form a representative test configuration during the tests.

NO.	PRODUCT	BRAND	MODEL NO.	SERIAL NO.	FCC ID
1	DC source	LONG WEI	PS-6403D	010934269	N/A
2	PC	HP	A6608CN	3CR83825X3	N/A

NO.	SIGNAL CABLE DESCRIPTION OF THE ABOVE SUPPORT UNITS
1	DC Line: Unshielded, Detachable 1.0m
2	AC Line: Unshielded, Detachable 1.5m

NOTE:

1. All power cords of the above support units are non shielded (1.8m).

3.3 Test Mode Applicability and Tested Channel Detail

Pre-Scan has been conducted to determine the worst-case mode from all possible combinations between available modulations, data rates, XYZ axis and antenna ports
The worst case was found when positioned on X-plane. Following channel(s) was (were) selected for the final test as listed below:

EUT CONFIGURE MODE	DESCRIPTION
A	EUT + Adapter + USB Cable + Earphone with LTE link
B	EUT + Battery + USB Cable + Earphone with LTE link

LTE BAND 4

EUT CONFIGURE MODE	TEST ITEM	AVAILABLE CHANNEL	TESTED CHANNEL	CHANNEL BANDWIDTH	MODULATION	MODE
B	EIRP	19957 to 20393	19957, 20175, 20393	1.4MHz	QPSK, 16QAM	1 RB / 0 RB Offset
		19965 to 20385	19965, 20175, 20385	3MHz	QPSK, 16QAM	1 RB / 0 RB Offset
		19975 to 20375	19975, 20175, 20375	5MHz	QPSK, 16QAM	1 RB / 0 RB Offset
		20000 to 20350	20000, 20175, 20350	10MHz	QPSK, 16QAM	1 RB / 0 RB Offset
		20025 to 20325	20025, 20175, 20325	15MHz	QPSK, 16QAM	1 RB / 0 RB Offset
		20050 to 20300	20050, 20175, 20300	20MHz	QPSK, 16QAM	1 RB / 0 RB Offset
B	FREQUENCY STABILITY	19957 to 20393	20175	1.4MHz	QPSK	1 RB / 0 RB Offset
		19965 to 20385	20175	3MHz	QPSK	1 RB / 0 RB Offset
		19975 to 20375	20175	5MHz	QPSK	1 RB / 0 RB Offset
		20000 to 20350	20175	10MHz	QPSK	1 RB / 0 RB Offset
		20025 to 20325	20175	15MHz	QPSK	1 RB / 0 RB Offset
		20050 to 20300	20175	20MHz	QPSK	1 RB / 0 RB Offset
B	OCCUPIED BANDWIDTH	19957 to 20393	19957, 20175, 20393	1.4MHz	QPSK, 16QAM	6 RB / 0 RB Offset
		19965 to 20385	19965, 20175, 20385	3MHz	QPSK, 16QAM	15 RB / 0 RB Offset
		19975 to 20375	19975, 20175, 20375	5MHz	QPSK, 16QAM	25 RB / 0 RB Offset
		20000 to 20350	20000, 20175, 20350	10MHz	QPSK, 16QAM	50 RB / 0 RB Offset
		20025 to 20325	20025, 20175, 20325	15MHz	QPSK, 16QAM	75 RB / 0 RB Offset
		20050 to 20300	20050, 20175, 20300	20MHz	QPSK, 16QAM	100 RB / 0 RB Offset
B	PEAK TO AVERAGE RATIO	19957 to 20393	19957, 20175, 20393	1.4MHz	QPSK, 16QAM	1 RB / 0 RB Offset
		19965 to 20385	19965, 20175, 20385	3MHz	QPSK, 16QAM	1 RB / 0 RB Offset
		19975 to 20375	19975, 20175, 20375	5MHz	QPSK, 16QAM	1 RB / 0 RB Offset
		20000 to 20350	20000, 20175, 20350	10MHz	QPSK, 16QAM	1 RB / 0 RB Offset
		20025 to 20325	20025, 20175, 20325	15MHz	QPSK, 16QAM	1 RB / 0 RB Offset
		20050 to 20300	20050, 20175, 20300	20MHz	QPSK, 16QAM	1 RB / 0 RB Offset
B	BAND EDGE	19957 to 20393	19957	1.4MHz	QPSK	1 RB / 0 RB Offset
			20393	1.4MHz	QPSK	6 RB / 0 RB Offset
		19965 to 20385	19965	3MHz	QPSK	1 RB / 5 RB Offset
			20385	3MHz	QPSK	6 RB / 0 RB Offset
			19965	3MHz	QPSK	1 RB / 0 RB Offset
			20385	3MHz	QPSK	15 RB / 0 RB Offset
					1 RB / 14 RB Offset	
					15 RB / 0 RB Offset	

		19975 to 20375	19975	5MHz	QPSK	1 RB / 0 RB Offset		
			20375	5MHz	QPSK	25 RB / 0 RB Offset		
		20000 to 20350	20000	10MHz	QPSK	1 RB / 24 RB Offset		
			20350	10MHz	QPSK	25 RB / 0 RB Offset		
					20000	10MHz	QPSK	1 RB / 0 RB Offset
					20350	10MHz	QPSK	50 RB / 0 RB Offset
B	BAND EDGE	20025 to 20325	20025	15MHz	QPSK	1 RB / 49 RB Offset		
			20325	15MHz	QPSK	75 RB / 0 RB Offset		
		20050 to 20300	20050	20MHz	QPSK	1 RB / 74 RB Offset		
			20300	20MHz	QPSK	75 RB / 0 RB Offset		
					20050	20MHz	QPSK	1 RB / 0 RB Offset
					20300	20MHz	QPSK	100 RB / 0 RB Offset
B	CONDCUDED EMISSION	19957 to 20393	20175	1.4MHz	QPSK	1 RB / 99 RB Offset		
		19965 to 20385	20175	3MHz	QPSK	100 RB / 0 RB Offset		
		19975 to 20375	20175	5MHz	QPSK	1 RB / 0 RB Offset		
		20000 to 20350	20175	10MHz	QPSK	1 RB / 0 RB Offset		
		20025 to 20325	20175	15MHz	QPSK	1 RB / 0 RB Offset		
		20050 to 20300	20175	20MHz	QPSK	1 RB / 0 RB Offset		
A	RADIATED EMISSION	19957 to 20393	20175	1.4MHz	QPSK	1 RB / 0 RB Offset		
		19965 to 20385	20175	3MHz	QPSK	1 RB / 0 RB Offset		
		19975 to 20375	20175	5MHz	QPSK	1 RB / 0 RB Offset		
		20000 to 20350	20175	10MHz	QPSK	1 RB / 0 RB Offset		
		20025 to 20325	20175	15MHz	QPSK	1 RB / 0 RB Offset		
		20050 to 20300	20175	20MHz	QPSK	1 RB / 0 RB Offset		

Note: This device was tested under all bandwidths, RB configurations and modulations. The worst case was found in QPSK modulation.

Test Condition:

Test Item	Environmental Conditions	Input Power	Tested By
ERP	21deg. C, 71%RH 22deg. C, 71%RH	120Vac, 60Hz	Nick Hsu
Frequency Stability	24deg. C, 64%RH	3.9Vdc	Match Tsui
Occupied Bandwidth	24deg. C, 64%RH	120Vac, 60Hz	Match Tsui
Band Edge	24deg. C, 64%RH	120Vac, 60Hz	Match Tsui
Condcudeted Emission	24deg. C, 64%RH	120Vac, 60Hz	Match Tsui
Radiated Emission	21deg. C, 71%RH	120Vac, 60Hz	Nick Hsu

3.4 EUT Operating Conditions

The EUT makes a call to the communication simulator. The communication simulator station system controlled a EUT to export maximum output power under transmission mode and specific channel frequency

3.5 General Description of Applied Standards

The EUT is a RF Product. According to the specifications of the manufacturer, it must comply with the requirements of the following standards:

FCC 47 CFR Part 2

FCC 47 CFR Part 27

ANSI C63.4-2003

ANSI/TIA/EIA-603-C 2004

NOTE: All test items have been performed and recorded as per the above standards.

4 Test Types and Results

4.1 Output Power Measurement

4.1.1 Limits of Output Power Measurement

Fixed, mobile, and portable (hand-held) stations operating in the 1710–1755 MHz band are limited to 1 watt EIRP.

Portable stations (hand-held devices) operating in the 699-716 MHz band are limited to 3 watts ERP.

4.1.2 Test Procedures

EIRP / ERP Measurement:

- a. The EUT was set up for the maximum power with LTE link data modulation. The power was measured with R&S Spectrum Analyzer. All measurements were done at 3 channels (low, middle and high operational frequency range). RBW and VBW is 10MHz for LTE.
- b. E.I.R.P power measurement. In the semi-anechoic chamber, EUT placed on the 0.8m height of Turn Table, rotated the table around 360 degrees to search the maximum radiation power and receiver antenna shall be rotated vertical and horizontal polarization and moved height from 1m to 4m to find the maximum polar radiated power. The “Read Value” is the spectrum reading the maximum power value.
- c. The substitution horn antenna is substituted for EUT at the same position and signals generator export the CW signal to the substitution antenna via a TX cable. Rotated the Turn Table and moved receiving antenna to find the maximum radiation power. Adjust output power level of S.G to get a Value of spectrum reading equal to “Read Value” of step a. Record the power level of S.G
- d. $EIRP = \text{Output power level of S.G} - \text{TX cable loss} + \text{Antenna gain of substitution horn}$
- e. $E.R.P = E.I.R.P - 2.15 \text{ dB}$

Conducted Power Measurement:

- a. The EUT was set up for the maximum power with LTE link data modulation and link up with simulator.
- b. Set the EUT to transmit under low, middle and high channel and record the power level shown on simulator.

4.1.3 Test Setup
EIRP / ERP MEASUREMENT:

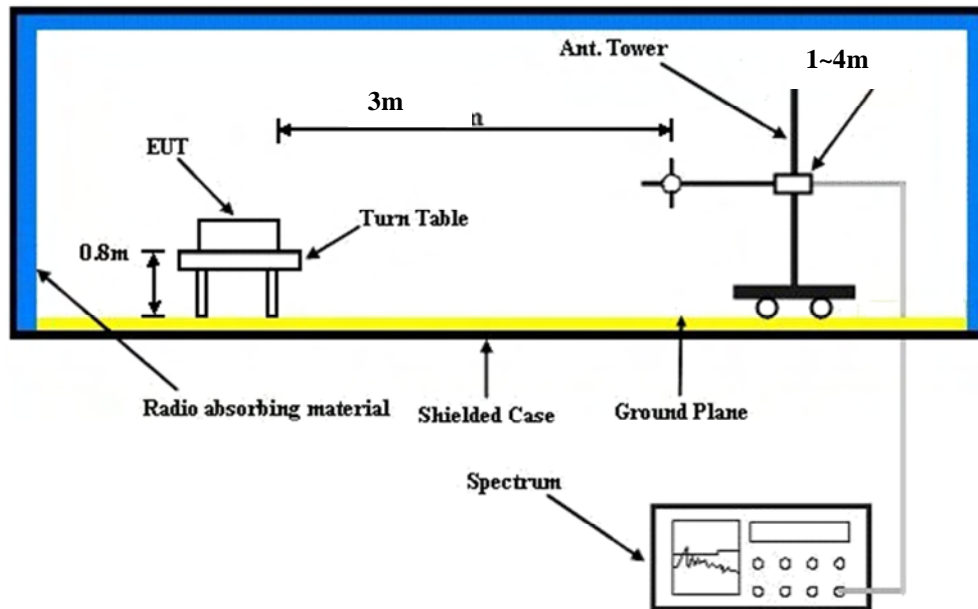

For the actual test configuration, please refer to the attached file (Test Setup Photo).

CONDUCTED POWER MEASUREMENT:



For the actual test configuration, please refer to the attached file (Test Setup Photo).

4.1.4 Test Results

AVERAGE CONDUCTED OUTPUT POWER (dBm)

LTE Band 4							
BW	Modulation	RB Size	RB Offset	Low CH 19957	Mid CH 20175	High CH 20393	MPR
				Frequency 1710.7 MHz	Frequency 1732.5 MHz	Frequency 1754.3 MHz	
1.4MHz	QPSK	1	0	22.70	22.96	22.70	0
		1	2	22.69	22.50	22.41	0
		1	5	22.42	22.70	22.45	0
		3	0	22.68	22.94	22.68	0
		3	1	22.67	22.48	22.39	0
		3	3	22.40	22.68	22.43	0
		6	0	21.51	21.74	21.47	1
	16QAM	1	0	21.77	21.85	21.60	1
		1	2	21.58	21.83	21.66	1
		1	5	21.53	21.60	21.68	1
		3	0	21.76	21.84	21.59	1
		3	1	21.57	21.82	21.65	1
		3	3	21.52	21.59	21.67	1
		6	0	21.06	21.22	20.95	2
LTE Band 4							
BW	Modulation	RB Size	RB Offset	Low CH 19965	Mid CH 20175	High CH 20385	MPR
				Frequency 1711.5 MHz	Frequency 1732.5 MHz	Frequency 1753.5 MHz	
3 MHz	QPSK	1	0	22.71	22.97	22.71	0
		1	7	22.70	22.51	22.42	0
		1	14	22.43	22.71	22.46	0
		8	0	21.93	22.13	21.85	1
		8	3	21.89	21.88	21.65	1
		8	7	21.72	21.85	21.59	1
		15	0	21.52	21.75	21.48	1
	16QAM	1	0	21.78	21.86	21.61	1
		1	7	21.59	21.84	21.67	1
		1	14	21.54	21.61	21.69	1
		8	0	20.98	21.02	21.00	2
		8	3	20.98	21.01	20.90	2
		8	7	20.89	21.00	20.93	2
		15	0	21.07	21.23	20.96	2

BW	Modulation	RB Size	RB Offset	Low CH 19975	Mid CH 20175	High CH 20375	MPR
				Frequency 1712.5 MHz	Frequency 1732.5 MHz	Frequency 1752.5 MHz	
5 MHz	QPSK	1	0	22.74	23.00	22.74	0
		1	12	22.73	22.54	22.45	0
		1	24	22.46	22.74	22.49	0
		12	0	21.96	22.16	21.88	1
		12	6	21.92	21.91	21.68	1
		12	13	21.75	21.88	21.62	1
		25	0	21.55	21.78	21.51	1
	16QAM	1	0	21.81	21.89	21.64	1
		1	12	21.62	21.87	21.70	1
		1	24	21.57	21.64	21.72	1
		12	0	21.01	21.05	21.03	2
		12	6	21.01	21.04	20.93	2
		12	13	20.92	21.03	20.96	2
		25	0	21.10	21.26	20.99	2

LTE Band 4							
BW	Modulation	RB Size	RB Offset	Low CH 20000	Mid CH 20175	High CH 20350	MPR
				Frequency 1715 MHz	Frequency 1732.5 MHz	Frequency 1750 MHz	
10 MHz	QPSK	1	0	22.78	23.04	22.78	0
		1	24	22.77	22.58	22.49	0
		1	49	22.50	22.78	22.53	0
		25	0	22.00	22.20	21.92	1
		25	12	21.96	21.95	21.72	1
		25	25	21.79	21.92	21.66	1
		50	0	21.59	21.82	21.55	1
	16QAM	1	0	21.85	21.93	21.68	1
		1	24	21.66	21.91	21.74	1
		1	49	21.61	21.68	21.76	1
		25	0	21.05	21.09	21.07	2
		25	12	21.05	21.08	20.97	2
		25	25	20.96	21.07	21.00	2
		50	0	21.14	21.30	21.03	2

BW	Modulation	RB Size	RB Offset	Low CH 20025	Mid CH 20175	High CH 20325	MPR
				Frequency 1717.5 MHz	Frequency 1732.5 MHz	Frequency 1747.5 MHz	
15 MHz	QPSK	1	0	22.84	23.10	22.84	0
		1	37	22.83	22.64	22.55	0
		1	74	22.56	22.84	22.59	0
		36	0	22.06	22.26	21.98	1
		36	19	22.02	22.01	21.78	1
		36	39	21.85	21.98	21.72	1
		75	0	21.65	21.88	21.61	1
	16QAM	1	0	21.91	21.99	21.74	1
		1	37	21.72	21.97	21.80	1
		1	74	21.67	21.74	21.82	1
		36	0	21.11	21.15	21.13	2
		36	19	21.11	21.14	21.03	2
		36	39	21.02	21.13	21.06	2
		75	0	21.20	21.36	21.09	2

LTE Band 4							
BW	Modulation	RB Size	RB Offset	Low CH 20050	Mid CH 20175	High CH 20300	MPR
				Frequency 1720 MHz	Frequency 1732.5 MHz	Frequency 1745 MHz	
20MHz	QPSK	1	0	22.87	23.13	22.87	0
		1	50	22.86	22.67	22.58	0
		1	99	22.59	22.87	22.62	0
		50	0	22.09	22.29	22.01	1
		50	25	22.05	22.04	21.81	1
		50	50	21.88	22.01	21.75	1
		100	0	21.68	21.91	21.64	1
	16QAM	1	0	21.94	22.02	21.77	1
		1	50	21.75	22.00	21.83	1
		1	99	21.70	21.77	21.85	1
		50	0	21.14	21.18	21.16	2
		50	25	21.14	21.17	21.06	2
		50	50	21.05	21.16	21.09	2
		100	0	21.23	21.39	21.12	2

EIRP

LTE BAND 4

CHANNEL BANDWIDTH: 1.4MHz QPSK

Channel	Frequency (MHz)	LVL (dBm)	Correction Factor(dB)	EIRP(dBm)	EIRP(mW)	Polarization (H/V)	LIMIT (W)
19957	1710.7	-17.94	41.29	23.35	216.47	H	1
20175	1732.5	-18.38	41.36	22.98	198.61	H	1
20393	1754.3	-17.74	42.74	25.00	316.08	H	1
19957	1710.7	-21.55	44.25	22.70	185.99	V	1
20175	1732.5	-21.38	44.20	22.82	191.43	V	1
20393	1754.3	-21.06	44.09	23.03	200.68	V	1

NOTE: EIRP (dBm) = LVL (dBm) + Correction Factor (dB)

CHANNEL BANDWIDTH: 1.4MHz 16QAM

Channel	Frequency (MHz)	LVL (dBm)	Correction Factor(dB)	EIRP(dBm)	EIRP(mW)	Polarization (H/V)	LIMIT (W)
19957	1710.7	-18.81	41.29	22.48	177.17	H	1
20175	1732.5	-19.31	41.36	22.05	160.32	H	1
20393	1754.3	-18.70	42.74	24.04	253.40	H	1
19957	1710.7	-22.42	44.25	21.83	152.23	V	1
20175	1732.5	-22.31	44.20	21.89	154.53	V	1
20393	1754.3	-22.02	44.09	22.07	160.88	V	1

NOTE: EIRP (dBm) = LVL (dBm) + Correction Factor (dB)

LTE BAND 4

CHANNEL BANDWIDTH: 3MHz QPSK

Channel	Frequency (MHz)	LVL (dBm)	Correction Factor(dB)	EIRP(dBm)	EIRP(mW)	Polarization (H/V)	LIMIT (W)
19965	1711.5	-17.92	41.27	23.35	216.12	H	1
20175	1732.5	-18.44	41.36	22.92	195.88	H	1
20385	1753.5	-17.69	42.76	25.07	321.14	H	1
19965	1711.5	-21.53	44.26	22.73	187.59	V	1
20175	1732.5	-21.44	44.20	22.76	188.80	V	1
20385	1753.5	-21.01	44.23	23.22	209.99	V	1

NOTE: EIRP (dBm) = LVL (dBm) + Correction Factor (dB)

CHANNEL BANDWIDTH: 3MHz 16QAM

Channel	Frequency (MHz)	LVL (dBm)	Correction Factor(dB)	EIRP(dBm)	EIRP(mW)	Polarization (H/V)	LIMIT (W)
19965	1711.5	-18.99	41.27	22.28	168.93	H	1
20175	1732.5	-19.33	41.36	22.03	159.59	H	1
20385	1753.5	-18.68	42.76	24.08	255.68	H	1
19965	1711.5	-22.60	44.26	21.66	146.62	V	1
20175	1732.5	-22.33	44.20	21.87	153.82	V	1
20385	1753.5	-22.00	44.23	22.23	167.19	V	1

NOTE: EIRP (dBm) = LVL (dBm) + Correction Factor (dB)

LTE BAND 4

CHANNEL BANDWIDTH: 5MHz QPSK

Channel	Frequency (MHz)	LVL (dBm)	Correction Factor(dB)	EIRP(dBm)	EIRP(mW)	Polarization (H/V)	LIMIT (W)
19975	1712.5	-17.98	41.39	23.41	219.23	H	1
20175	1732.5	-18.39	41.36	22.97	198.15	H	1
20375	1752.5	-17.64	42.63	24.99	315.43	H	1
19975	1712.5	-21.59	44.17	22.58	180.97	V	1
20175	1732.5	-21.39	44.20	22.81	190.99	V	1
20375	1752.5	-20.96	44.35	23.39	218.02	V	1

NOTE: EIRP (dBm) = LVL (dBm) + Correction Factor (dB)

CHANNEL BANDWIDTH: 5MHz 16QAM

Channel	Frequency (MHz)	LVL (dBm)	Correction Factor(dB)	EIRP(dBm)	EIRP(mW)	Polarization (H/V)	LIMIT (W)
19975	1712.5	-18.81	41.39	22.58	181.09	H	1
20175	1732.5	-19.41	41.36	21.95	156.68	H	1
20375	1752.5	-18.74	42.63	23.89	244.85	H	1
19975	1712.5	-22.42	44.17	21.75	149.49	V	1
20175	1732.5	-22.41	44.20	21.79	151.01	V	1
20375	1752.5	-22.06	44.35	22.29	169.24	V	1

NOTE: EIRP (dBm) = LVL (dBm) + Correction Factor (dB)

LTE BAND 4

CHANNEL BANDWIDTH: 10MHz QPSK

Channel	Frequency (MHz)	LVL (dBm)	Correction Factor(dB)	EIRP(dBm)	EIRP(mW)	Polarization (H/V)	LIMIT (W)
20000	1715.0	-17.79	41.49	23.70	234.21	H	1
20175	1732.5	-18.33	41.36	23.03	200.91	H	1
20350	1750.0	-17.51	42.28	24.77	300.12	H	1
20000	1715.0	-21.40	44.06	22.66	184.63	V	1
20175	1732.5	-21.33	44.20	22.87	193.64	V	1
20350	1750.0	-20.83	44.43	23.60	229.09	V	1

NOTE: EIRP (dBm) = LVL (dBm) + Correction Factor (dB)

CHANNEL BANDWIDTH: 10MHz 16QAM

Channel	Frequency (MHz)	LVL (dBm)	Correction Factor(dB)	EIRP(dBm)	EIRP(mW)	Polarization (H/V)	LIMIT (W)
20000	1715.0	-18.94	41.49	22.55	179.72	H	1
20175	1732.5	-19.43	41.36	21.93	155.96	H	1
20350	1750.0	-18.67	42.28	23.61	229.77	H	1
20000	1715.0	-22.55	44.06	21.51	141.68	V	1
20175	1732.5	-22.43	44.20	21.77	150.31	V	1
20350	1750.0	-21.99	44.43	22.44	175.39	V	1

NOTE: EIRP (dBm) = LVL (dBm) + Correction Factor (dB)

LTE BAND 4

CHANNEL BANDWIDTH: 15MHz QPSK

Channel	Frequency (MHz)	LVL (dBm)	Correction Factor(dB)	EIRP(dBm)	EIRP(mW)	Polarization (H/V)	LIMIT (W)
20025	1717.5	-17.80	41.34	23.54	225.84	H	1
20175	1732.5	-18.40	41.36	22.96	197.70	H	1
20325	1747.5	-17.58	42.09	24.51	282.23	H	1
20025	1717.5	-21.41	44.04	22.63	183.40	V	1
20175	1732.5	-21.40	44.20	22.80	190.55	V	1
20325	1747.5	-20.90	44.22	23.32	214.54	V	1

NOTE: EIRP (dBm) = LVL (dBm) + Correction Factor (dB)

CHANNEL BANDWIDTH: 15MHz 16QAM

Channel	Frequency (MHz)	LVL (dBm)	Correction Factor(dB)	EIRP(dBm)	EIRP(mW)	Polarization (H/V)	LIMIT (W)
20025	1717.5	-18.66	41.34	22.68	185.27	H	1
20175	1732.5	-19.27	41.36	22.09	161.81	H	1
20325	1747.5	-18.43	42.09	23.66	232.06	H	1
20025	1717.5	-22.27	44.04	21.77	150.45	V	1
20175	1732.5	-22.27	44.20	21.93	155.96	V	1
20325	1747.5	-21.75	44.22	22.47	176.40	V	1

NOTE: EIRP (dBm) = LVL (dBm) + Correction Factor (dB)

LTE BAND 4

CHANNEL BANDWIDTH: 20MHz QPSK

Channel	Frequency (MHz)	LVL (dBm)	Correction Factor(dB)	EIRP(dBm)	EIRP(mW)	Polarization (H/V)	LIMIT (W)
20050	1720.0	-18.38	41.28	22.90	195.03	H	1
20175	1732.5	-18.85	41.36	22.51	178.28	H	1
20300	1745.0	-18.16	41.96	23.80	239.72	H	1
20050	1720.0	-21.99	44.14	22.15	163.87	V	1
20175	1732.5	-21.85	44.20	22.35	171.63	V	1
20300	1745.0	-21.48	43.88	22.40	173.86	V	1

NOTE: EIRP (dBm) = LVL (dBm) + Correction Factor (dB)

CHANNEL BANDWIDTH: 20MHz 16QAM

Channel	Frequency (MHz)	LVL (dBm)	Correction Factor(dB)	EIRP(dBm)	EIRP(mW)	Polarization (H/V)	LIMIT (W)
20050	1720.0	-19.31	41.28	21.97	157.43	H	1
20175	1732.5	-19.92	41.36	21.44	139.35	H	1
20300	1745.0	-18.99	41.96	22.97	198.02	H	1
20050	1720.0	-22.92	44.14	21.22	132.28	V	1
20175	1732.5	-22.92	44.20	21.28	134.15	V	1
20300	1745.0	-22.31	43.88	21.57	143.62	V	1

NOTE: EIRP (dBm) = LVL (dBm) + Correction Factor (dB)

4.2 Frequency Stability Measurement

4.2.1 Limits of Frequency Stability Measurement

The frequency stability shall be sufficient to ensure that the fundamental emissions stay within the authorized bands of operation.

4.2.2 Test Procedure

- a. Device is placed at the oven room. The oven room could control the temperatures and humidity. Power warm up is at least 15 min and power applied should perform before recording frequency error.
- b. EUT is connected the external power supply to control the DC input power. The test voltage range is from minimum to maximum working voltage. Each step shall be record the frequency error rate.
- c. The temperature range step is 10 degrees in this test items. All temperature levels shall be hold the $\pm 0.5^{\circ}\text{C}$ during the measurement testing. The each temperature step shall be at least 0.5 hours, consider the EUT could be test under the stability condition.

NOTE: The frequency error was recorded frequency error from the communication simulator.

4.2.3 Test Setup

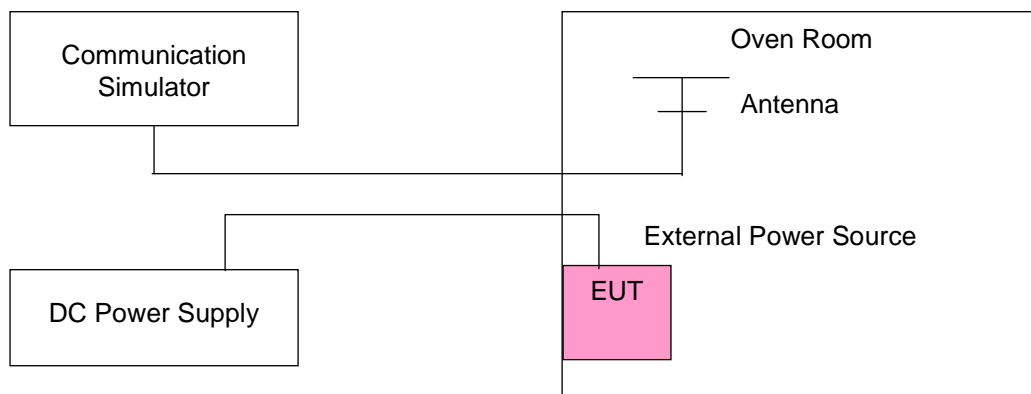

4.2.4 Test Results

LTE BAND 4

FREQUENCY ERROR VS. VOLTAGE

AFC FREQUENCY ERROR vs. VOLTAGE							
VOLTAGE (Volts)	FREQUENCY ERROR (ppm)						LIMIT (ppm)
	1.4MHz	3MHz	5MHz	10MHz	15MHz	20MHz	
3.9	0.0007	-0.0001	0.0006	0.0002	0.0001	0.0002	2.5
3.7	-0.0028	-0.0031	-0.0020	-0.0019	-0.0013	-0.0013	2.5
4.35	-0.0029	-0.0023	-0.0022	-0.0016	-0.0018	-0.0018	2.5

NOTE: The applicant defined the normal working voltage of the battery is from 3.7Vdc to 4.35Vdc.

AFC FREQUENCY ERROR vs. TEMPERATURE							
TEMP. (°C)	FREQUENCY ERROR (ppm)						LIMIT (ppm)
	1.4MHz	3MHz	5MHz	10MHz	15MHz	20MHz	
-30	-0.0071	-0.0071	-0.0066	-0.0074	-0.0068	-0.0066	2.5
-20	-0.0060	-0.0060	-0.5784	-0.0066	-0.0062	-0.0063	2.5
-10	-0.0053	-0.0053	-0.0053	-0.0060	-0.0054	-0.0054	2.5
0	-0.0047	-0.0046	-0.0045	-0.0052	-0.0046	-0.0044	2.5
10	-0.0043	-0.0041	-0.0037	-0.0043	-0.0042	-0.0037	2.5
20	-0.0032	-0.0031	-0.0031	-0.0037	-0.0035	-0.0029	2.5
30	-0.0019	-0.0025	-0.0022	-0.0028	-0.0025	-0.0022	2.5
40	-0.0008	-0.0019	-0.0012	-0.0017	-0.0017	-0.0013	2.5
50	-0.0002	-0.0008	-0.0008	-0.0009	-0.0006	-0.0006	2.5
60	0.0002	-0.0003	-0.0004	-0.0001	-0.0003	-0.0003	2.5

4.3 Occupied Bandwidth Measurement

4.3.1 Limits Of Occupied Bandwidth Measurement

The width of a frequency band such that, below the lower and above the upper frequency limits, the mean powers emitted are each equal to a specified percentage 0.5 %of the total mean power of a given emission.

4.3.2 Test Setup

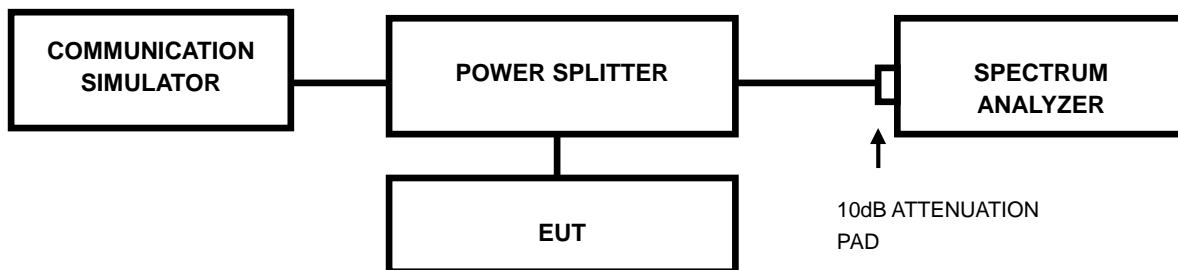

4.3.3 Test Procedures

- The conducted occupied bandwidth used the power splitter via EUT RF power connector between simulation base station and spectrum analyzer.
- Use OBW measurement function of Spectrum analyzer to measure 99 % occupied bandwidth.

4.3.4 Test Result

LTE BAND 4

CHANNEL BANDWIDTH: 1.4MHz				CHANNEL BANDWIDTH: 3MHz			
CHANNEL	Frequency (MHz)	99% OCCUPIED Bandwidth (MHz)		CHANNEL	Frequency (MHz)	99% OCCUPIED Bandwidth (MHz)	
		QPSK	16QAM			QPSK	16QAM
19957	1710.7	1.09	1.09	19965	1711.5	2.69	2.69
20175	1732.5	1.09	1.09	20175	1732.5	2.68	2.68
20393	1754.3	1.09	1.09	20385	1753.5	2.69	2.68

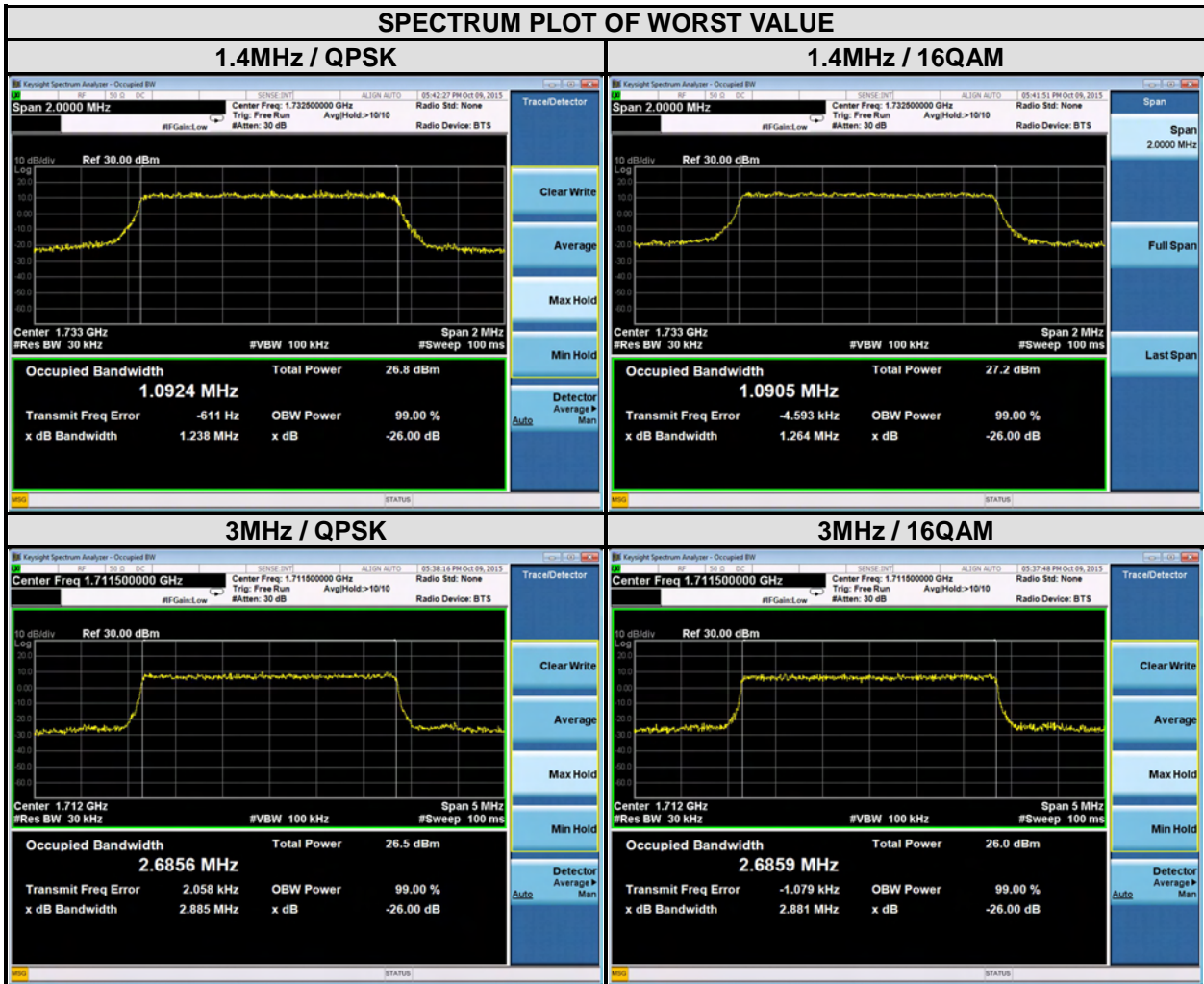

CHANNEL BANDWIDTH: 5MHz				CHANNEL BANDWIDTH: 10MHz			
CHANNEL	Frequency (MHz)	99% OCCUPIED Bandwidth (MHz)		CHANNEL	Frequency (MHz)	99% OCCUPIED Bandwidth (MHz)	
		QPSK	16QAM			QPSK	16QAM
19975	1712.5	4.48	4.48	20000	1715	8.94	8.94
20175	1732.5	4.48	4.48	20175	1732.5	8.94	8.95
20375	1752.5	4.48	4.48	20350	1750	8.94	8.93



CHANNEL BANDWIDTH: 15MHz				CHANNEL BANDWIDTH: 20MHz			
CHANNEL	FREQUENCY (MHz)	99% OCCUPIED BANDWIDTH (MHz)		CHANNEL	FREQUENCY (MHz)	99% OCCUPIED BANDWIDTH (MHz)	
		QPSK	16QAM			QPSK	16QAM
20025	1717.5	13.42	13.43	20050	1720	17.90	17.88
20175	1732.5	13.42	13.46	20175	1732.5	17.90	17.88
20325	1747.5	13.42	13.45	20300	1745	17.90	17.88

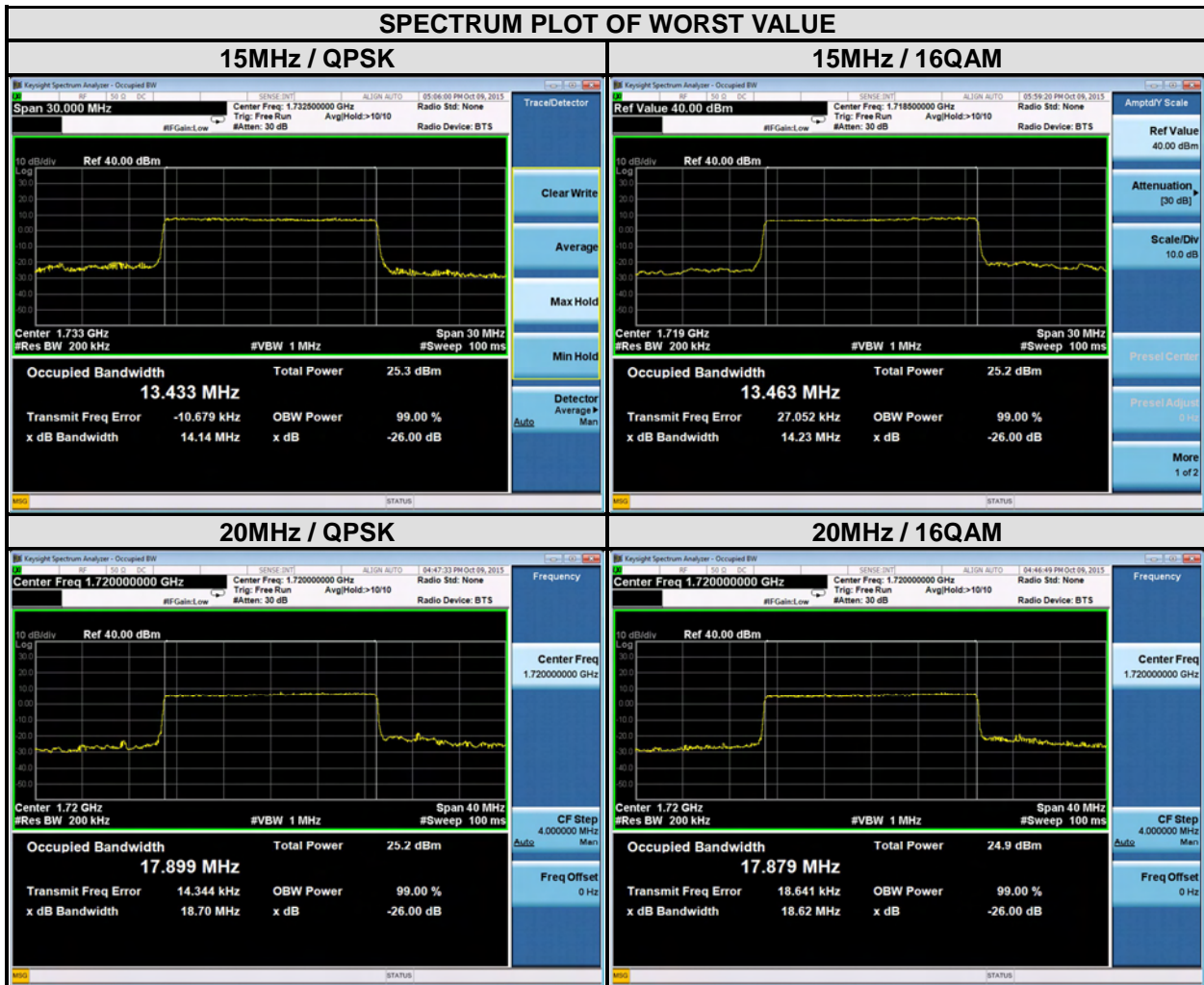

4.4 Peak To Average Ratio

4.4.1 Limits of Peak To Average Ratio Measurement

In measuring transmissions in this band using an average power technique, the peak to-average ratio (PAR) of the transmission may not exceed 13 dB

4.4.2 Test Setup

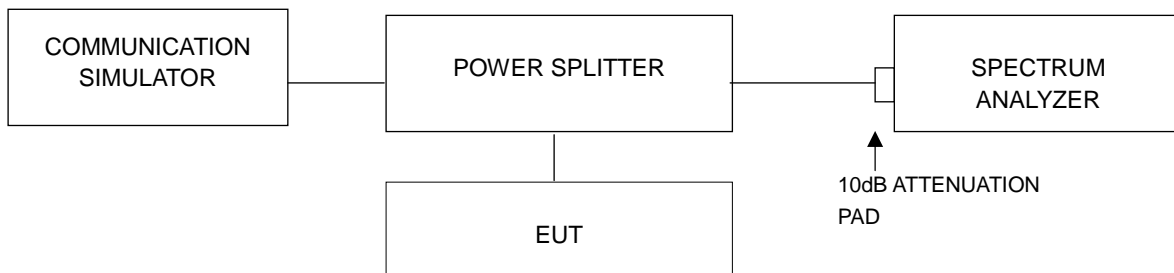

4.4.3 Test Procedures

1. Set resolution/measurement bandwidth \geq signal's occupied bandwidth;
2. Set the number of counts to a value that stabilizes the measured CCDF curve;
3. Record the maximum PAPR level associated with a probability of 0.1%.

4.4.4 Test Results

LTE BAND 4

CHANNEL BANDWIDTH: 1.4MHz				CHANNEL BANDWIDTH: 3MHz			
CHANNEL	FREQUENCY (MHz)	PEAK TO AVERAGE RATIO (dB)		CHANNEL	FREQUENCY (MHz)	PEAK TO AVERAGE RATIO (dB)	
		QPSK	16QAM			QPSK	16QAM
19957	1710.7	5.29	5.55	19965	1711.5	5.61	5.83
20175	1732.5	4.43	4.70	20175	1732.5	4.62	4.86
20393	1754.3	5.10	5.34	20385	1753.5	5.42	5.62

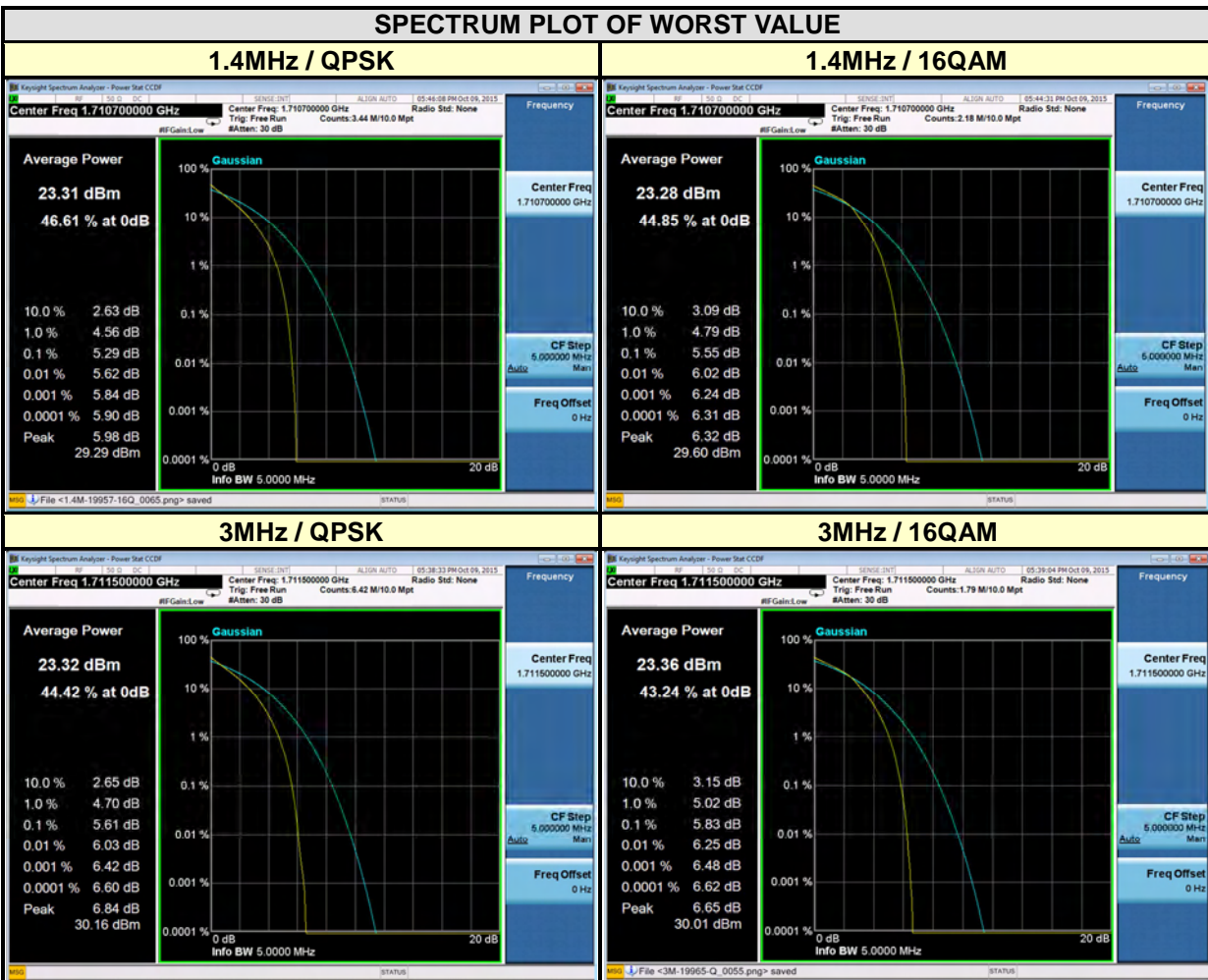

CHANNEL BANDWIDTH: 5MHz				CHANNEL BANDWIDTH: 10MHz			
CHANNEL	FREQUENCY (MHz)	PEAK TO AVERAGE RATIO (dB)		CHANNEL	FREQUENCY (MHz)	PEAK TO AVERAGE RATIO (dB)	
		QPSK	16QAM			QPSK	16QAM
19975	1712.5	5.71	6.08	20000	1715	5.52	5.77
20175	1732.5	4.97	5.22	20175	1732.5	4.56	4.79
20375	1752.5	4.48	4.48	20350	1750	5.54	5.71

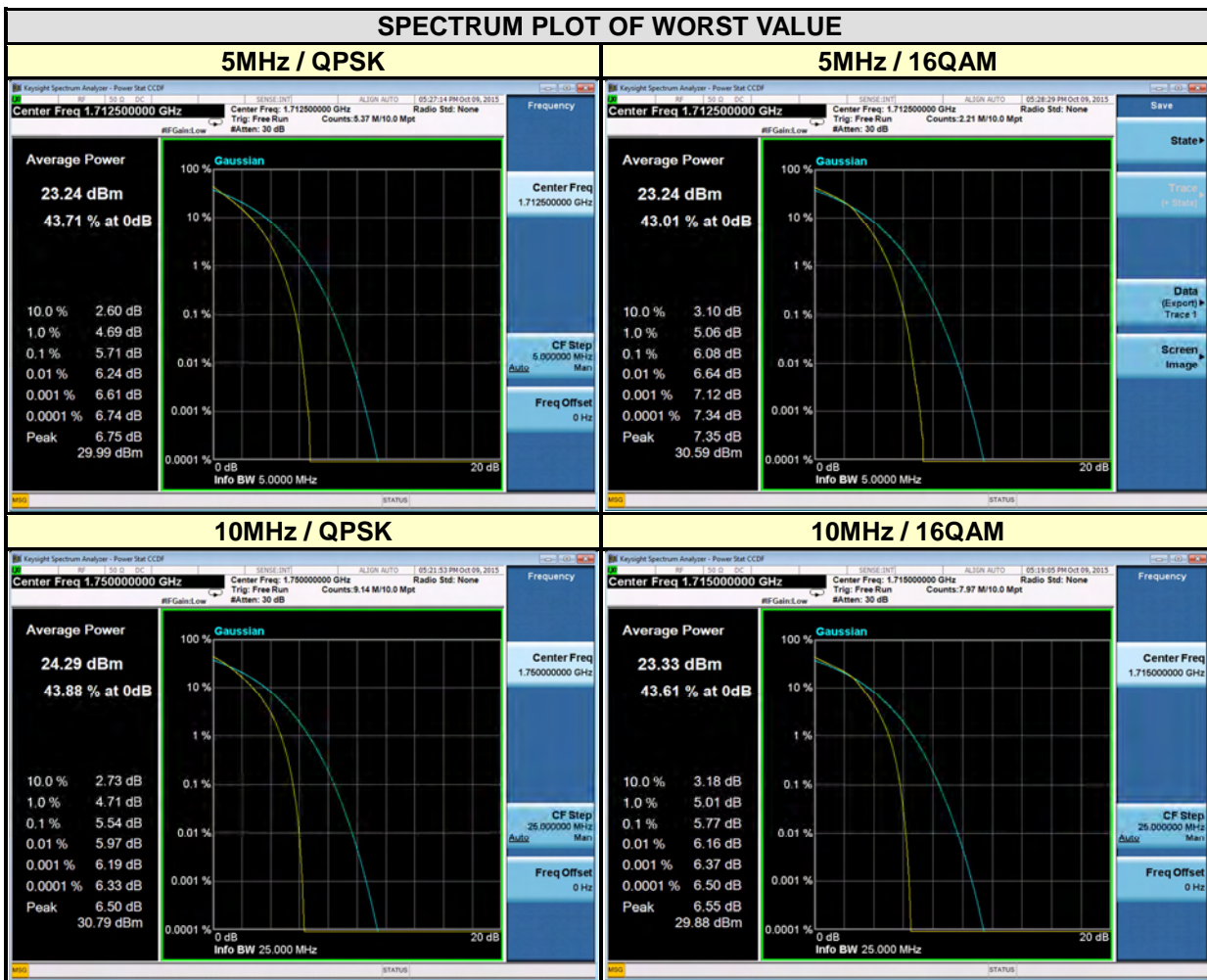

CHANNEL BANDWIDTH: 15MHz				CHANNEL BANDWIDTH: 20MHz			
CHANNEL	FREQUENCY (MHz)	PEAK TO AVERAGE RATIO (dB)		CHANNEL	FREQUENCY (MHz)	PEAK TO AVERAGE RATIO (dB)	
		QPSK	16QAM			QPSK	16QAM
20025	1717.5	5.50	5.77	20050	1720	5.38	5.75
20175	1732.5	4.88	5.11	20175	1732.5	5.10	5.41
20325	1747.5	5.38	5.69	20300	1745	5.34	5.74

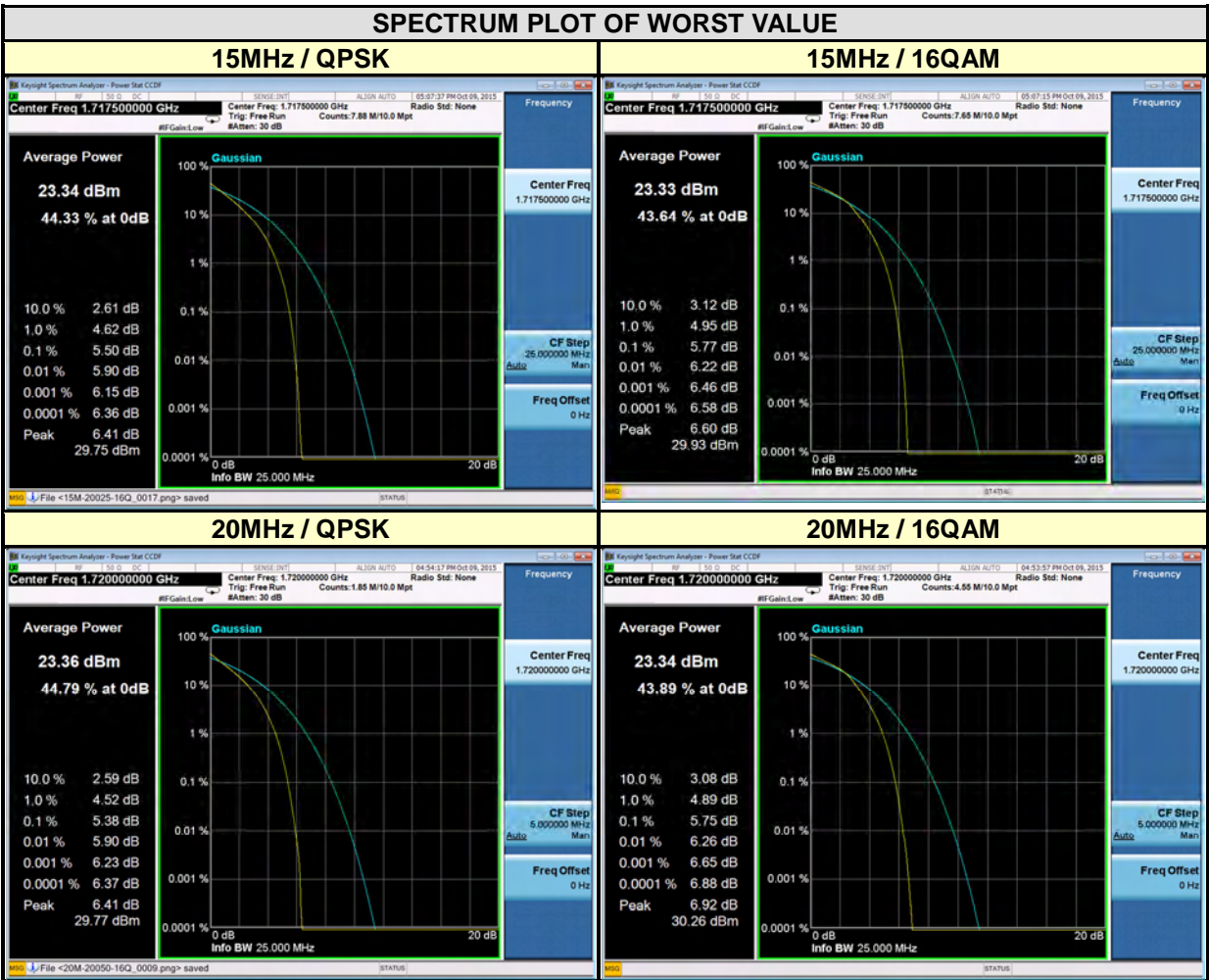

4.5 Band Edge Measurement

4.5.1 Limits of Band Edge Measurement

The power of any emission outside a licensee's frequency band(s) of operation shall be attenuated below the transmitter power (P) within the licensed band(s) of operation, measured in watts, by at least $43 + 10 \log (P)$ dB. Compliance with this provision is based on the use of measurement instrumentation employing a resolution bandwidth of 100 kilohertz or greater.

However, in the 100 kilohertz bands immediately outside and adjacent to a licensee's frequency block, a resolution bandwidth of at least 30 kHz may be employed.

4.5.2 Test Setup

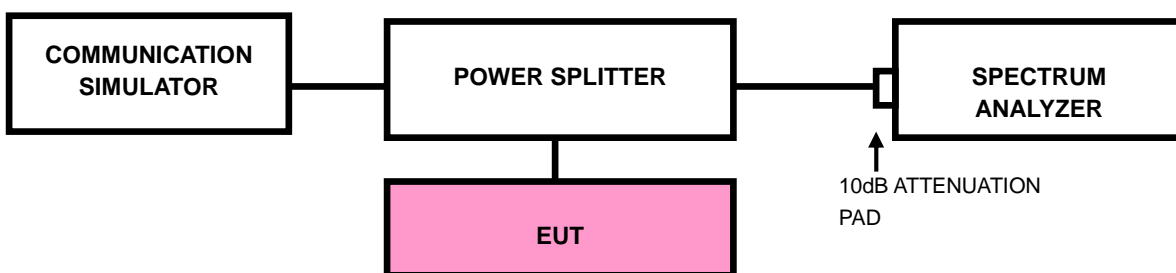

4.5.3 Test Procedures

- a. The EUT was set up for the maximum peak power with LTE link data modulation. The power was measured with R&S Spectrum Analyzer. All measurements were done at 2 channels (low and high operational frequency range.).
- b. The band edge measurement used the power splitter via EUT RF power connector between simulation base station and spectrum analyzer.
- c. The center frequency of spectrum is the band edge frequency and span is 1~5 MHz. RB of the spectrum is 20kHz and VB of the spectrum is 100 kHz. (LTE bandwidth 1.4MHz)
- d. The center frequency of spectrum is the band edge frequency and span is 1~5 MHz. RB of the spectrum is 30kHz and VB of the spectrum is 100kHz. (LTE bandwidth 3MHz)
- e. The center frequency of spectrum is the band edge frequency and span is 1~5 MHz. RB of the spectrum is 50kHz and VB of the spectrum is 200kHz. (LTE bandwidth 5MHz)
- f. The center frequency of spectrum is the band edge frequency and span is 1~5 MHz. RB of the spectrum is 100kHz and VB of the spectrum is 300kHz. (LTE bandwidth 10MHz)
- g. The center frequency of spectrum is the band edge frequency and span is 1~5 MHz. RB of the spectrum is 200kHz and VB of the spectrum is 1MHz. (LTE bandwidth 15MHz)
- h. The center frequency of spectrum is the band edge frequency and span is 1~5 MHz. RB of the spectrum is 200kHz and VB of the spectrum is 1MHz. (LTE bandwidth 20MHz)
- i. Record the max trace plot into the test report.

4.5.4 Test Results

LTE BAND 4

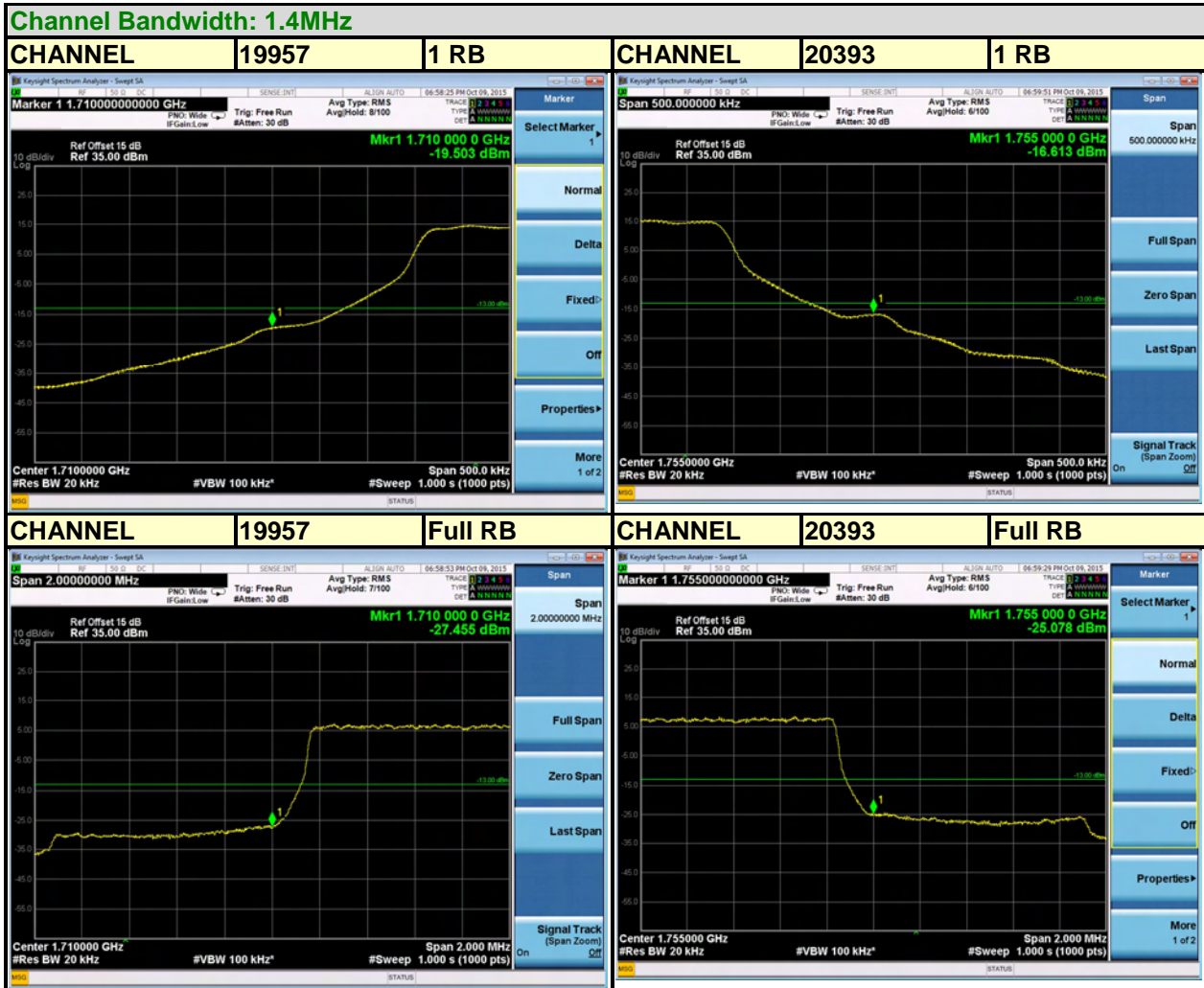

Channel Bandwidth: 3MHz

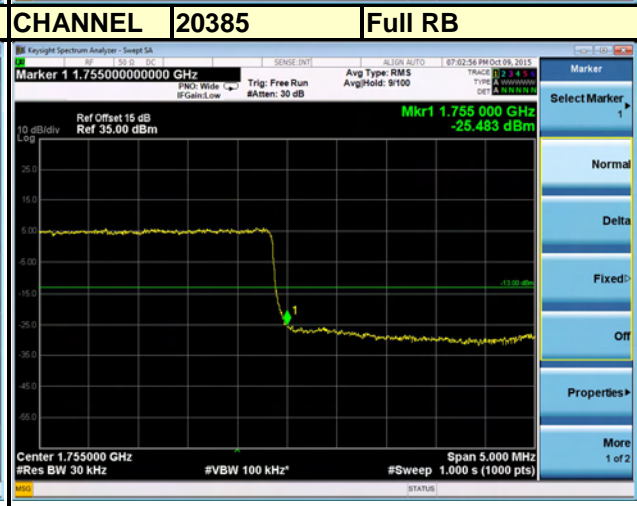
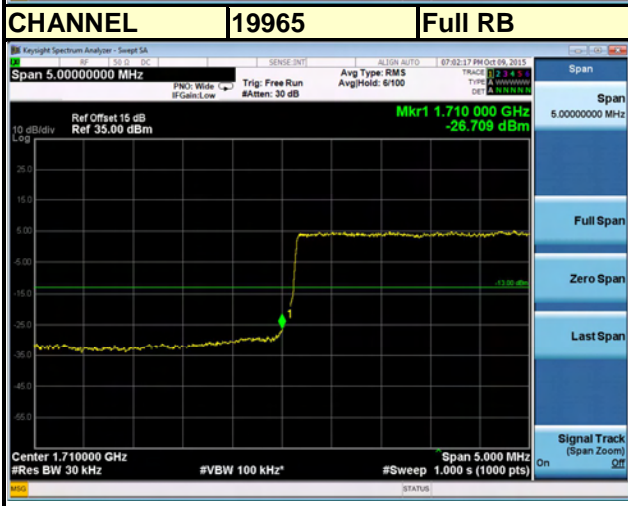
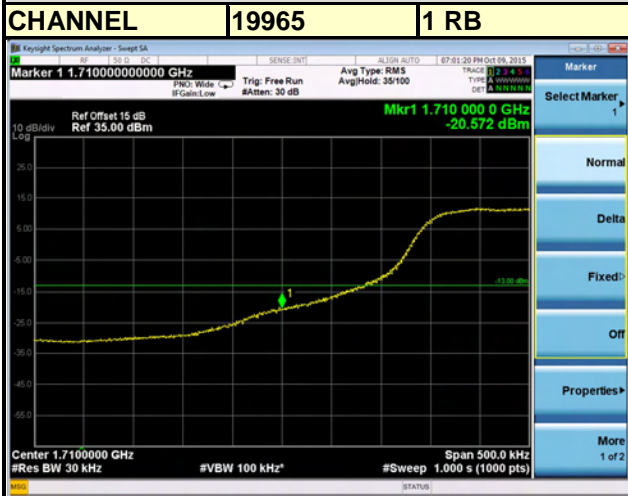

Channel Bandwidth: 5MHz

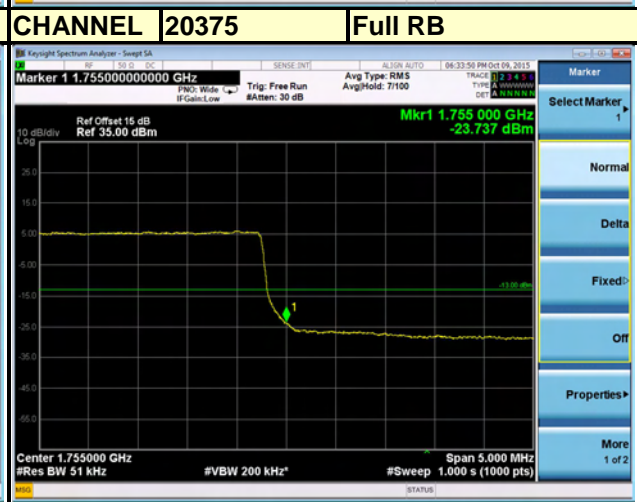
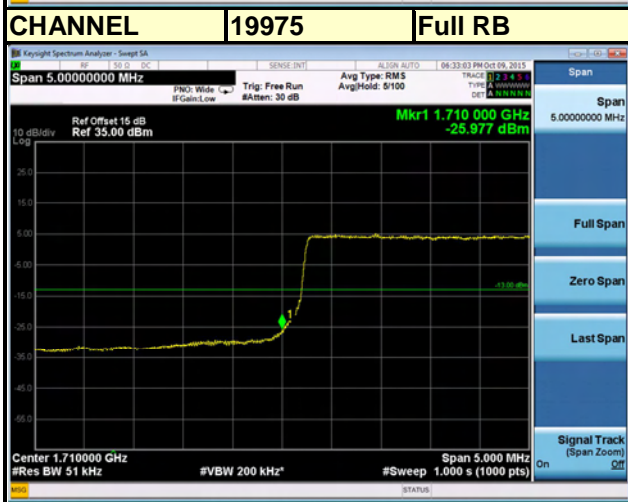
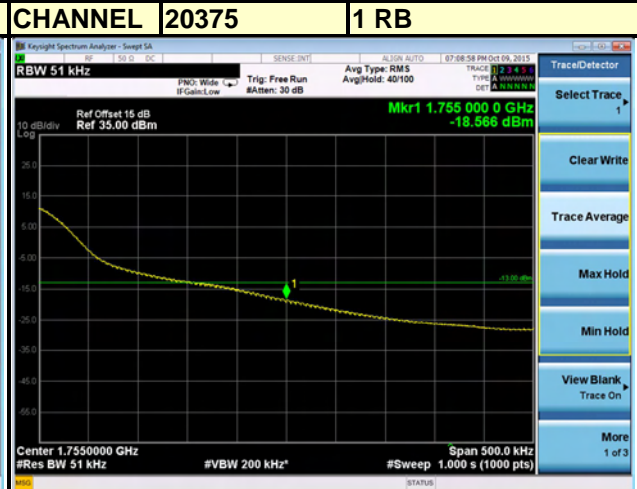
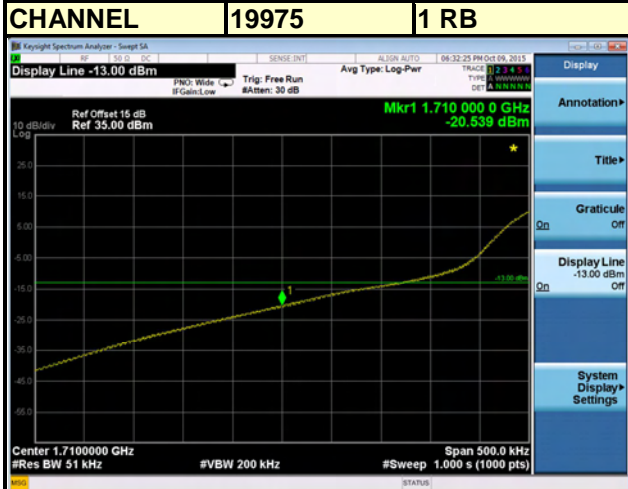

Channel Bandwidth: 10MHz

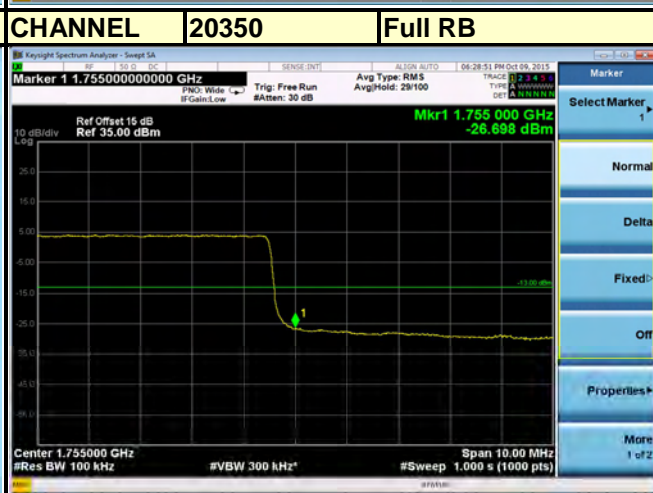
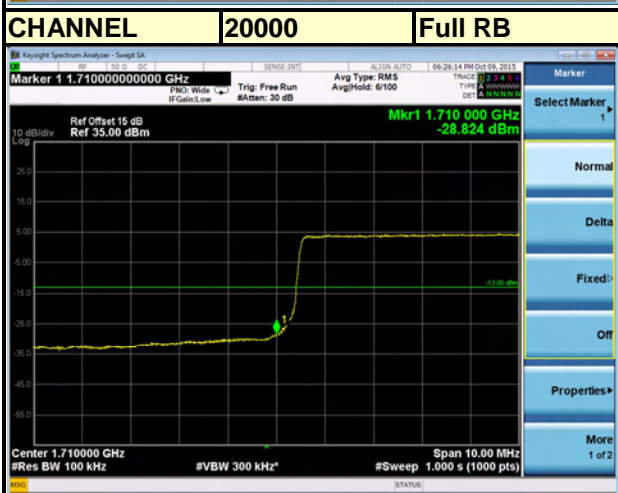
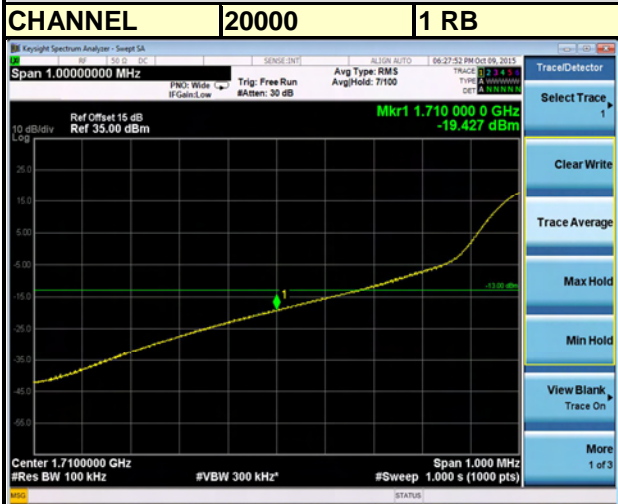

Channel Bandwidth: 15MHz

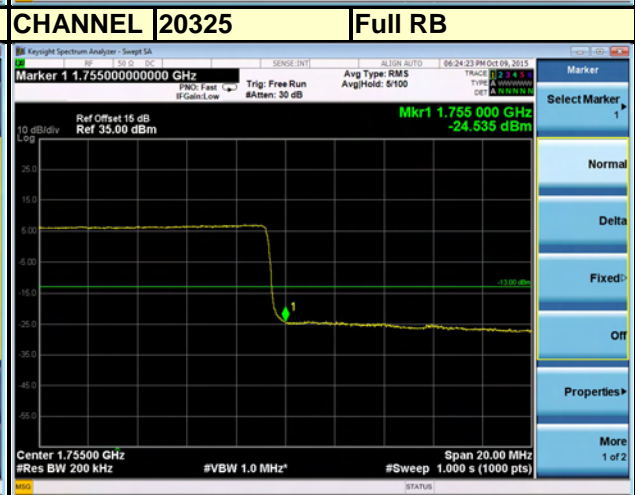
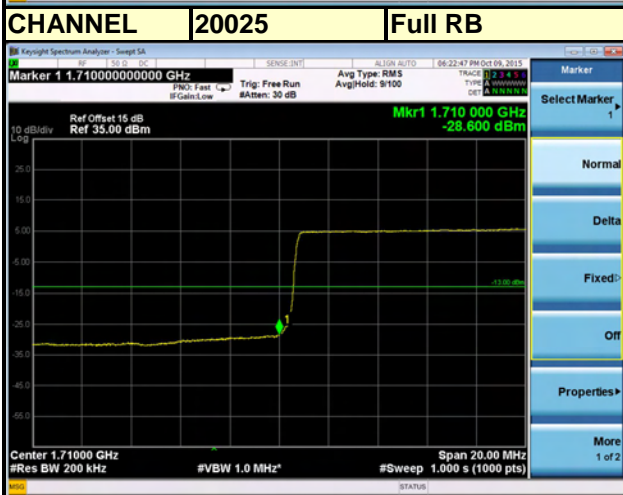
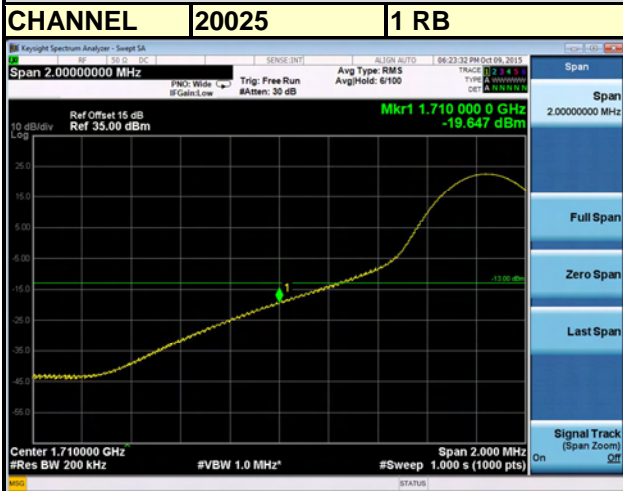

Channel Bandwidth: 20MHz

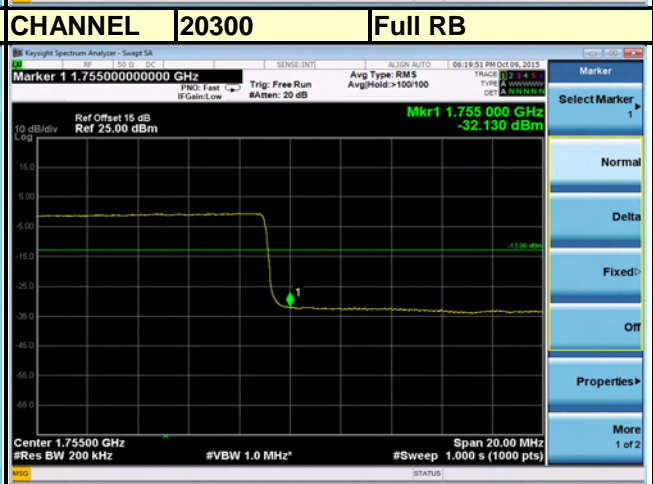
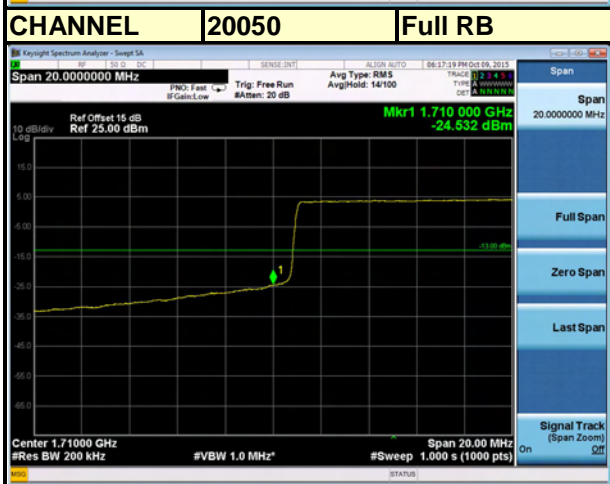
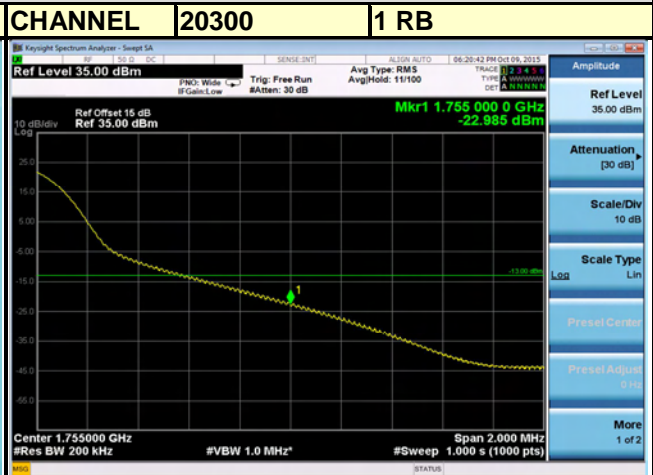
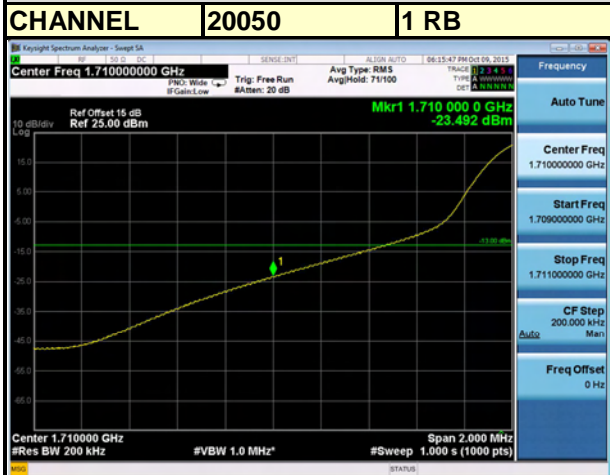

4.6 Conducted Spurious Emissions

4.6.1 Limits of Conducted Spurious Emissions Measurement

The power of any emission outside a licensee's frequency block shall be attenuated below the transmitter power (P) by at least $43 + 10 \log_{10}(P)$ dB. The limit of emission is equal to -13dBm.

4.6.2 Test Procedure

- a. The EUT makes a phone call to the communication simulator. All measurements were done at low, middle and high operational frequency range.
- b. Measuring frequency range is from 30MHz to 17.5GHz for LTE Band 4. 10dB attenuation pad is connected with spectrum. RBW=1MHz and VBW=3MHz are used for conducted emission measurement.

4.6.3 Test Setup

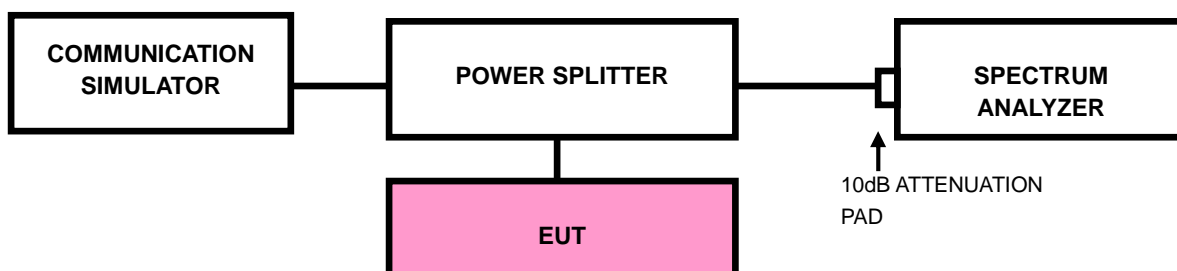

4.6.4 Test Results

LTE BAND 4

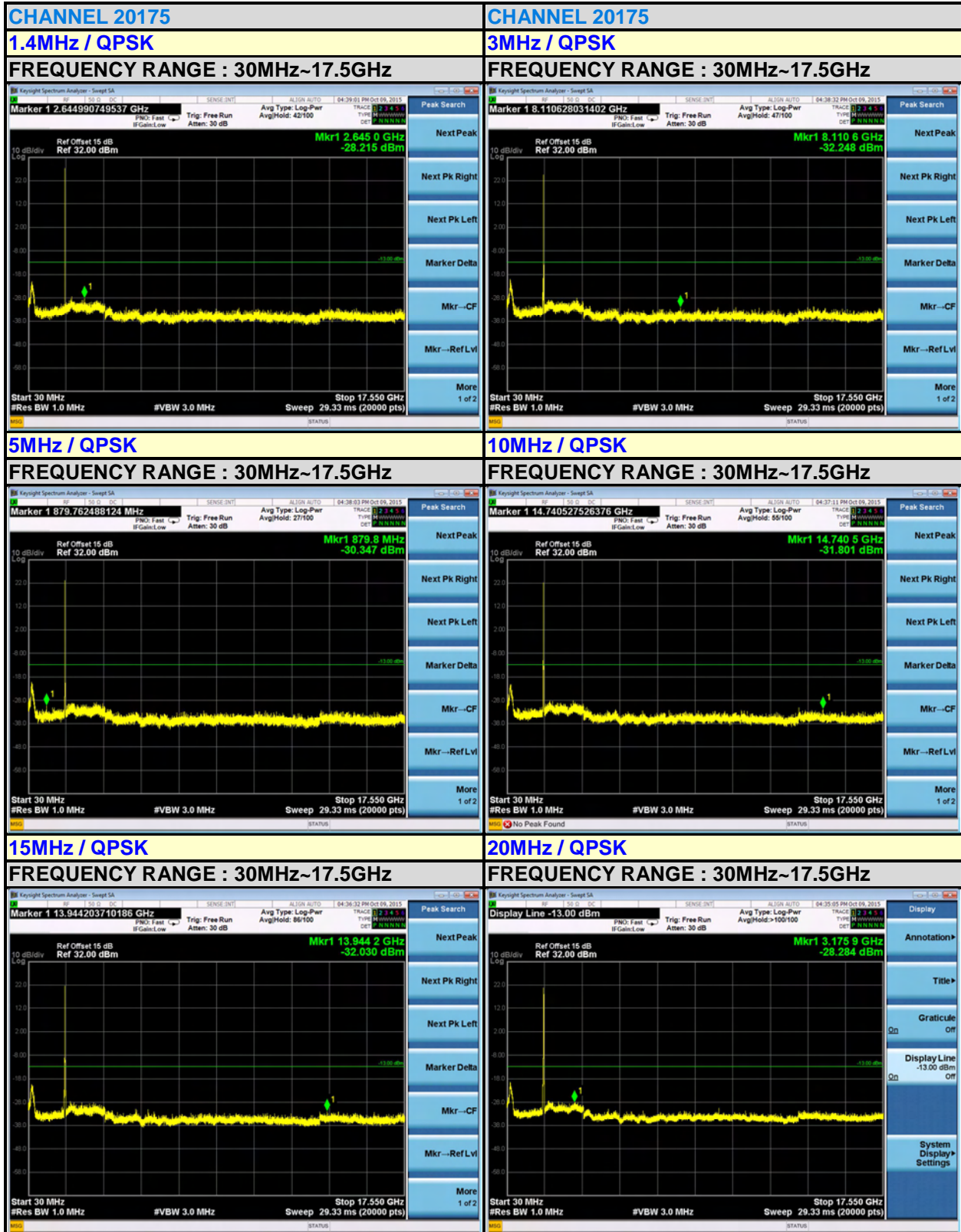

4.7 Radiated Emission Measurement

4.7.1 Limits of Radiated Emission Measurement

In the FCC 27.53(m) (4), On any frequency outside a licensee's frequency block, The power of any emission shall be attenuated below the transmitter power (P) by at least $43 + 10 \log (P)$ dB. The emission limit equal to -13dBm.

4.7.2 Test Procedure

- a. Substitution method is used for E.I.R.P measurement. In the semi-anechoic chamber, EUT placed on the 0.8m height of Turn Table, rotated the table around 360 degrees to search the maximum radiation power and receiver antenna shall be rotated vertical and horizontal polarization and moved height from 1m to 4m to find the maximum polar radiated power. The "Read Value" is the spectrum reading the maximum power value.
- b. The substitution horn antenna is substituted for EUT at the same position and signals generator export the CW signal to the substitution antenna via a TX cable. Rotated the Turn Table and moved receiving antenna to find the maximum radiation power. Adjust output power level of S.G to get a Value of spectrum reading equal to "Read Value " of step a. Record the power level of S.G.
- c. $EIRP = \text{Output power level of S.G} - \text{TX cable loss} + \text{Antenna gain of substitution horn}$.
- d. E.R.P power can be calculated form E.I.R.P power by subtracting the gain of dipole, $E.R.P \text{ power} = E.I.P.R \text{ power} - 2.15\text{dBi}$.

NOTE: The resolution bandwidth of spectrum analyzer is 1 MHz and the video bandwidth is 3 MHz.

4.7.3 Deviation from Test Standard

No deviation.

4.7.4 Test Setup

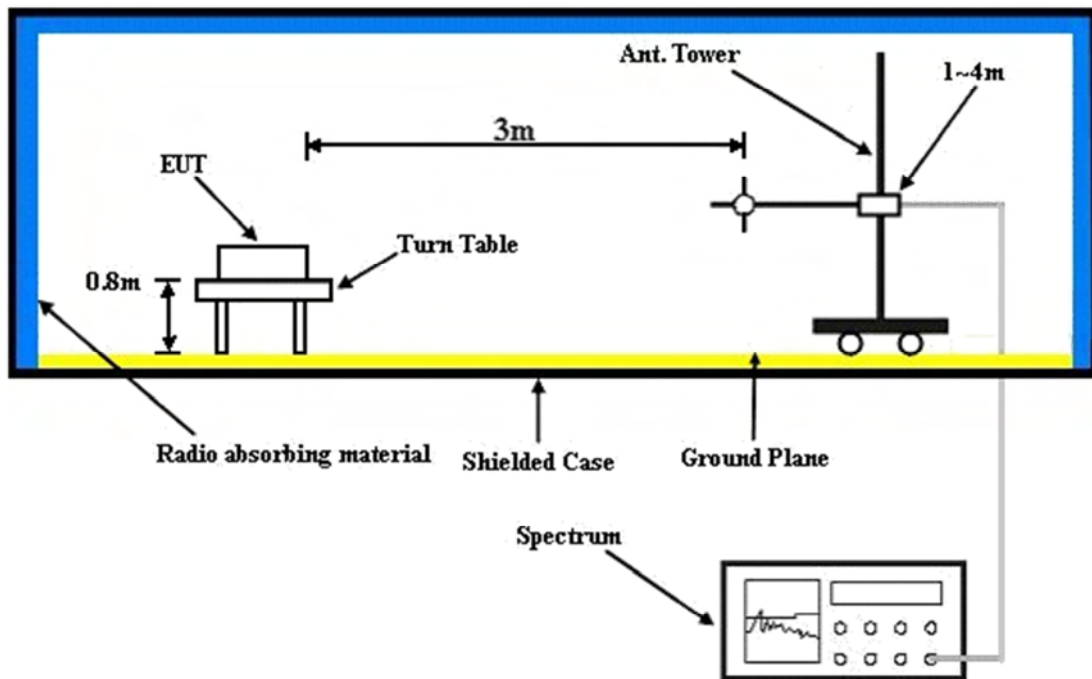

For the actual test configuration, please refer to the attached file (Test Setup Photo).

4.7.5 Test Results

BELOW 1GHz WORST-CASE DATA

LTE Band 4:

MODE	TX channel20175	FREQUENCY RANGE	Below 1000MHz
ENVIRONMENTAL CONDITIONS	23deg. C, 63%RH	INPUT POWER	DC 5V from adapter
TESTED BY	Green		
ANTENNA POLARITY & TEST DISTANCE: HORIZONTAL AT 3 M			

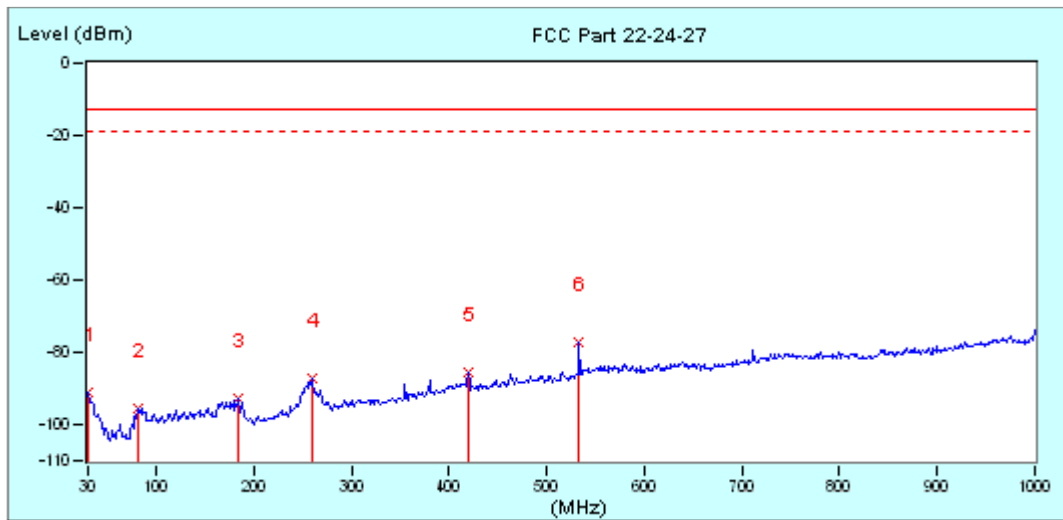

No.	Frequency MHz	Factor dB	Reading dBm	Emission dBm	Limit dBm	Margin dB	Tower / Table cm deg
1	30.00	-12.55	-78.30	-90.85	-13.00	-77.85	100 0
2	82.01	-23.15	-72.51	-95.66	-13.00	-82.66	100 0
3	184.64	-20.50	-72.03	-92.53	-13.00	-79.53	100 0
4	259.14	-15.67	-71.38	-87.05	-13.00	-74.05	100 0
5	419.41	-10.87	-74.71	-85.58	-13.00	-72.58	100 0
* 6	533.28	-7.56	-69.91	-77.47	-13.00	-64.47	100 0

MODE	TX channel20175	FREQUENCY RANGE	Below 1000MHz
ENVIRONMENTAL CONDITIONS	23deg. C, 63%RH	INPUT POWER	DC 5V from adapter
TESTED BY	Green		
ANTENNA POLARITY & TEST DISTANCE: VERTICAL AT 3 M			

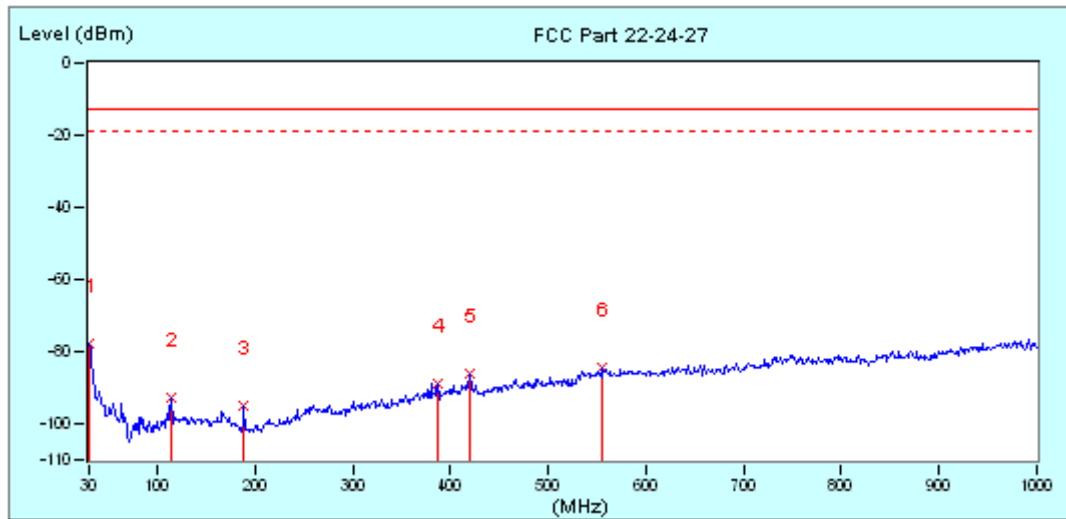

No.	Frequency MHz	Factor dB	Reading dBm	Emission dBm	Limit dBm	Margin dB	Tower / Table cm deg	
*	1	-12.55	-65.47	-78.02	-13.00	-65.02	100	0
	2	-19.01	-73.57	-92.58	-13.00	-79.58	100	0
	3	-20.84	-73.96	-94.80	-13.00	-81.80	100	0
	4	-12.50	-76.37	-88.87	-13.00	-75.87	100	0
	5	-10.87	-75.18	-86.05	-13.00	-73.05	100	0
	6	-6.12	-78.58	-84.70	-13.00	-71.70	100	0

ABOVE 1GHz

LTE BAND 4

CHANNEL BANDWIDTH: 1.4MHz / QPSK

MODE	TX channel 20175	FREQUENCY RANGE	Above 1000MHz
ENVIRONMENTAL CONDITIONS	23deg. C, 63%RH	INPUT POWER	DC 5V from adapter
TESTED BY	Green		
ANTENNA POLARITY & TEST DISTANCE: HORIZONTAL AT 3 M			

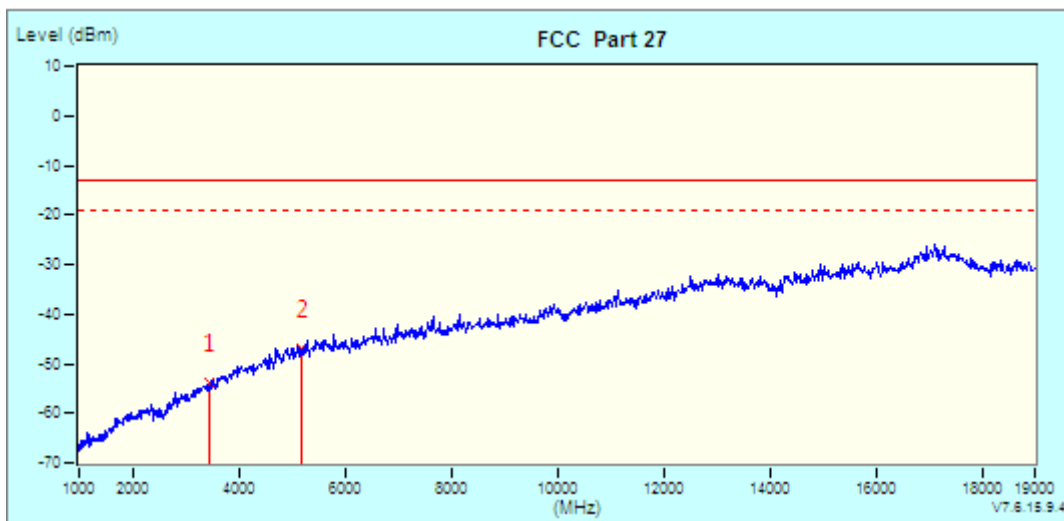

No.	Frequency MHz	Factor dB	Reading dBm	Emission dBm	Limit dBm	Margin dB	Tower / Table cm deg	
1	3465.00 (PK)	2.03	-55.68	-53.65	-13.00	-40.65	100	0
*	2	8.61	-55.48	-46.87	-13.00	-33.87	100	0

MODE	TX channel 20175	FREQUENCY RANGE	Above 1000MHz
ENVIRONMENTAL CONDITIONS	23deg. C, 63%RH	INPUT POWER	DC 5V from adapter
TESTED BY	Green		
ANTENNA POLARITY & TEST DISTANCE: VERTICAL AT 3 M			

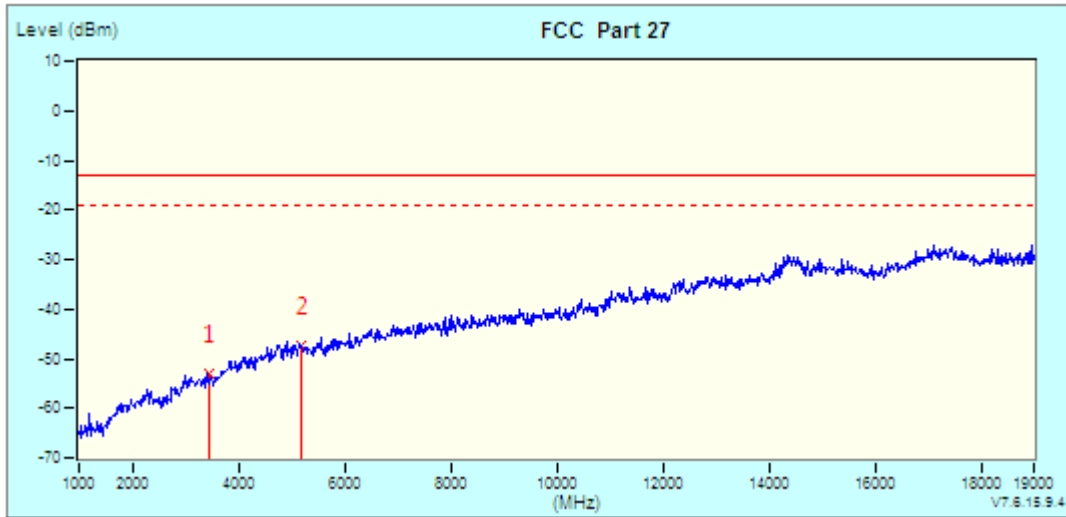

No.	Frequency MHz	Factor dB	Reading dBm	Emission dBm	Limit dBm	Margin dB	Tower / Table cm deg	
1	3465.00 (PK)	2.53	-55.61	-53.08	-13.00	-40.08	100	0
* 2	5197.50 (PK)	7.98	-55.21	-47.23	-13.00	-34.23	100	0

CHANNEL BANDWIDTH: 3MHz / QPSK

MODE	TX channel 20175	FREQUENCY RANGE	Above 1000MHz
ENVIRONMENTAL CONDITIONS	23deg. C, 63%RH	INPUT POWER	DC 5V from adapter
TESTED BY	Green		
ANTENNA POLARITY & TEST DISTANCE: HORIZONTAL AT 3 M			

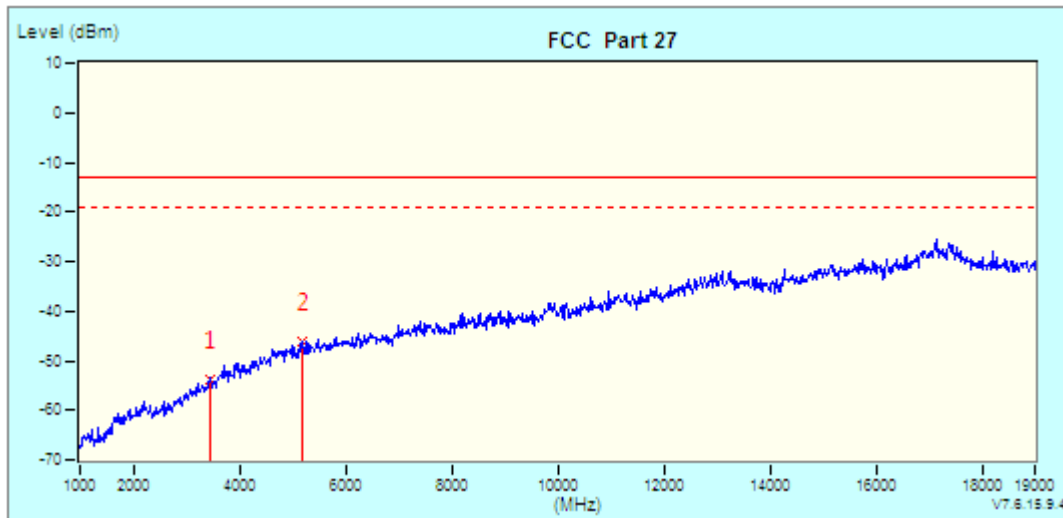

No.	Frequency MHz	Factor dB	Reading dBm	Emission dBm	Limit dBm	Margin dB	Tower / Table cm deg	
1	3465.00 (PK)	2.03	-55.92	-53.89	-13.00	-40.89	100	0
* 2	5197.50 (PK)	8.61	-54.68	-46.07	-13.00	-33.07	100	0

MODE	TX channel 20175	FREQUENCY RANGE	Above 1000MHz
ENVIRONMENTAL CONDITIONS	23deg. C, 63%RH	INPUT POWER	DC 5V from adapter
TESTED BY	Green		
ANTENNA POLARITY & TEST DISTANCE: VERTICAL AT 3 M			

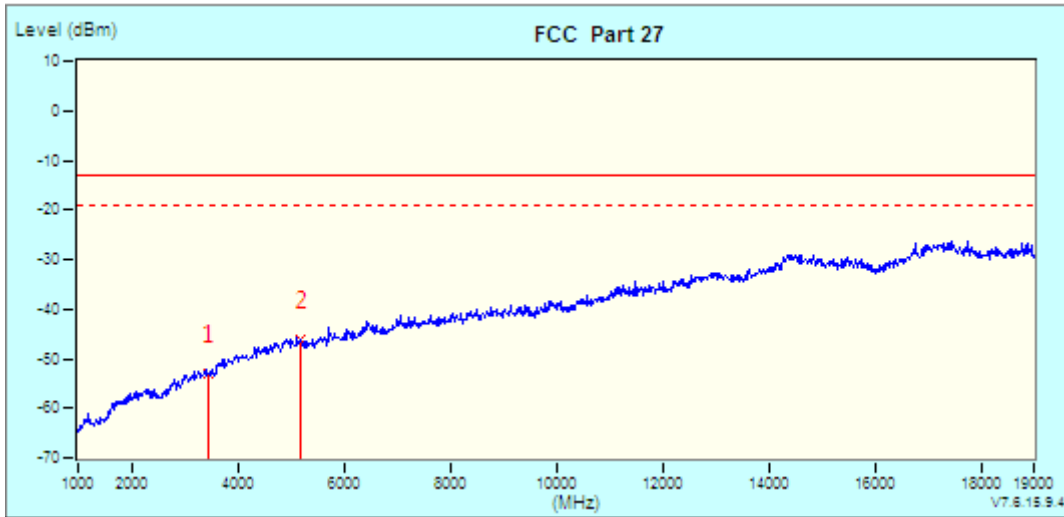

No.	Frequency MHz	Factor dB	Reading dBm	Emission dBm	Limit dBm	Margin dB	Tower / Table cm deg	
1	3465.00 (PK)	2.53	-55.61	-53.08	-13.00	-40.08	100	0
* 2	5197.50 (PK)	7.98	-54.27	-46.29	-13.00	-33.29	100	0

CHANNEL BANDWIDTH: 5MHz / QPSK

MODE	TX channel 20175	FREQUENCY RANGE	Above 1000MHz
ENVIRONMENTAL CONDITIONS	23deg. C, 63%RH	INPUT POWER	DC 5V from adapter
TESTED BY	Green		
ANTENNA POLARITY & TEST DISTANCE: HORIZONTAL AT 3 M			

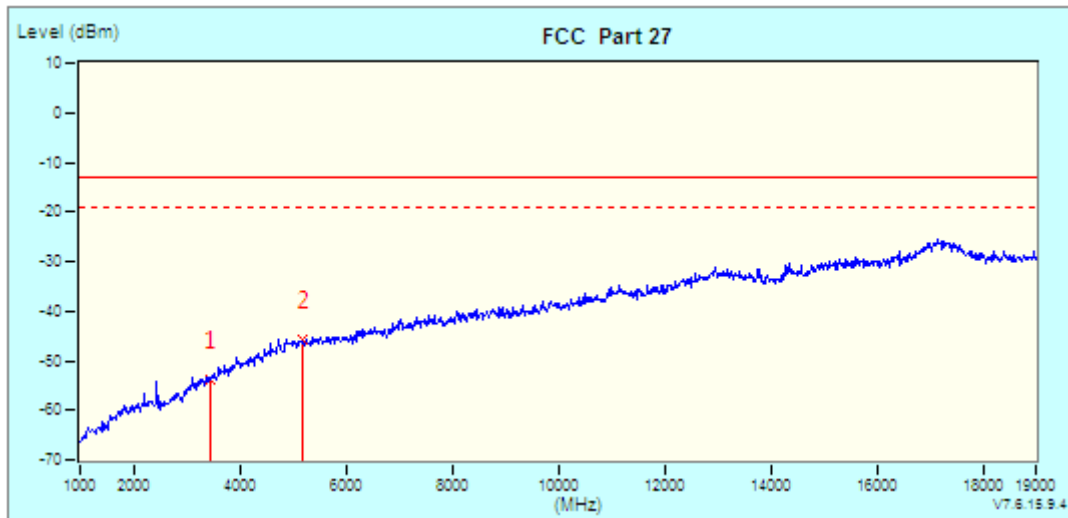

No.	Frequency MHz	Factor dB	Reading dBm	Emission dBm	Limit dBm	Margin dB	Tower / Table cm deg	
1	3465.00 (PK)	2.03	-55.92	-53.89	-13.00	-40.89	100	0
*	2	8.61	-54.53	-45.92	-13.00	-32.92	100	0

MODE	TX channel 20175	FREQUENCY RANGE	Above 1000MHz
ENVIRONMENTAL CONDITIONS	23deg. C, 63%RH	INPUT POWER	DC 5V from adapter
TESTED BY	Green		
ANTENNA POLARITY & TEST DISTANCE: VERTICAL AT 3 M			

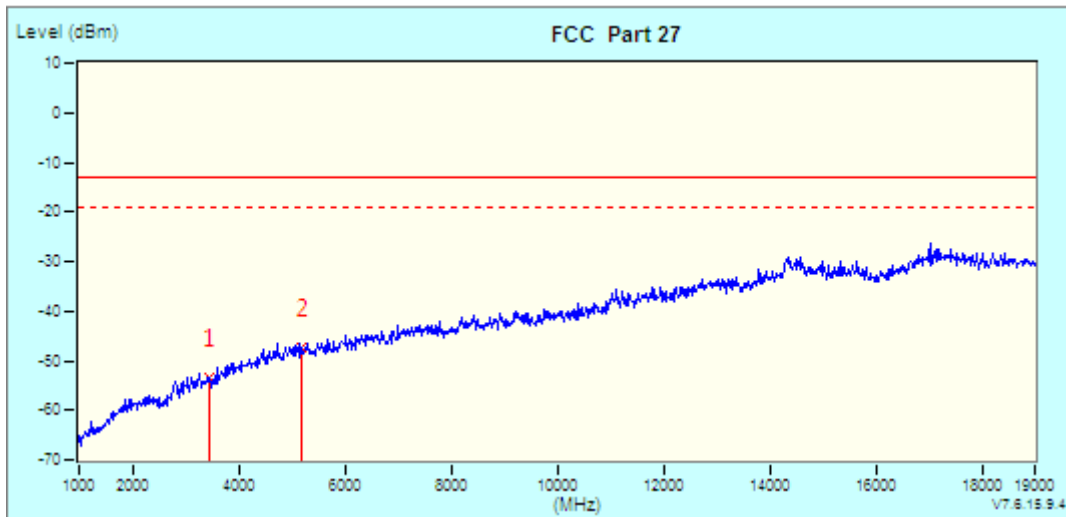

No.	Frequency MHz	Factor dB	Reading dBm	Emission dBm	Limit dBm	Margin dB	Tower / Table	
							cm	deg
1	3465.00 (PK)	2.53	-55.88	-53.35	-13.00	-40.35	100	0
* 2	5197.50 (PK)	7.98	-55.30	-47.32	-13.00	-34.32	100	0

CHANNEL BANDWIDTH: 10MHz / QPSK

MODE	TX channel 20175	FREQUENCY RANGE	Above 1000MHz
ENVIRONMENTAL CONDITIONS	23deg. C, 63%RH	INPUT POWER	DC 5V from adapter
TESTED BY	Green		
ANTENNA POLARITY & TEST DISTANCE: HORIZONTAL AT 3 M			

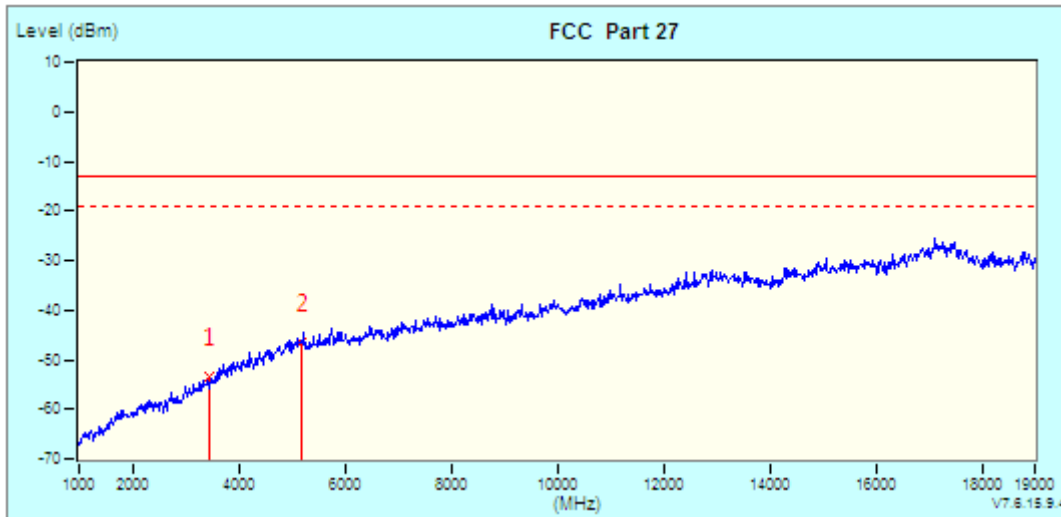

No.	Frequency MHz	Factor dB	Reading dBm	Emission dBm	Limit dBm	Margin dB	Tower / Table cm deg	
1	3465.00 (PK)	2.03	-55.36	-53.33	-13.00	-40.33	100	0
* 2	5197.50 (PK)	8.61	-55.21	-46.60	-13.00	-33.60	100	0

MODE	TX channel 20175	FREQUENCY RANGE	Above 1000MHz
ENVIRONMENTAL CONDITIONS	23deg. C, 63%RH	INPUT POWER	DC 5V from adapter
TESTED BY	Green		
ANTENNA POLARITY & TEST DISTANCE: VERTICAL AT 3 M			

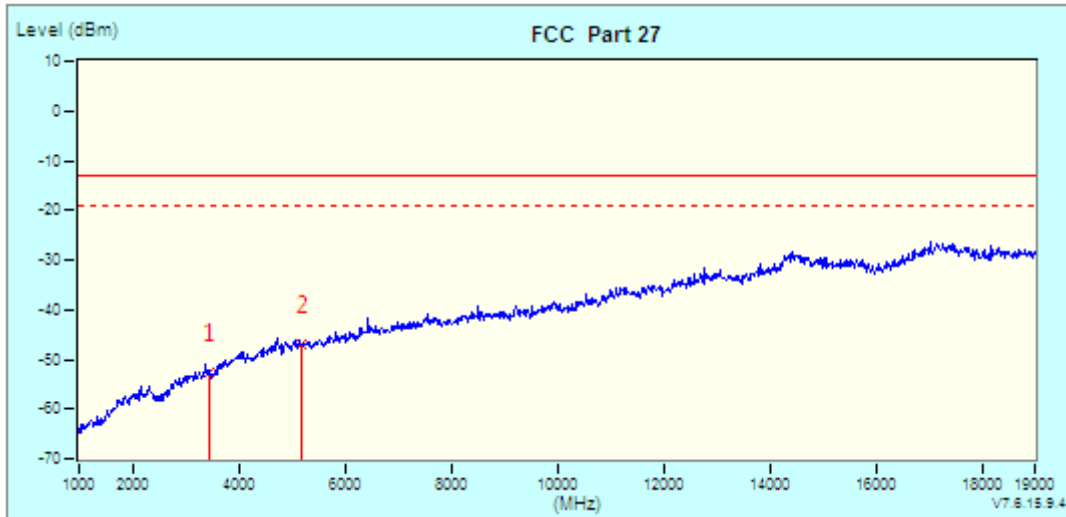

No.	Frequency MHz	Factor dB	Reading dBm	Emission dBm	Limit dBm	Margin dB	Tower / Table cm deg	
1	3465.00 (PK)	2.53	-55.16	-52.63	-13.00	-39.63	100	0
* 2	5197.50 (PK)	7.98	-55.08	-47.10	-13.00	-34.10	100	0

CHANNEL BANDWIDTH: 15MHz / QPSK

MODE	TX channel 20175	FREQUENCY RANGE	Above 1000MHz
ENVIRONMENTAL CONDITIONS	23deg. C, 63%RH	INPUT POWER	DC 5V from adapter
TESTED BY	Green		
ANTENNA POLARITY & TEST DISTANCE: HORIZONTAL AT 3 M			

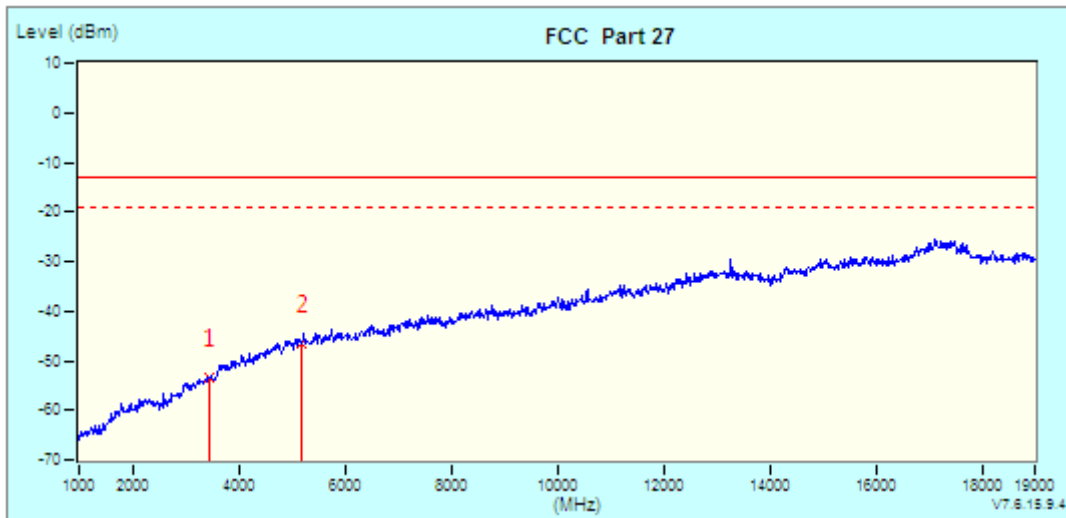

No.	Frequency MHz	Factor dB	Reading dBm	Emission dBm	Limit dBm	Margin dB	Tower / Table	
							cm	deg
1	3465.00 (PK)	2.03	-55.36	-53.33	-13.00	-40.33	100	0
* 2	5197.50 (PK)	8.61	-55.07	-46.46	-13.00	-33.46	100	0

MODE	TX channel 20175	FREQUENCY RANGE	Above 1000MHz
ENVIRONMENTAL CONDITIONS	23deg. C, 63%RH	INPUT POWER	DC 5V from adapter
TESTED BY	Green		
ANTENNA POLARITY & TEST DISTANCE: VERTICAL AT 3 M			

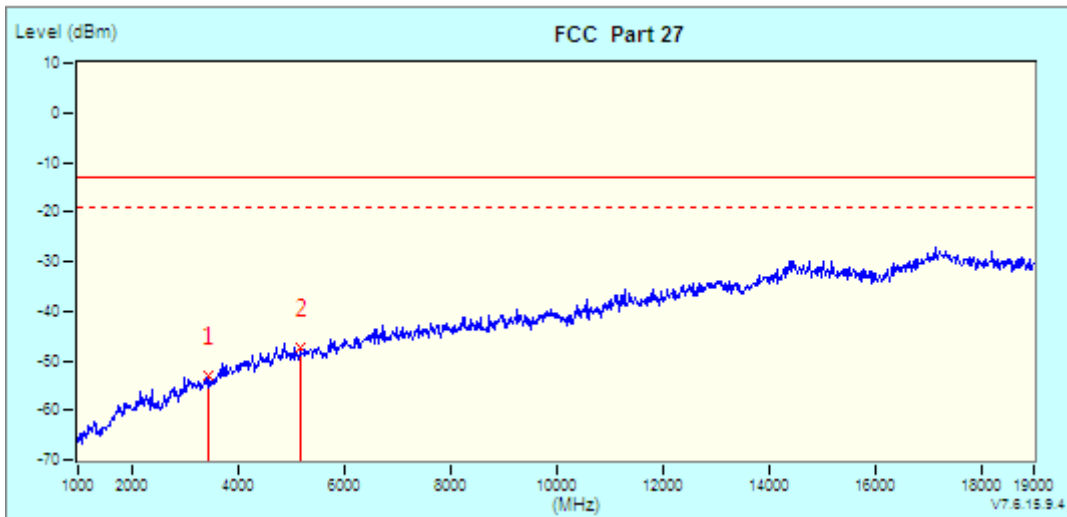

No.	Frequency MHz	Factor dB	Reading dBm	Emission dBm	Limit dBm	Margin dB	Tower / Table	
							cm	deg
1	3465.00 (PK)	2.53	-55.71	-53.18	-13.00	-40.18	100	0
* 2	5197.50 (PK)	7.98	-55.43	-47.45	-13.00	-34.45	100	0

CHANNEL BANDWIDTH: 20MHz / QPSK

MODE	TX channel 20175	FREQUENCY RANGE	Above 1000MHz
ENVIRONMENTAL CONDITIONS	23deg. C, 63%RH	INPUT POWER	DC 5V from adapter
TESTED BY	Green		
ANTENNA POLARITY & TEST DISTANCE: HORIZONTAL AT 3 M			

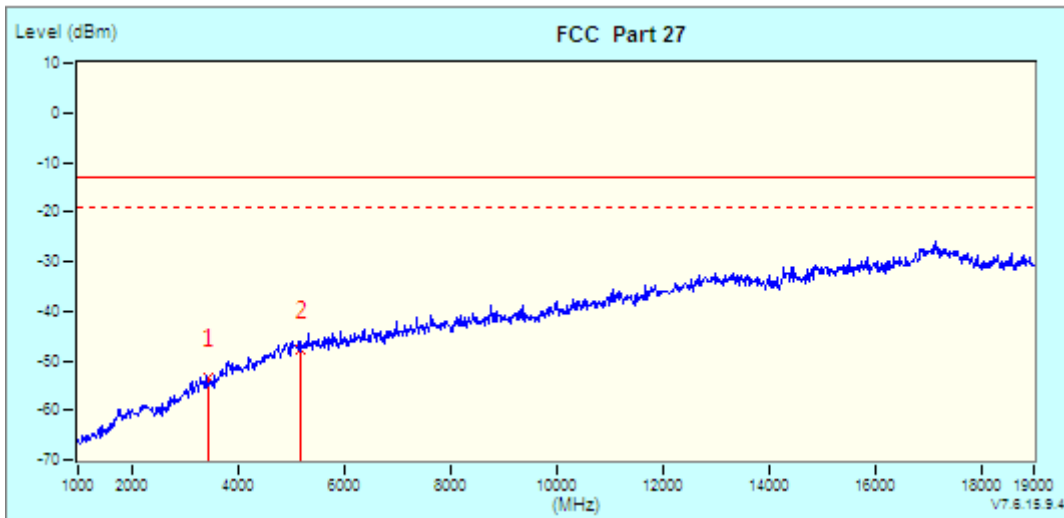

No.	Frequency MHz	Factor dB	Reading dBm	Emission dBm	Limit dBm	Margin dB	Tower / Table cm deg
1	3465.00 (PK)	2.03	-55.38	-53.35	-13.00	-40.35	100 0
* 2	5197.50 (PK)	8.61	-56.26	-47.65	-13.00	-34.65	100 0

MODE	TX channel 20175	FREQUENCY RANGE	Above 1000MHz
ENVIRONMENTAL CONDITIONS	23deg. C, 63%RH	INPUT POWER	DC 5V from adapter
TESTED BY	Green		
ANTENNA POLARITY & TEST DISTANCE: VERTICAL AT 3 M			

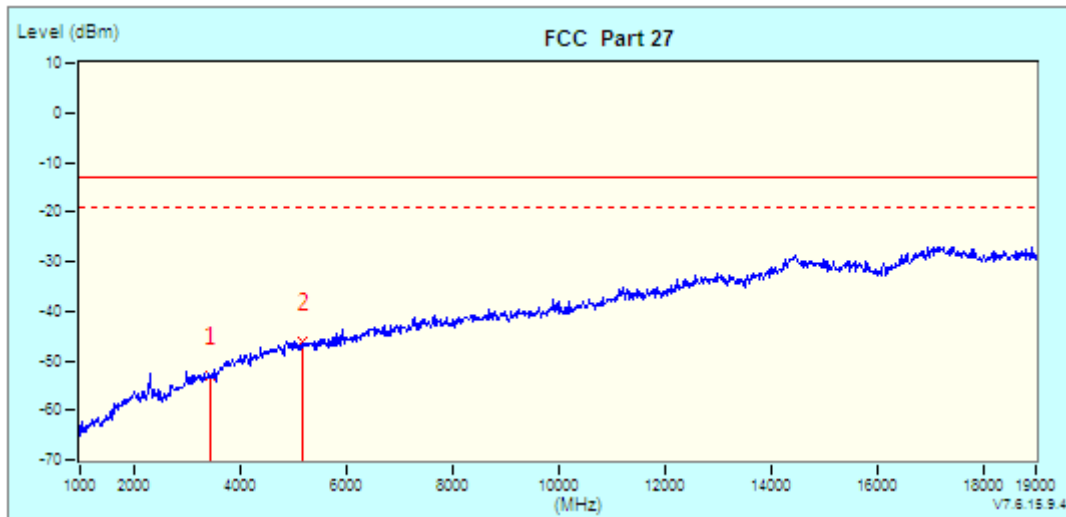

No.	Frequency MHz	Factor dB	Reading dBm	Emission dBm	Limit dBm	Margin dB	Tower / Table cm deg	
1	3465.00 (PK)	2.53	-55.71	-53.18	-13.00	-40.18	100	0
* 2	5197.50 (PK)	7.98	-54.14	-46.16	-13.00	-33.16	100	0

5 Pictures of Test Arrangements

Please refer to the attached file (Test Setup Photo).

Appendix – Information on the Testing Laboratories

We, Bureau Veritas Consumer Products Services (H.K.) Ltd., Taoyuan Branch, were founded in 1988 to provide our best service in EMC, Radio, Telecom and Safety consultation. Our laboratories are accredited and approved according to ISO/IEC 17025.

If you have any comments, please feel free to contact us at the following:

Linko EMC/RF Lab

Tel: 886-2-26052180

Fax: 886-2-26051924

Hsin Chu EMC/RF Lab/Telecom Lab

Tel: 886-3-5935343

Fax: 886-3-5935342

Hwa Ya EMC/RF/Safety

Tel: 886-3-3183232

Fax: 886-3-3270892

Email: service.adt@tw.bureauveritas.com

Web Site: www.bureauveritas-adt.com

The address and road map of all our labs can be found in our web site also.

--- END ---