

FCC Test Report (PART 24)

Report No.: RF150915W002-4

FCC ID: YCNA2010L36

Test Model: Lenovo A2010I36

Received Date: Sep. 15, 2015

Test Date: Sep. 16, 2015 ~ Oct. 12, 2015

Issued Date: Oct. 13, 2015

Applicant: Lenovo Mobile Communication Technology Ltd.

Address: No.999, Qishan North 2nd Road, Information & Optoelectronics Park, Torch Hi-tech Industry Development Zone, Xiamen, P.R. China

Issued By: Bureau Veritas Consumer Products Services (H.K.) Ltd., Taoyuan Branch

Lab Address: No. 47-2, 14th Ling, Chia Cau Vil., Lin Kou Dist., New Taipei City, Taiwan (R.O.C.)

Test Location: No. 19, Hwa Ya 2nd Rd., Wen Hwa Tsuen, Kwei Shan Hsiang, Taoyuan Hsien 333, Taiwan, R.O.C.

This report should not be used by the client to claim product certification, approval, or endorsement by TAF or any government agencies.



This report is for your exclusive use. Any copying or replication of this report to or for any other person or entity, or use of our name or trademark, is permitted only with our prior written permission. This report sets forth our findings solely with respect to the test samples identified herein. The results set forth in this report are not indicative or representative of the quality or characteristics of the lot from which a test sample was taken or any similar or identical product specifically and expressly noted. Our report includes all of the tests requested by you and the results thereof based upon the information that you provided to us. You have 60 days from date of issuance of this report to notify us of any material error or omission caused by our negligence, provided, however, that such notice shall be in writing and shall specifically address the issue you wish to raise. A failure to raise such issue within the prescribed time shall constitute your unqualified acceptance of the completeness of this report, the tests conducted and the correctness of the report contents. Unless specific mention, the uncertainty of measurement has been explicitly taken into account to declare the compliance or non-compliance to the specification. The report must not be used by the client to claim product certification, approval, or endorsement by TAF or any government agencies.

TABLE OF CONTENTS

| | |
|---|-----------|
| RELEASE CONTROL RECORD | 3 |
| 1 Certificate of Conformity..... | 4 |
| 2 Summary of Test Results | 5 |
| 2.1 Measurement Uncertainty | 5 |
| 2.2 Test Site And Instruments | 5 |
| 3 General Information..... | 7 |
| 3.1 General Description of EUT | 7 |
| 3.2 Configuration Of System Under Test..... | 9 |
| 3.2.1 Description Of Support Units | 10 |
| 3.3 Test Mode Applicability and Tested Channel Detail | 10 |
| 3.4 EUT Operating Conditions | 13 |
| 3.5 General Description of Applied Standards | 13 |
| 4 Test Types and Results | 14 |
| 4.1 Output Power Measurement | 14 |
| 4.1.1 Limits of Output Power Measurement..... | 14 |
| 4.1.2 Test Procedures..... | 14 |
| 4.1.3 Test Setup..... | 15 |
| 4.1.4 Test Results | 16 |
| 4.2 Frequency Stability Measurement..... | 25 |
| 4.2.1 Limits of Frequency Stability Measurement..... | 25 |
| 4.2.2 Test Procedure | 25 |
| 4.2.3 Test Setup..... | 25 |
| 4.2.4 Test Results | 26 |
| 4.3 Occupied Bandwidth Measurement | 28 |
| 4.3.1 Test Procedure | 28 |
| 4.3.2 Test Setup..... | 28 |
| 4.3.3 Test Result..... | 29 |
| 4.4 Band Edge Measurement | 37 |
| 4.4.1 Limits of Band Edge Measurement | 37 |
| 4.4.2 Test Setup..... | 37 |
| 4.4.3 Test Procedures..... | 37 |
| 4.4.4 Test Results | 38 |
| 4.5 Peak To Average Ratio..... | 45 |
| 4.5.1 Limits of Peak To Average Ratio Measurement | 45 |
| 4.5.2 Test Setup..... | 45 |
| 4.5.3 Test Procedures..... | 45 |
| 4.5.4 Test Results | 46 |
| 4.6 Conducted Spurious Emissions | 50 |
| 4.6.1 Limits of Conducted Spurious Emissions Measurement..... | 50 |
| 4.6.2 Test Setup..... | 50 |
| 4.6.3 Test Procedure | 50 |
| 4.6.4 Test Results | 51 |
| 4.7 Radiated Emission Measurement | 55 |
| 4.7.1 Limits of Radiated Emission Measurement..... | 55 |
| 4.7.2 Test Procedure | 55 |
| 4.7.3 Deviation from Test Standard | 55 |
| 4.7.4 Test Setup..... | 56 |
| 4.7.5 Test Results | 57 |
| 5 Pictures of Test Arrangements..... | 57 |
| Appendix – Information on the Testing Laboratories | 78 |



RELEASE CONTROL RECORD

| Issue No. | Description | Date Issued |
|----------------|------------------|---------------|
| RF150915W002-4 | Original release | Oct. 13, 2015 |

1 Certificate of Conformity

Product: Lenovo Mobile Phone
Brand: Lenovo
Test Model: Lenovo A2010I36
Sample Status: Production unit
Applicant: Lenovo Mobile Communication Technology Ltd.
Test Date: Sep. 16, 2015 ~ Oct. 12, 2015
Standards: FCC Part 24, Subpart E

The above equipment has been tested by **Bureau Veritas Consumer Products Services (H.K.) Ltd., Taoyuan Branch**, and found compliance with the requirement of the above standards. The test record, data evaluation & Equipment Under Test (EUT) configurations represented herein are true and accurate accounts of the measurements of the sample's EMC characteristics under the conditions specified in this report.

Prepared by : , **Date:** Oct. 13, 2015
Amyee Qian / Engineer

Approved by : , **Date:** Oct. 13, 2015
William Chung / Manager

2 Summary of Test Results

| Applied Standard: FCC Part 24 & Part 2 | | | |
|--|------------------------------|--------|---|
| FCC Clause | Test Item | Result | Remarks |
| 2.1046 24.232 | Effective Radiated Power | PASS | Meet the requirement of limit. |
| 2.1046 24.232(d) | Peak To Average Ratio | PASS | Meet the requirement of limit. |
| 2.1055 24.235 | Frequency Stability | PASS | Meet the requirement of limit. |
| 2.1049 24.238(b) | Occupied Bandwidth | PASS | Meet the requirement of limit. |
| 24.238(b) | Band Edge Measurements | PASS | Meet the requirement of limit. |
| 2.1051 24.238 | Conducted Spurious Emissions | PASS | Meet the requirement of limit. |
| 2.1053 24.238 | Radiated Spurious Emissions | PASS | Meet the requirement of limit. Minimum passing margin is -28.174dB at 43.58MHz. |

2.1 Measurement Uncertainty

Where relevant, the following measurement uncertainty levels have been estimated for tests performed on the EUT as specified in CISPR 16-4-2:

| Measurement | Frequency | Expanded Uncertainty (k=2) (\pm) |
|------------------------------------|------------------|--------------------------------------|
| Conducted Emissions at mains ports | 150kHz ~ 30MHz | 2.44 dB |
| Radiated Emissions up to 1 GHz | 30MHz ~ 200MHz | 2.93 dB |
| | 200MHz ~ 1000MHz | 2.95 dB |
| Radiated Emissions above 1 GHz | 1GHz ~ 18GHz | 2.26 dB |
| | 18GHz ~ 40GHz | 1.94 dB |

This uncertainty represents an expanded uncertainty expressed at approximately the 95% confidence level using a coverage factor of k=2.

2.2 Test Site And Instruments

| Description & Manufacturer | Model No. | Serial No. | Date Of Calibration | Due Date Of Calibration |
|--|----------------|---|---------------------|-------------------------|
| Spectrum Analyzer Agilent Technologies | N9038A | MY52260177 | May 19, 2015 | May 18, 2016 |
| Spectrum Analyzer ROHDE & SCHWARZ | FSU43 | 101261 | Dec. 10, 2014 | Dec. 09, 2015 |
| BILOG Antenna ETS-Lindgren | 3142E | 117536 | Feb. 23, 2015 | Feb. 22, 2016 |
| HORN Antenna ETS-Lindgren | 3117 | 00143293 | Aug. 27, 2015 | Aug. 26, 2016 |
| Bluetooth Tester | CBT | 100980 | Apr. 27, 2015 | Apr. 26, 2016 |
| Agilent Communications Tester-Wireless | 8960 Series 10 | MY53201073 | Jul. 06, 2015 | Jul. 05, 2017 |
| Preamplifier Agilent | 310N | 187226 | Jun. 29, 2015 | Jun. 28, 2016 |
| Preamplifier Agilent | 83017A | 980116 | Jan. 09, 2015 | Jan. 08, 2016 |
| Power Meter Anritsu | ML2495A | 1232002 | Sep. 16, 2015 | Sep. 15, 2016 |
| Power Sensor Anritsu | MA2411B | 1207325 | Sep. 16, 2015 | Sep. 15, 2016 |
| RF signal cable ETS-LINDGREN | 5D-FB | Cable-CH1-01(RFC-S MS-100-SMS-120+RF C-SMS-100-SMS-400) | Jun. 27, 2015 | Jun. 26, 2016 |
| RF signal cable ETS-LINDGREN | 8D-FB | Cable-CH1-02(RFC-S MS-100-SMS-24) | Jun. 27, 2015 | Jun. 26, 2016 |
| Software BV ADT | E38.130425b | NA | NA | NA |
| Antenna Tower MF | NA | NA | NA | NA |
| Turn Table MF | NA | NA | NA | NA |
| Antenna Tower & Turn Table Controller MF | MF-7802 | NA | NA | NA |

NOTE: 1. The calibration interval of the above test instruments is 12 months and the calibrations are traceable to NML/ROC and NIST/USA.

2. The calibration interval of the loop antenna is 24 months and the calibrations are traceable to NML/ROC and NIST/USA.

3. The test was performed in HwaYa Chamber 4.

4. The horn antenna and HP preamplifier (model: 8449B) are used only for the measurement of emission frequency above 1GHz if tested.

5. The FCC Site Registration No. is 460141.

6. The IC Site Registration No. is IC7450F-4.

3 General Information

3.1 General Description of EUT

| | | |
|----------------------------|--|-----------------------|
| PRODUCT | Lenovo Mobile Phone | |
| BRAND | Lenovo | |
| MODEL NAME | Lenovo A2010I36 | |
| POWER SUPPLY | 5.0Vdc (adapter or host equipment) 3.8Vdc (battery) | |
| MODULATION TYPE | GSM, GPRS: GMSK EDGE: GMSK, 8PSK WCDMA : BPSK LTE Band 2: QPSK, 16QAM | |
| FREQUENCY RANGE | GSM, GPRS, EDGE: 1850.2MHz ~ 1909.8MHz | |
| | WCDMA: 1852.4MHz ~ 1907.6MHz | |
| | LTE Band 2 Channel Bandwidth: 1.4MHz | 1850.7MHz ~ 1909.3MHz |
| | LTE Band 2 Channel Bandwidth: 3MHz | 1851.5MHz ~ 1908.5MHz |
| | LTE Band 2 Channel Bandwidth: 5MHz | 1852.5MHz ~ 1907.5MHz |
| | LTE Band 2 Channel Bandwidth: 10MHz | 1855.0MHz ~ 1905.0MHz |
| | LTE Band 2 Channel Bandwidth: 15MHz | 1857.5MHz ~ 1902.5MHz |
| | LTE Band 2 Channel Bandwidth: 20MHz | 1860.0MHz ~ 1900.0MHz |
| MAX. EIRP POWER | GSM: 608mW | |
| | EDGE: 476mW | |
| | WCDMA: 278mW | |
| | LTE Band 2 Channel Bandwidth: 1.4MHz | 288mW |
| | LTE Band 2 Channel Bandwidth: 3MHz | 310mW |
| | LTE Band 2 Channel Bandwidth: 5MHz | 295mW |
| | LTE Band 2 Channel Bandwidth: 10MHz | 301mW |
| | LTE Band 2 Channel Bandwidth: 15MHz | 327mW |
| EMISSION DESIGNATOR | GSM | 247KGXW |
| | EDGE | 247KG7W |

| | | |
|-------------------------|---|---------|
| | WCDMA | 4M20F9W |
| | LTE Band 2 Channel Bandwidth: 1.4MHz | 1M08G7D |
| | LTE Band 2 Channel Bandwidth: 3MHz | 2M69W7D |
| | LTE Band 2 Channel Bandwidth: 5MHz | 4M49G7D |
| | LTE Band 2 Channel Bandwidth: 10MHz | 8M93W7D |
| | LTE Band 2 Channel Bandwidth: 15MHz | 13M4G7D |
| | LTE Band 2 Channel Bandwidth: 20MHz | 17M9W7D |
| ANTENNA TYPE | Fixed Internal antenna with -0.36dBi gain | |
| HW VERSION | AL713_MB_PCB_V1.0 | |
| SW VERSION | A2010I36_USR_S203_1508251800_MP3V1_8G_TELEFONICA | |
| ACCESSORY DEVICE | Refer to note as below | |
| DATA CABLE | USB cable: Unshielded, detachable, 0.7m Earphone cable: Unshielded, detachable, 1.3m | |

Note:

1. The above EUT information is declared by manufacturer and for more detailed features description, please refer to the manufacturer's specifications or User's Manual.
2. The EUT was powered by the following adapter:

| ADAPTER | |
|----------------------|--------------------|
| BRAND: | Lenovo |
| MODEL: | C-P56 |
| INPUT: | AC 100-240V, 0.13A |
| OUTPUT: | DC 5V, 1.0A |
| MANUFACTURER: | chenyang |

3. The EUT matched the following USB Cable and Earphone.

| USB CABLE | |
|---------------------|----------------|
| BRAND: | lenovo |
| MODEL: | L16W-05100070L |
| SIGNAL LINE: | 0.7 METER |

| EARPHONE | |
|---------------------|------------------|
| BRAND: | Lenovo |
| MODEL: | TS990B-28AMS05-M |
| SIGNAL LINE: | 1.3 METER |

4. For the test results, the EUT had been tested with all conditions. But only the worst case was shown in test report.

3.2 Configuration Of System Under Test

FOR RADIATION EMISSION TEST

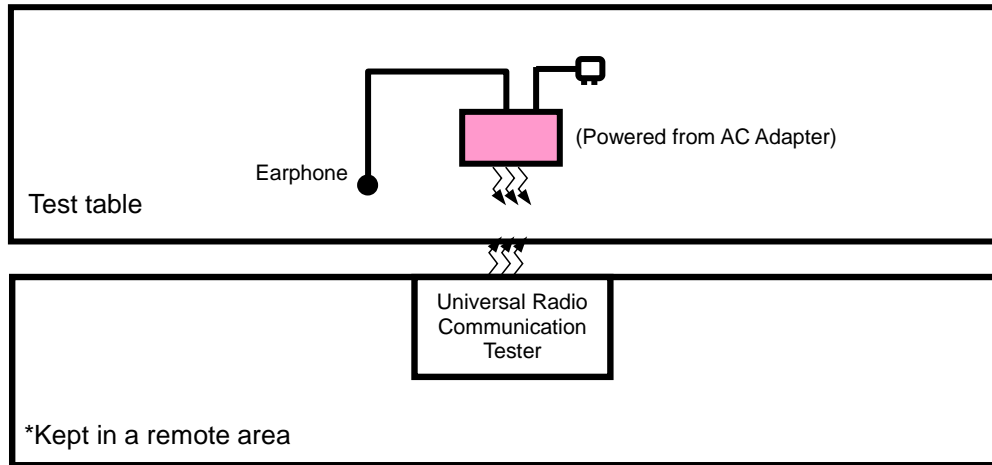

FOR E.R.P. TEST

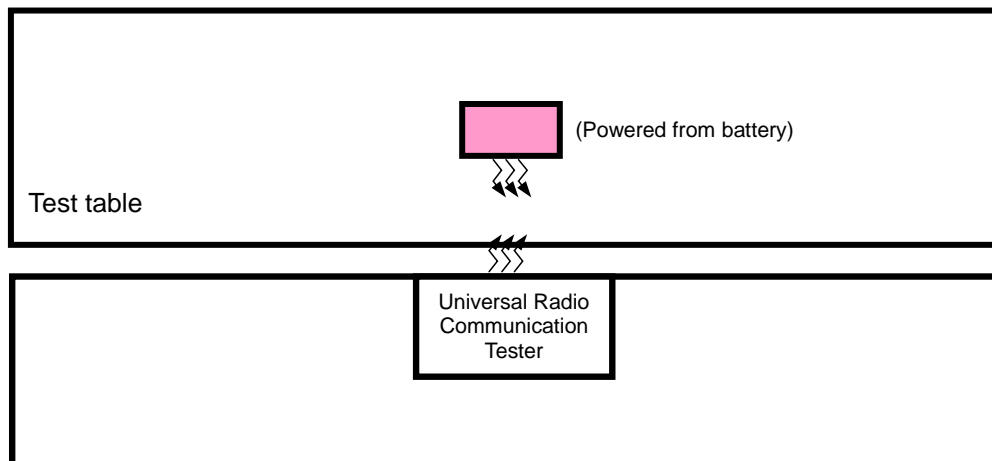

3.2.1 Description Of Support Units

The EUT has been tested as an independent unit together with other necessary accessories or support units. The following support units or accessories were used to form a representative test configuration during the tests.

| NO. | PRODUCT | BRAND | MODEL NO. | SERIAL NO. | FCC ID |
|-----|-----------|----------|-----------|------------|--------|
| 1 | DC source | LONG WEI | PS-6403D | 010934269 | N/A |
| 2 | PC | HP | A6608CN | 3CR83825X3 | N/A |

| NO. | SIGNAL CABLE DESCRIPTION OF THE ABOVE SUPPORT UNITS |
|-----|---|
| 1 | DC Line: Unshielded, Detachable 1.0m |
| 2 | AC Line: Unshielded, Detachable 1.5m |

NOTE:

1. All power cords of the above support units are non shielded (1.8m).

3.3 Test Mode Applicability and Tested Channel Detail

Pre-Scan has been conducted to determine the worst-case mode from all possible combinations between available modulations, data rates, XYZ axis and antenna ports
The worst case was found when positioned on Z-plane. Following channel(s) was (were) selected for the final test as listed below:

Test results are presented in the report as below.

| Test Mode | Test Condition |
|-----------|--------------------|
| A | Power from adapter |
| B | Power from battery |

GSM MODE

| EUT Configure Mode | Test Item | Available Channel | Tested Channel | Mode |
|--------------------|------------------------------|-------------------|----------------|-----------|
| A | EIRP | 512 to 810 | 512, 661, 810 | GSM |
| B | Frequency Stability | 512 to 810 | 661 | GSM |
| A | Occupied Bandwidth | 512 to 810 | 512, 661, 810 | GSM, EDGE |
| A | Band Edge | 512 to 810 | 512, 810 | GSM, EDGE |
| A | Peak To Average Ratio | 512 to 810 | 512, 661, 810 | GSM, EDGE |
| A | Condcudeted Emission | 512 to 810 | 512, 661, 810 | GSM, EDGE |
| A | Radiated Emission Below 1GHz | 512 to 810 | 512 | GSM |
| A | Radiated Emission Above 1GHz | 512 to 810 | 512, 661, 810 | GSM |

WCDMA MODE

| EUT Configure Mode | Test Item | Available Channel | Tested Channel | Mode |
|--------------------|------------------------------|-------------------|------------------|-------|
| A | EIRP | 9262 to 9538 | 9262, 9400, 9538 | WCDMA |
| B | Frequency Stability | 9262 to 9538 | 9400 | WCDMA |
| A | Occupied Bandwidth | 9262 to 9538 | 9262, 9400, 9538 | WCDMA |
| A | Band Edge | 9262 to 9538 | 9262, 9538 | WCDMA |
| A | Peak To Average Ratio | 9262 to 9538 | 9262, 9400, 9538 | WCDMA |
| A | Condcudeted Emission | 9262 to 9538 | 9262, 9400, 9538 | WCDMA |
| A | Radiated Emission Below 1GHz | 9262 to 9538 | 9262 | WCDMA |
| A | Radiated Emission Above 1GHz | 9262 to 9538 | 9262, 9400, 9538 | WCDMA |

LTE BAND 2

| EUT CONFIGURE MODE | TEST ITEM | AVAILABLE CHANNEL | TESTED CHANNEL | CHANNEL BANDWIDTH | MODULATION | MODE |
|--------------------|-----------------------|-------------------|---------------------|-------------------|-------------|----------------------|
| B | EIRP | 18607 to 19193 | 18607, 18900, 19193 | 1.4MHz | QPSK, 16QAM | 1 RB / 0 RB Offset |
| | | 18615 to 19185 | 18615, 18900, 19185 | 3MHz | QPSK, 16QAM | 1 RB / 0 RB Offset |
| | | 18625 to 19175 | 18625, 18900, 19175 | 5MHz | QPSK, 16QAM | 1 RB / 0 RB Offset |
| | | 18650 to 19150 | 18650, 18900, 19150 | 10MHz | QPSK, 16QAM | 1 RB / 0 RB Offset |
| | | 18675 to 19125 | 18675, 18900, 19125 | 15MHz | QPSK, 16QAM | 1 RB / 0 RB Offset |
| | | 18700 to 19100 | 18700, 18900, 19100 | 20MHz | QPSK, 16QAM | 1 RB / 0 RB Offset |
| B | FREQUENCY STABILITY | 18607 to 19193 | 18900 | 1.4MHz | QPSK | 1 RB / 0 RB Offset |
| | | 18615 to 19185 | 18900 | 3MHz | QPSK | 1 RB / 0 RB Offset |
| | | 18625 to 19175 | 18900 | 5MHz | QPSK | 1 RB / 0 RB Offset |
| | | 18650 to 19150 | 18900 | 10MHz | QPSK | 1 RB / 0 RB Offset |
| | | 18675 to 19125 | 18900 | 15MHz | QPSK | 1 RB / 0 RB Offset |
| | | 18700 to 19100 | 18900 | 20MHz | QPSK | 1 RB / 0 RB Offset |
| B | OCCUPIED BANDWIDTH | 18607 to 19193 | 18607, 18900, 19193 | 1.4MHz | QPSK, 16QAM | 6 RB / 0 RB Offset |
| | | 18615 to 19185 | 18615, 18900, 19185 | 3MHz | QPSK, 16QAM | 15 RB / 0 RB Offset |
| | | 18625 to 19175 | 18625, 18900, 19175 | 5MHz | QPSK, 16QAM | 25 RB / 0 RB Offset |
| | | 18650 to 19150 | 18650, 18900, 19150 | 10MHz | QPSK, 16QAM | 50 RB / 0 RB Offset |
| | | 18675 to 19125 | 18675, 18900, 19125 | 15MHz | QPSK, 16QAM | 75 RB / 0 RB Offset |
| | | 18700 to 19100 | 18700, 18900, 19100 | 20MHz | QPSK, 16QAM | 100 RB / 0 RB Offset |
| B | PEAK TO AVERAGE RATIO | 18607 to 19193 | 18607, 18900, 19193 | 1.4MHz | QPSK, 16QAM | 1 RB / 0 RB Offset |
| | | 18615 to 19185 | 18615, 18900, 19185 | 3MHz | QPSK, 16QAM | 1 RB / 0 RB Offset |
| | | 18625 to 19175 | 18625, 18900, 19175 | 5MHz | QPSK, 16QAM | 1 RB / 0 RB Offset |
| | | 18650 to 19150 | 18650, 18900, 19150 | 10MHz | QPSK, 16QAM | 1 RB / 0 RB Offset |
| | | 18675 to 19125 | 18675, 18900, 19125 | 15MHz | QPSK, 16QAM | 1 RB / 0 RB Offset |
| | | 18700 to 19100 | 18700, 18900, 19100 | 20MHz | QPSK, 16QAM | 1 RB / 0 RB Offset |

| | | | | | | | | |
|----------------|-------------------|----------------|--------------------|----------------|-------|---------------------|------|--------------------|
| B | BAND EDGE | 18607 to 19193 | 18607 | 1.4MHz | QPSK | 1 RB / 0 RB Offset | | |
| | | | 19193 | 1.4MHz | QPSK | 6 RB / 0 RB Offset | | |
| | | 18615 to 19185 | 18615 | 3MHz | QPSK | 1 RB / 5 RB Offset | | |
| | | | 19185 | 3MHz | QPSK | 6 RB / 0 RB Offset | | |
| | | 18625 to 19175 | 18625 | 5MHz | QPSK | 1 RB / 0 RB Offset | | |
| | | | 19175 | 5MHz | QPSK | 15 RB / 0 RB Offset | | |
| | | 18650 to 19150 | 18650 | 10MHz | QPSK | 1 RB / 14 RB Offset | | |
| | | | 19150 | 10MHz | QPSK | 15 RB / 0 RB Offset | | |
| | | 18675 to 19125 | 18675 | 15MHz | QPSK | 1 RB / 0 RB Offset | | |
| | | | 19125 | 15MHz | QPSK | 25 RB / 0 RB Offset | | |
| | | 18700 to 19100 | 18700 | 20MHz | QPSK | 1 RB / 24 RB Offset | | |
| | | | 19100 | 20MHz | QPSK | 25 RB / 0 RB Offset | | |
| | | B | CONDCUDED EMISSION | 18607 to 19193 | 18900 | 1.4MHz | QPSK | 1 RB / 0 RB Offset |
| | | | | 18615 to 19185 | 18900 | 3MHz | QPSK | 1 RB / 0 RB Offset |
| | | | | 18625 to 19175 | 18900 | 5MHz | QPSK | 1 RB / 0 RB Offset |
| | | | | 18650 to 19150 | 18900 | 10MHz | QPSK | 1 RB / 0 RB Offset |
| 18675 to 19125 | 18900 | | | 15MHz | QPSK | 1 RB / 0 RB Offset | | |
| 18700 to 19100 | 18900 | | | 20MHz | QPSK | 1 RB / 0 RB Offset | | |
| A | RADIATED EMISSION | 18607 to 19193 | 18900 | 1.4MHz | QPSK | 1 RB / 0 RB Offset | | |
| | | 18615 to 19185 | 18900 | 3MHz | QPSK | 1 RB / 0 RB Offset | | |
| | | 18625 to 19175 | 18900 | 5MHz | QPSK | 1 RB / 0 RB Offset | | |
| | | 18650 to 19150 | 18900 | 10MHz | QPSK | 1 RB / 0 RB Offset | | |
| | | 18675 to 19125 | 18900 | 15MHz | QPSK | 1 RB / 0 RB Offset | | |
| | | 18700 to 19100 | 18900 | 20MHz | QPSK | 1 RB / 0 RB Offset | | |

Test Condition:

| Test Item | Environmental Conditions | Input Power | Tested By |
|-----------------------|------------------------------------|--------------|------------|
| EIRP | 21deg. C, 71%RH 22deg. C, 71%RH | 120Vac, 60Hz | Nick Hsu |
| Frequency Stability | 24deg. C, 64%RH | 3.8Vdc | Match Tsui |
| Occupied Bandwidth | 24deg. C, 64%RH | 120Vac, 60Hz | Match Tsui |
| Band Edge | 24deg. C, 64%RH | 120Vac, 60Hz | Match Tsui |
| Peak To Average Ratio | 24deg. C, 64%RH | 120Vac, 60Hz | Match Tsui |
| Condcudeted Emission | 24deg. C, 64%RH | 120Vac, 60Hz | Match Tsui |
| Radiated Emission | 21deg. C, 71%RH | 120Vac, 60Hz | Nick Hsu |

3.4 EUT Operating Conditions

The EUT makes a call to the communication simulator. The communication simulator station system controlled a EUT to export maximum output power under transmission mode and specific channel frequency

3.5 General Description of Applied Standards

The EUT is a RF Product. According to the specifications of the manufacturer, it must comply with the requirements of the following standards:

FCC 47 CFR Part 2

FCC 47 CFR Part 24

ANSI/TIA/EIA-603-C 2004

NOTE: All test items have been performed and recorded as per the above standards.

4 Test Types and Results

4.1 Output Power Measurement

4.1.1 Limits of Output Power Measurement

Mobile / Portable station are limited to 2 watts e.i.r.p.

4.1.2 Test Procedures

EIRP / ERP Measurement:

- a. All measurements were done at low, middle and high operational frequency range. RBW and VBW is 1MHz for GSM, GPRS and 5MHz for WCDMA mode.
- b. Substitution method is used for E.I.R.P measurement. In the semi-anechoic chamber, EUT placed on the 0.8m height of Turn Table, rotated the table around 360 degrees to search the maximum radiation power and receiver antenna shall be rotated vertical and horizontal polarization and moved height from 1m to 4m to find the maximum polar radiated power. The "Read Value" is the spectrum reading the maximum power value.
- c. The substitution horn antenna is substituted for EUT at the same position and signals generator export the CW signal to the substitution antenna via a tx cable. Rotated the Turn Table and moved receiving antenna to find the maximum radiation power. Adjust output power level of S.G to get a Value of spectrum reading equal to "Read Value" of step b. Record the power level of S.G
- d. $EIRP = \text{Output power level of S.G} - \text{TX cable loss} + \text{Antenna gain of substitution horn.}$

Conducted Power Measurement:

The EUT was set up for the maximum power with GSM, GPRS & WCDMA link data modulation and link up with simulator. Set the EUT to transmit under low, middle and high channel and record the power level shown on simulator.

4.1.3 Test Setup

EIRP / ERP MEASUREMENT:

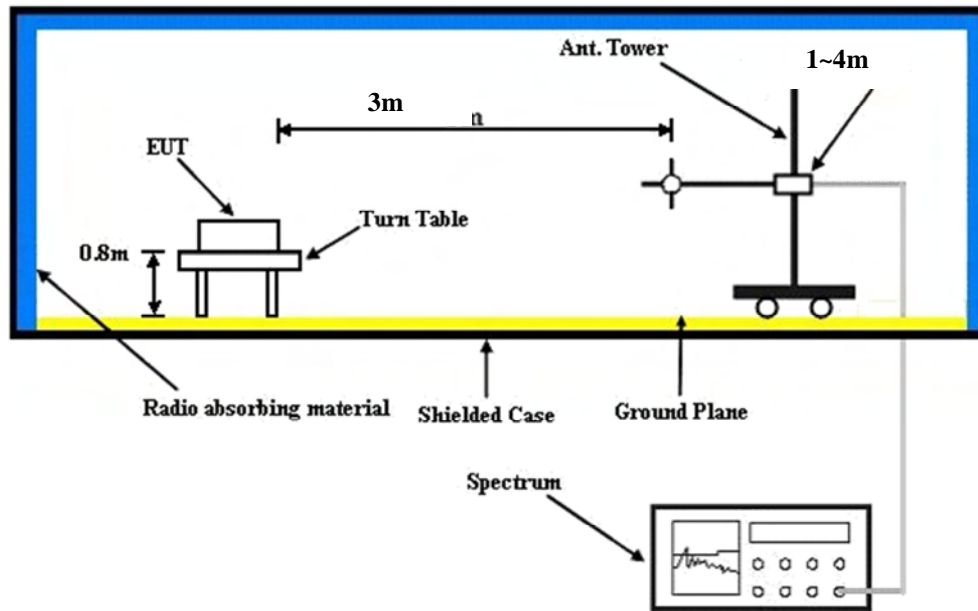

For the actual test configuration, please refer to the attached file (Test Setup Photo).

CONDUCTED POWER MEASUREMENT:

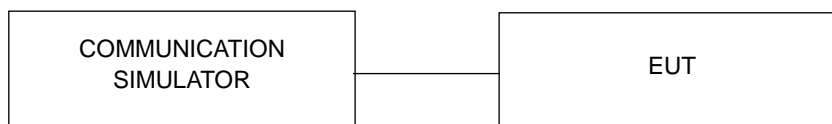

For the actual test configuration, please refer to the attached file (Test Setup Photo).

4.1.4 Test Results

CONDUCTED OUTPUT POWER (dBm)

| Band | GSM1900 | | |
|-----------------------|--------------|--------|--------|
| Channel | 512 | 661 | 810 |
| Frequency (MHz) | 1850.2 | 1880.0 | 1909.8 |
| GSM | 29.33 | 29.22 | 29.19 |
| GPRS 8 | 29.30 | 29.14 | 29.13 |
| GPRS 10 | 28.59 | 28.45 | 28.46 |
| GPRS 11 | 26.81 | 26.70 | 26.73 |
| GPRS 12 | 25.75 | 25.63 | 25.66 |
| EDGE 8 (MCS9) | 25.61 | 25.43 | 25.26 |
| EDGE 10 (MCS9) | 24.35 | 24.20 | 24.28 |
| EDGE 11 (MCS9) | 22.40 | 22.24 | 22.10 |
| EDGE 12 (MCS9) | 21.32 | 21.16 | 21.04 |

| Band | WCDMA II | | |
|------------------------|----------|--------|--------------|
| Channel | 9262 | 9400 | 9538 |
| Frequency (MHz) | 1852.4 | 1880.0 | 1907.6 |
| RMC 12.2K | 22.13 | 22.10 | 22.15 |
| HSPA | | | |
| HSDPA Subtest-1 | 20.22 | 20.12 | 20.21 |
| HSDPA Subtest-2 | 20.19 | 20.06 | 20.23 |
| HSDPA Subtest-3 | 19.70 | 19.58 | 19.74 |
| HSDPA Subtest-4 | 19.70 | 19.57 | 19.74 |
| HSUPA Subtest-1 | 19.76 | 19.73 | 19.75 |
| HSUPA Subtest-2 | 19.18 | 19.02 | 19.18 |
| HSUPA Subtest-3 | 20.19 | 20.04 | 20.18 |
| HSUPA Subtest-4 | 18.69 | 18.67 | 18.70 |
| HSUPA Subtest-5 | 21.14 | 20.84 | 21.14 |

| LTE Band 2 | | | | | | | |
|------------|------------|---------|-----------|-------------------------|-----------------------|-------------------------|---------------------|
| BW | Modulation | RB Size | RB Offset | Low CH 18607 | Mid CH 18900 | High CH 19193 | 3GPP MPR (dB) |
| | | | | Frequency 1850.7 MHz | Frequency 1880 MHz | Frequency 1909.3 MHz | |
| 1.4MHz | QPSK | 1 | 0 | 22.93 | 22.88 | 22.92 | 0 |
| | | 1 | 2 | 22.87 | 22.82 | 22.88 | 0 |
| | | 1 | 5 | 22.76 | 22.71 | 22.82 | 0 |
| | | 3 | 0 | 22.92 | 22.87 | 22.91 | 0 |
| | | 3 | 1 | 22.86 | 22.81 | 22.87 | 0 |
| | | 3 | 3 | 22.75 | 22.70 | 22.81 | 0 |
| | | 6 | 0 | 21.96 | 21.93 | 21.95 | 1 |
| | 16QAM | 1 | 0 | 22.22 | 22.04 | 22.10 | 1 |
| | | 1 | 2 | 22.05 | 22.14 | 22.02 | 1 |
| | | 1 | 5 | 21.93 | 21.98 | 21.88 | 1 |
| | | 3 | 0 | 22.20 | 22.02 | 22.08 | 1 |
| | | 3 | 1 | 22.03 | 22.12 | 22.00 | 1 |
| | | 3 | 3 | 21.91 | 21.96 | 21.86 | 1 |
| | | 6 | 0 | 20.90 | 20.95 | 21.03 | 2 |
| LTE Band 2 | | | | | | | |
| BW | Modulation | RB Size | RB Offset | Low CH 18615 | Mid CH 18900 | High CH 19185 | 3GPP MPR (dB) |
| | | | | Frequency 1851.5 MHz | Frequency 1880 MHz | Frequency 1908.5 MHz | |
| 3 MHz | QPSK | 1 | 0 | 22.96 | 22.91 | 22.95 | 0 |
| | | 1 | 7 | 22.90 | 22.85 | 22.91 | 0 |
| | | 1 | 14 | 22.79 | 22.74 | 22.85 | 0 |
| | | 8 | 0 | 22.07 | 22.04 | 22.03 | 1 |
| | | 8 | 3 | 21.92 | 21.92 | 22.00 | 1 |
| | | 8 | 7 | 21.96 | 21.90 | 21.98 | 1 |
| | | 15 | 0 | 21.99 | 21.96 | 21.98 | 1 |
| | 16QAM | 1 | 0 | 22.25 | 22.07 | 22.13 | 1 |
| | | 1 | 7 | 22.08 | 22.17 | 22.05 | 1 |
| | | 1 | 14 | 21.96 | 22.01 | 21.91 | 1 |
| | | 8 | 0 | 21.04 | 21.09 | 21.08 | 2 |
| | | 8 | 3 | 20.99 | 21.06 | 21.05 | 2 |
| | | 8 | 7 | 20.99 | 21.00 | 21.01 | 2 |

| | | 15 | 0 | 20.93 | 20.98 | 21.06 | 2 |
|-------------------|------------|---------|-----------|-------------------------|-----------------------|-------------------------|---------------------|
| BW | Modulation | RB Size | RB Offset | Low CH 18625 | Mid CH 18900 | High CH 19175 | 3GPP MPR (dB) |
| | | | | Frequency 1852.5 MHz | Frequency 1880 MHz | Frequency 1907.5 MHz | |
| 5 MHz | QPSK | 1 | 0 | 22.99 | 22.94 | 22.98 | 0 |
| | | 1 | 12 | 22.93 | 22.88 | 22.94 | 0 |
| | | 1 | 24 | 22.82 | 22.77 | 22.88 | 0 |
| | | 12 | 0 | 22.10 | 22.07 | 22.06 | 1 |
| | | 12 | 6 | 21.95 | 21.95 | 22.03 | 1 |
| | | 12 | 13 | 21.99 | 21.93 | 22.01 | 1 |
| | | 25 | 0 | 22.02 | 21.99 | 22.01 | 1 |
| | 16QAM | 1 | 0 | 22.28 | 22.10 | 22.16 | 1 |
| | | 1 | 12 | 22.11 | 22.20 | 22.08 | 1 |
| | | 1 | 24 | 21.99 | 22.04 | 21.94 | 1 |
| | | 12 | 0 | 21.07 | 21.12 | 21.11 | 2 |
| | | 12 | 6 | 21.02 | 21.09 | 21.08 | 2 |
| | | 12 | 13 | 21.02 | 21.03 | 21.04 | 2 |
| | | 25 | 0 | 20.96 | 21.01 | 21.09 | 2 |
| LTE Band 2 | | | | | | | |
| BW | Modulation | RB Size | RB Offset | Low CH 18650 | Mid CH 18900 | High CH 19150 | 3GPP MPR (dB) |
| | | | | Frequency 1855 MHz | Frequency 1880 MHz | Frequency 1905 MHz | |
| 10 MHz | QPSK | 1 | 0 | 23.01 | 22.96 | 23.00 | 0 |
| | | 1 | 24 | 22.95 | 22.90 | 22.96 | 0 |
| | | 1 | 49 | 22.84 | 22.79 | 22.90 | 0 |
| | | 25 | 0 | 22.12 | 22.09 | 22.08 | 1 |
| | | 25 | 12 | 21.97 | 21.97 | 22.05 | 1 |
| | | 25 | 25 | 22.01 | 21.95 | 22.03 | 1 |
| | | 50 | 0 | 22.04 | 22.01 | 22.03 | 1 |
| | 16QAM | 1 | 0 | 22.30 | 22.12 | 22.18 | 1 |
| | | 1 | 24 | 22.13 | 22.22 | 22.10 | 1 |
| | | 1 | 49 | 22.01 | 22.06 | 21.96 | 1 |
| | | 25 | 0 | 21.09 | 21.14 | 21.13 | 2 |
| | | 25 | 12 | 21.04 | 21.11 | 21.10 | 2 |
| | | 25 | 25 | 21.04 | 21.05 | 21.06 | 2 |
| | | 50 | 0 | 20.98 | 21.03 | 21.11 | 2 |
| BW | Modulation | RB Size | RB Offset | Low CH 18675 | Mid CH 18900 | High CH 19125 | 3GPP MPR (dB) |
| | | | | Frequency 1857.5 MHz | Frequency 1880 MHz | Frequency 1902.5 MHz | |

| 15 MHz | QPSK | 1 | 0 | 23.04 | 22.99 | 23.03 | 0 |
|-------------------|------------|---------|-----------|--------------|-----------|-----------|---------------|
| | | 1 | 37 | 22.98 | 22.93 | 22.99 | 0 |
| | | 1 | 74 | 22.87 | 22.82 | 22.93 | 0 |
| | | 36 | 0 | 22.15 | 22.12 | 22.11 | 1 |
| | | 36 | 19 | 22.00 | 22.00 | 22.08 | 1 |
| | | 36 | 39 | 22.04 | 21.98 | 22.06 | 1 |
| | | 75 | 0 | 22.07 | 22.04 | 22.06 | 1 |
| | 16QAM | 1 | 0 | 22.33 | 22.15 | 22.21 | 1 |
| | | 1 | 37 | 22.16 | 22.25 | 22.13 | 1 |
| | | 1 | 74 | 22.04 | 22.09 | 21.99 | 1 |
| | | 36 | 0 | 21.12 | 21.17 | 21.16 | 2 |
| | | 36 | 19 | 21.07 | 21.14 | 21.13 | 2 |
| | | 36 | 39 | 21.07 | 21.08 | 21.09 | 2 |
| 75 | | 0 | 21.01 | 21.06 | 21.14 | 2 | |
| LTE Band 2 | | | | | | | |
| BW | Modulation | RB Size | RB Offset | Low CH | Mid CH | High CH | 3GPP MPR (dB) |
| | | | | 18700 | 18900 | 19100 | |
| | | | | Frequency | Frequency | Frequency | |
| | | | | 1860 MHz | 1880 MHz | 1900 MHz | |
| 20MHz | QPSK | 1 | 0 | 23.09 | 23.04 | 23.08 | 0 |
| | | 1 | 50 | 23.03 | 22.98 | 23.04 | 0 |
| | | 1 | 99 | 22.92 | 22.87 | 22.98 | 0 |
| | | 50 | 0 | 22.20 | 22.17 | 22.16 | 1 |
| | | 50 | 25 | 22.05 | 22.05 | 22.13 | 1 |
| | | 50 | 50 | 22.09 | 22.03 | 22.11 | 1 |
| | | 100 | 0 | 22.12 | 22.09 | 22.11 | 1 |
| | 16QAM | 1 | 0 | 22.38 | 22.20 | 22.26 | 1 |
| | | 1 | 50 | 22.21 | 22.30 | 22.18 | 1 |
| | | 1 | 99 | 22.09 | 22.14 | 22.04 | 1 |
| | | 50 | 0 | 21.17 | 21.22 | 21.21 | 2 |
| | | 50 | 25 | 21.12 | 21.19 | 21.18 | 2 |
| | | 50 | 50 | 21.12 | 21.13 | 21.14 | 2 |
| | | 100 | 0 | 21.06 | 21.11 | 21.19 | 2 |

EIRP POWER (dBm)

GSM

| Channel | Frequency (MHz) | LVL (dBm) | Correction Factor(dB) | EIRP(dBm) | EIRP(mW) | Polarization (H/V) |
|---------|-----------------|-----------|-----------------------|-----------|---------------|--------------------|
| 512 | 1850.2 | -24.72 | 43.83 | 19.11 | 81.47 | H |
| 661 | 1880.0 | -24.81 | 43.57 | 18.76 | 75.16 | H |
| 810 | 1909.8 | -24.79 | 44.57 | 19.78 | 95.06 | H |
| 512 | 1850.2 | -19.22 | 46.39 | 27.17 | 521.19 | V |
| 661 | 1880.0 | -19.26 | 47.10 | 27.84 | 607.86 | V |
| 810 | 1909.8 | -19.23 | 45.98 | 26.75 | 472.72 | V |

EDGE

| Channel | Frequency (MHz) | LVL (dBm) | Correction Factor(dB) | EIRP(dBm) | EIRP(mW) | Polarization (H/V) |
|---------|-----------------|-----------|-----------------------|-----------|---------------|--------------------|
| 512 | 1850.2 | -24.80 | 43.83 | 19.03 | 79.98 | H |
| 661 | 1880.0 | -24.86 | 43.57 | 18.71 | 74.30 | H |
| 810 | 1909.8 | -24.93 | 44.57 | 19.64 | 92.04 | H |
| 512 | 1850.2 | -20.09 | 46.39 | 26.30 | 426.58 | V |
| 661 | 1880.0 | -20.32 | 47.10 | 26.78 | 476.21 | V |
| 810 | 1909.8 | -20.39 | 45.98 | 25.59 | 361.91 | V |

WCDMA

| Channel | Frequency (MHz) | LVL (dBm) | Correction Factor(dB) | EIRP(dBm) | EIRP(mW) | Polarization (H/V) |
|---------|-----------------|-----------|-----------------------|-----------|---------------|--------------------|
| 9262 | 1852.4 | -23.99 | 43.83 | 19.84 | 96.38 | H |
| 9400 | 1880.0 | -25.41 | 43.57 | 18.16 | 65.46 | H |
| 9538 | 1907.6 | -25.32 | 44.57 | 19.25 | 84.14 | H |
| 9262 | 1852.4 | -22.73 | 46.39 | 23.66 | 232.27 | V |
| 9400 | 1880.0 | -22.65 | 47.10 | 24.45 | 278.48 | V |
| 9538 | 1907.6 | -22.90 | 45.98 | 23.08 | 203.05 | V |

- REMARKS:** 1. EIRP Output Power (dBm) = LVL (dBm) + Correction Factor (dB).
 2. Correction factor (dB) = Free Space Loss + Antenna Factor + Cable Loss

LTE BAND 2

CHANNEL BANDWIDTH: 1.4MHz QPSK

| Channel | Frequency (MHz) | LVL (dBm) | Correction Factor(dB) | EIRP(dBm) | EIRP(mW) | Polarization (H/V) | LIMIT (W) |
|---------|-----------------|-----------|-----------------------|-----------|---------------|--------------------|-----------|
| 18607 | 1850.7 | -20.08 | 43.83 | 23.75 | 237.36 | H | 1 |
| 18900 | 1880.0 | -21.37 | 43.57 | 22.20 | 165.96 | H | 1 |
| 19193 | 1909.3 | -21.48 | 44.32 | 22.84 | 192.26 | H | 1 |
| 18607 | 1850.7 | -22.20 | 46.41 | 24.21 | 263.69 | V | 1 |
| 18900 | 1880.0 | -22.47 | 47.07 | 24.60 | 288.40 | V | 1 |
| 19193 | 1909.3 | -22.31 | 45.88 | 23.57 | 227.72 | V | 1 |

NOTE: EIRP (dBm) = LVL (dBm) + Correction Factor (dB)

CHANNEL BANDWIDTH: 1.4MHz 16QAM

| Channel | Frequency (MHz) | LVL (dBm) | Correction Factor(dB) | EIRP(dBm) | EIRP(mW) | Polarization (H/V) | LIMIT (W) |
|---------|-----------------|-----------|-----------------------|-----------|----------|--------------------|-----------|
| 18607 | 1850.7 | -20.95 | 43.83 | 22.88 | 194.27 | H | 1 |
| 18900 | 1880.0 | -22.30 | 43.57 | 21.27 | 133.97 | H | 1 |
| 19193 | 1909.3 | -22.44 | 44.32 | 21.88 | 154.13 | H | 1 |
| 18607 | 1850.7 | -23.07 | 46.41 | 23.34 | 215.82 | V | 1 |
| 18900 | 1880.0 | -23.28 | 47.07 | 23.79 | 239.33 | V | 1 |
| 19193 | 1909.3 | -23.27 | 45.88 | 22.61 | 182.56 | V | 1 |

NOTE: EIRP (dBm) = LVL (dBm) + Correction Factor (dB)

CHANNEL BANDWIDTH: 3MHz QPSK

| Channel | Frequency (MHz) | LVL (dBm) | Correction Factor(dB) | EIRP(dBm) | EIRP(mW) | Polarization (H/V) | LIMIT (W) |
|---------|-----------------|-----------|-----------------------|-----------|---------------|--------------------|-----------|
| 18615 | 1851.5 | -20.06 | 43.82 | 23.76 | 237.79 | H | 1 |
| 18900 | 1880.0 | -21.43 | 43.57 | 22.14 | 163.68 | H | 1 |
| 19185 | 1908.5 | -21.43 | 44.38 | 22.95 | 197.06 | H | 1 |
| 18615 | 1851.5 | -22.18 | 46.45 | 24.27 | 267.36 | V | 1 |
| 18900 | 1880.0 | -22.16 | 47.07 | 24.91 | 309.74 | V | 1 |
| 19185 | 1908.5 | -22.26 | 45.88 | 23.62 | 230.14 | V | 1 |

NOTE: EIRP (dBm) = LVL (dBm) + Correction Factor (dB)

CHANNEL BANDWIDTH: 3MHz 16QAM

| Channel | Frequency (MHz) | LVL (dBm) | Correction Factor(dB) | EIRP(dBm) | EIRP(mW) | Polarization (H/V) | LIMIT (W) |
|---------|-----------------|-----------|-----------------------|-----------|----------|--------------------|-----------|
| 18615 | 1851.5 | -21.13 | 43.82 | 22.69 | 185.87 | H | 1 |
| 18900 | 1880.0 | -22.32 | 43.57 | 21.25 | 133.35 | H | 1 |
| 19185 | 1908.5 | -22.42 | 44.38 | 21.96 | 156.89 | H | 1 |
| 18615 | 1851.5 | -23.25 | 46.45 | 23.20 | 208.98 | V | 1 |
| 18900 | 1880.0 | -23.31 | 47.07 | 23.76 | 237.68 | V | 1 |
| 19185 | 1908.5 | -23.56 | 45.88 | 22.32 | 170.61 | V | 1 |

NOTE: EIRP (dBm) = LVL (dBm) + Correction Factor (dB)

CHANNEL BANDWIDTH: 5MHz QPSK

| Channel | Frequency (MHz) | LVL (dBm) | Correction Factor(dB) | EIRP(dBm) | EIRP(mW) | Polarization (H/V) | LIMIT (W) |
|---------|-----------------|-----------|-----------------------|-----------|---------------|--------------------|-----------|
| 18625 | 1852.5 | -20.12 | 43.83 | 23.71 | 234.86 | H | 1 |
| 18900 | 1880.0 | -21.38 | 43.57 | 22.19 | 165.58 | H | 1 |
| 19175 | 1907.5 | -21.38 | 44.19 | 22.81 | 190.90 | H | 1 |
| 18625 | 1852.5 | -22.24 | 46.46 | 24.22 | 264.42 | V | 1 |
| 18900 | 1880.0 | -22.37 | 47.07 | 24.70 | 295.12 | V | 1 |
| 19175 | 1907.5 | -22.21 | 45.89 | 23.68 | 233.40 | V | 1 |

NOTE: EIRP (dBm) = LVL (dBm) + Correction Factor (dB)

CHANNEL BANDWIDTH: 5MHz 16QAM

| Channel | Frequency (MHz) | LVL (dBm) | Correction Factor(dB) | EIRP(dBm) | EIRP(mW) | Polarization (H/V) | LIMIT (W) |
|---------|-----------------|-----------|-----------------------|-----------|----------|--------------------|-----------|
| 18625 | 1852.5 | -20.95 | 43.83 | 22.88 | 194.00 | H | 1 |
| 18900 | 1880.0 | -22.40 | 43.57 | 21.17 | 130.92 | H | 1 |
| 19175 | 1907.5 | -22.48 | 44.19 | 21.71 | 148.18 | H | 1 |
| 18625 | 1852.5 | -23.07 | 46.46 | 23.39 | 218.42 | V | 1 |
| 18900 | 1880.0 | -23.21 | 47.07 | 23.86 | 243.22 | V | 1 |
| 19175 | 1907.5 | -23.31 | 45.89 | 22.58 | 181.18 | V | 1 |

NOTE: EIRP (dBm) = LVL (dBm) + Correction Factor (dB)

CHANNEL BANDWIDTH: 10MHz QPSK

| Channel | Frequency (MHz) | LVL (dBm) | Correction Factor(dB) | EIRP(dBm) | EIRP(mW) | Polarization (H/V) | LIMIT (W) |
|---------|-----------------|-----------|-----------------------|-----------|---------------|--------------------|-----------|
| 18650 | 1855.0 | -19.93 | 43.86 | 23.93 | 247.23 | H | 1 |
| 18900 | 1880.0 | -21.32 | 43.57 | 22.25 | 167.88 | H | 1 |
| 19150 | 1905.0 | -21.25 | 43.99 | 22.74 | 188.10 | H | 1 |
| 18650 | 1855.0 | -22.05 | 46.28 | 24.23 | 264.73 | V | 1 |
| 18900 | 1880.0 | -22.28 | 47.07 | 24.79 | 301.30 | V | 1 |
| 19150 | 1905.0 | -22.08 | 45.92 | 23.84 | 242.21 | V | 1 |

NOTE: EIRP (dBm) = LVL (dBm) + Correction Factor (dB)

CHANNEL BANDWIDTH: 10MHz 16QAM

| Channel | Frequency (MHz) | LVL (dBm) | Correction Factor(dB) | EIRP(dBm) | EIRP(mW) | Polarization (H/V) | LIMIT (W) |
|---------|-----------------|-----------|-----------------------|-----------|----------|--------------------|-----------|
| 18650 | 1855.0 | -21.08 | 43.86 | 22.78 | 189.71 | H | 1 |
| 18900 | 1880.0 | -22.42 | 43.57 | 21.15 | 130.32 | H | 1 |
| 19150 | 1905.0 | -22.41 | 43.99 | 21.58 | 144.01 | H | 1 |
| 18650 | 1855.0 | -23.20 | 46.28 | 23.08 | 203.14 | V | 1 |
| 18900 | 1880.0 | -23.19 | 47.07 | 23.88 | 244.34 | V | 1 |
| 19150 | 1905.0 | -23.24 | 45.92 | 22.68 | 185.44 | V | 1 |

NOTE: EIRP (dBm) = LVL (dBm) + Correction Factor (dB)

CHANNEL BANDWIDTH: 15MHz QPSK

| Channel | Frequency (MHz) | LVL (dBm) | Correction Factor(dB) | EIRP(dBm) | EIRP(mW) | Polarization (H/V) | LIMIT (W) |
|---------|-----------------|-----------|-----------------------|-----------|---------------|--------------------|-----------|
| 18675 | 1857.5 | -19.94 | 43.99 | 24.05 | 254.21 | H | 1 |
| 18900 | 1880.0 | -21.39 | 43.57 | 22.18 | 165.20 | H | 1 |
| 19125 | 1902.5 | -21.32 | 43.66 | 22.34 | 171.20 | H | 1 |
| 18675 | 1857.5 | -22.06 | 45.93 | 23.87 | 243.61 | V | 1 |
| 18900 | 1880.0 | -21.92 | 47.07 | 25.15 | 327.34 | V | 1 |
| 19125 | 1902.5 | -22.15 | 46.20 | 24.05 | 254.21 | V | 1 |

NOTE: EIRP (dBm) = LVL (dBm) + Correction Factor (dB)

CHANNEL BANDWIDTH: 15MHz 16QAM

| Channel | Frequency (MHz) | LVL (dBm) | Correction Factor(dB) | EIRP(dBm) | EIRP(mW) | Polarization (H/V) | LIMIT (W) |
|---------|-----------------|-----------|-----------------------|-----------|----------|--------------------|-----------|
| 18675 | 1857.5 | -20.80 | 43.99 | 23.19 | 208.55 | H | 1 |
| 18900 | 1880.0 | -22.26 | 43.57 | 21.31 | 135.21 | H | 1 |
| 19125 | 1902.5 | -22.17 | 43.66 | 21.49 | 140.77 | H | 1 |
| 18675 | 1857.5 | -22.92 | 45.93 | 23.01 | 199.85 | V | 1 |
| 18900 | 1880.0 | -22.79 | 47.07 | 24.28 | 267.92 | V | 1 |
| 19125 | 1902.5 | -23.00 | 46.20 | 23.20 | 209.03 | V | 1 |

NOTE: EIRP (dBm) = LVL (dBm) + Correction Factor (dB)

CHANNEL BANDWIDTH: 20MHz QPSK

| Channel | Frequency (MHz) | LVL (dBm) | Correction Factor(dB) | EIRP(dBm) | EIRP(mW) | Polarization (H/V) | LIMIT (W) |
|---------|-----------------|-----------|-----------------------|-----------|---------------|--------------------|-----------|
| 18700 | 1860.0 | -20.52 | 43.50 | 22.98 | 198.56 | H | 1 |
| 18900 | 1880.0 | -21.84 | 43.57 | 21.73 | 148.94 | H | 1 |
| 19100 | 1900.0 | -21.90 | 43.62 | 21.72 | 148.46 | H | 1 |
| 18700 | 1860.0 | -22.64 | 45.57 | 22.93 | 196.34 | V | 1 |
| 18900 | 1880.0 | -22.37 | 47.07 | 24.70 | 295.12 | V | 1 |
| 19100 | 1900.0 | -22.73 | 46.26 | 23.53 | 225.48 | V | 1 |

NOTE: EIRP (dBm) = LVL (dBm) + Correction Factor (dB)

CHANNEL BANDWIDTH: 20MHz 16QAM

| Channel | Frequency (MHz) | LVL (dBm) | Correction Factor(dB) | EIRP(dBm) | EIRP(mW) | Polarization (H/V) | LIMIT (W) |
|---------|-----------------|-----------|-----------------------|-----------|----------|--------------------|-----------|
| 18700 | 1860.0 | -21.45 | 43.50 | 22.05 | 160.29 | H | 1 |
| 18900 | 1880.0 | -22.91 | 43.57 | 20.66 | 116.41 | H | 1 |
| 19100 | 1900.0 | -22.73 | 43.62 | 20.89 | 122.63 | H | 1 |
| 18700 | 1860.0 | -23.57 | 45.57 | 22.00 | 158.49 | V | 1 |
| 18900 | 1880.0 | -23.44 | 47.07 | 23.63 | 230.67 | V | 1 |
| 19100 | 1900.0 | -23.56 | 46.26 | 22.70 | 186.25 | V | 1 |

NOTE: EIRP (dBm) = LVL (dBm) + Correction Factor (dB)

4.2 Frequency Stability Measurement

4.2.1 Limits of Frequency Stability Measurement

The frequency stability shall be sufficient to ensure that the fundamental emission stays within the authorized frequency block.

4.2.2 Test Procedure

- a. Device is placed at the oven room. The oven room could control the temperatures and humidity. Power warm up is at least 15 min and power applied should perform before recording frequency error.
- b. EUT is connected the external power supply to control the DC input power. The test voltage range is from minimum to maximum working voltage. Each step shall be record the frequency error rate.
- c. The temperature range step is 10 degrees in this test items. All temperature levels shall be hold the $\pm 0.5^{\circ}\text{C}$ during the measurement testing. The each temperature step shall be at least 0.5 hours, consider the EUT could be test under the stability condition.

NOTE: The frequency error was recorded frequency error from the communication simulator.

4.2.3 Test Setup

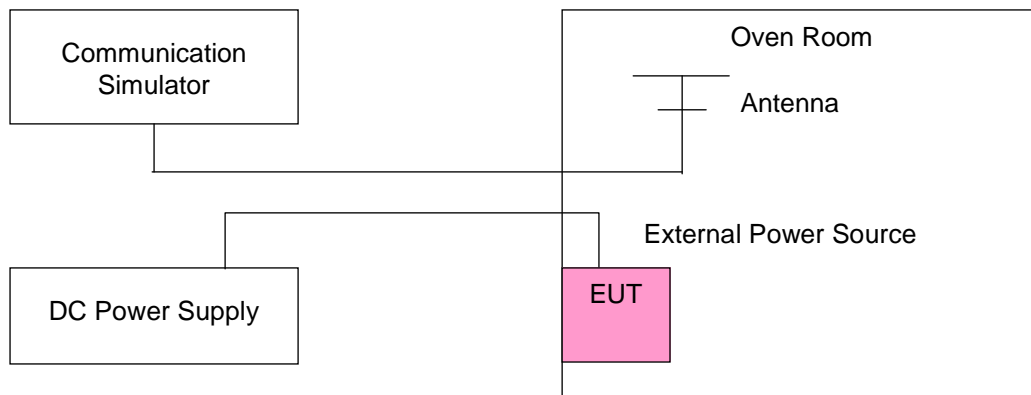

4.2.4 Test Results

FREQUENCY ERROR VS. VOLTAGE

| VOLTAGE (Volts) | FREQUENCY ERROR (ppm) | | | LIMIT (ppm) |
|-----------------|-----------------------|---------|---------|-------------|
| | GSM | EDGE | WCDMA | |
| 3.9 | 0.0006 | 0.0005 | 0.0008 | 2.5 |
| 3.7 | -0.0020 | -0.0023 | -0.0025 | 2.5 |
| 4.35 | -0.0015 | -0.0026 | -0.0021 | 2.5 |

NOTE: The applicant defined the normal working voltage of the battery is from 3.7Vdc to 4.35Vdc.

FREQUENCY ERROR vs. TEMPERATURE.

| TEMP. (°C) | FREQUENCY ERROR (ppm) | | | LIMIT (ppm) |
|------------|-----------------------|---------|---------|-------------|
| | GSM | EDGE | WCDMA | |
| -30 | -0.0065 | -0.0067 | -0.0060 | 2.5 |
| -20 | -0.0058 | -0.0059 | -0.0054 | 2.5 |
| -10 | -0.0052 | -0.0053 | -0.0045 | 2.5 |
| 0 | -0.0043 | -0.0047 | -0.0038 | 2.5 |
| 10 | -0.0037 | -0.0038 | -0.0031 | 2.5 |
| 20 | -0.0034 | -0.0031 | -0.0022 | 2.5 |
| 30 | -0.0025 | -0.0022 | -0.0016 | 2.5 |
| 40 | -0.0016 | -0.0016 | -0.0009 | 2.5 |
| 50 | -0.0011 | -0.0006 | -0.0003 | 2.5 |
| 60 | -0.0006 | -0.0002 | 0.0003 | 2.5 |

LTE BAND 2

| AFC FREQUENCY ERROR vs. VOLTAGE | | | | | | | |
|---------------------------------|-----------------------|---------|---------|---------|---------|---------|-------------|
| VOLTAGE (Volts) | FREQUENCY ERROR (ppm) | | | | | | LIMIT (ppm) |
| | 1.4MHz | 3MHz | 5MHz | 10MHz | 15MHz | 20MHz | |
| 3.9 | 0.0010 | 0.0014 | 0.0007 | 0.0017 | 0.0027 | 0.0012 | 2.5 |
| 3.7 | -0.0039 | -0.0051 | -0.0041 | -0.0034 | -0.0066 | -0.0028 | 2.5 |
| 4.35 | -0.0038 | -0.0044 | -0.0048 | -0.0036 | -0.0057 | -0.0028 | 2.5 |

NOTE: The applicant defined the normal working voltage of the battery is from 3.7Vdc to 4.35Vdc.

| AFC FREQUENCY ERROR vs. TEMPERATURE | | | | | | | |
|-------------------------------------|-----------------------|---------|---------|---------|---------|---------|-------------|
| TEMP. (°C) | FREQUENCY ERROR (ppm) | | | | | | LIMIT (ppm) |
| | 1.4MHz | 3MHz | 5MHz | 10MHz | 15MHz | 20MHz | |
| -30 | -0.0068 | -0.0068 | -0.0064 | -0.0063 | -0.0069 | -0.0062 | 2.5 |
| -20 | -0.0057 | -0.0060 | -0.0056 | -0.0056 | -0.0059 | -0.0055 | 2.5 |
| -10 | -0.0050 | -0.0054 | -0.0050 | -0.0049 | -0.0053 | -0.0044 | 2.5 |
| 0 | -0.0043 | -0.0047 | -0.0044 | -0.0043 | -0.0045 | -0.0040 | 2.5 |
| 10 | -0.0040 | -0.0040 | -0.0038 | -0.0037 | -0.0039 | -0.0028 | 2.5 |
| 20 | -0.0031 | -0.0033 | -0.0034 | -0.0028 | -0.0032 | -0.0022 | 2.5 |
| 30 | -0.0023 | -0.0029 | -0.0026 | -0.0021 | -0.0023 | -0.0012 | 2.5 |
| 40 | -0.0016 | -0.0021 | -0.0021 | -0.0011 | -0.0012 | -0.0006 | 2.5 |
| 50 | -0.0006 | -0.0012 | -0.0011 | -0.0011 | -0.0005 | -0.0001 | 2.5 |
| 60 | -0.0002 | -0.0007 | -0.0004 | -0.0002 | -0.0001 | 0.0002 | 2.5 |

4.3 Occupied Bandwidth Measurement

4.3.1 Test Procedure

The EUT makes a call to the communication simulator. All measurements were done at low, middle and high operational frequency range. The communication simulator station system controlled a EUT to export maximum output power under transmission mode and specific channel frequency. Use OBW measurement function of Spectrum analyzer to measure 99 % occupied bandwidth.

4.3.2 Test Setup

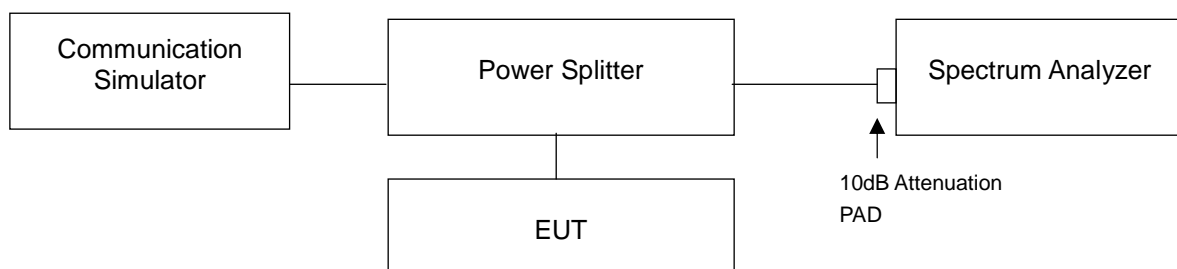

4.3.3 Test Result

| CHANNEL | FREQUENCY (MHz) | 99% OCCUPIED BANDWIDTH (kHz) | | CHANNEL | FREQUENCY (MHz) | 99% OCCUPIED BANDWIDTH (MHz) |
|---------|-----------------|------------------------------|--------|---------|-----------------|------------------------------|
| | | GSM | EDGE | | | WCDMA |
| 512 | 1850.2 | 245.00 | 247.00 | 9262 | 1852.4 | 4.20 |
| 661 | 1880.0 | 244.00 | 245.00 | 9400 | 1880.0 | 4.20 |
| 810 | 1909.8 | 247.00 | 243.00 | 9538 | 1907.6 | 4.20 |

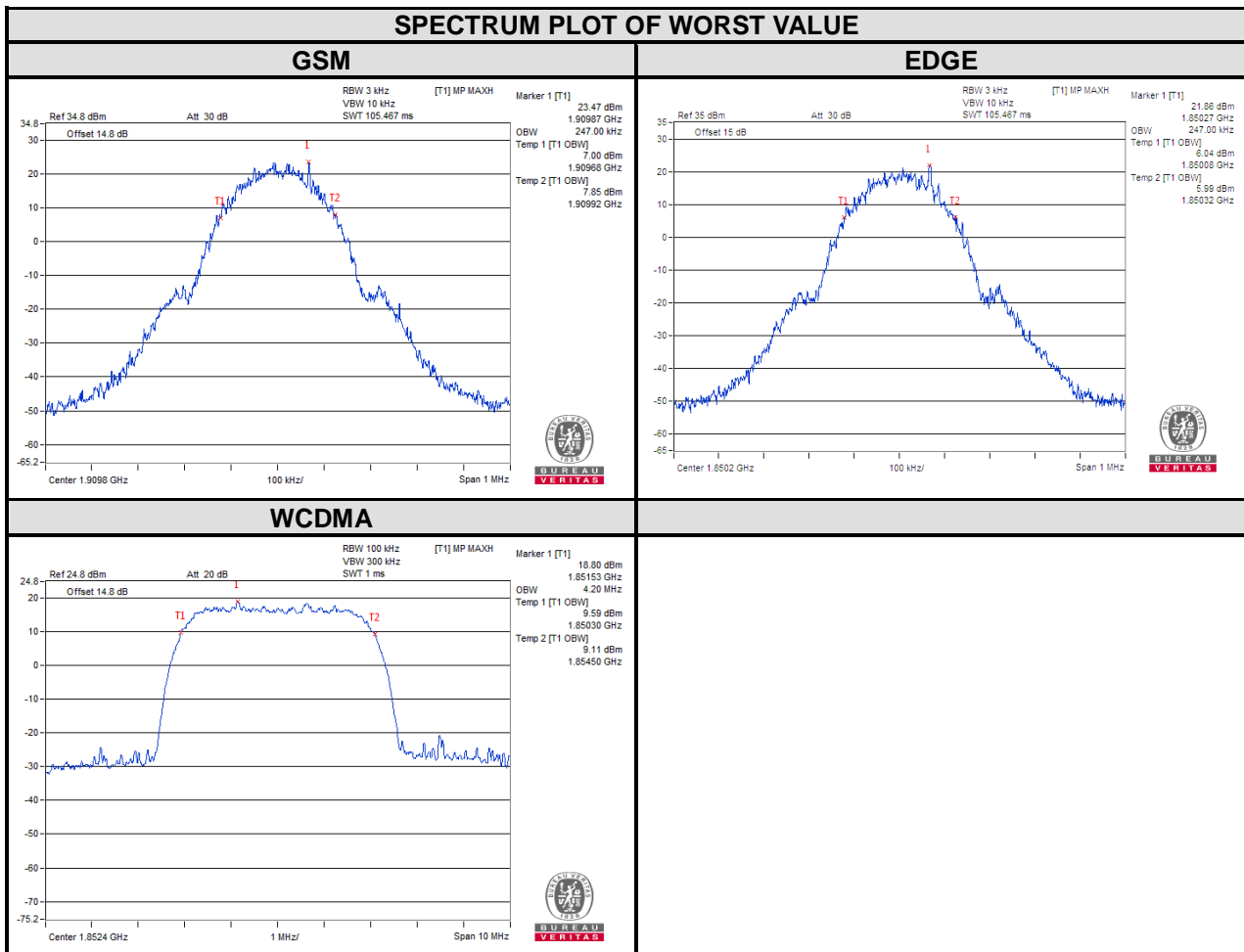

| CHANNEL | FREQUENCY (MHz) | 26dB BANDWIDTH (kHz) | | CHANNEL | FREQUENCY (MHz) | 26dB BANDWIDTH (MHz) |
|---------|-----------------|----------------------|--------|---------|-----------------|----------------------|
| | | GSM | EDGE | | | WCDMA |
| 512 | 1850.2 | 322.28 | 316.66 | 9262 | 1852.4 | 4.87 |
| 661 | 1880.0 | 324.47 | 320.82 | 9400 | 1880.0 | 4.87 |
| 810 | 1909.8 | 320.89 | 319.51 | 9538 | 1907.6 | 4.86 |

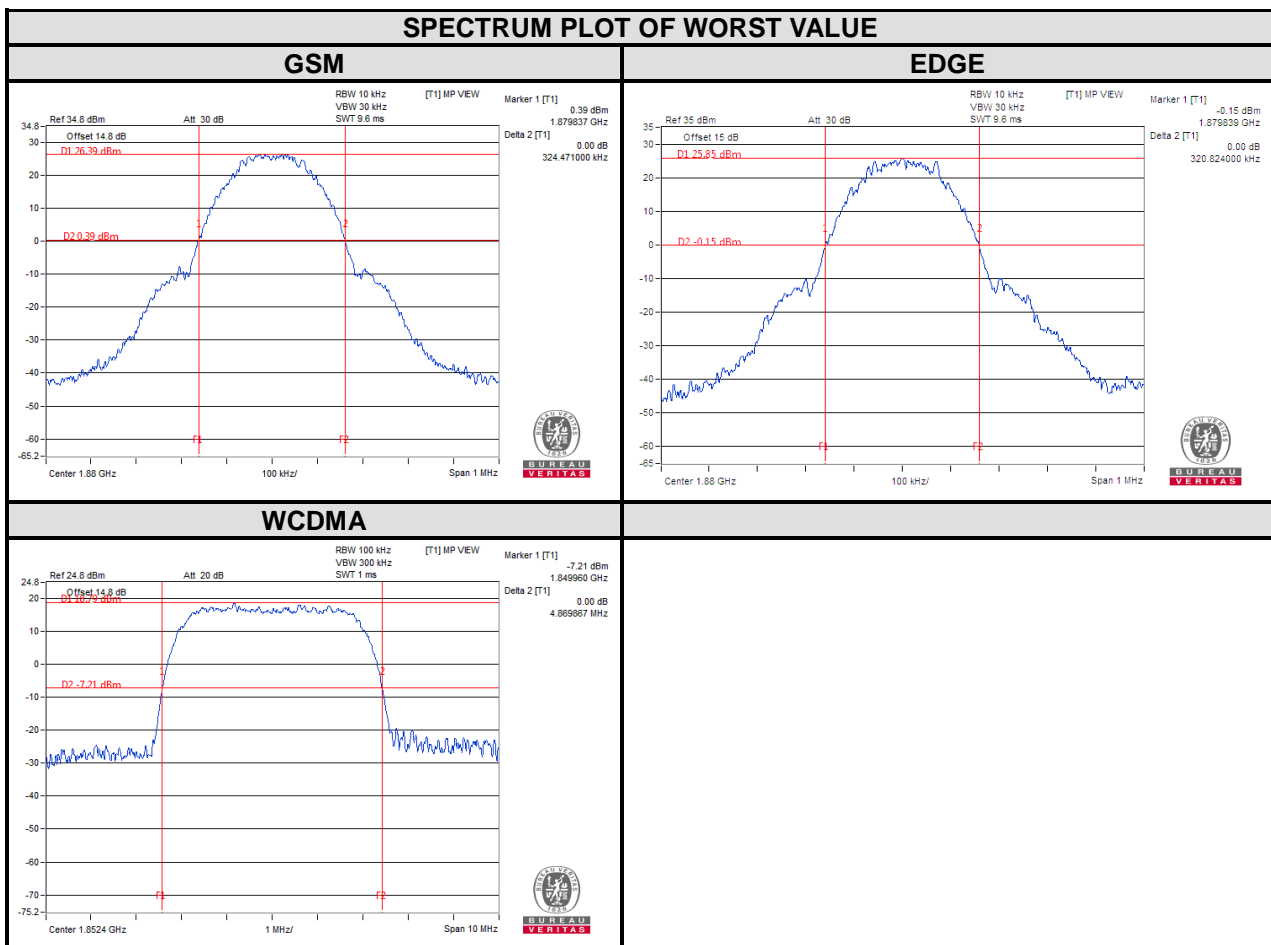

| LTE band 2 | | | | | | | |
|----------------------------|-----------------|------------------------------|-------|---------|-----------------|-----------------------|-------|
| Channel Bandwidth : 1.4MHz | | | | | | | |
| Channel | Frequency (MHz) | 99% Occupied bandwidth (MHz) | | Channel | Frequency (MHz) | 26 dB bandwidth (MHz) | |
| | | QPSK | 16QAM | | | QPSK | 16QAM |
| 18607 | 1850.7 | 1.08 | 1.08 | 18607 | 1850.7 | 1.25 | 1.25 |
| 18900 | 1880 | 1.08 | 1.08 | 18900 | 1880 | 1.25 | 1.25 |
| 19193 | 1909.3 | 1.08 | 1.08 | 19193 | 1909.3 | 1.25 | 1.26 |

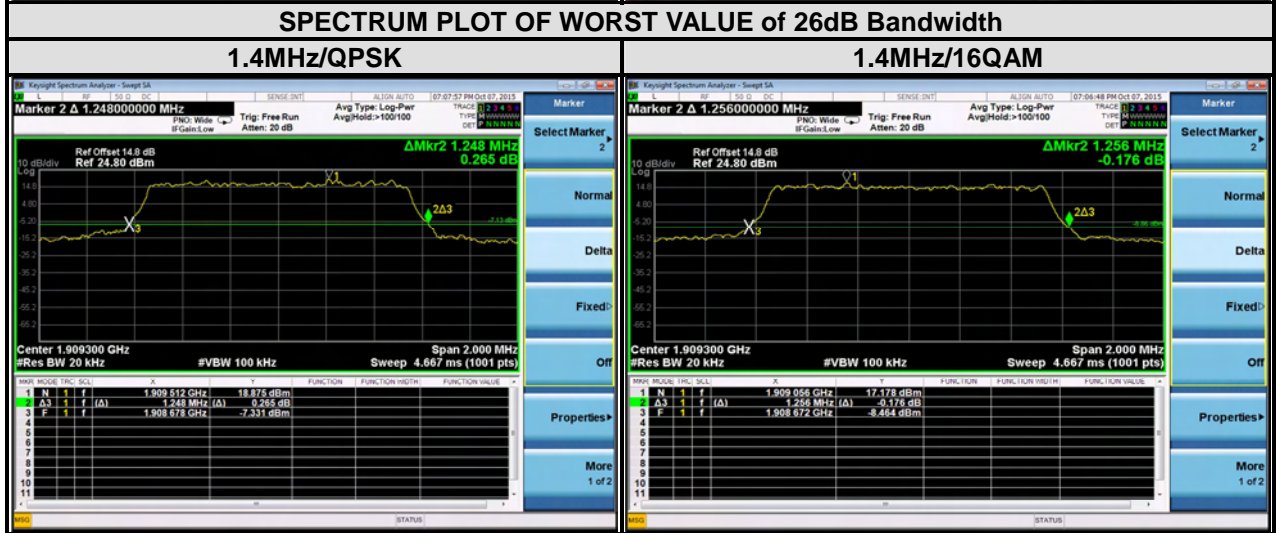
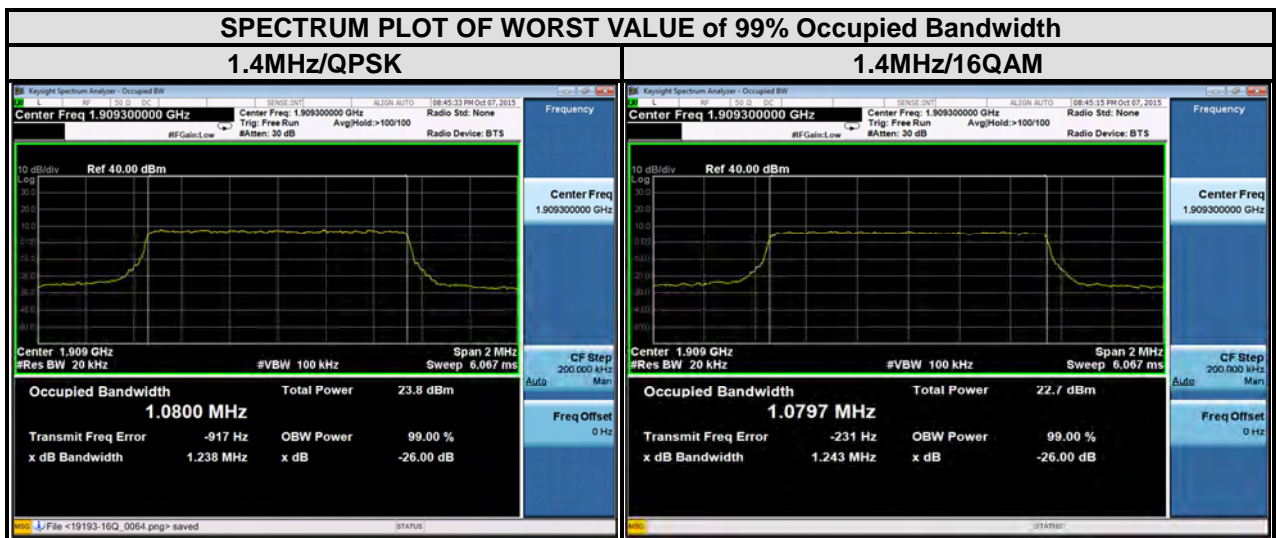

| LTE band 2 | | | | | | | |
|--------------------------|-----------------|------------------------------|-------|---------|-----------------|-----------------------|-------|
| Channel Bandwidth : 3MHz | | | | | | | |
| Channel | Frequency (MHz) | 99% Occupied bandwidth (MHz) | | Channel | Frequency (MHz) | 26 dB bandwidth (MHz) | |
| | | QPSK | 16QAM | | | QPSK | 16QAM |
| 18615 | 1851.5 | 2.68 | 2.68 | 18615 | 1851.5 | 2.94 | 2.91 |
| 18900 | 1880 | 2.68 | 2.69 | 18900 | 1880 | 2.95 | 2.93 |
| 19185 | 1908.5 | 2.67 | 2.68 | 19185 | 1908.5 | 2.93 | 2.92 |

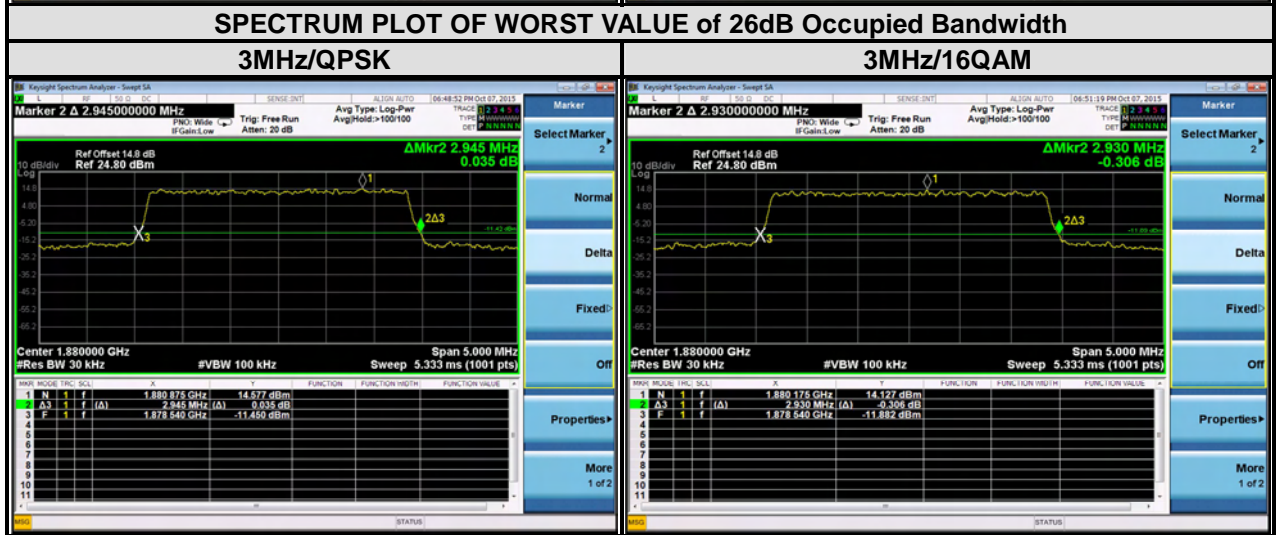
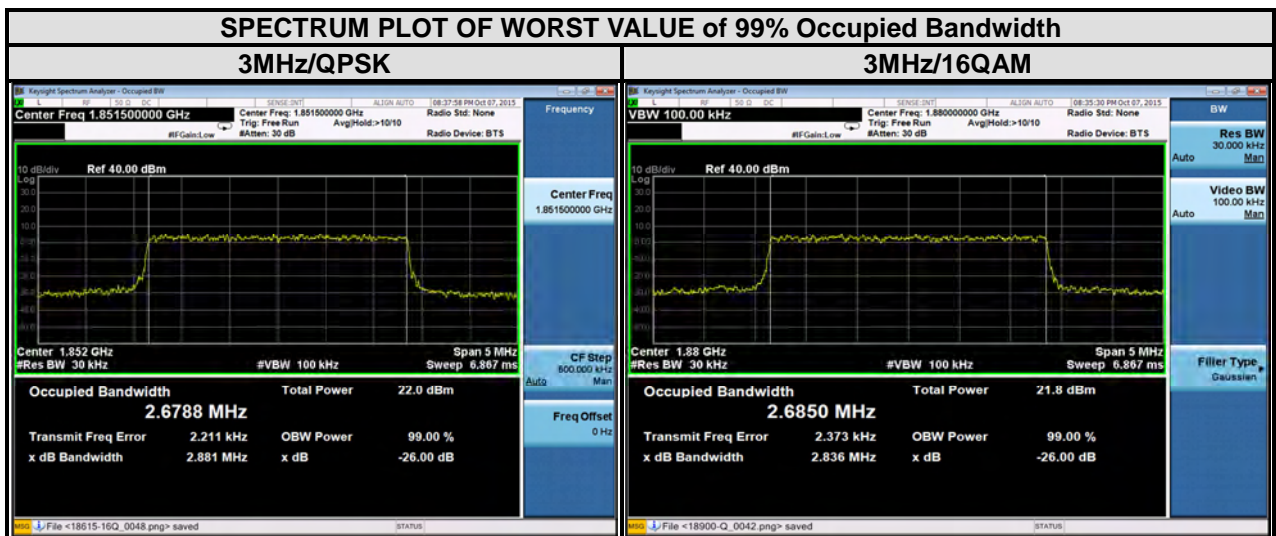

| LTE band 2 | | | | | | | |
|---------------------------|-----------------|------------------------------|-------|---------|-----------------|-----------------------|-------|
| Channel Bandwidth : 5 MHz | | | | | | | |
| Channel | Frequency (MHz) | 99% Occupied bandwidth (MHz) | | Channel | Frequency (MHz) | 26 dB bandwidth (MHz) | |
| | | QPSK | 16QAM | | | QPSK | 16QAM |
| 18625 | 1852.5 | 4.47 | 4.47 | 18625 | 1852.5 | 5.01 | 4.98 |
| 18900 | 1880 | 4.49 | 4.47 | 18900 | 1880 | 5.00 | 5.00 |
| 19175 | 1907.5 | 4.47 | 4.46 | 19175 | 1907.5 | 5.02 | 4.95 |

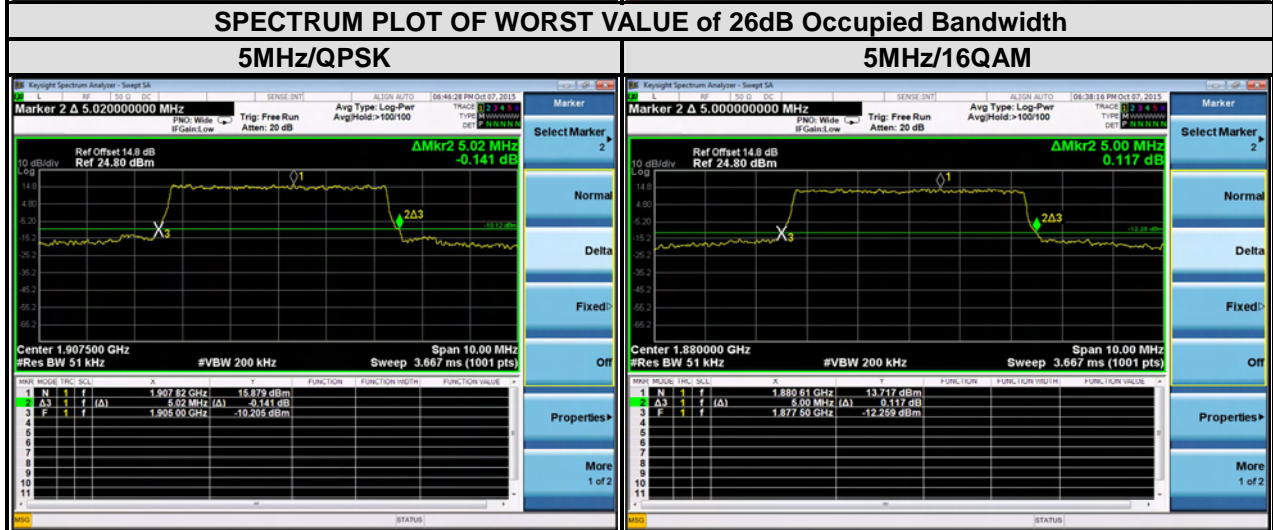
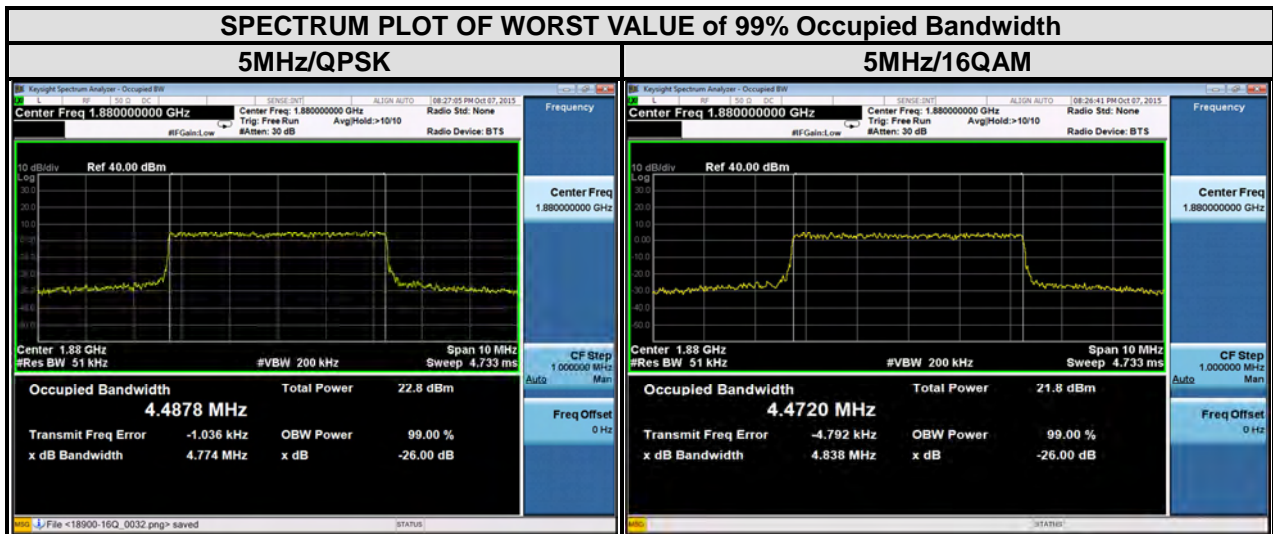

| LTE band 2 | | | | | | | |
|----------------------------|-----------------|------------------------------|-------|---------|-----------------|-----------------------|-------|
| Channel Bandwidth : 10 MHz | | | | | | | |
| Channel | Frequency (MHz) | 99% Occupied bandwidth (MHz) | | Channel | Frequency (MHz) | 26 dB bandwidth (MHz) | |
| | | QPSK | 16QAM | | | QPSK | 16QAM |
| 18650 | 1855 | 8.92 | 8.92 | 18650 | 1855 | 9.80 | 9.84 |
| 18900 | 1880 | 8.91 | 8.93 | 18900 | 1880 | 9.78 | 9.90 |
| 19150 | 1905 | 8.91 | 8.91 | 19150 | 1905 | 9.78 | 9.96 |

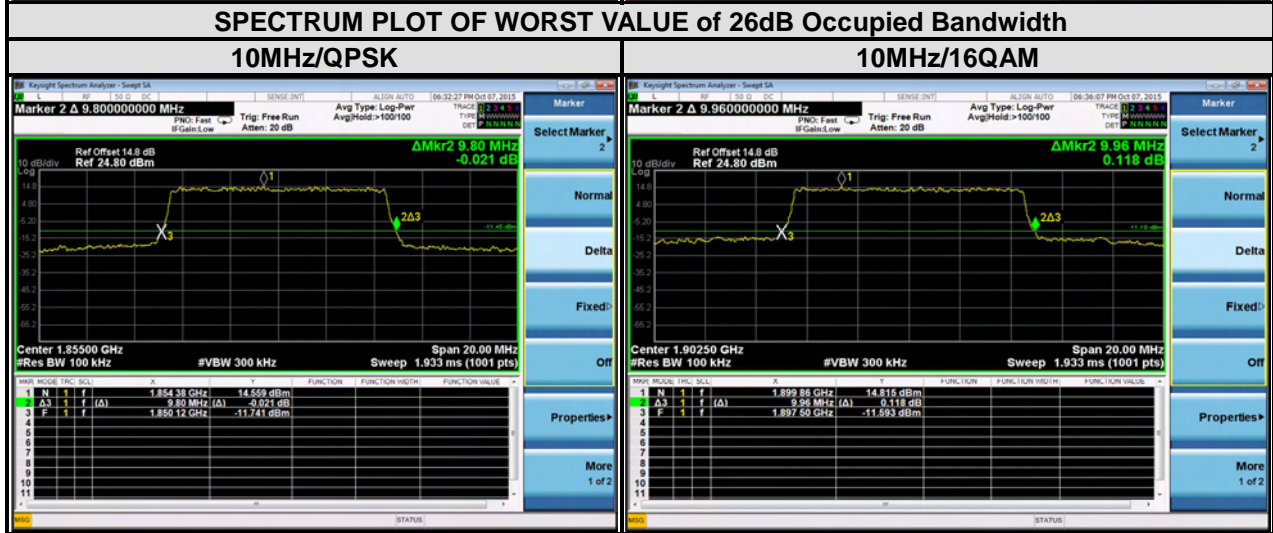
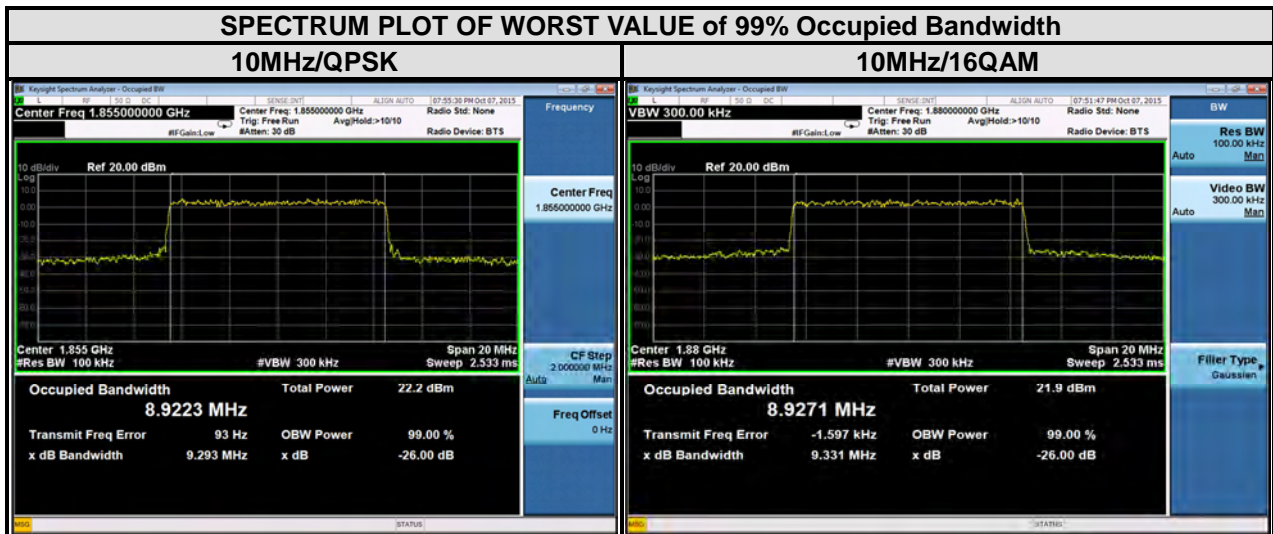

| LTE band 2 | | | | | | | |
|----------------------------|-----------------|------------------------------|-------|---------|-----------------|-----------------------|-------|
| Channel Bandwidth : 15 MHz | | | | | | | |
| Channel | Frequency (MHz) | 99% Occupied bandwidth (MHz) | | Channel | Frequency (MHz) | 26 dB bandwidth (MHz) | |
| | | QPSK | 16QAM | | | QPSK | 16QAM |
| 18675 | 1857.5 | 13.44 | 13.42 | 18675 | 1857.5 | 14.76 | 14.82 |
| 18900 | 1880 | 13.39 | 13.38 | 18900 | 1880 | 14.79 | 14.76 |
| 19125 | 1902.5 | 13.35 | 13.41 | 19125 | 1902.5 | 14.73 | 14.70 |

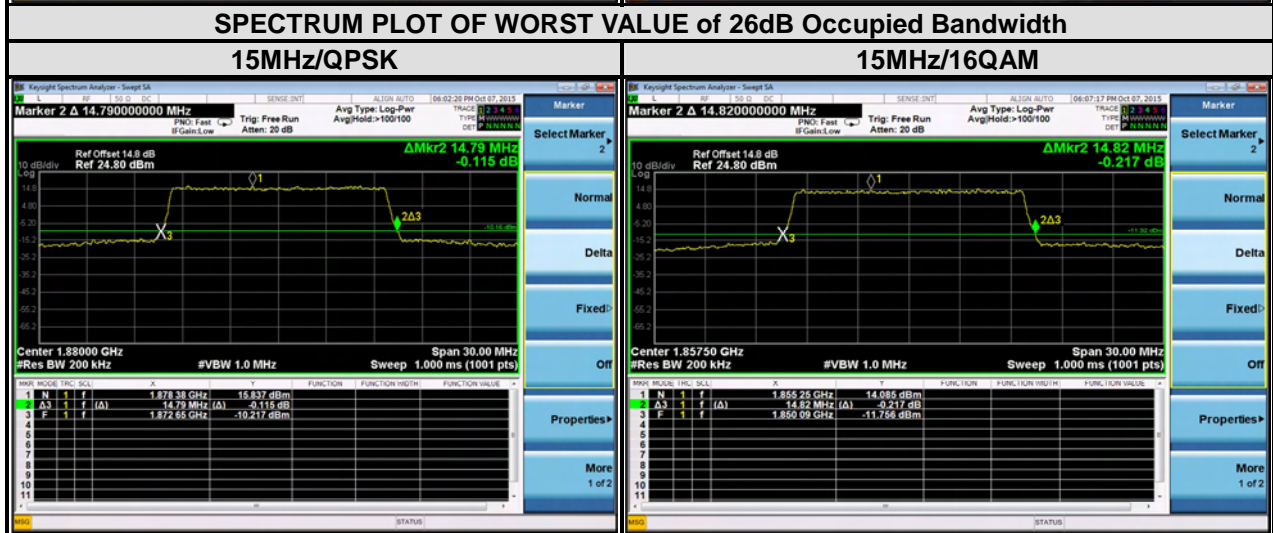
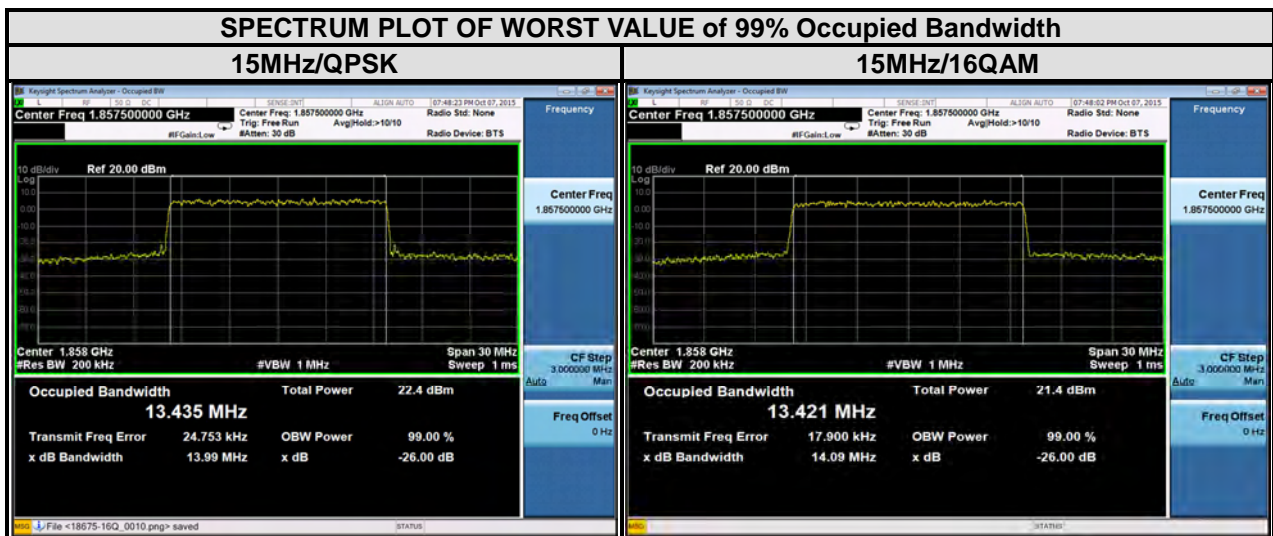

| LTE band 2 | | | | | | | |
|----------------------------|-----------------|------------------------------|-------|---------|-----------------|-----------------------|-------|
| Channel Bandwidth : 20 MHz | | | | | | | |
| Channel | Frequency (MHz) | 99% Occupied bandwidth (MHz) | | Channel | Frequency (MHz) | 26 dB bandwidth (MHz) | |
| | | QPSK | 16QAM | | | QPSK | 16QAM |
| 18700 | 1860 | 17.85 | 17.83 | 18700 | 1860 | 19.52 | 19.28 |
| 18900 | 1880 | 17.86 | 17.90 | 18900 | 1880 | 19.36 | 19.24 |
| 19100 | 1900 | 17.83 | 17.93 | 19100 | 1900 | 19.36 | 19.24 |

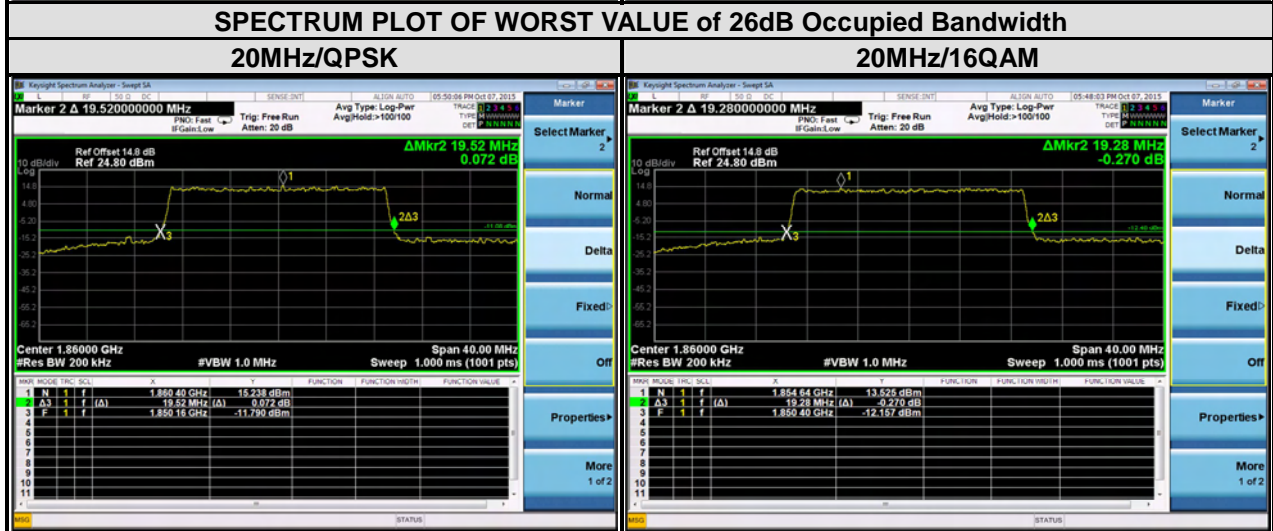
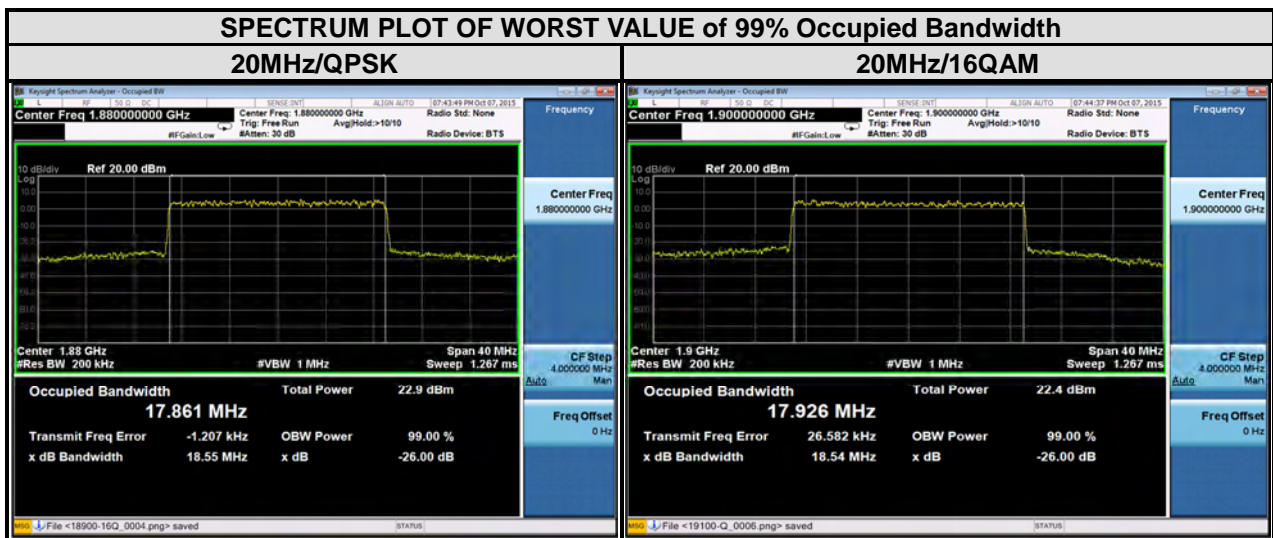

4.4 Band Edge Measurement

4.4.1 Limits of Band Edge Measurement

Power of any emission outside of the authorized operating frequency ranges must be attenuated below the transmitting power (P) by a factor of at least $43 + 10 \log(P)$ dB. In the 1 MHz bands immediately outside and adjacent to the frequency block a resolution bandwidth of at least one percent of the emission bandwidth of the fundamental emission of the transmitter may be employed.

4.4.2 Test Setup

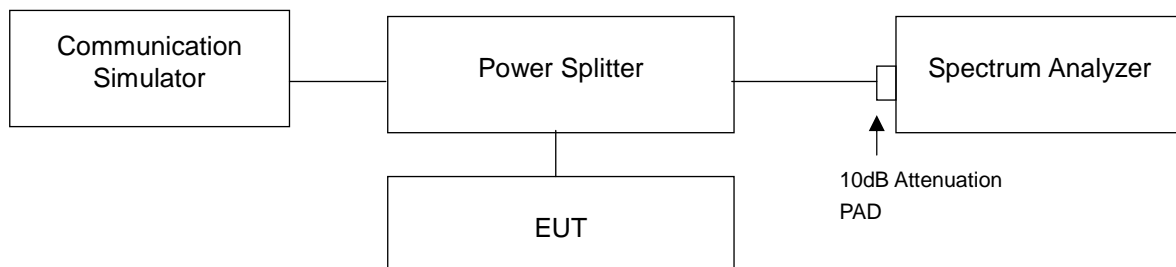

4.4.3 Test Procedures

- a. All measurements were done at low and high operational frequency range.
- b. The center frequency of spectrum is the band edge frequency and span is 1.5MHz. RB of the spectrum is 3kHz and VB of the spectrum is 10kHz (GSM/ GPRS/EDGE).
- c. The center frequency of spectrum is the band edge frequency and span is 10MHz. RB of the spectrum is 100kHz and VB of the spectrum is 300kHz (WCDMA).
- d. The center frequency of spectrum is the band edge frequency and span is 1~5 MHz. RB of the spectrum is 20kHz and VB of the spectrum is 100 kHz. (LTE bandwidth 1.4MHz)
- e. The center frequency of spectrum is the band edge frequency and span is 1~5 MHz. RB of the spectrum is 30kHz and VB of the spectrum is 100kHz. (LTE bandwidth 3MHz)
- f. The center frequency of spectrum is the band edge frequency and span is 1~5 MHz. RB of the spectrum is 50kHz and VB of the spectrum is 200kHz. (LTE bandwidth 5MHz)
- g. The center frequency of spectrum is the band edge frequency and span is 1~5 MHz. RB of the spectrum is 100kHz and VB of the spectrum is 300kHz. (LTE bandwidth 10MHz)
- h. The center frequency of spectrum is the band edge frequency and span is 1~5 MHz. RB of the spectrum is 200kHz and VB of the spectrum is 1MHz. (LTE bandwidth 15MHz)
- i. The center frequency of spectrum is the band edge frequency and span is 1~5 MHz. RB of the spectrum is 200kHz and VB of the spectrum is 1MHz. (LTE bandwidth 20MHz)
- j. Record the max trace plot into the test report.

4.4.4 Test Results

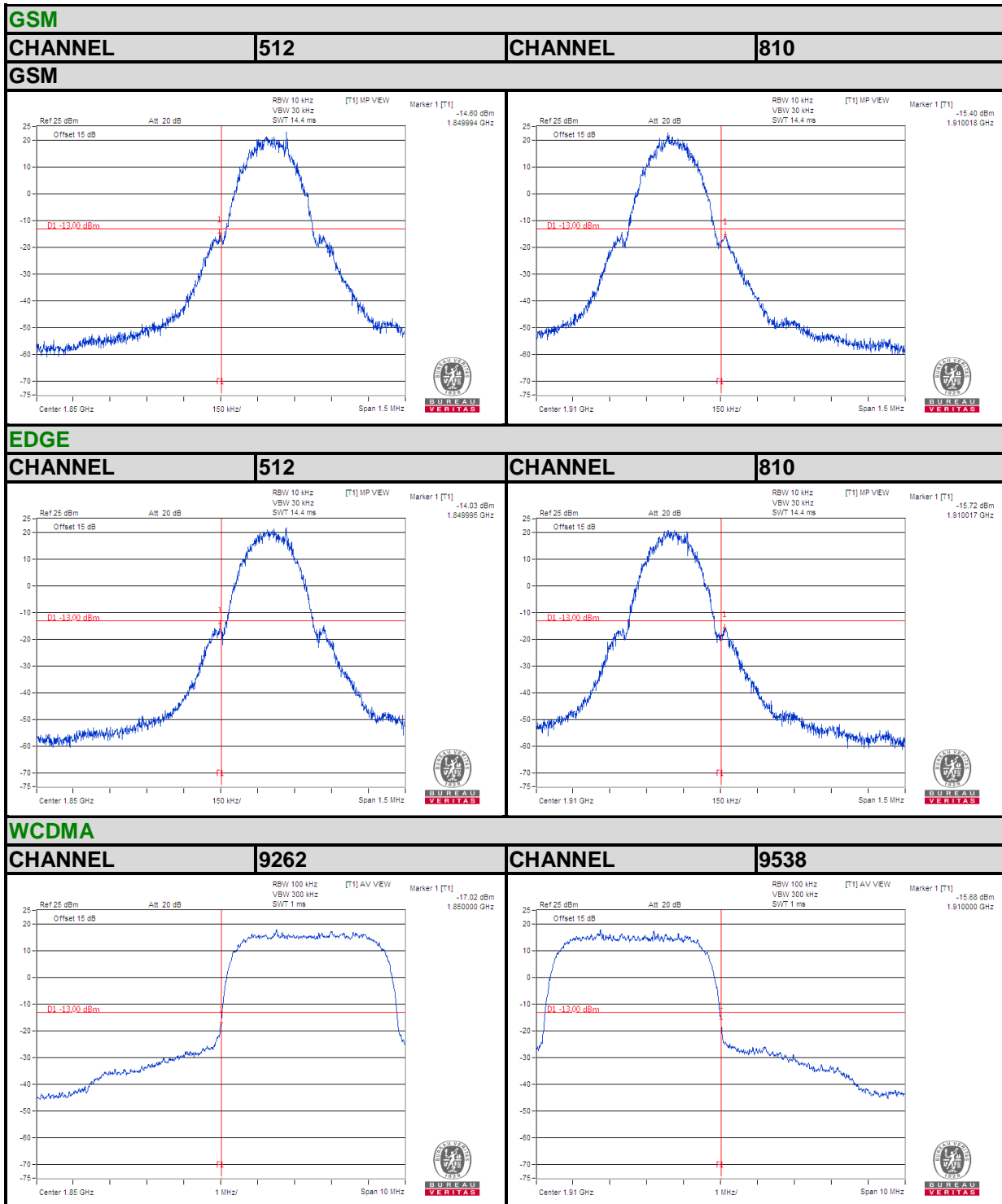

LTE BAND 2

Channel Bandwidth: 1.4MHz

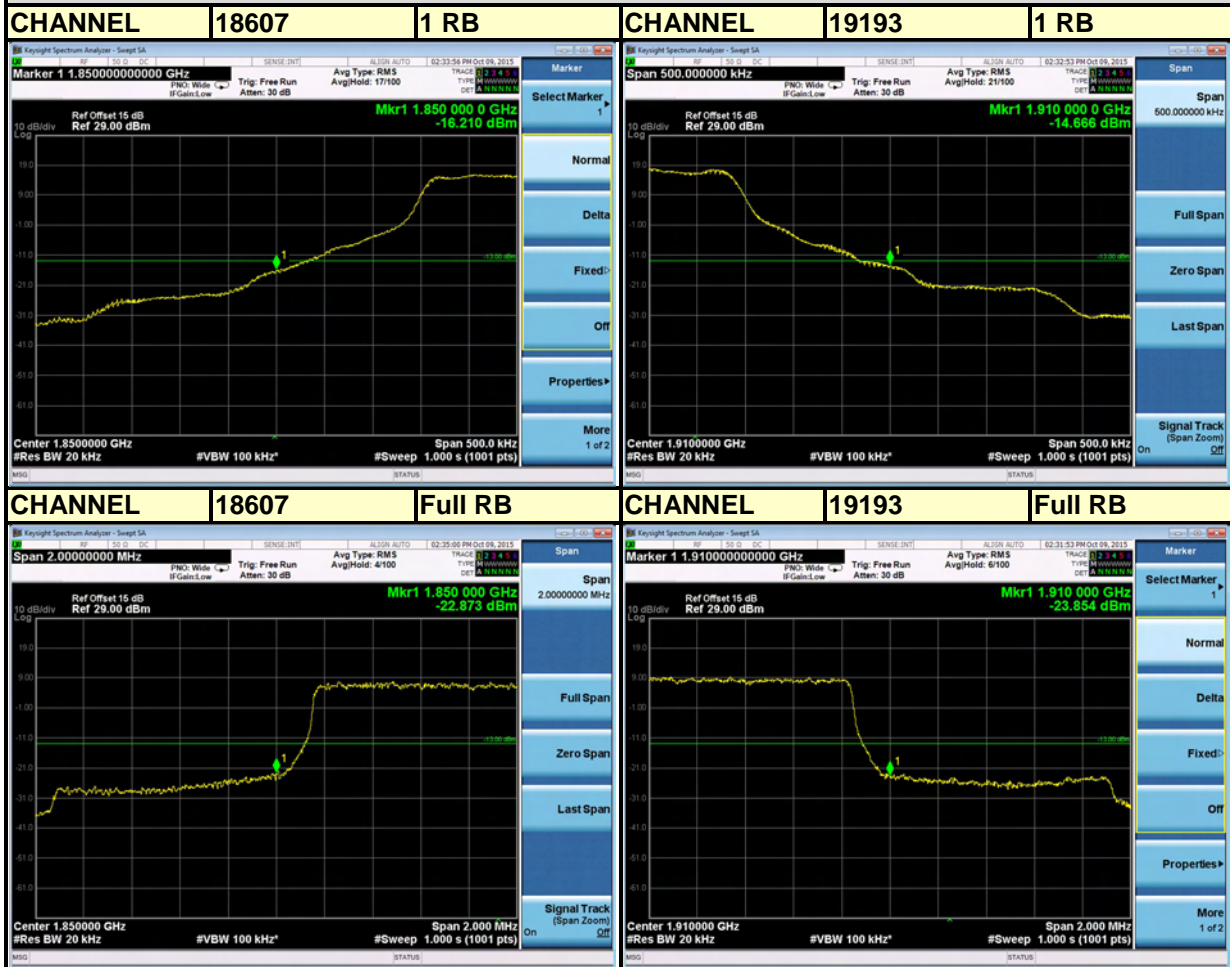

LTE BAND 2

Channel Bandwidth: 3MHz

