

FCC TEST REPORT (WLAN)

Report No.: RF150915W002-2

FCC ID: YCNA2010L36

Test Model: Lenovo A2010I36

Received Date: Sep. 15, 2015

Test Date: Sep. 16, 2015 ~ Oct. 12, 2015

Issued Date: Oct. 13, 2015

Applicant: Lenovo Mobile Communication Technology Ltd.

Address: No.999, Qishan North 2nd Road, Information & Optoelectronics Park, Torch Hi-tech Industry Development Zone, Xiamen, P.R. China

Issued By: Bureau Veritas Consumer Products Services (H.K.) Ltd., Taoyuan Branch

Lab Address: No. 47-2, 14th Ling, Chia Cau Vil., Lin Kou Dist., New Taipei City, Taiwan (R.O.C.)

Test Location: No. 19, Hwa Ya 2nd Rd., Wen Hwa Tsuen, Kwei Shan Hsiang, Taoyuan Hsien 333, Taiwan, R.O.C.

This report should not be used by the client to claim product certification, approval, or endorsement by TAF or any government agencies.



This report is for your exclusive use. Any copying or replication of this report to or for any other person or entity, or use of our name or trademark, is permitted only with our prior written permission. This report sets forth our findings solely with respect to the test samples identified herein. The results set forth in this report are not indicative or representative of the quality or characteristics of the lot from which a test sample was taken or any similar or identical product unless specifically and expressly noted. Our report includes all of the tests requested by you and the results thereof based upon the information that you provided to us. You have 60 days from date of issuance of this report to notify us of any material error or omission caused by our negligence, provided, however, that such notice shall be in writing and shall specifically address the issue you wish to raise. A failure to raise such issue within the prescribed time shall constitute your unqualified acceptance of the completeness of this report, the tests conducted and the correctness of the report contents. Unless specific mention, the uncertainty of measurement has been explicitly taken into account to declare the compliance or non-compliance to the specification. The report must not be used by the client to claim product certification, approval, or endorsement by TAF or any government agencies.

TABLE OF CONTENTS

RELEASE CONTROL RECORD	4
1 Certificate of Conformity.....	5
2 Summary of Test Results	6
2.1 Measurement Uncertainty	6
3 General Information.....	7
3.1 General Description of EUT	7
3.2 Description of Test Modes	8
3.2.1 Test Mode Applicability and Tested Channel Detail.....	9
3.3 Description of Support Units	11
3.3.1 Configuration of System under Test	11
3.4 General Description of Applied Standards	11
4 Test Types and Results	12
4.1 Radiated Emission and Bandedge Measurement.....	12
4.1.1 Limits of Radiated Emission and Bandedge Measurement	12
4.1.2 Test Instruments	13
4.1.3 Test Procedures.....	14
4.1.4 Deviation from Test Standard	14
4.1.5 Test Set Up	15
4.1.6 EUT Operating Conditions.....	15
4.1.7 Test Results	16
4.2 Conducted Emission Measurement	30
4.2.1 Limits of Conducted Emission Measurement	30
4.2.2 Test Instruments	30
4.2.3 Test Procedures.....	31
4.2.4 Deviation from Test Standard	31
4.2.5 Test Setup.....	31
4.2.6 EUT Operating Conditions.....	31
4.2.7 Test Results	32
4.3 6dB Bandwidth Measurement	34
4.3.1 Limits of 6dB Bandwidth Measurement.....	34
4.3.2 Test Setup.....	34
4.3.3 Test Instruments	34
4.3.4 Test Procedure	34
4.3.5 Deviation from Test Standard	34
4.3.6 EUT Operating Conditions.....	34
4.3.7 Test Result.....	35
4.4 Conducted Output Power Measurement.....	37
4.4.1 Limits of Conducted Output Power Measurement	37
4.4.2 Test Setup.....	37
4.4.3 Test Instruments	37
4.4.4 Test Procedures.....	37
4.4.5 Deviation from Test Standard	37
4.4.6 EUT Operating Conditions.....	37
4.4.7 Test Results	38
4.4.7.1 Maximum Peak Output Power	38
4.4.7.2 Average Output Power (For Reference)	39
4.5 Power Spectral Density Measurement.....	40
4.5.1 Limits of Power Spectral Density Measurement	40
4.5.2 Test Setup.....	40
4.5.3 Test Instruments	40
4.5.4 Test Procedure	40
4.5.5 Deviation from Test Standard	40
4.5.6 EUT Operating Condition	40



4.5.7 Test Results	41
4.6 Conducted Out of Band Emission Measurement.....	43
4.6.1 Limits of Conducted Out of Band Emission Measurement.....	43
4.6.2 Test Setup.....	43
4.6.3 Test Instruments	43
4.6.4 Test Procedure	43
4.6.5 Deviation from Test Standard	43
4.6.6 EUT Operating Condition	43
4.6.7 Test Results	44
5 Pictures of Test Arrangements.....	48
Appendix – Information on the Testing Laboratories	49



RELEASE CONTROL RECORD

ISSUE NO.	REASON FOR CHANGE	DATE ISSUED
RF150915W002-2	Original release	Oct. 13, 2015

1 Certificate of Conformity

Product: Lenovo Mobile Phone
Brand: Lenovo
Test Model: Lenovo A2010I36
Sample Status: Production unit
Applicant: Lenovo Mobile Communication Technology Ltd.
Test Date: Sep. 16, 2015 ~ Oct. 12, 2015
Standards: **FCC Part 15, Subpart C (Section 15.247)**
ANSI C63.10: 2013

The above equipment has been tested by **Bureau Veritas Consumer Products Services (H.K.) Ltd., Taoyuan Branch**, and found compliance with the requirement of the above standards. The test record, data evaluation & Equipment Under Test (EUT) configurations represented herein are true and accurate accounts of the measurements of the sample's EMC characteristics under the conditions specified in this report.

Prepared by :  _____, **Date:** _____ Oct. 13, 2015
Amyee Qian / Engineer

Approved by :  _____, **Date:** _____ Oct. 13, 2015
William Chung / Manager

2 Summary of Test Results

FCC Part 15, Subpart C (SECTION 15.247)			
FCC Clause	Test Item	Result	Remarks
15.207	AC Power Conducted Emission	PASS	Meet the requirement of limit. Minimum passing margin is -12.40dB at 0.39600MHz.
15.205 & 15.209	Band Edge Emission Measurement	PASS	Meet the requirement of limit. Minimum passing margin is -1.1dB at 2483.50MHz.
15.247(d)	Antenna Port Emission	PASS	Meet the requirement of limit.
15.247(a)(2)	6dB bandwidth	PASS	Meet the requirement of limit.
15.247(b)	Conducted power	PASS	Meet the requirement of limit.
15.247(e)	Power Spectral Density	PASS	Meet the requirement of limit.
15.203	Antenna Requirement	PASS	No antenna connector is used.

2.1 Measurement Uncertainty

Where relevant, the following measurement uncertainty levels have been estimated for tests performed on the EUT as specified in CISPR 16-4-2:

Measurement	Frequency	Expanded Uncertainty (k=2) (\pm)
Conducted Emissions at mains ports	9kHz ~ 30MHz	2.44 dB
Radiated Emissions up to 1 GHz	30MHz ~ 200MHz	2.93 dB
	200MHz ~ 1000MHz	2.95 dB
Radiated Emissions above 1 GHz	1GHz ~ 18GHz	2.26 dB
	18GHz ~ 40GHz	1.94 dB

This uncertainty represents an expanded uncertainty expressed at approximately the 95% confidence level using a coverage factor of $k = 2$.

3 General Information

3.1 General Description of EUT

Product	Lenovo Mobile Phone
Brand	Lenovo
Test Model	Lenovo A2010I36
Power Supply Rating	5.0Vdc (adapter or host equipment) 3.8Vdc (battery)
Modulation Technology	DSSS, OFDM
Modulation Type	CCK, DQPSK, DBPSK for DSSS 64QAM, 16QAM, QPSK, BPSK for OFDM
Transfer Rate	802.11b: 11/ 5.5/ 2.0 / 1.0 Mbps 802.11g: 54/ 48/ 36 / 24 / 18 / 9/ 6 Mbps 802.11n: up to 135 Mbps
Operating Frequency	2412 ~ 2462MHz for 11b/g/n(HT20) 2422 ~ 2452MHz for 11b/g/n(HT40)
Number of Channel	11 for 802.11b, 802.11g, 802.11n(20MHz) 7 for 802.11n(20MHz)
Output Power	49.659 mW
Antenna Type	PIFA Antenna with -2.8dBi gain
Accessory Device	Refer to note as below
Data Cable Supplied	USB cable: Unshielded, detachable, 0.7m Earphone cable: Unshielded, detachable,1.3m

Note:

- The above EUT information is declared by manufacturer and for more detailed features description, please refer to the manufacturer's specifications or User's Manual.
- The EUT incorporates a MIMO function. Physically, the EUT provides two completed transmitters and two receivers.

Modulation Mode	TX Function
802.11b	1TX /1RX
802.11g	1TX /1RX
802.11n (HT20)	1TX /1RX
802.11n (HT40)	1TX /1RX

- The EUT was powered by the following adapter:

ADAPTER	
BRAND:	Lenovo
MODEL:	C-P56
INPUT:	AC 100-240V, 0.13A
OUTPUT:	DC 5V, 1.0A
MANUFACTURER:	chenyang

- The EUT matched the following USB Cable and Earphone.

USB CABLE	
BRAND:	lenovo
MODEL:	L16W-05100070L
SIGNAL LINE:	0.7 METER

EARPHONE	
BRAND:	Lenovo
MODEL:	TS990B-28AMS05-M
SIGNAL LINE:	1.3 METER

- For the test results, the EUT had been tested with all conditions. But only the worst case was shown in test report.

3.2 Description of Test Modes

11 channels are provided for 802.11b, 802.11g and 802.11n (HT20):

Channel	Frequency	Channel	Frequency
1	2412MHz	7	2442MHz
2	2417MHz	8	2447MHz
3	2422MHz	9	2452MHz
4	2427MHz	10	2457MHz
5	2432MHz	11	2462MHz
6	2437MHz		

7 channels are provided for 802.11n (HT40):

Channel	Frequency	Channel	Frequency
3	2422MHz	7	2442MHz
4	2427MHz	8	2447MHz
5	2432MHz	9	2452MHz
6	2437MHz		

3.2.1 Test Mode Applicability and Tested Channel Detail

EUT CONFIGURE MODE	APPLICABLE TO				DESCRIPTION
	RE \geq 1G	RE<1G	PLC	APCM	
-	√	√	√	√	-

Where RE \geq 1G: Radiated Emission above 1GHz & Bandedge Measurement
 RE<1G: Radiated Emission below 1GHz
 PLC: Power Line Conducted Emission
 APCM: Antenna Port Conducted Measurement

NOTE: The EUT had been pre-tested on the positioned of each 3 axis. The worst case was found when positioned on **Y-plane**.
NOTE: "-" means no effect.

Radiated Emission Test (Above 1GHz):

- Pre-Scan has been conducted to determine the worst-case mode from all possible combinations between available modulations, data rates and antenna ports (if EUT with antenna diversity architecture).
- Following channel(s) was (were) selected for the final test as listed below.

EUT CONFIGURE MODE	MODE	AVAILABLE CHANNEL	TESTED CHANNEL	MODULATION TECHNOLOGY	MODULATION TYPE	DATA RATE (Mbps)
-	802.11b	1 to 11	1, 6, 11	DSSS	DBPSK	1.0
-	802.11g	1 to 11	1, 6, 11	OFDM	BPSK	6.0
-	802.11n (HT20)	1 to 11	1, 6, 11	OFDM	BPSK	7.2
-	802.11n (HT40)	3 to 9	3, 6, 9	OFDM	BPSK	15.0

Radiated Emission Test (Below 1GHz):

- Pre-Scan has been conducted to determine the worst-case mode from all possible combinations between available modulations, data rates and antenna ports (if EUT with antenna diversity architecture).
- Following channel(s) was (were) selected for the final test as listed below.

EUT CONFIGURE MODE	MODE	AVAILABLE CHANNEL	TESTED CHANNEL	MODULATION TECHNOLOGY	MODULATION TYPE	DATA RATE (Mbps)
-	802.11n (20MHz)	1 to 11	6	OFDM	BPSK	7.2

Power Line Conducted Emission Test:

- Pre-Scan has been conducted to determine the worst-case mode from all possible combinations between available modulations, data rates and antenna ports (if EUT with antenna diversity architecture).
- Following channel(s) was (were) selected for the final test as listed below.

EUT CONFIGURE MODE	MODE	AVAILABLE CHANNEL	TESTED CHANNEL	MODULATION TECHNOLOGY	MODULATION TYPE	DATA RATE (Mbps)
-	802.11b	1 to 11	1	DSSS	DBPSK	1.0

BANDEDGE MEASUREMENT:

- Pre-Scan has been conducted to determine the worst-case mode from all possible combinations between available modulations, data rates and antenna ports (if EUT with antenna diversity architecture).
- Following channel(s) was (were) selected for the final test as listed below.

EUT CONFIGURE MODE	MODE	AVAILABLE CHANNEL	TESTED CHANNEL	MODULATION TECHNOLOGY	MODULATION TYPE	DATA RATE (Mbps)
-	802.11b	1 to 11	1, 6, 11	DSSS	DBPSK	1.0
-	802.11g	1 to 11	1, 6, 11	OFDM	BPSK	6.0
-	802.11n (HT20)	1 to 11	1, 6, 11	OFDM	BPSK	7.2
-	802.11n (HT40)	3 to 9	3, 6, 9	OFDM	BPSK	15.0

Antenna Port Conducted Measurement:

- This item includes all test value of each mode, but only includes spectrum plot of worst value of each mode.
- Pre-Scan has been conducted to determine the worst-case mode from all possible combinations between available modulations, data rates and antenna ports (if EUT with antenna diversity architecture).
- Following channel(s) was (were) selected for the final test as listed below.

EUT CONFIGURE MODE	MODE	AVAILABLE CHANNEL	TESTED CHANNEL	MODULATION TECHNOLOGY	MODULATION TYPE	DATA RATE (Mbps)
-	802.11b	1 to 11	1, 6, 11	DSSS	DBPSK	1.0
-	802.11g	1 to 11	1, 6, 11	OFDM	BPSK	6.0
-	802.11n (HT20)	1 to 11	1, 6, 11	OFDM	BPSK	7.2
-	802.11n (HT40)	3 to 9	3, 6, 9	OFDM	BPSK	15.0

Test Condition:

APPLICABLE TO	ENVIRONMENTAL CONDITIONS	INPUT POWER	TESTED BY
RE≥1G	25deg. C, 65%RH	120Vac, 60Hz	Chris Lin
RE<1G	25deg. C, 65%RH	120Vac, 60Hz	Chris Lin
PLC	25deg. C, 68%RH	120Vac, 60Hz	Sun Lin
APCM	21deg. C, 60%RH	120Vac, 60Hz	Nick Chen

3.3 Description of Support Units

The EUT has been tested as an independent unit together with other necessary accessories or support units. The following support units or accessories were used to form a representative test configuration during the tests.

NO.	PRODUCT	BRAND	MODEL NO.	SERIAL NO.	FCC ID
1	DC source	LONG WEI	PS-6403D	010934269	N/A
2	PC	HP	A6608CN	3CR83825X3	N/A

NO.	SIGNAL CABLE DESCRIPTION OF THE ABOVE SUPPORT UNITS
1	DC Line: Unshielded, Detachable 1.0m
2	AC Line: Unshielded, Detachable 1.5m

3.3.1 Configuration of System under Test

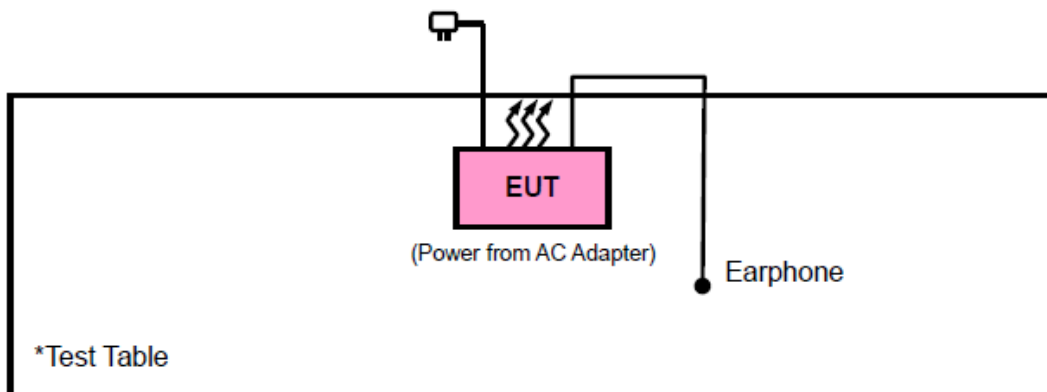

3.4 General Description of Applied Standards

The EUT is a RF Product. According to the specifications of the manufacturer, it must comply with the requirements of the following standards:

FCC Part 15, Subpart C (15.247)
558074 D01 DTS Meas Guidance v03r03
 ANSI C63.10-2013

All test items have been performed and recorded as per the above standards.

NOTE: The EUT has been verified to comply with the requirements of FCC Part 15, Subpart B, Class B (DoC). The test report has been issued separately.

4 Test Types and Results

4.1 Radiated Emission and Bandedge Measurement

4.1.1 Limits of Radiated Emission and Bandedge Measurement

Radiated emissions which fall in the restricted bands must comply with the radiated emission limits specified as below table. Other emissions shall be at least 20dB below the highest level of the desired power:

Frequencies (MHz)	Field Strength (microvolts/meter)	Measurement Distance (meters)
0.009 ~ 0.490	2400/F(kHz)	300
0.490 ~ 1.705	24000/F(kHz)	30
1.705 ~ 30.0	30	30
30 ~ 88	100	3
88 ~ 216	150	3
216 ~ 960	200	3
Above 960	500	3

NOTE:

1. The lower limit shall apply at the transition frequencies.
2. Emission level (dBuV/m) = 20 log Emission level (uV/m).
3. For frequencies above 1000MHz, the field strength limits are based on average detector, however, the peak field strength of any emission shall not exceed the maximum permitted average limits, specified above by more than 20dB under any condition of modulation.

4.1.2 Test Instruments

DESCRIPTION & MANUFACTURER	MODEL NO.	SERIAL NO.	DATE OF CALIBRATION	DUE DATE OF CALIBRATION
Spectrum Analyzer Agilent Technologies	N9038A	MY52260177	May 19, 2015	May 18, 2016
Spectrum Analyzer ROHDE & SCHWARZ	FSU43	101261	Dec. 10, 2014	Dec. 09, 2015
BILOG Antenna ETS-Lindgren	3142E	117536	Feb. 23, 2015	Feb. 22, 2016
HORN Antenna ETS-Lindgren	3117	00143293	Aug. 27, 2015	Aug. 26, 2016
Bluetooth Tester	CBT	100980	Apr. 27, 2015	Apr. 26, 2016
Agilent Communications Tester-Wireless	8960 Series 10	MY53201073	Jul. 06, 2015	Jul. 05, 2017
Preamplifier Agilent	310N	187226	Jun. 29, 2015	Jun. 28, 2016
Preamplifier Agilent	83017A	980116	Jan. 09, 2015	Jan. 08, 2016
Power Meter Anritsu	ML2495A	1232002	Sep. 16, 2015	Sep. 15, 2016
Power Sensor Anritsu	MA2411B	1207325	Sep. 16, 2015	Sep. 15, 2016
RF signal cable ETS-LINDGREN	5D-FB	Cable-CH1-01(R FC-SMS-100-SM S-120+RFC-SMS -100-SMS-400)	Jun. 27, 2015	Jun. 26, 2016
RF signal cable ETS-LINDGREN	8D-FB	Cable-CH1-02(R FC-SMS-100-SM S-24)	Jun. 27, 2015	Jun. 26, 2016
Software BV ADT	E38.130425b	NA	NA	NA
Antenna Tower MF	NA	NA	NA	NA
Turn Table MF	NA	NA	NA	NA
Antenna Tower & Turn Table Controller MF	MF-7802	NA	NA	NA

- NOTE:**
1. The calibration interval of the above test instruments is 12 months and the calibrations are traceable to NML/ROC and NIST/USA.
 2. The calibration interval of the loop antenna is 24 months and the calibrations are traceable to NML/ROC and NIST/USA.
 3. The test was performed in HwaYa Chamber 4.
 4. The horn antenna and HP preamplifier (model: 8449B) are used only for the measurement of emission frequency above 1GHz if tested.
 5. The FCC Site Registration No. is 460141.
 6. The IC Site Registration No. is IC7450F-4.

4.1.3 Test Procedures

- a. The EUT was placed on the top of a rotating table 0.8 meters (for below 1GHz) / 1.5 meters (for above 1GHz) above the ground at 3 meter chamber room for test. The table was rotated 360 degrees to determine the position of the highest radiation.
- b. The EUT was set 3 meters away from the interference-receiving antenna, which was mounted on the top of a variable-height antenna tower.
- c. The height of antenna is varied from one meter to four meters above the ground to determine the maximum value of the field strength. Both horizontal and vertical polarizations of the antenna are set to make the measurement.
- d. For each suspected emission, the EUT was arranged to its worst case and then the antenna was tuned to heights from 1 meter to 4 meters and the rotatable table was turned from 0 degrees to 360 degrees to find the maximum reading.
- e. The test-receiver system was set to quasi-peak detect function and specified bandwidth with maximum hold mode when the test frequency is below 1 GHz.
- f. The test-receiver system was set to peak and average detect function and specified bandwidth with maximum hold mode when the test frequency is above 1 GHz. If the peak reading value also meets average limit, measurement with the average detector is unnecessary.

Note:

1. The resolution bandwidth and video bandwidth of test receiver/spectrum analyzer is 120kHz for Quasi-peak detection (QP) at frequency below 1GHz.
2. The resolution bandwidth of test receiver/spectrum analyzer is 1 MHz and the video bandwidth is 3 MHz for Peak detection (PK) at frequency above 1GHz.
3. The resolution bandwidth of test receiver/spectrum analyzer is 1MHz and the video bandwidth is 3MHz for RMS Average (Duty cycle < 98%) for Average detection (AV) at frequency above 1GHz, then the measurement results was added to a correction factor ($10 \log(1/\text{duty cycle})$).
4. The resolution bandwidth of test receiver/spectrum analyzer is 1MHz and the video bandwidth is 10Hz (Duty cycle $\geq 98\%$) for Average detection (AV) at frequency above 1GHz.
5. All modes of operation were investigated and the worst-case emissions are reported.

4.1.4 Deviation from Test Standard

No deviation.

4.1.5 Test Set Up

<Frequency Range below 1GHz>

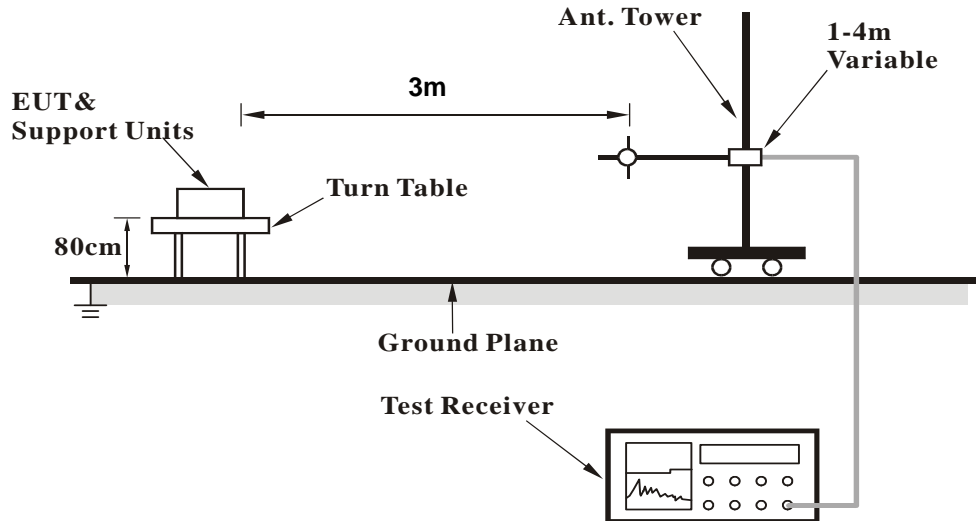

<Frequency Range above 1GHz>

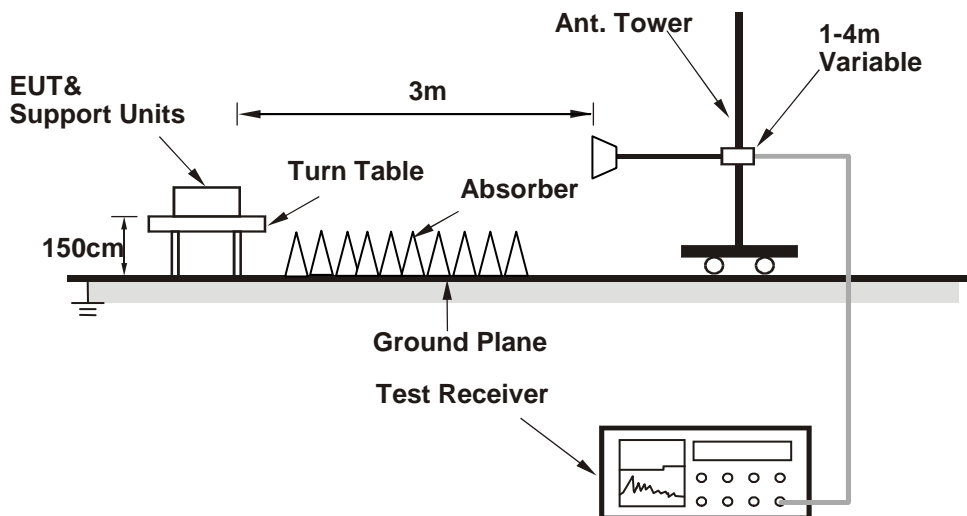

For the actual test configuration, please refer to the attached file (Test Setup Photo).

4.1.6 EUT Operating Conditions

- Placed the EUT on the testing table.
- Use the software to control the EUT under transmission condition continuously at specific channel frequency.

4.1.7 Test Results

BELOW 1GHz WORST-CASE DATA:

802.11n (20MHz)

CHANNEL	TX Channel 6	DETECTOR FUNCTION	Quasi-Peak (QP)
FREQUENCY RANGE	30MHz ~ 1GHz		

ANTENNA POLARITY & TEST DISTANCE: HORIZONTAL AT 3 M								
NO.	FREQ. (MHz)	EMISSION LEVEL (dBUV/m)	LIMIT (dBUV/m)	MARGIN (dB)	ANTENNA HEIGHT (m)	TABLE ANGLE (Degree)	RAW VALUE (dBUV)	CORRECTION FACTOR (dB/m)
1	30.00	22.0 QP	40.0	-18.0	1.00 H	0	40.22	-18.21
2	58.13	20.1 QP	40.0	-19.9	1.00 H	0	48.55	-28.47
3	107.60	9.5 QP	43.5	-34.0	1.00 H	0	36.24	-26.74
4	197.81	13.8 QP	43.5	-29.7	1.00 H	0	37.61	-23.81
5	243.40	17.2 QP	46.0	-28.8	1.00 H	0	38.77	-21.59
6	325.85	16.1 QP	46.0	-29.9	1.00 H	0	35.44	-19.33

REMARKS:

1. Emission Level(dBuV/m) = Raw Value(dBuV) + Correction Factor(dB/m)
2. Correction Factor(dB/m) = Antenna Factor(dB/m) + Cable Factor(dB) – Pre-Amplifier Factor(dB)
3. The other emission levels were very low against the limit.
4. Margin value = Emission Level – Limit value

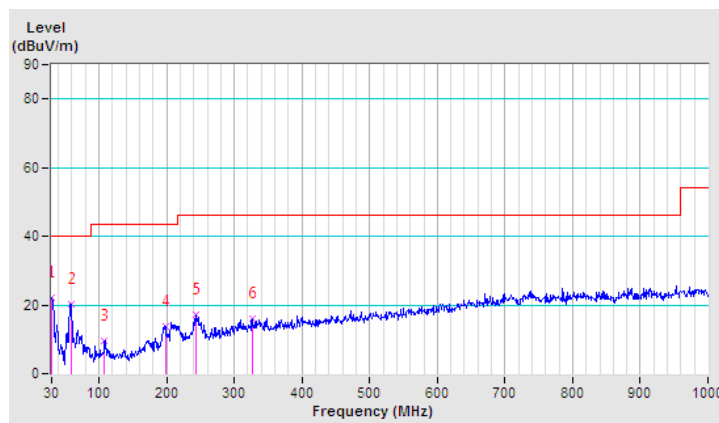

CHANNEL	TX Channel 6	DETECTOR FUNCTION	Quasi-Peak (QP)
FREQUENCY RANGE	30MHz ~ 1GHz		

ANTENNA POLARITY & TEST DISTANCE: VERTICAL AT 3 M								
NO.	FREQ. (MHz)	EMISSION LEVEL (dBuV/m)	LIMIT (dBuV/m)	MARGIN (dB)	ANTENNA HEIGHT (m)	TABLE ANGLE (Degree)	RAW VALUE (dBuV)	CORRECTION FACTOR (dB/m)
1	31.94	33.4 QP	40.0	-6.7	1.00 V	0	52.88	-19.53
2	37.76	28.8 QP	40.0	-11.2	1.00 V	0	52.28	-23.47
3	54.25	23.1 QP	40.0	-17.0	1.00 V	0	51.58	-28.53
4	106.63	18.4 QP	43.5	-25.1	1.00 V	0	45.11	-26.71
5	164.83	10.3 QP	43.5	-33.2	1.00 V	0	34.20	-23.88
6	211.39	13.5 QP	43.5	-30.0	1.00 V	0	36.69	-23.22

REMARKS:

1. Emission Level(dBuV/m) = Raw Value(dBuV) + Correction Factor(dB/m)
2. Correction Factor(dB/m) = Antenna Factor(dB/m) + Cable Factor(dB) – Pre-Amplifier Factor(dB)
3. The other emission levels were very low against the limit.
4. Margin value = Emission Level – Limit value

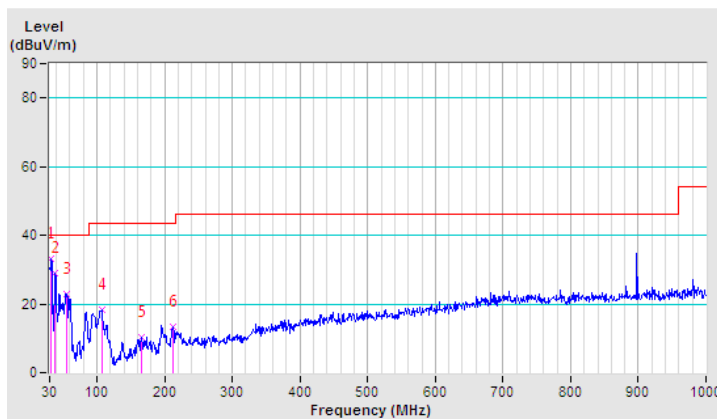

ABOVE 1GHz DATA

802.11b

CHANNEL	TX Channel 1	DETECTOR FUNCTION	Peak (PK)
FREQUENCY RANGE	1GHz ~ 25GHz		Average (AV)

ANTENNA POLARITY & TEST DISTANCE: HORIZONTAL AT 3 M

NO.	FREQ. (MHz)	EMISSION LEVEL (dBuV/m)	LIMIT (dBuV/m)	MARGIN (dB)	ANTENNA HEIGHT (m)	TABLE ANGLE (Degree)	RAW VALUE (dBuV)	CORRECTION FACTOR (dB/m)
1	#2390.00	57.2 PK	74.0	-16.8	1.48 H	185	61.06	-3.86
2	#2390.00	43.4 AV	54.0	-10.6	1.48 H	185	47.26	-3.86
3	#2400.00	68.6 PK	87.2	-18.6	1.48 H	185	72.44	-3.84
4	#2400.00	63.4 AV	86.0	-22.6	1.48 H	185	67.24	-3.84
5	*2412.00	107.2 PK			1.48 H	185	111.03	-3.83
6	*2412.00	106.0 AV			1.48 H	185	109.83	-3.83
7	#4824.00	60.9 PK	74.0	-13.1	1.00 H	0	61.49	-0.59
8	#4824.00	51.9 AV	54.0	-2.1	1.00 H	0	52.49	-0.59

ANTENNA POLARITY & TEST DISTANCE: VERTICAL AT 3 M

NO.	FREQ. (MHz)	EMISSION LEVEL (dBuV/m)	LIMIT (dBuV/m)	MARGIN (dB)	ANTENNA HEIGHT (m)	TABLE ANGLE (Degree)	RAW VALUE (dBuV)	CORRECTION FACTOR (dB/m)
1	#2390.00	57.1 PK	74.0	-16.9	1.00 V	49	60.96	-3.86
2	#2390.00	45.7 AV	54.0	-8.3	1.00 V	49	49.56	-3.86
3	#2400.00	69.9 PK	87.9	-18.0	1.00 V	49	73.74	-3.84
4	#2400.00	66.2 AV	86.6	-20.4	1.00 V	49	70.04	-3.84
5	*2412.00	107.9 PK			1.00 V	49	111.73	-3.83
6	*2412.00	106.6 AV			1.00 V	49	110.43	-3.83
7	#4824.00	60.8 PK	74.0	-13.2	N/A V	N/A	61.39	-0.59
8	#4824.00	50.7 AV	54.0	-3.3	N/A V	N/A	51.29	-0.59

REMARKS:

1. Emission Level(dBuV/m) = Raw Value(dBuV) + Correction Factor(dB/m)
2. Correction Factor(dB/m) = Antenna Factor(dB/m) + Cable Factor(dB) – Pre-Amplifier Factor(dB)
3. The other emission levels were very low against the limit.
4. Margin value = Emission Level – Limit value
5. " * ": Fundamental frequency.
6. " # ": The radiated frequency is out of the restricted band.

CHANNEL	TX Channel 6	DETECTOR FUNCTION	Peak (PK)
FREQUENCY RANGE	1GHz ~ 25GHz		Average (AV)

ANTENNA POLARITY & TEST DISTANCE: HORIZONTAL AT 3 M								
NO.	FREQ. (MHz)	EMISSION LEVEL (dBuV/m)	LIMIT (dBuV/m)	MARGIN (dB)	ANTENNA HEIGHT (m)	TABLE ANGLE (Degree)	RAW VALUE (dBuV)	CORRECTION FACTOR (dB/m)
1	*2437.00	90.0 PK			1.08 H	145	86.68	3.32
2	*2437.00	85.6 AV			1.08 H	145	82.28	3.32
3	4874.00	46.7 PK	74.0	-27.3	1.00 H	184	37.18	9.52
4	4874.00	32.5 AV	54.0	-21.5	1.00 H	184	22.98	9.52
5	7311.00	49.5 PK	74.0	-24.5	1.00 H	360	37.64	11.86
6	7311.00	34.4 AV	54.0	-19.6	1.00 H	360	22.54	11.86

ANTENNA POLARITY & TEST DISTANCE: VERTICAL AT 3 M								
NO.	FREQ. (MHz)	EMISSION LEVEL (dBuV/m)	LIMIT (dBuV/m)	MARGIN (dB)	ANTENNA HEIGHT (m)	TABLE ANGLE (Degree)	RAW VALUE (dBuV)	CORRECTION FACTOR (dB/m)
1	*2437.00	90.7 PK			1.00 V	314	87.38	3.32
2	*2437.00	85.8 AV			1.00 V	314	82.48	3.32
3	4874.00	46.5 PK	74.0	-27.5	1.00 V	119	36.98	9.52
4	4874.00	32.4 AV	54.0	-21.6	1.00 V	119	22.88	9.52
5	7311.00	48.9 PK	74.0	-25.1	1.00 V	141	37.04	11.86
6	7311.00	34.2 AV	54.0	-19.8	1.00 V	141	22.34	11.86

REMARKS:

1. Emission Level(dBuV/m) = Raw Value(dBuV) + Correction Factor(dB/m)
2. Correction Factor(dB/m) = Antenna Factor(dB/m) + Cable Factor(dB) – Pre-Amplifier Factor(dB)
3. The other emission levels were very low against the limit.
4. Margin value = Emission Level – Limit value
5. " * ": Fundamental frequency.
6. " # ": The radiated frequency is out of the restricted band.

CHANNEL	TX Channel 11	DETECTOR FUNCTION	Peak (PK)
FREQUENCY RANGE	1GHz ~ 25GHz		Average (AV)

ANTENNA POLARITY & TEST DISTANCE: HORIZONTAL AT 3 M								
NO.	FREQ. (MHz)	EMISSION LEVEL (dBuV/m)	LIMIT (dBuV/m)	MARGIN (dB)	ANTENNA HEIGHT (m)	TABLE ANGLE (Degree)	RAW VALUE (dBuV)	CORRECTION FACTOR (dB/m)
1	*2462.00	89.4 PK			1.23 H	142	86.01	3.39
2	*2462.00	85.1 AV			1.23 H	142	81.71	3.39
3	2483.50	49.2 PK	74.0	-24.8	1.23 H	142	45.73	3.47
4	2483.50	37.2 AV	54.0	-16.8	1.23 H	142	33.73	3.47
5	4924.00	46.7 PK	74.0	-27.3	1.00 H	169	37.10	9.60
6	4924.00	32.3 AV	54.0	-21.7	1.00 H	169	22.70	9.60
7	7386.00	49.5 PK	74.0	-24.5	1.00 H	121	37.69	11.81
8	7386.00	34.4 AV	54.0	-19.6	1.00 H	121	22.59	11.81

ANTENNA POLARITY & TEST DISTANCE: VERTICAL AT 3 M								
NO.	FREQ. (MHz)	EMISSION LEVEL (dBuV/m)	LIMIT (dBuV/m)	MARGIN (dB)	ANTENNA HEIGHT (m)	TABLE ANGLE (Degree)	RAW VALUE (dBuV)	CORRECTION FACTOR (dB/m)
1	*2462.00	89.6 PK			1.11 V	10	86.21	3.39
2	*2462.00	84.9 AV			1.11 V	10	81.51	3.39
3	2483.50	49.7 PK	74.0	-24.3	1.11 V	10	46.23	3.47
4	2483.50	37.2 AV	54.0	-16.8	1.11 V	10	33.73	3.47
5	4924.00	46.4 PK	74.0	-27.6	1.00 V	211	36.80	9.60
6	4924.00	32.3 AV	54.0	-21.7	1.00 V	211	22.70	9.60
7	7386.00	49.7 PK	74.0	-24.3	1.00 V	233	37.89	11.81
8	7386.00	34.6 AV	54.0	-19.4	1.00 V	233	22.79	11.81

REMARKS:

1. Emission Level(dBuV/m) = Raw Value(dBuV) + Correction Factor(dB/m)
2. Correction Factor(dB/m) = Antenna Factor(dB/m) + Cable Factor(dB) – Pre-Amplifier Factor(dB)
3. The other emission levels were very low against the limit.
4. Margin value = Emission Level – Limit value
5. " * ": Fundamental frequency.
6. " # ": The radiated frequency is out of the restricted band.

802.11g

CHANNEL	TX Channel 1	DETECTOR FUNCTION	Peak (PK)
FREQUENCY RANGE	1GHz ~ 25GHz		Average (AV)

ANTENNA POLARITY & TEST DISTANCE: HORIZONTAL AT 3 M								
NO.	FREQ. (MHz)	EMISSION LEVEL (dBuV/m)	LIMIT (dBuV/m)	MARGIN (dB)	ANTENNA HEIGHT (m)	TABLE ANGLE (Degree)	RAW VALUE (dBuV)	CORRECTION FACTOR (dB/m)
1	#2390.00	70.9 PK	74.0	-3.1	1.48 H	181	74.76	-3.86
2	#2390.00	50.4 AV	54.0	-3.6	1.48 H	181	54.26	-3.86
3	#2400.00	81.4 PK	90.7	-9.3	1.48 H	181	85.24	-3.84
4	#2400.00	70.5 AV	80.9	-10.4	1.48 H	181	74.34	-3.84
5	*2412.00	110.7 PK			1.48 H	181	114.53	-3.83
6	*2412.00	100.9 AV			1.48 H	181	104.73	-3.83
7	#4824.00	57.0 PK	74.0	-17.0	1.00 H	0	57.59	-0.59
8	#4824.00	45.1 AV	54.0	-8.9	1.00 H	0	45.69	-0.59
ANTENNA POLARITY & TEST DISTANCE: VERTICAL AT 3 M								
NO.	FREQ. (MHz)	EMISSION LEVEL (dBuV/m)	LIMIT (dBuV/m)	MARGIN (dB)	ANTENNA HEIGHT (m)	TABLE ANGLE (Degree)	RAW VALUE (dBuV)	CORRECTION FACTOR (dB/m)
1	#2390.00	66.9 PK	74.0	-7.1	1.00 V	261	70.76	-3.86
2	#2390.00	46.7 AV	54.0	-7.3	1.00 V	261	50.56	-3.86
3	#2400.00	81.4 PK	89.3	-7.9	1.00 V	261	85.24	-3.84
4	#2400.00	67.6 AV	79.8	-12.2	1.00 V	261	71.44	-3.84
5	*2412.00	109.3 PK			1.00 V	261	113.13	-3.83
6	*2412.00	99.8 AV			1.00 V	261	103.63	-3.83
7	#4824.00	56.8 PK	74.0	-17.2	1.00 V	0	57.39	-0.59
8	#4824.00	44.7 AV	54.0	-9.3	1.00 V	0	45.29	-0.59

REMARKS:

1. Emission Level(dBuV/m) = Raw Value(dBuV) + Correction Factor(dB/m)
2. Correction Factor(dB/m) = Antenna Factor(dB/m) + Cable Factor(dB) – Pre-Amplifier Factor(dB)
3. The other emission levels were very low against the limit.
4. Margin value = Emission Level – Limit value
5. " * ": Fundamental frequency.
6. " # ": The radiated frequency is out of the restricted band.

CHANNEL	TX Channel 6	DETECTOR FUNCTION	Peak (PK)
FREQUENCY RANGE	1GHz ~ 25GHz		Average (AV)

ANTENNA POLARITY & TEST DISTANCE: HORIZONTAL AT 3 M								
NO.	FREQ. (MHz)	EMISSION LEVEL (dBuV/m)	LIMIT (dBuV/m)	MARGIN (dB)	ANTENNA HEIGHT (m)	TABLE ANGLE (Degree)	RAW VALUE (dBuV)	CORRECTION FACTOR (dB/m)
1	*2437.00	108.9 PK			1.50 H	190	112.69	-3.79
2	*2437.00	99.6 AV			1.50 H	190	103.39	-3.79
3	#4874.00	53.5 PK	74.0	-20.5	1.00 H	0	54.11	-0.61
4	#4874.00	41.9 AV	54.0	-12.1	1.00 H	0	42.51	-0.61
5	#7311.00	56.8 PK	74.0	-17.2	1.00 H	0	53.53	3.27
6	#7311.00	44.6 AV	54.0	-9.4	1.00 H	0	41.33	3.27

ANTENNA POLARITY & TEST DISTANCE: VERTICAL AT 3 M								
NO.	FREQ. (MHz)	EMISSION LEVEL (dBuV/m)	LIMIT (dBuV/m)	MARGIN (dB)	ANTENNA HEIGHT (m)	TABLE ANGLE (Degree)	RAW VALUE (dBuV)	CORRECTION FACTOR (dB/m)
1	*2437.00	108.4 PK			1.00 V	266	112.19	-3.79
2	*2437.00	98.1 AV			1.00 V	266	101.89	-3.79
3	#4874.00	53.9 PK	74.0	-20.1	1.00 V	0	54.51	-0.61
4	#4874.00	41.6 AV	54.0	-12.4	1.00 V	0	42.21	-0.61
5	#7311.00	56.4 PK	74.0	-17.6	1.00 V	0	53.13	3.27
6	#7311.00	44.3 AV	54.0	-9.7	1.00 V	0	41.03	3.27

REMARKS:

1. Emission Level(dBuV/m) = Raw Value(dBuV) + Correction Factor(dB/m)
2. Correction Factor(dB/m) = Antenna Factor(dB/m) + Cable Factor(dB) – Pre-Amplifier Factor(dB)
3. The other emission levels were very low against the limit.
4. Margin value = Emission Level – Limit value
5. " * ": Fundamental frequency.
6. " # ": The radiated frequency is out of the restricted band.

CHANNEL	TX Channel 11	DETECTOR FUNCTION	Peak (PK)
FREQUENCY RANGE	1GHz ~ 25GHz		Average (AV)

ANTENNA POLARITY & TEST DISTANCE: HORIZONTAL AT 3 M								
NO.	FREQ. (MHz)	EMISSION LEVEL (dBuV/m)	LIMIT (dBuV/m)	MARGIN (dB)	ANTENNA HEIGHT (m)	TABLE ANGLE (Degree)	RAW VALUE (dBuV)	CORRECTION FACTOR (dB/m)
1	*2462.00	109.9 PK			1.74 H	170	113.66	-3.76
2	*2462.00	100.4 AV			1.74 H	170	104.16	-3.76
3	#2483.50	69.1 PK	74.0	-4.9	1.74 H	170	72.83	-3.73
4	#2483.50	50.0 AV	54.0	-4.0	1.74 H	170	53.73	-3.73
5	#4924.00	54.5 PK	74.0	-19.5	1.00 H	0	55.13	-0.63
6	#4924.00	42.4 AV	54.0	-11.6	1.00 H	0	43.03	-0.63
7	#7386.00	57.0 PK	74.0	-17.0	1.00 H	0	53.55	3.45
8	#7386.00	44.6 AV	54.0	-9.4	1.00 H	0	41.15	3.45

ANTENNA POLARITY & TEST DISTANCE: VERTICAL AT 3 M								
NO.	FREQ. (MHz)	EMISSION LEVEL (dBuV/m)	LIMIT (dBuV/m)	MARGIN (dB)	ANTENNA HEIGHT (m)	TABLE ANGLE (Degree)	RAW VALUE (dBuV)	CORRECTION FACTOR (dB/m)
1	*2462.00	108.6 PK			1.00 V	206	112.36	-3.76
2	*2462.00	98.7 AV			1.00 V	206	102.46	-3.76
3	#2483.50	65.7 PK	74.0	-8.3	1.00 V	206	69.43	-3.73
4	#2483.50	46.5 AV	54.0	-7.5	1.00 V	206	50.23	-3.73
5	#4924.00	54.1 PK	74.0	-19.9	1.00 V	0	54.73	-0.63
6	#4924.00	42.1 AV	54.0	-11.9	1.00 V	0	42.73	-0.63
7	#7386.00	56.8 PK	74.0	-17.2	1.00 V	0	53.35	3.45
8	#7386.00	44.9 AV	54.0	-9.1	1.00 V	0	41.45	3.45

REMARKS:

1. Emission Level(dBuV/m) = Raw Value(dBuV) + Correction Factor(dB/m)
2. Correction Factor(dB/m) = Antenna Factor(dB/m) + Cable Factor(dB) – Pre-Amplifier Factor(dB)
3. The other emission levels were very low against the limit.
4. Margin value = Emission Level – Limit value
5. " * ": Fundamental frequency.
6. " # ": The radiated frequency is out of the restricted band.

802.11n (20MHz)

CHANNEL	TX Channel 1	DETECTOR FUNCTION	Peak (PK)
FREQUENCY RANGE	1GHz ~ 25GHz		Average (AV)

ANTENNA POLARITY & TEST DISTANCE: HORIZONTAL AT 3 M								
NO.	FREQ. (MHz)	EMISSION LEVEL (dBuV/m)	LIMIT (dBuV/m)	MARGIN (dB)	ANTENNA HEIGHT (m)	TABLE ANGLE (Degree)	RAW VALUE (dBuV)	CORRECTION FACTOR (dB/m)
1	#2390.00	70.7 PK	74.0	-3.3	1.81 H	25	74.56	-3.86
2	#2390.00	51.3 AV	54.0	-2.7	1.81 H	25	55.16	-3.86
3	#2400.00	85.7 PK	89.8	-4.1	1.81 H	25	89.54	-3.84
4	#2400.00	68.2 AV	80.2	-12.0	1.81 H	25	72.04	-3.84
5	*2412.00	109.8 PK			1.81 H	25	113.63	-3.83
6	*2412.00	100.2 AV			1.81 H	25	104.03	-3.83
7	#4824.00	56.7 PK	74.0	-17.3	1.00 H	0	57.29	-0.59
8	#4824.00	43.4 AV	54.0	-10.6	1.00 H	0	43.99	-0.59
ANTENNA POLARITY & TEST DISTANCE: VERTICAL AT 3 M								
NO.	FREQ. (MHz)	EMISSION LEVEL (dBuV/m)	LIMIT (dBuV/m)	MARGIN (dB)	ANTENNA HEIGHT (m)	TABLE ANGLE (Degree)	RAW VALUE (dBuV)	CORRECTION FACTOR (dB/m)
1	#2390.00	67.4 PK	74.0	-6.6	1.00 V	172	71.26	-3.86
2	#2390.00	48.6 AV	54.0	-5.4	1.00 V	172	52.46	-3.86
3	#2400.00	83.3 PK	88.9	-5.6	1.00 V	172	87.14	-3.84
4	#2400.00	65.7 AV	78.9	-13.2	1.00 V	172	69.54	-3.84
5	*2412.00	108.9 PK			1.00 V	172	112.73	-3.83
6	*2412.00	98.9 AV			1.00 V	172	102.73	-3.83
7	#4824.00	55.4 PK	74.0	-18.6	1.00 V	0	55.99	-0.59
8	#4824.00	43.2 AV	54.0	-10.8	1.00 V	0	43.79	-0.59

REMARKS:

1. Emission Level(dBuV/m) = Raw Value(dBuV) + Correction Factor(dB/m)
2. Correction Factor(dB/m) = Antenna Factor(dB/m) + Cable Factor(dB) – Pre-Amplifier Factor(dB)
3. The other emission levels were very low against the limit.
4. Margin value = Emission Level – Limit value
5. " * ": Fundamental frequency.
6. " # ": The radiated frequency is out of the restricted band.

CHANNEL	TX Channel 6	DETECTOR FUNCTION	Peak (PK)
FREQUENCY RANGE	1GHz ~ 25GHz		Average (AV)

ANTENNA POLARITY & TEST DISTANCE: HORIZONTAL AT 3 M								
NO.	FREQ. (MHz)	EMISSION LEVEL (dBuV/m)	LIMIT (dBuV/m)	MARGIN (dB)	ANTENNA HEIGHT (m)	TABLE ANGLE (Degree)	RAW VALUE (dBuV)	CORRECTION FACTOR (dB/m)
1	*2437.00	107.4 PK			1.46 H	231	111.19	-3.79
2	*2437.00	96.1 AV			1.46 H	231	99.89	-3.79
3	#4874.00	55.6 PK	74.0	-18.4	1.00 H	0	56.21	-0.61
4	#4874.00	42.0 AV	54.0	-12.0	1.00 H	0	42.61	-0.61
5	#7311.00	57.8 PK	74.0	-16.2	1.00 H	0	54.53	3.27
6	#7311.00	45.1 AV	54.0	-8.9	1.00 H	0	41.83	3.27

ANTENNA POLARITY & TEST DISTANCE: VERTICAL AT 3 M								
NO.	FREQ. (MHz)	EMISSION LEVEL (dBuV/m)	LIMIT (dBuV/m)	MARGIN (dB)	ANTENNA HEIGHT (m)	TABLE ANGLE (Degree)	RAW VALUE (dBuV)	CORRECTION FACTOR (dB/m)
1	*2437.00	108.6 PK			1.00 V	166	112.39	-3.79
2	*2437.00	98.4 AV			1.00 V	166	102.19	-3.79
3	#4874.00	55.1 PK	74.0	-18.9	1.00 V	0	55.71	-0.61
4	#4874.00	41.9 AV	54.0	-12.1	1.00 V	0	42.51	-0.61
5	#7311.00	57.5 PK	74.0	-16.5	1.00 V	0	54.23	3.27
6	#7311.00	44.9 AV	54.0	-9.1	1.00 V	0	41.63	3.27

REMARKS:

1. Emission Level(dBuV/m) = Raw Value(dBuV) + Correction Factor(dB/m)
2. Correction Factor(dB/m) = Antenna Factor(dB/m) + Cable Factor(dB) – Pre-Amplifier Factor(dB)
3. The other emission levels were very low against the limit.
4. Margin value = Emission Level – Limit value
5. " * ": Fundamental frequency.
6. " # ": The radiated frequency is out of the restricted band.

CHANNEL	TX Channel 11	DETECTOR FUNCTION	Peak (PK)
FREQUENCY RANGE	1GHz ~ 25GHz		Average (AV)

ANTENNA POLARITY & TEST DISTANCE: HORIZONTAL AT 3 M

NO.	FREQ. (MHz)	EMISSION LEVEL (dBuV/m)	LIMIT (dBuV/m)	MARGIN (dB)	ANTENNA HEIGHT (m)	TABLE ANGLE (Degree)	RAW VALUE (dBuV)	CORRECTION FACTOR (dB/m)
1	*2462.00	109.3 PK			1.46 H	179	113.06	-3.76
2	*2462.00	98.8 AV			1.46 H	179	102.56	-3.76
3	#2483.50	65.6 PK	74.0	-8.4	1.46 H	179	69.33	-3.73
4	#2483.50	48.1 AV	54.0	-5.9	1.46 H	179	51.83	-3.73
5	#4924.00	54.6 PK	74.0	-19.4	1.00 H	0	55.23	-0.63
6	#4924.00	43.0 AV	54.0	-11.0	1.00 H	0	43.63	-0.63
7	#7386.00	57.6 PK	74.0	-16.4	1.00 H	0	54.15	3.45
8	#7386.00	45.2 AV	54.0	-8.8	1.00 H	0	41.75	3.45

ANTENNA POLARITY & TEST DISTANCE: VERTICAL AT 3 M

NO.	FREQ. (MHz)	EMISSION LEVEL (dBuV/m)	LIMIT (dBuV/m)	MARGIN (dB)	ANTENNA HEIGHT (m)	TABLE ANGLE (Degree)	RAW VALUE (dBuV)	CORRECTION FACTOR (dB/m)
1	*2462.00	106.5 PK			1.00 V	167	110.26	-3.76
2	*2462.00	95.9 AV			1.00 V	167	99.66	-3.76
3	#2483.50	60.8 PK	74.0	-13.2	1.00 V	167	64.53	-3.73
4	#2483.50	45.8 AV	54.0	-8.2	1.00 V	167	49.53	-3.73
5	#4924.00	54.5 PK	74.0	-19.5	1.00 V	0	55.13	-0.63
6	#4924.00	42.1 AV	54.0	-11.9	1.00 V	0	42.73	-0.63
7	#7386.00	57.0 PK	74.0	-17.0	1.00 V	0	53.55	3.45
8	#7386.00	45.0 AV	54.0	-9.0	1.00 V	0	41.55	3.45

REMARKS:

1. Emission Level(dBuV/m) = Raw Value(dBuV) + Correction Factor(dB/m)
2. Correction Factor(dB/m) = Antenna Factor(dB/m) + Cable Factor(dB) – Pre-Amplifier Factor(dB)
3. The other emission levels were very low against the limit.
4. Margin value = Emission Level – Limit value
5. " * ": Fundamental frequency.
6. " # ": The radiated frequency is out of the restricted band.

802.11n (40MHz)

CHANNEL	TX Channel 3	DETECTOR FUNCTION	Peak (PK)
FREQUENCY RANGE	1GHz ~ 25GHz		Average (AV)

ANTENNA POLARITY & TEST DISTANCE: HORIZONTAL AT 3 M								
NO.	FREQ. (MHz)	EMISSION LEVEL (dBuV/m)	LIMIT (dBuV/m)	MARGIN (dB)	ANTENNA HEIGHT (m)	TABLE ANGLE (Degree)	RAW VALUE (dBuV)	CORRECTION FACTOR (dB/m)
1	#2390.00	68.2 PK	74.0	-5.8	1.48 H	180	72.06	-3.86
2	#2390.00	51.4 AV	54.0	-2.6	1.48 H	180	55.26	-3.86
3	#2400.00	70.1 PK	83.5	-13.4	1.48 H	180	73.94	-3.84
4	#2400.00	58.1 AV	73.7	-15.6	1.48 H	180	61.94	-3.84
5	*2422.00	103.5 PK			1.48 H	180	107.32	-3.82
6	*2422.00	93.7 AV			1.48 H	180	97.52	-3.82
7	#4844.00	54.1 PK	74.0	-19.9	N/A H	N/A	54.70	-0.60
8	#4844.00	42.3 AV	54.0	-11.7	N/A H	N/A	42.90	-0.60
ANTENNA POLARITY & TEST DISTANCE: VERTICAL AT 3 M								
NO.	FREQ. (MHz)	EMISSION LEVEL (dBuV/m)	LIMIT (dBuV/m)	MARGIN (dB)	ANTENNA HEIGHT (m)	TABLE ANGLE (Degree)	RAW VALUE (dBuV)	CORRECTION FACTOR (dB/m)
1	#2390.00	62.9 PK	74.0	-11.1	1.00 V	249	66.76	-3.86
2	#2390.00	47.9 AV	54.0	-6.1	1.00 V	249	51.76	-3.86
3	#2400.00	67.0 PK	82.8	-15.8	1.00 V	249	70.84	-3.84
4	#2400.00	55.9 AV	73.0	-17.1	1.00 V	249	59.74	-3.84
5	*2422.00	102.8 PK			1.00 V	360	106.62	-3.82
6	*2422.00	93.0 AV			1.00 V	360	96.82	-3.82
7	#4844.00	53.6 PK	74.0	-20.4	1.00 V	0	54.20	-0.60
8	#4844.00	41.8 AV	54.0	-12.2	1.00 V	0	42.40	-0.60

REMARKS:

1. Emission Level(dBuV/m) = Raw Value(dBuV) + Correction Factor(dB/m)
2. Correction Factor(dB/m) = Antenna Factor(dB/m) + Cable Factor(dB) – Pre-Amplifier Factor(dB)
3. The other emission levels were very low against the limit.
4. Margin value = Emission Level – Limit value
5. " * ": Fundamental frequency.
6. " # ": The radiated frequency is out of the restricted band.

CHANNEL	TX Channel 6	DETECTOR FUNCTION	Peak (PK)
FREQUENCY RANGE	1GHz ~ 25GHz		Average (AV)

ANTENNA POLARITY & TEST DISTANCE: HORIZONTAL AT 3 M								
NO.	FREQ. (MHz)	EMISSION LEVEL (dBuV/m)	LIMIT (dBuV/m)	MARGIN (dB)	ANTENNA HEIGHT (m)	TABLE ANGLE (Degree)	RAW VALUE (dBuV)	CORRECTION FACTOR (dB/m)
1	*2437.00	106.3 PK			1.50 H	168	110.09	-3.79
2	*2437.00	96.2 AV			1.50 H	168	99.99	-3.79
3	#4874.00	53.8 PK	74.0	-20.2	1.00 H	0	54.41	-0.61
4	#4874.00	42.6 AV	54.0	-11.4	1.00 H	0	43.21	-0.61
5	#7311.00	58.7 PK	74.0	-15.3	1.00 H	0	55.43	3.27
6	#7311.00	44.9 AV	54.0	-9.1	1.00 H	0	41.63	3.27

ANTENNA POLARITY & TEST DISTANCE: VERTICAL AT 3 M								
NO.	FREQ. (MHz)	EMISSION LEVEL (dBuV/m)	LIMIT (dBuV/m)	MARGIN (dB)	ANTENNA HEIGHT (m)	TABLE ANGLE (Degree)	RAW VALUE (dBuV)	CORRECTION FACTOR (dB/m)
1	*2437.00	105.4 PK			1.00 V	86	109.19	-3.79
2	*2437.00	95.6 AV			1.00 V	86	99.39	-3.79
3	#4874.00	53.6 PK	74.0	-20.4	1.00 V	0	54.21	-0.61
4	#4874.00	41.8 AV	54.0	-12.2	1.00 V	0	42.41	-0.61
5	#7311.00	58.4 PK	74.0	-15.6	1.00 V	0	55.13	3.27
6	#7311.00	44.2 AV	54.0	-9.8	1.00 V	0	40.93	3.27

REMARKS:

1. Emission Level(dBuV/m) = Raw Value(dBuV) + Correction Factor(dB/m)
2. Correction Factor(dB/m) = Antenna Factor(dB/m) + Cable Factor(dB) – Pre-Amplifier Factor(dB)
3. The other emission levels were very low against the limit.
4. Margin value = Emission Level – Limit value
5. " * ": Fundamental frequency.
6. " # ": The radiated frequency is out of the restricted band.

CHANNEL	TX Channel 9	DETECTOR FUNCTION	Peak (PK)
FREQUENCY RANGE	1GHz ~ 25GHz		Average (AV)

ANTENNA POLARITY & TEST DISTANCE: HORIZONTAL AT 3 M								
NO.	FREQ. (MHz)	EMISSION LEVEL (dBuV/m)	LIMIT (dBuV/m)	MARGIN (dB)	ANTENNA HEIGHT (m)	TABLE ANGLE (Degree)	RAW VALUE (dBuV)	CORRECTION FACTOR (dB/m)
1	*2452.00	106.5 PK			1.46 H	180	110.28	-3.78
2	*2452.00	96.6 AV			1.46 H	180	100.38	-3.78
3	#2483.50	66.4 PK	74.0	-7.6	1.46 H	180	70.13	-3.73
4	#2483.50	52.9 AV	54.0	-1.1	1.46 H	180	56.63	-3.73
5	#4904.00	55.1 PK	74.0	-18.9	1.00 H	0	55.72	-0.62
6	#4904.00	42.3 AV	54.0	-11.7	1.00 H	0	42.92	-0.62
7	#7356.00	58.4 PK	74.0	-15.6	1.00 H	0	55.02	3.38
8	#7356.00	45.6 AV	54.0	-8.4	1.00 H	0	42.22	3.38
ANTENNA POLARITY & TEST DISTANCE: VERTICAL AT 3 M								
NO.	FREQ. (MHz)	EMISSION LEVEL (dBuV/m)	LIMIT (dBuV/m)	MARGIN (dB)	ANTENNA HEIGHT (m)	TABLE ANGLE (Degree)	RAW VALUE (dBuV)	CORRECTION FACTOR (dB/m)
1	*2452.00	105.9 PK			1.00 V	23	109.68	-3.78
2	*2452.00	96.1 AV			1.00 V	23	99.88	-3.78
3	#2483.50	65.8 PK	74.0	-8.2	1.00 V	23	69.53	-3.73
4	#2483.50	52.2 AV	54.0	-1.8	1.00 V	23	55.93	-3.73
5	#4904.00	54.0 PK	74.0	-20.0	1.00 V	0	54.62	-0.62
6	#4904.00	41.8 AV	54.0	-12.2	1.00 V	0	42.42	-0.62
7	#7356.00	57.8 PK	74.0	-16.2	1.00 V	0	54.42	3.38
8	#7356.00	45.1 AV	54.0	-8.9	1.00 V	0	41.72	3.38

REMARKS:

1. Emission Level(dBuV/m) = Raw Value(dBuV) + Correction Factor(dB/m)
2. Correction Factor(dB/m) = Antenna Factor(dB/m) + Cable Factor(dB) – Pre-Amplifier Factor(dB)
3. The other emission levels were very low against the limit.
4. Margin value = Emission Level – Limit value
5. " * ": Fundamental frequency.
6. " # ": The radiated frequency is out of the restricted band.

4.2 Conducted Emission Measurement

4.2.1 Limits of Conducted Emission Measurement

Frequency (MHz)	Conducted Limit (dBuV)	
	Quasi-peak	Average
0.15 - 0.5	66 - 56	56 - 46
0.50 - 5.0	56	46
5.0 - 30.0	60	50

- NOTE:** 1. The lower limit shall apply at the transition frequencies.
 2. The limit decreases in line with the logarithm of the frequency in the range of 0.15 to 0.50MHz.
 3. All emanations from a class A/B digital device or system, including any network of conductors and apparatus connected thereto, shall not exceed the level of field strengths specified above.

4.2.2 Test Instruments

Description & Manufacturer	Model No.	Serial No.	Date Of Calibration	Due Date Of Calibration
Test Receiver ROHDE & SCHWARZ	ESCI	100613	Nov. 11, 2014	Nov. 10, 2015
RF signal cable Woken	5D-FB	Cable-HYC01-01	Dec. 26, 2014	Dec. 25, 2015
LISN ROHDE & SCHWARZ (EUT)	ESH3-Z5	835239/001	Feb. 26, 2015	Feb. 25, 2016
LISN ROHDE & SCHWARZ (Peripheral)	ESH3-Z5	100311	Jul. 24, 2015	Jul. 23, 2016
Software ADT	BV ADT_Cond_ V7.3.7.3	NA	NA	NA

- NOTE:** 1. The calibration interval of the above test instruments is 12 months and the calibrations are traceable to NML/ROC and NIST/USA.
 2. The test was performed in HwaYa Shielded Room 1.
 3. The VCCI Site Registration No. is C-2040.

4.2.3 Test Procedures

- a. The EUT was placed 0.4 meters from the conducting wall of the shielded room with EUT being connected to the power mains through a line impedance stabilization network (LISN). Other support units were connected to the power mains through another LISN. The two LISNs provide 50 ohm/ 50uH of coupling impedance for the measuring instrument.
- b. Both lines of the power mains connected to the EUT were checked for maximum conducted interference.
- c. The frequency range from 150kHz to 30MHz was searched. Emission levels under (Limit - 20dB) was not recorded.

NOTE: All modes of operation were investigated and the worst-case emissions are reported.

4.2.4 Deviation from Test Standard

No deviation.

4.2.5 Test Setup

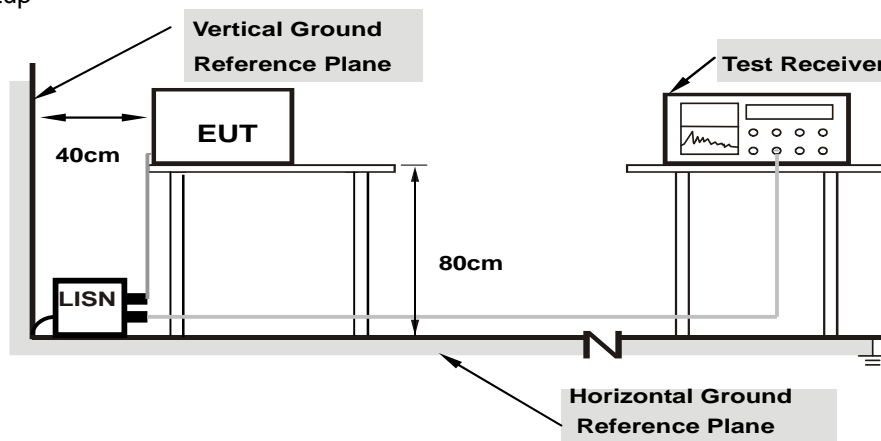

Note: 1.Support units were connected to second LISN.

For the actual test configuration, please refer to the attached file (Test Setup Photo).

4.2.6 EUT Operating Conditions

Same as 4.1.6.

4.2.7 Test Results

Phase	Line (L)	Detector Function	Quasi-Peak (QP) / Average (AV)				
Frequency (MHz)	QuasiPeak (dBuV)	CAverage (dBuV)	Limit (dBuV)	Margin (dB)	Line	Filter	Corr. (dB)
0.196000	---	30.01	53.78	-23.77	L	ON	9.7
0.196000	43.19	---	63.78	-20.59	L1	ON	9.7
0.396000	---	35.54	47.94	-12.40	L	ON	9.7
0.396000	41.65	---	57.94	-16.29	L	ON	9.7
0.496000	---	26.05	46.07	-20.02	L	ON	9.7
0.496000	35.83	---	56.07	-20.24	L	ON	9.7
1.036000	---	23.00	46.00	-23.00	L	ON	9.7
1.036000	36.83	---	56.00	-19.17	L	ON	9.7
1.332000	---	28.09	46.00	-17.91	L	ON	9.7
1.332000	36.60	---	56.00	-19.40	L	ON	9.7
2.472000	---	27.74	46.00	-18.26	L	ON	9.7
2.472000	34.04	---	56.00	-21.96	L	ON	9.7

- REMARKS:**
1. Q.P. and AV. are abbreviations of quasi-peak and average individually.
 2. "-": The Quasi-peak reading value also meets average limit and measurement with the average detector is unnecessary.
 3. The emission levels of other frequencies were very low against the limit.
 4. Margin value = Emission level - Limit value
 5. Correction factor = Insertion loss + Cable loss
 6. Emission Level = Correction Factor + Reading Value.

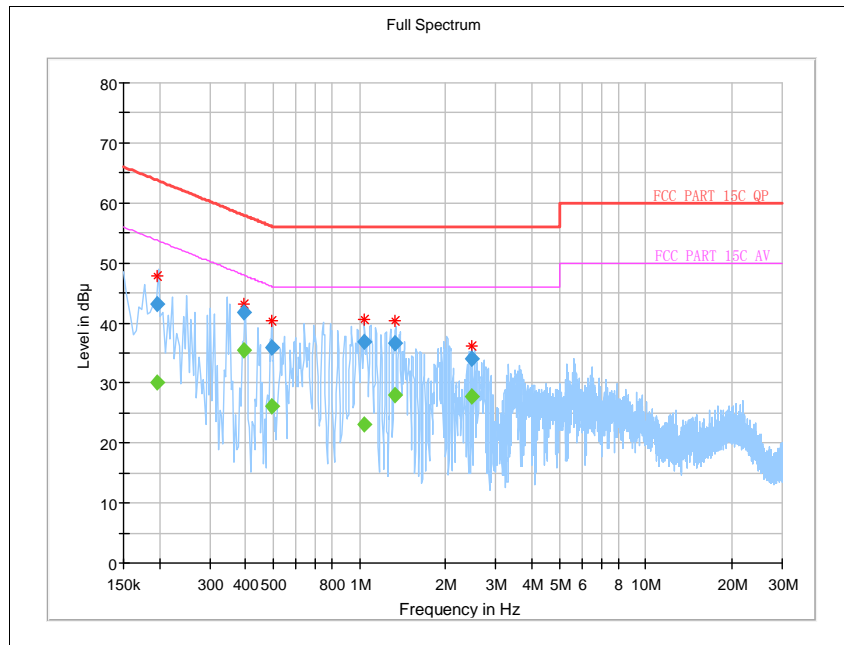

Phase	Neutral (N)	Detector Function	Quasi-Peak (QP) / Average (AV)
-------	-------------	-------------------	--------------------------------

Frequency (MHz)	QuasiPeak (dBuV)	CAverage (dBuV)	Limit (dBuV)	Margin (dB)	Line	Filter	Corr. (dB)
0.150000	---	35.81	56.00	-20.19	N	ON	9.8
0.150000	52.56	---	66.00	-13.44	N	ON	9.8
0.296000	---	31.49	50.35	-18.86	N	ON	10.0
0.296000	46.80	---	60.35	-13.55	N	ON	10.0
0.476000	---	24.43	46.41	-21.98	N	ON	10.1
0.476000	43.56	---	56.41	-12.85	N	ON	10.1
0.792000	---	29.85	46.00	-16.15	N	ON	10.0
0.792000	40.68	---	56.00	-15.32	N	ON	10.0
1.936000	---	28.40	46.00	-17.60	N	ON	9.8
1.936000	36.62	---	56.00	-19.38	N	ON	9.8
2.076000	---	26.19	46.00	-19.81	N	ON	9.8
2.076000	36.41	---	56.00	-19.59	N	ON	9.8

- REMARKS:**
1. Q.P. and AV. are abbreviations of quasi-peak and average individually.
 2. "-": The Quasi-peak reading value also meets average limit and measurement with the average detector is unnecessary.
 3. The emission levels of other frequencies were very low against the limit.
 4. Margin value = Emission level - Limit value
 5. Correction factor = Insertion loss + Cable loss
 6. Emission Level = Correction Factor + Reading Value.

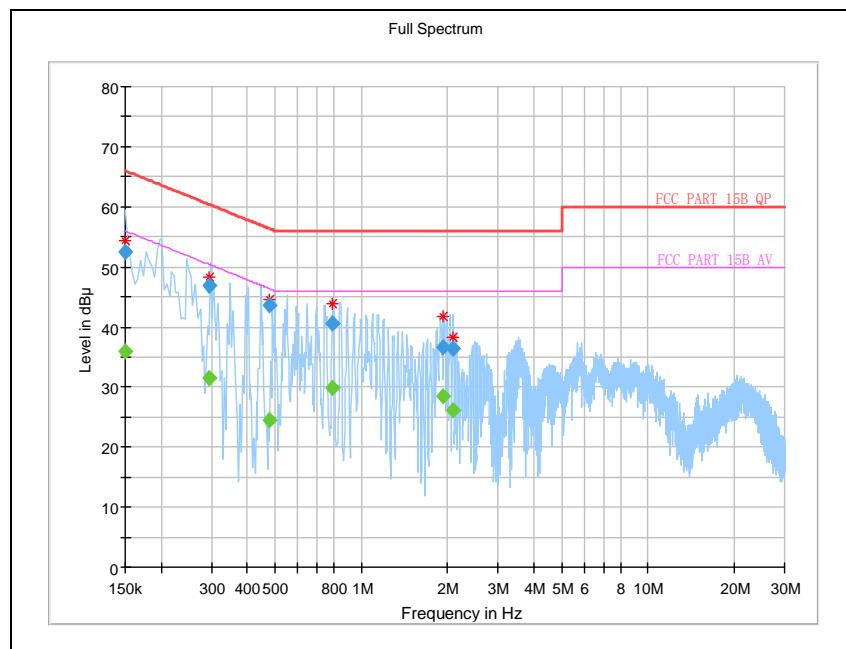

4.3 6dB Bandwidth Measurement

4.3.1 Limits of 6dB Bandwidth Measurement

The minimum of 6dB Bandwidth Measurement is 0.5 MHz.

4.3.2 Test Setup

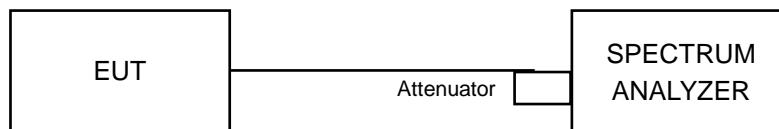

4.3.3 Test Instruments

Refer to section 4.1.2 to get information of above instrument.

4.3.4 Test Procedure

- a. Set resolution bandwidth (RBW) = 100kHz
- b. Set the video bandwidth (VBW) $\geq 3 \times$ RBW, Detector = Peak.
- c. Trace mode = max hold.
- d. Sweep = auto couple.
- e. Measure the maximum width of the emission that is constrained by the frequencies associated with the two amplitude points (upper and lower) that are attenuated by 6 dB relative to the maximum level measured in the fundamental emission

4.3.5 Deviation from Test Standard

No deviation.

4.3.6 EUT Operating Conditions

The software provided by client to enable the EUT under transmission condition continuously at lowest, middle and highest channel frequencies individually.

4.3.7 Test Result

802.11b

Channel	Frequency (MHz)	6db Bandwidth (MHz)	Minimum Limit (MHz)	Pass / Fail
1	2412	8.12	0.5	PASS
6	2437	8.60	0.5	PASS
11	2462	9.60	0.5	PASS

802.11g

Channel	Frequency (MHz)	6db Bandwidth (MHz)	Minimum Limit (MHz)	Pass / Fail
1	2412	13.17	0.5	PASS
6	2437	15.15	0.5	PASS
11	2462	16.57	0.5	PASS

802.11n (HT20)

Channel	Frequency (MHz)	6db Bandwidth (MHz)	Minimum Limit (MHz)	Pass / Fail
1	2412	14.17	0.5	Pass
6	2437	15.41	0.5	Pass
11	2462	17.81	0.5	Pass

802.11n (HT40)

Channel	Frequency (MHz)	6db Bandwidth (MHz)	Minimum Limit (MHz)	Pass / Fail
3	2422	31.13	0.5	Pass
6	2437	35.27	0.5	Pass
9	2452	34.55	0.5	Pass

Spectrum Plot of Worst Value

802.11b

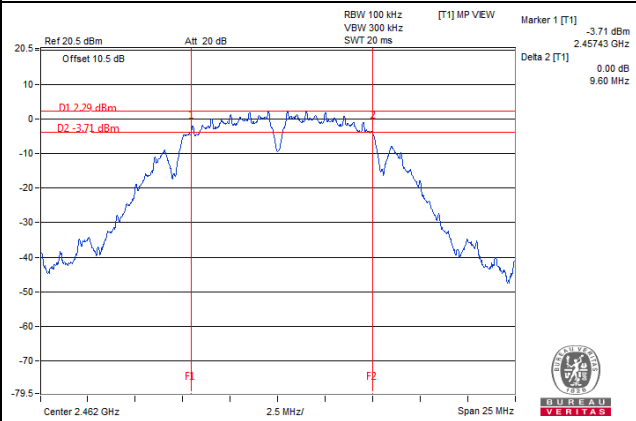

802.11g

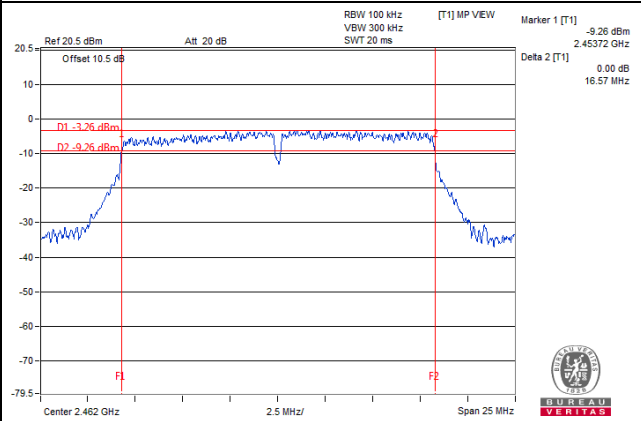

802.11n (HT20)

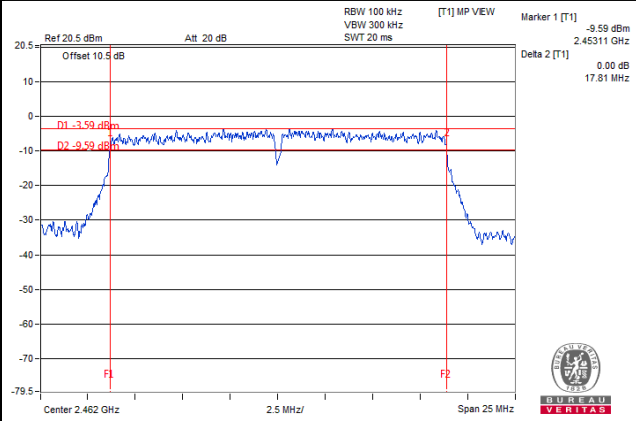

802.11n (HT40)

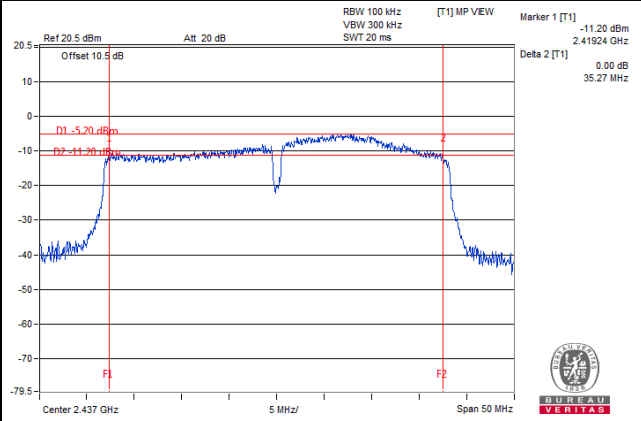

4.4 Conducted Output Power Measurement

4.4.1 Limits of Conducted Output Power Measurement

For systems using digital modulation in the 2400–2483.5 MHz bands: 1 Watt (30dBm)

4.4.2 Test Setup

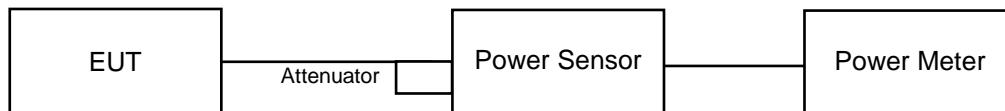

4.4.3 Test Instruments

Refer to section 4.1.2 to get information of above instrument.

4.4.4 Test Procedures

A peak / average power sensor was used on the output port of the EUT. A power meter was used to read the response of the peak / average power sensor. Record the power level.

4.4.5 Deviation from Test Standard

No deviation.

4.4.6 EUT Operating Conditions

Same as Item 4.3.6.

4.4.7 Test Results

4.4.7.1 Maximum Peak Output Power

802.11b

CHANNEL	CHANNEL FREQUENCY (MHz)	PEAK POWER (dBm)	PEAK POWER (mW)	PEAK POWER LIMIT (W)	PASS/FAIL
1	2412	15.14	32.659	1	PASS
6	2437	15.63	36.559	1	PASS
11	2462	15.23	33.343	1	PASS

802.11g

CHANNEL	CHANNEL FREQUENCY (MHz)	PEAK POWER (dBm)	PEAK POWER (mW)	PEAK POWER LIMIT (W)	PASS/FAIL
1	2412	16.12	40.926	1	PASS
6	2437	16.76	47.424	1	PASS
11	2462	16.59	45.604	1	PASS

802.11n (20MHz)

CHANNEL	CHANNEL FREQUENCY (MHz)	PEAK POWER (dBm)	PEAK POWER (mW)	PEAK POWER LIMIT (W)	PASS/FAIL
1	2412	16.08	40.551	1	PASS
6	2437	16.96	49.659	1	PASS
11	2462	16.75	47.315	1	PASS

802.11n (40MHz)

CHANNEL	CHANNEL FREQUENCY (MHz)	PEAK POWER (dBm)	PEAK POWER (mW)	PEAK POWER LIMIT (W)	PASS/FAIL
3	2422	16.07	40.458	1	PASS
6	2437	16.25	42.170	1	PASS
9	2452	16.16	41.305	1	PASS

4.4.7.2 Average Output Power (For Reference)

The average power sensor was used on the output port of the EUT. A power meter was used to read the response of the power sensor. Record the power level.

802.11b

CHANNEL	CHANNEL FREQUENCY (MHz)	AVERAGE POWER (dBm)	PASS/FAIL
1	2412	11.97	N/A
6	2437	12.48	N/A
11	2462	12.06	N/A

802.11g

CHANNEL	CHANNEL FREQUENCY (MHz)	AVERAGE POWER (dBm)	PASS/FAIL
1	2412	9.78	N/A
6	2437	10.26	N/A
11	2462	10.09	N/A

802.11n (20MHz)

CHANNEL	CHANNEL FREQUENCY (MHz)	AVERAGE POWER (dBm)	PASS/FAIL
1	2412	9.62	N/A
6	2437	10.29	N/A
11	2462	10.05	N/A

802.11n (40MHz)

CHANNEL	CHANNEL FREQUENCY (MHz)	AVERAGE POWER (dBm)	PASS/FAIL
3	2422	9.14	N/A
6	2437	9.48	N/A
9	2452	9.37	N/A

4.5 Power Spectral Density Measurement

4.5.1 Limits of Power Spectral Density Measurement

The Maximum of Power Spectral Density Measurement is 8dBm.

4.5.2 Test Setup

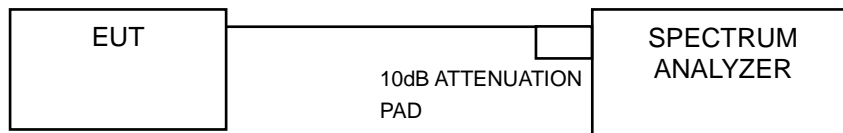

4.5.3 Test Instruments

Refer to section 4.1.2 to get information of above instrument.

4.5.4 Test Procedure

- Set analyzer center frequency to DTS channel center frequency.
- Set the span to 1.5 times the DTS bandwidth.
- Set the RBW to: $3 \text{ kHz} \leq \text{RBW} \leq 100 \text{ kHz}$.
- Set the VBW $\geq 3 \times \text{RBW}$.
- Detector = peak.
- Sweep time = auto couple.
- Trace mode = max hold.
- Allow trace to fully stabilize.
- Use the peak marker function to determine the maximum amplitude level within the RBW.

4.5.5 Deviation from Test Standard

No deviation.

4.5.6 EUT Operating Condition

Same as Item 4.3.6

4.5.7 Test Results

802.11b

Channel	Freq. (MHz)	PSD (dBm/3kHz)	Limit (dBm)	Pass /Fail
1	2412	-10.58	8	Pass
6	2437	-9.16	8	Pass
11	2462	-9.89	8	Pass

802.11g

Channel	Freq. (MHz)	PSD (dBm/3kHz)	Limit (dBm)	Pass /Fail
1	2412	-12.92	8	Pass
6	2437	-11.39	8	Pass
11	2462	-13.10	8	Pass

802.11n (HT20)

Channel	Freq. (MHz)	PSD (dBm/3kHz)	Limit (dBm)	Pass /Fail
1	2412	-14.14	8	Pass
6	2437	-12.54	8	Pass
11	2462	-13.22	8	Pass

802.11n (HT40)

Channel	Freq. (MHz)	PSD (dBm/3kHz)	Limit (dBm)	PASS /FAIL
3	2422	-15.85	8	PASS
6	2437	-14.87	8	PASS
9	2452	-14.90	8	PASS

Spectrum Plot of Worst Value

802.11b

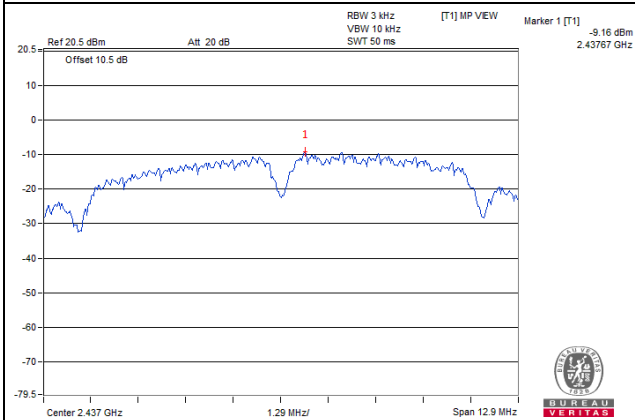

802.11g

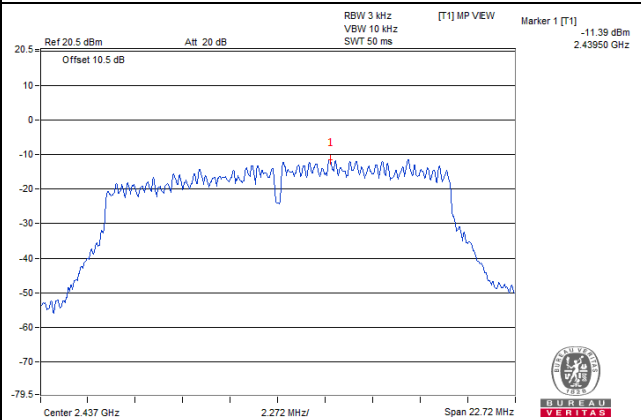

802.11n (HT20)

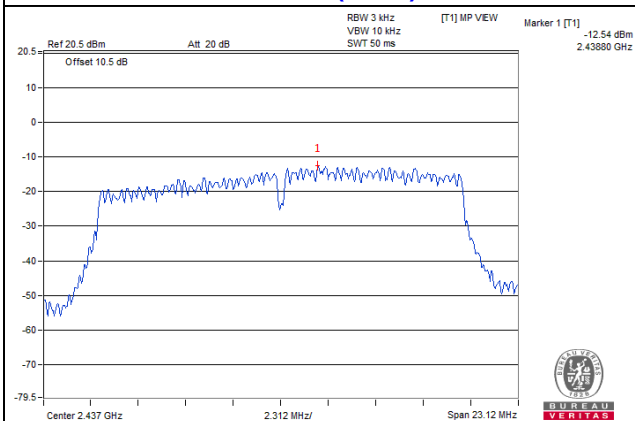

802.11n (HT40)

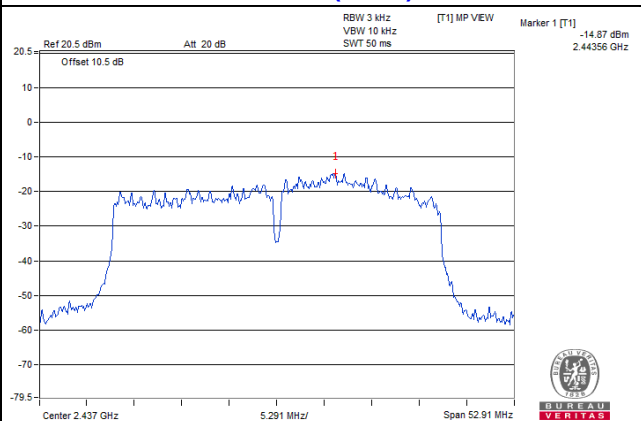

4.6 Conducted Out of Band Emission Measurement

4.6.1 Limits of Conducted Out of Band Emission Measurement

Below 20dB of the highest emission level of operating band (in 100kHz Resolution Bandwidth).

4.6.2 Test Setup

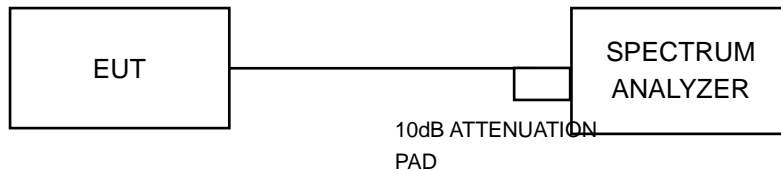

4.6.3 Test Instruments

Refer to section 4.1.2 to get information of above instrument.

4.6.4 Test Procedure

MEASUREMENT PROCEDURE REF

1. Set the RBW = 100 kHz.
2. Set the VBW \geq 300 kHz.
3. Detector = peak.
4. Sweep time = auto couple.
5. Trace mode = max hold.
6. Allow trace to fully stabilize.
7. Use the peak marker function to determine the maximum power level in any 100 kHz band segment within the fundamental EBW.

MEASUREMENT PROCEDURE OOB

1. Set RBW = 100 kHz.
2. Set VBW \geq 300 kHz.
3. Detector = peak.
4. Sweep = auto couple.
5. Trace Mode = max hold.
6. Allow trace to fully stabilize.
7. Use the peak marker function to determine the maximum amplitude level.

4.6.5 Deviation from Test Standard

No deviation.

4.6.6 EUT Operating Condition

Same as Item 4.3.6

4.6.7 Test Results

The spectrum plots are attached on the following pages. D1 line indicates the highest level, and D2 line indicates the 20dB offset below D1. It shows compliance with the requirement.

802.11b

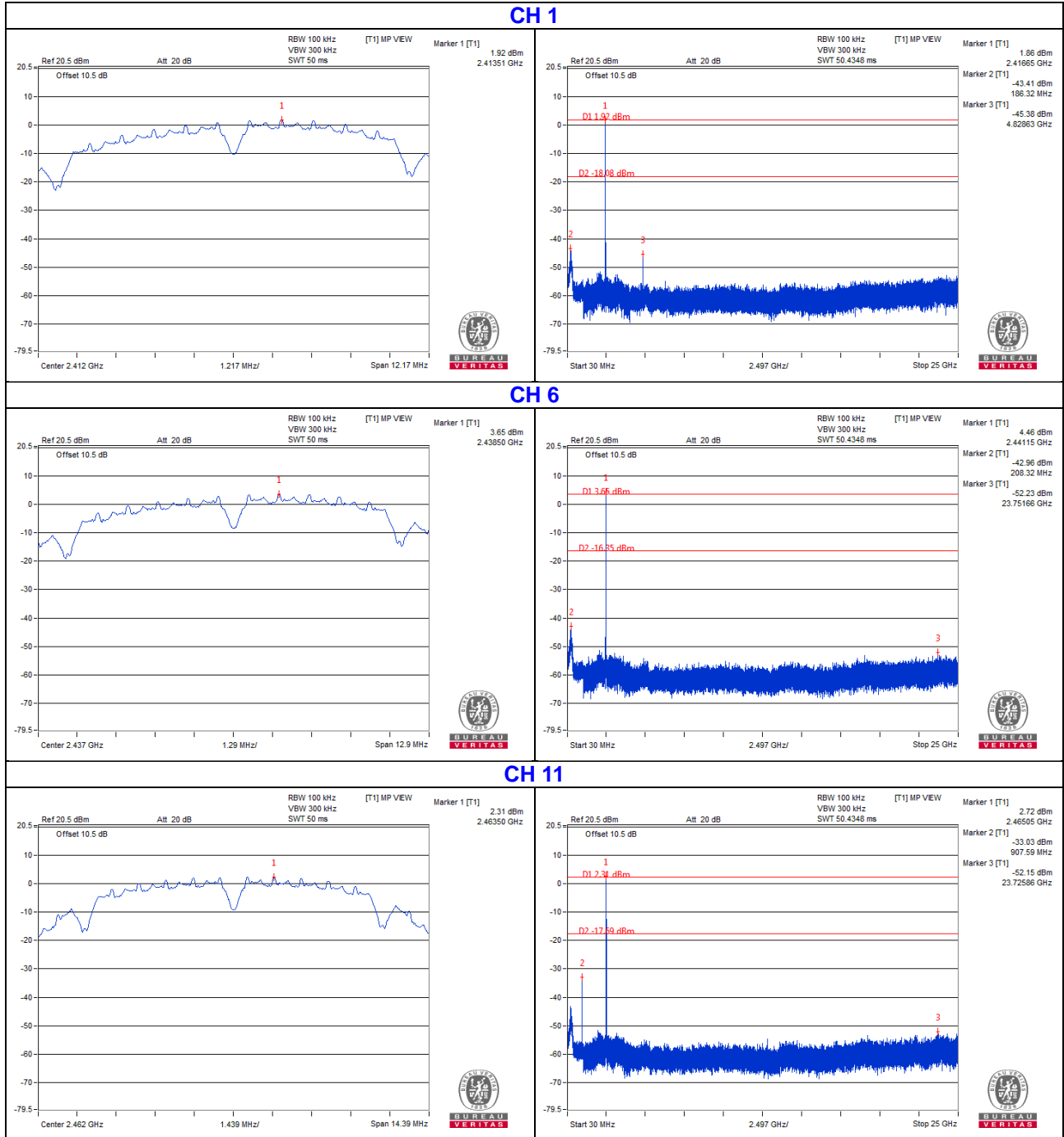

802.11g

CH 1

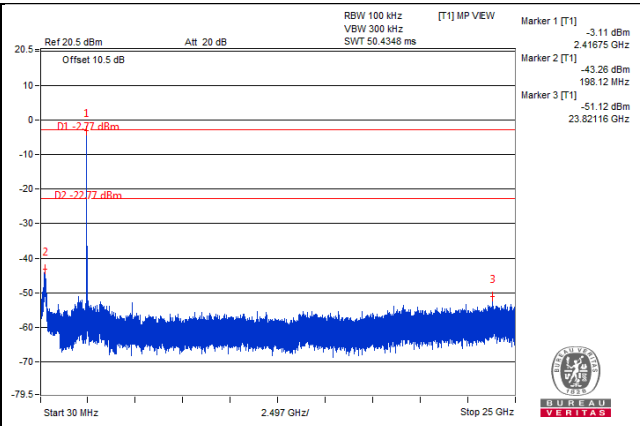
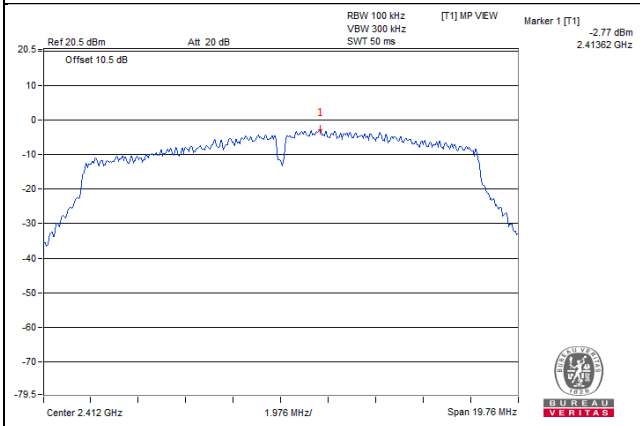

CH 6

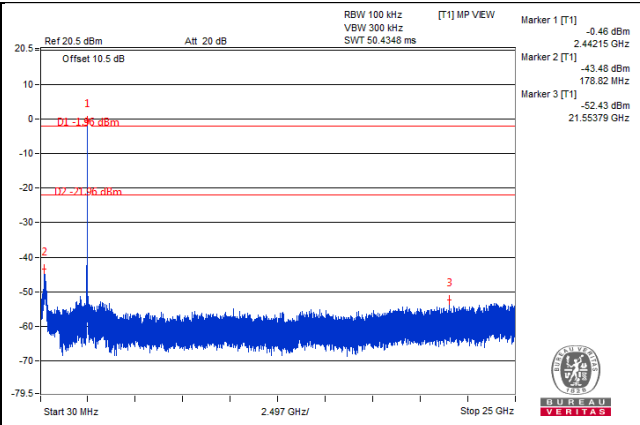
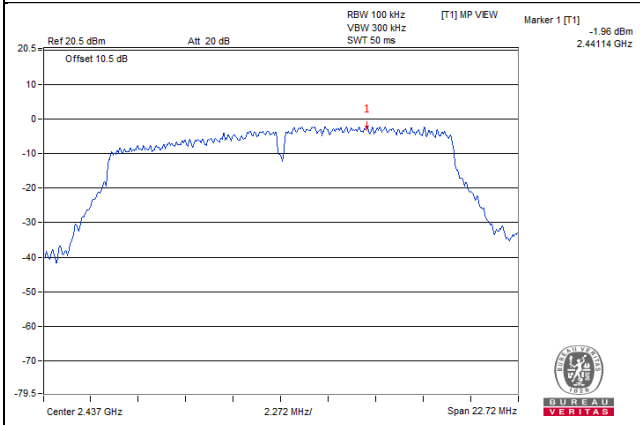

CH 11

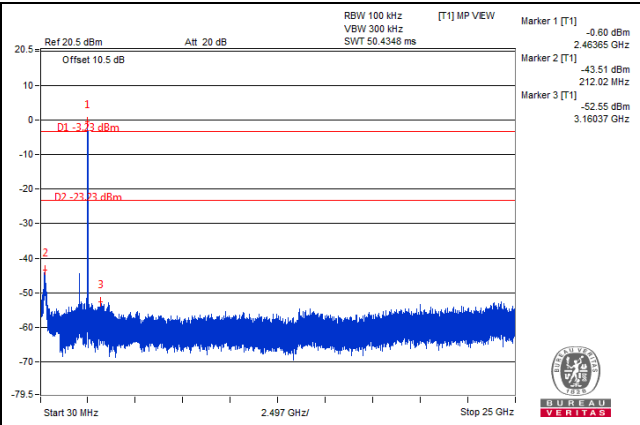
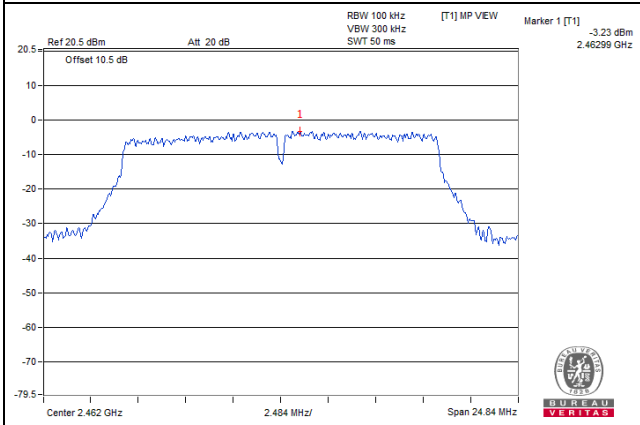

802.11n (HT20)

CH 1

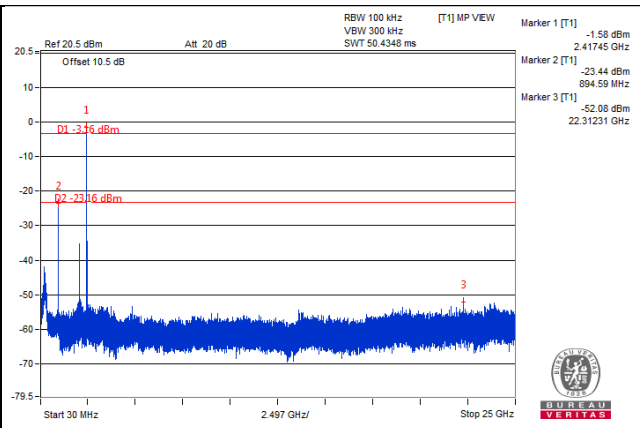
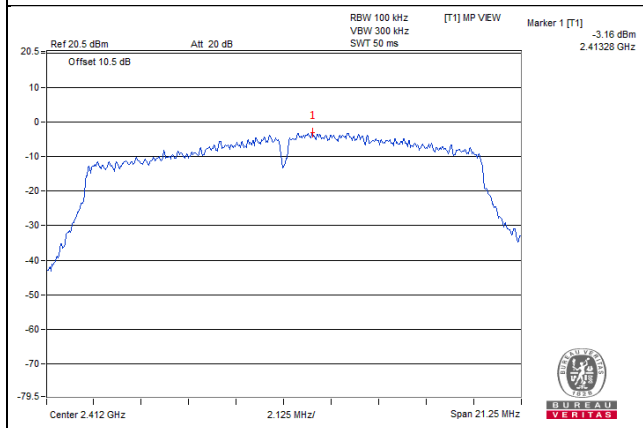

CH 6

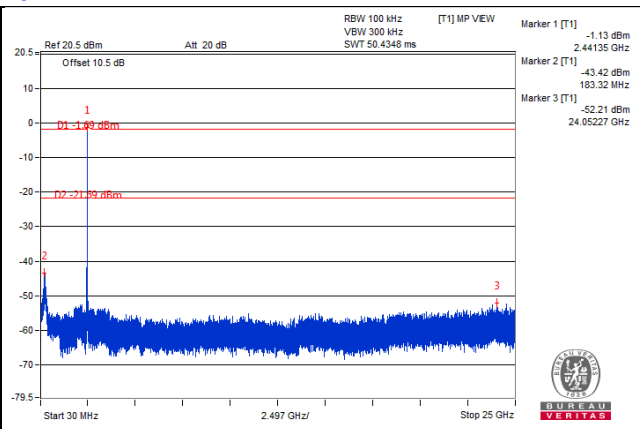
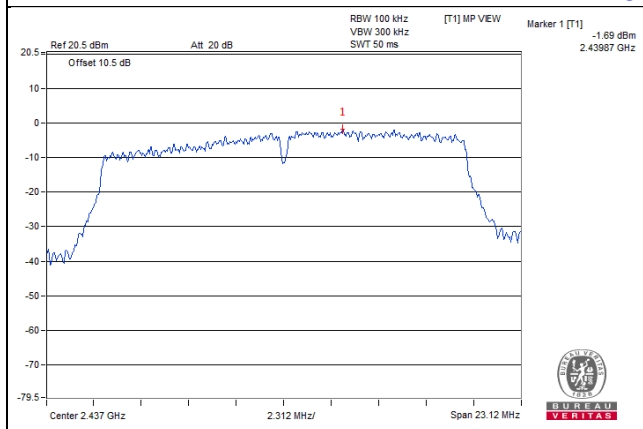

CH 11

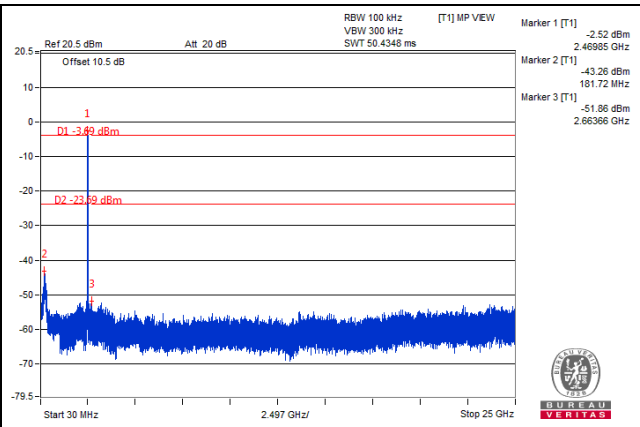
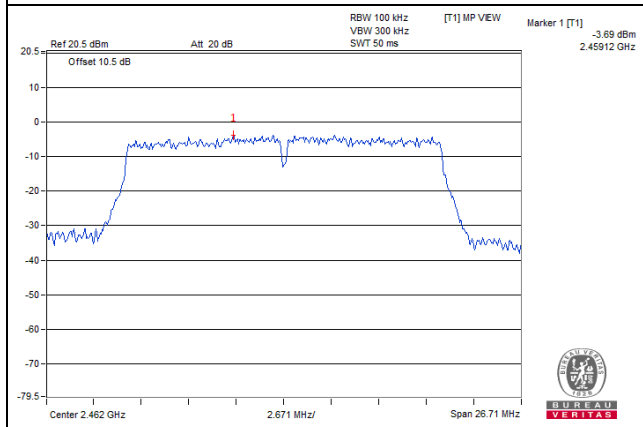

802.11n (HT40)

CH 3

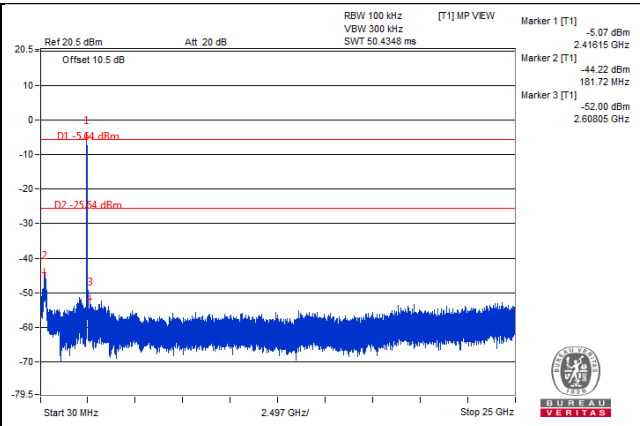
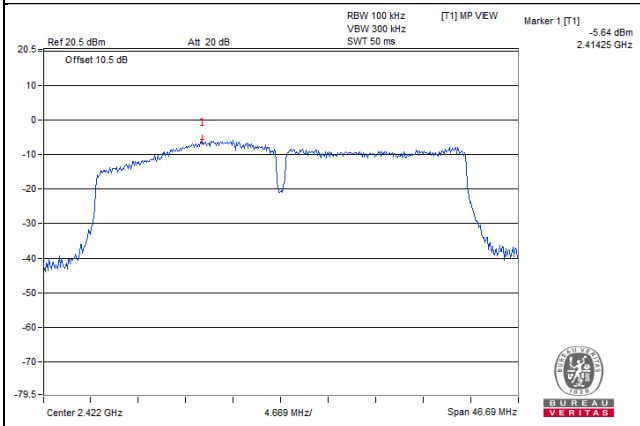

CH 6

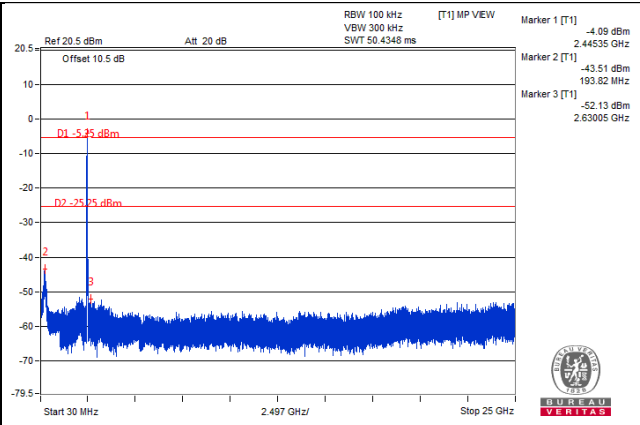
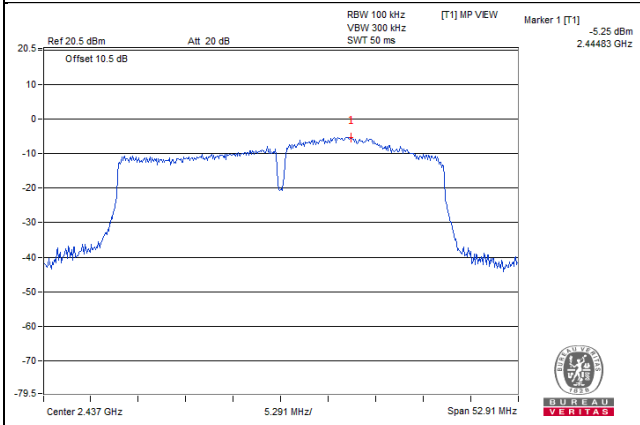

CH 9

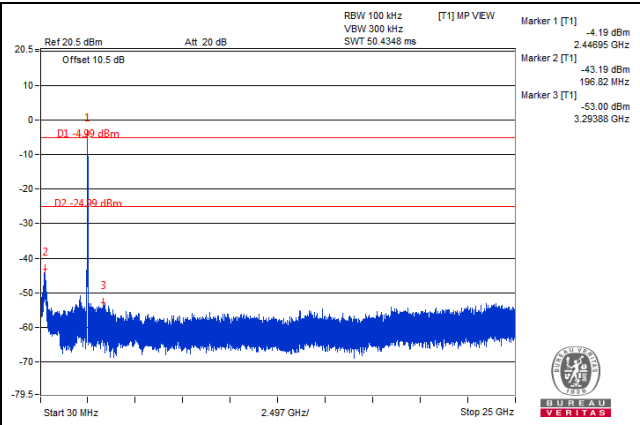
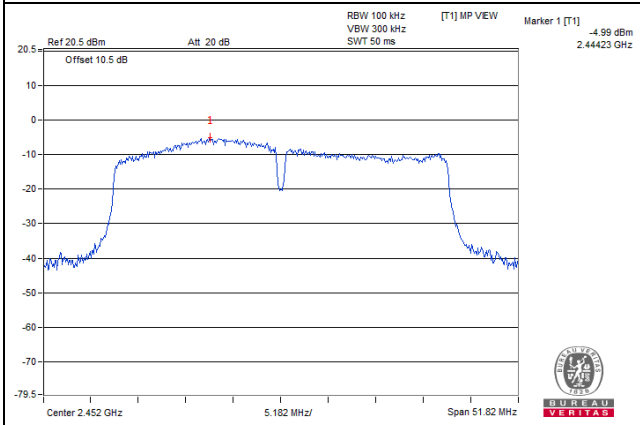

5 Pictures of Test Arrangements

Please refer to the attached file (Test Setup Photo).

Appendix – Information on the Testing Laboratories

We, Bureau Veritas Consumer Products Services (H.K.) Ltd., Taoyuan Branch, were founded in 1988 to provide our best service in EMC, Radio, Telecom and Safety consultation. Our laboratories are accredited and approved according to ISO/IEC 17025.

If you have any comments, please feel free to contact us at the following:

Linko EMC/RF Lab

Tel: 886-2-26052180

Fax: 886-2-26051924

Hsin Chu EMC/RF/Telecom Lab

Tel: 886-3-5935343

Fax: 886-3-5935342

Hwa Ya EMC/RF/Safety Lab

Tel: 886-3-3183232

Fax: 886-3-3270892

Email: service.adt@tw.bureauveritas.com

Web Site: www.bureauveritas-adt.com

The address and road map of all our labs can be found in our web site also.

--- END ---