

# Electromagnetic Emission

## FCC MEASUREMENT REPORT

### CERTIFICATION OF COMPLIANCE

#### FCC Part 15 Certification Measurement

**PRODUCT** : BLACKVUE SPORT  
**MODEL/Serial No.** : SC300 / Proto type  
**MULTIPLE MODEL** : -  
**FCC ID** : YCK-SC300  
**APPLICANT** : Pittasoft Co., Ltd.  
BYC HIGH CITY A-7th floor, 371-17 Gasan-Dong,  
Geumcheon-Gu, Seoul, 153-803, Korea  
Attn.: Kyungtae Ko / Senior Engineer  
**MANUFACTURER** : Pittasoft Co., Ltd.  
BYC HIGH CITY A-7th floor, 371-17 Gasan-Dong,  
Geumcheon-Gu, Seoul, 153-803, Korea  
**FCC CLASSIFICATION** : DTS (Part 15 Digital Transmission System)  
**TYPE OF MODULATION** : DSSS (CCK), OFDM (QAM)  
**FREQUENCY CHANNEL** : 802.11b/g/n(HT20): 2 412 MHz to 2 472 MHz and Channel Spacing 5 MHz (13 Ch)  
802.11n(HT40): 2 422 MHz to 2 462 MHz and Channel Spacing 5 MHz (9 Ch)  
**AIR DATE RATE** : 11 Mbps (802.11b), 54 Mbps (802.11g), 150 Mbps (802.11n)  
**ANTENNA TYPE** : Internal Antenna (Integral)  
**ANTENNA GAIN** : -2.80 dBi max  
**RF POWER** : 9.120 mW  
**RULE PART(S)** : FCC Part 15 Subpart C  
**FCC PROCEDURE** : ANSI C63.4-2009  
**TEST REPORT No.** : ETL140117.0102  
**DATES OF TEST** : April 07, 2014 to April 10, 2014  
**REPORT ISSUE DATE** : July 22, 2014  
**TEST LABORATORY** : ETL Inc. (FCC Designation Number : KR0022)

The BLACKVUE SPORT, Model SC300 has been tested in accordance with the measurement procedures specified in ANSI C63.4-2009 at the ETL Test Laboratory and has been shown to be complied with the electromagnetic radiated emission limits specified in FCC Rule Part15 Subpart C section 15.247.

I attest to the accuracy of data. All measurement herein was performed by me or was made under my supervision and is correct to the best of my knowledge and belief. I assume full responsibility for the completeness of these measurements and vouch for the qualifications of all persons taking them.

The results of testing in this report apply to the product/system which was tested only. Other similar equipment will not necessarily produce the same results due to production tolerance and measurement uncertainties.

Prepared by:   
Jeong Hwan, Pyo (Test Engineer)  
July 22, 2014

Reviewed by:   
Kug Kyoung, Yoon (Chief Engineer)  
July 22, 2014

**ETL Inc.**

**114, Gasan digital 2-ro, Geumcheon-gu, Seoul, 153-803, Korea**

**Tel: 82-2-858-0786 Fax: 82-2-858-0788**

*The test report merely corresponds to the test sample(s).*

*This report shall not be reproduced, in whole or in part without the written approval of ETL Inc.*

## Table of Contents

### **FCC Measurement Report**

- 1. Introduction**
- 2. Product Information**
- 3. Description of Tests**
- 4. Test Condition**
- 5. Test Results**
  - 5.1 Summary of Test Results**
  - 5.2 6 dB Bandwidth**
  - 5.3 Maximum Peak Output Power**
  - 5.4 Bandwidth of Frequency Band Edges**
  - 5.5 Power Spectral Density**
  - 5.6 Spurious Emissions**
  - 5.7 Conducted Emissions Test**
  - 5.8 Radio Frequency Exposure**
- 6. Sample Calculation**
- 7. List of test Equipment used for Measurement**

**Appendix A. FCC ID Label and Location**

**Appendix B. Test Setup Photographs**

**Appendix C. External Photographs**

**Appendix D. Internal Photographs**

**Appendix E. Block Diagram**

**Appendix F. Circuit Diagram**

**Appendix G. User Manual**

**Appendix H. Operational Description**

**Appendix I. Antenna Requirement**

**Appendix J. Radio Frequency Exposure**

## FCC MEASUREMENT REPORT

**Scope** – Measurement and determination of electromagnetic emission (EME) of radio frequency devices including intentional radiators and/or unintentional radiators for compliance with the technical rules and regulations of the U.S Federal Communications Commission(FCC)

### General Information

<b>Applicant Name</b>	<b>: Pittasoft Co., Ltd.</b>
<b>Address</b>	<b>: BYC HIGH CITY A-7th floor, 371-17 Gasan-Dong, Geumcheon-Gu, Seoul, 153-803, Korea</b>
<b>Attention</b>	<b>: Kyungtae Ko / Senior Engineer</b>

- **EUT Type** : BLACKVUE SPORT
- **Model Number** : SC300
- **S/N** : Proto type
- **Modulation Technique** : DSSS (CCK), OFDM (QAM)
- **Frequency Channel** : 802.11b/g/n(HT20) : 2 412 MHz to 2 472 MHz and Channel Spacing 5 MHz (13 Ch)  
802.11n(HT40): 2 422 MHz to 2 462 MHz and Channel Spacing 5 MHz (9 Ch)
- **Air Data Rate** : 11 Mbps (802.11b), 54 Mbps (802.11g), 150 Mbps (802.11n)
- **Antenna Type** : Internal Antenna (Integral)
- **Antenna Gain** : -2.80 dBi max
- **RF Power** : 9.120 mW
- **Environmental of Tests** : Temperature: (17.5 ± 5.0) °C  
: Humidity: (54 ± 11) % R.H.  
: Atmospheric Pressure: (101.3 ± 0.3) kPa
- **FCC Rule Part(s)** : FCC Part 15 Subpart C
- **Test Procedure** : ANSI C63.4-2009
- **FCC Classification** : DTS (Part 15 Digital Transmission System)
- **Place of Tests** : ETL Inc. Testing Lab. (FCC Designation Number : KR0022)

Radiated Emission test 1;  
97-4, Gureomae-gil, Seosin-myeon, Hwaseong-si,  
Gyeonggi-do, 445-882, Korea

Radiated Emission test 2 and Conducted Emission test;  
114, Gasan digital 2-ro, Geumcheon-gu, Seoul, 153-803, Korea

## **1. INTRODUCTION**

The measurement test for radiated and conducted emission test was conducted at the ETL Inc. The site is constructed in conformance with the requirements of the ANSI C63.4-2009 and CISPR Publication 16. The ETL has site descriptions on file with the FCC for 3 m and 10 m site configurations. Detailed description of test facility was found to be in compliance with FCC Rules according to the ANSI C63.4-2009 and registered to the Federal Communications Commission (FCC Designation Number : KR0022).

The measurement procedure described in American National Standard for Method of Measurement of Radio-Noise Emission from Low-Voltage Electrical and Electronic Equipment in the Range of 9 kHz to 40 GHz (ANSI C63.4-2009) was used in determining radiated and conducted emissions from the Pittasoft Co., Ltd. Model: SC300

## 2. PRODUCT INFORMATION

### 2.1 Equipment Description

The Equipment Under Test (EUT) is the BLACKVUE SPORT (model: SC300).

The model SC300 is basic model that was tested.

### 2.2 General Specification

Item		Specification
Camera	Pixel	3.5 Mega Pixel
	Angle of View	Opposite Angel 138°
	Weight	77 g (LCD: 22 g)
	Size	55.0 mm (W) 36.7 mm (L) x 44.2 mm (H)
	Sensor	3.5 M CMOS Sensor
H/W Interface	Storage	Micro SD Card (Up to 32 GB, Class 10 or higher micro SD cards are recommended)
	Input/Output	USB 2.0 / USB 2.0, HDMI
	Button	Power/Mode, Wi-Fi, Shutter/Choice
	LCD	2.0 Inch, 240p
Battery	Type	Rechargeable 3.7 V, 1 050 mAh Li-Polymer Pack Battery
	Charging	Micro USB
Video	Format	MP4
	Resolution/FPS	1 080p, 30 fps 720 p, 60 fps/30 fps
	Time-laps Recording	1, 5, 30, 60, 300, 600 second intervals
Photo	Format	JPEG
	Resolution	3.5 M (2 304 x 1 536, 3:2) 3.0 M (2 048 x 1 536, 4:3) 3.0 M (2 304 x 1 286, 16:9)
High Speed Shooting	Resolution/FPS	480p, 120 fps
Wi-Fi	13 Channel	802.11b/g/n(20)
	9 Channel	802.11n(40)
	PCM	DSSS (CCK), OFDM (QAM)

Item		Specification
Audio	MIC	Built-in, Mono
	Format	128 kHz, AAC
Software	Application	BLACKVUE SPORT APP (Android 2.3 or later, iOS 5.0 or later)
Waterproof	Degree	IP68
	Housing	Depth Rate 10 m/32 ft
		Frontcase (basic) - Option
		Frontcase (extended)
		Backdoor (for LCD) - Option
	Backdoor (slim)	
Waterproof power cable		External power supply
Operation Temperature		(22.5 ± 22.5) °C
High Internal Frequency		REF Clock → 26 MHz

## 3. DESCRIPTION OF TESTS

The tests documented in this report were performed in accordance with ANSI C63.4-2009 and FCC CFR 47 2.1046, 2.1047, 2.1049, 2.1051, 2.1053, 2.1055, 2.1057, 15.207, 15.209 and 15.247.

### 3.1 Radiated Emission Measurement

Radiated emission measurements were made in accordance with § 13 in ANSI C63.4-2009 "Measurement of Intentional radiators" The measurements were performed over the frequency range of 30 MHz to 40 GHz using antenna as the input transducer to a Spectrum analyzer or a Field Intensity Meter. The measurements were made with the detector set for "Peak, Quasi-peak, Average" within a bandwidth of 120 kHz and above 1 GHz is 1 MHz.

Preliminary measurements were made at 3 m using broadband antennas, and spectrum analyzer to determine the frequency producing the maximum emission in shielded room. Appropriate precaution was taken to ensure that all emission from the EUT were maximized and investigated. The system configuration, mode of operation, turntable azimuth and height with respect to the antenna were noted for each frequency found. The spectrum was scanned from 30 MHz to 1 000 MHz using Log-Bicon antenna. Above 1 GHz, linearly polarized double ridge horn antennas were used. Final measurements were made open site or SVSWR chamber at 3 m. The test equipment was placed on a styrofoam table. Sufficient time for the EUT, support equipment, and test equipment was allowed in order for them to warm up to their normal operating condition. Each frequency found during pre-scan measurements was re-examined by manual. The EUT, support equipment and interconnecting cables were re-configured to the set-up producing the maximum emission for the frequency and were placed on top of a 0.8 m high nonmetallic 1.0 m x 1.5 m table. The EUT, support equipment, and interconnecting cables were re-arranged and manipulated to maximize each emission. The turntable containing the system was rotated; the antenna height was varied 1 m to 4 m and stopped at the azimuth or height producing the maximum emission.

Varying the mode of operating frequencies of the EUT maximized each emission. The system was tested in all the three orthogonal planes and changing the polarity of the antenna. The worst-case emissions are recorded in the data tables. If necessary, the radiated emission measurement could be performed at a closer distance to ensure higher accuracy and the results were extrapolated to the specified distance using an inverse linear distance extrapolation factor (20 dB/decade) as per section 15.31(f).

Photographs of the worst-case emission can be seen in Photographs of the worst-case emission test setup can be seen in Appendix B.



## 3.2 Conducted Emission Measurement

Conducted emissions measurements were made in accordance with section § 13 in ANSI C63.4-2009 "measurement of intentional radiators" The measurements were performed over the frequency range of 0.15 MHz to 30 MHz using a 50  $\Omega$ /50  $\mu$ H LISN as the input transducer to a Spectrum Analyzer or a Test Receiver. The measurements were made with the detector set for "Peak" amplitude within a bandwidth of 9 kHz or for "quasi-peak" within a bandwidth of 9 kHz.

The line-conducted emission test is conducted inside a shielded anechoic chamber room with 1 m x 1.5 m x 0.8 m wooden table which is placed 0.4 m away from the vertical wall and 1.5 m away from the side wall of the chamber room. Two LISN are bonded to the shielded room. The EUT is powered from the LISN and the support equipment is powered from the other LISN. Power to the LISNs are filtered by a noise cut power line filters. All electrical cables are shielded by braided tinned steel tubing with inner  $\phi$  1.2 cm. If the EUT is a DC-powered device, power will be derived from the source power supply it normally will be powered from and these supply lines will be connected to the LISN. Non-inductive bundling to a 1 m length shortened all interconnecting cables more than 1 m. Sufficient time for the EUT, support equipment, and test equipment was allowed in order for them to warm up to their normal operating condition. The RF output of the LISN was connected to the EMI Test Receiver to determine the frequency producing the maximum emission from the EUT. The frequency producing the maximum level was reexamined using to set Quasi-Peak mode by manual, after scanned by automatic Peak mode from 0.15 MHz to 30 MHz. The bandwidth of the spectrum analyzer was set to 9 kHz. The EUT, support equipment, and interconnecting cables were arranged and manipulated to maximize each emission.

Photographs of the worst-case emission can be seen in Photographs of the worst-case emission test setup can be seen in Appendix B.



### 3.3 FCC Part 15.205 Restricted Bands of Operations

(a) Except as shown in paragraph (d) of this section, only spurious emissions are permitted in any of the frequency bands listed below:

MHz	MHz	MHz	GHz
0.090 - 0.110	16.42 - 16.423	399.9 - 410	4.5 - 5.15
<sup>1</sup> 0.495 - 0.505	16.694 75 - 16.695 25	608 - 614	5.35 - 5.46
2.173 5 - 2.190 5	16.804 25 - 16.804 75	960 - 1 240	7.25 - 7.75
4.125 - 4.128	25.5 - 25.67	1 300 - 1 427	8.025 - 8.5
4.177 25 - 4.177 75	37.5 - 38.25	1 435 - 1 626.5	9.0 - 9.2
4.207 25 - 4.207 75	73 - 74.6	1 645.5 - 1 646.5	9.3 - 9.5
6.215 - 6.218	74.8 - 75.2	1 660 - 1 710	10.6 - 12.7
6.267 75 - 6.268 25	108 - 121.94	1 718.8 - 1 722.2	13.25 - 13.4
6.311 75 - 6.312 25	123 - 138	2 200 - 2 300	14.47 - 14.5
8.291 - 8.294	149.9 - 150.05	2 310 - 2 390	15.35 - 16.2
8.362 - 8.366	156.524 75 - 156.525 25	2 483.5 - 2 500	17.7 - 21.4
8.376 25 - 8.386 75	156.7 - 156.9	2 690 - 2 900	22.01 - 23.12
8.414 25 - 8.414 75	162.012 5 - 167.17	3 260 - 3 267	23.6 - 24.0
12.29 - 12.293	167.72 - 173.2	3 332 - 3 339	31.2 - 31.8
12.519 75 - 12.520 25	240 - 285	3 345.8 - 3 358	36.43 - 36.5
12.576 75 - 12.577 25	322 - 335.4	3 600 - 4 400	( <sup>2</sup> )
13.36 - 13.41			

<sup>1</sup> Until February 1, 1999, this restricted band shall be 0.490 MHz - 0.510 MHz.

<sup>2</sup> Above 38.6

(b) Except as provided in paragraphs (d) and (e), the field strength of emissions appearing within these frequency bands shall not exceed the limits shown in Section 15.209. At frequencies equal to or less than 1 000 MHz, compliance with the limits in Section 15.209 shall be demonstrated using measurement instrumentation employing a CISPR quasi-peak detector. Above 1 000 MHz, compliance with the emission limits in Section 15.209 shall be demonstrated based on the average value of the measured emissions. The provisions in Section 15.35 apply to these measurements.

## 4. TEST CONDITION

### 4.1 Test Configuration

The device was configured for testing in a typical fashion (as a customer would normally use it). During the tests, the following conditions and configurations were used.

### 4.2 Description of Test modes

BLACKVUE SPORT that has the control software.

### 4.3 The setup drawing(s)

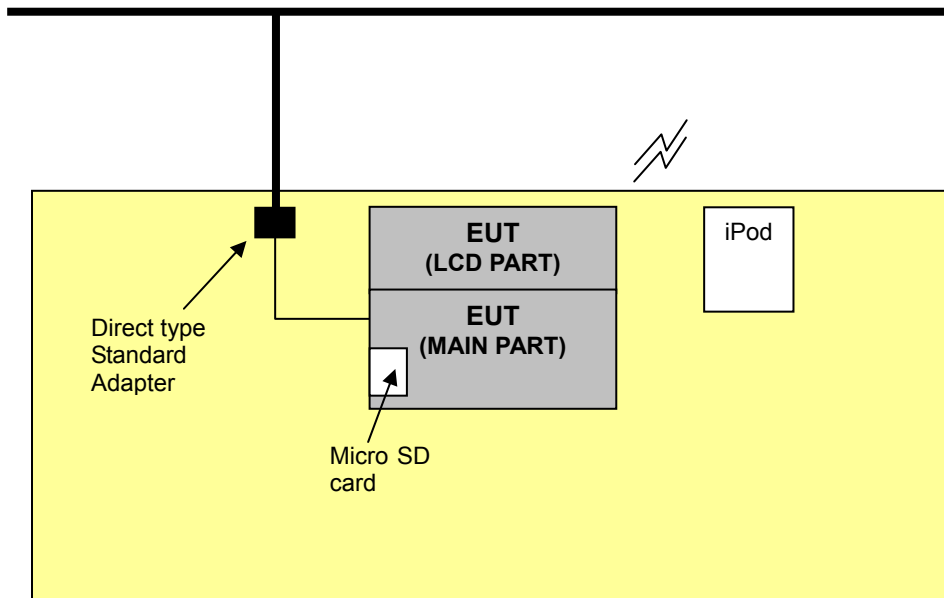

————— : Signal line

————— : Power line

■ : Adapter

## 5. TEST RESULTS

### 5.1 Summary of Test Results

The measurement results were obtained with the EUT tested in the conditions described in this report. Detailed measurement data and plots showing the maximum emission of the EUT are reported.

47 CFR Part 15, Subpart C	Measurement Required	Result
15.247(a)(2)	6 dB Bandwidth	Pass
15.247(b)(3)	Maximum Peak Output Power	Pass
15.247(d)	Bandwidth of Frequency Band Edges	Pass
15.247(e)	Power Spectral Density	Pass
15.209(a)	Spurious Emissions	Pass
15.207	Conducted Emissions	Pass
1.1307(b)(1)	RF Exposure	Pass

The data collected shows that the **Pittasoft Co., Ltd. / BLACKVUE SPORT / SC300** complied with technical requirements of above rules part 15.207, 209 and 15.247 Limits.

The equipment is not modified anything, mechanical or circuits to improve EMI status during a measurement. No EMI suppression device(s) was added and/or modified during testing.

## 5.2 6 dB Bandwidth

EUT	BLACKVUE SPORT / SC300
Limit apply to	FCC Part 15.247(a)(2)
Test Date	April 07, 2014
Environmental of Test	22.5 °C, 45 % R.H., 101.2 kPa
Operating Condition	RF transmitting continuously during the tested.
Result	Passed

### Limit

The maximum 6 dB bandwidth shall be at least 500 kHz.

### Test Data

Mode	Frequency [MHz]	6 dB Bandwidth [MHz]	Limit
802.11b	2 412	10.47	> 500 kHz
	2 442	10.50	
	2 472	11.10	
802.11g	2 412	16.53	
	2 442	16.53	
	2 472	16.50	
802.11n(HT20)	2 412	17.47	
	2 442	17.70	
	2 472	17.63	
802.11n(HT40)	2 422	36.42	
	2 442	36.50	
	2 462	36.42	

### NOTES:

1. Measure frequency separation of relevant channel using spectrum analyzer.
2. RBW 300 kHz, VBW 1 MHz, Sweep time Auto.
3. Please see the measured plot in next page.

## Plots of 6 dB Bandwidth (802.11b)

[2 412 MHz]

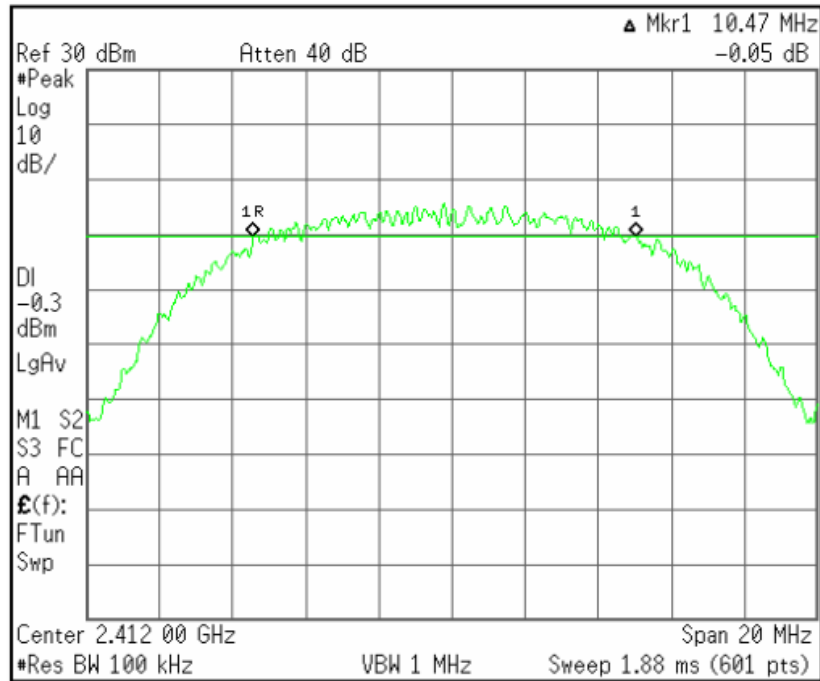

[2 442 MHz]

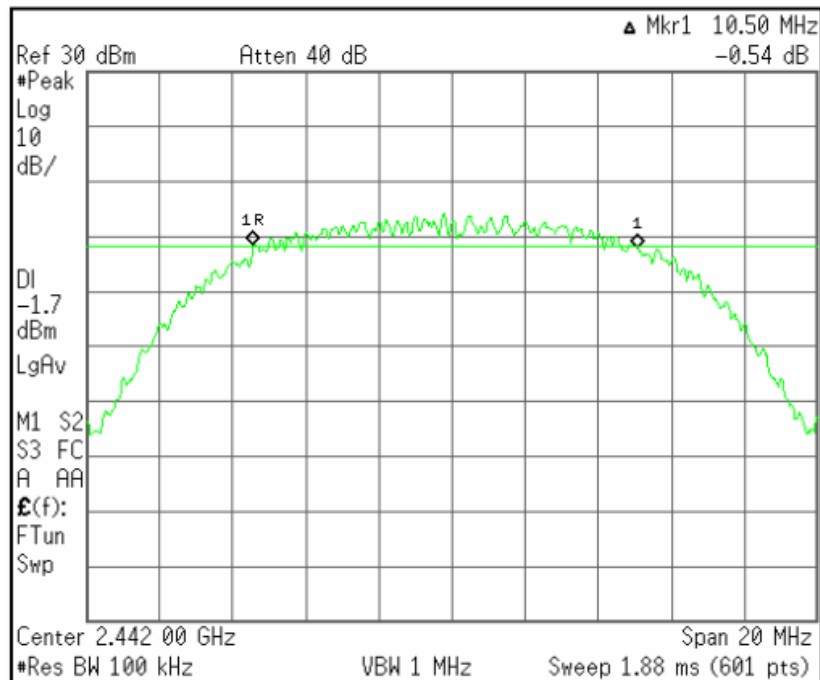

[2 472 MHz]

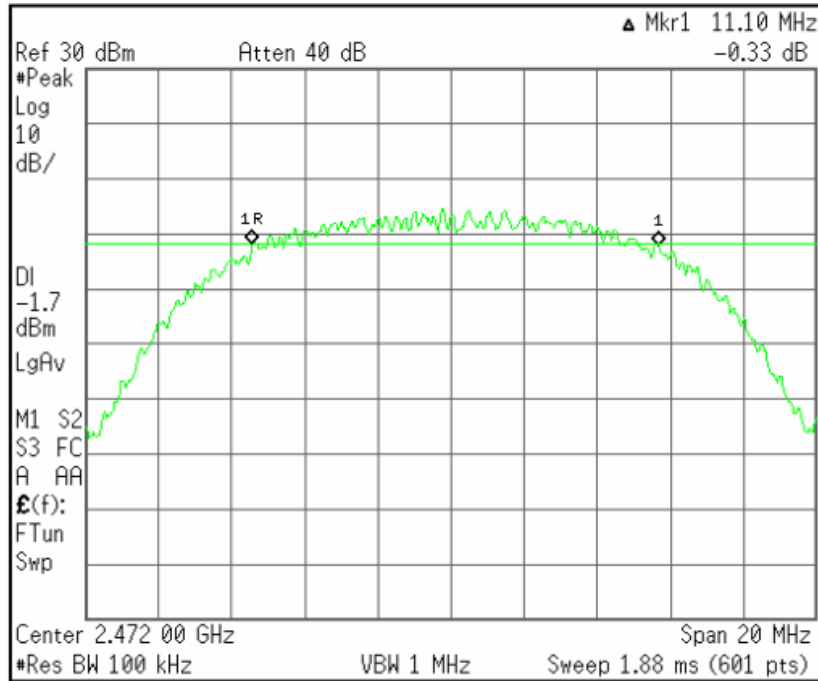

### Plots of 6 dB Bandwidth (802.11g)

[2 412 MHz]

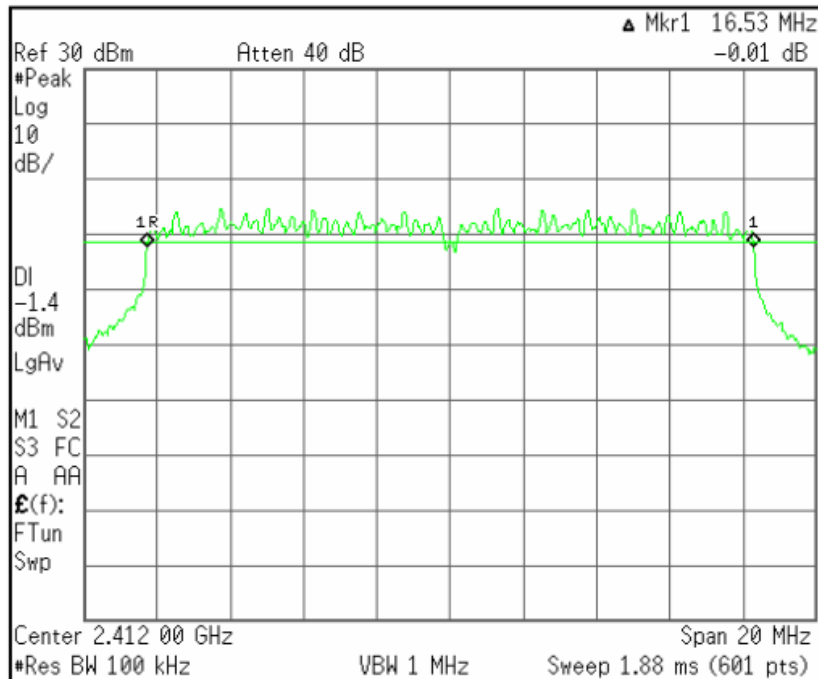

[2 442 MHz]

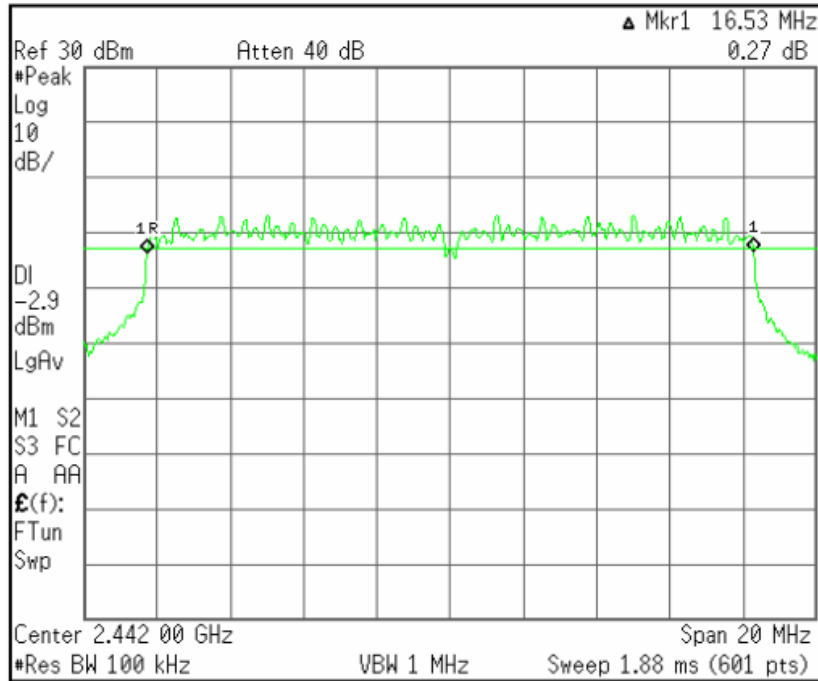

[2 472 MHz]

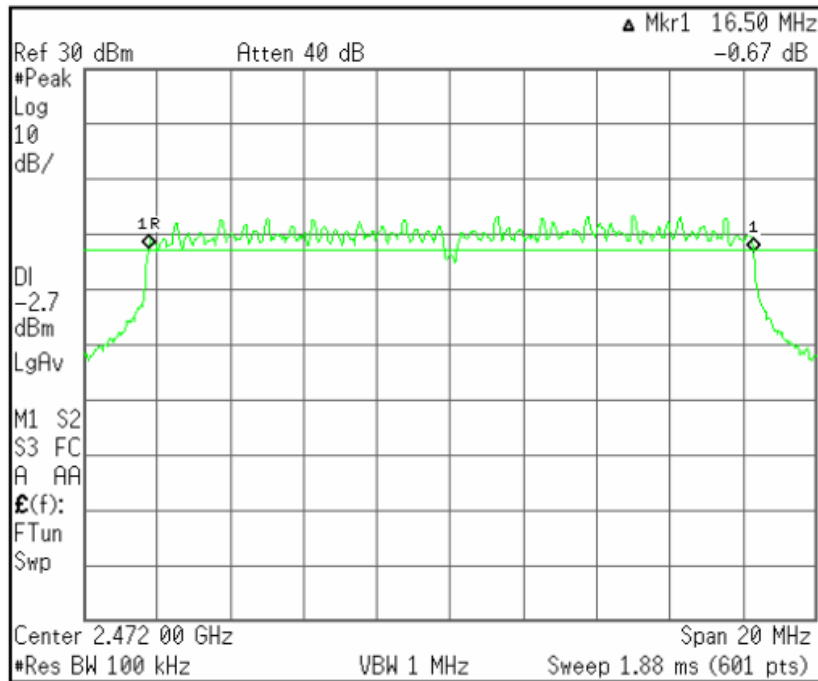



## Plots of 6 dB Bandwidth (802.11n(HT20))

[2 412 MHz]

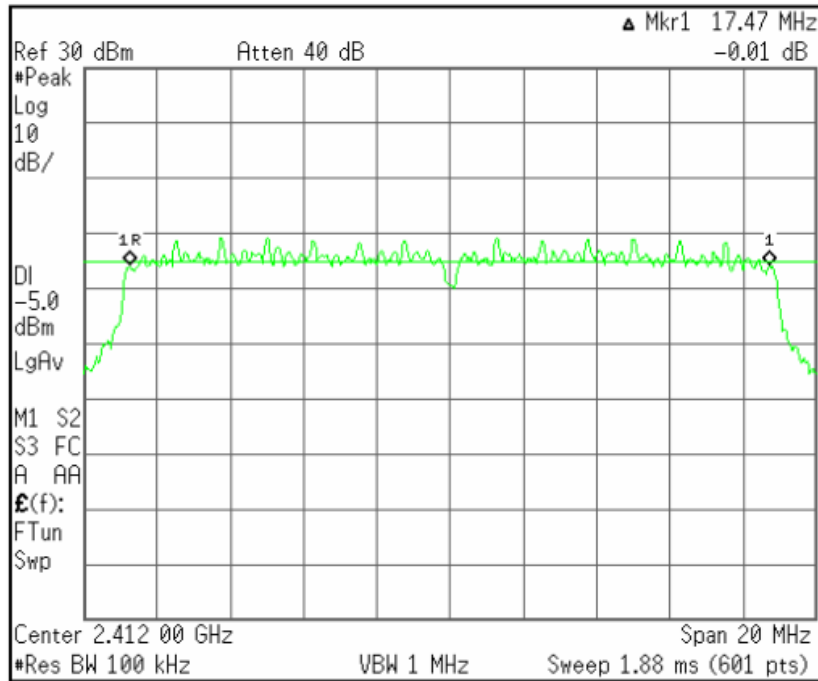

[2 442 MHz]

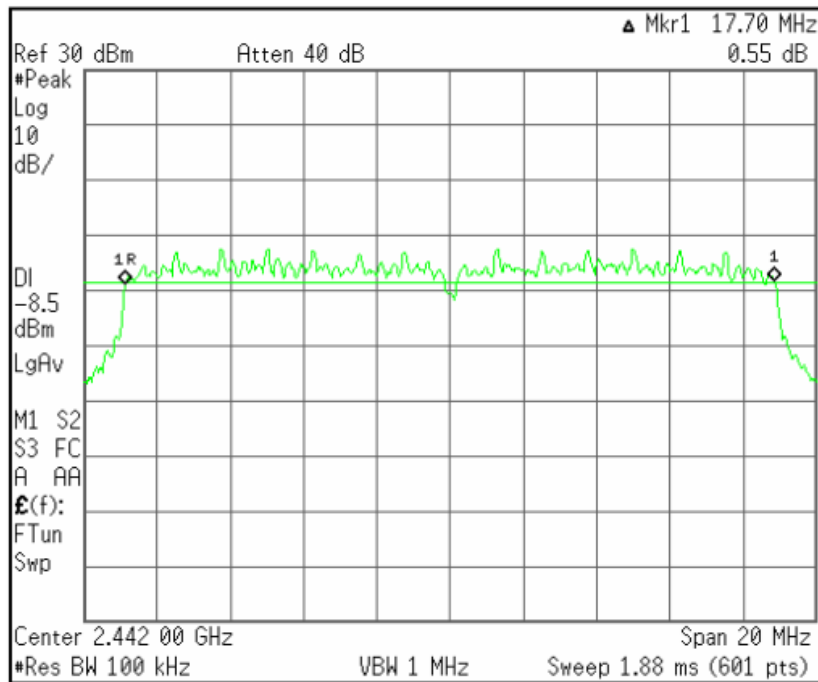

[2 472 MHz]

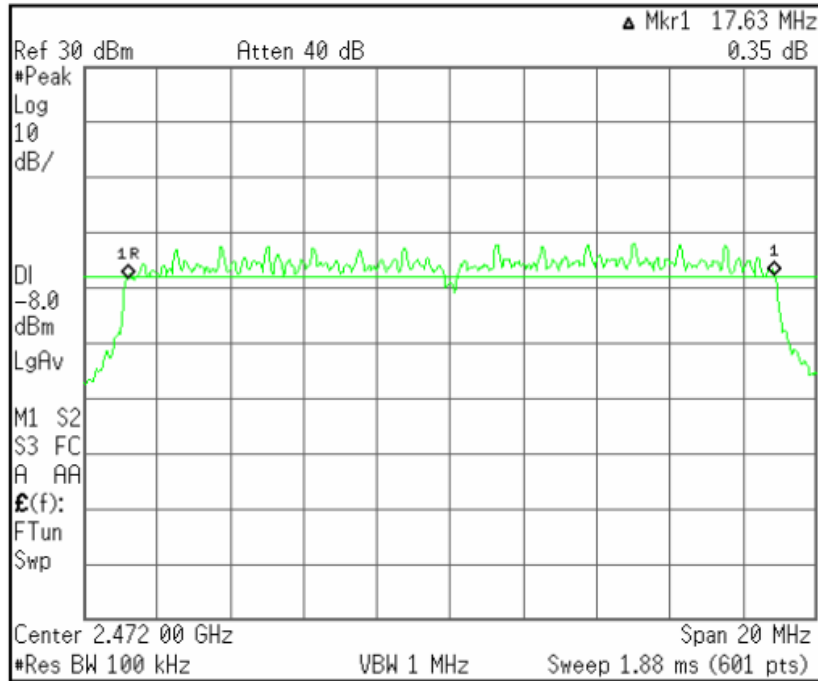

### Plots of 6 dB Bandwidth (802.11n(HT40))

[2 422 MHz]

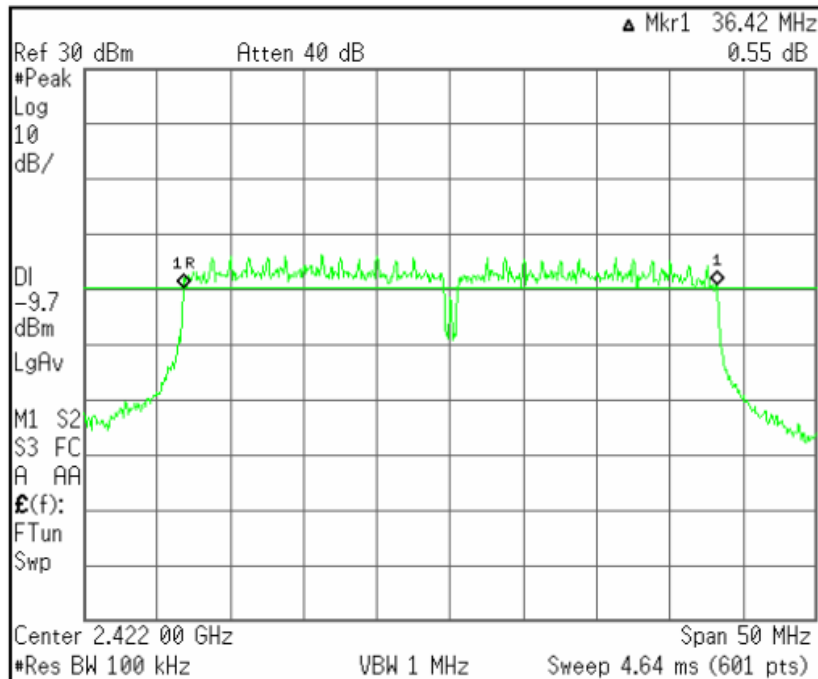

[2 442 MHz]

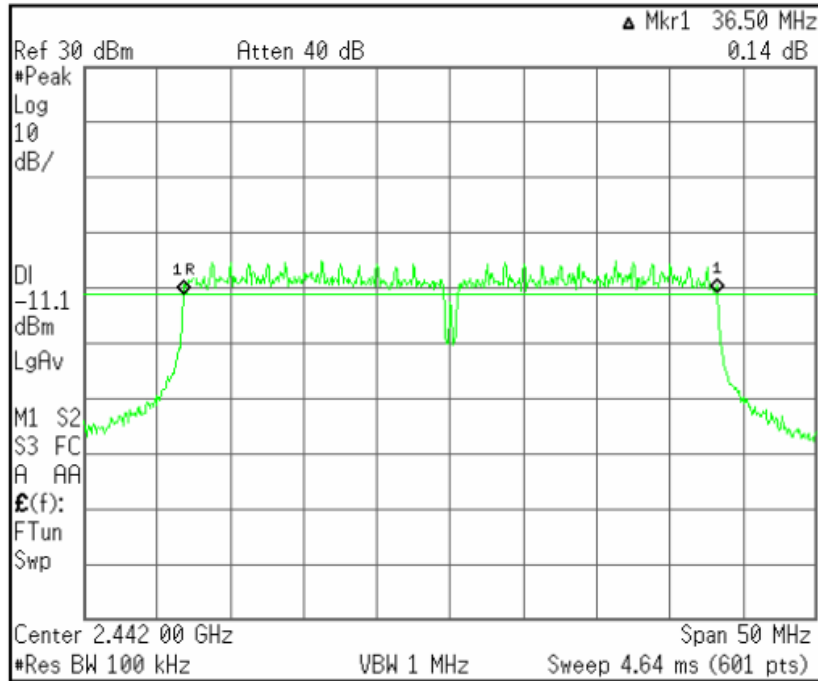

[2 462 MHz]

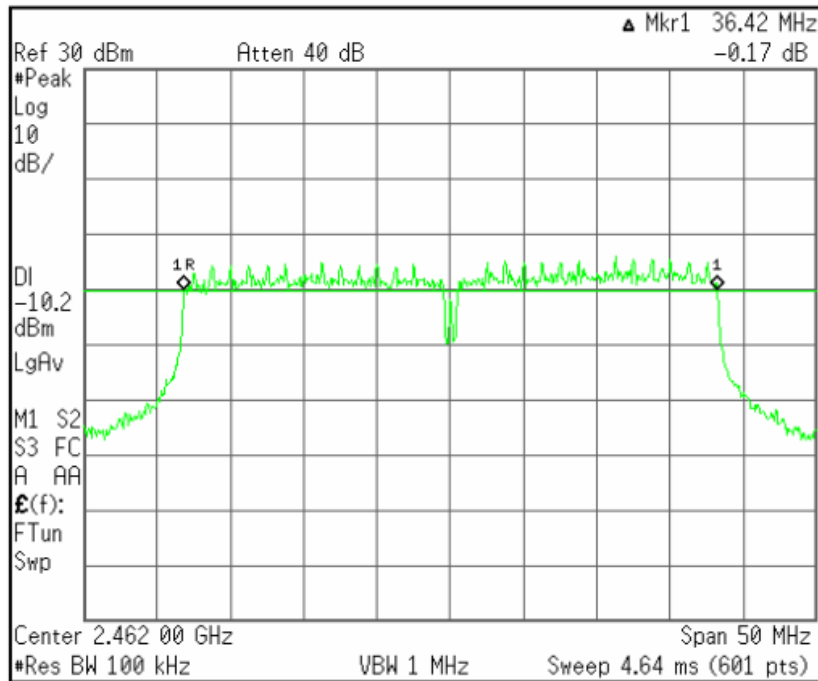

## 5.3 Maximum Peak Conducted Output Power

EUT	BLACKVUE SPORT / SC300
Limit apply to	FCC Part 15.247(b)(3)
Test Date	April 07, 2014
Environmental of Test	22.1 °C, 43 % R.H., 101.2 kPa
Operating Condition	RF transmitting continuously during the tested.
Result	Passed

### Limit

The maximum peak conducted output power of the intentional radiator shall not exceed the following:

For frequency hopping systems operating in the 2 400.0 MHz - 2 483.5 MHz band: 1 Watt

### Test Data

Mode	Frequency [MHz]	Output Power [dBm]	Limit
802.11b	2 412	9.20	< 30.00 dBm (1 W)
	2 442	7.96	
	2 472	8.35	
802.11g	2 412	9.44	
	2 442	7.99	
	2 472	8.35	
802.11n(HT20)	2 412	9.60	
	2 442	8.01	
	2 472	8.29	
802.11n(HT40)	2 422	9.19	
	2 442	7.81	
	2 462	8.36	

### NOTES:

1. Measure conducted Channel power of relevant channel using spectrum analyzer.
2. RBW 1 MHz, VBW 8 MHz
3. Please see the measured plot in next page.

## Plots of Maximum Peak Output Power Bandwidth (802.11b)

[2 412 MHz]

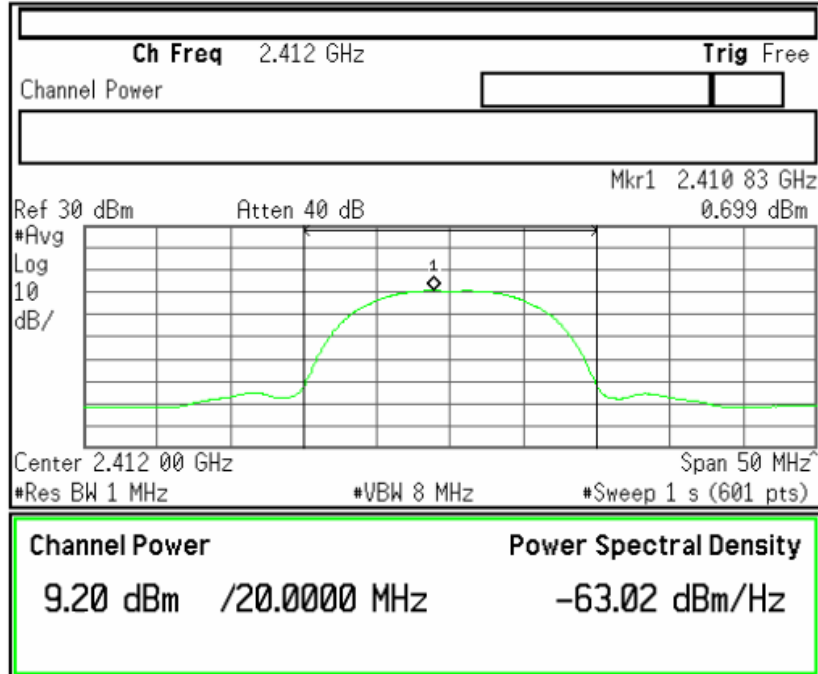

[2 442 MHz]

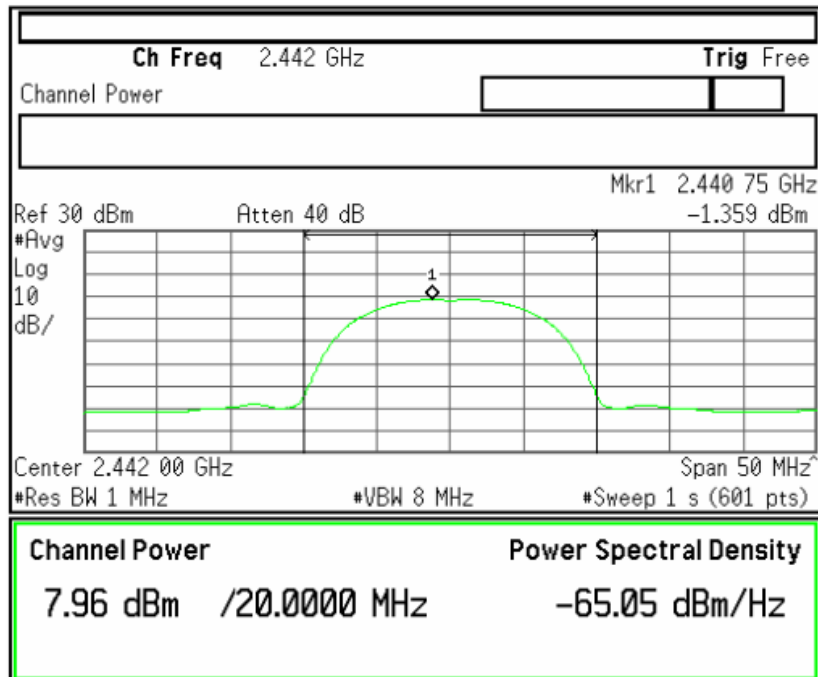

[2 472 MHz]

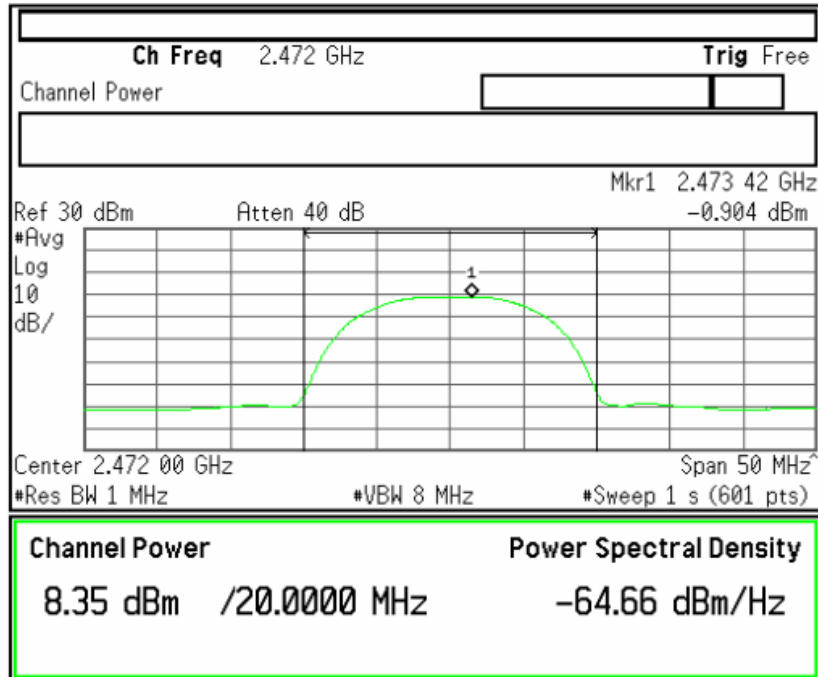

## Plots of Maximum Peak Output Power Bandwidth (802.11g)

[2 412 MHz]

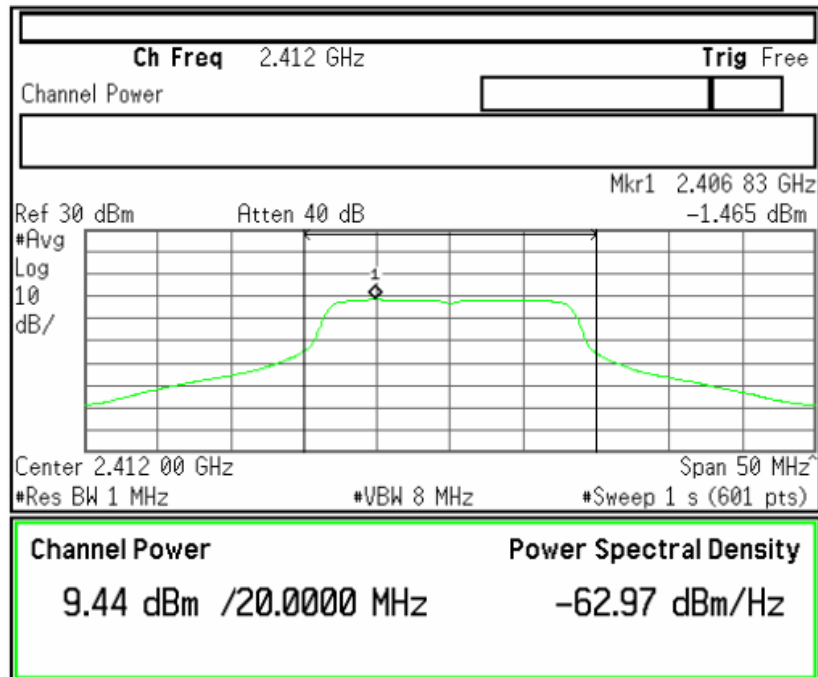

[2 442 MHz]

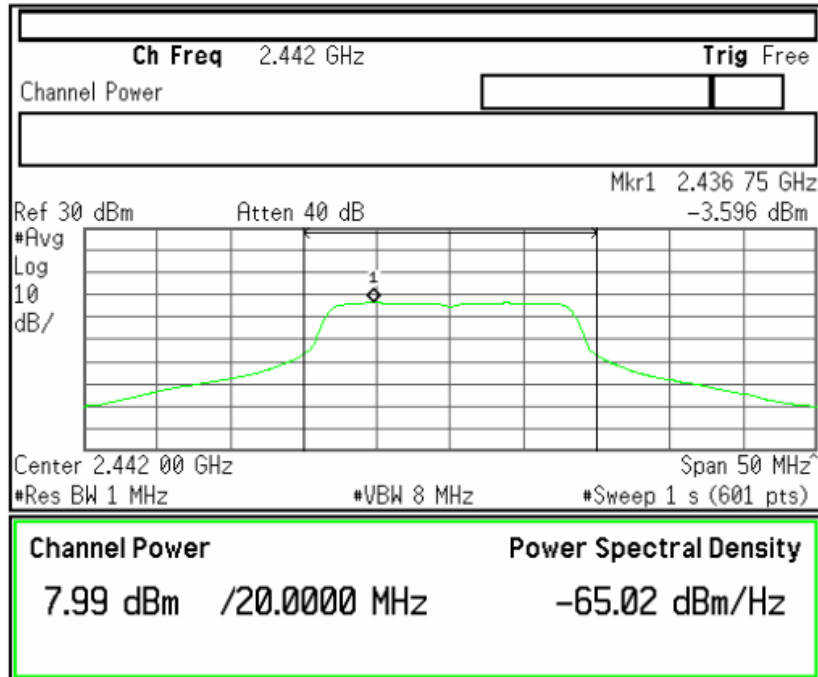

[2 472 MHz]

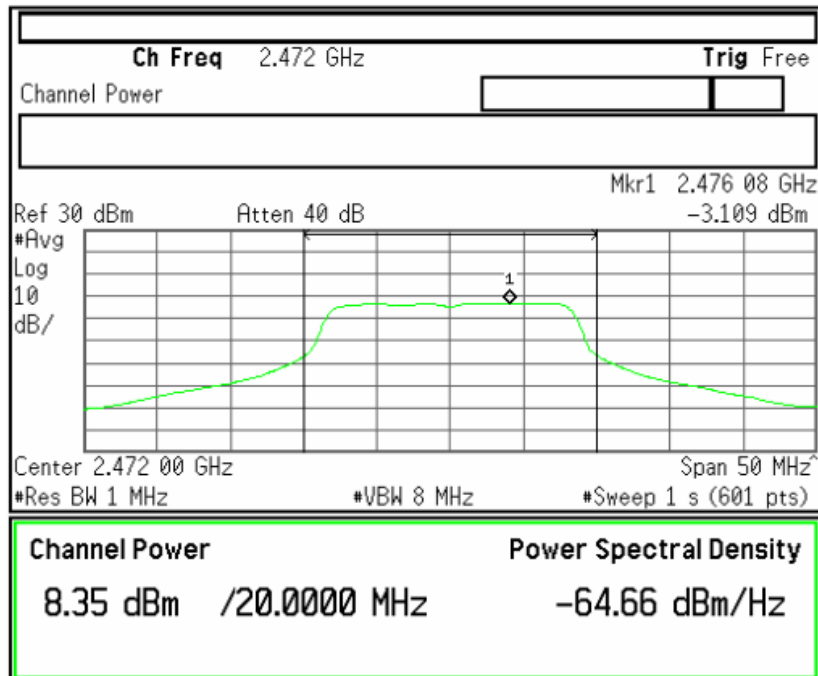



## Plots of Maximum Peak Output Power Bandwidth (802.11n(HT20))

[2 412 MHz]

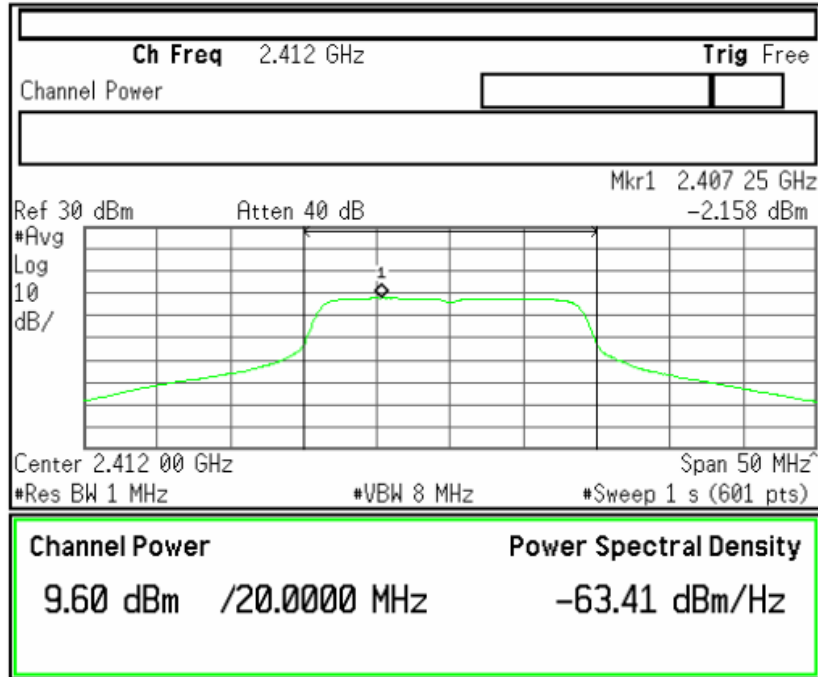

[2 442 MHz]

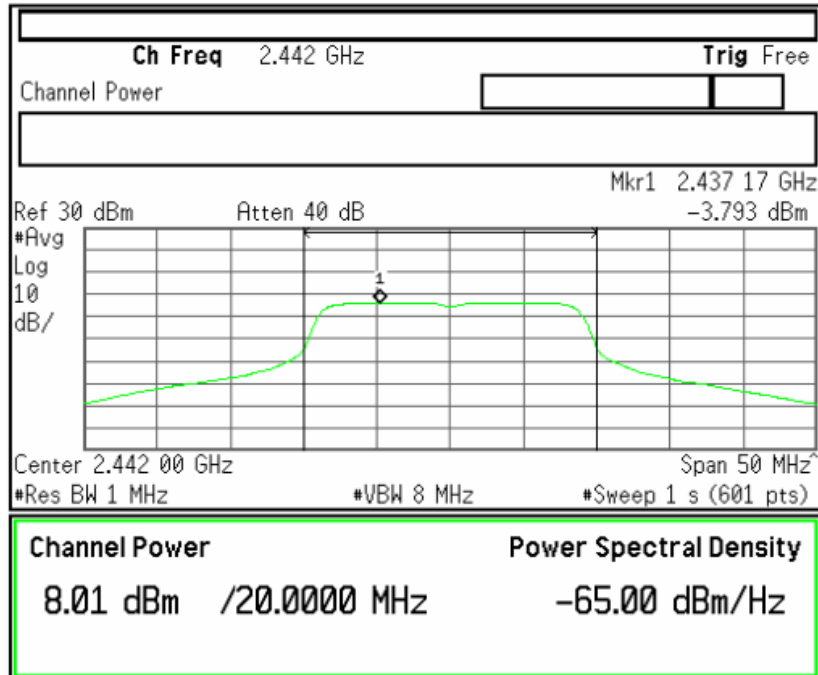

[2 472 MHz]

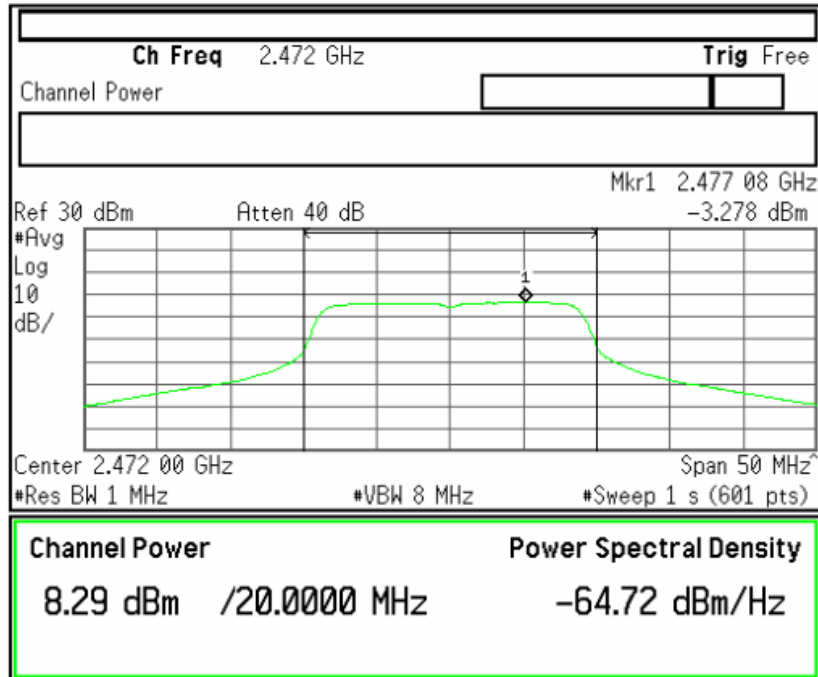

### Plots of Maximum Peak Output Power Bandwidth (802.11n(HT40))

[2 422 MHz]

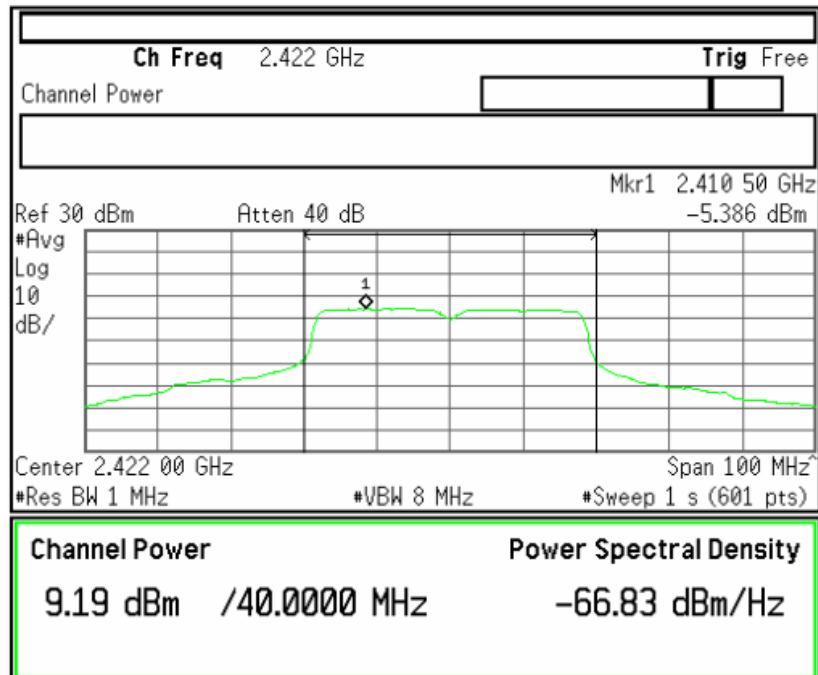

[2 442 MHz]

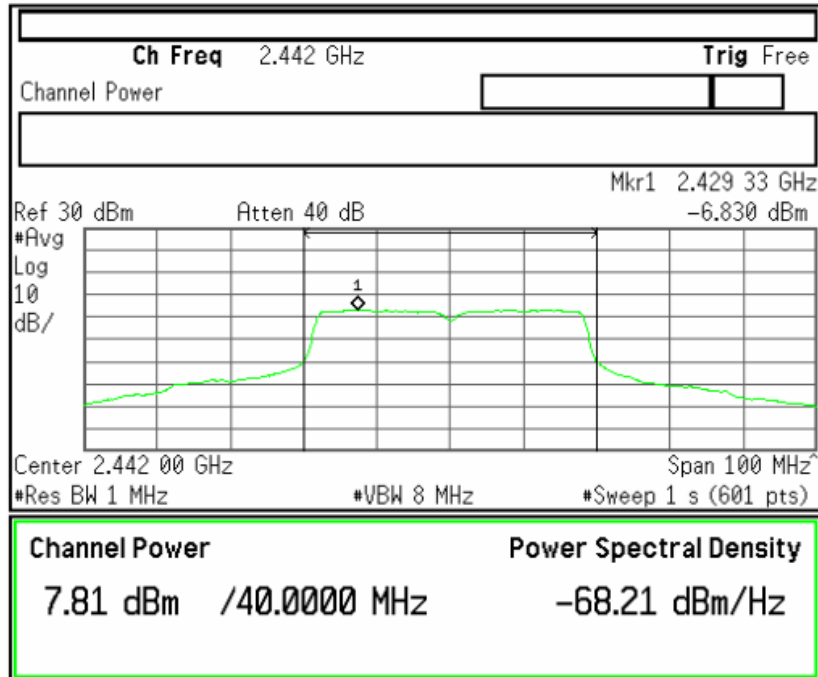

[2 462 MHz]

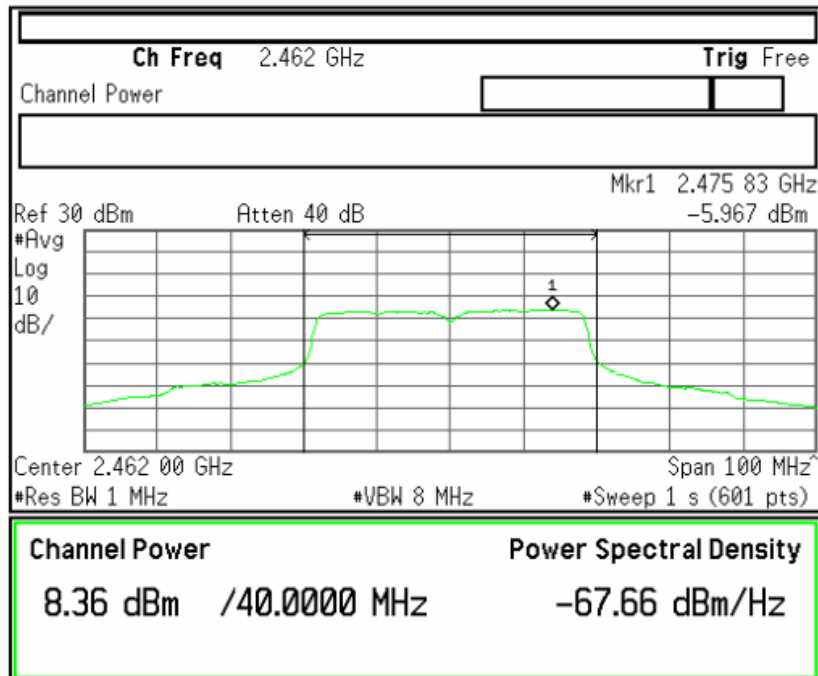

## 5.4 Bandwidth of Frequency Band Edges

EUT	BLACKVUE SPORT / SC300
Limit apply to	FCC Part 15.247(d)
Test Date	April 08, 2014
Environmental of Test	21.5 °C, 47 % R.H., 101.0 kPa
Operating Condition	RF transmitting continuously during the tested.
Result	Passed

### Limit

In any 100 kHz bandwidth outside the frequency band in which the spread spectrum or digitally modulated intentional radiator is operating, the radio frequency power that is produced by the intentional radiator shall be at least 20 dB below that in the 100 kHz bandwidth within the band that contains the highest level of the desired power, based on either an RF conducted or a radiated measurement, provided the transmitter demonstrates compliance with the peak conducted power limits. If the transmitter complies with the conducted power limits based on the use of RMS averaging over a time interval, as permitted under paragraph (b)(3) of this section, the attenuation required under this paragraph shall be 30 dB instead of 20 dB. Attenuation below the general limits specified in Section 15.209(a) is not required. In addition, radiated emissions which fall in the restricted bands, as defined in Section 15.205(a), must also comply with the radiated emission limits specified in Section 15.209(a) (see Section 15.205(c)).

### Test Results

- Refer to see the measured plot in next page.

### NOTES:

1. The test was performed to make a direct field strength measurement at the band edge frequencies.

## Plots of Bandwidth of Frequency Band Edges (802.11b)

Conducted

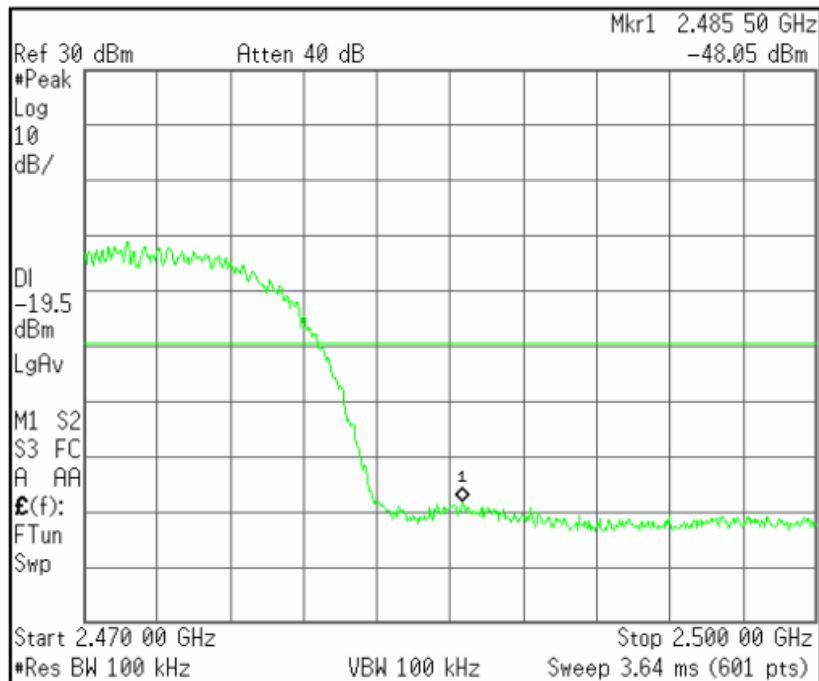
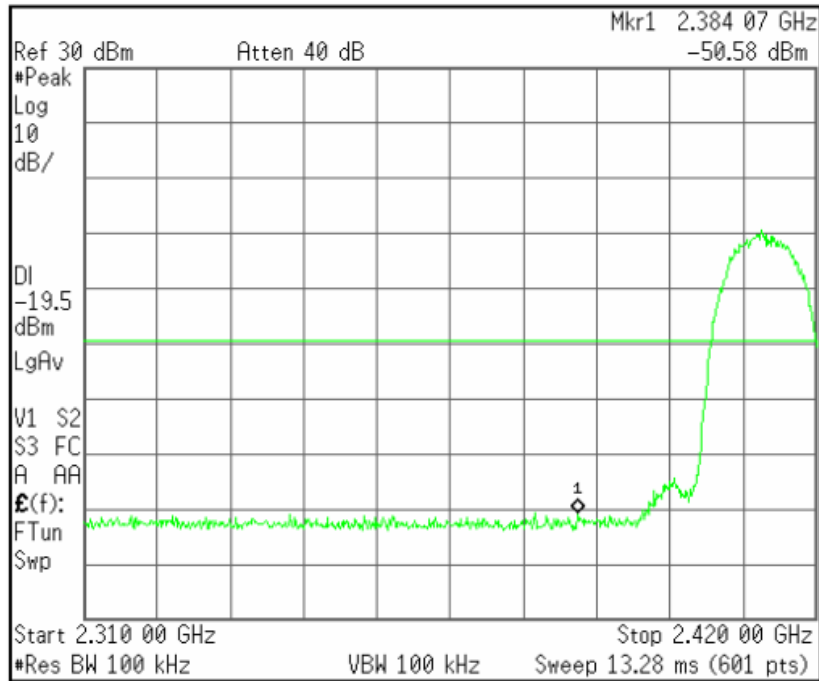

## Radiated

Peak Detector: RBW: 1 MHz, VBW: 1 MHz (2 310 MHz - 2 390 MHz), Worst case (Low, Horizontal)

— Peak Limit Line  
 — AV Limit Line

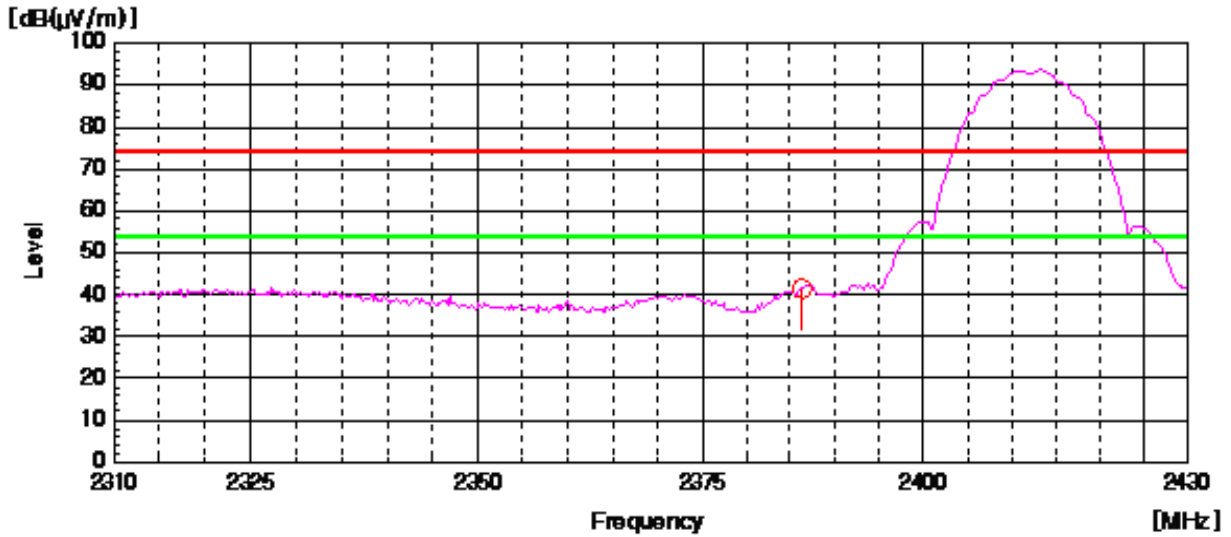

AV Detector: RBW: 1 MHz, VBW: 10 Hz (2 310 MHz - 2 390 MHz), Worst case (Low, Horizontal)

— Peak Limit Line  
 — AV Limit Line

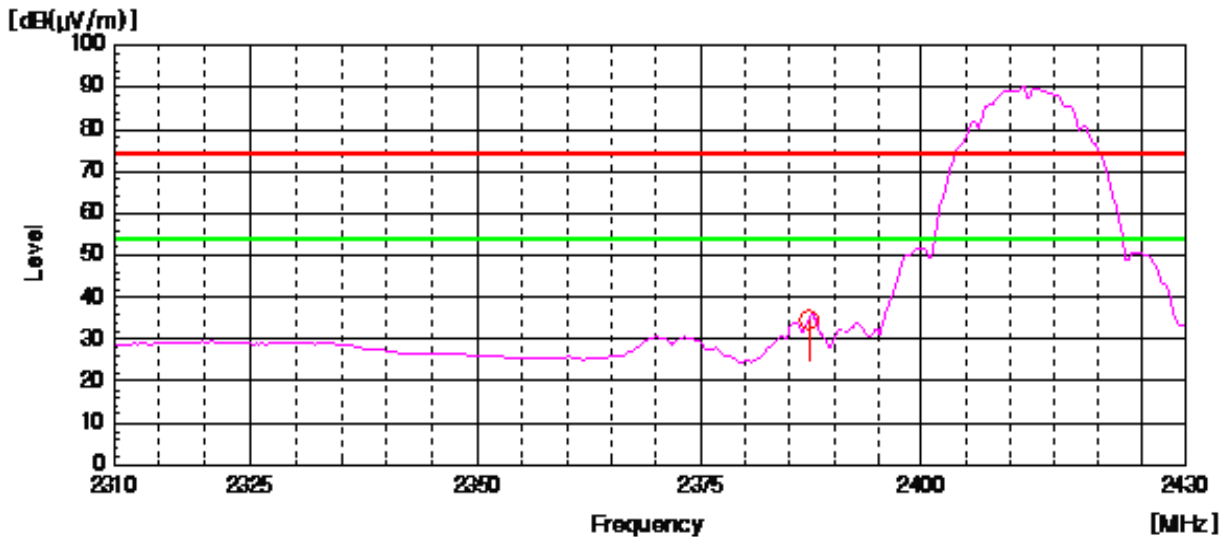

Peak Detector: RBW: 1 MHz, VBW: 1 MHz (2 483.5 MHz - 2 500 MHz), Worst case (High, Horizontal)

— Peak Limit Line  
 — AV Limit Line

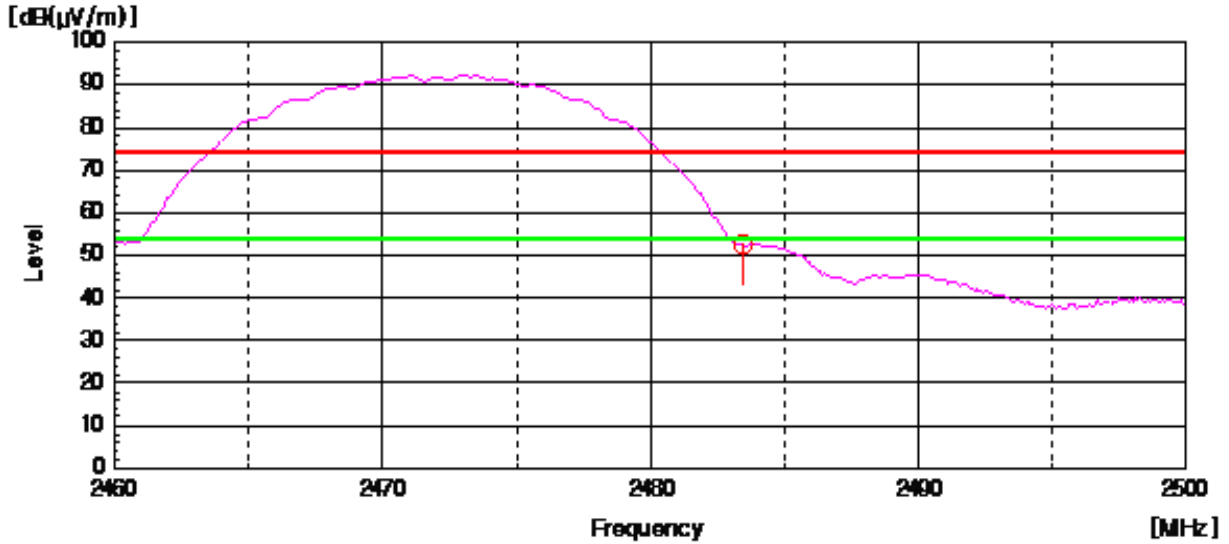

AV Detector: RBW: 1 MHz, VBW: 10 Hz (2 483.5 MHz - 2 500 MHz), Worst case (High, Horizontal)

— Peak Limit Line  
 — AV Limit Line

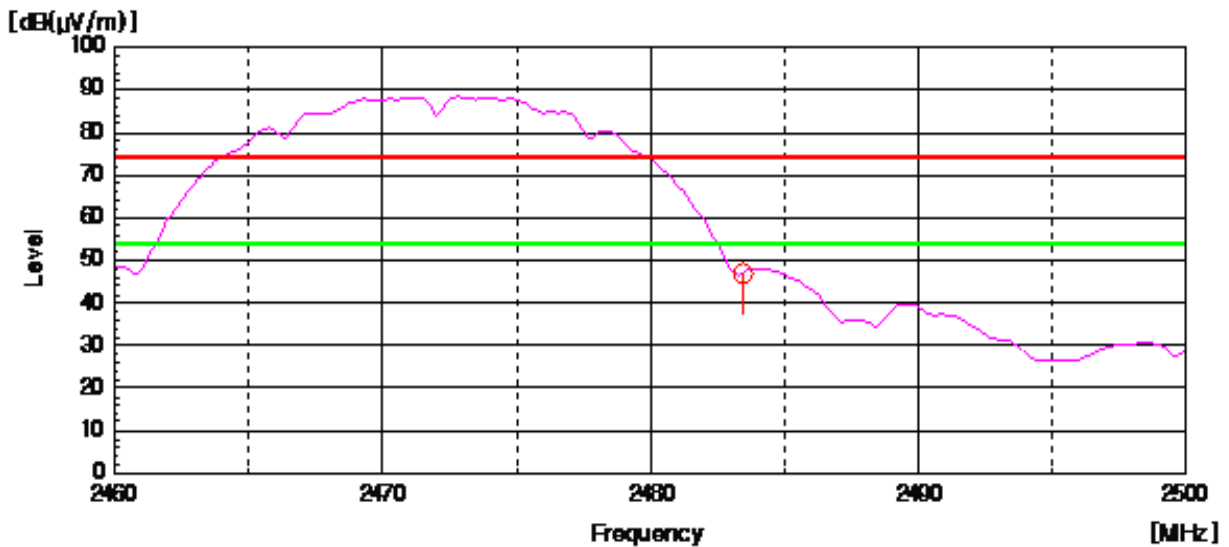



## Plots of Bandwidth of Frequency Band Edges (802.11g)

Conducted

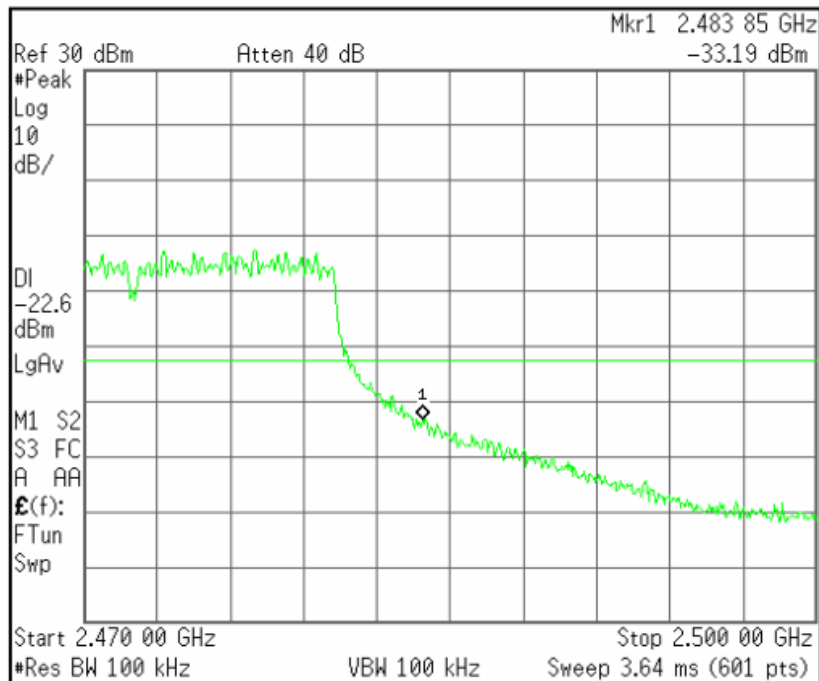
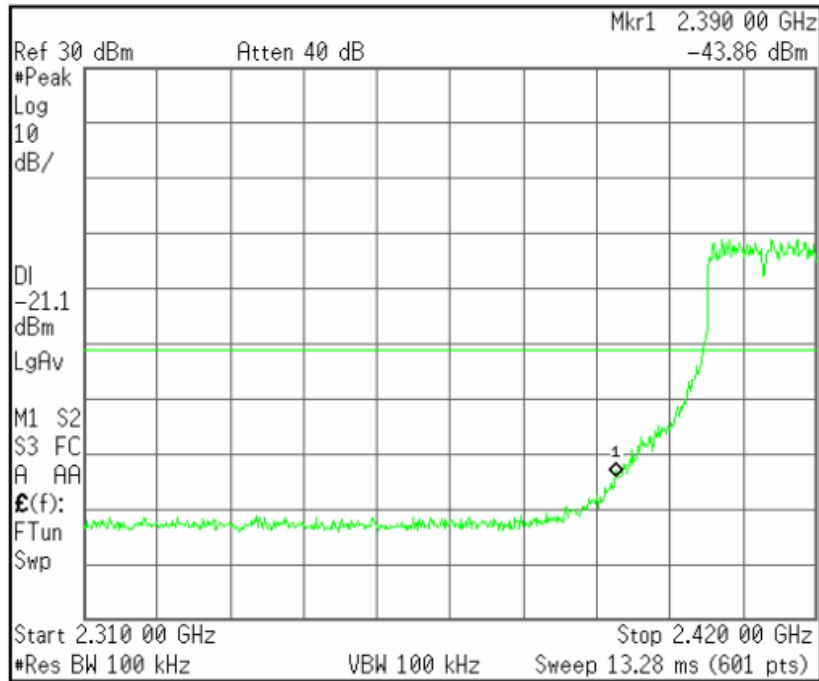

## Radiated

Peak Detector: RBW: 1 MHz, VBW: 1 MHz (2 310 MHz - 2 390 MHz), Worst case (Low, Horizontal)

— Peak Limit Line  
 — AV Limit Line

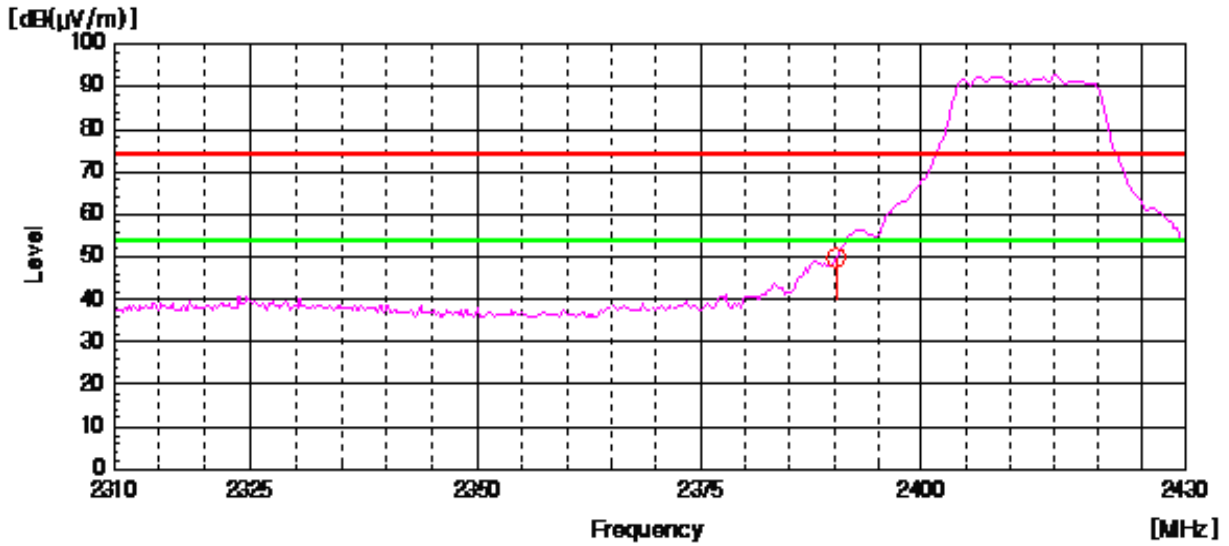

AV Detector: RBW: 1 MHz, VBW: 10 Hz (2 310 MHz - 2 390 MHz), Worst case (Low, Horizontal)

— Peak Limit Line  
 — AV Limit Line

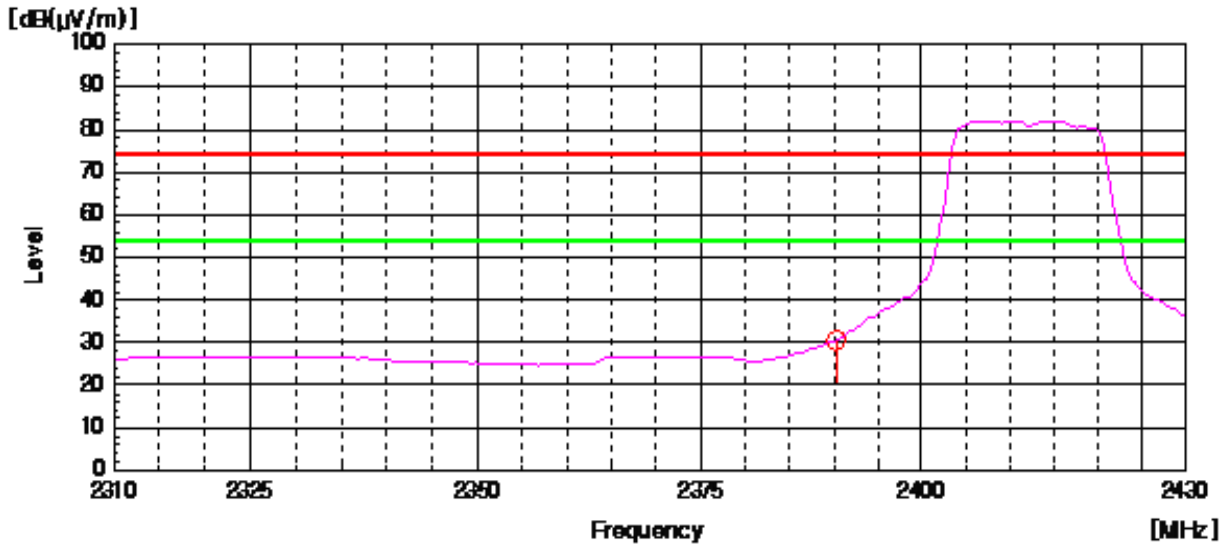

Peak Detector: RBW: 1 MHz, VBW: 1 MHz (2 483.5 MHz - 2 500 MHz), Worst case (High, Horizontal)

— Peak Limit Line  
 — AV Limit Line

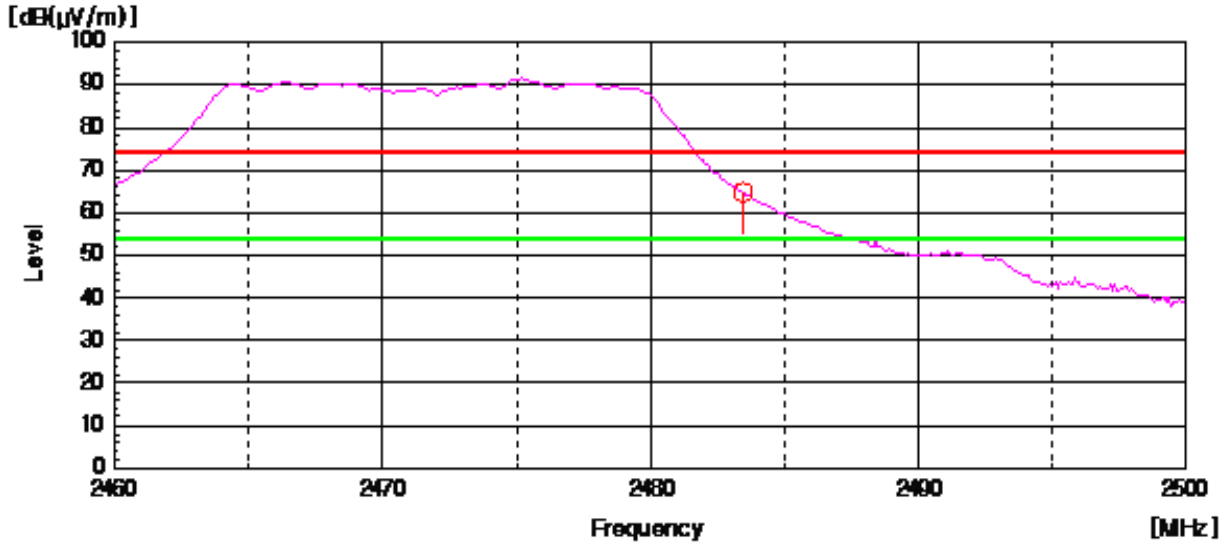

AV Detector: RBW: 1 MHz, VBW: 10 Hz (2 483.5 MHz - 2 500 MHz), Worst case (High, Horizontal)

— Peak Limit Line  
 — AV Limit Line

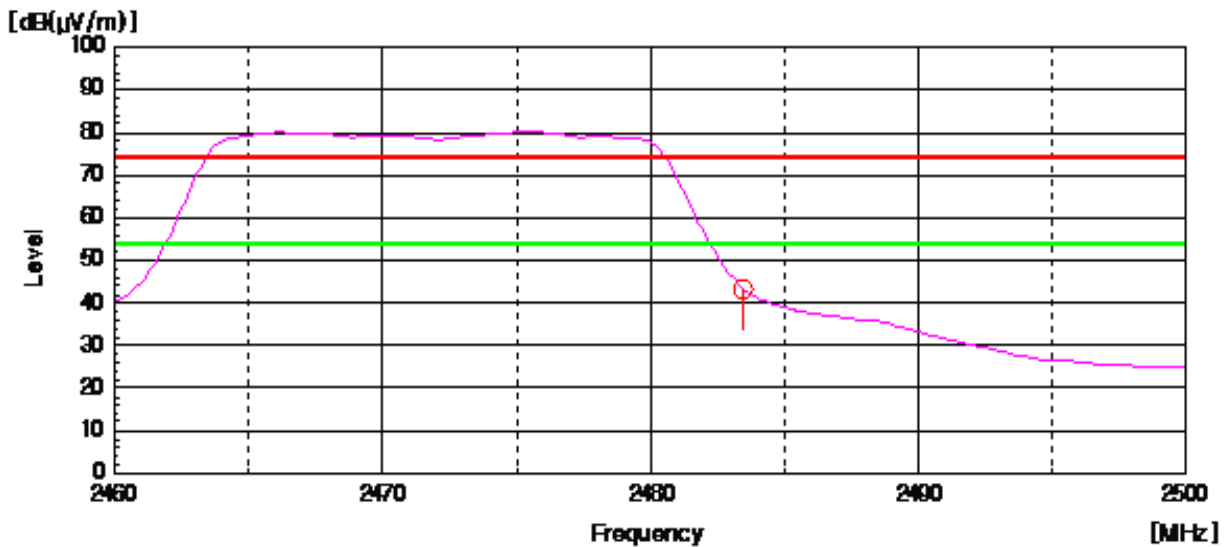

## Plots of Bandwidth of Frequency Band Edges (802.11n(HT20))

Conducted

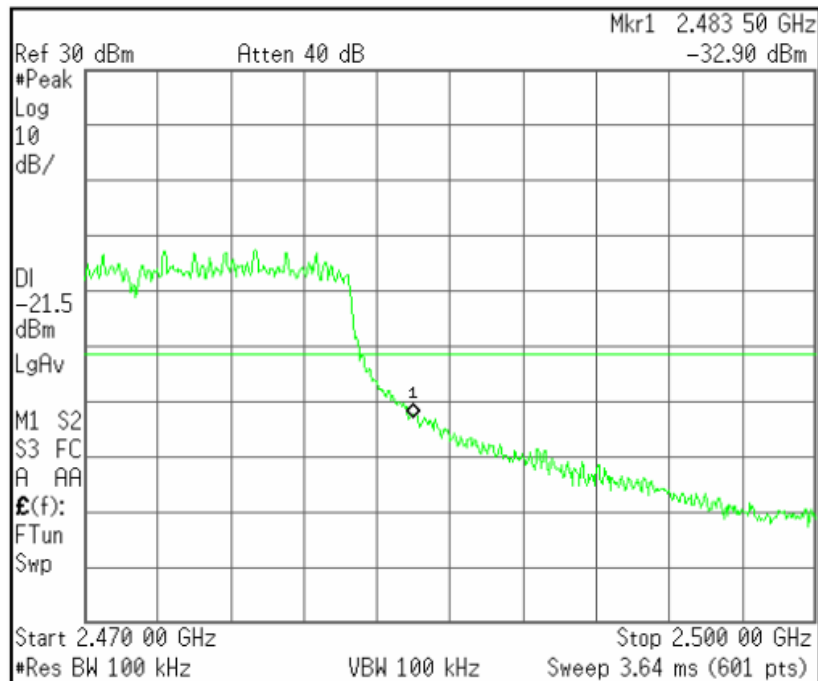
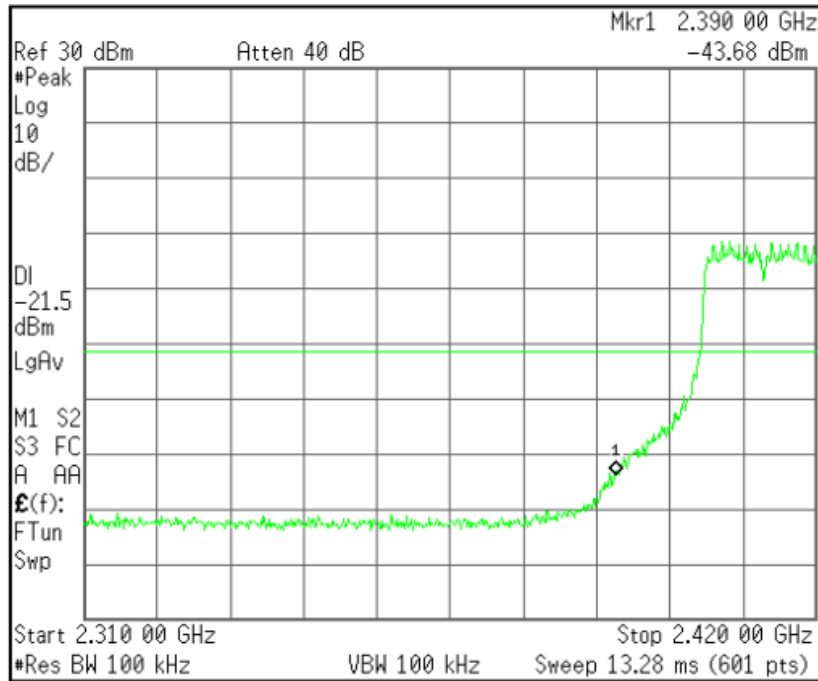

## Radiated

Peak Detector: RBW: 1 MHz, VBW: 1 MHz (2 310 MHz - 2 390 MHz), Worst case (Low, Horizontal)

— Peak Limit Line  
 — AV Limit Line

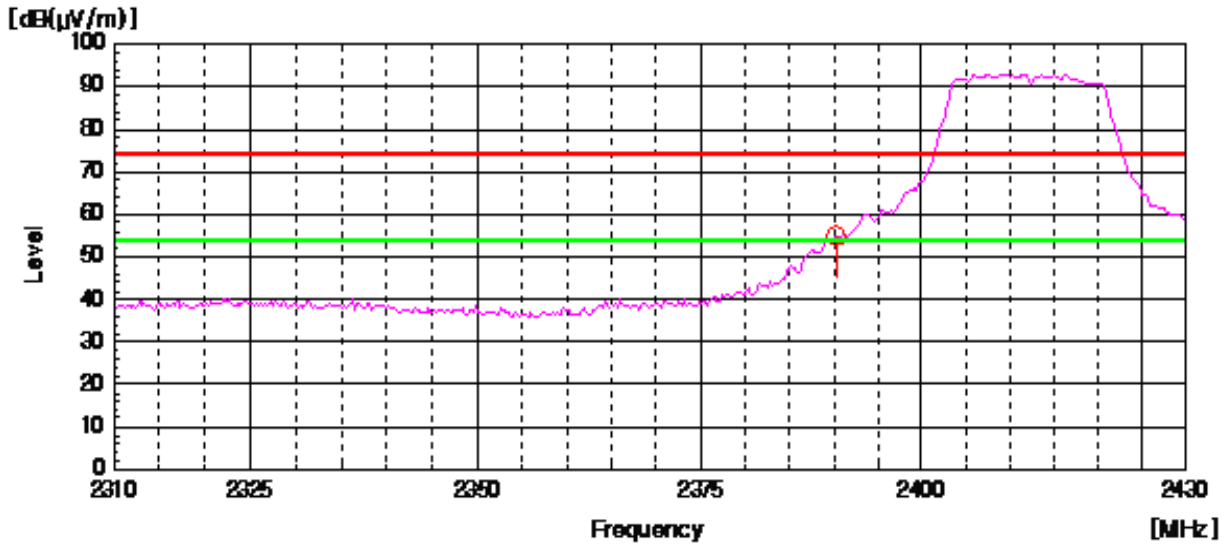

AV Detector: RBW: 1 MHz, VBW: 10 Hz (2 310 MHz - 2 390 MHz), Worst case (Low, Horizontal)

— Peak Limit Line  
 — AV Limit Line

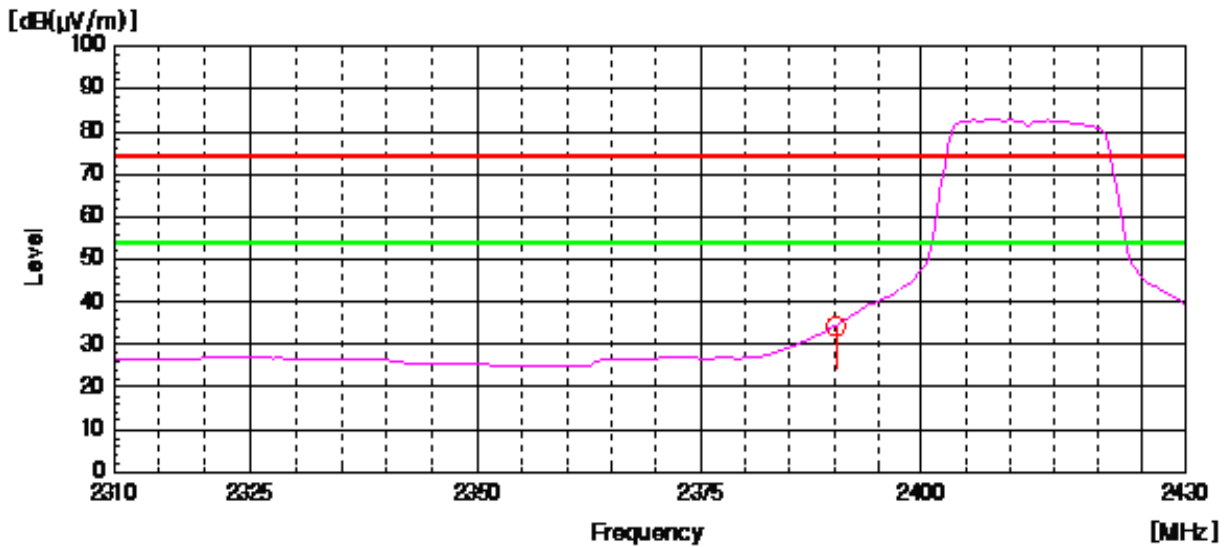

Peak Detector: RBW: 1 MHz, VBW: 1 MHz (2 483.5 MHz - 2 500 MHz), Worst case (High, Horizontal)

— Peak Limit Line  
 — AV Limit Line

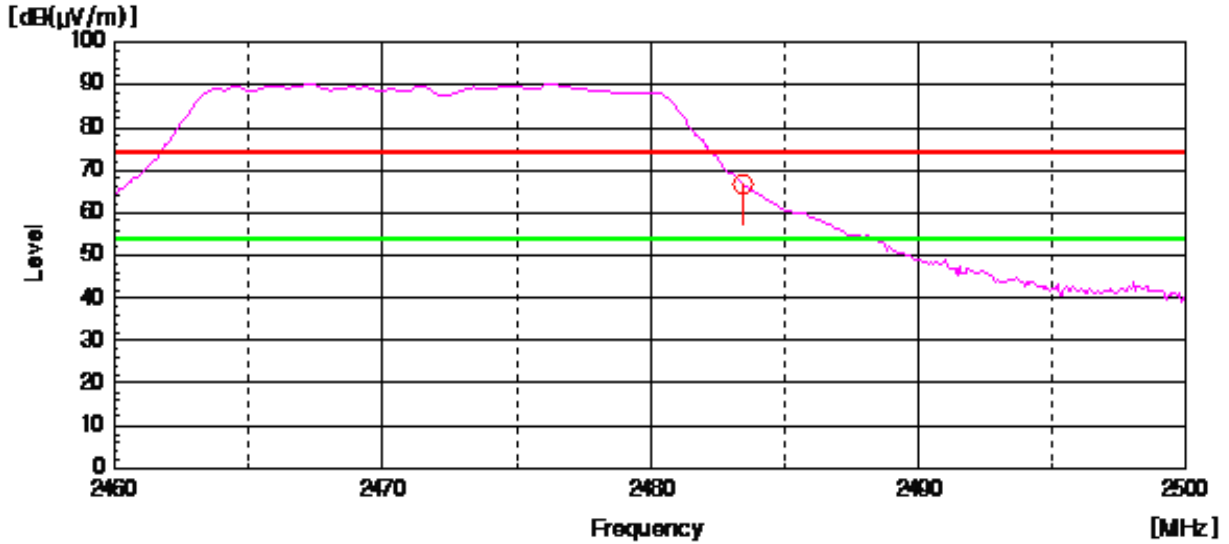

AV Detector: RBW: 1 MHz, VBW: 10 Hz (2 483.5 MHz - 2 500 MHz), Worst case (High, Horizontal)

— Peak Limit Line  
 — AV Limit Line

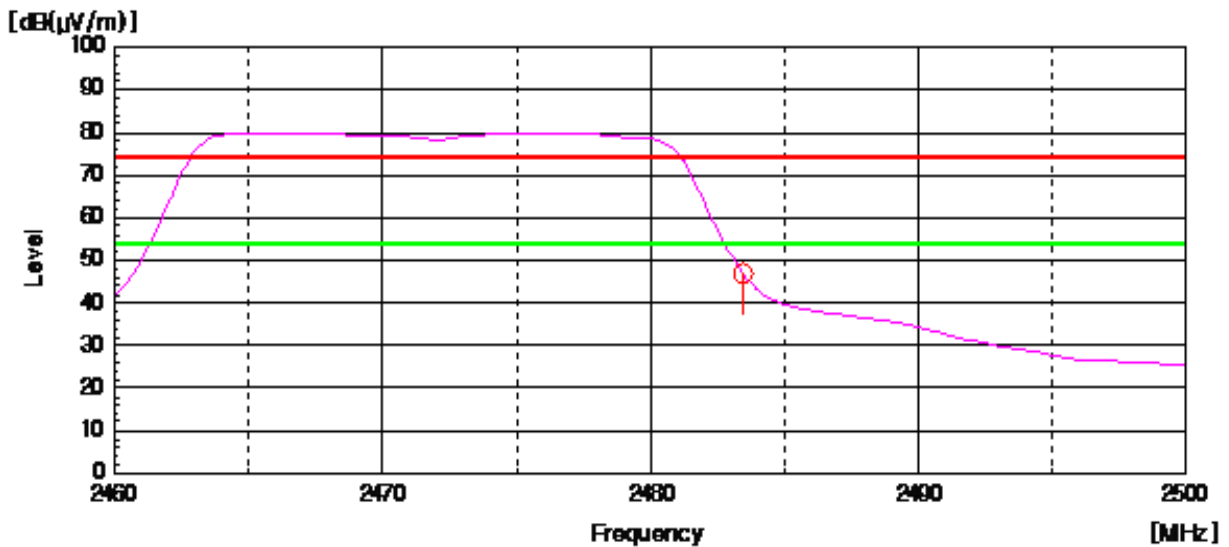

## Plots of Bandwidth of Frequency Band Edges (802.11n(HT40))

Conducted

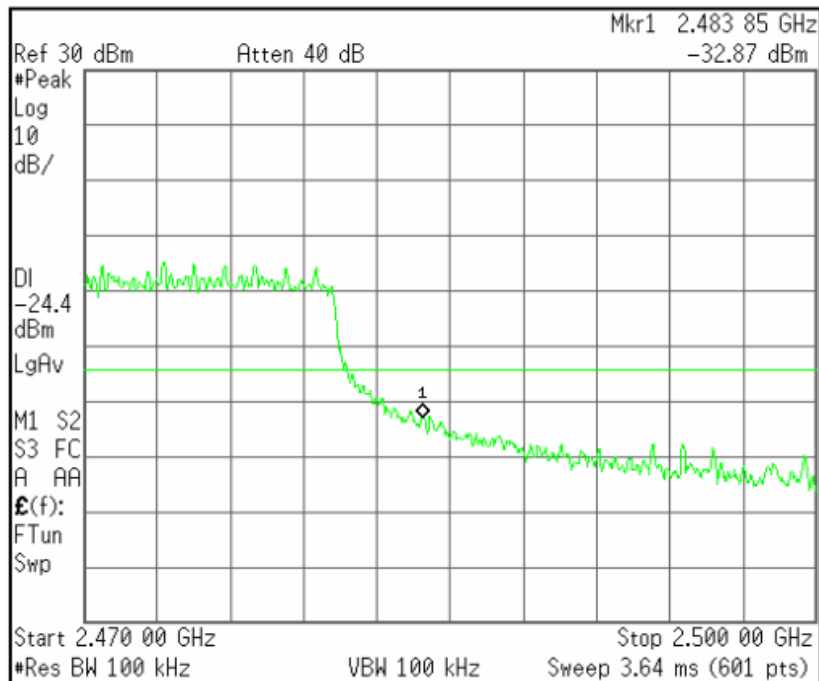
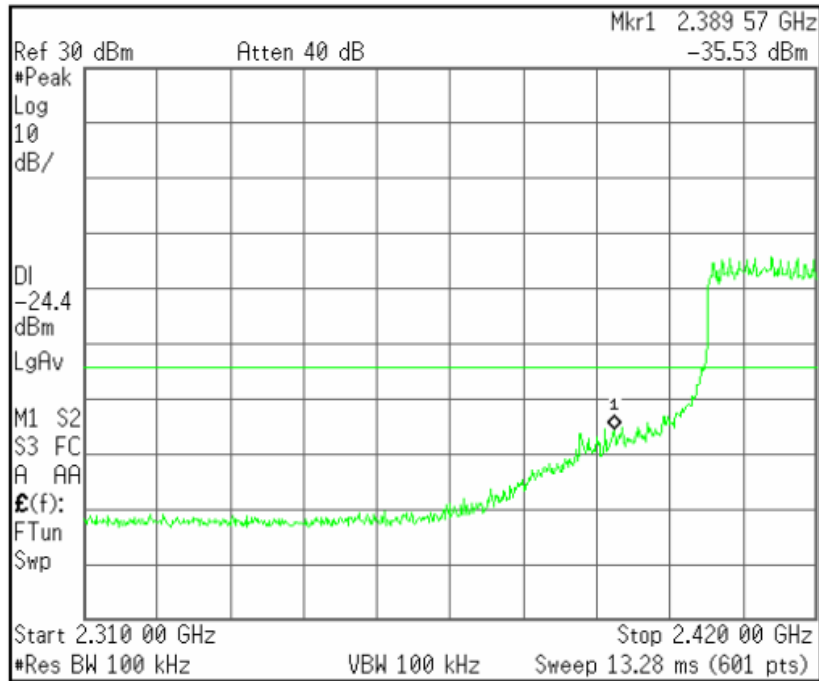

## Radiated

Peak Detector: RBW: 1 MHz, VBW: 1 MHz (2 310 MHz - 2 390 MHz), Worst case (Low, Horizontal)

— Peak Limit Line  
 — AV Limit Line

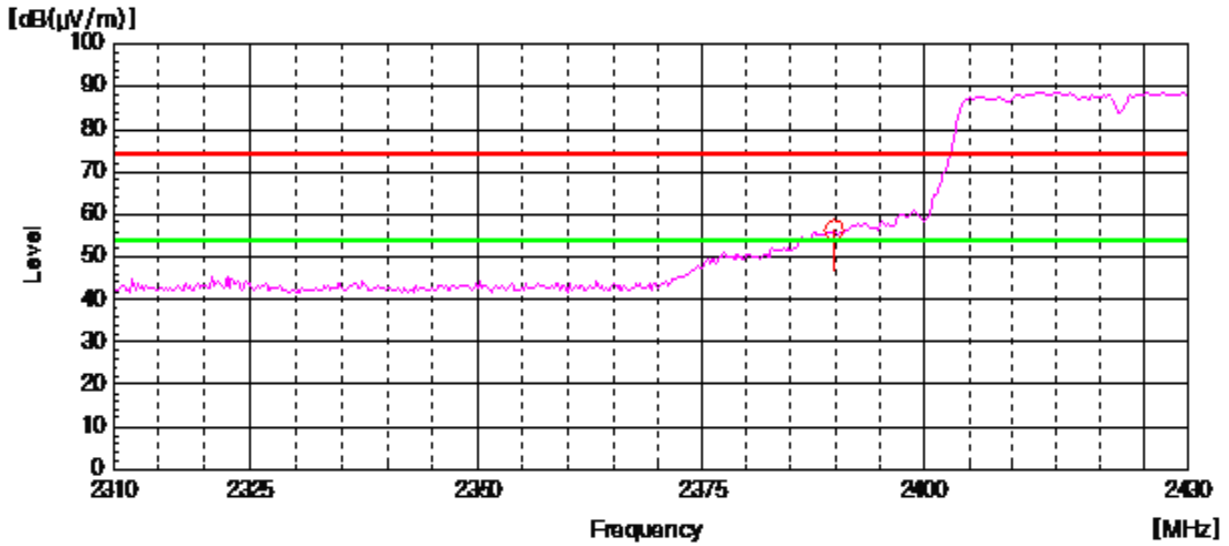

AV Detector: RBW: 1 MHz, VBW: 10 Hz (2 310 MHz - 2 390 MHz), Worst case (Low, Horizontal)

— Peak Limit Line  
 — AV Limit Line

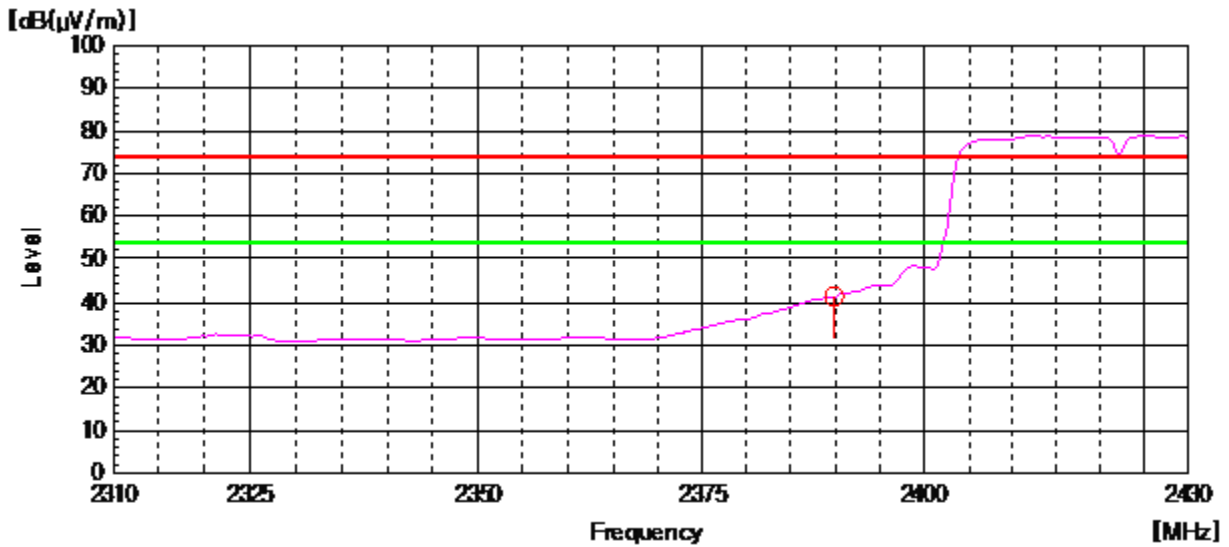



Peak Detector: RBW: 1 MHz, VBW: 1 MHz (2 483.5 MHz - 2 500 MHz), Worst case (High, Horizontal)

— Peak Limit Line  
 — AV Limit Line

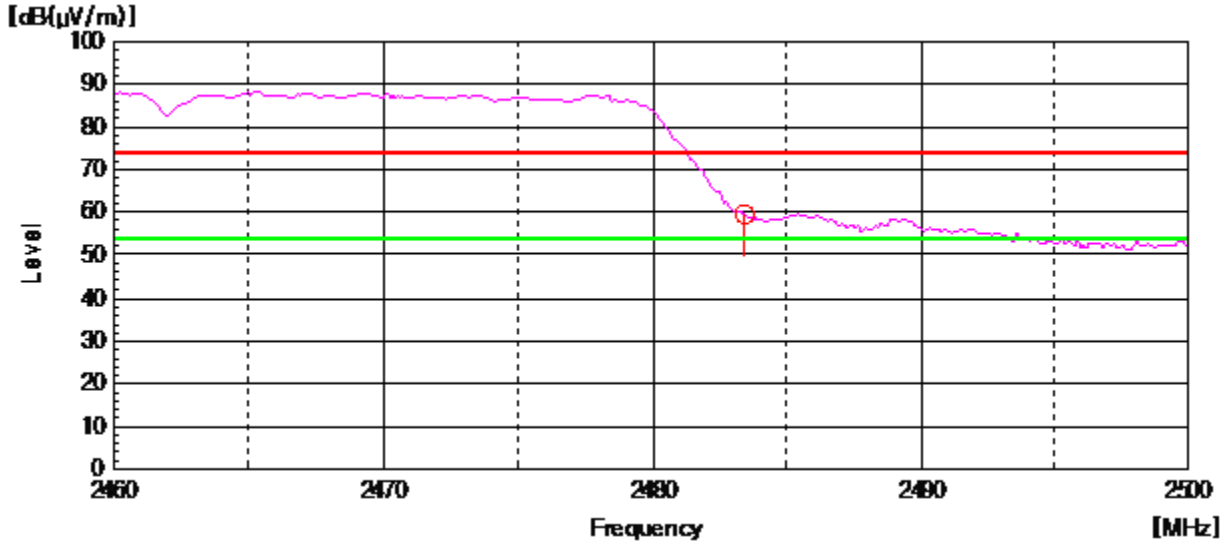

AV Detector: RBW: 1 MHz, VBW: 10 Hz (2 483.5 MHz - 2 500 MHz), Worst case (High, Horizontal)

— Peak Limit Line  
 — AV Limit Line

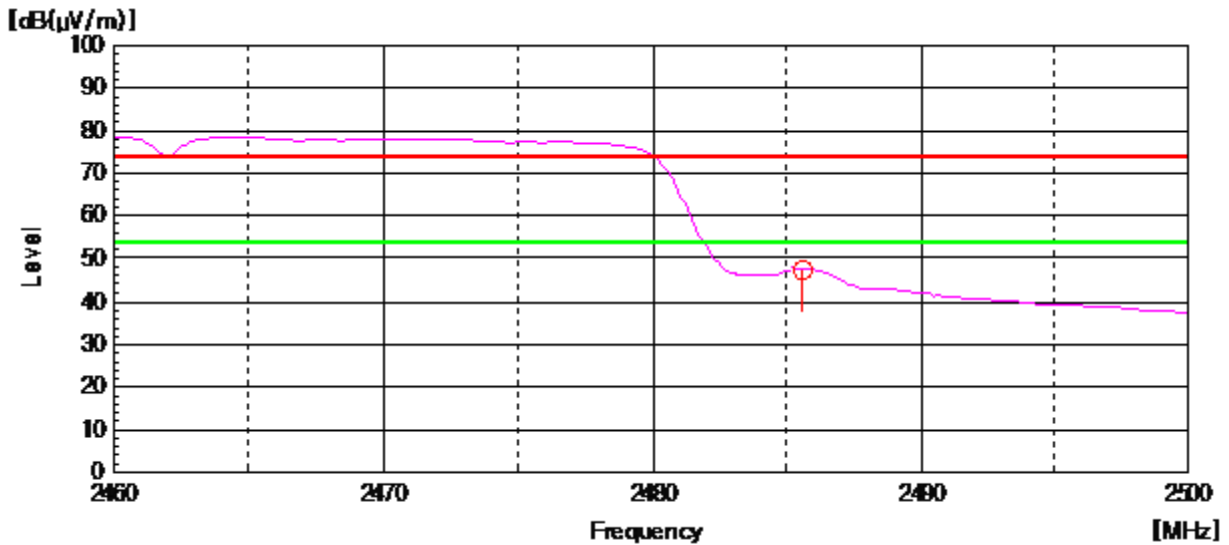

## 5.5 Power Spectral Density

EUT	BLACKVUE SPORT / SC300
Limit apply to	FCC Part 15.247(e)
Test Date	April 08, 2014
Environmental of Test	20.9 °C, 48 % R.H., 101.1 kPa
Operating Condition	RF transmitting continuously during the tested.
Result	Passed

### Limit

For digitally modulated systems, the power spectral density conducted from the intentional radiator to the antenna shall not be greater than 8 dBm in any 3 kHz band during any time interval of continuous transmission. This power spectral density shall be determined in accordance with the provisions of paragraph (b) of this section. The same method of determining the conducted output power shall be used to determine the power spectral density.

### Test Data

Mode	Frequency [MHz]	PSD [dBm]	Limit
802.11b	2 412	0.48	8.00 dBm
	2 442	-1.60	
	2 472	-1.26	
802.11g	2 412	-1.16	
	2 442	-2.83	
	2 472	-3.11	
802.11n(HT20)	2 412	-1.14	
	2 442	-3.14	
	2 472	-2.65	
802.11n(HT40)	2 422	-4.67	
	2 442	-5.87	
	2 462	-5.01	

### NOTES:

1. Measure power spectral density of relevant channel using spectrum analyzer.
2. RBW 100 kHz, VBW 300 kHz, span 1 MHz, Sweep time (= span / 3 kHz).
3. Please see the measured plot in next page.

## Plots of Power Spectral Density (802.11b)

[2 412 MHz]

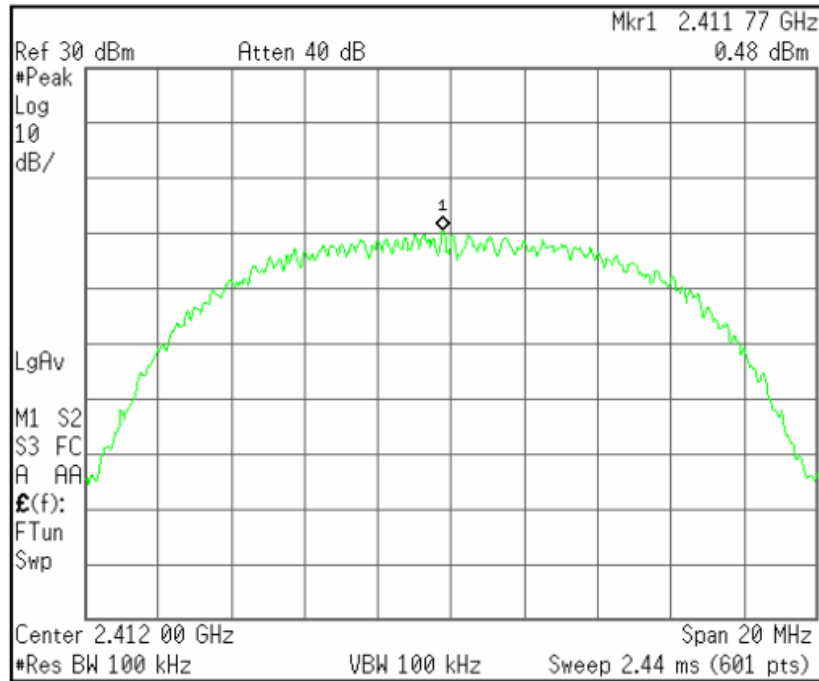

[2 442 MHz]

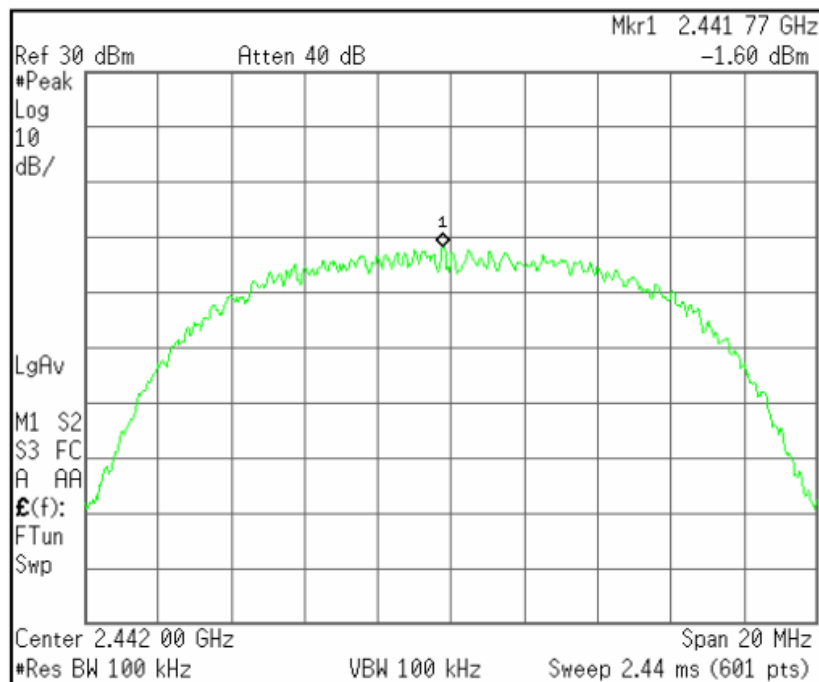

[2 472 MHz]

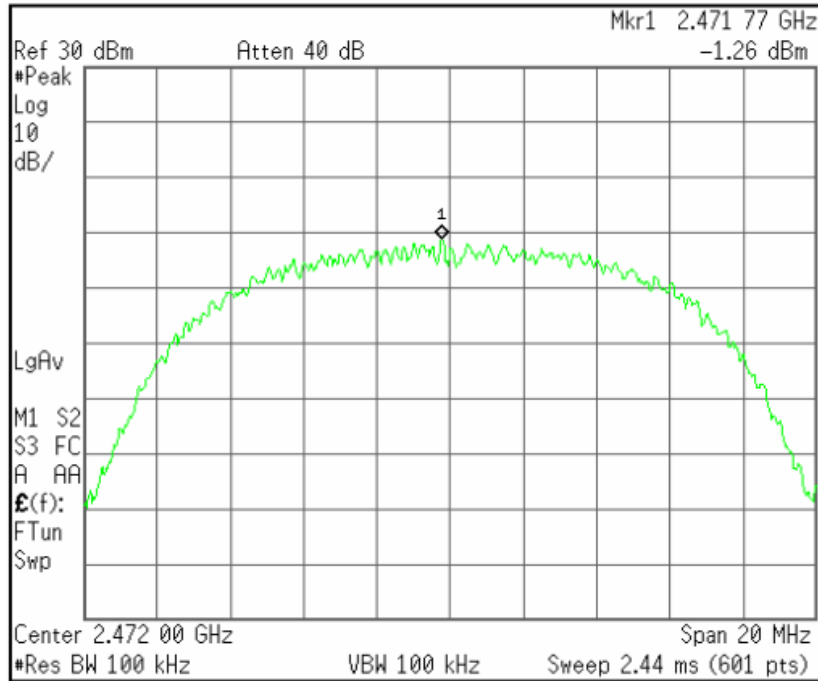

## Plots of Power Spectral Density (802.11g)

[2 412 MHz]

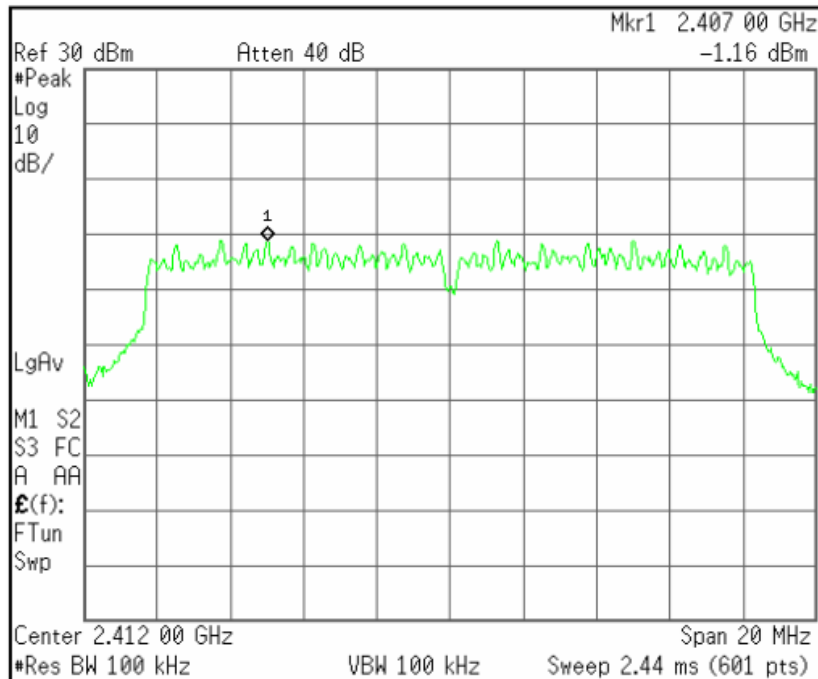

[2 442 MHz]

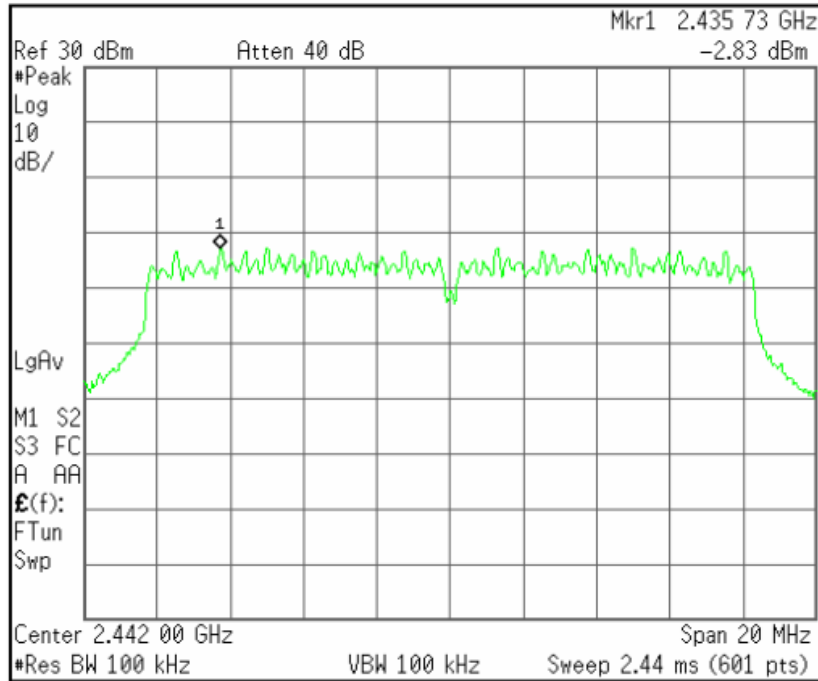

[2 472 MHz]

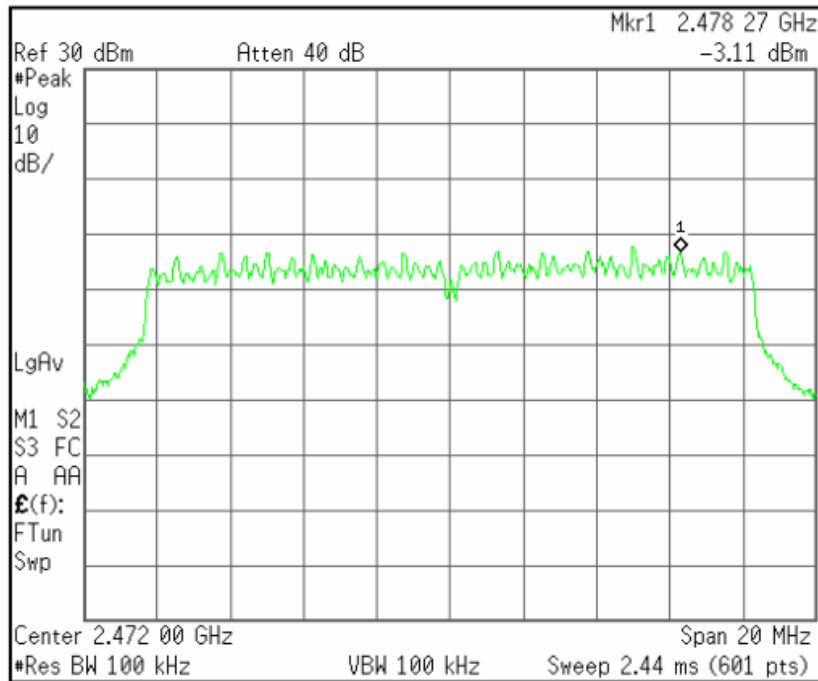

## Plots of Power Spectral Density (802.11n(HT20))

[2 412 MHz]

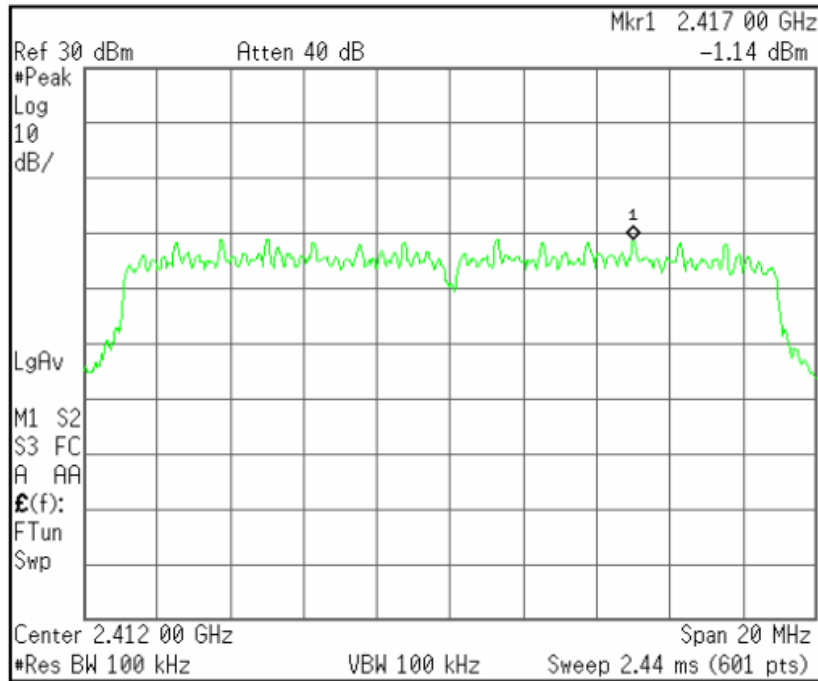

[2 442 MHz]

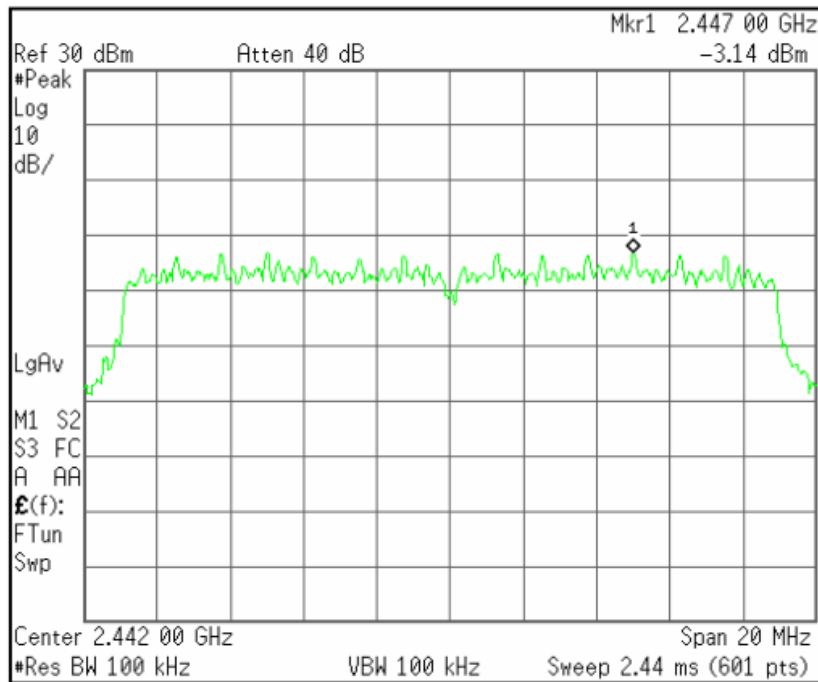

[2 472 MHz]

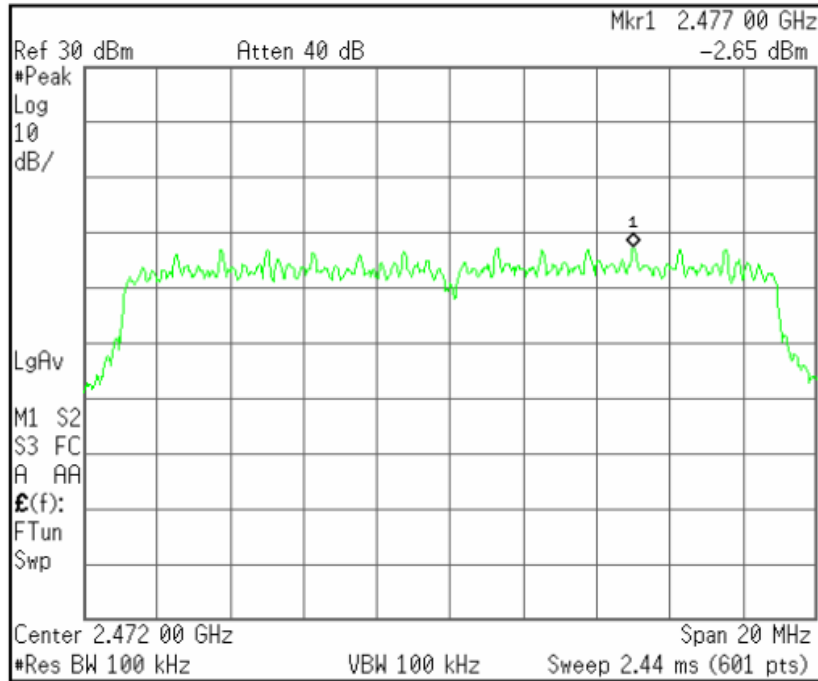

## Plots of Power Spectral Density (802.11n(HT40))

[2 422 MHz]

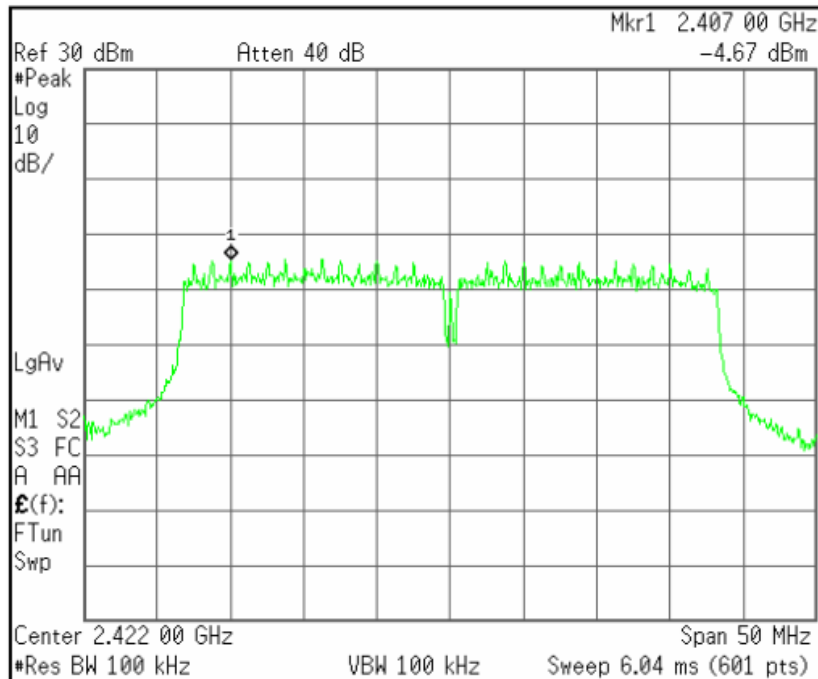

[2 442 MHz]

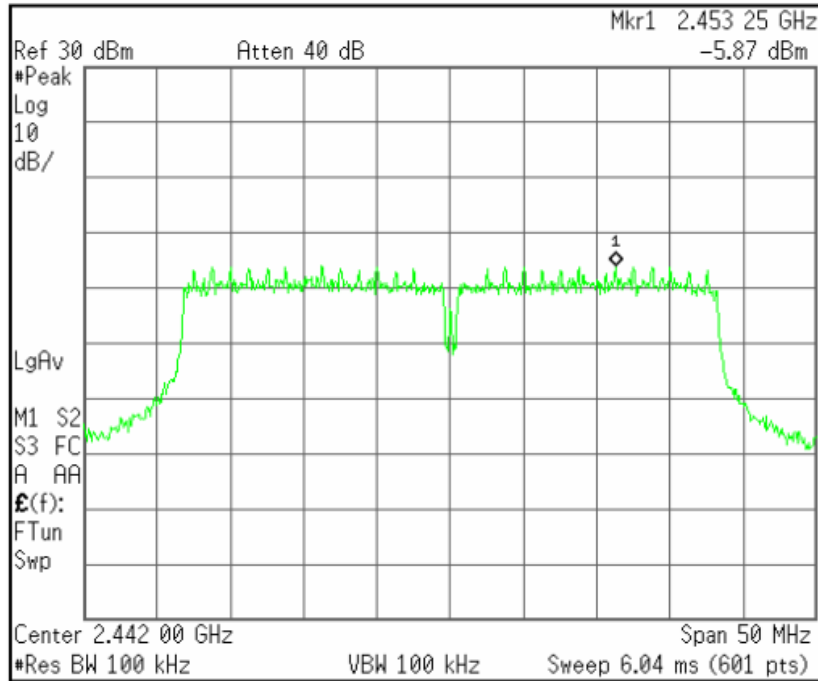

[2 462 MHz]

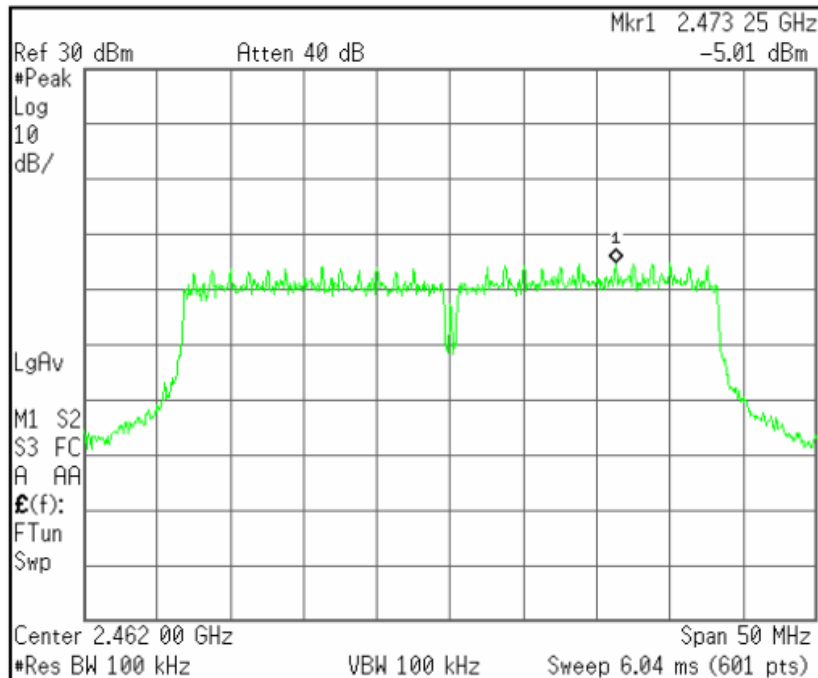



## 5.6 Spurious Emissions

EUT	BLACKVUE SPORT / SC300
Limit apply to	FCC Part 15.209
Test Date	April 09, 2014 to April 10, 2014
Environmental of Test	(17.3 ± 4.8) °C, (55 ± 10) % R.H., (101.4 ± 0.2) kPa
Operating Condition	Low CH, Middle CH, High CH Transmission
Result	Passed

### Limit

Except as provided elsewhere in this Subpart, the emissions from an intentional radiator shall not exceed the field strength levels specified in the following table:

Frequencies [MHz]	Field Strength [ $\mu$ V/m]	Measurement Distance [m]
0.009 - 0.490	2 400/F(kHz)	300
0.490 - 1.705	24 000/F(kHz)	30
1.705 - 30.0	30	30
30 - 88	100	3
88 - 216	150	3
216 - 960	200	3
Above 960	500	3

\* Except as provided in paragraph (g), fundamental emissions from intentional radiators operating under this Section shall not be located in the frequency bands 54 MHz - 72 MHz, 76 MHz - 88 MHz, 174 MHz - 216 MHz or 470 MHz - 806 MHz. However, operation within these frequency bands is permitted under other sections of this Part, e.g., Sections 15.231 and 15.241.

### Test Results

- Refer to see the measured plot in next page.

## Radiated Emissions Test data

### - 9 kHz to 30 MHz

Test Date	April 09, 2014
Environmental of Test	12.5 °C, 64 % R.H., 101.5 kPa

- 802.11b, 802.11g, 802.11n(HT20) and 802.11n(HT40) mode

The following table shows the highest levels of radiated emissions on both polarizations of horizontal and vertical.  
 Detector mode: CISPR Quasi-Peak mode (100 Hz, 9 kHz)

Frequency [MHz]	Reading [dB(μV)]	Polarization (*H/**V)	Ant. Factor [dB/m]	Cable Loss [dB]	Result [dB(μV/m)]	Limit [dB(μV/m)]	Margin [dB]
	<b>Emission attenuated more than 20 dB below the limit are not reported.</b>						

**Result: All emissions below noise floor of 20 dB(μV/m).**

NOTES:

1. \* H : Horizontal polarization , \*\* V : Vertical polarization
2. Result = Reading + Antenna factor + Cable loss
3. Margin = Limit - Result
4. The measurement was performed for the frequency range 9 kHz to 30 MHz according to FCC Part 15.209.

**- Below 1 GHz (30 MHz to 1 GHz)**

Test Date	April 09, 2014
Environmental of Test	13.6 °C, 60 % R.H., 101.5 kPa

**- 802.11b mode**

The following table shows the highest levels of radiated emissions on both polarizations of horizontal and vertical.  
 Detector mode: CISPR Quasi-Peak mode (6 dB Bandwidth: 120 kHz)

Frequency [MHz]	Reading [dB(μV)]	Polarization (*H/**V)	Ant. Factor [dB/m]	Cable Loss [dB(μV)]	Height [cm]	Result [dB(μV/m)]	Limit [dB(μV/m)]	Margin [dB]
32.50	12.03	V	10.51	0.96	100	23.50	40.00	16.50
136.70	8.89	V	12.27	1.54	105	22.70	43.50	20.80
190.05	14.35	V	10.21	1.74	116	26.30	43.50	17.20
255.52	9.55	H	11.53	1.92	386	23.00	46.00	23.00
296.75	9.45	H	12.99	2.16	350	24.60	46.00	21.40
316.15	12.85	H	13.51	2.24	310	28.60	46.00	17.40
461.65	5.39	H	17.29	2.82	295	25.50	46.00	20.50

**NOTES:**

- \* H : Horizontal polarization , \*\* V : Vertical polarization
- Result = Reading + Antenna factor + Cable loss
- Margin value = Limit - Result
- The measurement was performed for the frequency range above 30 MHz according to FCC Part 15.209.

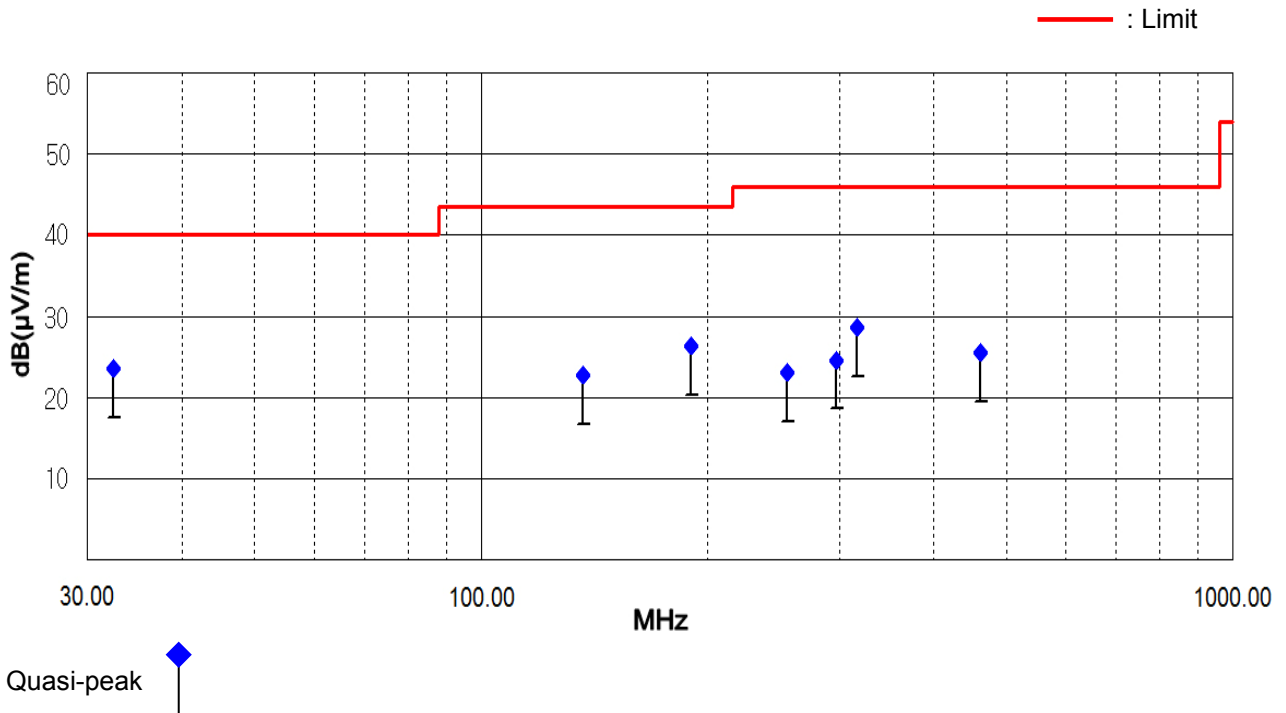

- 802.11g mode

The following table shows the highest levels of radiated emissions on both polarizations of horizontal and vertical.  
 Detector mode: CISPR Quasi-Peak mode (6 dB Bandwidth: 120 kHz)

Frequency [MHz]	Reading [dB(μV)]	Polarization (*H/**V)	Ant. Factor [dB/m]	Cable Loss [dB(μV)]	Height [cm]	Result [dB(μV/m)]	Limit [dB(μV/m)]	Margin [dB]
32.50	11.13	V	10.51	0.96	100	22.60	40.00	17.40
136.70	9.69	V	12.27	1.54	106	23.50	43.50	20.00
190.10	14.16	V	10.20	1.74	112	26.10	43.50	17.40
255.50	9.65	H	11.53	1.92	350	23.10	46.00	22.90
296.75	9.15	H	12.99	2.16	330	24.30	46.00	21.70
316.20	12.64	H	13.52	2.24	310	28.40	46.00	17.60
461.65	5.69	H	17.29	2.82	285	25.80	46.00	20.20

NOTES:

- \* H : Horizontal polarization , \*\* V : Vertical polarization
- Result = Reading + Antenna factor + Cable loss
- Margin value = Limit - Result
- The measurement was performed for the frequency range above 30 MHz according to FCC Part 15.209.

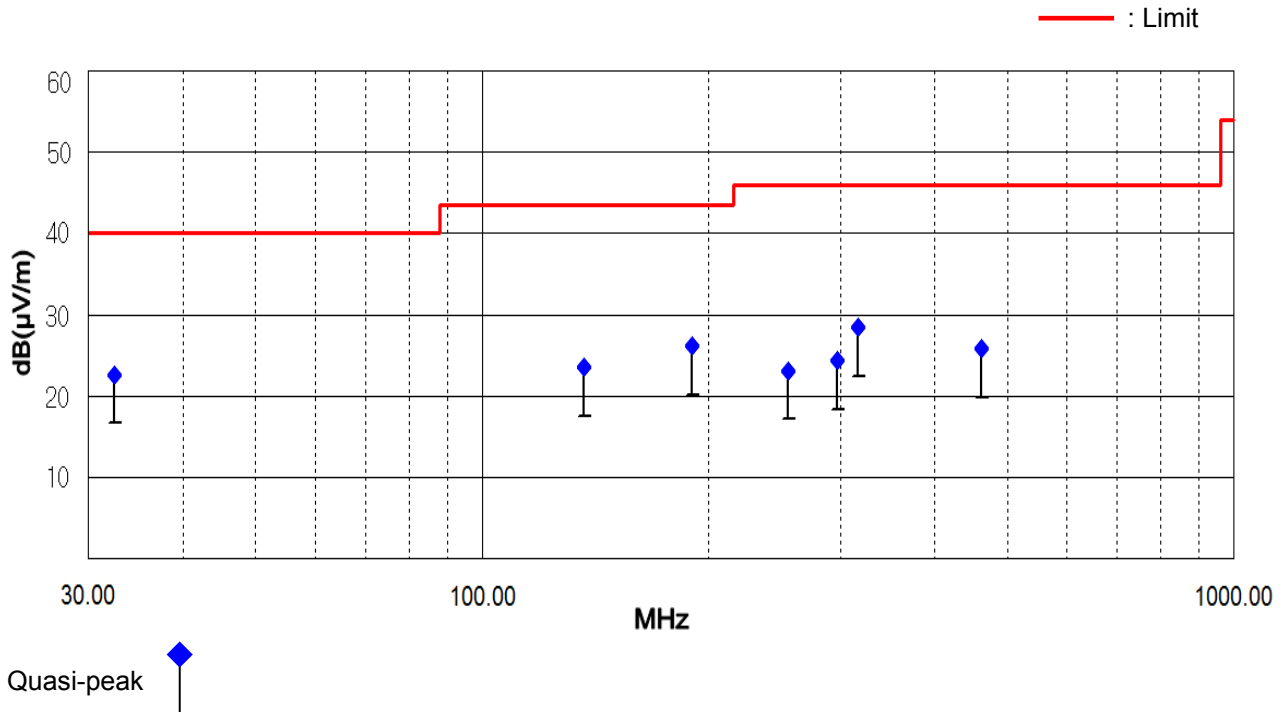

- 802.11n(HT20) mode

The following table shows the highest levels of radiated emissions on both polarizations of horizontal and vertical.  
 Detector mode: CISPR Quasi-Peak mode (6 dB Bandwidth: 120 kHz)

Frequency [MHz]	Reading [dB(μV)]	Polarization (*H/**V)	Ant. Factor [dB/m]	Cable Loss [dB(μV)]	Height [cm]	Result [dB(μV/m)]	Limit [dB(μV/m)]	Margin [dB]
32.55	11.22	V	10.52	0.96	100	22.70	40.00	17.30
136.70	8.89	V	12.27	1.54	107	22.70	43.50	20.80
190.10	13.86	V	10.20	1.74	110	25.80	43.50	17.70
255.60	10.05	H	11.53	1.92	390	23.50	46.00	22.50
296.75	9.45	H	12.99	2.16	330	24.60	46.00	21.40
316.20	12.64	H	13.52	2.24	310	28.40	46.00	17.60
461.65	5.19	H	17.29	2.82	295	25.30	46.00	20.70

NOTES:

1. This test was applied both to 802.11n(HT20) and 802.11n(HT40). (Worst case: 802.11n(HT20))
2. \* H : Horizontal polarization , \*\* V : Vertical polarization
3. Result = Reading + Antenna factor + Cable loss
4. Margin value = Limit – Result
5. The measurement was performed for the frequency range above 30 MHz according to FCC Part 15.209.

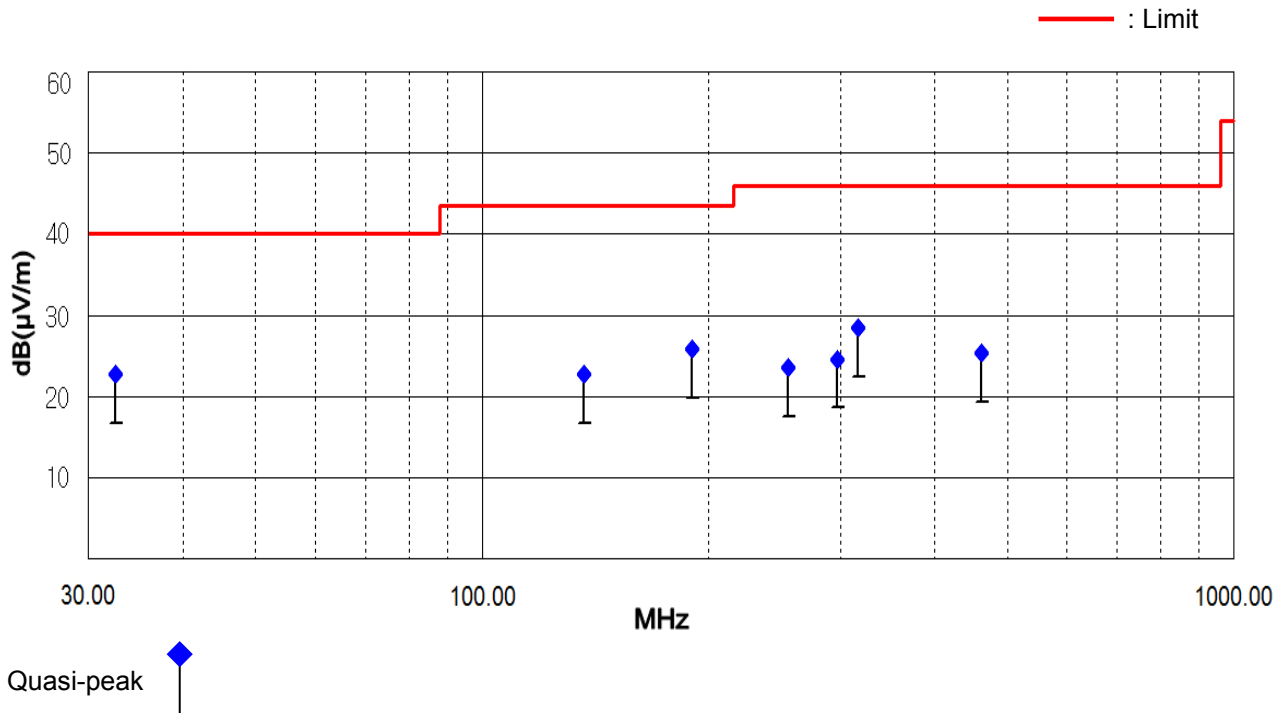

**- Above 1 GHz (1 GHz to 25 GHz)**

Test Date	April 10, 2014
Environmental of Test	22.1 °C, 46 % R.H., 101.3 kPa

- 802.11b mode

1. Low CH

Frequency [MHz]	Reading [dB(μV)]		Polarity (*H/**V)	Ant. Factor [dB/m]	Cable Loss [dB]	Result [dB(μV/m)]		Limit [dB(μV/m)]		Margin [dB]	
	Peak	Average				Peak	Average	Peak	Average	Peak	Average
4 823.92	62.75	44.55	H	31.20	-34.65	59.30	41.10	73.97	53.97	14.67	12.87

2. Middle CH

Frequency [MHz]	Reading [dB(μV)]		Polarity (*H/**V)	Ant. Factor [dB/m]	Cable Loss [dB]	Result [dB(μV/m)]		Limit [dB(μV/m)]		Margin [dB]	
	Peak	Average				Peak	Average	Peak	Average	Peak	Average
4 884.20	59.74	52.94	H	31.32	-34.66	56.40	49.60	73.97	53.97	17.57	4.37

3. High CH

Frequency [MHz]	Reading [dB(μV)]		Polarity (*H/**V)	Ant. Factor [dB/m]	Cable Loss [dB]	Result [dB(μV/m)]		Limit [dB(μV/m)]		Margin [dB]	
	Peak	Average				Peak	Average	Peak	Average	Peak	Average
4 944.15	61.34	51.54	H	31.43	-34.67	58.10	48.30	73.97	53.97	15.87	5.67

**Result: No signal detect above second harmonic.**

- 802.11g mode

1. Low CH

Frequency [MHz]	Reading [dB(μV)]		Polarity (*H/**V)	Ant. Factor [dB/m]	Cable Loss [dB]	Result [dB(μV/m)]		Limit [dB(μV/m)]		Margin [dB]	
	Peak	Average				Peak	Average	Peak	Average	Peak	Average
4 823.96	60.65	52.65	H	31.20	-34.65	57.20	49.20	73.97	53.97	16.77	4.77

2. Middle CH

Frequency [MHz]	Reading [dB(μV)]		Polarity (*H/**V)	Ant. Factor [dB/m]	Cable Loss [dB]	Result [dB(μV/m)]		Limit [dB(μV/m)]		Margin [dB]	
	Peak	Average				Peak	Average	Peak	Average	Peak	Average
4 884.28	62.24	52.54	H	31.32	-34.66	58.90	49.20	73.97	53.97	15.07	4.77

3. High CH

Frequency [MHz]	Reading [dB(μV)]		Polarity (*H/**V)	Ant. Factor [dB/m]	Cable Loss [dB]	Result [dB(μV/m)]		Limit [dB(μV/m)]		Margin [dB]	
	Peak	Average				Peak	Average	Peak	Average	Peak	Average
4 944.18	59.94	51.34	H	31.43	-34.67	56.70	48.10	73.97	53.97	17.27	5.87

**Result: No signal detect above second harmonic.**

- 802.11n(HT20) mode

1. Low CH

Frequency [MHz]	Reading [dB(μV)]		Polarity (*H/**V)	Ant. Factor [dB/m]	Cable Loss [dB]	Result [dB(μV/m)]		Limit [dB(μV/m)]		Margin [dB]	
	Peak	Average				Peak	Average	Peak	Average	Peak	Average
4 823.91	59.85	48.55	H	31.20	-34.65	56.40	45.10	73.97	53.97	17.57	8.87

2. Middle CH

Frequency [MHz]	Reading [dB(μV)]		Polarity (*H/**V)	Ant. Factor [dB/m]	Cable Loss [dB]	Result [dB(μV/m)]		Limit [dB(μV/m)]		Margin [dB]	
	Peak	Average				Peak	Average	Peak	Average	Peak	Average
4 884.32	62.74	50.64	H	31.32	-34.66	59.40	47.30	73.97	53.97	14.57	6.67

3. High CH

Frequency [MHz]	Reading [dB(μV)]		Polarity (*H/**V)	Ant. Factor [dB/m]	Cable Loss [dB]	Result [dB(μV/m)]		Limit [dB(μV/m)]		Margin [dB]	
	Peak	Average				Peak	Average	Peak	Average	Peak	Average
4 944.21	61.74	52.34	H	31.43	-34.67	58.50	49.10	73.97	53.97	15.47	4.87

**Result: No signal detect above second harmonic.**



- 802.11n(HT40) mode

1. Low CH

Frequency [MHz]	Reading [dB(μV)]		Polarity (*H/**V)	Ant. Factor [dB/m]	Cable Loss [dB]	Result [dB(μV/m)]		Limit [dB(μV/m)]		Margin [dB]	
	Peak	Average				Peak	Average	Peak	Average	Peak	Average
4 844.25	51.51	43.01	H	31.24	-34.65	48.10	39.60	73.97	53.97	25.87	14.37

2. Middle CH

Frequency [MHz]	Reading [dB(μV)]		Polarity (*H/**V)	Ant. Factor [dB/m]	Cable Loss [dB]	Result [dB(μV/m)]		Limit [dB(μV/m)]		Margin [dB]	
	Peak	Average				Peak	Average	Peak	Average	Peak	Average
4 884.32	52.54	42.64	H	31.32	-34.66	49.20	39.30	73.97	53.97	24.77	14.67

3. High CH

Frequency [MHz]	Reading [dB(μV)]		Polarity (*H/**V)	Ant. Factor [dB/m]	Cable Loss [dB]	Result [dB(μV/m)]		Limit [dB(μV/m)]		Margin [dB]	
	Peak	Average				Peak	Average	Peak	Average	Peak	Average
4 924.28	57.07	45.87	H	31.40	-34.67	53.80	42.60	73.97	53.97	20.17	11.37

**Result: No signal detect above second harmonic.**

NOTES:

1. \* H : Horizontal polarization , \*\* V : Vertical polarization
2. Factor = Antenna factor + Cable loss + Preamp
3. Result = Reading + Factor
4. Margin = Limit - Result
5. Measuring frequencies from 1GHz to the 10<sup>th</sup> harmonic of highest fundamental frequency.
6. Measurements above show only up to 6 maximum emissions noted, or would be lesser if no specific emissions from the EUT are recorded (ie: margin > 20 dB from the applicable limit) and considered that's already beyond the background noise floor.
7. Spectrum setting:
  - a. Peak Setting 1 GHz to 10<sup>th</sup> harmonics of fundamental, RBW = 1 MHz, VBW = 1 MHz, Sweep = Auto
  - b. AV Setting 1 GHz to 10<sup>th</sup> harmonics of fundamental, RBW = 1 MHz, VBW = 10 Hz, Sweep = Auto

## Plots of Spurious Emissions (Conducted Measurement)

Test Date	April 10, 2014
Environmental of Test	21.5 °C, 45 % R.H., 101.2 kPa

### - 802.11b mode

[CH Low]

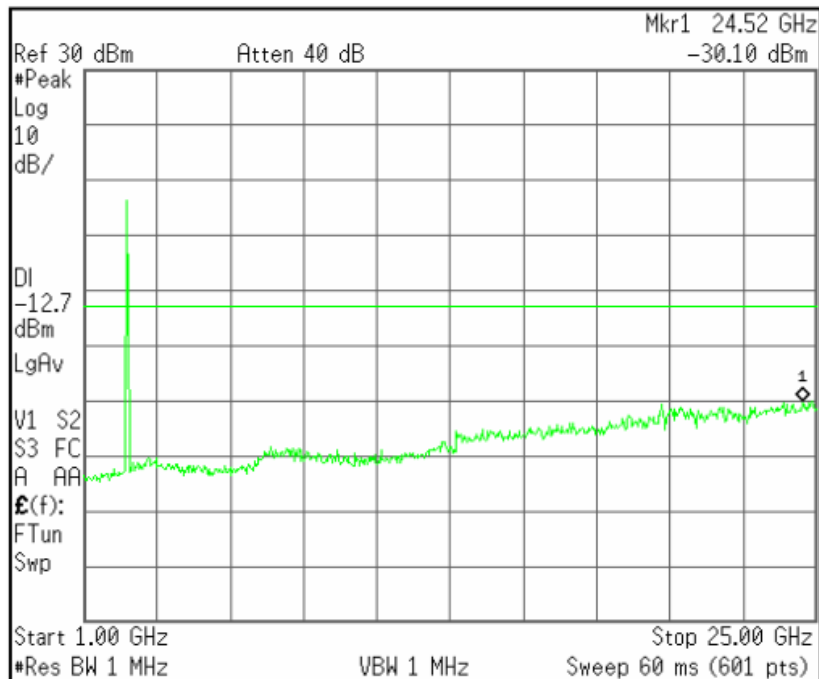
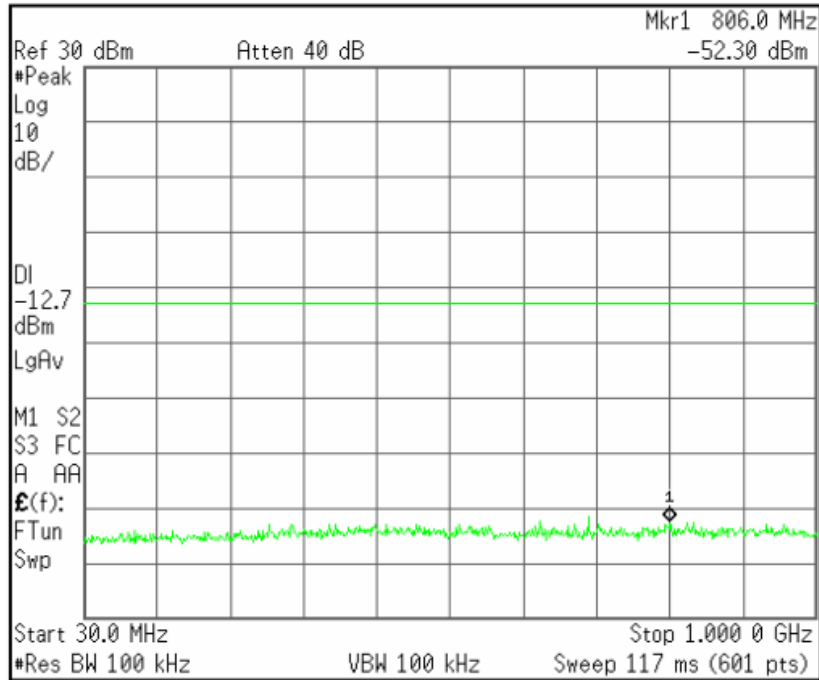

[CH Mid]

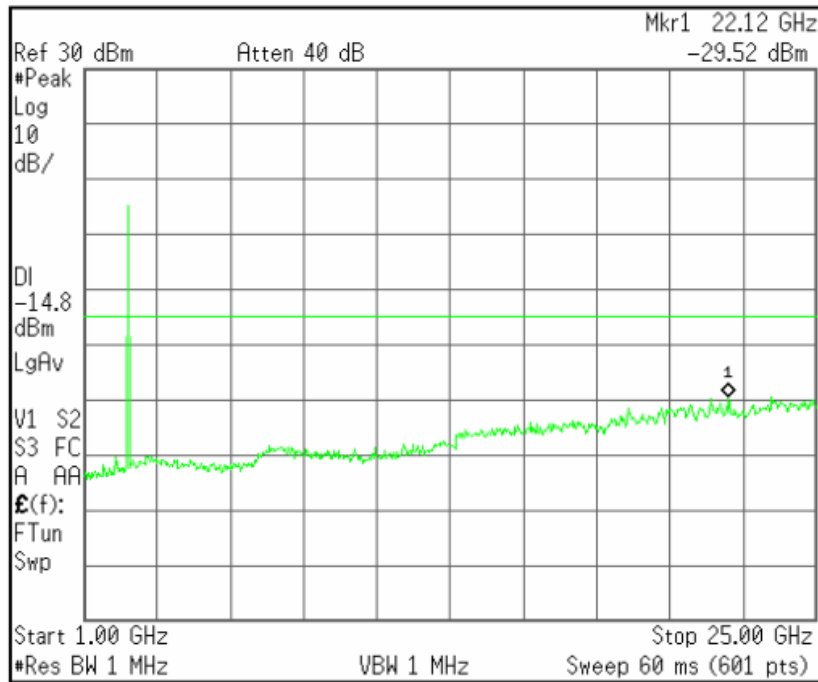
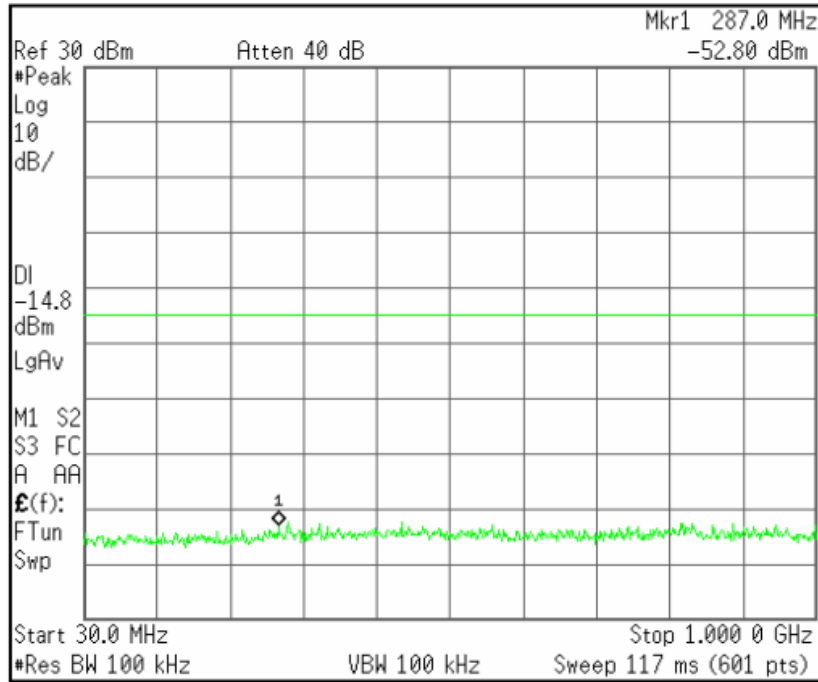

[CH High]

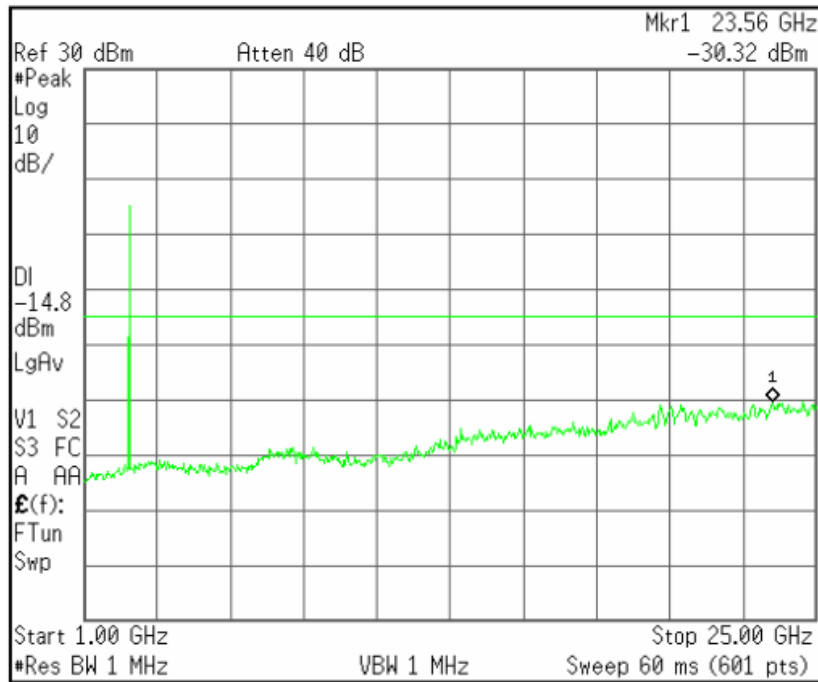
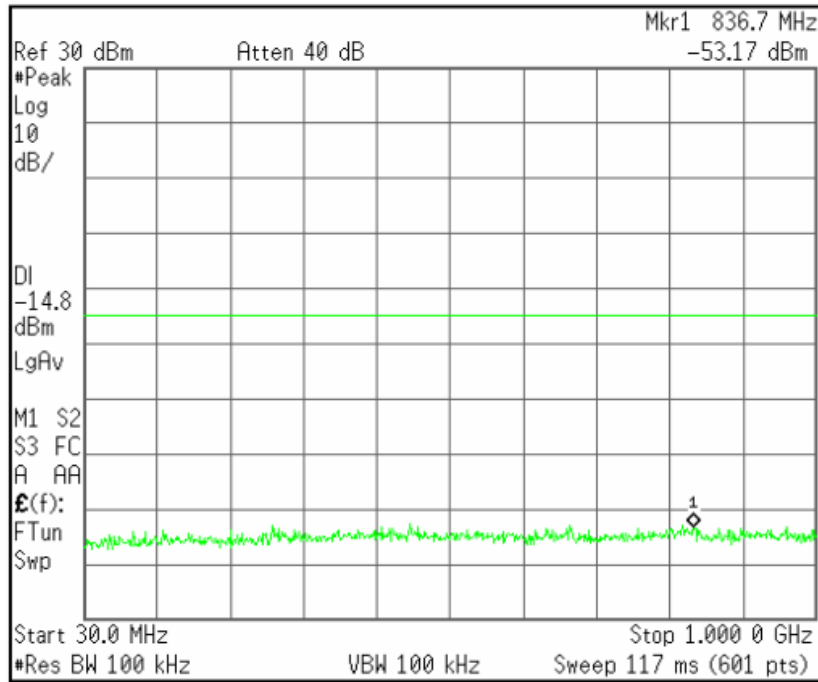

- 802.11g mode

[CH Low]

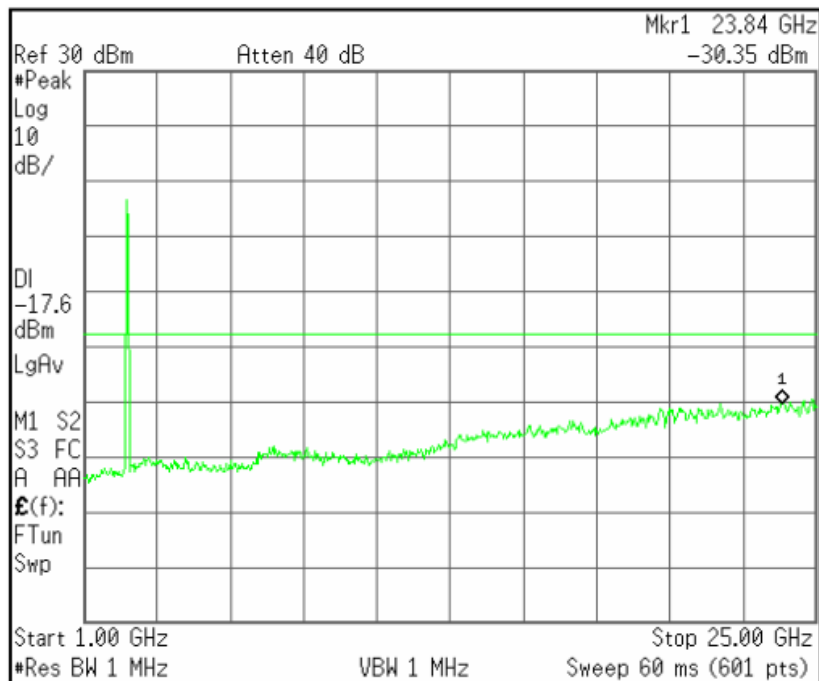
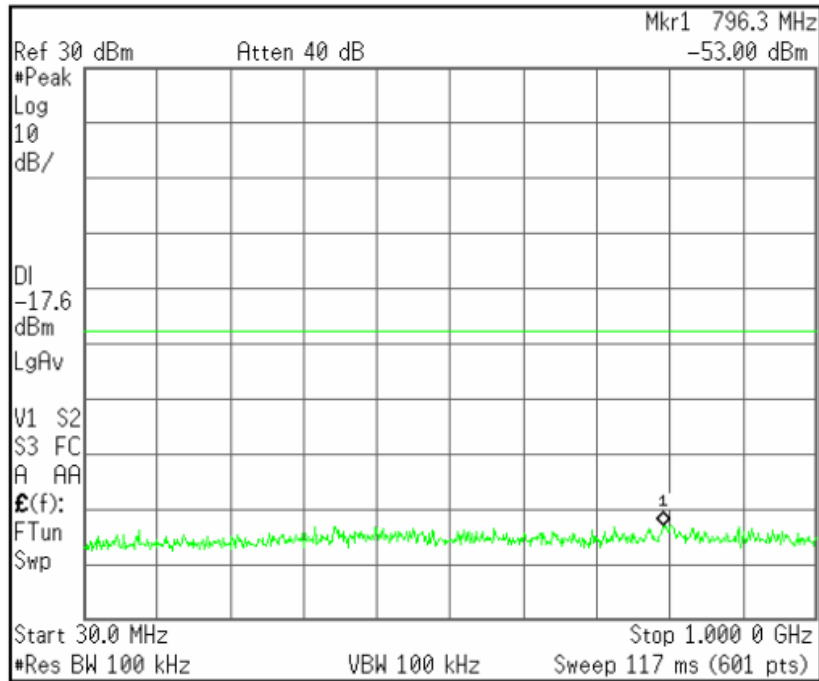

[CH Mid]

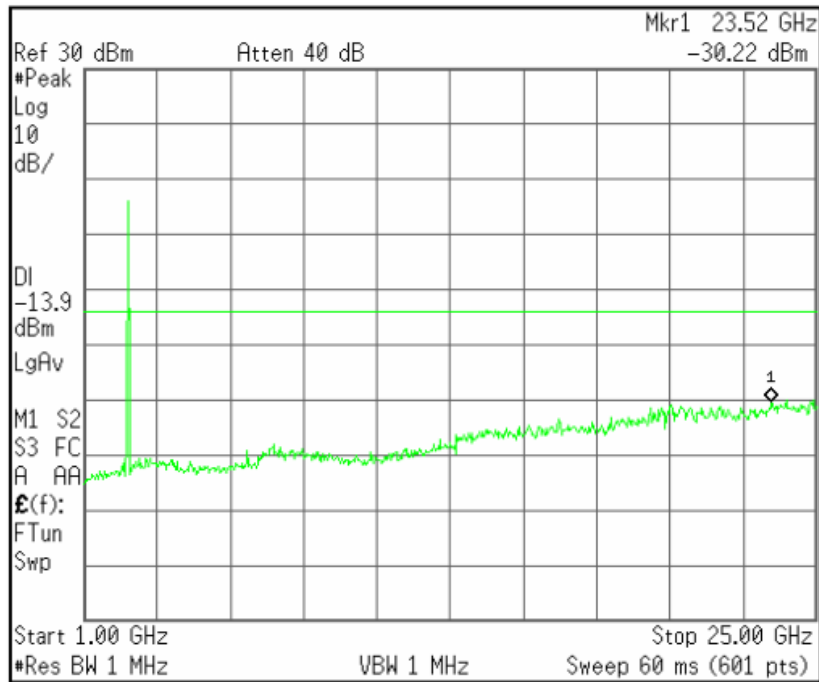
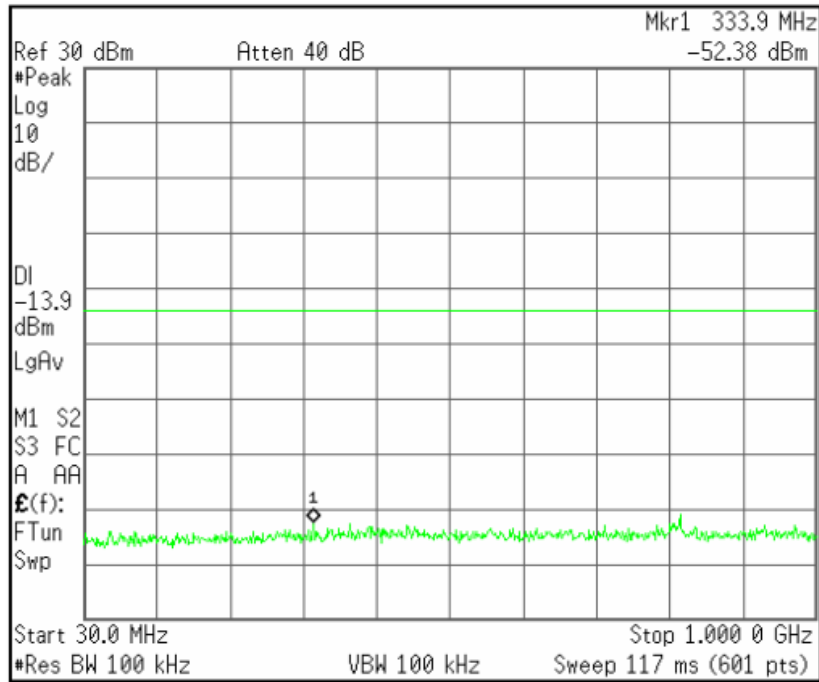

[CH High]

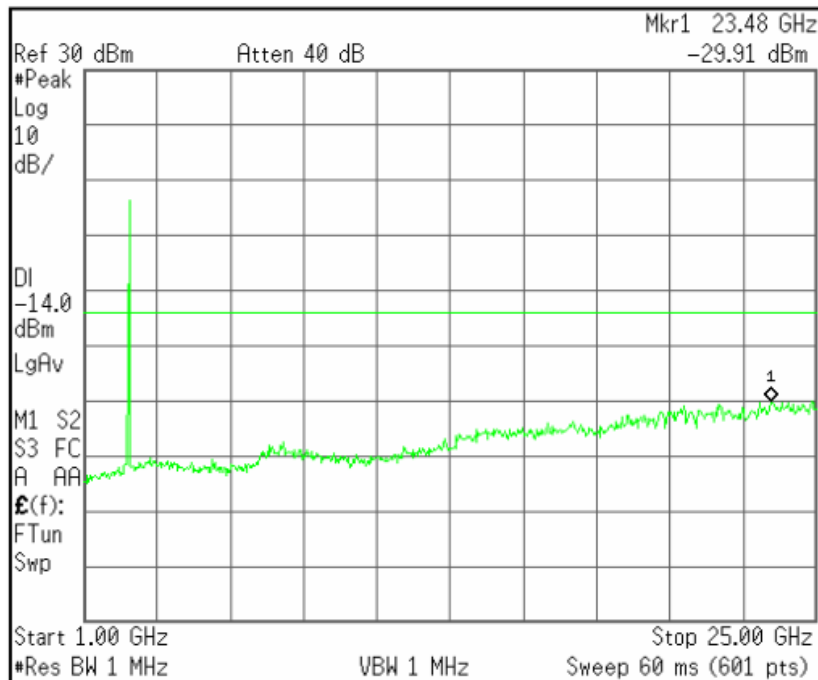
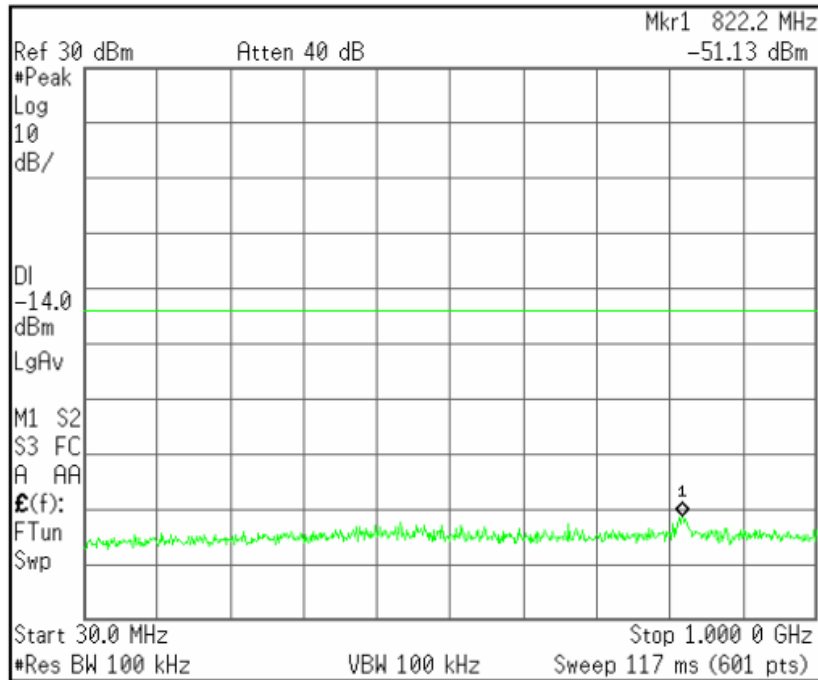

- 802.11n(HT20) mode

[CH Low]

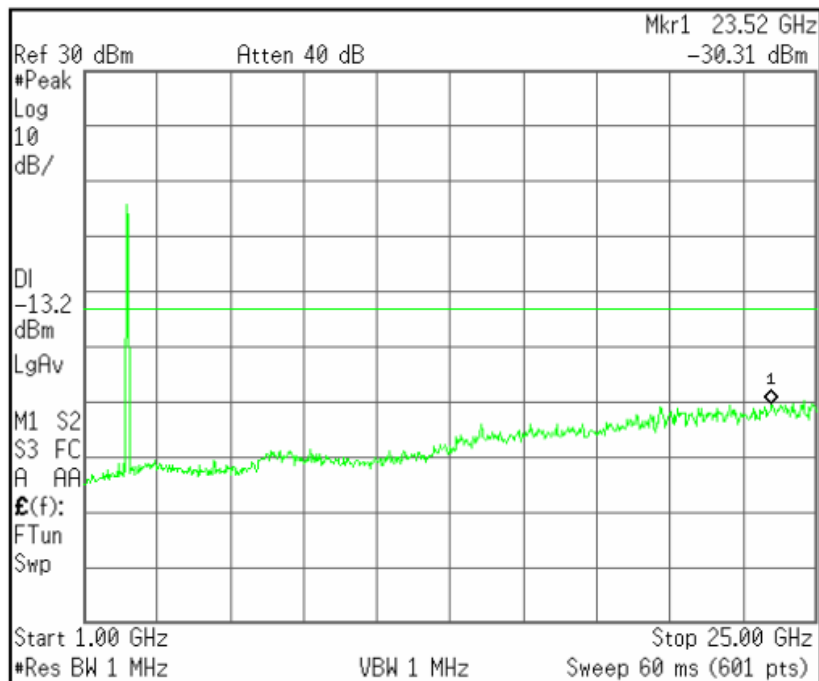
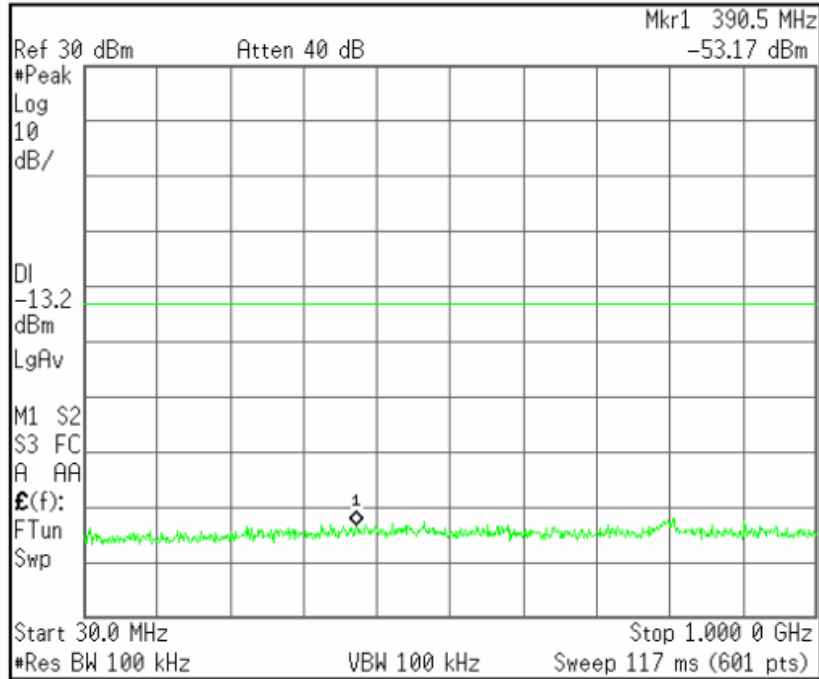



[CH Mid]

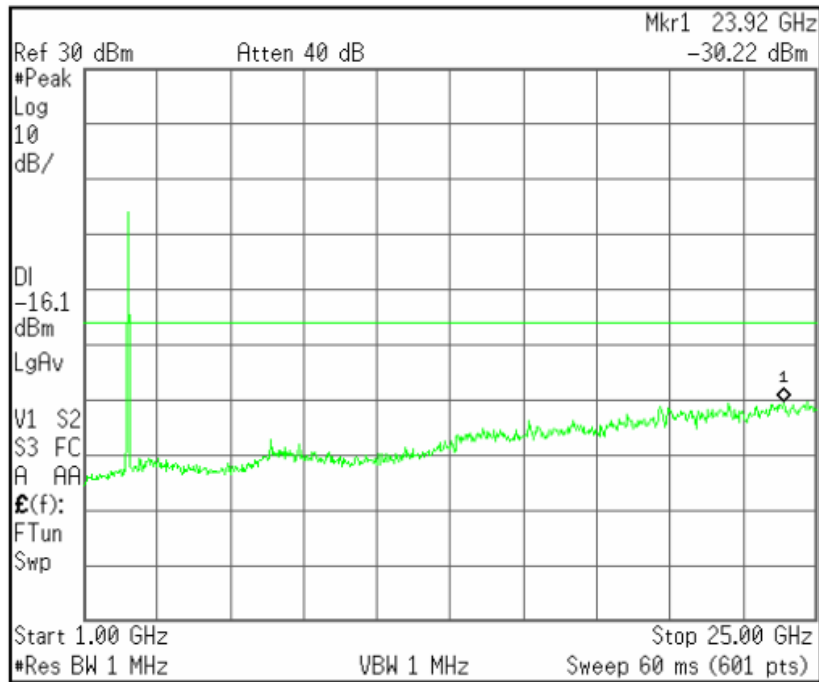
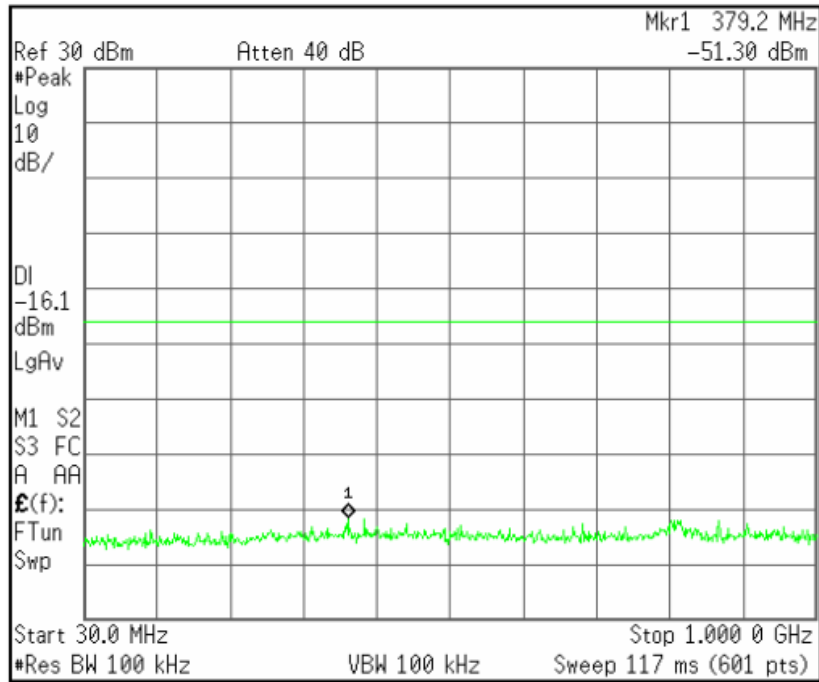

[CH High]

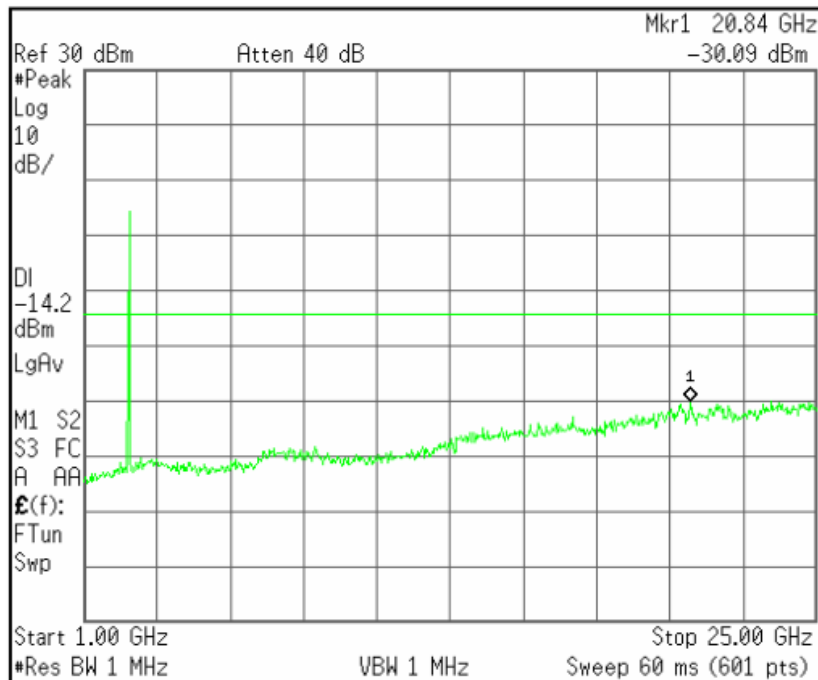
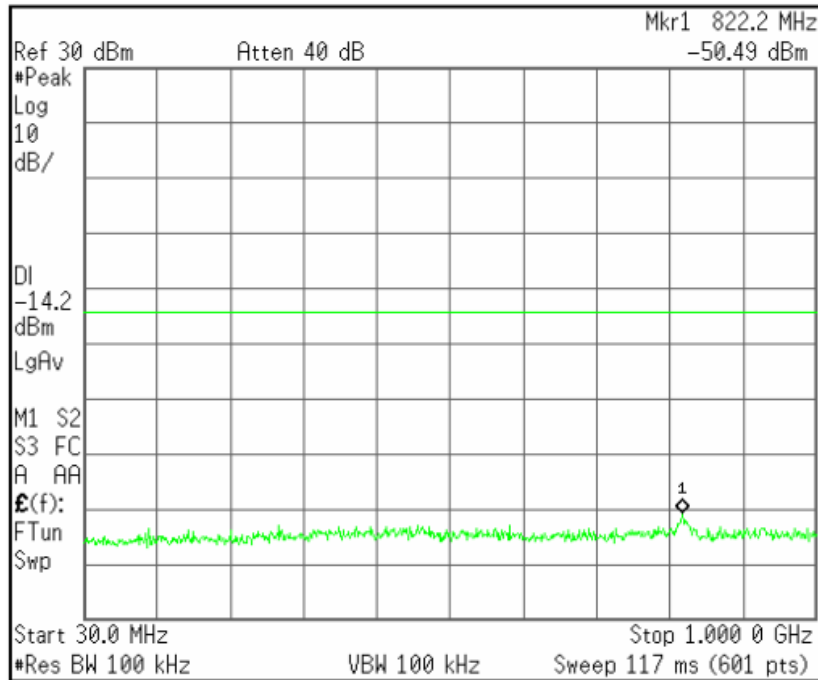

- 802.11n(HT40) mode

[CH Low]

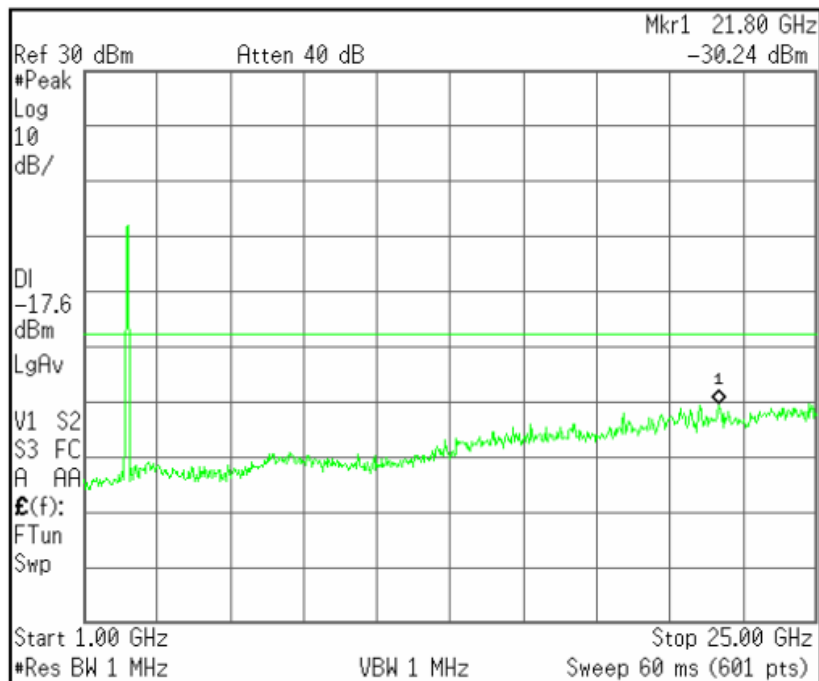
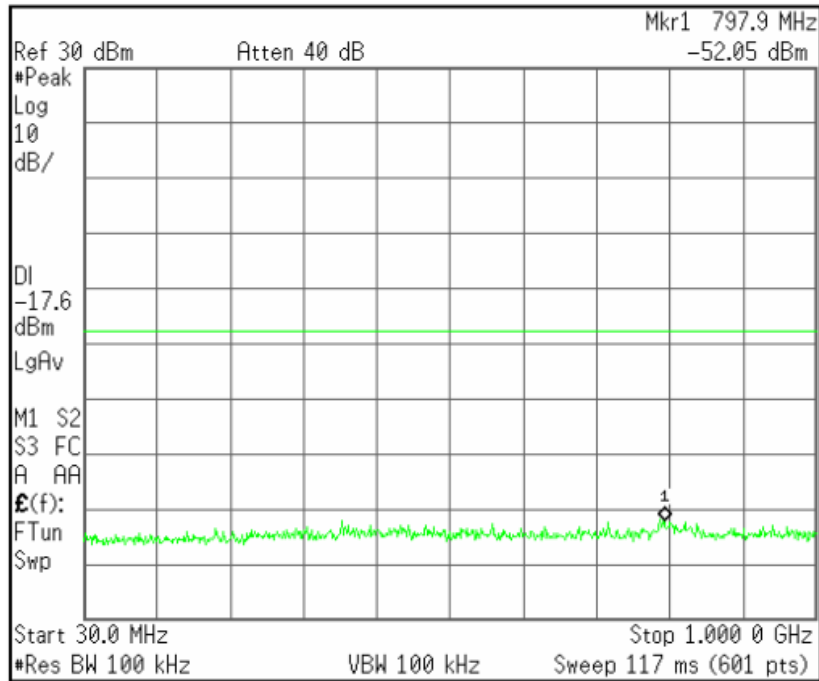

[CH Mid]

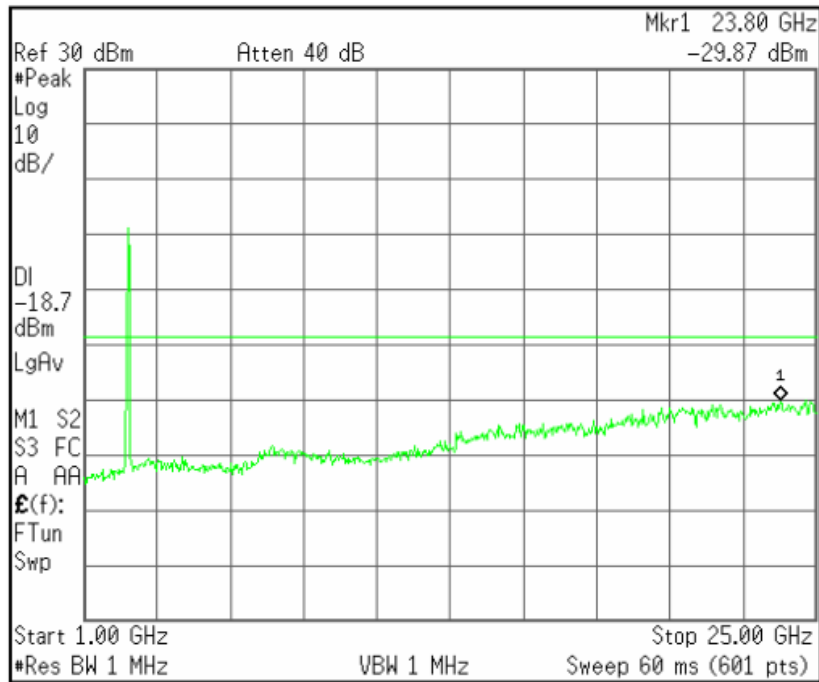
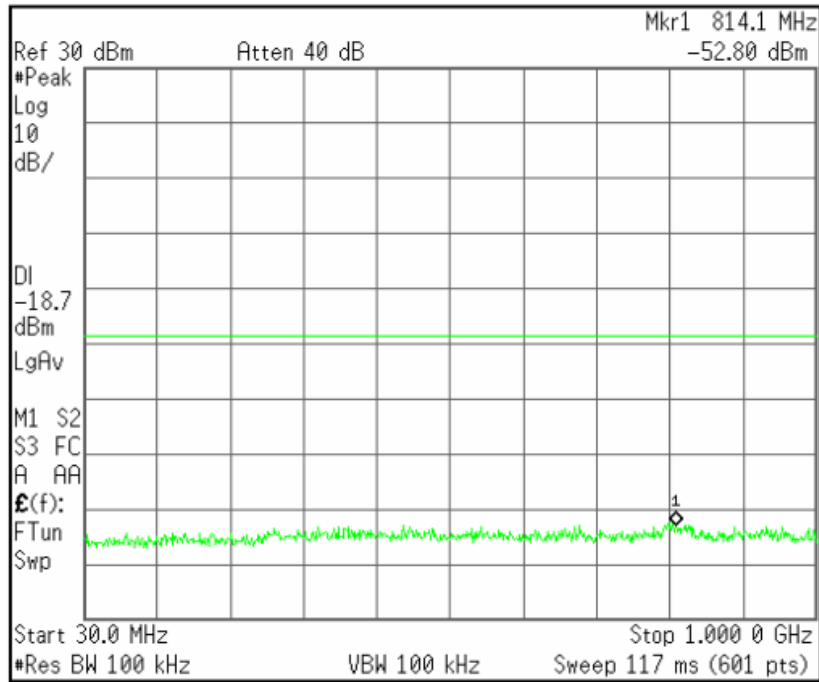

[CH High]

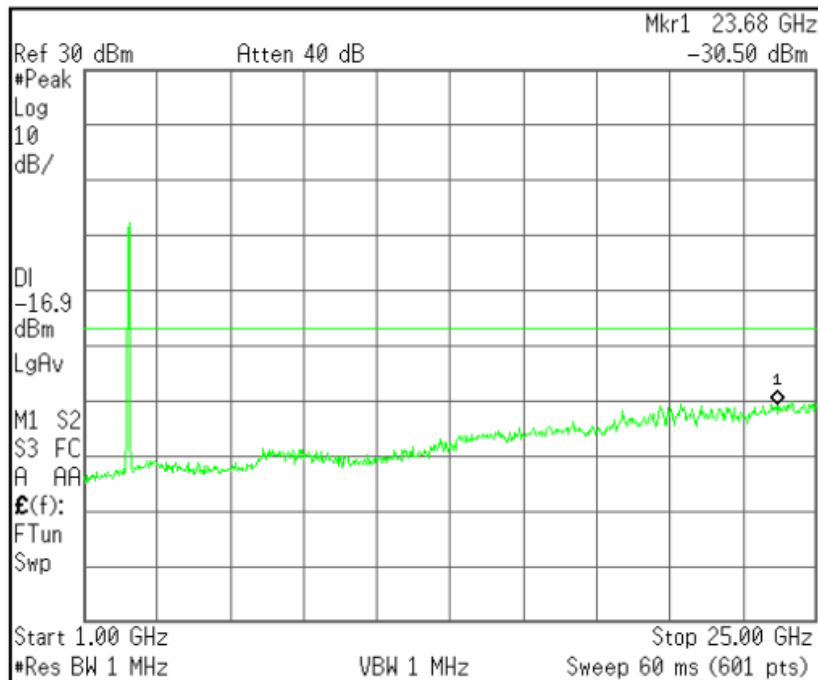
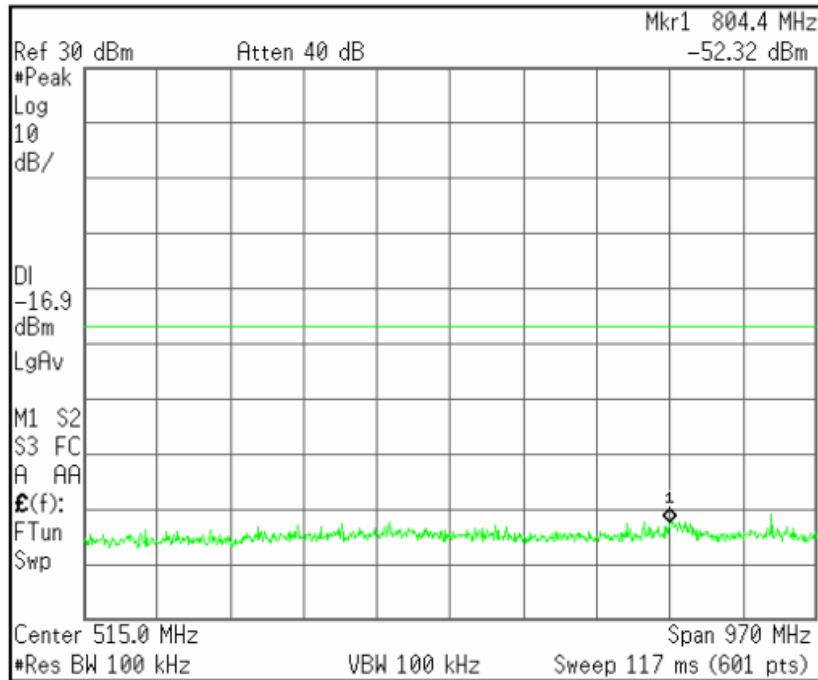

## 5.7 Conducted Emissions Measurement

EUT	BLACKVUE SPORT / SC300
Limit apply to	FCC Part 15.207
Test Date	April 10, 2014
Environmental of Test	20.6 °C, 46 % R.H., 101.3 kPa
Operating Condition	RF transmitting continuously during the tested.
Result	Passed by 8.87 dB

### Limit

For an intentional radiator that is designed to be connected to the public utility (AC) power line, the radio frequency voltage that is conducted back onto the AC power line on any frequency or frequencies within the band 150 kHz to 30 MHz shall not exceed the limits in the following table, as measured using a 50  $\mu$ H/50 ohms line impedance stabilization network (LISN). Compliance with the provisions of this paragraph shall be based on the measurement of the radio frequency voltage between each power line and ground at the power terminal. The lower limit applies at the boundary between the frequencies ranges.

Frequency of Emission [MHz]	Conducted limit [dB( $\mu$ V)]	
	Quasi-peak	Average
0.15 - 0.5	66 to 56 *	56 to 46 *
0.5 - 5	56	46
5 - 30	60	50

\* Decreases with the logarithm of the frequency.

### Test Results

- Refer to see the measured plot in next page.

## Conducted Emission Test Data

The following data and graph shows the highest levels of conducted emissions on both polarizations of hot and neutral line.

Detector mode: CISPR Quasi-Peak mode (6 dB Bandwidth: 9 kHz)

### NOTES:

1. Please see the measured data and graph in next page.
2. The Level (Result) value was included the reading, antenna factor and cable loss.
3. Delta (Margin) value = Limit - Level (Result)
4. Measurements were performed at the AC Power Inlet in the frequency band of 150 kHz ~ 30 MHz according to the FCC Part 15 Class B.

Line: HOT

ETL EMC Laboratory  
 Conducted Emission Test Result

EUT: ETLE140117.0102  
 Manuf:  
 Op Cond:  
 Operator:  
 Test Spec:  
 Comment: H

Prescan Measurement: Detectors: X PK / + AV  
 Meas Time: see scan settings  
 Peaks: 16  
 Acc Margin: 10 dB

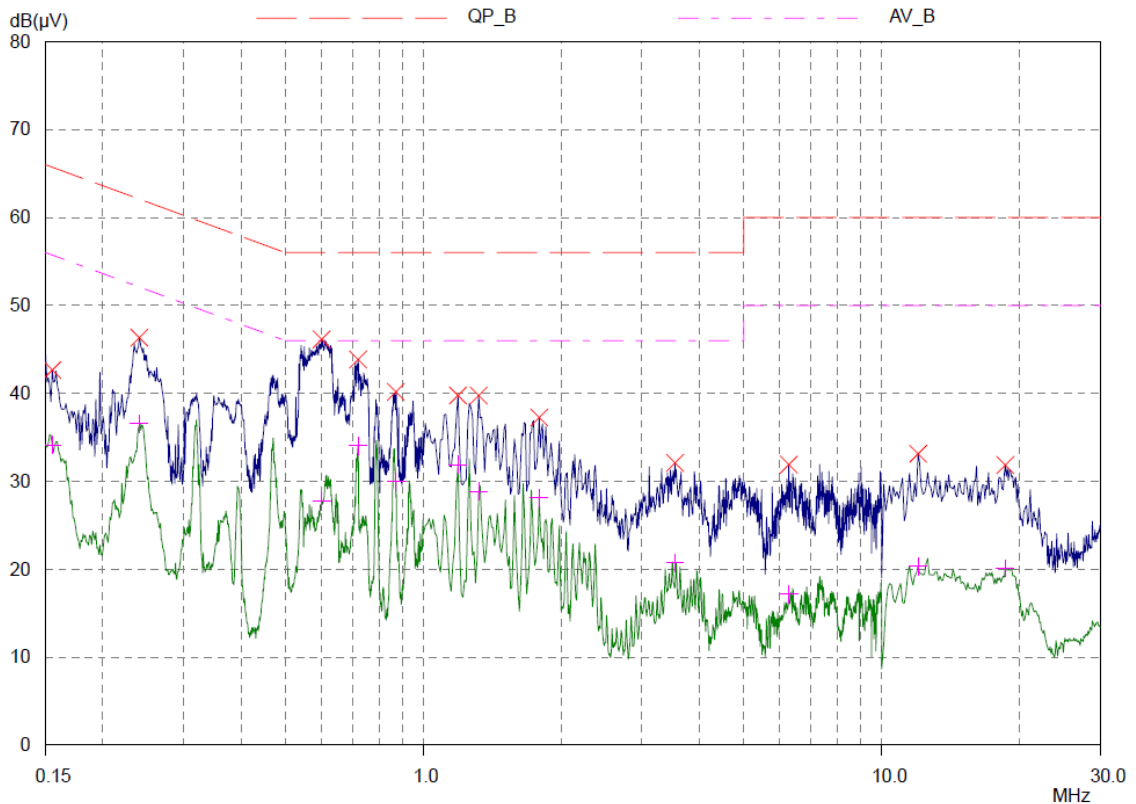



ETL EMC Laboratory  
Conducted Emission Test Result

EUT: ETLE140117.0102  
 Manuf:  
 Op Cond:  
 Operator:  
 Test Spec:  
 Comment: H

Prescan Measurement:      Detectors:      X PK / + AV  
    Meas Time:      see scan settings  
    Peaks:            16  
    Acc Margin:     10 dB

Peak Search Results

Frequency MHz	PK Level dB(μV)	PK Limit dB(μV)	PK Delta dB
0.155	42.64	65.73	23.09
0.24	46.33	62.10	15.77
0.6	46.14	56.00	9.86
0.721	43.85	56.00	12.15
0.871	40.17	56.00	15.83
1.19	39.77	56.00	16.23
1.32	39.76	56.00	16.24
1.79	37.26	56.00	18.74
3.54	32.09	56.00	23.91
6.27	31.89	60.00	28.11
12.0	33.13	60.00	26.87
18.6	31.86	60.00	28.14

Frequency MHz	AV Level dB(μV)	AV Limit dB(μV)	AV Delta dB
0.155	34.10	55.73	21.63
0.24	36.54	52.10	15.56
0.6	27.69	46.00	18.31
0.721	34.05	46.00	11.95
0.871	29.93	46.00	16.07
1.19	31.90	46.00	14.10
1.32	28.82	46.00	17.18
1.79	28.13	46.00	17.87
3.54	20.72	46.00	25.28
6.27	17.16	50.00	32.84
12.0	20.34	50.00	29.66
18.6	20.10	50.00	29.90

\* limit exceeded

**Line: Neutral**

ETL EMC Laboratory  
 Conducted Emission Test Result  
 EUT: ETLE140117.0102  
 Manuf:  
 Op Cond:  
 Operator:  
 Test Spec:  
 Comment: N

Prescan Measurement: Detectors: X PK / + AV  
 Meas Time: see scan settings  
 Peaks: 16  
 Acc Margin: 10 dB

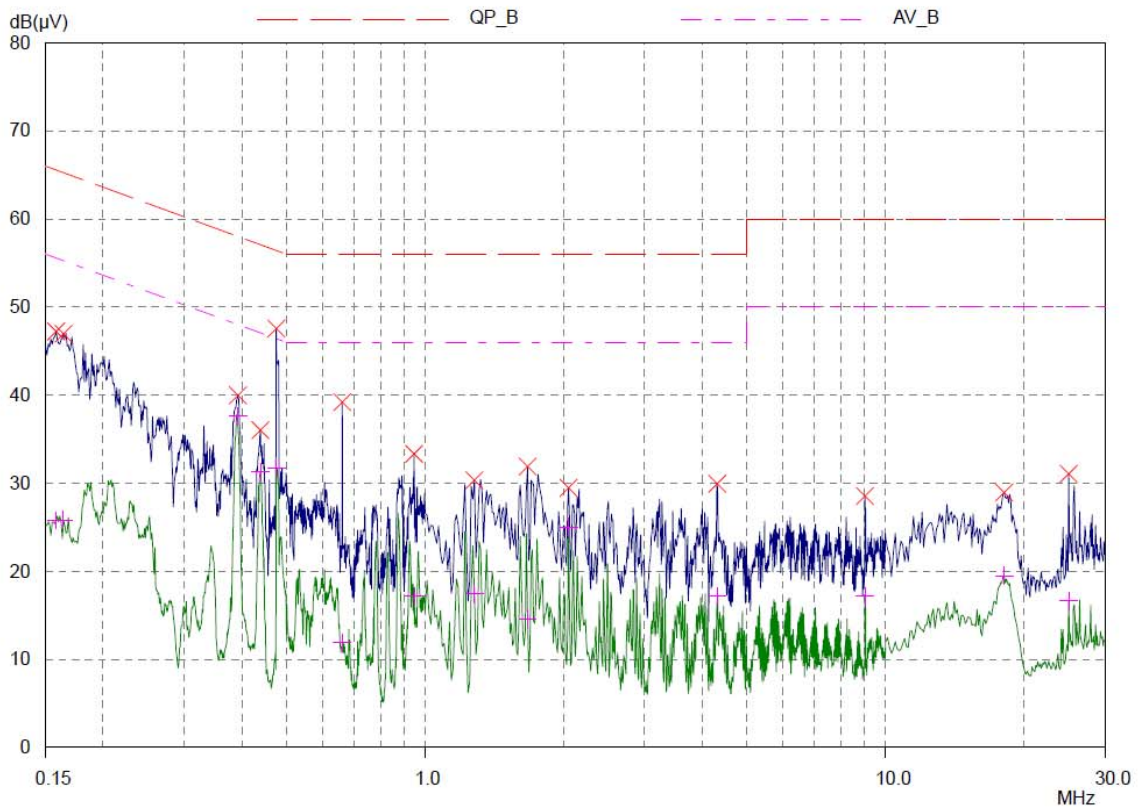

ETL EMC Laboratory  
Conducted Emission Test Result

EUT: ETLE140117.0102  
 Manuf:  
 Op Cond:  
 Operator:  
 Test Spec:  
 Comment: N

Prescan Measurement:      Detectors:      X PK / + AV  
    Meas Time:      see scan settings  
    Peaks:            16  
    Acc Margin:     10 dB

Peak Search Results

Frequency MHz	PK Level dB(μV)	PK Limit dB(μV)	PK Delta dB
0.158	47.23	65.57	18.34
0.164	46.96	65.26	18.30
0.392	39.96	58.02	18.06
0.439	36.03	57.08	21.05
0.475	47.56	56.43	8.87
0.661	39.19	56.00	16.81
0.947	33.32	56.00	22.68
1.28	30.33	56.00	25.67
1.67	31.88	56.00	24.12
2.05	29.47	56.00	26.53
4.31	29.94	56.00	26.06
9.02	28.54	60.00	31.46
18.1	28.93	60.00	31.07
25.0	31.05	60.00	28.95

Frequency MHz	AV Level dB(μV)	AV Limit dB(μV)	AV Delta dB
0.158	25.78	55.57	29.79
0.164	25.82	55.26	29.44
0.392	37.58	48.02	10.44
0.439	31.26	47.08	15.82
0.475	31.71	46.43	14.72
0.661	11.85	46.00	34.15
0.947	17.15	46.00	28.85
1.28	17.45	46.00	28.55
1.67	14.59	46.00	31.41
2.05	25.00	46.00	21.00
4.31	17.20	46.00	28.80
9.02	17.17	50.00	32.83
18.1	19.48	50.00	30.52
25.0	16.66	50.00	33.34

\* limit exceeded

## 5.8 Radio Frequency Exposure

### Standard Applicable:

According to §1.1307(b)(1), systems operating under the provisions of this section shall be operated in a manner that ensure that the public is not exposed to radio frequency energy level in excess of the Commission's guideline.

This is a Portable device with its physical nature to be used nearby, the distance between radiating structure and human is less than 20 cm.

As per KDB 447498 D01, The 1-g and 10-g SAR test exclusion thresholds for 100 MHz to 6 GHz at test separation distances  $\leq 50$  mm are determined by:

$$\left[ \frac{\text{(max. power of channel, including tune-up tolerance, mW)}}{\text{(min. test separation distance, mm)}} \right]^* \sqrt{f(\text{GHz})} \leq 3.0 \text{ for 1-g SAR and } \leq 7.5 \text{ for 10-g extremity SAR, where}$$

f (GHz) is the RF channel transmit frequency in GHz

Power and distance are rounded to the nearest mW and mm before calculation

The result is rounded to one decimal place for comparison

### Measurement Result:

This is a portable device and the Max peak output power is **(9.120 mW)** lower than the threshold given and derived as above, where

$$= 9.120 \text{ (mW)} / 5 \text{ (mm)} * \sqrt{2.412 \text{ (GHz)}} = 2.833 < 3.000$$

As the result of calculation result indicates, the RF exposure generating from given transmitter (transmitter employed digital modulation) can be excluded from SAR measurement, and is deemed compliant with RF exposure as per FCC.

## 6. SAMPLE CALCULATION

### Sample Field Strength Calculation

The field strength is calculated by adding the Antenna Factor and Cable Factor.  
The basic equation with a sample calculation is as follows:

$$FS = RA + AF + CF - PA$$

Where FS = Field Strength

RA = Receiver Amplitude

AF = Antenna Factor

CF = Cable Attenuation Factor

PA\* = Preamplifier Factor

\* PA is only be used for the measuring frequency above 1 GHz.

$$dB(\mu V) = 20 \log_{10} (\mu V) : \text{Equation}$$

$$dB(\mu V) = dBm + 107$$

Example : @ 4 884.20 MHz

Class B Limit = 53.97 dB( $\mu$ V/m) (Average)

Reading = 52.94 dB( $\mu$ V)

Antenna Factor + (Cable loss + Amp. Gain) = 31.32 + (-34.66) = -3.34 dB( $\mu$ V/m)

Total = 49.60 dB( $\mu$ V/m)

Margin = 53.97 - 49.60 = 4.37 dB

= 4.37 dB below Limit

## 7. List of test equipments used for measurements

	Test Equipment	Model	Mfg.	Serial No.	Cal. Date	Cal. Due Date
<input checked="" type="checkbox"/>	EMI Test Receiver	ESVS 10	R&S	835165/001	14.03.18	15.03.18
<input checked="" type="checkbox"/>	EMI Test Receiver	ESCS30	R&S	847793/005	14.03.18	15.03.18
<input checked="" type="checkbox"/>	EMI Test Receiver	ESCI7	R&S	100851	13.09.05	14.09.05
<input checked="" type="checkbox"/>	Two-Line V-Network	ENV216	R&S	101715	14.03.17	15.03.17
<input checked="" type="checkbox"/>	Loop Antenna	6502	EMCO	00033743	12.09.24	14.09.24
<input checked="" type="checkbox"/>	LogBicon Antenna	VULB9160	Schwarzbeck	3082	13.07.25	15.07.25
<input checked="" type="checkbox"/>	Horn Antenna	BBHA 9120D	Schwarzbeck	277	12.05.10	14.05.10
<input checked="" type="checkbox"/>	Spectrum Analyzer	E7405A	H.P.	US41160290	13.09.05	14.09.05
<input checked="" type="checkbox"/>	PSA Series Spectrum Analyzer	E4440A	Agilent	US40420382	13.09.11	14.09.11
<input checked="" type="checkbox"/>	Amplifier	TK-PA18	TESTEK	120020	13.09.05	14.09.05
<input checked="" type="checkbox"/>	System Power Supply	6030A	Agilent	1036546	14.03.17	15.03.17
<input checked="" type="checkbox"/>	Band Reject Filter	WRCGV 2402/2480-2382/2500-52/10SS	Wainwright Instrument	2	13.09.05	14.09.05
<input checked="" type="checkbox"/>	Highpass Filter	WHKX3.0 /18G-6SS	Wainwright Instrument	15	14.03.18	15.03.18
<input checked="" type="checkbox"/>	Power Meter	NRVS	R&S	834053/060	13.09.05	14.09.05
<input checked="" type="checkbox"/>	Turn-Table	DS1200-S	Innco Systems GmbH	2740311	N/A	N/A
<input checked="" type="checkbox"/>	Turn-Table	TT 1.35 SI	SES	-	N/A	N/A
<input checked="" type="checkbox"/>	Antenna Master	AM 4.5	SES	-	N/A	N/A