

# RF Test Report

## 2.4 GHz WLAN 802.11b/g/n

**Report No.** : FCCCBNW-WAY-P23110165-3R1  
**Customer** : Pittasoft Co., Ltd.  
**Address** : A 4th floor, ABN Tower, 331, Pangyo-ro, Bundang-gu  
Seongnam-si, Gyeonggi-do South Korea  
**Use of Report** : Certification  
**Model Name** : DR970X Plus  
**FCC ID** : YCK-DR970XP  
**Date of Test** : 2023.11.15 to 2024.01.30  
**Test Method Used** : FCC 47 CFR PART 15 Subpart C (Section §15.247)  
KDB558074 D01v05r02,  
ANSI C63.10-2013  
**Testing Environment** : Refer to the Test Condition

**Test Result** :  Pass  Fail

**ISSUED BY:** BV CPS ADT Korea Ltd., EMC/RF Laboratory

**ADDRESS:** Innoplex No.2 106, Sinwon-ro 306, Yeongtong-gu,  
Suwon-si, Gyeonggi-do, Korea 16675

**TEST LOCATION:** HeungAn-daero 49, DongAn-gu, Anyang-si,  
Gyeonggi-do, Korea, 14119

Tested by

Name : Kwangmin JUNG

(Signature)  

Technical Manager

Name : Donghwa SHIN

(Signature)  

2024. 01. 31

**BV CPS ADT Korea Ltd.**

This report is for your exclusive use. Any copying or replication of this report to or for any other person or entity, or use of our name or trademark, is permitted only with our prior written permission. This report sets forth our findings solely with respect to the test samples identified herein. The results set forth in this report are not indicative or representative of the quality or characteristics of the lot from which a test sample was taken or any similar or identical product unless specifically and expressly noted. Our report includes all of the tests requested by you and the results thereof based upon the information that you provided to us. You have 60 days from date of issuance of this report to notify us of any material error or omission caused by our negligence, provided, however, that such notice shall be in writing and shall specifically address the issue you wish to raise. A failure to raise such issue within the prescribed time shall constitute your unqualified acceptance of the completeness of this report, the tests conducted and the correctness of the report contents. Unless specific mention, the uncertainty of measurement has been explicitly taken into account to declare the compliance or non-compliance to the specification.



**BUREAU**  
**VERITAS**

## RELEASE CONTROL RECORD

REPORT NO.	REASON FOR CHANGE	DATE ISSUED
FCCCBNW-WAY-P23110165-3	Original release	2024.01.26
FCCCBNW-WAY-P23110165-3R1	Update the test report	2024.01.31

# Table of Contents

<b>RELEASE CONTROL RECORD .....</b>	<b>2</b>
<b>1 SUMMARY OF TEST RESULTS.....</b>	<b>4</b>
1.1 DECISION RULES FOR STATEMENT OF CONFORMITY .....	5
1.2 MEASUREMENT UNCERTAINTY .....	5
<b>2 GENERAL INFORMATION.....</b>	<b>6</b>
2.1 GENERAL DESCRIPTION OF EUT.....	6
2.2 TESTED SAMPLE AND TESTED COMPANION DEVICE INFORMATION .....	6
2.3 DESCRIPTION OF TEST MODE .....	7
2.4 INSTRUMENT CALIBRATION.....	7
2.5 EUT CONFIGURATION.....	7
2.6 GENERAL DESCRIPTION OF APPLIED STANDARDS .....	7
2.7 TEST EQUIPMENT.....	8
<b>3 TEST RESULTS .....</b>	<b>9</b>
3.1 ANTENNA REQUIREMENT .....	9
3.2 6 DB BANDWIDTH.....	10
3.3 MAXIMUM PEAK OUTPUT POWER.....	16
3.4 POWER SPECTRAL DENSITY .....	20
3.5 SPURIOUS EMISSION, BAND EDGE AND RESTRICTED BANDS.....	26
3.6 AC CONDUCTED EMISSIONS (150 KHZ TO 30 MHZ).....	59
3.7 DUTY CYCLE.....	60
<b>APPENDIX – INFORMATION OF THE TESTING LABORATORIES .....</b>	<b>63</b>

## 1 Summary of Test Results

The EUT has been tested according to the following specifications

Applied Standard : FCC Part 15, Subpart C 15.247					
FCC Part Section(s)	Test Description	Limit	Test Condition	Test Result	Reference
15.247(a)(2)	6 dB Bandwidth	> 500 kHz	Conducted	PASS	Section 3.2
15.247(b)(3)	Maximum Peak Output Power	< 1 Watt		PASS	Section 3.3
15.247(e)	Power Spectral Density	< 8 dBm / 3 kHz Band		PASS	Section 3.4
15.247(d)	Conducted spurious emissions	≥ 20 dBc In any 100 kHz bandwidth		PASS	Section 3.5
15.205 15.209	General Field Strength Limits (Restricted Bands and Radiated Emission Limits)	Emissions in Restricted bands must meet the radiated limits detailed in 15.209	Radiated	PASS	Section 3.5
15.207	AC Conducted Emissions (150 kHz – 30 MHz)	< FCC 15.207 limits	AC Line Conducted	NA <sup>Note3)</sup>	Section 3.6
15.203	Antenna Requirement	FCC 15.203	-	PASS	Section 3.1

### NOTES

- 1) The general test methods used to test on this devices are ANSI C63.10.
- 2) Determining compliance based on the results of the compliance measurement, not taking into account measurement instrumentation uncertainty.
- 3) Devices which only employ battery power for operation.

## 1.1 Decision Rules for Statement of Conformity

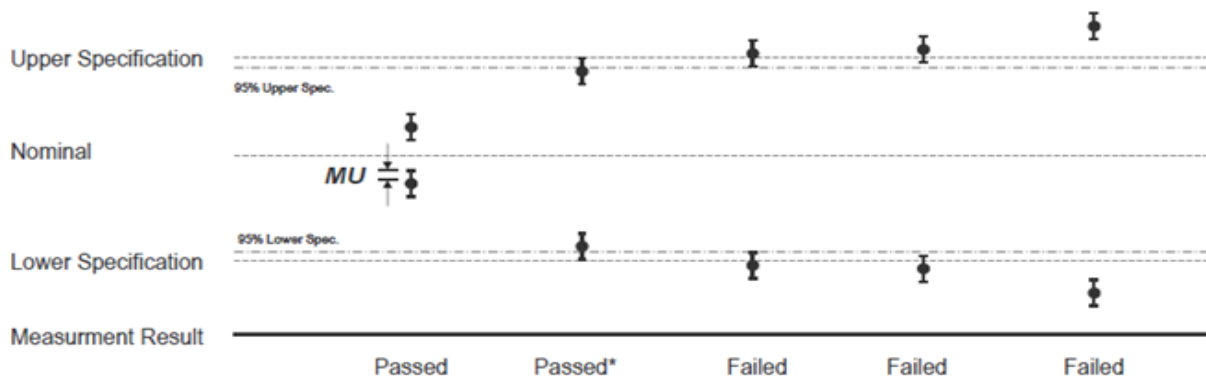

**QUA-52 Decision Rule(QA Document) was applied.**

**Step 1) :** Reference Check, Daily Check, Peripheral device Check

**Step 2) :** Re-test Procedure (Repeat the test maximum 3 times, Different Test Engineer)

- 1) If the original test results are subject to retesting and the judgement is unclear, the retest is carried out.
- 2) If the result of the first retest is the same as the initial test, the judgement is made based on the value.
- 3) If the result of the first retest differ from the results of the initial test, the second re-test is carried out.
- 4) After completion of the second retest, the average of the three test results is determined as the final result. However, if the deviation of the three test values is more than 5 % of the reference value, the technical manager should review the reproducibility of the test from the beginning.

## 1.2 Measurement Uncertainty

Where relevant, the following measurement uncertainty levels have been estimated for tests performed on the EUT as specified in CISPR 16-4-2

Measurement Items	Frequency Range	Expanded Uncertainty $U = kUc (k = 2)$
Radiated Spurious Emissions	9 kHz – 30 MHz	2.00
	30 MHz – 1 GHz	4.22
	1 GHz – 18 GHz	5.40
	18 GHz – 26.5 GHz	5.08
Measurement Items		Expanded Uncertainty $U = kUc (k = 2)$
Conducted	Maximum Output Power	1.20
	Spurious Emissions	1.36

This uncertainty represents an expanded uncertainty expressed at approximately the 95 % confidence level using a coverage factor of  $k = 2$ .

## 2 General Information

### 2.1 General Description of EUT

<b>Equipment Class</b>	Digital Transmission System (DTS)
<b>Product name</b>	CAR DASHCAM
<b>FCC ID</b>	YCK-DR970XP
<b>Model</b>	DR970X Plus
<b>Additional model name</b>	DR970X-1CH Plus, DR970X-2CH Plus, DR970X-2CH IR Plus, DR970X-2CH Truck Plus, DR970X-2CH DMS Plus
<b>Power Supply</b>	DC 12 V , DC 24V
<b>Modulation Type</b>	802.11b: CCK, DSSS 802.11g/n: OFDM
<b>Transfer Rate</b>	1, 2, 5.5, 11 Mbps (802.11b) / SISO 6, 9, 12, 18, 24, 36, 48, 54 Mbps (802.11g) / SISO MCS0 to MCS15 (802.11n) / SISO
<b>Operating Frequency</b>	802.11b/g/n(HT20): 2 412 MHz to 2 462 MHz 802.11n(HT40): 2 422 MHz to 2 452 MHz
<b>Output Power (Peak / Average)</b>	23.80 dBm / 16.73 dBm
<b>Antenna Type</b>	Chip Antenna
<b>Antenna Gain</b>	-1.79 dBi
<b>H/W Version</b>	1.0
<b>S/W Version</b>	1.0

**NOTE 1:** For a more detailed features description, please refer to the manufacturer's specifications or the user's manual.

**NOTE 2:** For the test results, the EUT had been tested with all conditions. But only the worst case was shown in test report.

### 2.2 Tested sample and Tested companion device information

Type	Model	Note
Test sample (Conducted)	DR970X Plus	S/N: 97XPK3MAE00210
Test sample (Radiated)	DR970X Plus	S/N: 97XPK3MAE00213

## 2.3 Description of Test Mode

The EUT has been tested with all modes of operating conditions to determine the worst case emission characteristics.

Test Mode		Worst case data rate	Tested Frequency (MHz)		
<b>TM 1</b>	802.11b	1 Mbps	2 412	2 437	2 462
<b>TM 2</b>	802.11g	6 Mbps	2 412	2 437	2 462
<b>TM 3</b>	802.11n(HT20)	MCS 0	2 412	2 437	2 462
<b>TM 4</b>	802.11n(HT40)	MCS 0	2 422	2 437	2 452

Note: This device support SISO.

## 2.4 INSTRUMENT CALIBRATION

The measuring equipment, which was utilized in performing the tests documented herein, has been calibrated in accordance with the manufacturer's recommendations for utilizing calibration equipments, which is traceable to recognized national standards.

## 2.5 EUT CONFIGURATION

The EUT configuration for testing is installed on RF field strength measurement to meet the Commissions requirement and operating in a manner that intends to maximize its emission characteristics in a continuous normal application.

## 2.6 General Description of Applied Standards

Generally the tests were performed according to the specifications of the standard, it must comply with the requirements of the following standards.

**FCC CFR 47 Part 15, Subpart C (§15.247)**  
**KDB 558074 D01 15.247 Meas Guidance v05r02**  
**ANSI C63.10-2013**

All test items in this test report have been performed and recorded as per the above standards.



## 2.7 Test Equipment

Test Equipment is traceable to the National Institute of Standards and Technology (NIST). Measurement antenna used during testing were calibrated in accordance to the requirements of ANSI C63.5-2017.

Equipment Name	Manufacturer	Model No.	Serial No.	Next Cal. Date
Spectrum Analyzer	R&S	FSW50	101403	2024-11-22
Signal Analyzer	R&S	FSV30	103017	2024-11-22
Signal Analyzer	Keysight Technologies	N9020B	MY62150135	2024-05-25
Signal Analyzer	Keysight Technologies	N9030B	MY57142476	2024-11-22
MXG Vector Signal Generator	Keysight Technologies	N5182B	MY53051310	2024-11-22
Signal Generator	R&S	SMB100A	MY41006053	2024-05-25
DC Power Supply	Keysight Technologies	E3632A	MY62216181	2024-05-25
Attenuator	Aeroflex	40AH2W-10	1	2024-11-22
True-RMS Digital Multimeter	Fluke	177	43240434	2024-05-25
High Pass Filter	Micro-Tronics	HPM17543	28	2024-05-25
High Pass Filter	Wt Microwave	WT-A1698-HS	WT190313-6-4	2024-11-22
Humidity Barometer TEMP Meter	LUTRON	MHB-382SD	AJ.38475	2024-11-21
Humidity Barometer TEMP Meter	LUTRON	MHB-382SD	AJ.38459	2023-11-29
EMI Test Receiver	R&S	ESW8	101170	2024-11-21
EMI Test Receiver	R&S	ESW44	101812	2024-11-22
Active Loop Antenna	R&S	HFH2-Z2E	100881	2025-02-03
Trilog Antenna (with 6 dB ATT.)	Schwarzbeck	VULB 9163	1100	2025-02-08
Horn Antenna	R&S	HF907	102773	2024-12-05
BBHA 9170 Broad-Band Horn Antenna	Schwarzbeck	BBHA9170	00955	2024-11-27
Signal Conditioning Unit	R&S	SCU-18F	180112	2024-11-21
Signal Conditioning Unit	R&S	SCU08F2	08400015	2024-11-21
Amplifier	L3 Narda-MITEQ	JS44-18004000-33-8P	2142086	2024-11-22
Power Meter	R&S	NRX	103577	2024-11-22
Power Sensor	R&S	NRP-Z211	102377	2024-11-22
EMC 32	R&S	EMC32	1000	-
EMC 32	R&S	EMC32	1040	-



## 3 Test Results

### 3.1 Antenna Requirement

**Except from §15.203 of the FCC Rules/Regulations:**

responsible party can be used with the device. The use of a permanently attached antenna or of an antenna that uses a unique coupling to the intentional radiator shall be considered sufficient to comply with the provisions of the section.

- The antenna(s) of the EUT are Permanently attached.
- There are no provisions for connection to an external antenna.

**Result**

The EUT complies with the requirement of §15.203

## 3.2 6 dB Bandwidth

### 3.2.1 Regulation

§15.247(a)(2) : Systems using digital modulation techniques may operate in the 902-928 MHz, 2400-2483.5 MHz, and 5725-5850 MHz bands. **The minimum 6 dB bandwidth shall be at least 500 kHz.**

### 3.2.2 Test Procedure

The automatic bandwidth measurement capability of an instrument may be employed using the X dB bandwidth mode with X set to 6 dB, if the functionality described in 11.8.1 (i.e., RBW = 100 kHz, VBW  $\geq 3 \times$  RBW, and peak detector with maximum hold) is implemented by the instrumentation function. When using this capability, care shall be taken so that the bandwidth measurement is not influenced by any intermediate power nulls in the fundamental emission that might be  $\geq 6$  dB.

### 3.2.3 Test Setup

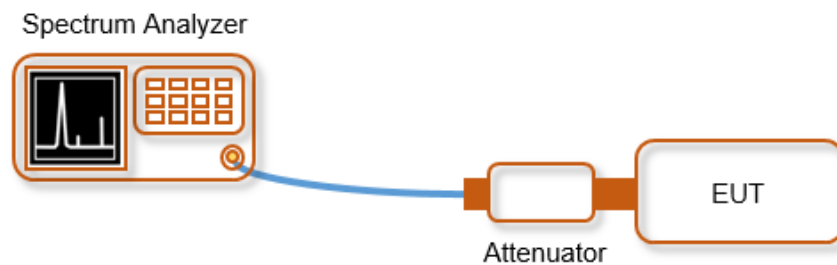

### 3.2.4 Test Result

[Test Data of 6 dB Bandwidth]

Limit: The minimum 6 dB bandwidth shall be at least 500 kHz.

Test Mode	Tested Frequency	6dB Bandwidth [MHz]	
		12 V	24 V
TM 1	2 412	10.11	10.11
	2 437	10.11	10.11
	2 462	10.11	10.11
TM 2	2 412	16.49	16.47
	2 437	16.49	16.53
	2 462	16.48	16.55
TM 3	2 412	17.61	17.61
	2 437	17.61	17.61
	2 462	17.61	17.61
TM 4	2 422	36.38	36.39
	2 437	36.36	36.37
	2 452	36.42	36.41



[Test Plot of 6 dB Bandwidth]

TM 1

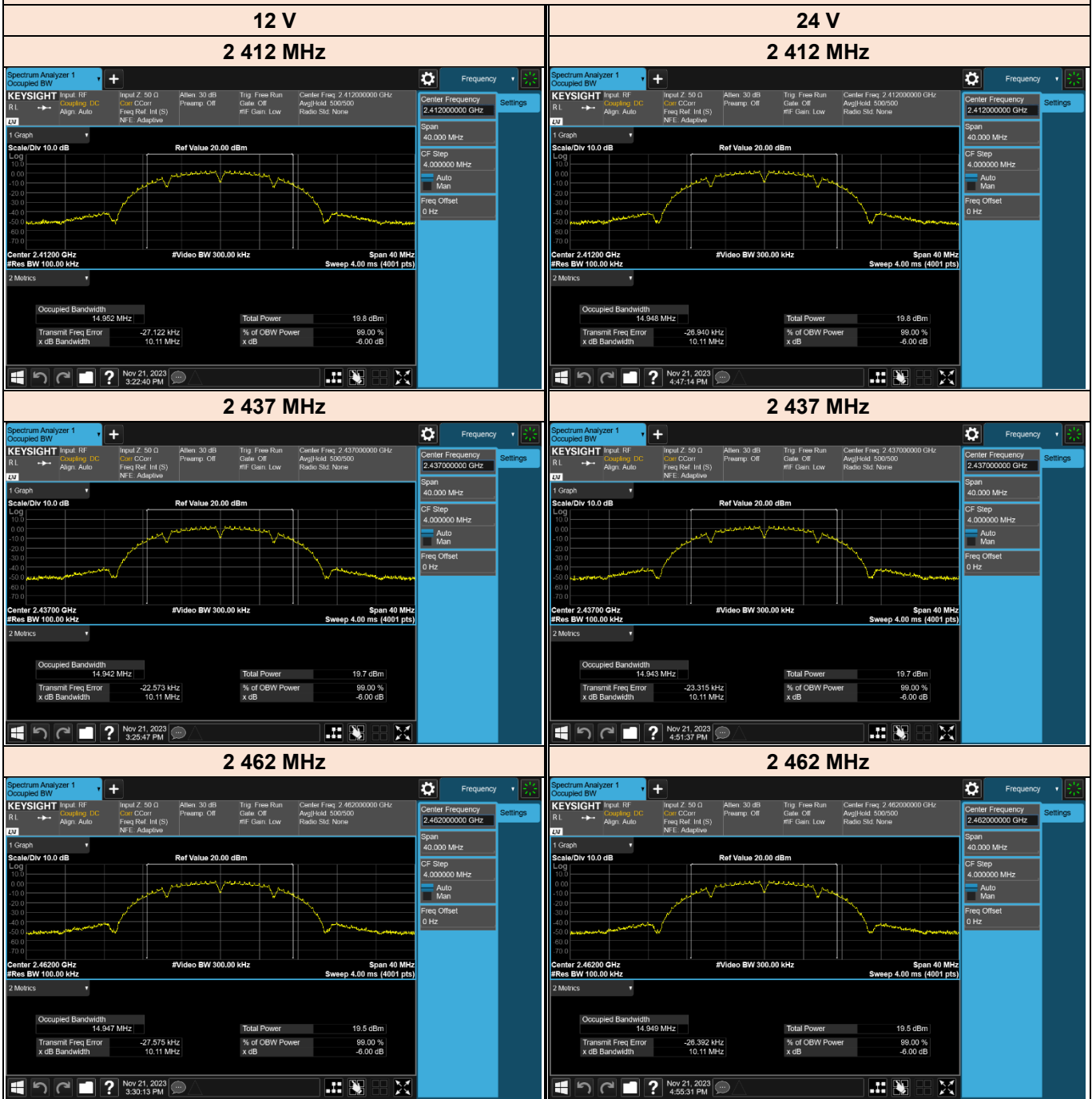



TM 2

12 V

2 412 MHz

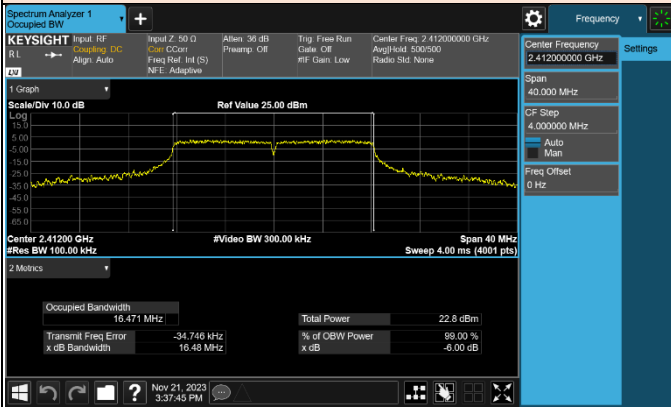

24 V

2 412 MHz

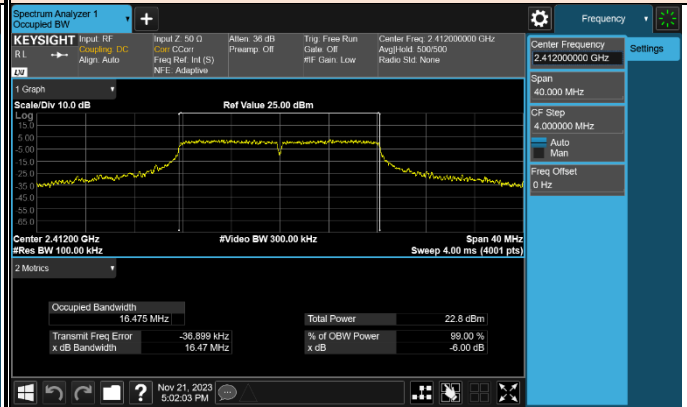

2 437 MHz

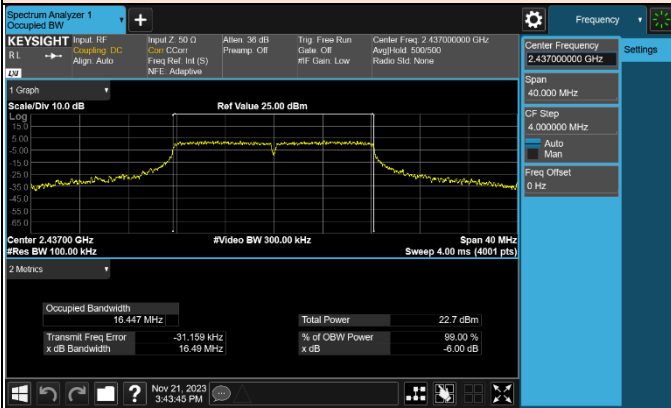

2 437 MHz

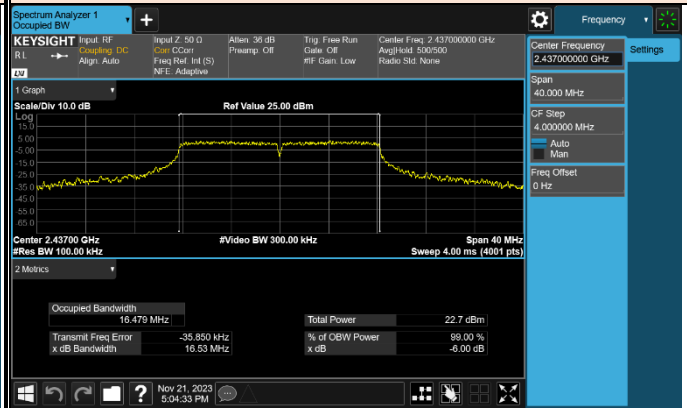

2 462 MHz

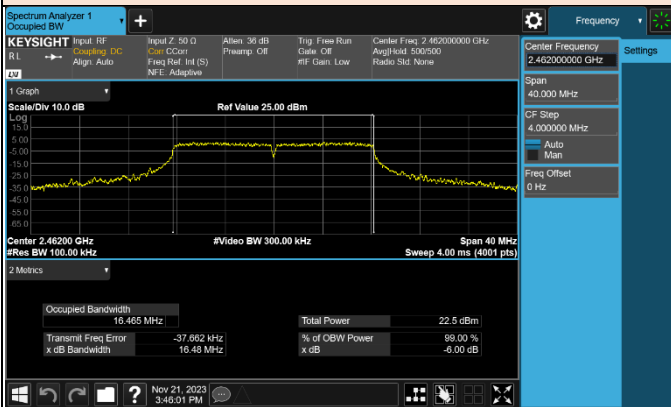

2 462 MHz

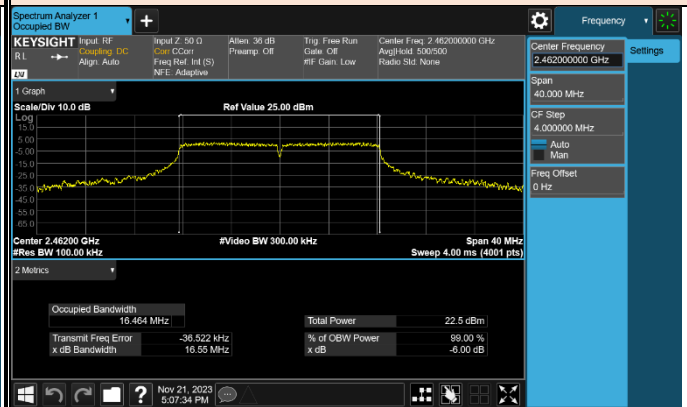



TM 3

12 V

2 412 MHz

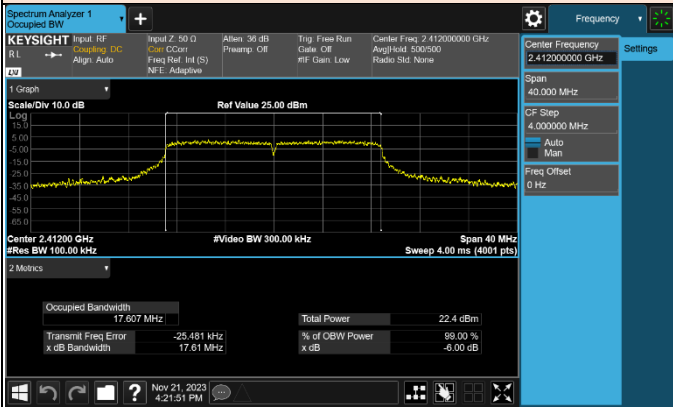

24 V

2 412 MHz

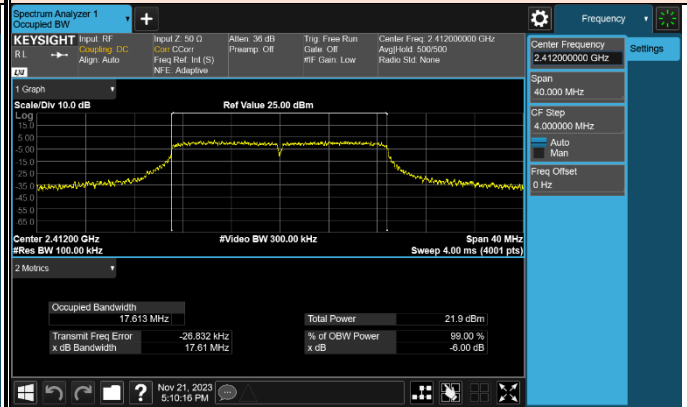

2 437 MHz

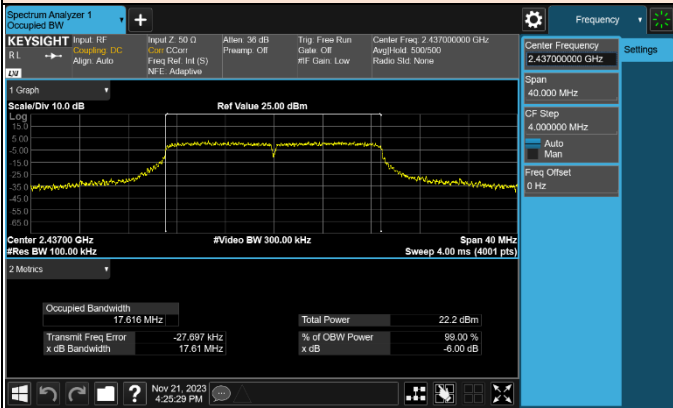

2 437 MHz

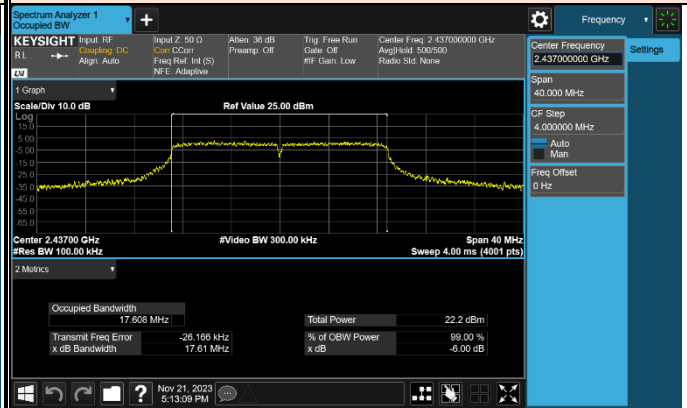

2 462 MHz

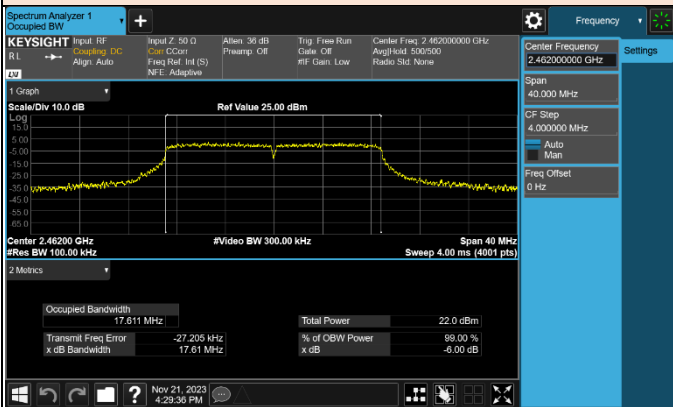

2 462 MHz

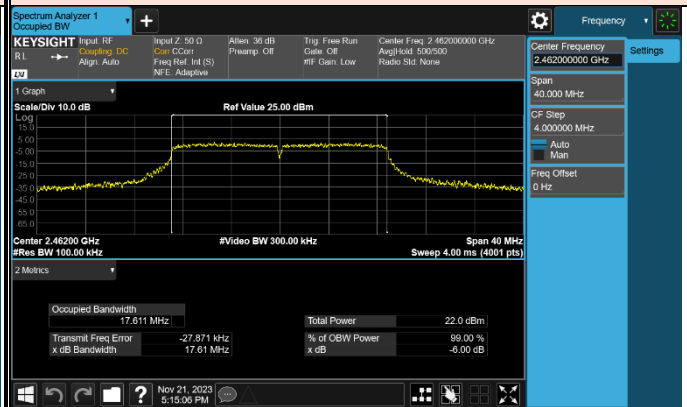



TM 4

12 V

2 422 MHz

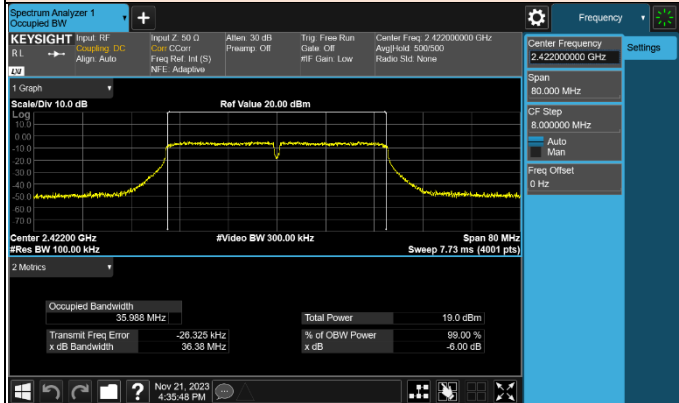

24 V

2 422 MHz

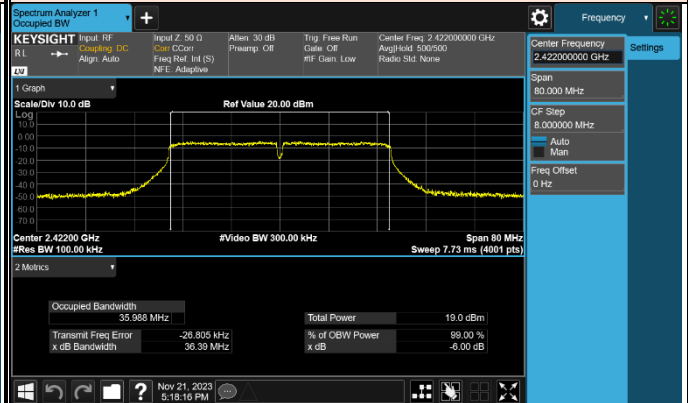

2 437 MHz

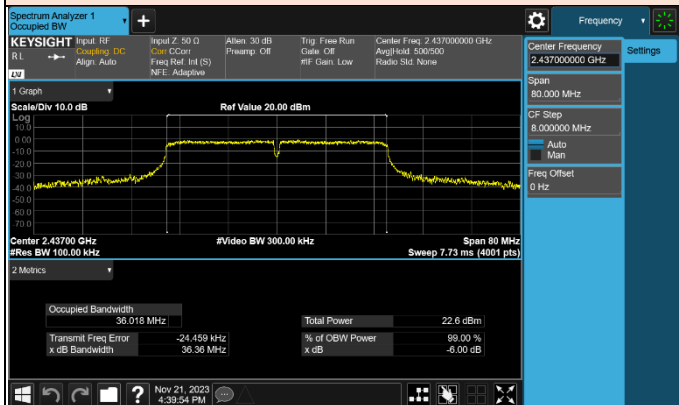

2 437 MHz

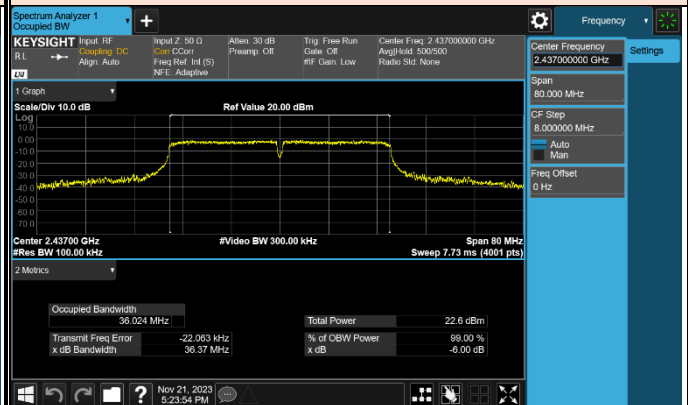

2 452 MHz

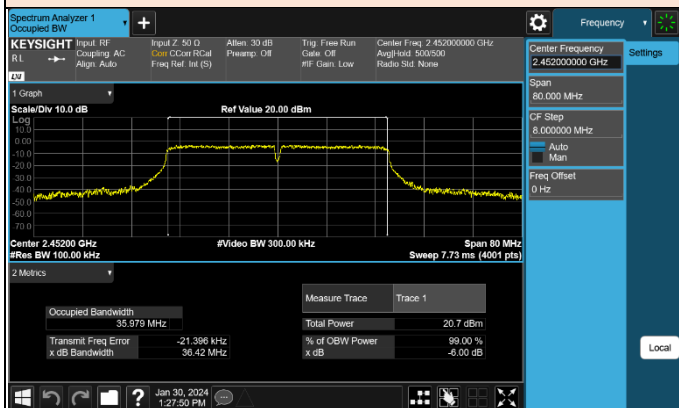

2 452 MHz

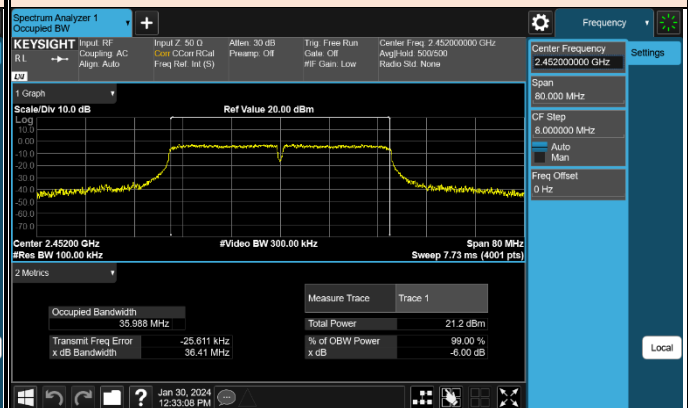

## 3.3 Maximum Peak Output Power

### 3.3.1 Regulation

§15.247(b)(3) : For systems using digital modulation in the 902-928 MHz, 2400-2483.5 MHz, and 5725-5850 MHz bands: 1 Watt. As an alternative to a peak power measurement, compliance with the one Watt limit can be based on a measurement of the maximum conducted output power. Maximum Conducted Output Power is defined as the total transmit power delivered to all antennas and antenna elements averaged across all symbols in the signaling alphabet when the transmitter is operating at its maximum power control level. Power must be summed across all antennas and antenna elements. The average must not include any time intervals during which the transmitter is off or is transmitting at a reduced power level. If multiple modes of operation are possible (e.g., alternative modulation methods), the maximum conducted output power is the highest total transmit power occurring in any mode.

§15.247(b)(4) : The conducted output power limit specified in paragraph (b) of this section is based on the use of antennas with directional gains that do not exceed 6 dBi. Except as shown in paragraph (c) of this section, if transmitting antennas of directional gain greater than 6 dBi are used, the conducted output power from the intentional radiator shall be reduced below the stated values in paragraphs (b)(1), (b)(2), and (b)(3) of this section, as appropriate, by the amount in dB that the directional gain of the antenna exceeds 6 dBi.

### 3.3.2 Test Procedure

#### General

Section 15.247 permits the maximum conducted (average) output power to be measured as an alternative to the maximum peak conducted output power for demonstrating compliance to the limit. When this option is exercised, the measured power is to be referenced to the OBW rather than the DTS bandwidth (see ANSI C63.10 for measurement guidance).

When using a spectrum analyzer or EMI receiver to perform these measurements, it shall be capable of utilizing a number of measurement points in each sweep that is greater than or equal to twice the span/RBW to set a bin-to-bin spacing of  $\leq RBW/2$  so that narrowband signals are not lost between frequency bins.

If possible, configure or modify the operation of the EUT so that it transmits continuously at its maximum power control level. The intent is to test at 100 % duty cycle; however a small reduction in duty cycle (to no lower than 98 %) is permitted, if required by the EUT for amplitude control purposes. Manufacturers are expected to provide software to the test lab to permit such continuous operation.

If continuous transmission (or at least 98 % duty cycle) cannot be achieved due to hardware limitations (e.g., overheating), the EUT shall be operated at its maximum power control level, with the transmit duration as long as possible, and the duty cycle as high as possible during which sweep triggering/signal gating techniques may be used to perform the measurement over the transmission duration.



### 3.3.2.1 Maximum peak conducted output power

One of the following procedures may be used to determine the maximum peak conducted output power of a DTS EUT.

#### **RBW $\geq$ DTS bandwidth**

The following procedure shall be used when an instrument with a resolution bandwidth that is greater than the DTS bandwidth is available to perform the measurement:

- a) Set the RBW  $\geq$  DTS bandwidth.
- b) Set VBW  $\geq$  [3  $\times$  RBW].
- c) Set span  $\geq$  [3  $\times$  RBW].
- d) Sweep time = auto couple.
- e) Detector = peak.
- f) Trace mode = max hold.
- g) Allow trace to fully stabilize.
- h) Use peak marker function to determine the peak amplitude level.

#### **Measurement using a power meter (PM)**

Method AVGPM is a measurement using an RF average power meter, as follows:

- a) As an alternative to spectrum analyzer or EMI receiver measurements, measurements may be performed using a wideband RF power meter with a thermocouple detector or equivalent if all of the conditions listed below are satisfied:
  - 1) The EUT is configured to transmit continuously, or to transmit with a constant duty cycle.
  - 2) At all times when the EUT is transmitting, it shall be transmitting at its maximum power control level.
  - 3) The integration period of the power meter exceeds the repetition period of the transmitted signal by at least a factor of five.
- b) If the transmitter does not transmit continuously, measure the duty cycle, D, of the transmitter output signal as described in 11.6.
- c) Measure the average power of the transmitter. This measurement is an average over both the ON and OFF periods of the transmitter.
- d) Adjust the measurement in dBm by adding [10 log(1/D)], where D is the duty cycle

#### Notes:

A peak responding power sensor is used, where the power sensor system video bandwidth is greater than the occupied bandwidth of the EUT.

### 3.3.3 Test Setup

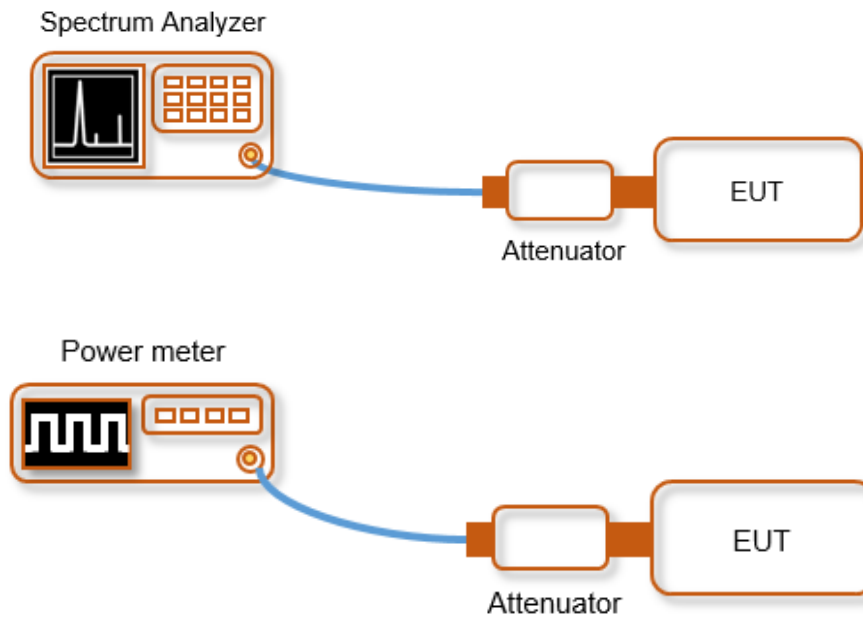

### 3.3.4 Test Result

[Test Result of Peak Power & Average Power]

Limit: 1 Watt

Test Mode	Tested Frequency	Measured Power [dBm]			
		12V		24V	
		PK	Average	PK	Average
TM 1	2 412	11.05	8.57	11.01	8.43
	2 437	10.88	8.32	10.74	8.29
	2 462	10.58	8.13	10.56	7.96
TM 2	2 412	<b>23.80</b>	<b>16.73</b>	<b>23.61</b>	<b>16.70</b>
	2 437	23.17	16.20	23.08	16.02
	2 462	22.87	15.88	22.78	15.79
TM 3	2 412	23.37	16.30	23.31	16.14
	2 437	23.21	16.02	23.14	16.06
	2 462	22.00	14.90	22.01	14.80
TM 4	2 422	23.02	15.80	22.88	15.79
	2 437	22.78	15.69	22.77	15.61
	2 452	22.23	15.07	22.15	15.06

Note: Average Power = Measurement Average Power + Duty cycle factor.

## 3.4 Power Spectral Density

### 3.4.1 Regulation

§15.247(e) : For digitally modulated systems, the power spectral density conducted from the intentional radiator to the antenna shall not be greater than 8 dBm in any 3 kHz band during any time interval of continuous transmission. This power spectral density shall be determined in accordance with the provisions of paragraph (b) of this section. The same method of determining the conducted output power shall be used to determine the power spectral density.

### 3.4.2 Test Procedure

The following procedure shall be used if maximum peak conducted output power was used to determine compliance, and it is optional if the maximum conducted (average) output power was used to determine compliance:

- a) Set analyzer center frequency to DTS channel center frequency.
- b) Set the span to 1.5 times the DTS bandwidth.
- c) Set the RBW to  $3 \text{ kHz} \leq \text{RBW} \leq 100 \text{ kHz}$ .
- d) Set the VBW  $\geq [3 \times \text{RBW}]$ .
- e) Detector = peak.
- f) Sweep time = auto couple.
- g) Trace mode = max hold.
- h) Allow trace to fully stabilize.
- i) Use the peak marker function to determine the maximum amplitude level within the RBW.
- j) If measured value exceeds requirement, then reduce RBW (but no less than 3 kHz) and repeat.

### 3.4.3 Test Setup

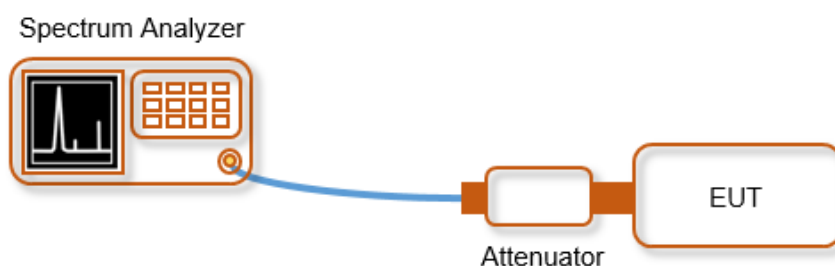

### 3.4.4 Test Result

[Test Data of Power Spectral Density]

Limit: not be greater than 8 dBm in any 3 kHz

Test Mode	Tested Frequency	Measured Power [dBm/3kHz]	
		12 V	24 V
TM 1	2 412	-15.93	-16.25
	2 437	-16.19	-16.15
	2 462	-16.12	-16.53
TM 2	2 412	-11.28	-11.49
	2 437	-11.61	-11.40
	2 462	-11.79	-11.57
TM 3	2 412	-11.25	-11.08
	2 437	-10.78	-11.19
	2 462	-11.22	-10.78
TM 4	2 422	-16.07	-17.08
	2 437	-12.58	-13.49
	2 452	-13.67	-13.16



BUREAU VERITAS

### [Test Plot of Power Spectral Density]

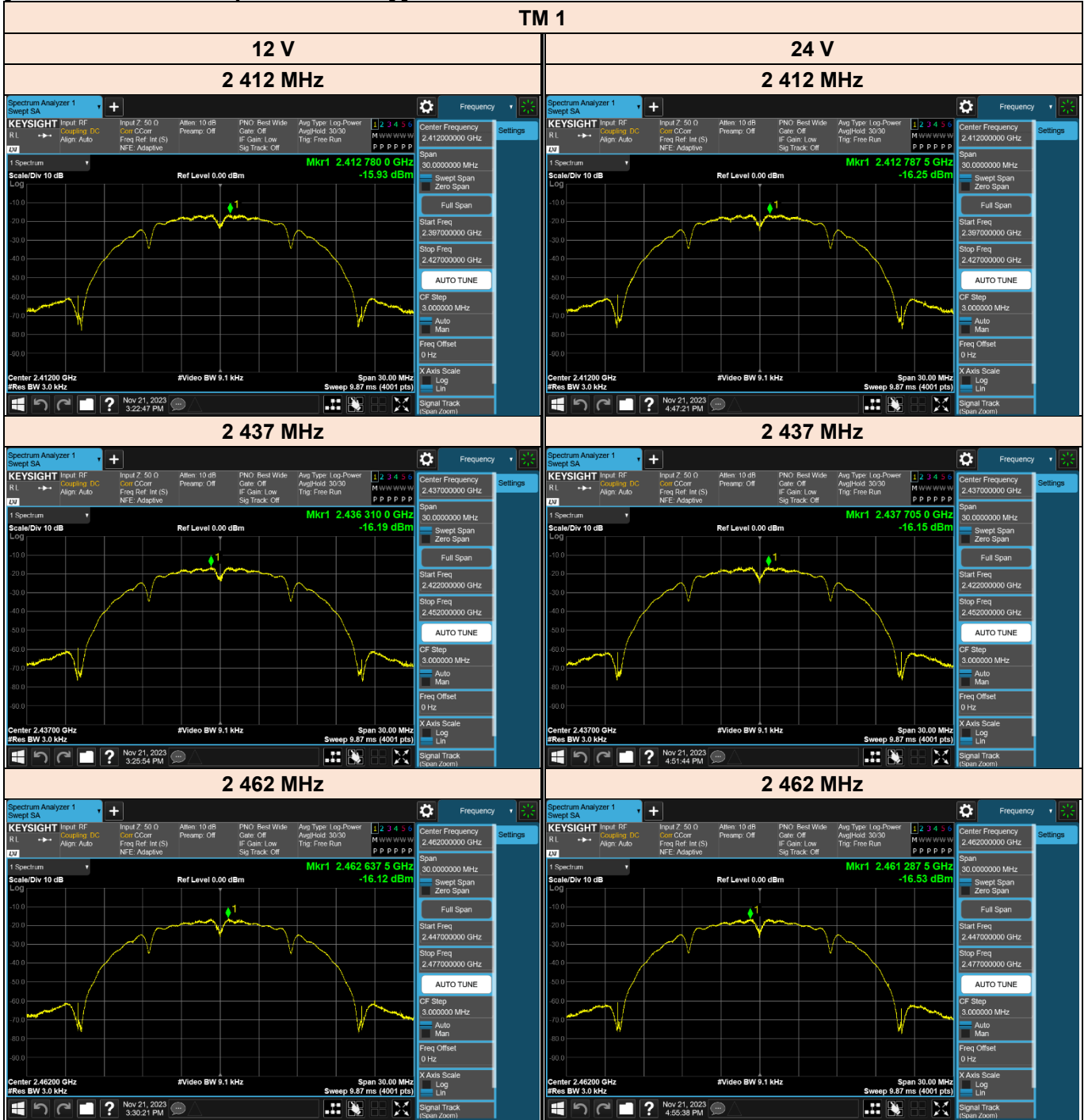



BUREAU VERITAS

TM 2

12 V

2 412 MHz

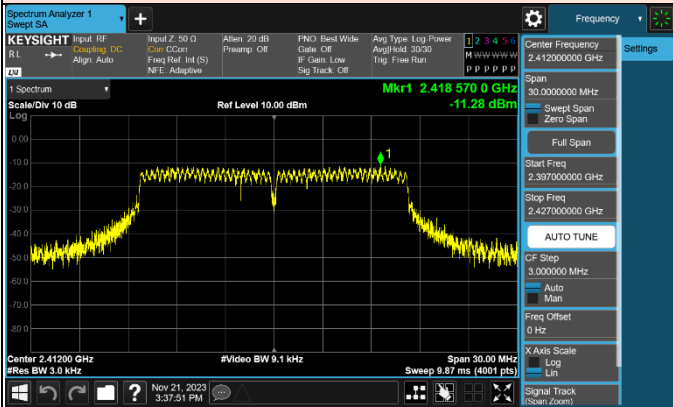

24 V

2 412 MHz

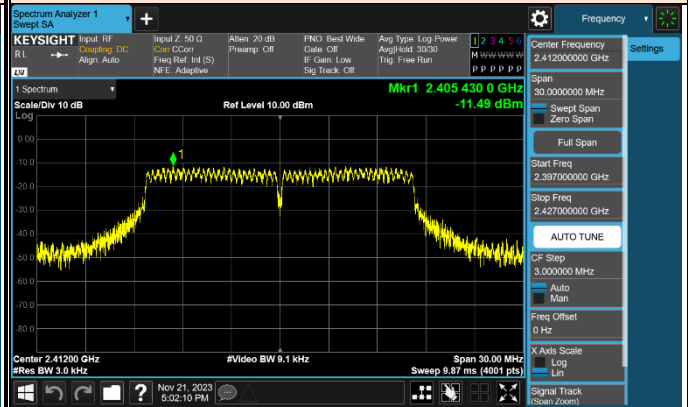

2 437 MHz

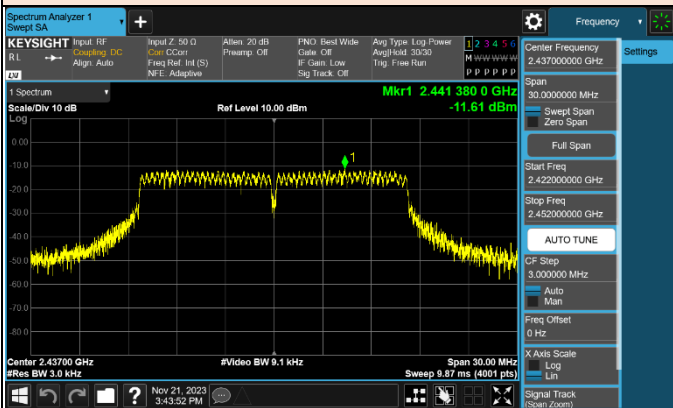

2 437 MHz

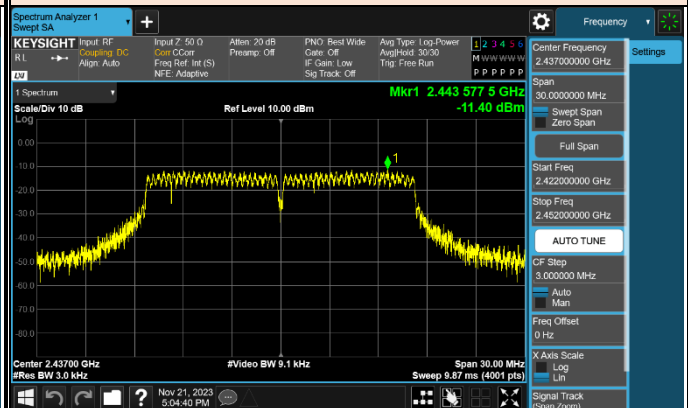

2 462 MHz

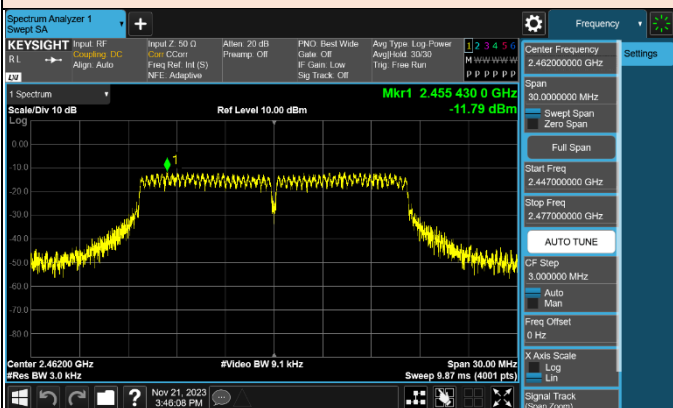

2 462 MHz

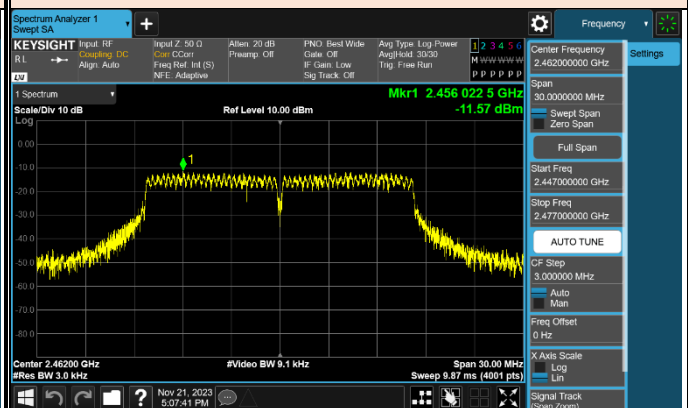



TM 3

12 V

2 412 MHz

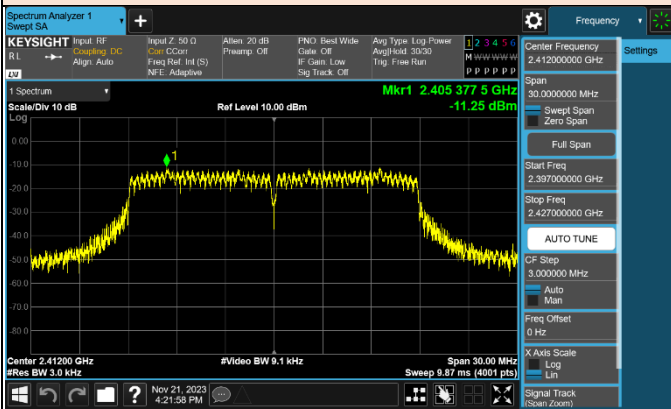

24 V

2 412 MHz

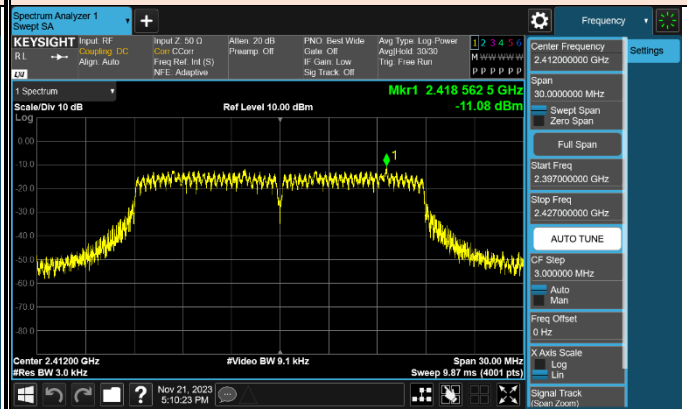

2 437 MHz

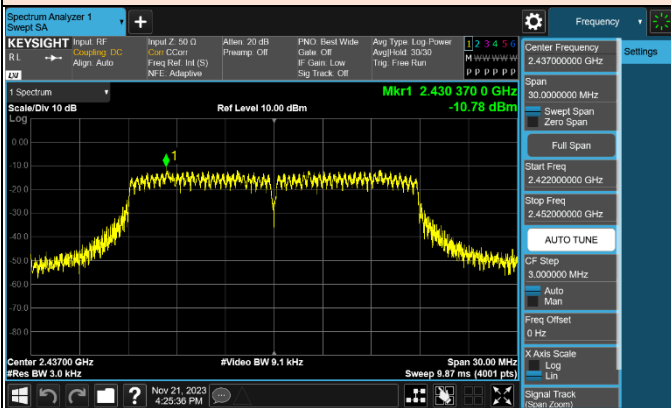

2 437 MHz

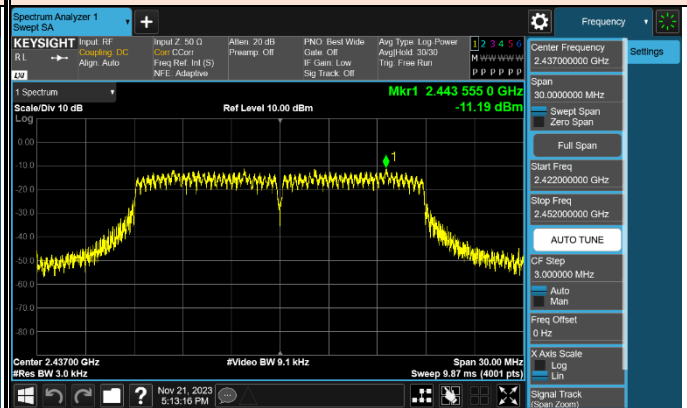

2 462 MHz

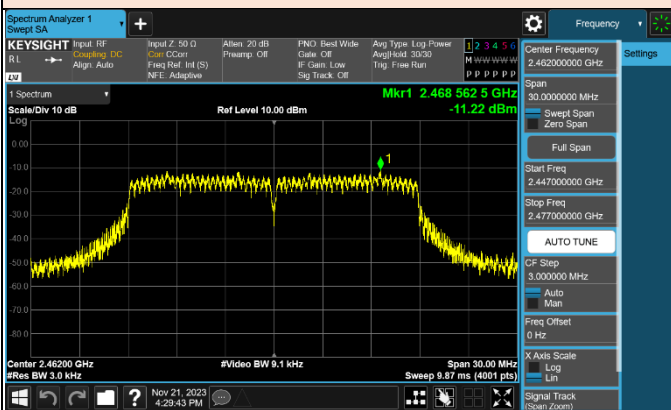

2 462 MHz

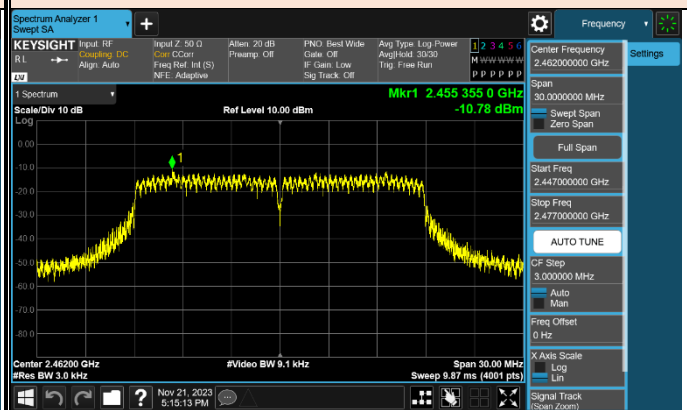





TM 4

12 V

2 422 MHz

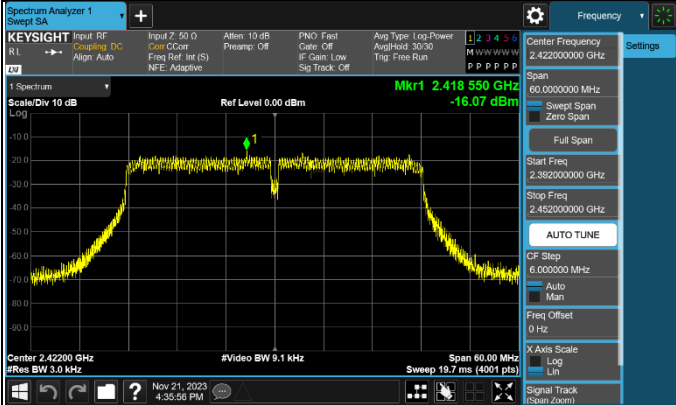

24 V

2 422 MHz

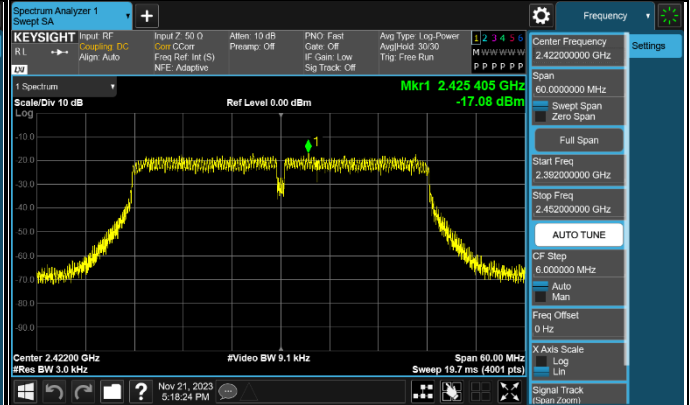

2 437 MHz

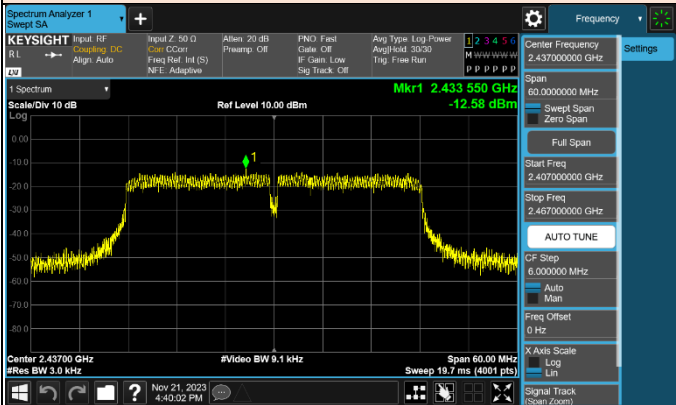

2 437 MHz

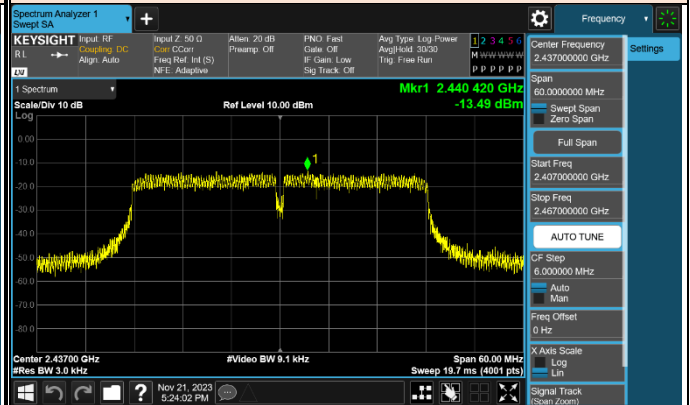

2 452 MHz

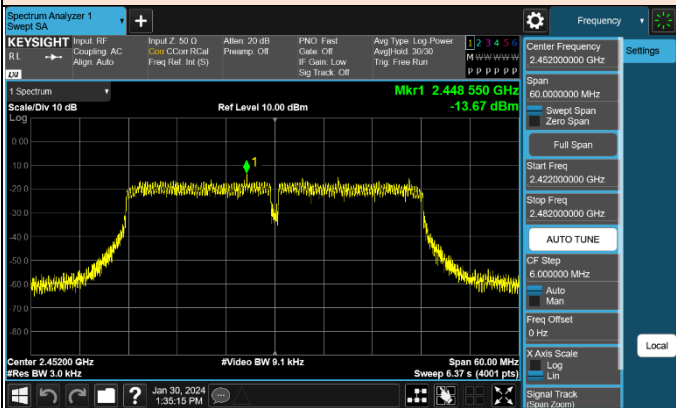

2 452 MHz

