



BUREAU
VERITAS

RF Test Report

2.4 GHz Bluetooth LE

Report No. : FCCCBNW-WAY-P23110165-1
Customer : Pittasoft Co., Ltd.
Address : A 4th floor, ABN Tower, 331, Pangyo-ro, Bundang-gu
Seongnam-si, Gyeonggi-do South Korea
Use of Report : Certification
Model Name : DR970X Plus
FCC ID : YCK-DR970XP
Date of Test : 2023.11.15 to 2024.01.22
Test Method Used : FCC 47 CFR PART 15 Subpart C (Section §15.247)
KDB558074 D01v05r02,
ANSI C63.10-2013
Testing Environment : Refer to the Test Condition

Test Result : Pass Fail

ISSUED BY: BV CPS ADT Korea Ltd., EMC/RF Laboratory

ADDRESS: Innoplex No.2 106, Sinwon-ro 306, Yeongtong-gu,
Suwon-si, Gyeonggi-do, Korea 16675

TEST LOCATION: HeungAn-daero 49, DongAn-gu, Anyang-si,
Gyeonggi-do, Korea, 14119

Tested by

Name : Kwangmin JUNG

(Signature)

Technical Manager

Name : Donghwa SHIN

(Signature)

2024. 01. 26

BV CPS ADT Korea Ltd.

This report is for your exclusive use. Any copying or replication of this report to or for any other person or entity, or use of our name or trademark, is permitted only with our prior written permission. This report sets forth our findings solely with respect to the test samples identified herein. The results set forth in this report are not indicative or representative of the quality or characteristics of the lot from which a test sample was taken or any similar or identical product unless specifically and expressly noted. Our report includes all of the tests requested by you and the results thereof based upon the information that you provided to us. You have 60 days from date of issuance of this report to notify us of any material error or omission caused by our negligence, provided, however, that such notice shall be in writing and shall specifically address the issue you wish to raise. A failure to raise such issue within the prescribed time shall constitute your unqualified acceptance of the completeness of this report, the tests conducted and the correctness of the report contents. Unless specific mention, the uncertainty of measurement has been explicitly taken into account to declare the compliance or non-compliance to the specification.



BUREAU
VERITAS

RELEASE CONTROL RECORD

REPORT NO.	REASON FOR CHANGE	DATE ISSUED
FCCCBNW-WAY-P23110165-1	Original release	2024.01.26

Table of Contents

RELEASE CONTROL RECORD	2
1 SUMMARY OF TEST RESULTS.....	4
1.1 DECISION RULES FOR STATEMENT OF CONFORMITY	5
1.2 MEASUREMENT UNCERTAINTY	5
2 GENERAL INFORMATION.....	6
2.1 GENERAL DESCRIPTION OF EUT.....	6
2.2 TESTED SAMPLE AND TESTED COMPANION DEVICE INFORMATION	6
2.3 DESCRIPTION OF TEST MODE	7
2.4 INSTRUMENT CALIBRATION.....	7
2.5 EUT CONFIGURATION.....	7
2.6 GENERAL DESCRIPTION OF APPLIED STANDARDS	7
2.7 TEST EQUIPMENT.....	8
3 TEST RESULTS	9
3.1 ANTENNA REQUIREMENT	9
3.2 6 DB BANDWIDTH.....	10
3.3 MAXIMUM PEAK OUTPUT POWER.....	11
3.4 POWER SPECTRAL DENSITY	16
3.5 SPURIOUS EMISSION, BAND EDGE AND RESTRICTED BANDS.....	19
3.6 AC CONDUCTED EMISSIONS (150 KHZ TO 30 MHZ).....	35
3.7 DUTY CYCLE.....	36
APPENDIX – INFORMATION OF THE TESTING LABORATORIES	38

1 Summary of Test Results

The EUT has been tested according to the following specifications

Applied Standard : FCC Part 15, Subpart C 15.247					
FCC Part Section(s)	Test Description	Limit	Test Condition	Test Result	Reference
15.247(a)(2)	6 dB Bandwidth	> 500 kHz	Conducted	PASS	Section 3.2
15.247(b)(3)	Maximum Peak Output Power	< 1 Watt		PASS	Section 3.3
15.247(e)	Power Spectral Density	< 8 dBm / 3 kHz Band		PASS	Section 3.4
15.247(d)	Conducted spurious emissions	≥ 20 dBc In any 100 kHz bandwidth		PASS	Section 3.5
15.205 15.209	General Field Strength Limits (Restricted Bands and Radiated Emission Limits)	Emissions in Restricted bands must meet the radiated limits detailed in 15.209	Radiated	PASS	Section 3.5
15.207	AC Conducted Emissions (150 kHz – 30 MHz)	< FCC 15.207 limits	AC Line Conducted	NA ^{Note3)}	Section 3.6
15.203	Antenna Requirement	FCC 15.203	-	PASS	Section 3.1

NOTES

- 1) The general test methods used to test on this devices are ANSI C63.10.
- 2) Determining compliance based on the results of the compliance measurement, not taking into account measurement instrumentation uncertainty.
- 3) Devices which only employ battery power for operation.

1.1 Decision Rules for Statement of Conformity

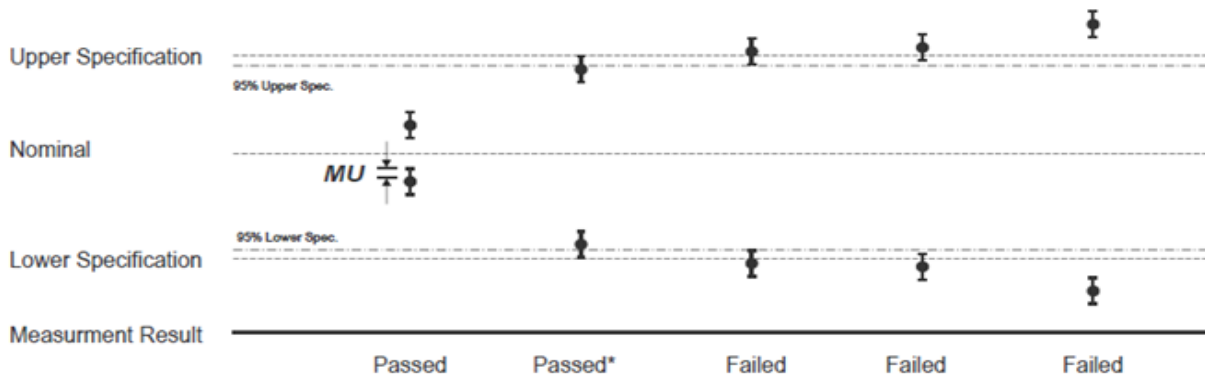

QUA-52 Decision Rule(QA Document) was applied.

Step 1) : Reference Check, Daily Check, Peripheral device Check

Step 2) : Re-test Procedure (Repeat the test maximum 3 times, Different Test Engineer)

- 1) If the original test results are subject to retesting and the judgement is unclear, the retest is carried out.
- 2) If the result of the first retest is the same as the initial test, the judgement is made based on the value.
- 3) If the result of the first retest differ from the results of the initial test, the second re-test is carried out.
- 4) After completion of the second retest, the average of the three test results is determined as the final result. However, if the deviation of the three test values is more than 5 % of the reference value, the technical manager should review the reproducibility of the test from the beginning.

1.2 Measurement Uncertainty

Where relevant, the following measurement uncertainty levels have been estimated for tests performed on the EUT as specified in CISPR 16-4-2

Measurement Items	Frequency Range	Expanded Uncertainty $U = kUc (k = 2)$
Radiated Spurious Emissions	9 kHz – 30 MHz	2.00
	30 MHz – 1 GHz	4.22
	1 GHz – 18 GHz	5.40
	18 GHz – 26.5 GHz	5.08
Measurement Items		Expanded Uncertainty $U = kUc (k = 2)$
Conducted	Maximum Output Power	1.20
	Spurious Emissions	1.36

This uncertainty represents an expanded uncertainty expressed at approximately the 95 % confidence level using a coverage factor of $k = 2$.



2 General Information

2.1 General Description of EUT

Equipment Class	Digital Transmission System (DTS)
Product name	CAR DASHCAM
FCC ID	YCK-DR970XP
Model	DR970X Plus
Additional model name	DR970X-1CH Plus, DR970X-2CH Plus, DR970X-2CH IR Plus, DR970X-2CH Truck Plus, DR970X-2CH DMS Plus
Power Supply	DC 12 V , DC 24V
Modulation Type	GFSK
Transfer Rate	1Mbps
Operating Frequency	2 402 MHz to 2 480 MHz
Output Power	8.17 dBm
Antenna Type	Chip Antenna
Antenna Gain	-1.79 dBi
H/W Version	1.0
S/W Version	1.0

NOTE 1: For a more detailed features description, please refer to the manufacturer's specifications or the user's manual.

NOTE 2: For the test results, the EUT had been tested with all conditions. But only the worst case was shown in test report.

2.2 Tested sample and Tested companion device information

Type	Model	Note
Test sample (Conducted)	DR970X Plus	S/N: 97XPK3MAE00210
Test sample (Radiated)	DR970X Plus	S/N: 97XPK3MAE00213

2.3 Description of Test Mode

The EUT has been tested with all modes of operating conditions to determine the worst case emission characteristics.

Test Mode		Tested Frequency (MHz)		
TM 1	Bluetooth LE (1 Mbps)	2 402	2 440	2 480

Note: A test was performed for each voltage.

2.4 INSTRUMENT CALIBRATION

The measuring equipment, which was utilized in performing the tests documented herein, has been calibrated in accordance with the manufacturer's recommendations for utilizing calibration equipments, which is traceable to recognized national standards.

2.5 EUT CONFIGURATION

The EUT configuration for testing is installed on RF field strength measurement to meet the Commissions requirement and operating in a manner that intends to maximize its emission characteristics in a continuous normal application.

2.6 General Description of Applied Standards

Generally the tests were performed according to the specifications of the standard, it must comply with the requirements of the following standards.

FCC CFR 47 Part 15, Subpart C (§15.247)
KDB 558074 D01 15.247 Meas Guidance v05r02
ANSI C63.10-2013

All test items in this test report have been performed and recorded as per the above standards.



2.7 Test Equipment

Test Equipment is traceable to the National Institute of Standards and Technology (NIST). Measurement antenna used during testing were calibrated in accordance to the requirements of ANSI C63.5-2017.

Equipment Name	Manufacturer	Model No.	Serial No.	Next Cal. Date
Spectrum Analyzer	R&S	FSW50	101403	2024-11-22
Signal Analyzer	R&S	FSV30	103017	2024-11-22
Signal Analyzer	Keysight Technologies	N9020B	MY62150135	2024-05-25
Signal Analyzer	Keysight Technologies	N9030B	MY57142476	2024-11-22
MXG Vector Signal Generator	Keysight Technologies	N5182B	MY53051310	2024-11-22
Signal Generator	R&S	SMB100A	MY41006053	2024-05-25
DC Power Supply	Keysight Technologies	E3632A	MY62216181	2024-05-25
Attenuator	Aeroflex	40AH2W-10	1	2024-11-22
True-RMS Digital Multimeter	Fluke	177	43240434	2024-05-25
High Pass Filter	Micro-Tronics	HPM17543	28	2024-05-25
High Pass Filter	Wt Microwave	WT-A1698-HS	WT190313-6-4	2024-11-22
Humidity Barometer TEMP Meter	LUTRON	MHB-382SD	AJ.38475	2024-11-21
Humidity Barometer TEMP Meter	LUTRON	MHB-382SD	AJ.38459	2023-11-29
EMI Test Receiver	R&S	ESW8	101170	2024-11-21
EMI Test Receiver	R&S	ESW44	101812	2024-11-22
Active Loop Antenna	R&S	HFH2-Z2E	100881	2025-02-03
Trilog Antenna (with 6 dB ATT.)	Schwarzbeck	VULB 9163	1100	2025-02-08
Horn Antenna	R&S	HF907	102773	2024-12-05
BBHA 9170 Broad-Band Horn Antenna	Schwarzbeck	BBHA9170	00955	2024-11-27
Signal Conditioning Unit	R&S	SCU-18F	180112	2024-11-21
Signal Conditioning Unit	R&S	SCU08F2	08400015	2024-11-21
Amplifier	L3 Narda-MITEQ	JS44-18004000-33-8P	2142086	2024-11-22
Power Meter	R&S	NRX	103577	2024-11-22
Power Sensor	R&S	NRP-Z211	102377	2024-11-22
EMC 32	R&S	EMC32	1000	-
EMC 32	R&S	EMC32	1040	-

3 Test Results

3.1 Antenna Requirement

Except from §15.203 of the FCC Rules/Regulations:

An intentional radiator antenna shall be designed to ensure that no antenna other than that furnished by the responsible party can be used with the device. The use of a permanently attached antenna or of an antenna that uses a unique coupling to the intentional radiator shall be considered sufficient to comply with the provisions of the section.

- The antenna(s) of the EUT are Permanently attached.
- There are no provisions for connection to an external antenna.

Result

The EUT complies with the requirement of §15.203

3.2 6 dB Bandwidth

3.2.1 Regulation

§15.247(a)(2) : Systems using digital modulation techniques may operate in the 902-928 MHz, 2400-2483.5 MHz, and 5725-5850 MHz bands. **The minimum 6 dB bandwidth shall be at least 500 kHz.**

3.2.2 Test Procedure

The automatic bandwidth measurement capability of an instrument may be employed using the X dB bandwidth mode with X set to 6 dB, if the functionality described in 11.8.1 (i.e., RBW = 100 kHz, VBW ≥ 3 × RBW, and peak detector with maximum hold) is implemented by the instrumentation function. When using this capability, care shall be taken so that the bandwidth measurement is not influenced by any intermediate power nulls in the fundamental emission that might be ≥6 dB.

3.2.3 Test Setup

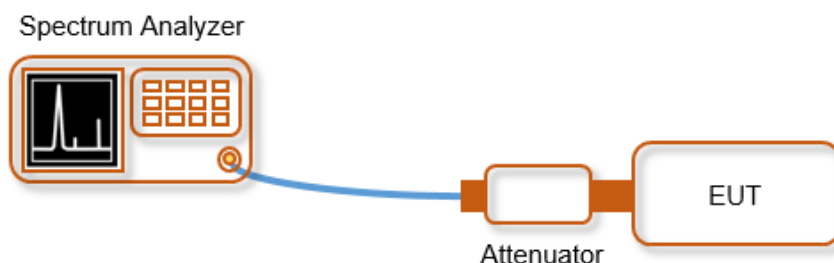

3.2.4 Test Result

[Test Data of 6 dB Bandwidth]

Limit: The minimum 6 dB bandwidth shall be at least 500 kHz.

Test Mode	Tested Frequency	6dB Bandwidth [MHz]	
		12 V	24 V
TM 1	2 402	0.712	0.722
	2 440	0.731	0.718
	2 480	0.720	0.719



[Test Plot of 6 dB Bandwidth]

TM 1

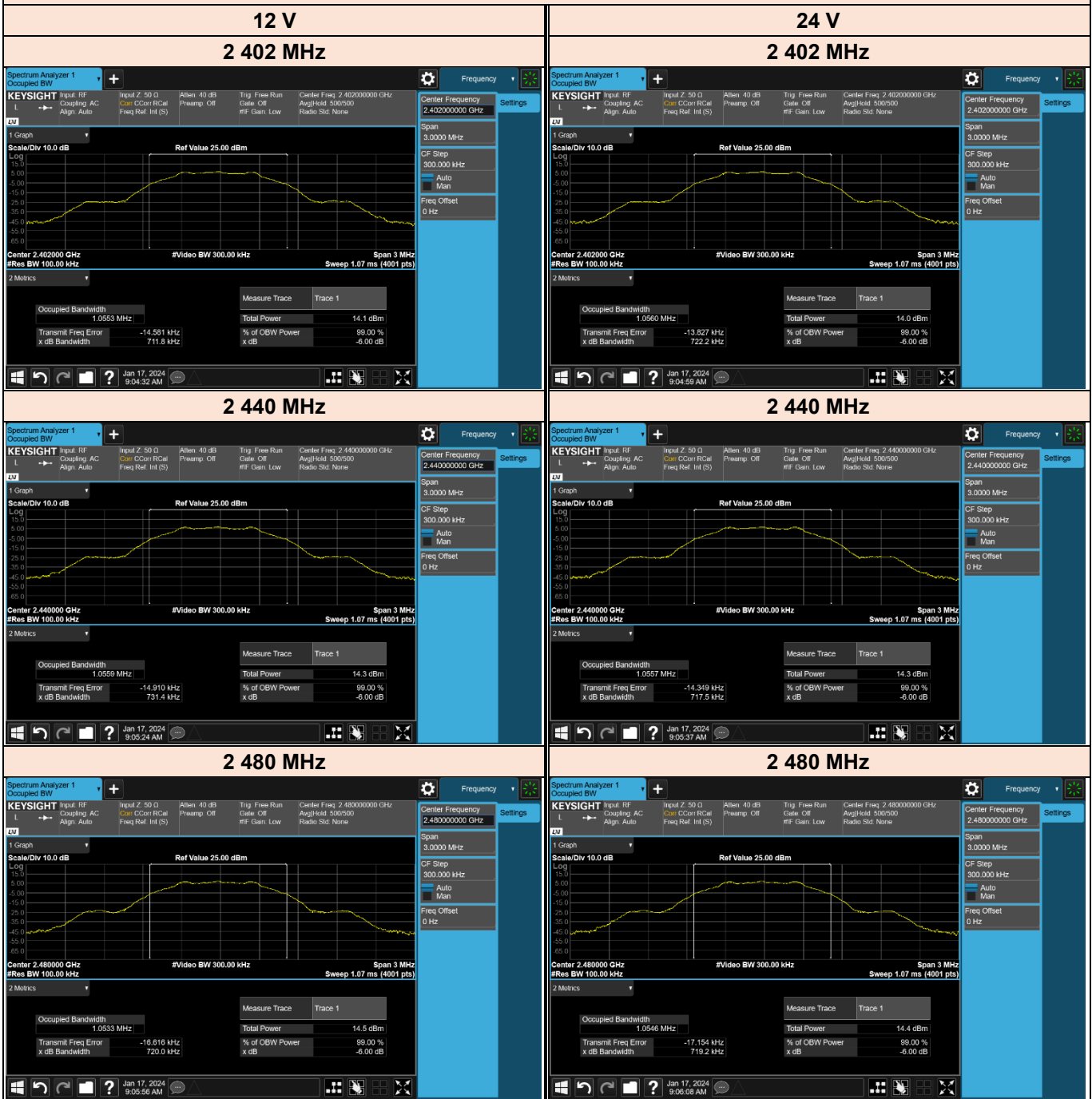

3.3 Maximum Peak Output Power

3.3.1 Regulation

§15.247(b)(3) : For systems using digital modulation in the 902-928 MHz, 2400-2483.5 MHz, and 5725-5850 MHz bands: 1 Watt. As an alternative to a peak power measurement, compliance with the one Watt limit can be based on a measurement of the maximum conducted output power. Maximum Conducted Output Power is defined as the total transmit power delivered to all antennas and antenna elements averaged across all symbols in the signaling alphabet when the transmitter is operating at its maximum power control level. Power must be summed across all antennas and antenna elements. The average must not include any time intervals during which the transmitter is off or is transmitting at a reduced power level. If multiple modes of operation are possible (e.g., alternative modulation methods), the maximum conducted output power is the highest total transmit power occurring in any mode.

§15.247(b)(4) : The conducted output power limit specified in paragraph (b) of this section is based on the use of antennas with directional gains that do not exceed 6 dBi. Except as shown in paragraph (c) of this section, if transmitting antennas of directional gain greater than 6 dBi are used, the conducted output power from the intentional radiator shall be reduced below the stated values in paragraphs (b)(1), (b)(2), and (b)(3) of this section, as appropriate, by the amount in dB that the directional gain of the antenna exceeds 6 dBi.

3.3.2 Test Procedure

General

Section 15.247 permits the maximum conducted (average) output power to be measured as an alternative to the maximum peak conducted output power for demonstrating compliance to the limit. When this option is exercised, the measured power is to be referenced to the OBW rather than the DTS bandwidth (see ANSI C63.10 for measurement guidance).

When using a spectrum analyzer or EMI receiver to perform these measurements, it shall be capable of utilizing a number of measurement points in each sweep that is greater than or equal to twice the span/RBW to set a bin-to-bin spacing of $\leq \text{RBW}/2$ so that narrowband signals are not lost between frequency bins.

If possible, configure or modify the operation of the EUT so that it transmits continuously at its maximum power control level. The intent is to test at 100 % duty cycle; however a small reduction in duty cycle (to no lower than 98 %) is permitted, if required by the EUT for amplitude control purposes. Manufacturers are expected to provide software to the test lab to permit such continuous operation.

If continuous transmission (or at least 98 % duty cycle) cannot be achieved due to hardware limitations (e.g., overheating), the EUT shall be operated at its maximum power control level, with the transmit duration as long as possible, and the duty cycle as high as possible during which sweep triggering/signal gating techniques may be used to perform the measurement over the transmission duration.

3.3.2.1 Maximum peak conducted output power

One of the following procedures may be used to determine the maximum peak conducted output power of a DTS EUT.

RBW \geq DTS bandwidth

The following procedure shall be used when an instrument with a resolution bandwidth that is greater than the DTS bandwidth is available to perform the measurement:

- a) Set the RBW \geq DTS bandwidth.
- b) Set VBW \geq [3 \times RBW].
- c) Set span \geq [3 \times RBW].
- d) Sweep time = auto couple.
- e) Detector = peak.
- f) Trace mode = max hold.
- g) Allow trace to fully stabilize.
- h) Use peak marker function to determine the peak amplitude level.

PKPM1 Peak power meter method

The maximum peak conducted output power may be measured using a broadband peak RF power meter. The power meter shall have a video bandwidth that is greater than or equal to the DTS bandwidth and shall use a fast-responding diode detector.

Measurement using a power meter (PM)

Method AVGPM is a measurement using an RF average power meter, as follows:

- a) As an alternative to spectrum analyzer or EMI receiver measurements, measurements may be performed using a wideband RF power meter with a thermocouple detector or equivalent if all of the conditions listed below are satisfied:
 - 1) The EUT is configured to transmit continuously, or to transmit with a constant duty cycle.
 - 2) At all times when the EUT is transmitting, it shall be transmitting at its maximum power control level.
 - 3) The integration period of the power meter exceeds the repetition period of the transmitted signal by at least a factor of five.
- b) If the transmitter does not transmit continuously, measure the duty cycle, D, of the transmitter output signal as described in 11.6.
- c) Measure the average power of the transmitter. This measurement is an average over both the ON and OFF periods of the transmitter.
- d) Adjust the measurement in dBm by adding [10 log(1/D)], where D is the duty cycle

Notes:

A peak responding power sensor is used, where the power sensor system video bandwidth is greater than the occupied bandwidth of the EUT.

3.3.3 Test Setup

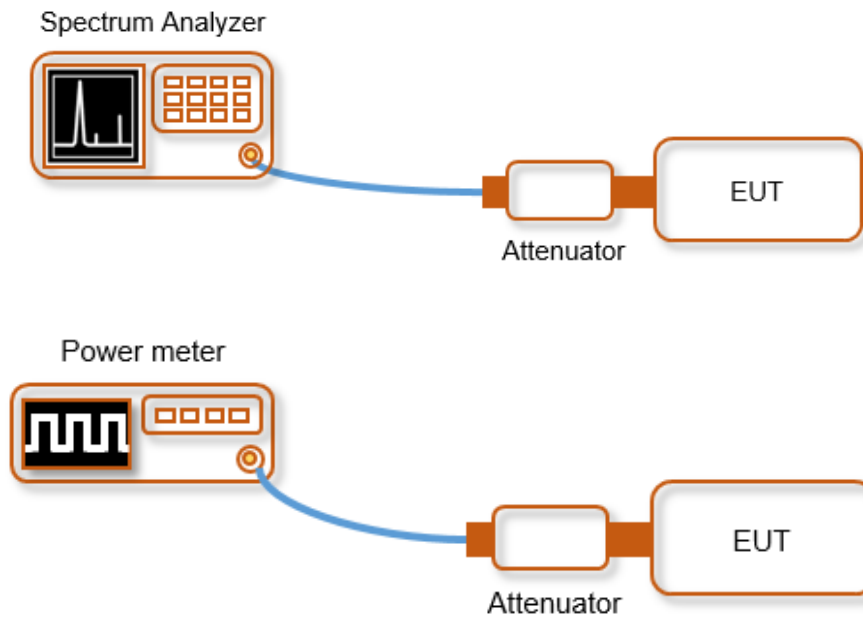

3.3.4 Test Result

[Test Result of Peak Power & Average Power]

Limit: 1 Watt

Test Mode	Tested Frequency	Measured Power [dBm]			
		12V		24V	
		PK	Average	PK	Average
TM 1	2 402	7.73	7.44	7.72	7.47
	2 440	7.88	7.71	7.87	7.71
	2 480	8.17	7.72	8.17	7.72

Note: Average Power = Measurement Average Power + Duty cycle factor.



BUREAU VERITAS

[Test Plot of Peak Power]

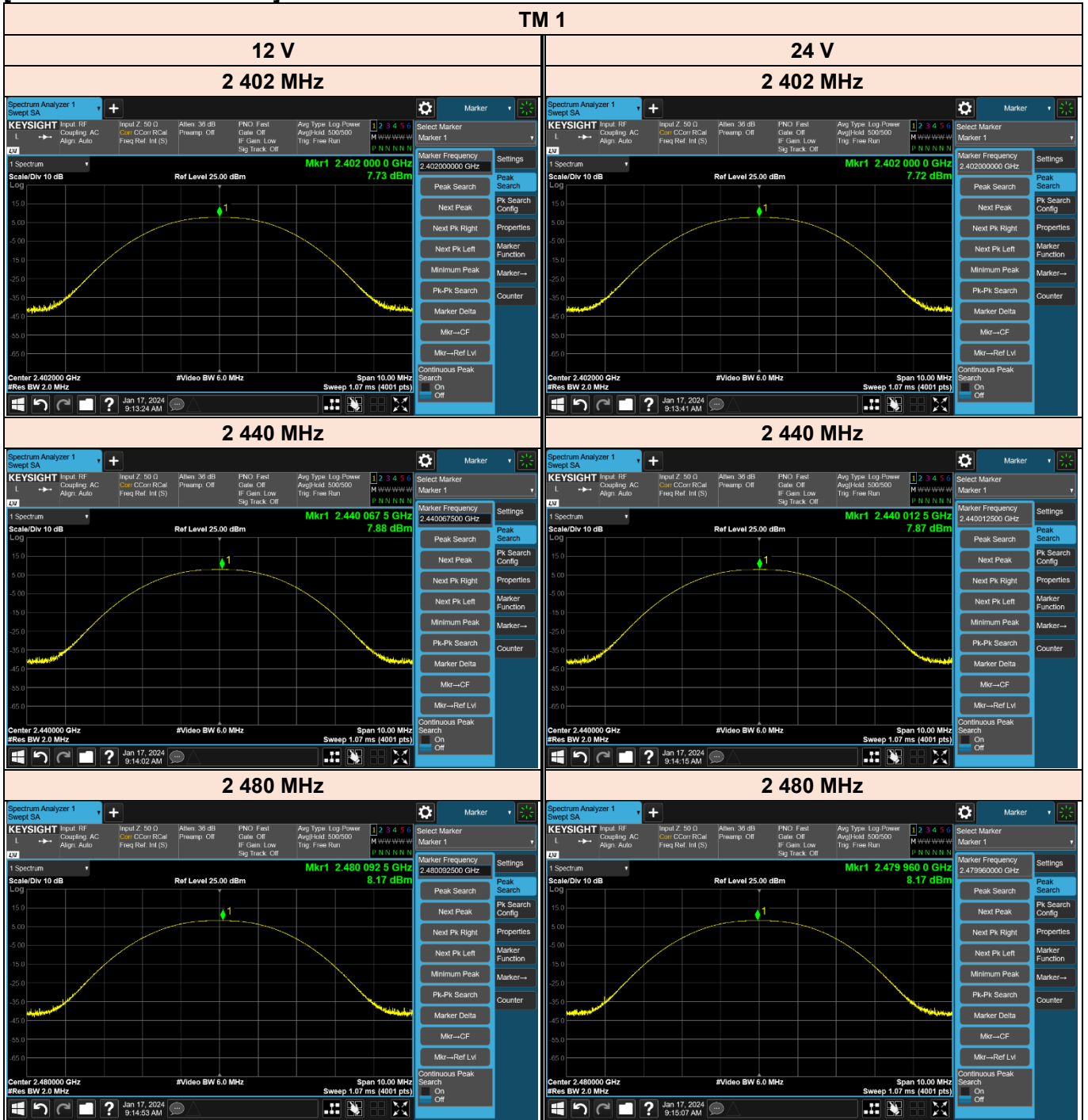

3.4 Power Spectral Density

3.4.1 Regulation

§15.247(e) : For digitally modulated systems, the power spectral density conducted from the intentional radiator to the antenna shall not be greater than 8 dBm in any 3 kHz band during any time interval of continuous transmission. This power spectral density shall be determined in accordance with the provisions of paragraph (b) of this section. The same method of determining the conducted output power shall be used to determine the power spectral density.

3.4.2 Test Procedure

The following procedure shall be used if maximum peak conducted output power was used to determine compliance, and it is optional if the maximum conducted (average) output power was used to determine compliance:

- a) Set analyzer center frequency to DTS channel center frequency.
- b) Set the span to 1.5 times the DTS bandwidth.
- c) Set the RBW to $3 \text{ kHz} \leq \text{RBW} \leq 100 \text{ kHz}$.
- d) Set the VBW $\geq [3 \times \text{RBW}]$.
- e) Detector = peak.
- f) Sweep time = auto couple.
- g) Trace mode = max hold.
- h) Allow trace to fully stabilize.
- i) Use the peak marker function to determine the maximum amplitude level within the RBW.
- j) If measured value exceeds requirement, then reduce RBW (but no less than 3 kHz) and repeat.

3.4.3 Test Setup

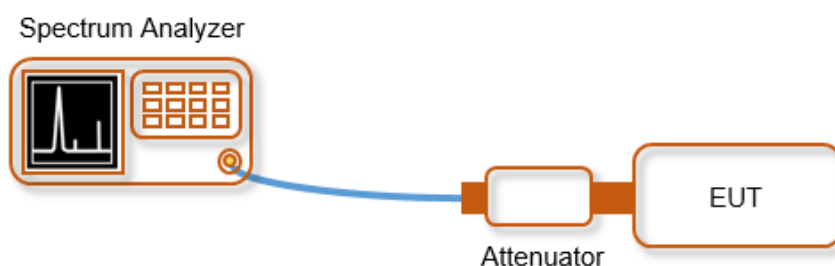

3.4.4 Test Result

[Test Data of Power Spectral Density]

Limit: not be greater than 8 dBm in any 3 kHz

Test Mode	Tested Frequency	Measured Power [dBm/3kHz]	
		12 V	24 V
TM 1	2 402	-7.130	-7.150
	2 440	-6.470	-6.470
	2 480	-7.460	-7.510



[Test Plot of Power Spectral Density]

TM 1

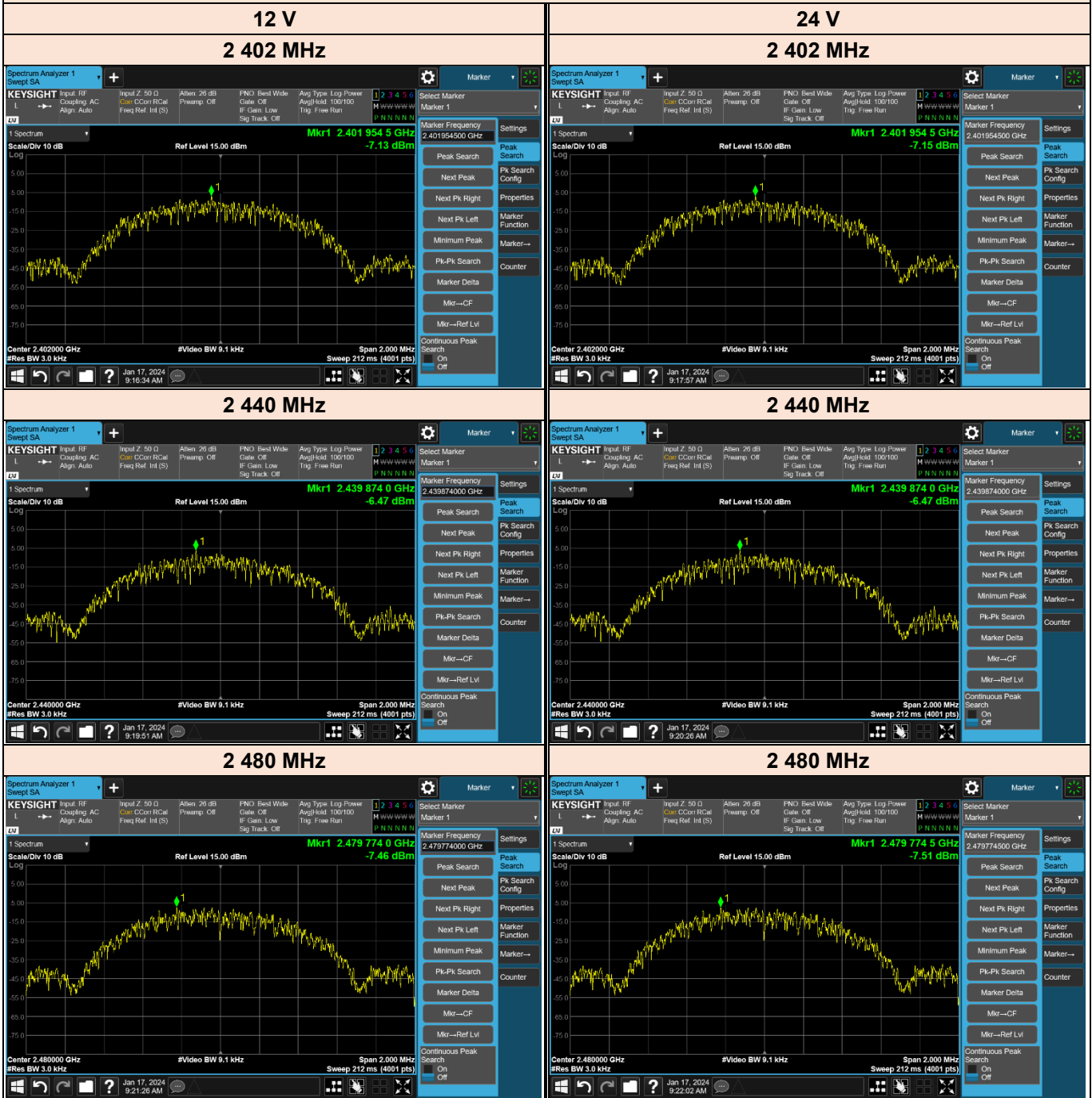

3.5 Spurious Emission, Band edge and Restricted Bands

3.5.1 Regulation

§15.247(d) : In any 100 kHz bandwidth outside the frequency band in which the spread spectrum or digitally modulated intentional radiator is operating, the radio frequency power that is produced by the intentional radiator shall be at least 20 dB below that in the 100 kHz bandwidth within the band that contains the highest level of the desired power, based on either an RF conducted or a radiated measurement, provided the transmitter demonstrates compliance with the peak conducted power limits. If the transmitter complies with the conducted power limits based on the use of RMS averaging over a time interval, as permitted under paragraph (b)(3) of this section, the attenuation required under this paragraph shall be 30 dB instead of 20 dB. Attenuation below the general limits specified in §15.209(a) is not required. In addition, radiated emissions which fall in the restricted bands, as defined in §15.205(a), must also comply with the radiated emission limits specified in §15.209(a) (see §15.205(c)).

§15.209(a) : Except as provided elsewhere in this subpart, the emissions from an intentional radiator shall not exceed the field strength levels specified in the following table:

Frequency (MHz)	Field strength (microvolts/meter)	Measurement distance (meters)
0.009-0.490	2400/F(kHz)	300
0.490-1.705	24000/F(kHz)	30
1.705-30.0	30	30
30-88	100**	3
88-216	150**	3
216-960	200**	3
Above 960	500	3

**Except as provided in paragraph (g), fundamental emissions from intentional radiators operating under this section shall not be located in the frequency bands 54-72 MHz, 76-88 MHz, 174-216 MHz or 470-806 MHz. However, operation within these frequency bands is permitted under other sections of this part, e.g., §§15.231 and 15.241.

§15.205(a) : Except as shown in paragraph (d) of this section, only spurious emissions are permitted in any of the frequency bands listed below:

MHz	MHz	MHz	GHz
0.090-0.110	16.42-16.423	399.9-410	4.5-5.15
¹ 0.495-0.505	16.69475-16.69525	608-614	5.35-5.46
2.1735-2.1905	16.80425-16.80475	960-1240	7.25-7.75
4.125-4.128	25.5-25.67	1300-1427	8.025-8.5
4.17725-4.17775	37.5-38.25	1435-1626.5	9.0-9.2
4.20725-4.20775	73-74.6	1645.5-1646.5	9.3-9.5
6.215-6.218	74.8-75.2	1660-1710	10.6-12.7
6.26775-6.26825	108-121.94	1718.8-1722.2	13.25-13.4
6.31175-6.31225	123-138	2200-2300	14.47-14.5
8.291-8.294	149.9-150.05	2310-2390	15.35-16.2
8.362-8.366	156.52475-156.52525	2483.5-2500	17.7-21.4
8.37625-8.38675	156.7-156.9	2690-2900	22.01-23.12
8.41425-8.41475	162.0125-167.17	3260-3267	23.6-24.0
12.29-12.293	167.72-173.2	3332-3339	31.2-31.8
12.51975-12.52025	240-285	3345.8-3358	36.43-36.5
12.57675-12.57725	322-335.4	3600-4400	(²)
13.36-13.41			

¹Until February 1, 1999, this restricted band shall be 0.490-0.510 MHz.

²Above 38.6

§15.205 (b) : Except as provided in paragraphs (d) and (e) of this section, the field strength of emissions appearing within these frequency bands shall not exceed the limits shown in §15.209. At frequencies equal to or less than 1000 MHz, compliance with the limits in §15.209 shall be demonstrated using measurement instrumentation employing a CISPR quasi-peak detector. Above 1000 MHz, compliance with the emission limits in §15.209 shall be demonstrated based on the average value of the measured emissions. The provisions in §15.35 apply to these measurements.

3.5.2 Test Procedure

Band-edge Compliance for RF Conducted Emissions

These procedures are applicable for determining compliance at authorized-band band-edges where the requirements are expressed as a value relative to the in-band signal level. Procedures for determining compliance with field strength limits at or close to the band-edges are given in 6.10.6 (see also Table A.2).

Band-edge tests are typically performed as a conducted test but may be performed as radiated measurements on a test site meeting the specifications in 5.2, at the measurement distances specified in 5.3. The instrumentation shall meet the requirements in 4.1.1 using the bandwidths and detectors specified in 4.1.4.2.

When performing radiated measurements, the measurement antenna(s) shall meet the specifications in 4.3. The EUT shall be connected to an antenna and operated at the highest power settings following procedures in 6.3.

For other than frequency-hopping devices, this test sequence shall be performed once. For devices that support frequency hopping, this test sequence shall be performed twice: once with the hopping function turned OFF and then repeated with the hopping function turned ON. The purpose of the test with the hopping function turned on is to confirm that the RF power remains OFF while the device is changing frequencies, and that the oscillator stabilizes at the new frequency before RF power is turned back ON. Overshoot of any oscillator, including phase-lock-loop stabilized oscillators, can cause the device to be temporarily tuned to frequencies outside the authorized band, and it is important that no transmissions occur during such temporary periods. Particular attention to the hopping sequence requirements specified below is needed in the case of adaptive frequency-hopping devices:

- a) Connect the EMI receiver or spectrum analyzer to the EUT using an appropriate RF cable connected to the EUT output. Configure the spectrum analyzer settings as described in step e) (be sure to enter all losses between the unlicensed wireless device output and the spectrum analyzer).
- b) Set the EUT to the lowest frequency channel (for the hopping on test, the hopping sequence shall include the lowest frequency channel).
- c) Set the EUT to operate at maximum output power and 100% duty cycle, or equivalent “normal mode of operation” as specified in 6.10.3.
- d) If using the radiated method, then use the applicable procedure(s) of 6.4, 6.5, or 6.6, and orient the EUT and measurement antenna positions to produce the highest emission level.
- e) Perform the test as follows:
 - 1) Span: Wide enough to capture the peak level of the emission operating on the channel closest to the band edge, as well as any modulation products that fall outside of the authorized band of operation.
 - 2) Reference level: As required to keep the signal from exceeding the maximum instrument input mixer level for linear operation. In general, the peak of the spectral envelope shall be more than $[10 \log (\text{OBW/RBW})]$ below the reference level. Specific guidance is given in 4.1.5.2.
 - 3) Attenuation: Auto (at least 10 dB preferred).
 - 4) Sweep time: Coupled.
 - 5) Resolution bandwidth: 100 kHz.
 - 6) Video bandwidth: 300 kHz.
 - 7) Detector: Peak.
 - 8) Trace: Max hold.
- f) Allow the trace to stabilize. For the test with the hopping function turned ON, this can take several minutes to achieve a reasonable probability of intercepting any emissions due to oscillator overshoot.
- g) Set the marker on the emission at the band edge, or on the highest modulation product outside of the band, if this level is greater than that at the band edge. Enable the marker-delta function, and then use the marker-to-peak function to move the marker to the peak of the in-band emission.
- h) Repeat step c) through step e) for every applicable modulation.
- i) Set the EUT to the highest frequency channel (for the hopping on test, the hopping sequence shall include the highest frequency channel) and repeat step c) through step d).
- j) The band-edge measurement shall be reported by providing plot(s) of the measuring instrument display; the plot axes and the scale units per division shall be clearly labeled. Tabular data may be reported in addition to the plot(s).

Spurious RF Conducted Emissions

Conducted spurious emissions shall be measured for the transmit frequency, per 5.5 and 5.6, and at the maximum transmit powers.

Connect the primary antenna port through an attenuator to the spectrum analyzer input; in the results, account for all losses between the unlicensed wireless device output and the spectrum analyzer. The instrument shall span 30 MHz to 10 times the operating frequency in GHz, with a resolution bandwidth of 100 kHz, video bandwidth of 300 kHz, and a coupled sweep time with a peak detector. The band 30 MHz to the highest frequency may be split into smaller spans, as long as the entire spectrum is covered.

Spurious Radiated Emissions

1. The preliminary radiated measurement were performed to determine the frequency producing the maximum emissions in an semi-anechoic chamber at a distance of 3 meters.
2. The EUT was placed on the top of the 0.8-meter height, 1 x 1.5 meter non-metallic table. To find the maximum emission levels, the height of a measuring antenna was changed and the turntable was rotated 360°.
3. The antenna polarization was also changed from vertical to horizontal. The spectrum was scanned from 9 kHz to 30 MHz using the loop antenna, and from 30 to 1000 MHz using the Bi-Log antenna, and from 1000 MHz to 26500 MHz using the horn antenna.
4. To obtain the final measurement data, the EUT was arranged on a turntable situated on a 4 x 4 meter in an semi-anechoic chamber. The EUT was tested at a distance 3 meters.
5. Each frequency found during preliminary measurements was re-examined and investigated. The test-receiver system was set up to average, peak, and quasi-peak detector fuction with specified bandwidth.
6. The 0.8 m height is for below 1 GHz testing, and 1.5 m is for above 1GHz testing.

- Procedure for unwanted emissions measurements below 1 000 MHz

The procedure for unwanted emissions measurements below 1 000 MHz is as follows:

- a) Follow the requirements in 12.7.4.
- b) Compliance shall be determined using CISPR quasi-peak detection; however, peak detection is permitted as an alternative to quasi-peak detection.

- Procedure for peak unwanted emissions measurements above 1 000 MHz

The procedure for peak unwanted emissions measurements above 1 000 MHz is as follows:

- a) Follow the requirements in 12.7.4.
- b) Peak emission levels are measured by setting the instrument as follows:
 - 1) RBW = 1 MHz.
 - 2) VBW \geq [3 \times RBW].
 - 3) Detector = peak.
 - 4) Sweep time = auto.
 - 5) Trace mode = max hold.
 - 6) Allow sweeps to continue until the trace stabilizes. Note that if the transmission is not continuous, then the time required for the trace to stabilize will increase by a factor of approximately 1 / D, where D is the duty cycle. For example, at 50 % duty cycle, the measurement time will increase by a factor of two, relative to measurement time for continuous transmission.

- Procedure for average unwanted emissions measurements above 1 000 MHz

Trace averaging with continuous EUT transmission at full power

If the EUT can be configured or modified to transmit continuously (D \geq 98%), then the average emission levels shall be measured using the following method (with EUT transmitting continuously):

- a) RBW = 1 MHz (unless otherwise specified).
- b) VBW \geq (3 \times RBW).
- c) Detector = RMS (power averaging), if [span / (# of points in sweep)] \leq (RBW / 2). Satisfying this condition may require increasing the number of points in the sweep or reducing the span. If this
- d) condition cannot be satisfied, then the detector mode shall be set to peak.
- e) Averaging type = power (i.e., rms):
 - 1) As an alternative, the detector and averaging type may be set for linear voltage averaging.
 - 2) Some instruments require linear display mode to use linear voltage averaging. Log or dB
- f) averaging shall not be used.
- g) Sweep time = auto.
- h) Perform a trace average of at least 100 traces.

Trace averaging across ON and OFF times of the EUT transmissions followed by duty cycle correction

If continuous transmission of the EUT ($D \geq 98\%$) cannot be achieved and the duty cycle is constant (duty cycle variations are less than $\pm 2\%$), then the following procedure shall be used:

- a) The EUT shall be configured to operate at the maximum achievable duty cycle.
- b) Measure the duty cycle D of the transmitter output signal as described in 2.4
- c) $RBW = 1 \text{ MHz}$ (unless otherwise specified).
- d) $VBW \geq [3 \times RBW]$.
- e) Detector = RMS (power averaging), if $[\text{span} / (\# \text{ of points in sweep})] \leq (RBW / 2)$. Satisfying this condition may require increasing the number of points in the sweep or reducing the span. If this condition cannot be satisfied, then the detector mode shall be set to peak.
- f) Averaging type = power (i.e., rms):
 - 1) As an alternative, the detector and averaging type may be set for linear voltage averaging.
 - 2) Some instruments require linear display mode to use linear voltage averaging. Log or dB averaging shall not be used.
- g) Sweep time = auto.
- h) Perform a trace average of at least 100 traces.
- i) A correction factor shall be added to the measurement results prior to comparing with the emission limit to compute the emission level that would have been measured had the test been performed at 100% duty cycle. The correction factor is computed as follows:
 - 3) If power averaging (rms) mode was used in step f), then the applicable correction factor is $[10 \log (1 / D)]$, where D is the duty cycle.
 - 4) If linear voltage averaging mode was used in step f), then the applicable correction factor is $[20 \log (1 / D)]$, where D is the duty cycle.
 - 5) If a specific emission is demonstrated to be continuous ($D \geq 98\%$) rather than turning ON and OFF with the transmit cycle, then no duty cycle correction is required for that emission.

- Sample Calculation

- Field Strength Level $[\text{dB}\mu\text{V}/\text{m}] = \text{S/A Reading Value} [\text{dB}\mu\text{V}] + \text{T.F} [\text{dB}/\text{m}] + \text{DCCF} [\text{dB}]$
- Total Factor $[\text{dB}/\text{m}] = \text{T.F} [\text{dB}/\text{m}] = \text{Antenna Factor} [\text{dB}/\text{m}] + \text{Cable Loss} [\text{dB}] + \text{Amplifier Gain} [\text{dB}]$
- Margin $[\text{dB}] = \text{Field Strength Level} [\text{dB}\mu\text{V}/\text{m}] - \text{Limit} [\text{dB}\mu\text{V}/\text{m}]$

3.5.3 Test Setup

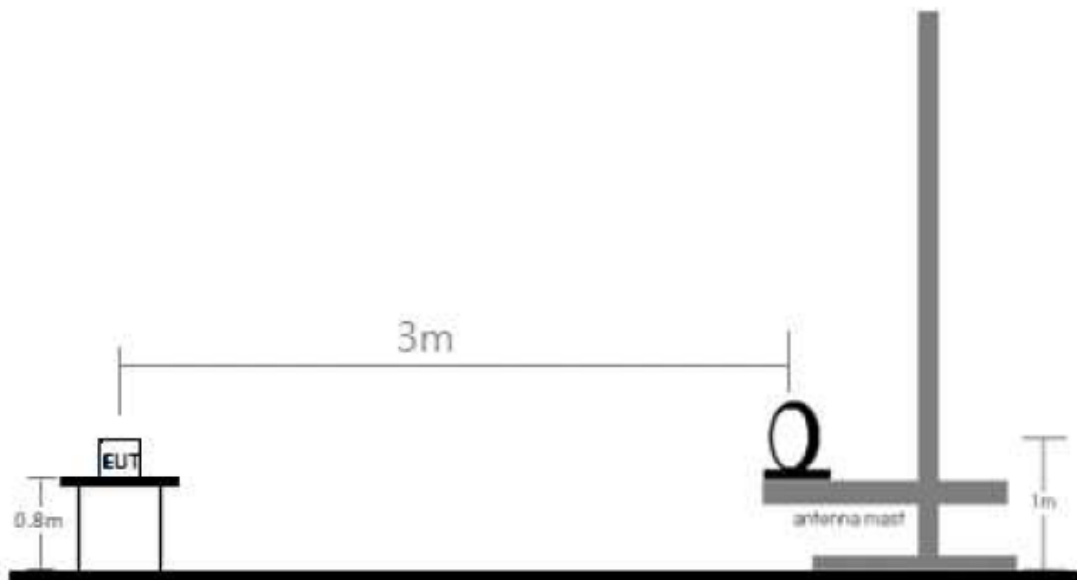

[Radiated Emission Test Setup Below 30 MHz]

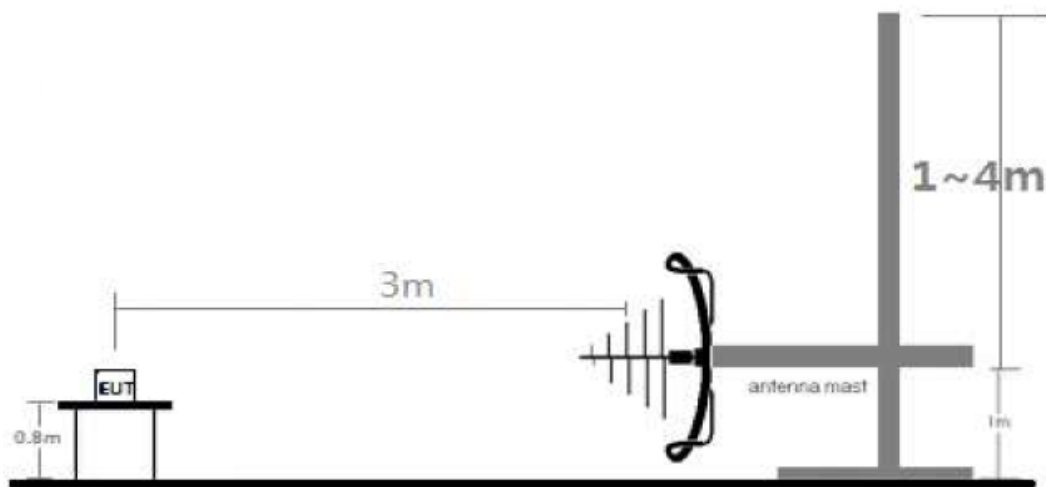

[Radiated Emission Test Setup Below 1 GHz]

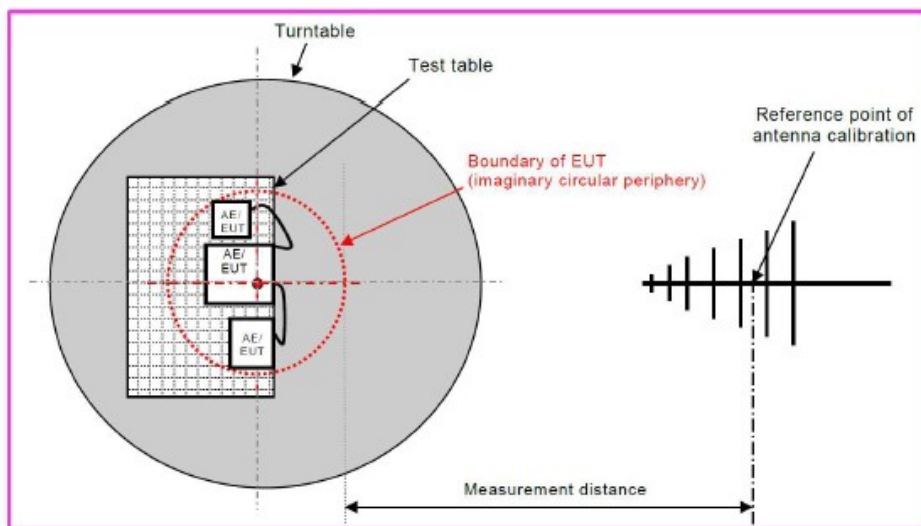
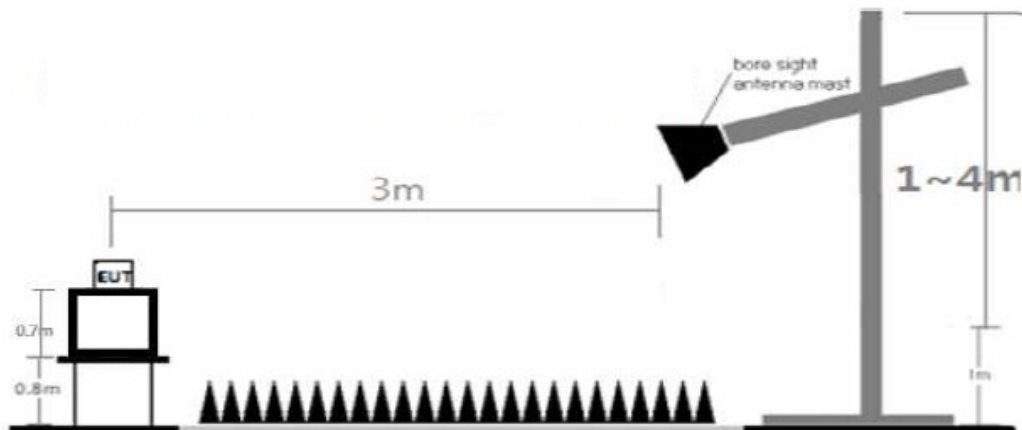

[Radiated Emission Test Setup Above 1 GHz]

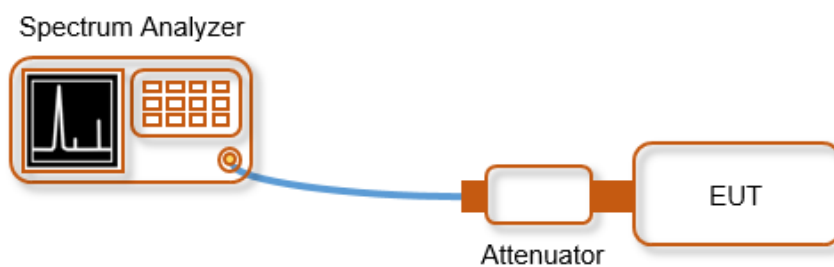

[Conducted Spurious Emission]

3.5.4 Test Result of Radiated Spurious Emission

Remarks

1. Field Strength (dB μ V/m) = S/A Reading Value(dB μ V) + Total Factor(dB/m) + DCCF(dB)
2. Total Factor(dB/m) = T.F (dB/m) = Antenna Factor(dB/m) + Cable Loss(dB) – Pre-Amplifier Gain(dB)
3. Margin(dB) = Field Strength (dB μ V/m) – Limit (dB μ V/m)
4. Measurement Distance = 3 m
5. DCCF = Duty Cycle Correction Factor.
6. No other spurious and harmonic emissions were found greater than listed emissions on above table
7. If the measured peak value satisfies the AVG LIMIT, the AVG value was not written.

3.5.4.1 Radiated Emissions (Below 1 GHz)

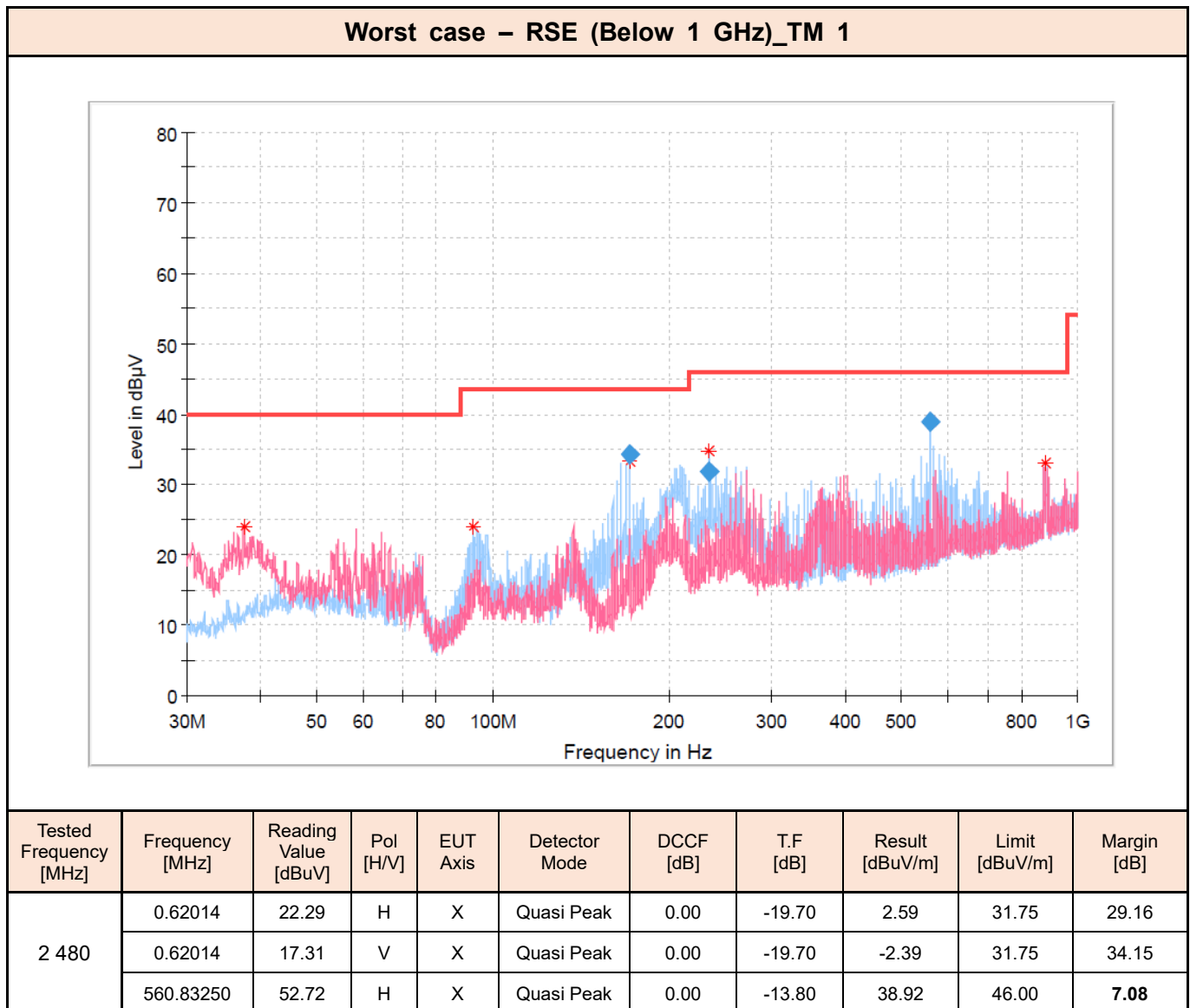



3.5.4.2 Radiated Emissions (Above 1 GHz)

TM 1_12 V

Tested Frequency [MHz]	Frequency [MHz]	Reading Value [dBuV]	Pol [H/V]	EUT Axis	Detector Mode	DCCF [dB]	T.F [dB]	Result [dBuV/m]	Limit [dBuV/m]	Margin [dB]
2 402	2 382.65	44.51	H	X	Peak	0.00	3.40	47.91	74.00	26.09
	2 387.05	32.75	H	X	Average	2.02	3.40	38.17	54.00	15.83
	2 664.75	46.31	H	X	Peak	0.00	5.00	51.31	74.00	22.69
	6 946.41	34.57	H	X	Average	2.02	7.20	43.79	54.00	10.21
2 440	14 878.59	37.83	H	X	Peak	0.00	19.80	57.63	74.00	16.37
	14 878.59	25.93	H	X	Average	2.02	19.80	47.75	54.00	6.25
2 480	2 485.26	45.00	H	X	Peak	0.00	3.90	48.90	74.00	25.10
	2 523.83	32.62	H	X	Average	2.02	4.30	38.94	54.00	15.06
	7 439.53	47.25	H	X	Peak	0.00	8.40	55.65	74.00	18.35
	7 439.53	38.92	H	X	Average	2.02	8.40	49.34	54.00	4.66

TM 1_24 V

Tested Frequency [MHz]	Frequency [MHz]	Reading Value [dBuV]	Pol [H/V]	EUT Axis	Detector Mode	DCCF [dB]	T.F [dB]	Result [dBuV/m]	Limit [dBuV/m]	Margin [dB]
2 402	2 364.49	45.22	H	X	Peak	0.00	3.30	48.52	74.00	25.48
	2 389.85	32.81	H	X	Average	1.98	3.40	38.19	54.00	15.81
	2 928.94	44.20	H	X	Peak	0.00	5.70	49.90	74.00	24.10
	6 946.41	34.57	H	X	Average	1.98	7.20	43.75	54.00	10.25
2 440	2 125.94	50.27	H	X	Peak	0.00	2.80	53.07	74.00	20.93
	7 319.06	33.21	H	X	Average	1.98	8.00	43.19	54.00	10.81
2 480	2 520.08	44.84	H	X	Peak	0.00	4.30	49.14	74.00	24.86
	2 520.08	32.58	H	X	Average	1.98	4.30	38.86	54.00	15.14
	7 439.53	46.45	H	X	Peak	0.00	8.40	54.85	74.00	19.15
	7 439.53	38.18	H	X	Average	1.98	8.40	48.56	54.00	5.44



TM 1

12 V

24 V

Bandedge_2 402 MHz_Worst case

Bandedge_2 402 MHz_Worst case

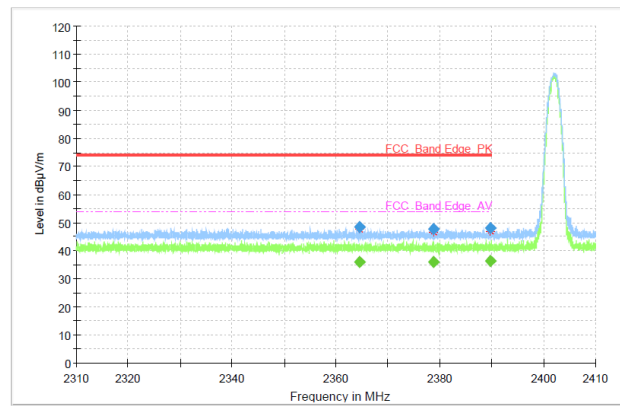
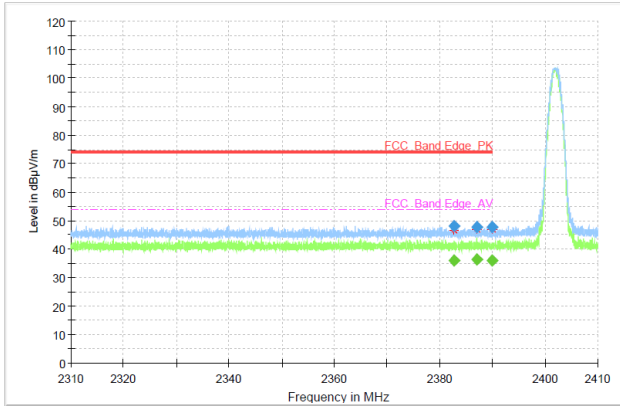

Bandedge_2 480 MHz_Worst case

Bandedge_2 480 MHz_Worst case

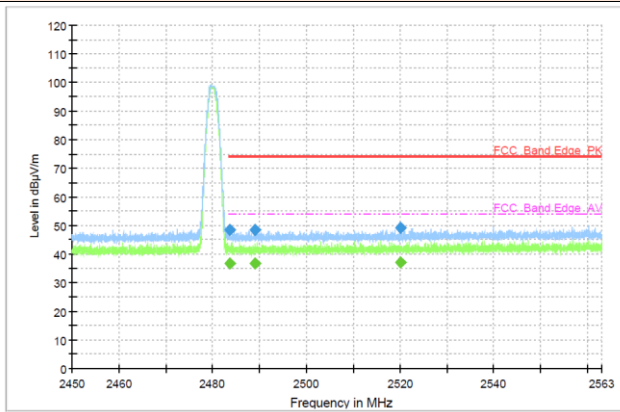
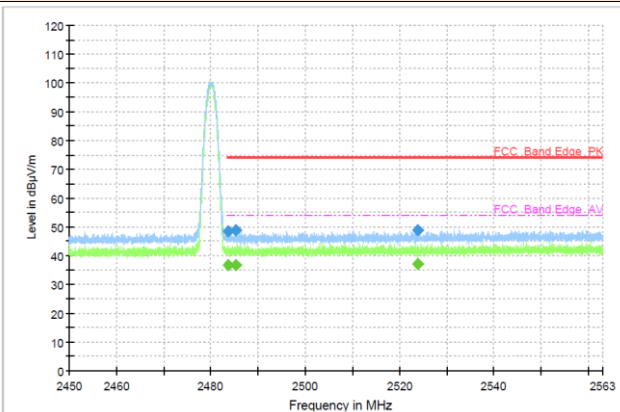

Spurious_Worst case

Spurious_Worst case

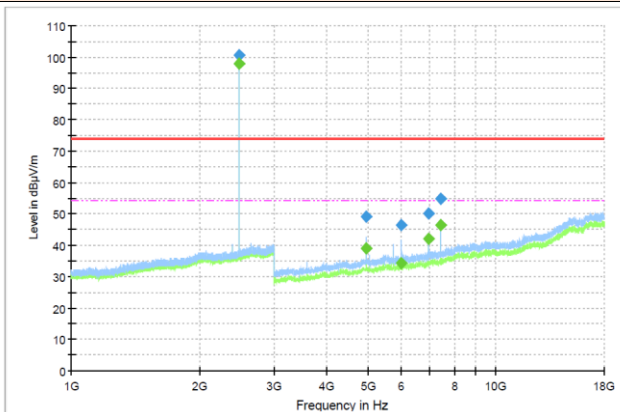
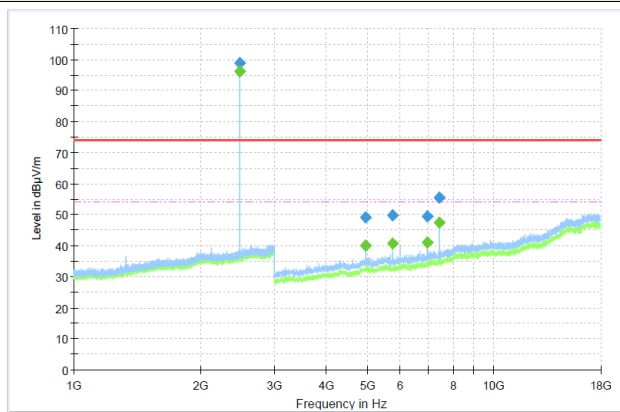



3.5.5 Test Result of Conducted Spurious Emission

Remarks

Frequency range: 1 GHz ~26.5 GHz

RBW = 1 MHz, VBW = 3 MHz, SWEEP TIME = AUTO, DETECTOR = PEAK, TRACE = MAX HOLD, SWEEP POINT : 100001

LIMIT LINE = 20 dB below of the reference level. (RBW = 100 kHz, VBW = 300 kHz)

If the emission level with above setting was close to the limit (ie, less than 3 dB margin) then zoom scan is required using RBW = 100 kHz, VBW = 300 kHz, SPAN = 100 MHz and BINS = 2001 to get accurate emission level within 100 kHz BW.

[12 V Spurious Emission]

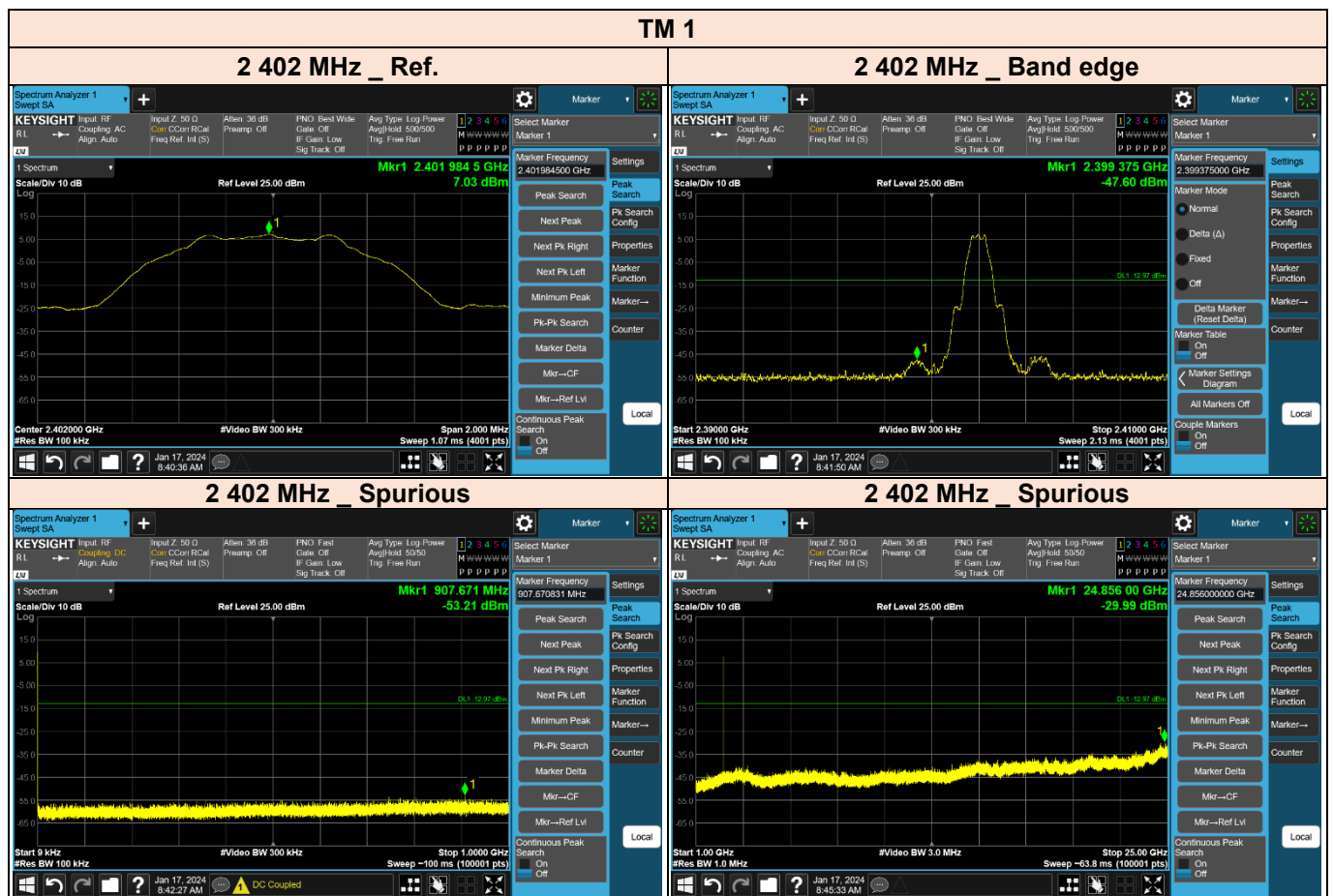



BUREAU VERITAS

TM 1

2 440 MHz _ Ref.

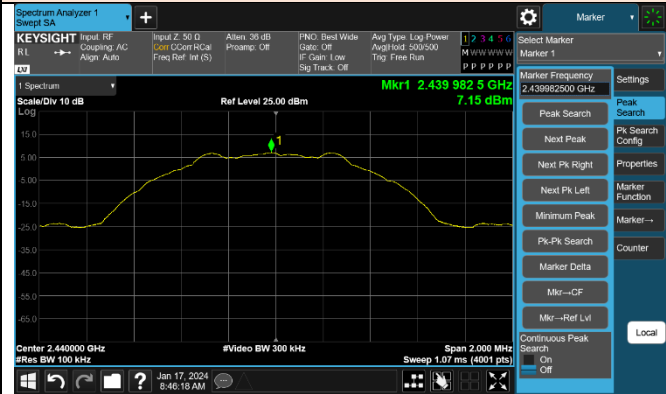

2 440 MHz _ Spurious

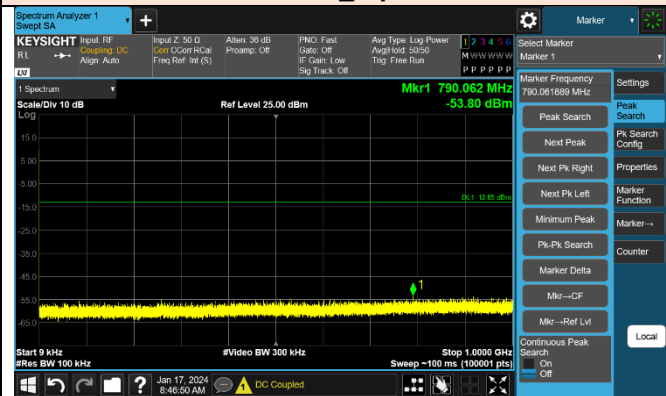

2 440 MHz _ Spurious



2 480 MHz _ Ref

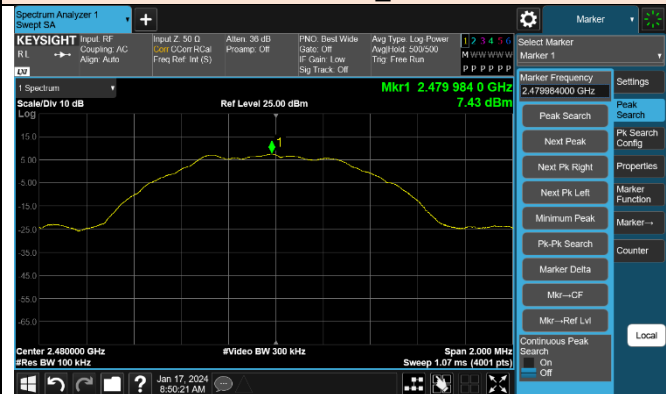

2 480 MHz _ Band edge

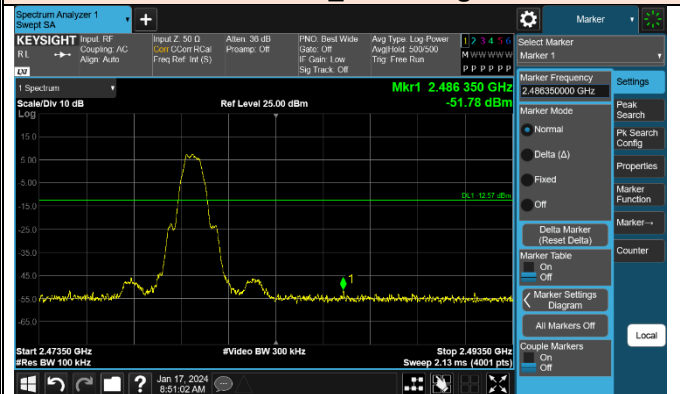

2 480 MHz _ Spurious

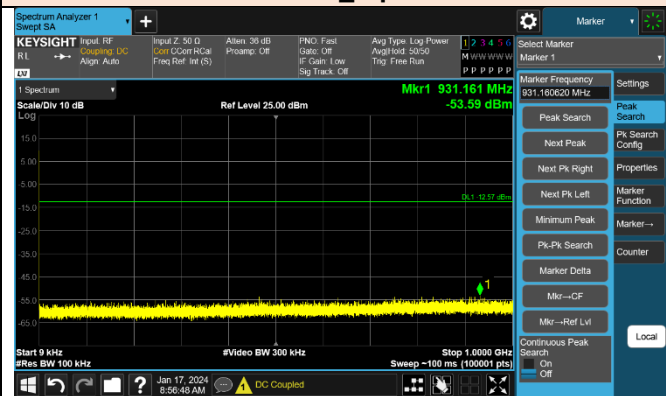

2 480 MHz _ Spurious

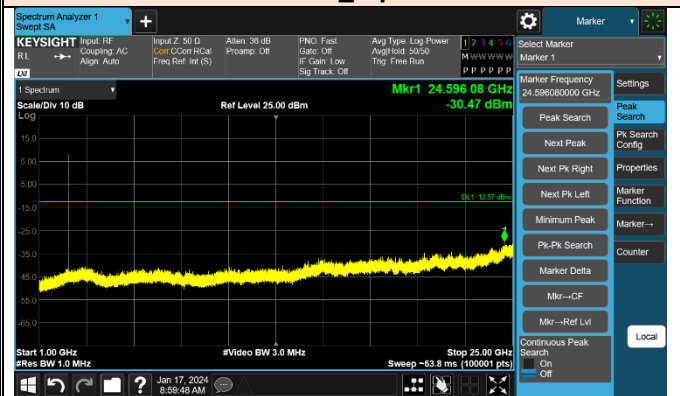



BUREAU VERITAS

[24 V Spurious Emission]

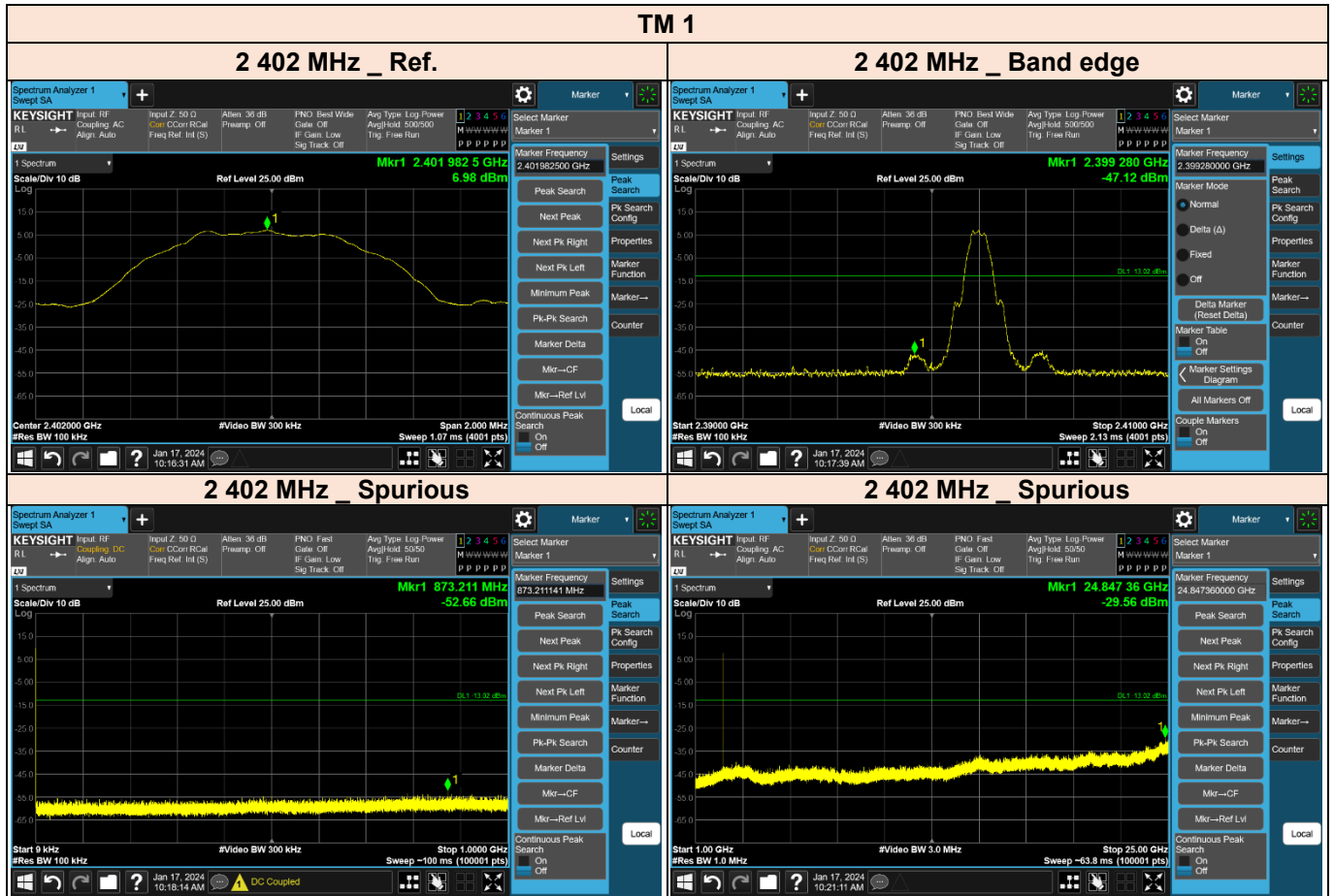



BUREAU VERITAS

TM 1

2 440 MHz _ Ref.

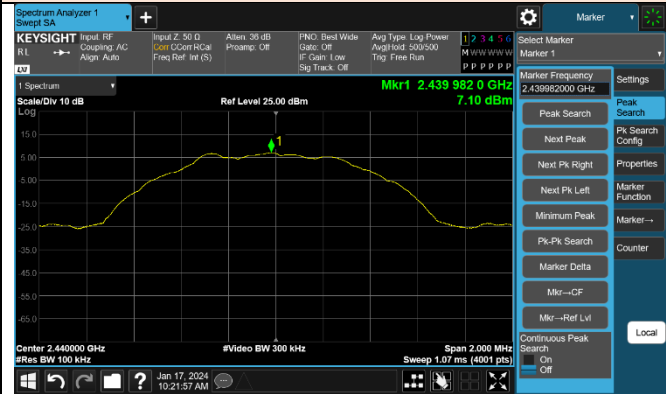

2 440 MHz _ Spurious

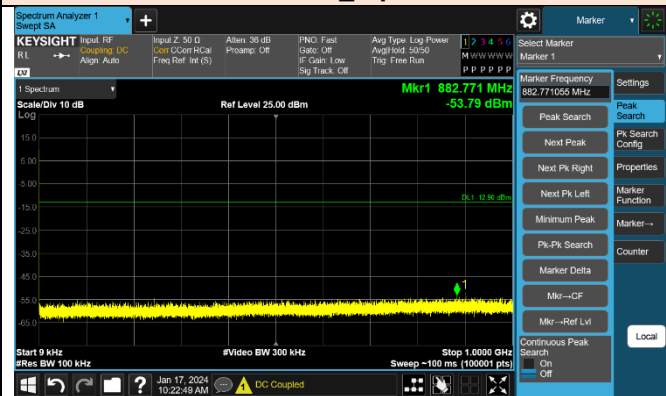

2 440 MHz _ Spurious



2 480 MHz _ Ref

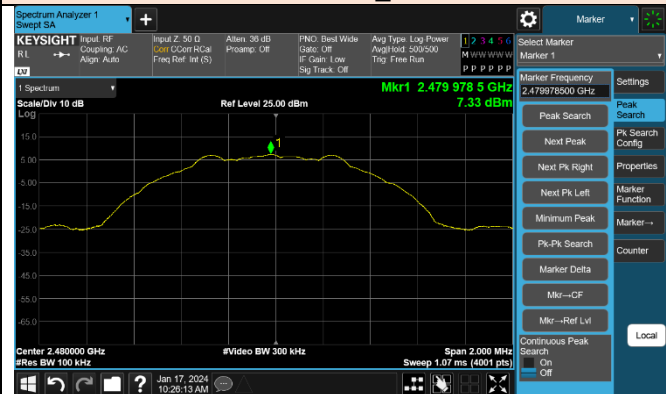

2 480 MHz _ Band edge

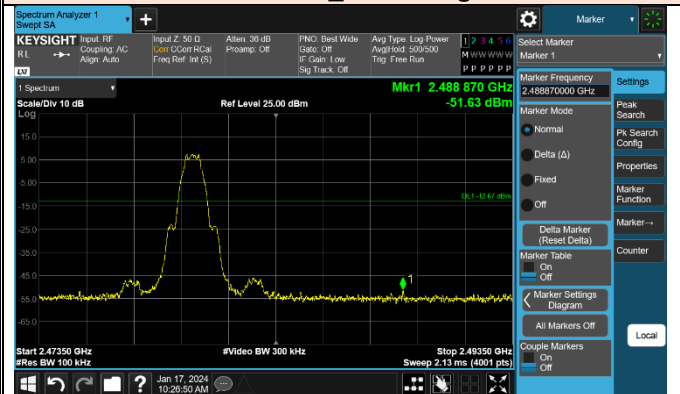

2 480 MHz _ Spurious

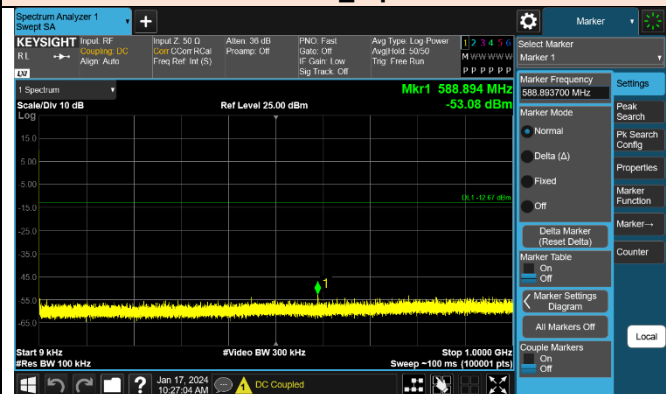

2 480 MHz _ Spurious

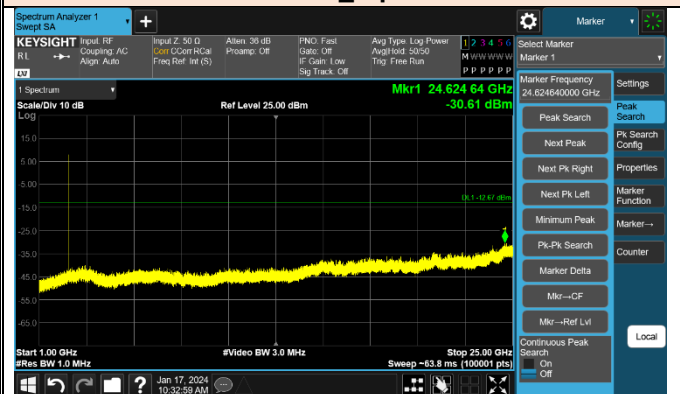

3.6 AC Conducted Emissions (150 kHz to 30 MHz)

3.6.1 Regulation

§15.207(a) : Except as shown in paragraphs (b) and (c) of this section, for an intentional radiator that is designed to be connected to the public utility (AC) power line, the radio frequency voltage that is conducted back onto the AC power line on any frequency or frequencies, within the band 150 kHz to 30 MHz, shall not exceed the limits in the following table, as measured using a 50 μ H/50 ohms line impedance stabilization network (LISN). Compliance with the provisions of this paragraph shall be based on the measurement of the radio frequency voltage between each power line and ground at the power terminal. The lower limit applies at the boundary between the frequency ranges.

Frequency of emission (MHz)	Conducted limit (dB μ V)	
	Quasi-peak	Average
0.15-0.5	66 to 56*	56 to 46*
0.5-5	56	46
5-30	60	50

* Decreases with the logarithm of the frequency.

3.6.2 Test Procedure

- The EUT was placed 0.4 meters from the conducting wall of the shielded room with EUT being connected to the power mains through a line impedance stabilization network (LISN). Other support units were connected to the power mains through another LISN. The two LISNs provide 50 ohm / 50 μ H of coupling impedance for the measuring instrument.
- Both lines of the power mains connected to the EUT were checked for maximum conducted interference.
- The frequency range from 150 kHz to 30 MHz was searched. Emission levels under (Limit – 20 dB) was not recorded.

Remark : The resolution bandwidth and video bandwidth of test receiver is 9 kHz for quasi-peak detection (QP) and average detection (AV) at frequency 0.15 MHz – 30 MHz.

3.6.3 Test Setup

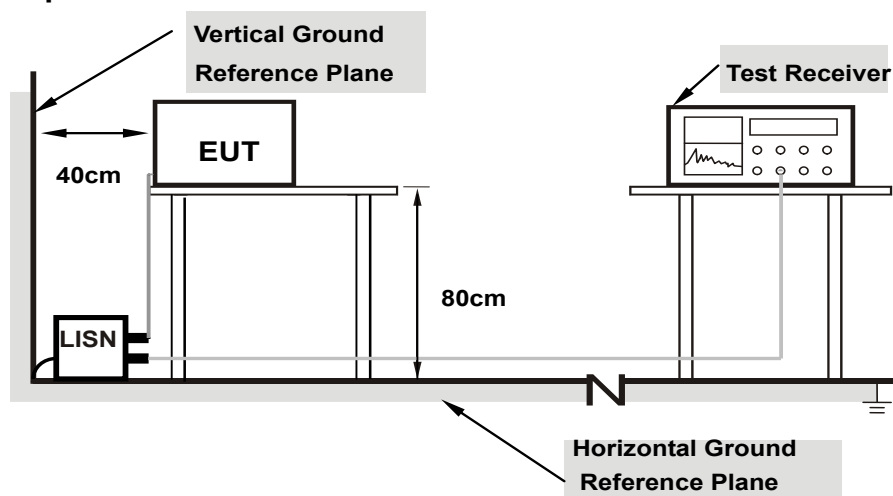

3.6.4 Test Result

- N/A

3.7 Duty Cycle

3.7.1 Test Procedure

- a) The zero-span mode on a spectrum analyzer or EMI receiver if the response time and spacing between bins on the sweep are sufficient to permit accurate measurements of the on and off times of the transmitted signal.
- b) Set the center frequency of the instrument to the center frequency of the transmission. Set $RBW \geq OBW$ if possible; otherwise, set RBW to the largest available value. Set $VBW \geq RBW$. Set detector = peak or average.
- c) The zero-span measurement method shall not be used unless both RBW and VBW are $> 50/T$ and the number of sweep points across duration T exceeds 100. (For example, if VBW and/or RBW are limited to 3 MHz, then the zero-span method of measuring duty cycle shall not be used if $T \leq 16.7$ microseconds.)

3.7.2 Test Setup

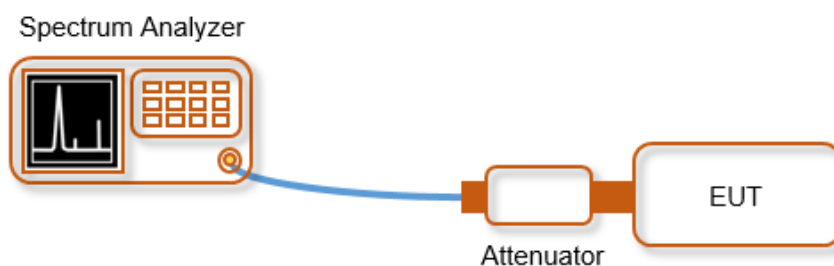



3.7.3 Test Result

Test Mode	12 V				
	On Time [ms]	Period [ms]	Duty Cycle [X]	Duty Cycle [D]	DCCF [dB]
TM 1	0.394	0.6263	0.628	62.83	2.02

Test Mode	24 V				
	On Time [ms]	Period [ms]	Duty Cycle [X]	Duty Cycle [D]	DCCF [dB]
TM 1	0.396	0.6248	0.634	63.38	1.98

[Test Plot of Duty Cycle]

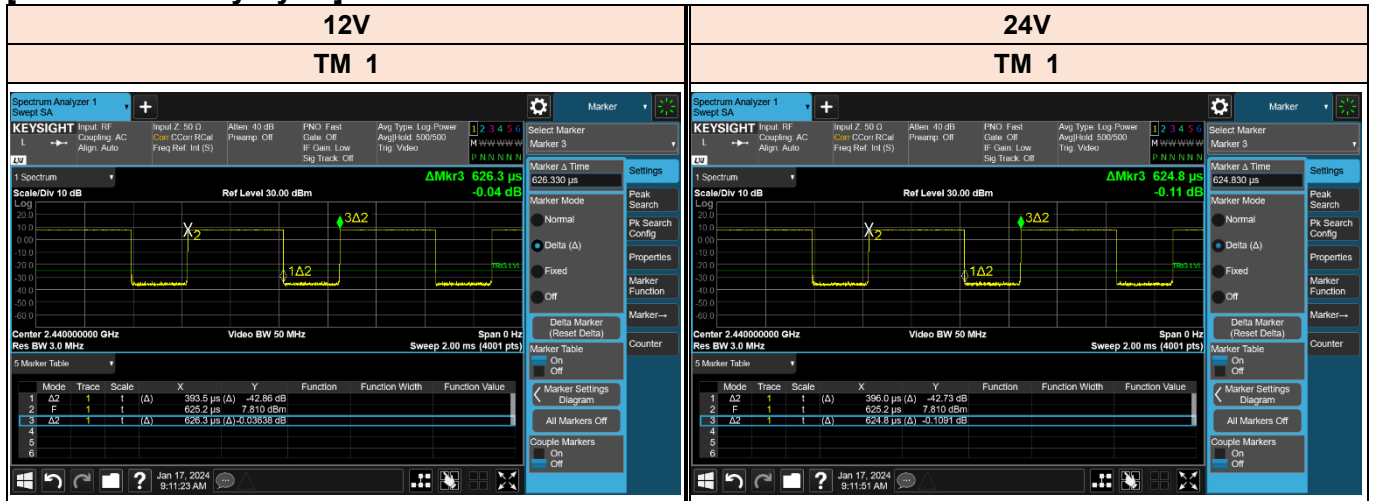



Appendix – Information of the Testing Laboratories

We, Bureau Veritas Consumer Products Services Korea. Our laboratories are FCC recognized accredited test firms and accredited and approved according to ISO/IEC 17025.

Test Firm Name : BV CPS ADT Korea Ltd.

Address : Innoplex No.2 106, Sinwon-ro 306, Yeongtong-gu, Suwon-si, Gyeonggi-do, 16675 KOREA

FCC

Designation Number : KR0158

Test Firm Registration Number : 666061

ISED

Designation Number : KR0158

Test Firm Registration Number : 25944

If you have any comments, please feel free to contact us at the following:

Email: Meyer.Shin@bureauveritas.com

Web Site: www.bureauveritas.co.kr/cps/eaw

The address and road map of all our labs can be found in our web site also.

- End of report -