

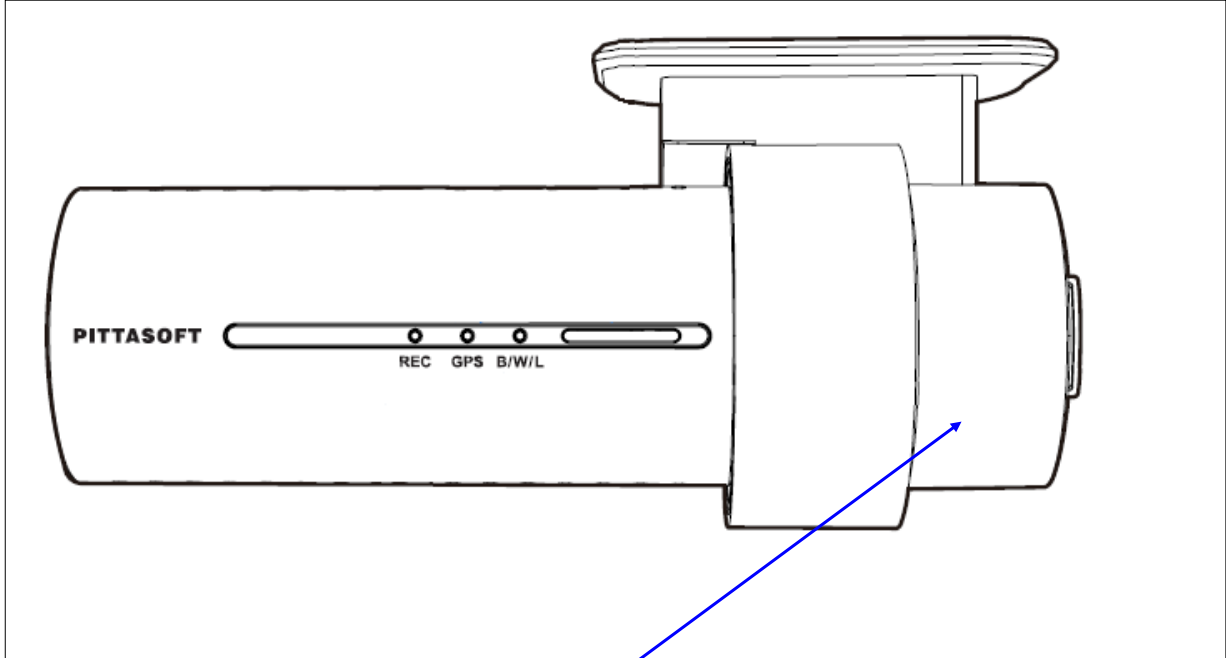





# Label Information

## 1. Label Location



Label Position

     **BLACKVUE**  
Made in Korea  
· Input: 12-24V  $\overline{=}$  1A  
FCC ID : YCK-DR970XP      Model : DR970X Plus      · S/N:  
HVIN : DR970X Plus  
IC : 23402-DR970XP

45mm X 12mm

# Product S/N Label\_ DR970X-1CH Plus

1. 2023.12.18



45mm X 12mm

# Product S/N Label\_DR970X-2CH DMS Plus

1. 2023.12.21

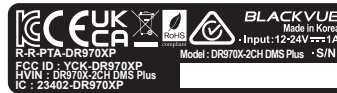

45mm X 12mm

# Product S/N Label\_ DR970X-2CH IR Plus

1. 2023.12.18



45mm X 12mm

# Product S/N Label\_ DR970X-2CH Plus

1. 2023.12.18



45mm X 12mm

# Product S/N Label\_DR970X-2CH Truck Plus

1. 2023.12.21

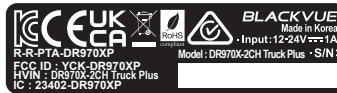

45mm X 12mm