



BLACKVUE™

DR770X Box Series Quick Start Guide



ENGLISH/РУССКИЙ

www.blackvue.com



Detailed Manual

BLACKVUE

DR770X Box Series

For manuals, customer support and FAQs go to www.blackvue.com

Руководства, служба технической поддержки и часто задаваемые вопросы представлены на сайте www.blackvue.com

Important safety information

For user safety and to avoid property damage, read through this manual and follow these safety instructions to use the product correctly.

- Do not disassemble, repair, or modify the product yourself.
Doing so may cause fire, electric shock, or malfunction. For internal inspection and repair, contact the service center.
- Do not adjust the product while driving.
Doing so may cause an accident. Stop or park your car in a safe place before installing and setting up the product.
- Do not operate the product with wet hands.
Doing so may cause electric shock.
- If any foreign matter gets inside the product, detach the power cord immediately.
Contact the service center for repair.
- Do not cover the product with any material.
Doing so may cause external deformation of the product or fire. Use the product and peripherals in a well-ventilated location.
- If the product is used outside the optimal temperature range, performance can decline or malfunctions may occur.
- When entering or exiting a tunnel, when directly facing into bright sunlight, or when recording at night without lighting the quality of recorded video may deteriorate.
- If the product is damaged or the power supply is cut due to an accident, video may not be recorded.
- Do not remove the microSD card while the microSD card is saving or reading data.
The data can be damaged or malfunctions may occur.
- It is desirable that the device be installed and operated with a distance of at least 20cm or more between the radiator and a person's body (excluding extremities: hand, wrists, feet, and ankles)

FCC Compliance Information

This equipment has been tested and found to comply with the limits for a Class B digital device, pursuant to Part 15 of the FCC Rules. These limits are designed to provide reasonable protections against harmful interference in a residential installation.

This equipment generates, uses and can radiate radio frequency energy and, if not installed and used in accordance with the instructions, may cause harmful interference to radio communications. However, there is no guarantee that interference will not occur in a particular installation.

If this equipment does cause harmful interference to radio or television reception which can be determined by turning the equipment off and on, the user is encouraged to try to correct the interference by one or more of the following measures.

- Reorient or relocate the receiving antenna.
- Increase the separation between the equipment and receiver.
- Connect the equipment into an outlet on a circuit different from that to which the receiver is connected.
- Consult the dealer or an experienced radio, TV technician for help.
- Only shielded interface cable should be used.

Finally, any changes or modifications to the equipment by the user not expressly approved by the grantee or manufacturer could void the user's authority to operate such equipment.

This device complies with Part 15 of the FCC Rules. Operation is subject to the following two conditions:

- (1) This device may not cause harmful interference, and
- (2) This device must accept any interference received, including interference that may cause undesired operation of this device.

FCC ID: YCK-DR770XBOX

FCC ID: YCK-EB1

CAUTION

Any changed or modifications in construction of this device which are not expressly approved by the party responsible for compliance could void the user's authority to operate the equipment.

There is a risk of explosion if the battery is replaced by an incorrect type.
Dispose of used batteries according to the instructions.

Do not ingest battery, as it could cause chemical burns.

This product contains a coin / button cell battery. If the coin / button cell battery is swallowed, it can cause severe internal burns in just 2 hours and can lead to death.

Keep new and used batteries away from children.

If the battery compartment does not close securely, stop using the product and keep it away from children. If you think batteries might have been swallowed or placed inside any part of the body, seek immediate medical attention.

Do not dispose of the battery into fire or a hot oven, or mechanically crush or cut the battery, it can result in an explosion.

Leaving a battery in an extremely high temperature environment can result in an explosion or the leakage of flammable liquid or gas.

A battery subjected to extremely low air pressure may result in an explosion or the leakage of flammable liquid or gas.

CE WARNING

- Changes and modifications not expressly approved by the party responsible for compliance could void the user's authority to operate the equipment.
- It is desirable that it be installed and operated with at least 20cm or more between the radiator and a person's body (excluding extremities: hand, wrists, feet, and ankles).

IC Compliance

This Class [B] digital apparatus complies with Canadian ICES-003.

This radio transmitter has been approved by Industry Canada to operate with the antenna types listed below with the maximum permissible gain and required antenna impedance for each antenna type indicated. Antenna types not included in this list, having a gain greater than the maximum gain indicated for that type, are strictly prohibited for use with this device.

- IC Warning

This device complies with Industry Canada licence-exempt RSS standard(s).

Operation is subject to the following two conditions:

- (1) this device may not cause interference, and
- (2) this device must accept any interference, including interference that may cause undesired operation of the device.

Le présent appareil est conforme aux CNR d'Industrie Canada applicables aux appareils radio exempts de licence.

L'exploitation est autorisée aux deux conditions suivantes:

- (1) l'appareil ne doit pas produire de brouillage, et
- (2) l'utilisateur de l'appareil doit accepter tout brouillage radioélectrique subi, même si le brouillage est susceptible d'en compromettre le fonctionnement.

Disposal of your BlackVue dashcam











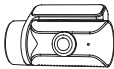
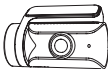





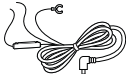

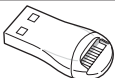
1. All electrical and electronic products should be disposed of separately from the municipal waste stream via designated collection facilities appointed by the government or the local authorities. Contact local authorities to learn about disposal and recycling options available in your area.
2. The correct disposal of your BlackVue dashcam will help prevent potential negative consequences for the environment and human health.
3. For more detailed information about disposal of your BlackVue dashcam, please contact your city office, waste disposal service or the shop where you purchased the product.

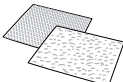
► In the box

Check the box for each of the following items before installing the BlackVue dashcam.

DR770X Box (Front + Rear + IR)











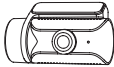

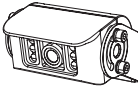

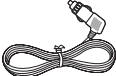

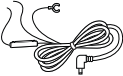
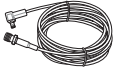
	Main unit		Front camera
	Rear camera		Rear Infrared camera
	SOS button		External GPS
	Main unit Cigarette Lighter power cable (3p)		Camera connection cable (3EA)
	Main unit Hardwiring power cable (3p)		microSD card
	microSD card reader		Quick start guide
	Velcro strip		Pry tool
	Main unit key		Allen wrench
	Double-sided tape for the Mounting Brackets		Spare screws for tamperproof cover (3EA)

Need help?

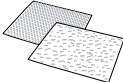
Download the manual (including FAQs) and the latest firmware from www.blackvue.com

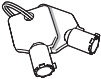
Or contact a Customer Support expert at cs@pittasoft.com

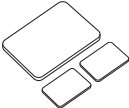
DR770X Box Truck (Front + IR + ERC1 (Truck))

	Main unit		Front camera
	Rear Infrared camera		Rear Truck IR camera
	SOS button		External GPS
	Main unit Cigarette Lighter power cable (3p)		Camera connection cable (2EA)
	Main unit hardwiring power cable (3p)		Rear camera connection cable (15m long waterproof)
	Truck camera screws for the mounting brackets (3eA)		microSD card
	microSD card reader		Quick start guide
	Velcro strip		Pry tool
	Main unit key		Allen wrench
	Double-sided tape for the Mounting Brackets		Spare screws for tamperproof cover (2EA)

Need help?

Download the manual (including FAQs) and the latest firmware from www.blackvue.com

Or contact a Customer Support expert at cs@pittasoft.com

At a glance

The following diagrams explain each part of the DR770X Box.

Main box

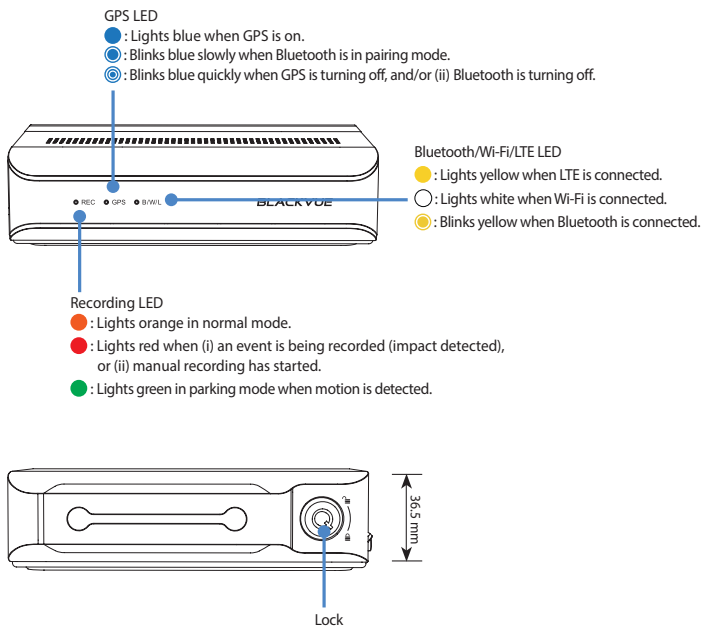

SOS button

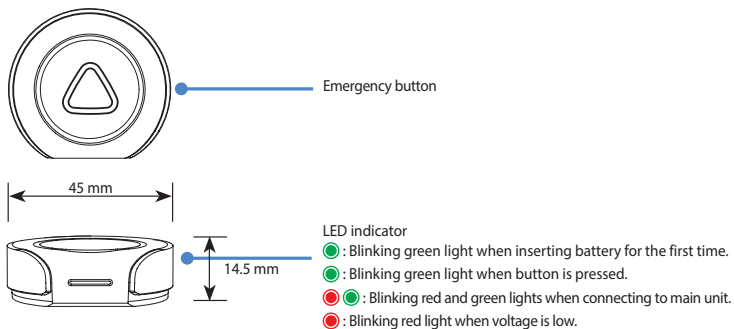

□ Front camera

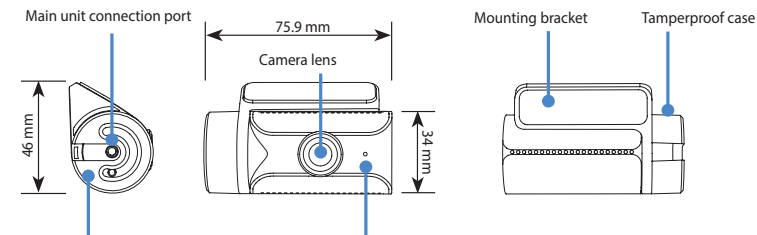

Rotate the screw on tamper proof cover counterclockwise and detach the cover from camera to connect the cable.

Front security LED

- : Lights on during (i) normal mode, (ii) an event is being recorded (impact detected), (iii) manual recording has started, or (iv) motion is detected in parking mode.
- : Blinks slowly during parking mode motion detection standby.

□ Rear camera

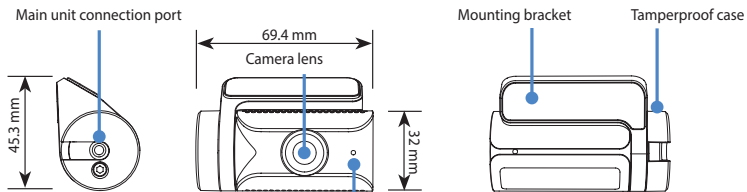

Front security LED

- : Lights on during (i) normal mode, (ii) an event is being recorded (impact detected), (iii) manual recording has started, or (iv) motion is detected in parking mode.

□ Rear Infrared camera

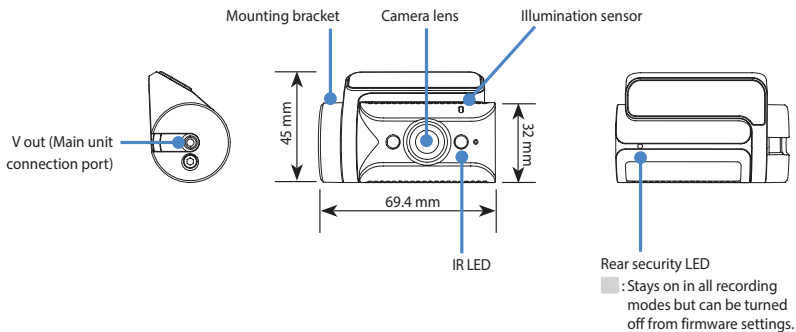

□ Rear truck camera

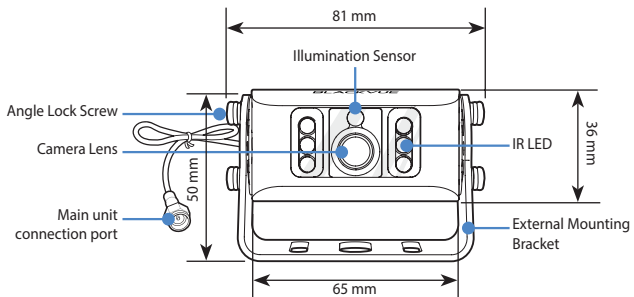

➤ Main box and SOS Button Installation

Install the main unit (box) on the side of center console or inside the glove box. For the heavy duty vehicles, the box can also be installed on the luggage shelf.

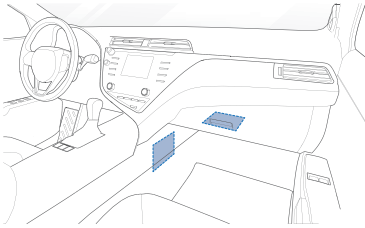

For Sedans

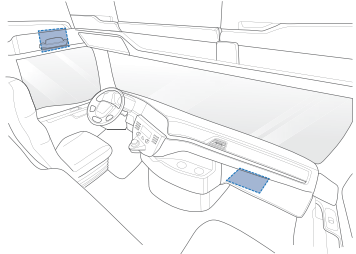

For Heavy Vehicles

Insert the key in the box, rotate it counterclockwise and open the lock on the main unit. Take out the lock case and insert the micro SD card.

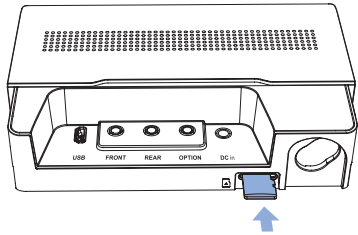
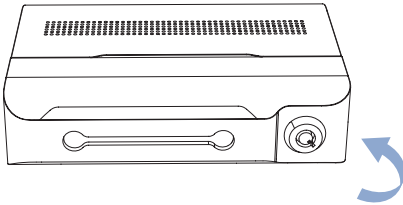

⚠ Warning

- The front camera cable must be connected to the respective port. Connecting it to rear camera port will give a warning beep sound.

Insert the cables into the cable cover and connect them to their respective ports. Fix the cover on the main unit and lock it.

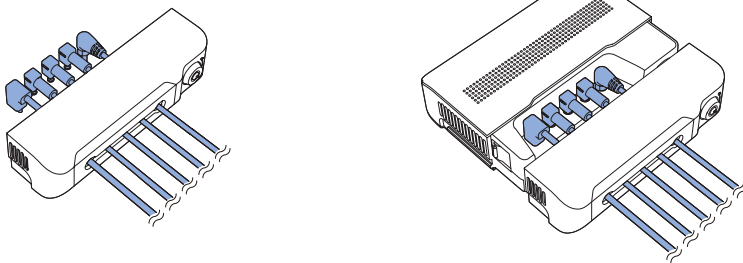

SOS button can be installed where it's in your arm's reach and can be easily **accessed**.

□ Changing SOS Button Battery

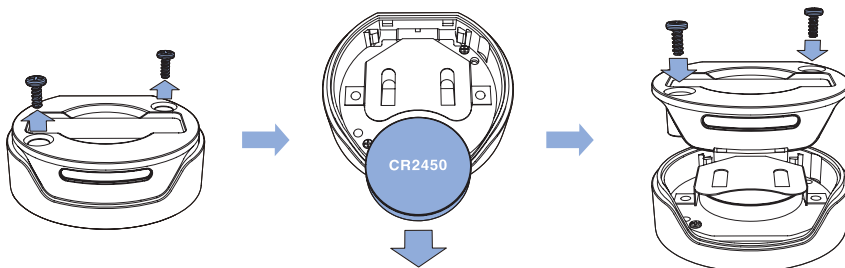

STEP1. Unscrew the back panel of the SOS Button

STEP 2. Remove the battery and replace it with a new CR2450 type coin battery.

STEP 3 Close and re-screw the back panel of the SOS button.

➤ Front camera installation

Install the front camera behind the rear view mirror. Remove any foreign matter and clean and dry the windshield before installation.

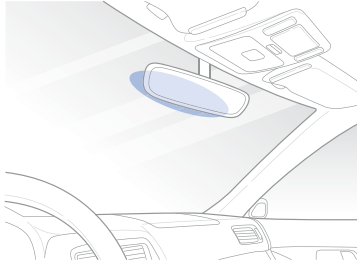

- A** Detach the tamperproof bracket from the front camera by rotating the screw counterclockwise with the allen wrench.

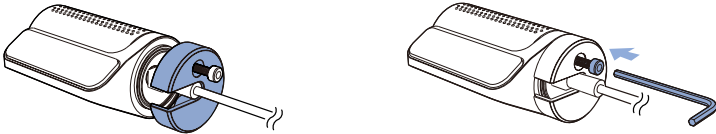

- B** Connect the front camera ('Rear' port) and the main unit ('Front') using the rear camera connection cable.

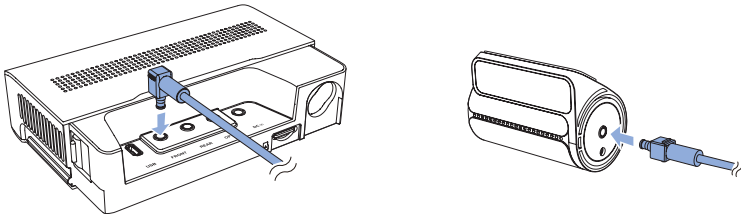

Note

- Please make sure that the front camera cable is connected to the "Front" port in the main unit.

- C Align the tamperproof bracket with the mount bracket. Use the Allen wrench to tighten the screw. Do not fully tighten the screw as this could be done after attaching the camera to the front windshield.



- D Peel off the protective film from the double-sided tape and attach the front camera to the windshield behind the rear-view mirror.



- E Adjust the angle of the lens by rotating the body of the front camera. We recommend pointing the lens slightly downwards ($\approx 10^\circ$ below horizontal), so as to record video with a 6:4 road to background ratio. Tighten the screw fully.

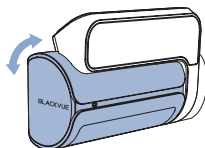

- F Use the pry tool to lift the edges of the rubber window sealing and/or molding and tuck in the front camera connection cable.

