

7.4.2. Conducted Spurious Emissions  
 - Tested Power Supply: 12 V

Low Band-edge

***Lowest Channel & Modulation : GFSK***

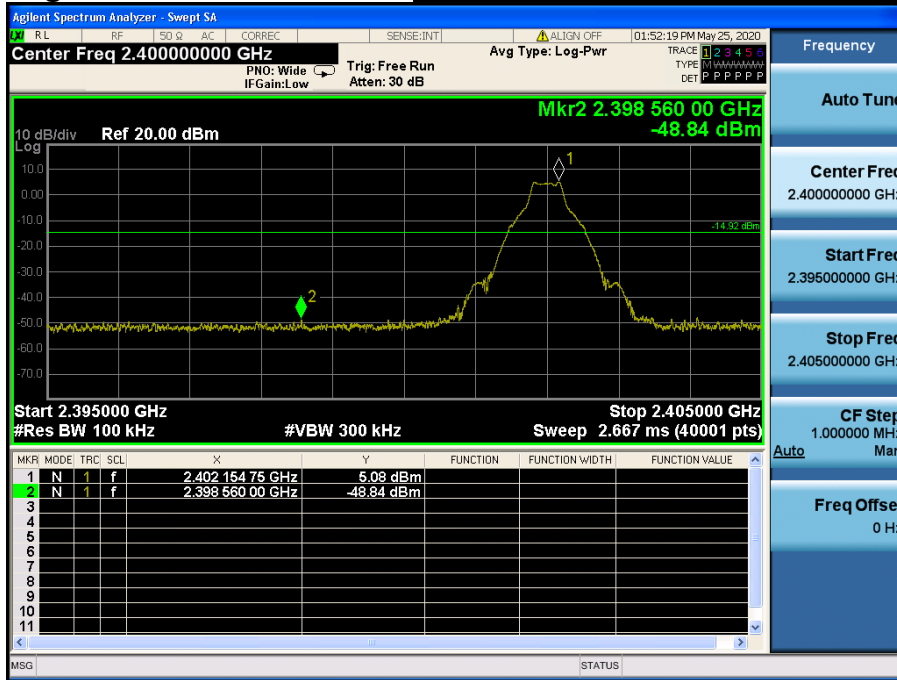

Low Band-edge

***Hopping mode & Modulation : GFSK***

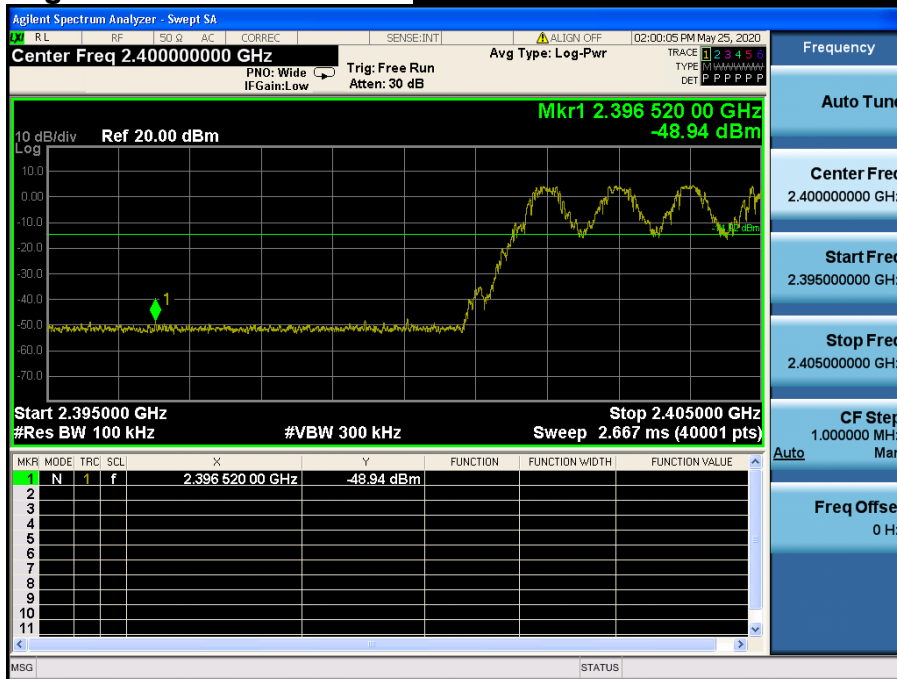

Conducted Spurious Emissions **Lowest Channel & Modulation : GFSK**

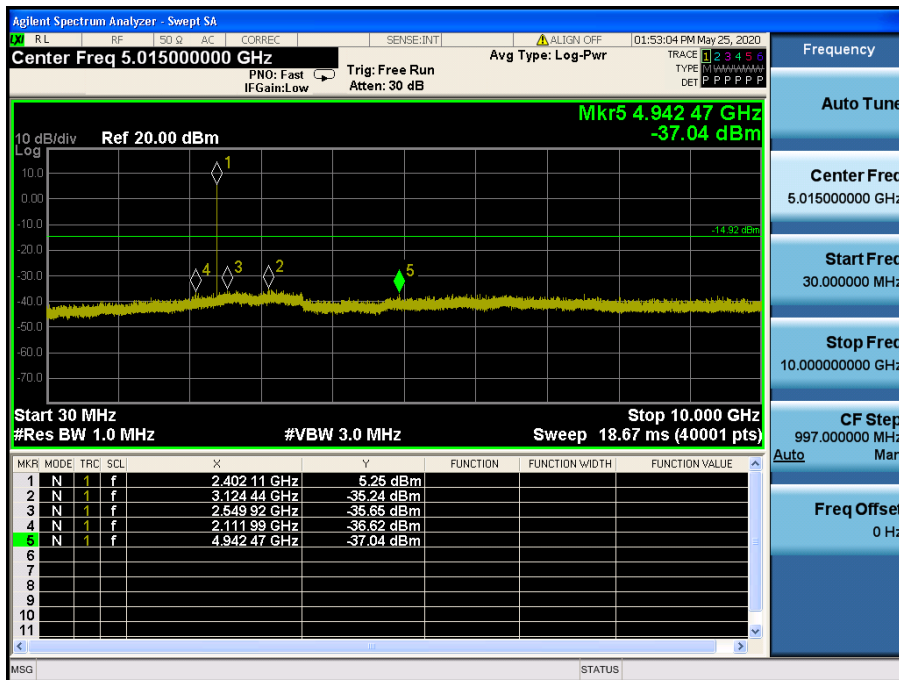
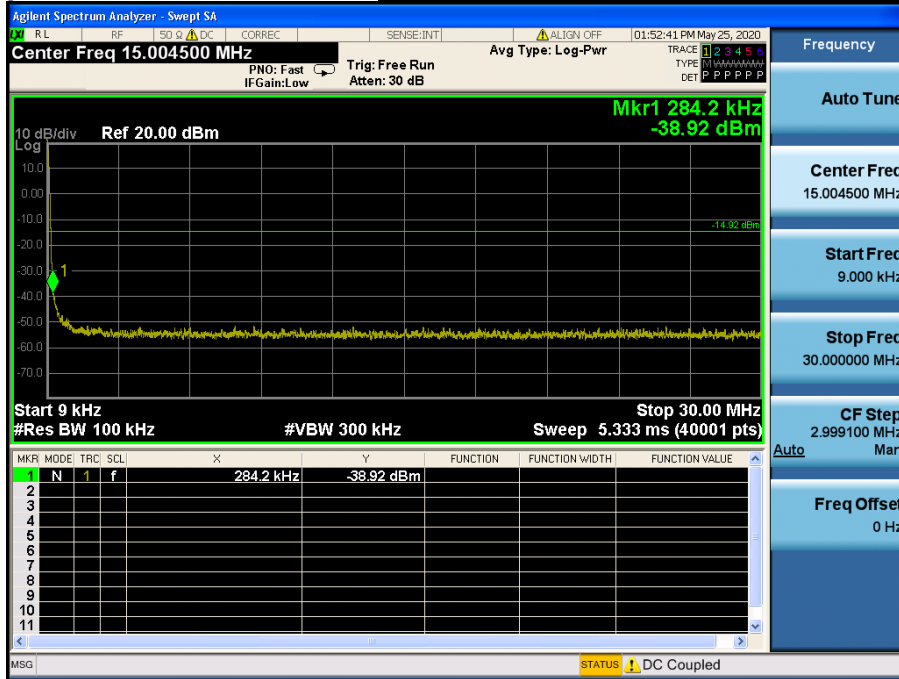

**Conducted Spurious Emissions**      ***Lowest Channel & Modulation : GFSK***

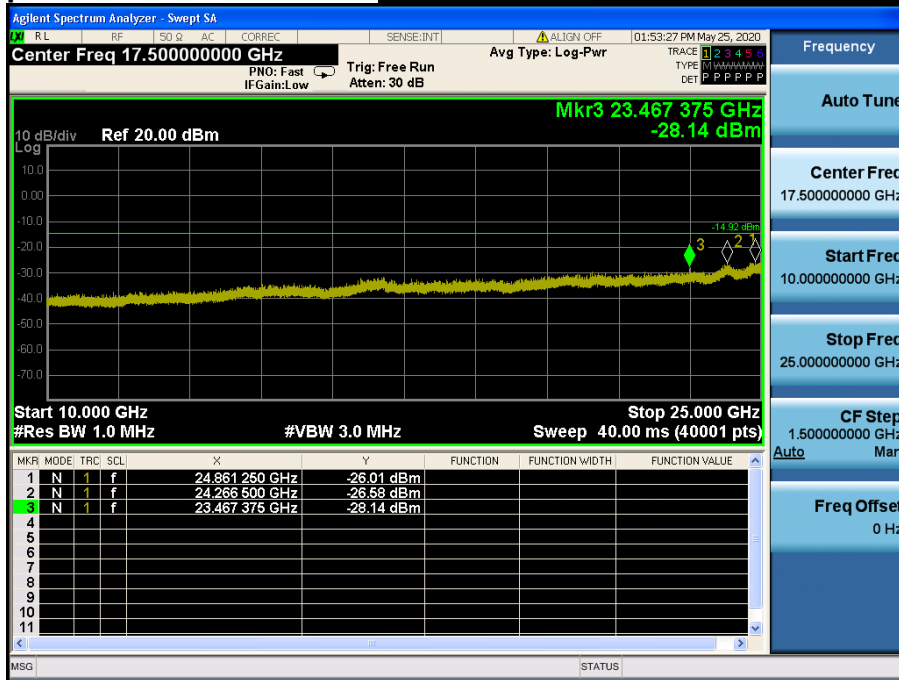

Reference for limit

Middle Channel & Modulation : GFSK

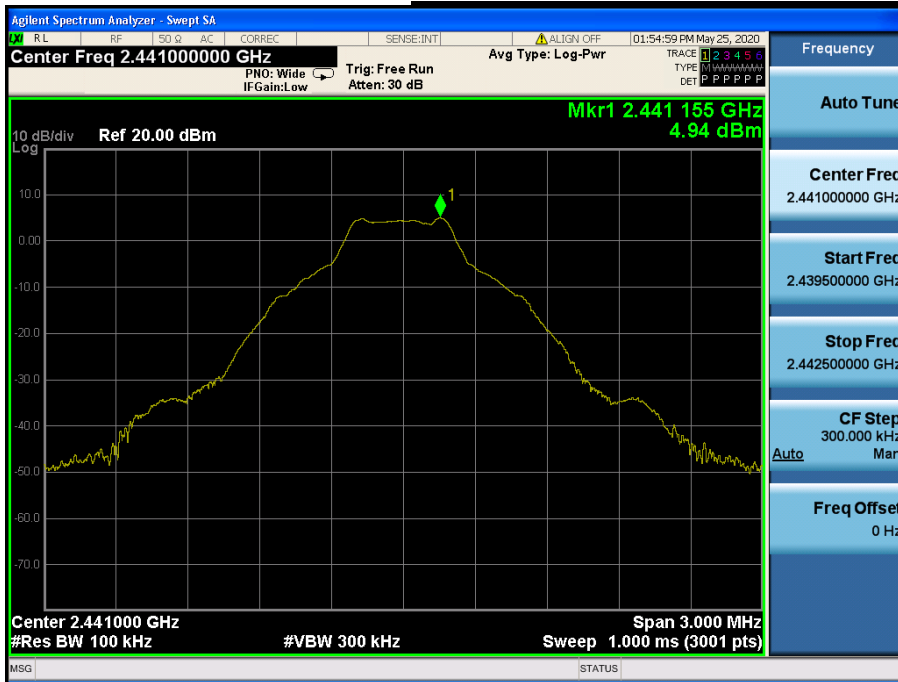

Conducted Spurious Emissions

Middle Channel & Modulation : GFSK

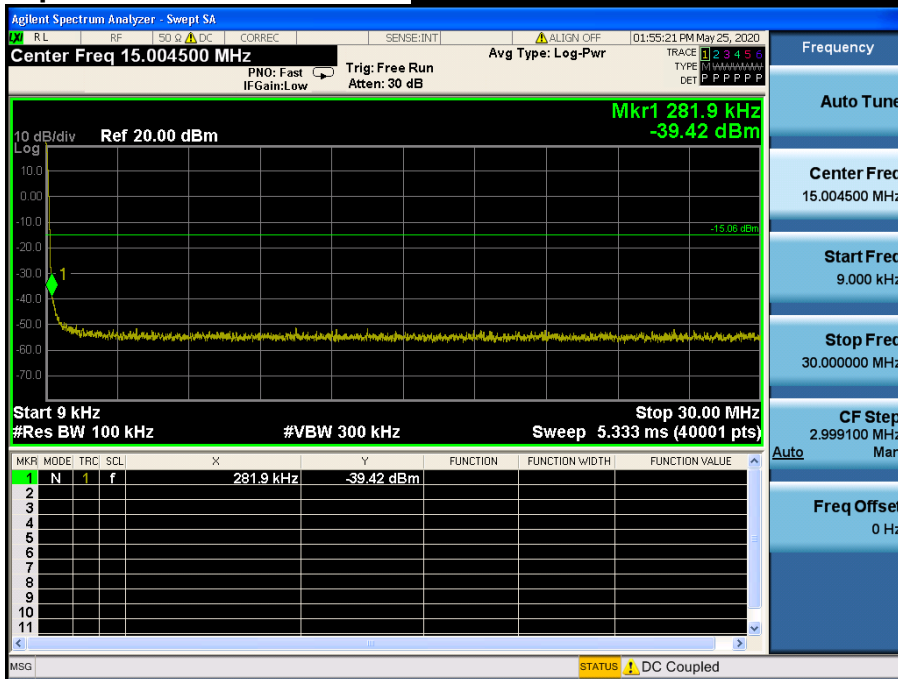

Conducted Spurious Emissions **Middle Channel & Modulation : GFSK**

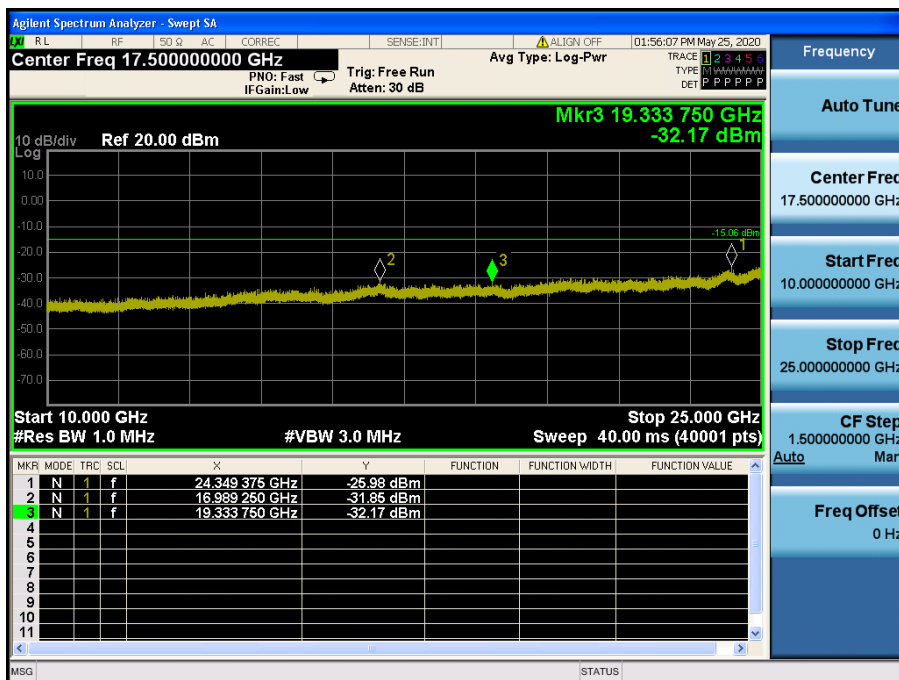
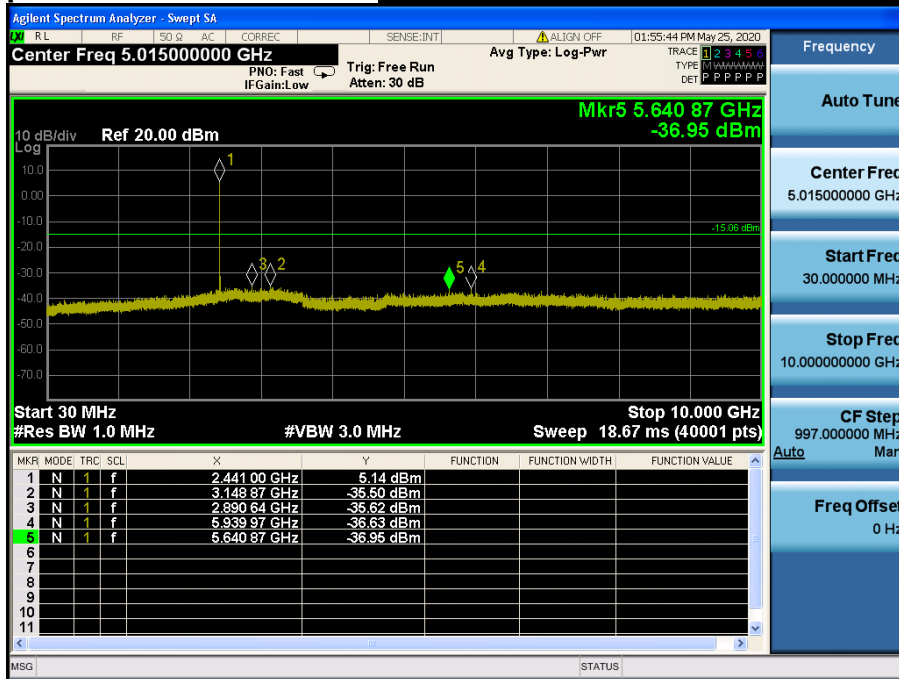

High Band-edge

Highest Channel & Modulation : GFSK

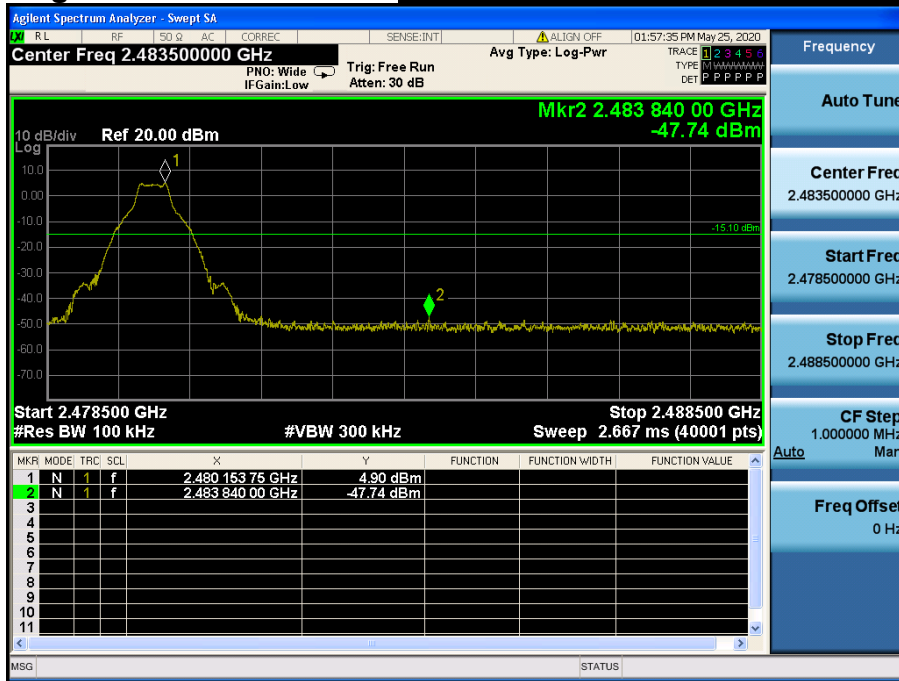

High Band-edge

Hopping mode & Modulation : GFSK

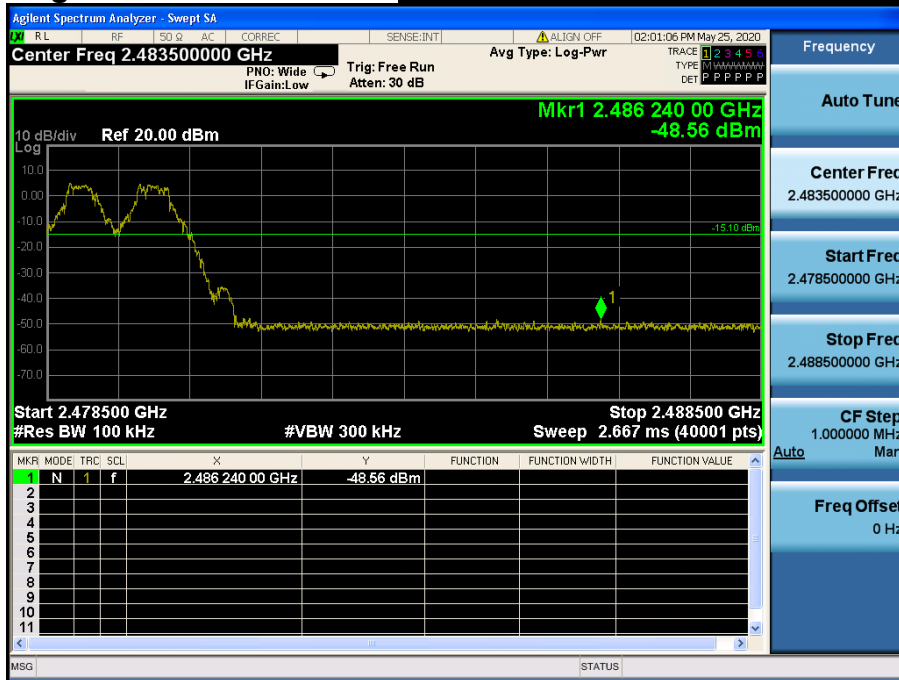

Conducted Spurious Emissions **Highest Channel & Modulation : GFSK**

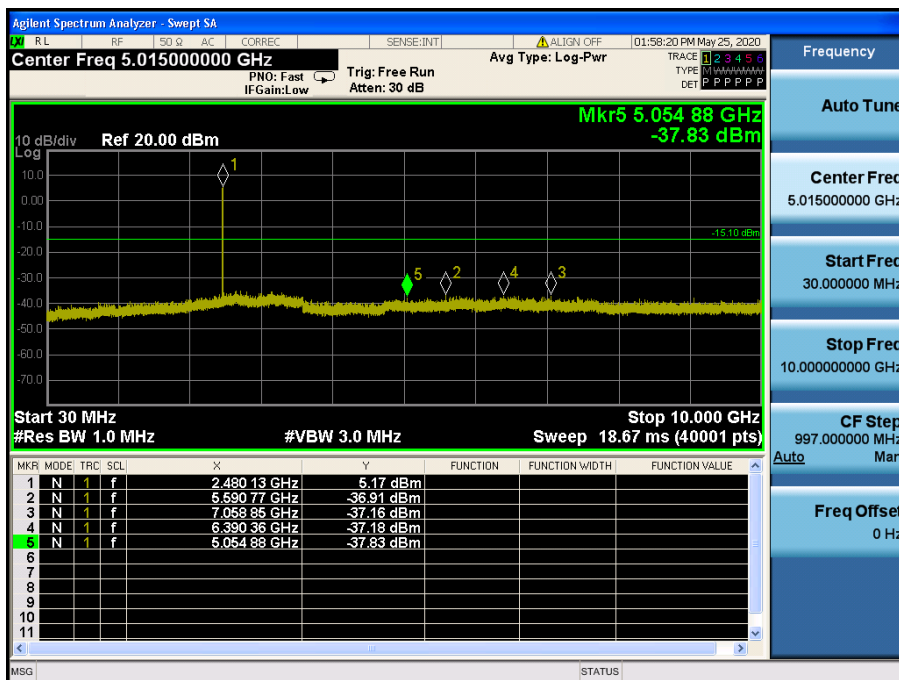
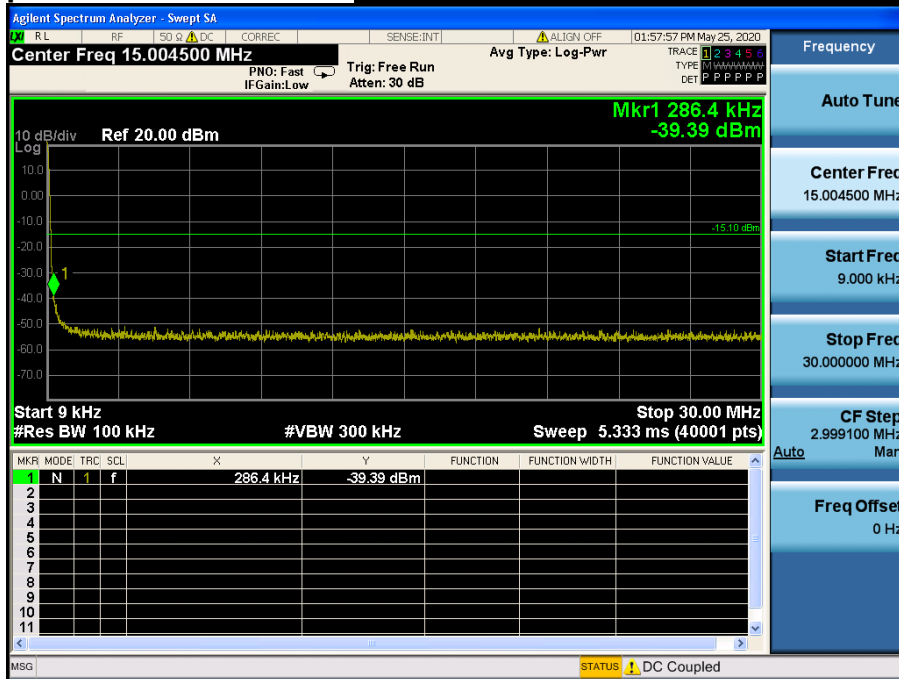

Conducted Spurious Emissions **Highest Channel & Modulation : GFSK**





Low Band-edge

*Lowest Channel & Modulation :  $\pi/4$ DQPSK*

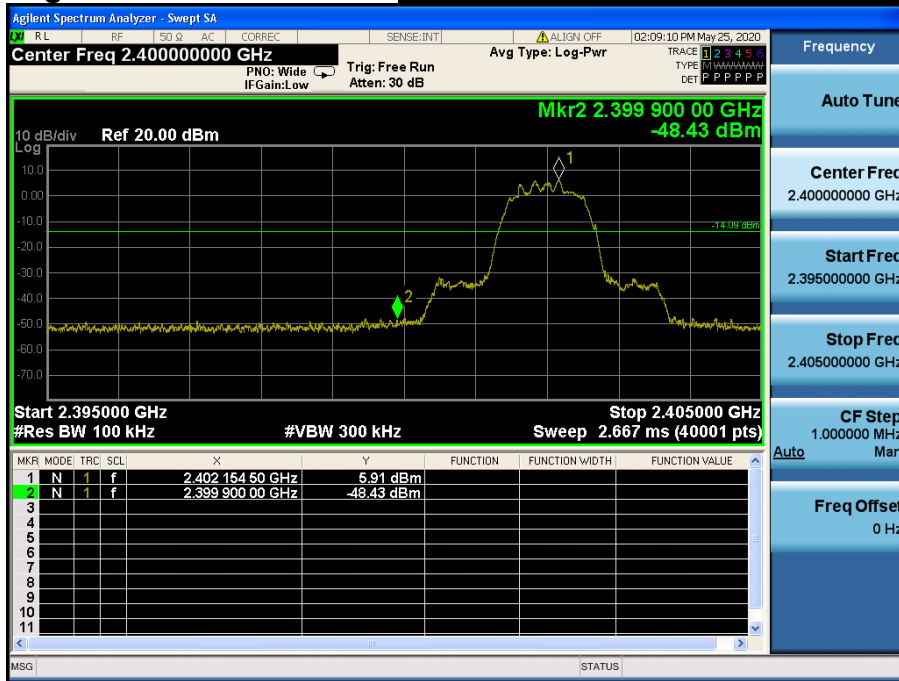

Low Band-edge

*Hopping mode & Modulation :  $\pi/4$ DQPSK*

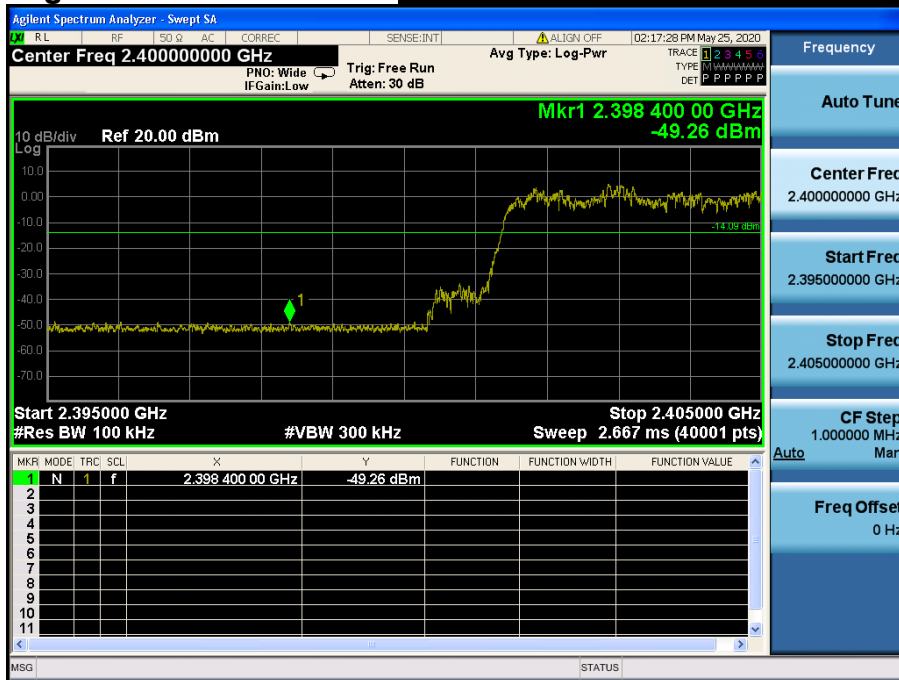

Conducted Spurious Emissions **Lowest Channel & Modulation :  $\pi/4$ DQPSK**

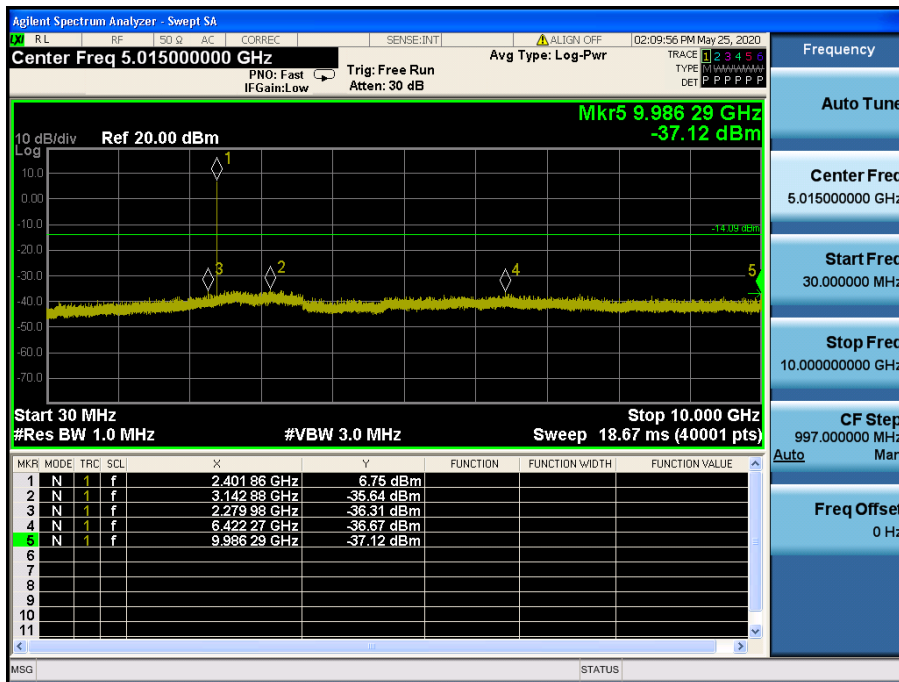
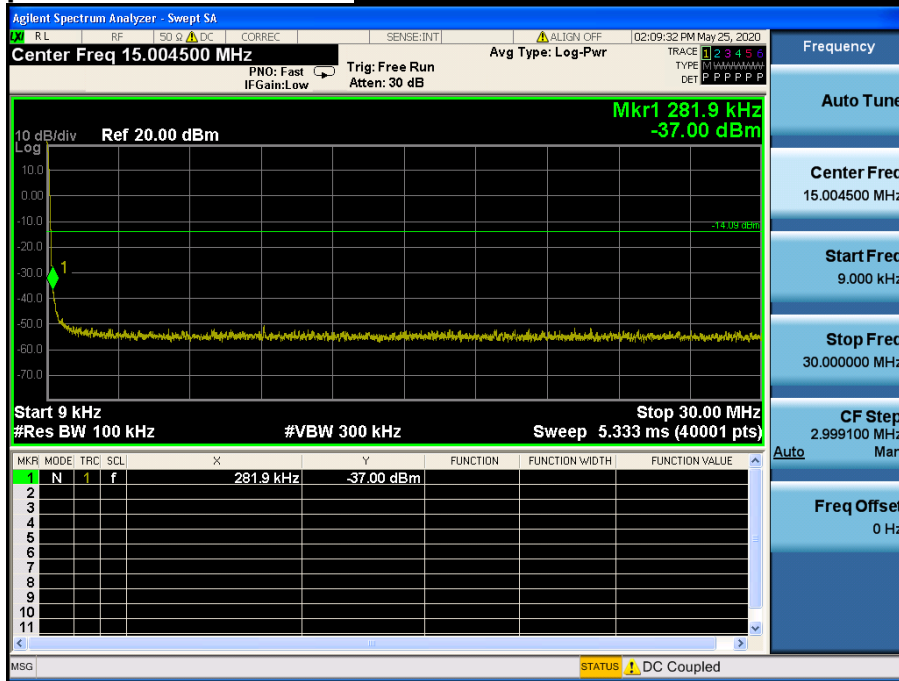

Conducted Spurious Emissions **Lowest Channel & Modulation :  $\pi/4$ DQPSK**



Reference for limit

**Middle Channel & Modulation :  $\pi/4$ DQPSK**



Conducted Spurious Emissions

**Middle Channel & Modulation :  $\pi/4$ DQPSK**

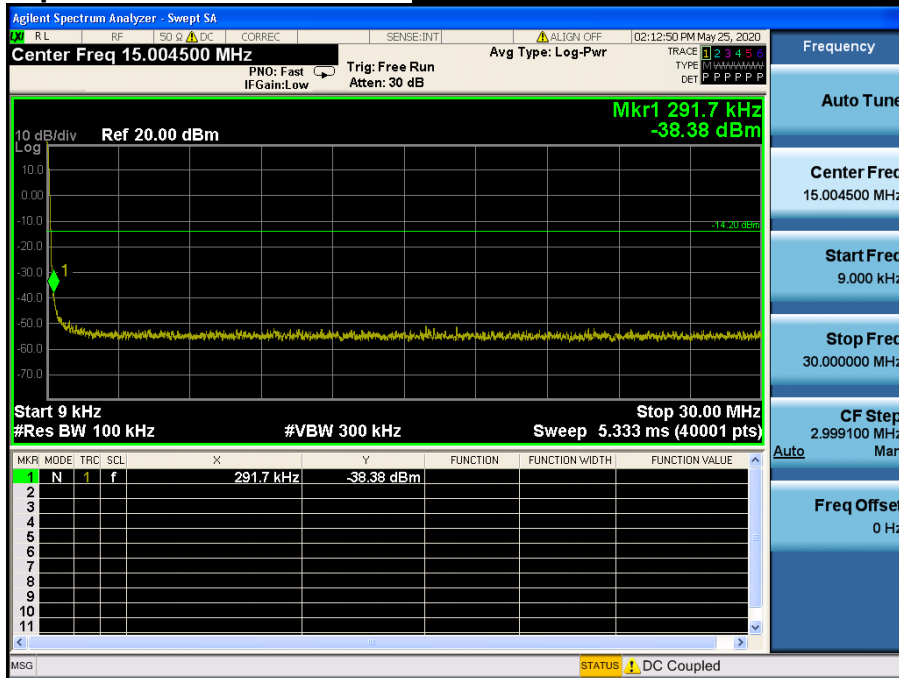

Conducted Spurious Emissions ***Middle Channel & Modulation :  $\pi/4$ DQPSK***

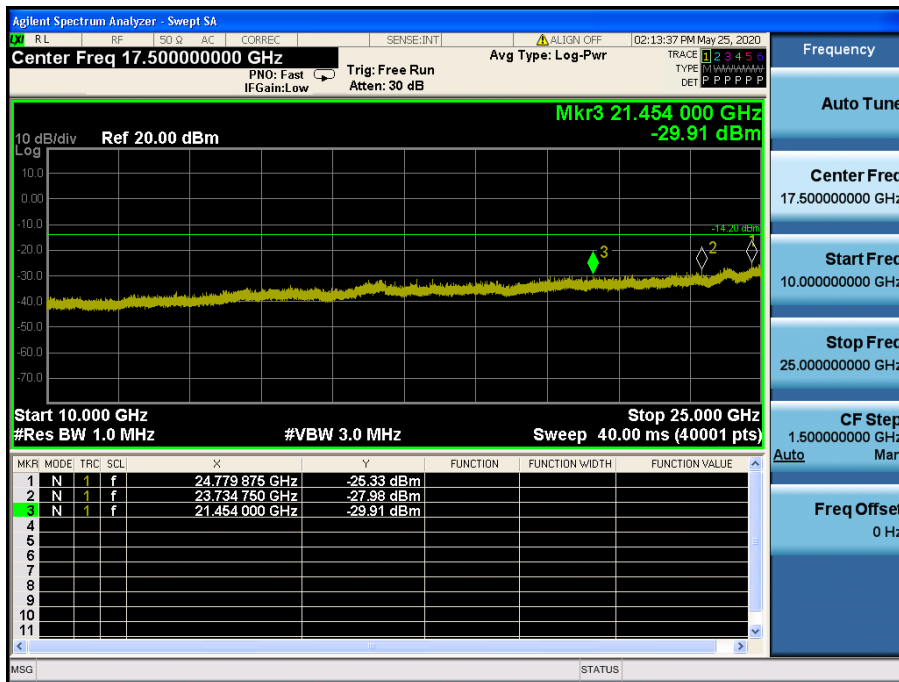
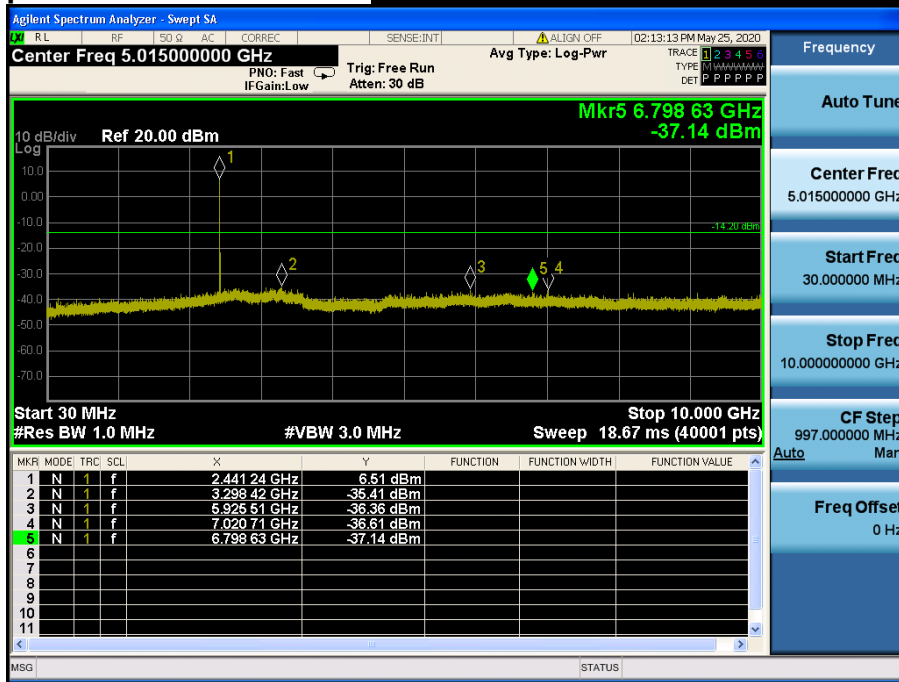

High Band-edge

**Highest Channel & Modulation :  $\pi/4$ DQPSK**

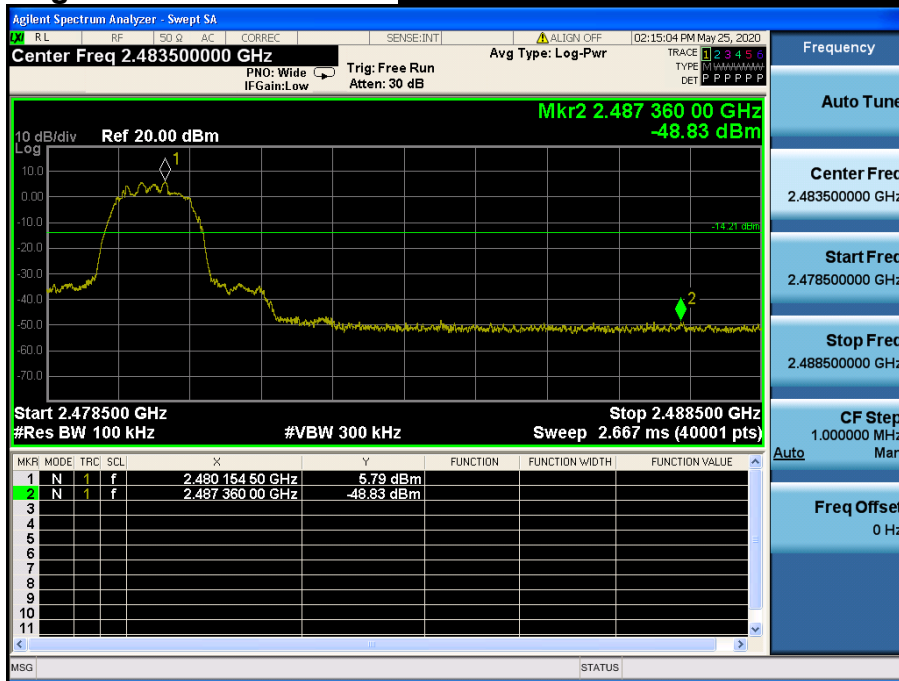

High Band-edge

**Hopping mode & Modulation :  $\pi/4$ DQPSK**

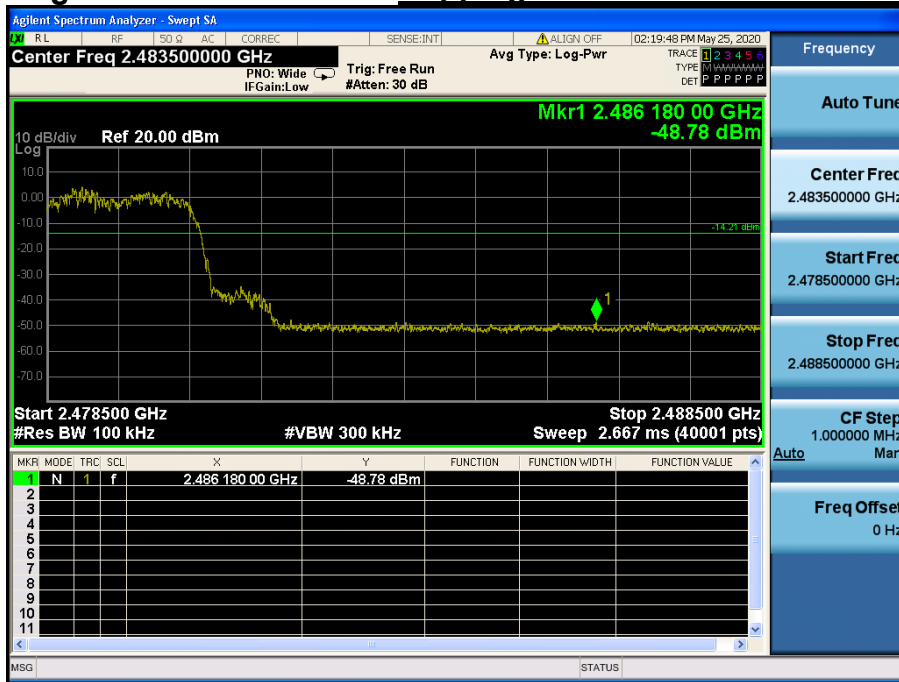

Conducted Spurious Emissions **Highest Channel & Modulation :  $\pi/4$ DQPSK**

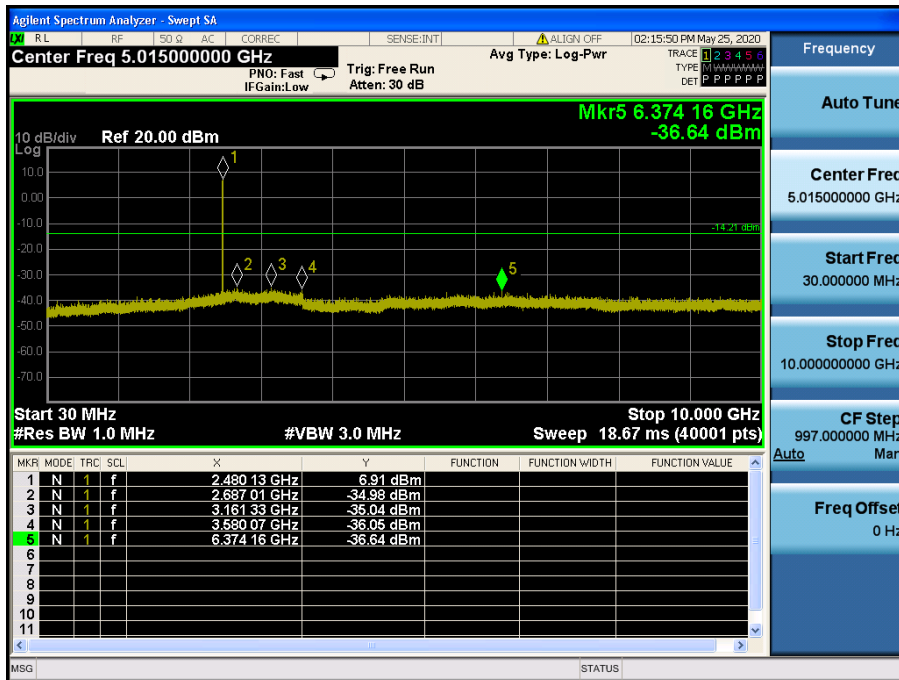
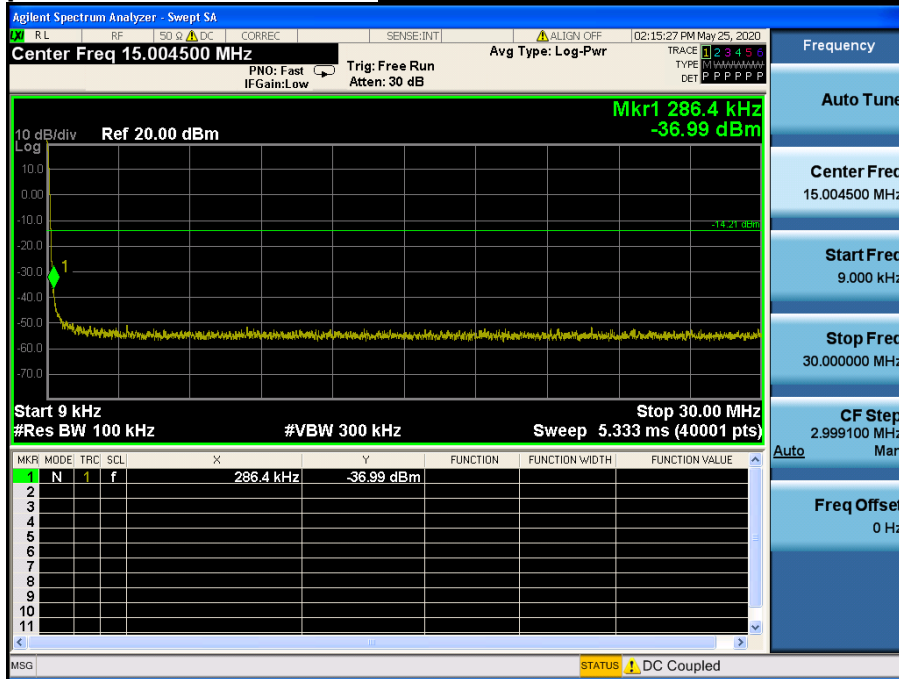

Conducted Spurious Emissions **Highest Channel & Modulation :  $\pi/4$ DQPSK**





Low Band-edge

**Lowest Channel & Modulation : 8DPSK**

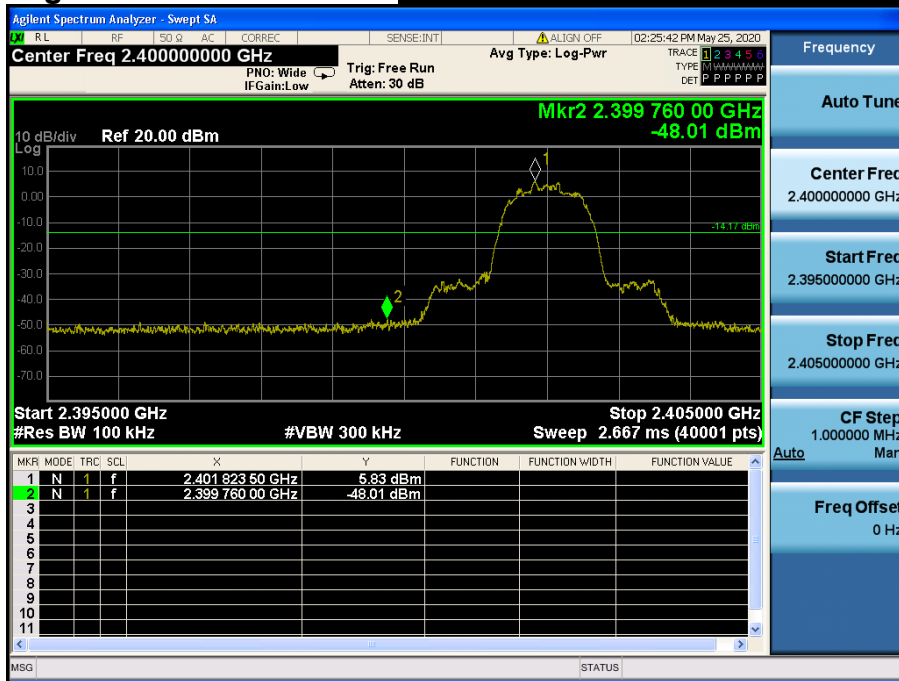

Low Band-edge

**Hopping mode & Modulation : 8DPSK**

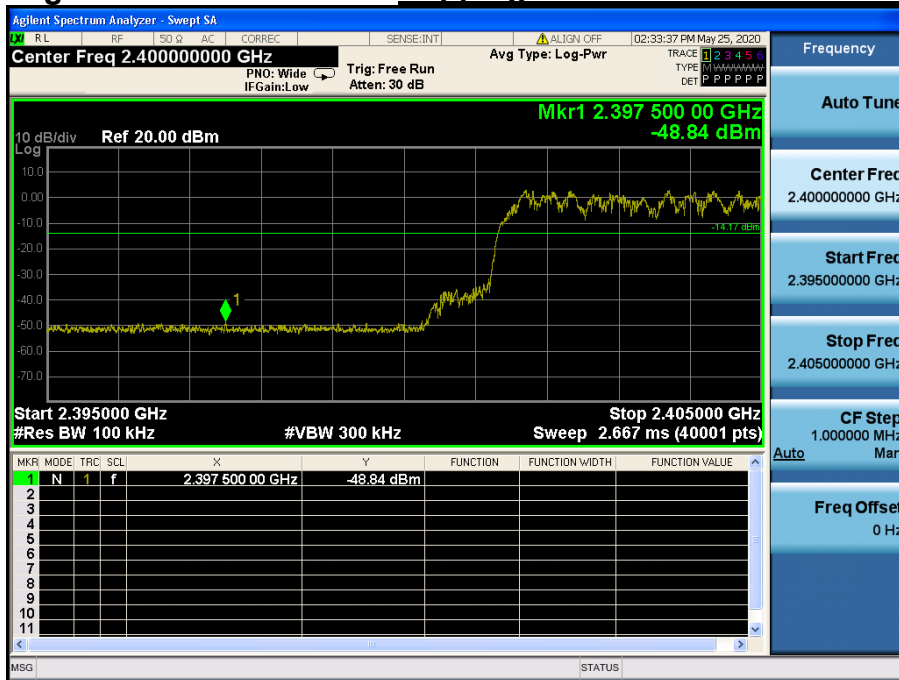

Conducted Spurious Emissions **Lowest Channel & Modulation : 8DPSK**

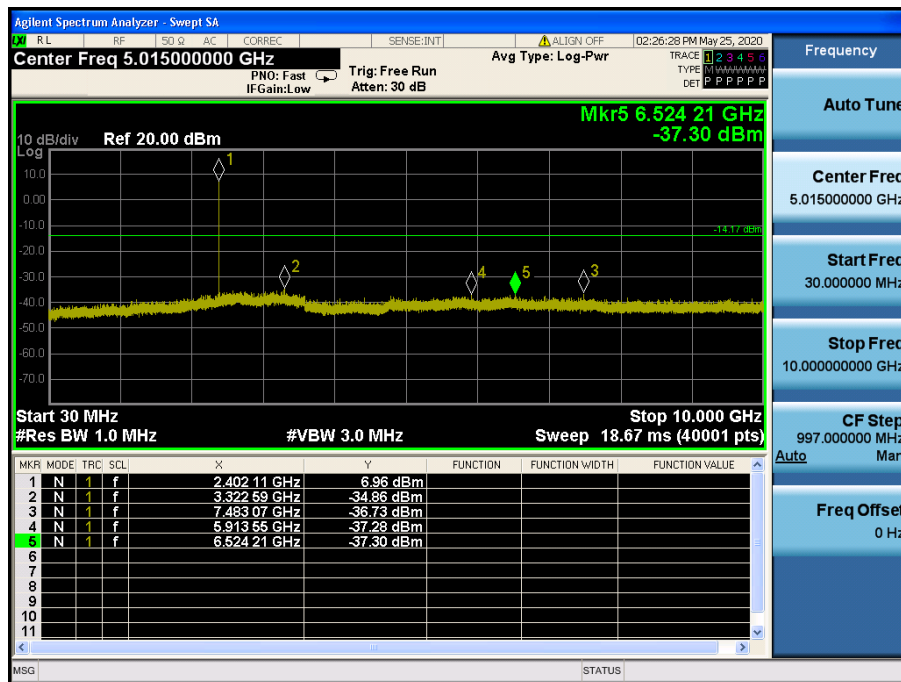
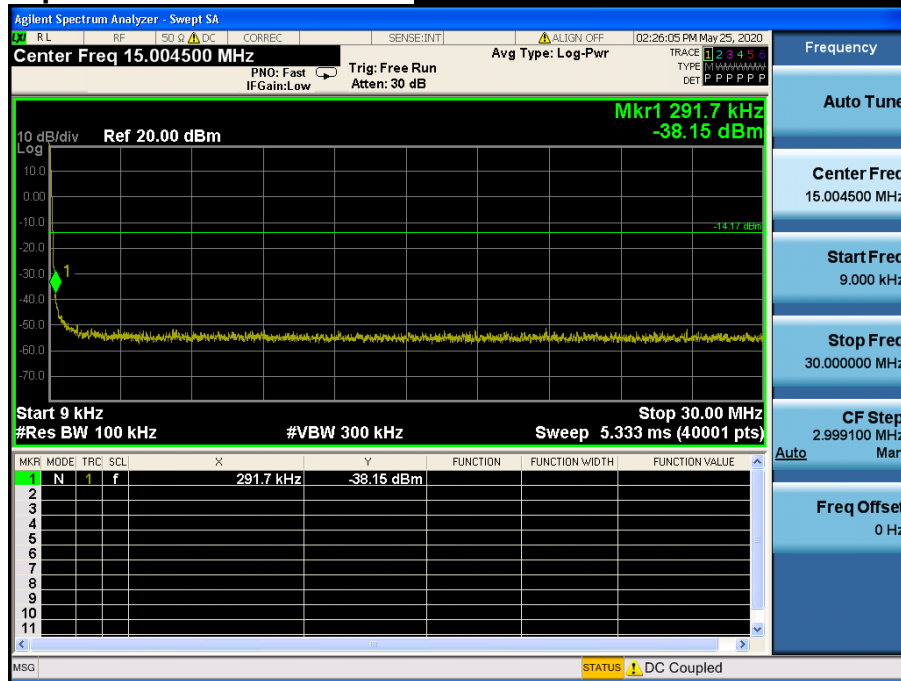

**Conducted Spurious Emissions**      **Lowest Channel & Modulation : 8DPSK**

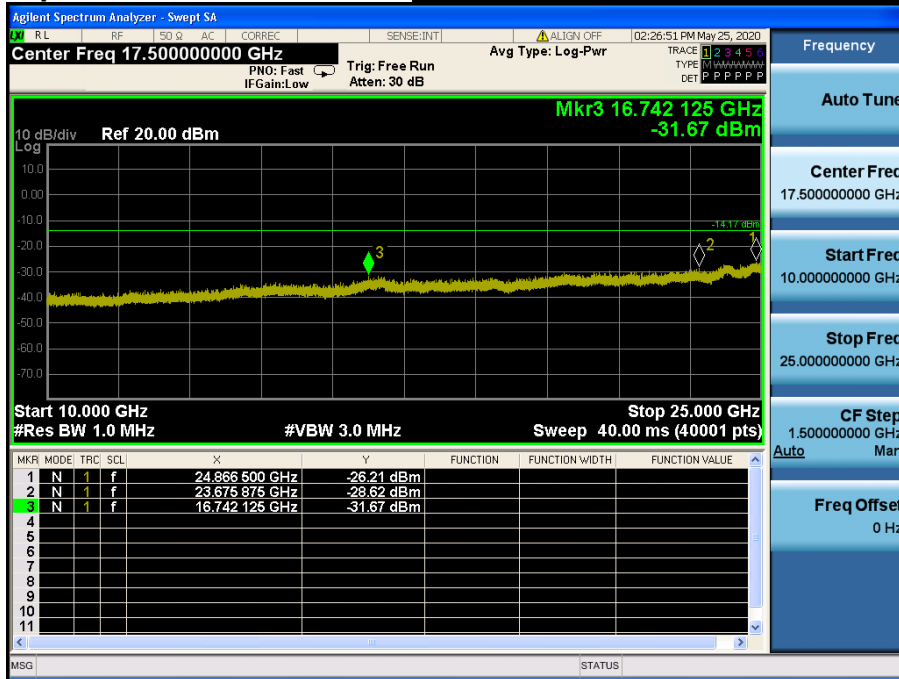

Reference for limit

**Middle Channel & Modulation : 8DPSK**

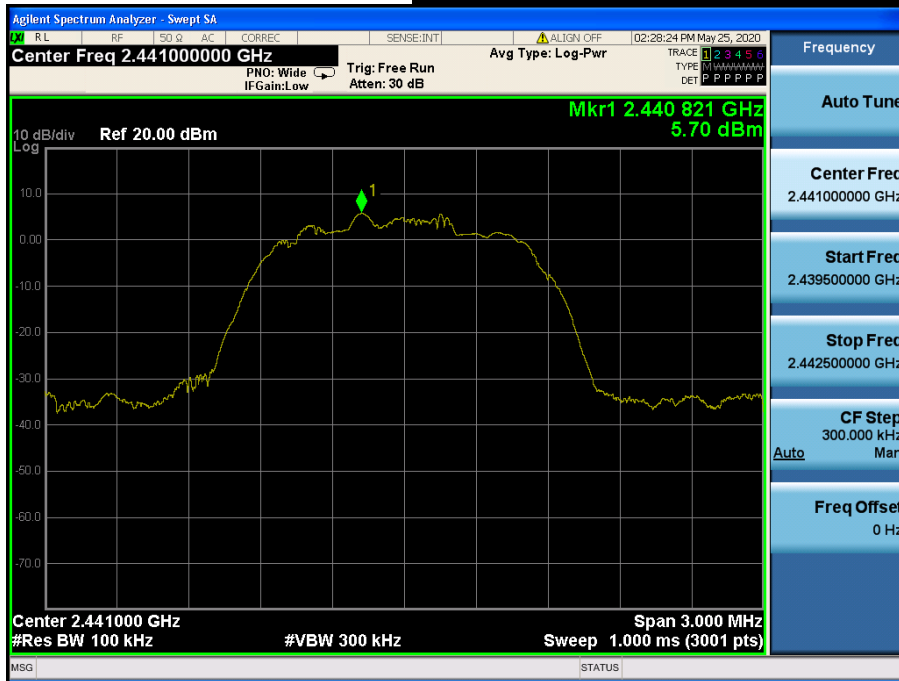

Conducted Spurious Emissions

**Middle Channel & Modulation : 8DPSK**

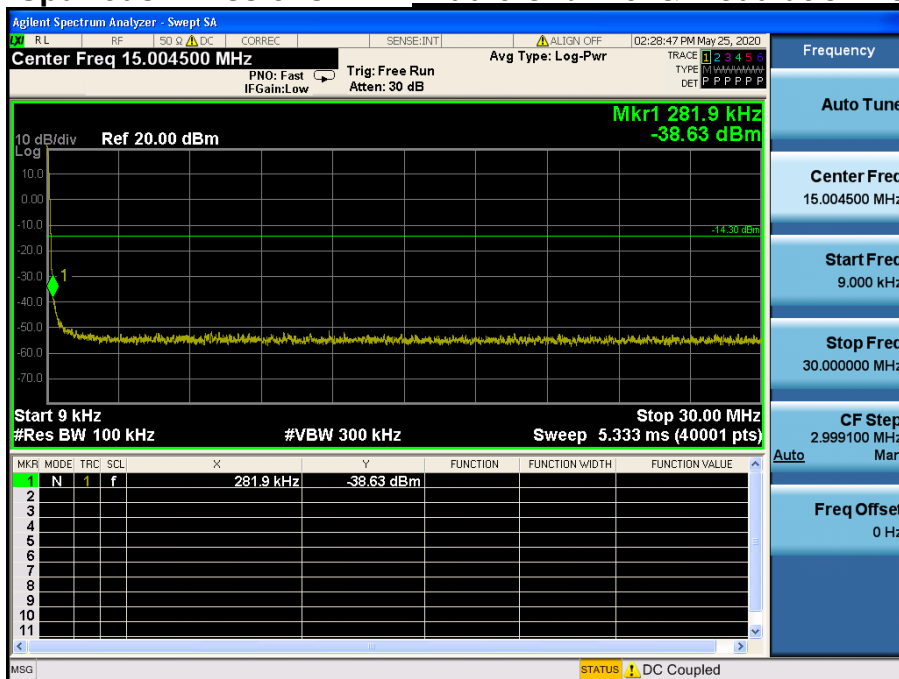

Conducted Spurious Emissions *Middle Channel & Modulation : 8DPSK*

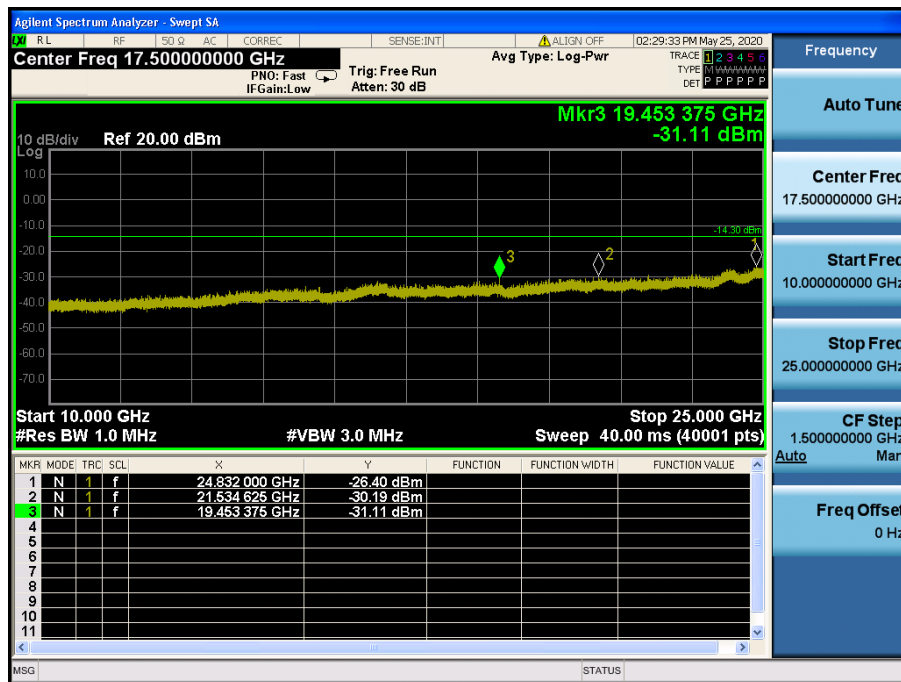
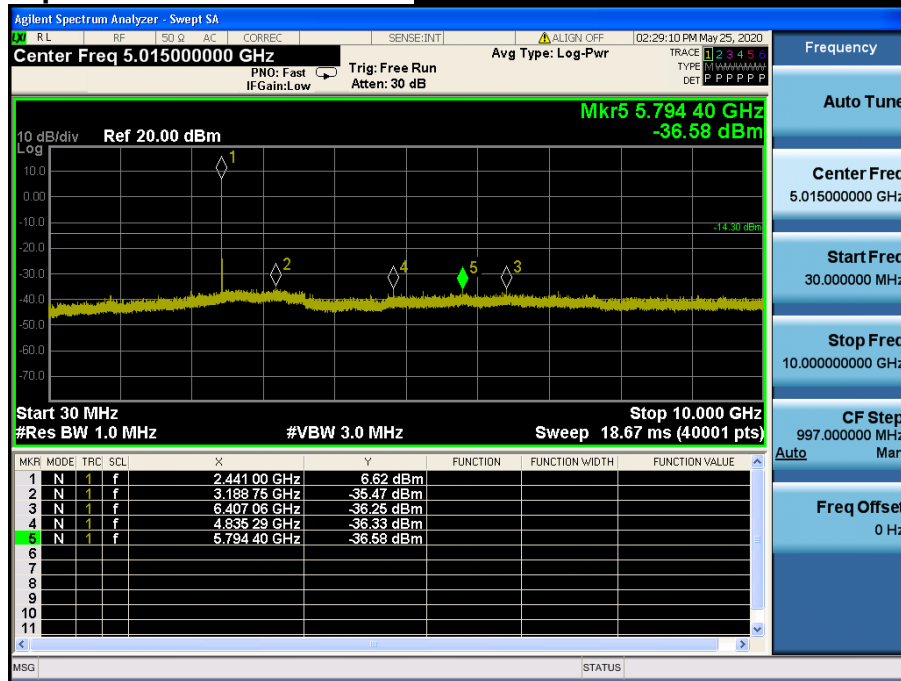

High Band-edge

**Highest Channel & Modulation : 8DPSK**

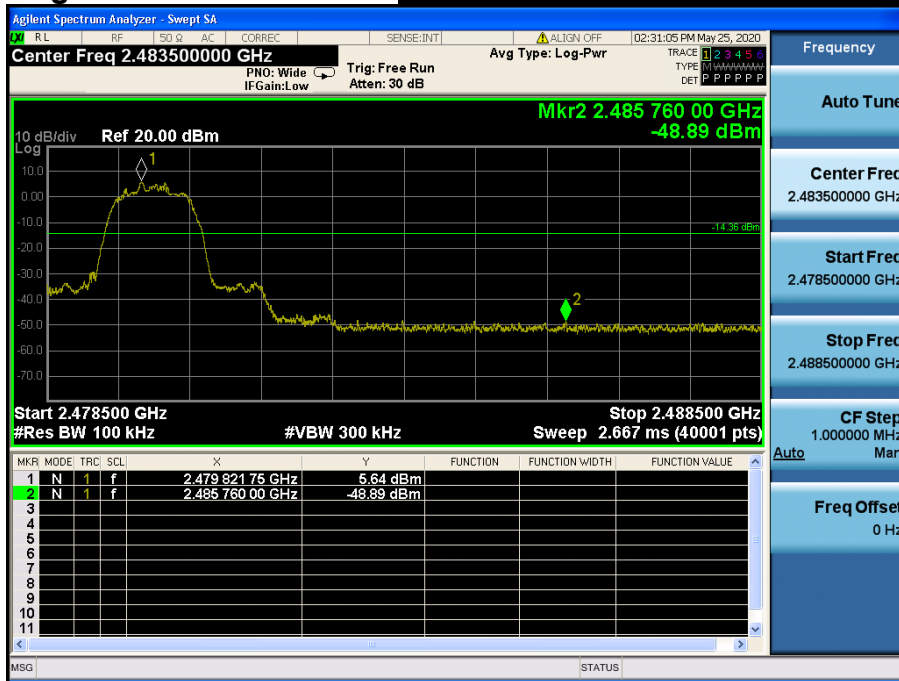

High Band-edge

**Hopping mode & Modulation : 8DPSK**

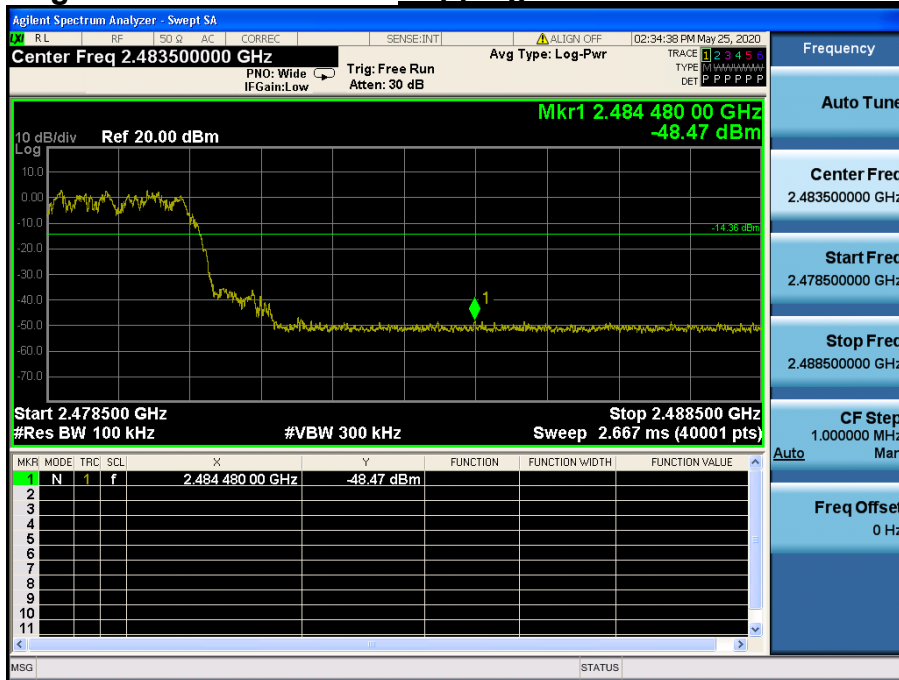

Conducted Spurious Emissions *Highest Channel & Modulation : 8DPSK*

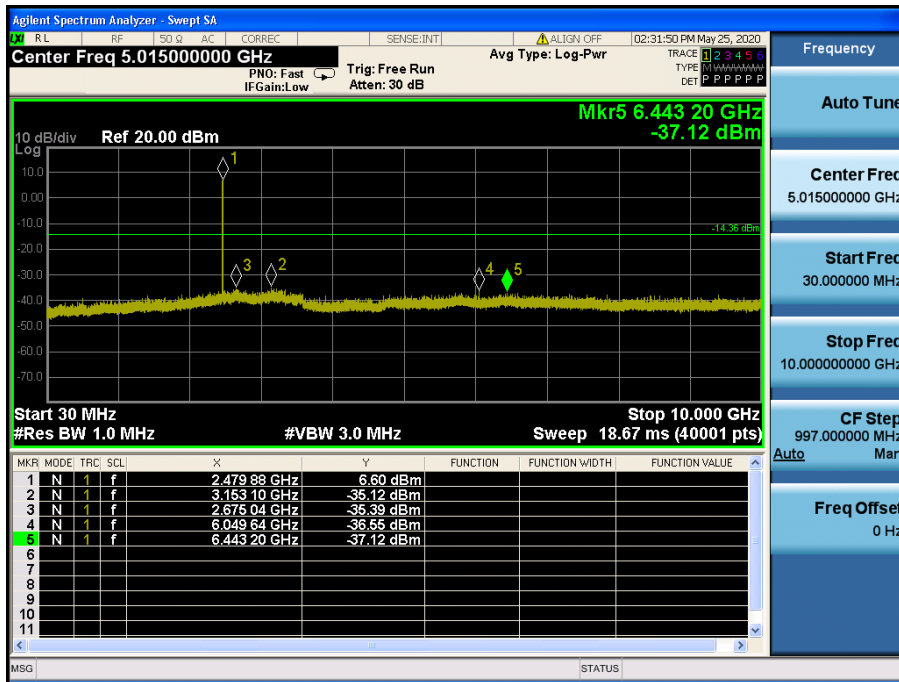
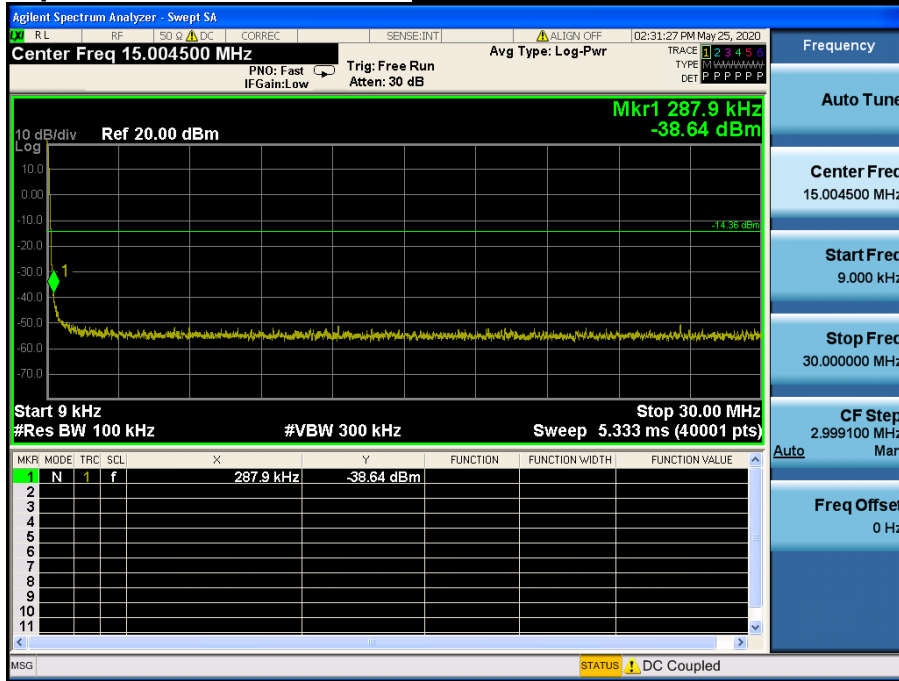

**Conducted Spurious Emissions**      **Highest Channel & Modulation : 8DPSK**





- Tested Power Supply: 24 V

Low Band-edge

Lowest Channel & Modulation : GFSK

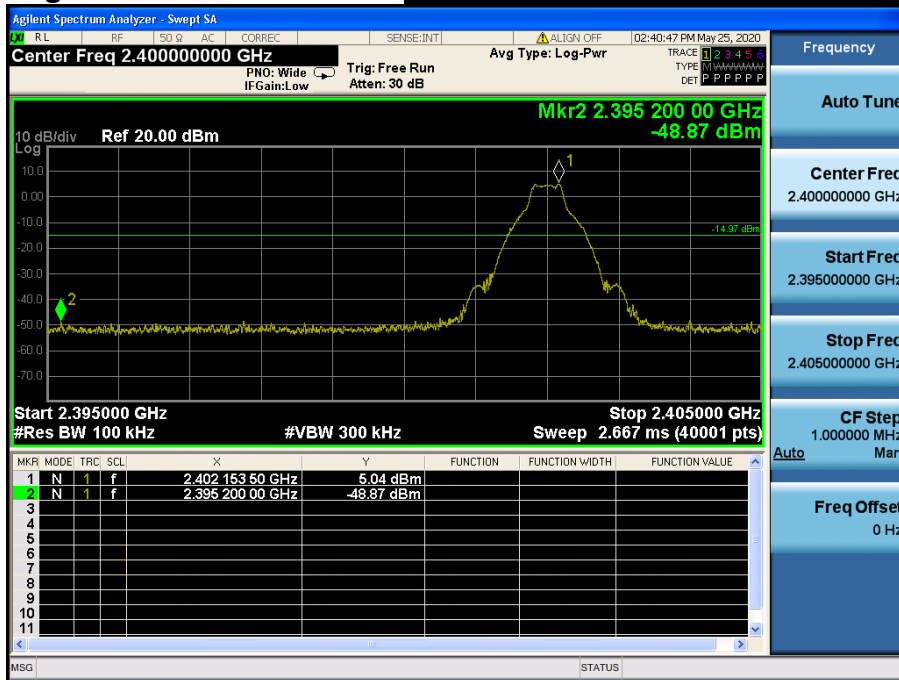

Low Band-edge

Hopping mode & Modulation : GFSK

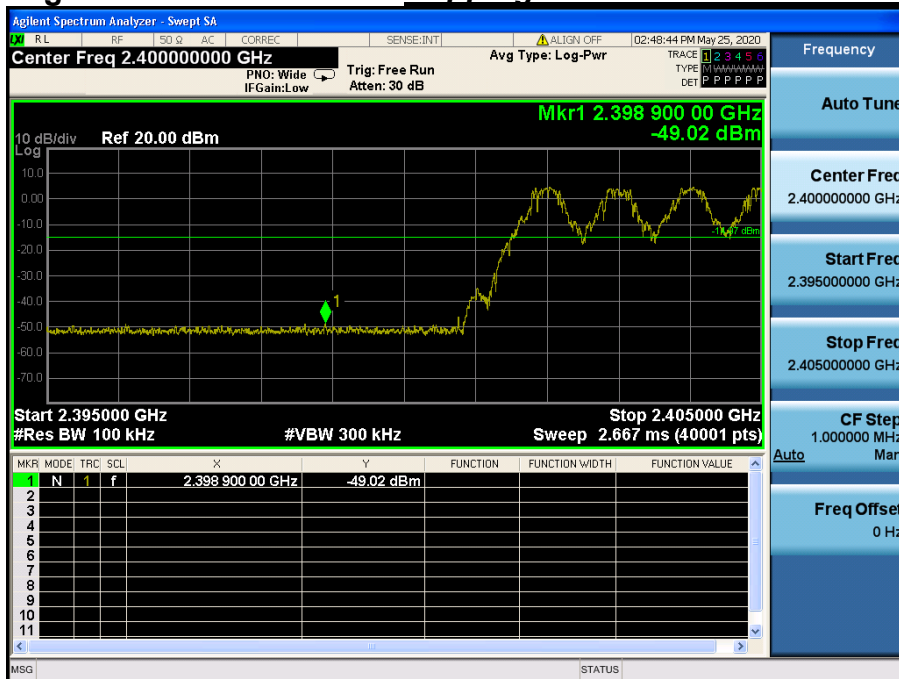

Conducted Spurious Emissions **Lowest Channel & Modulation : GFSK**

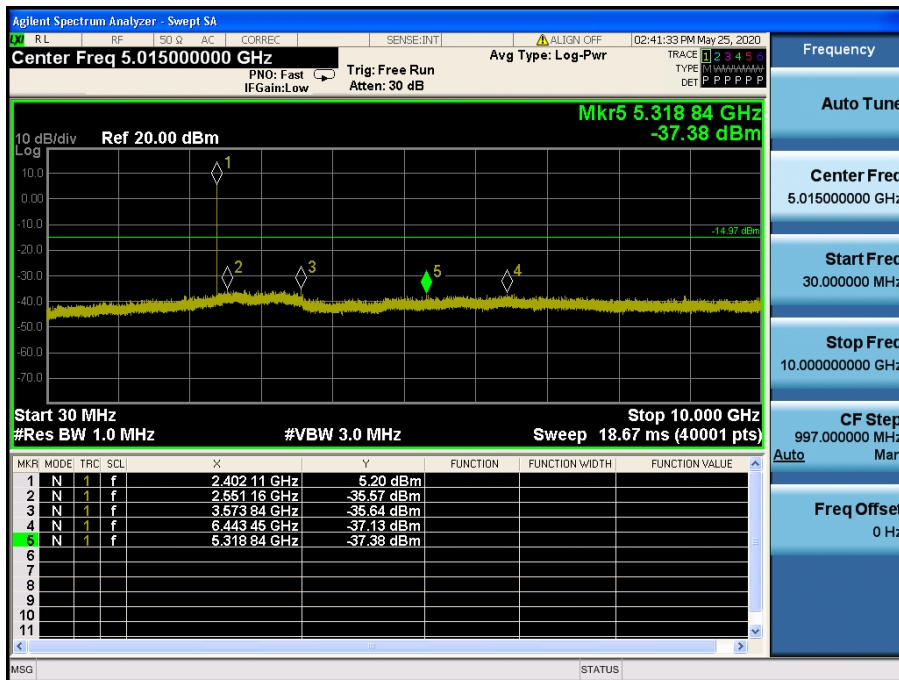
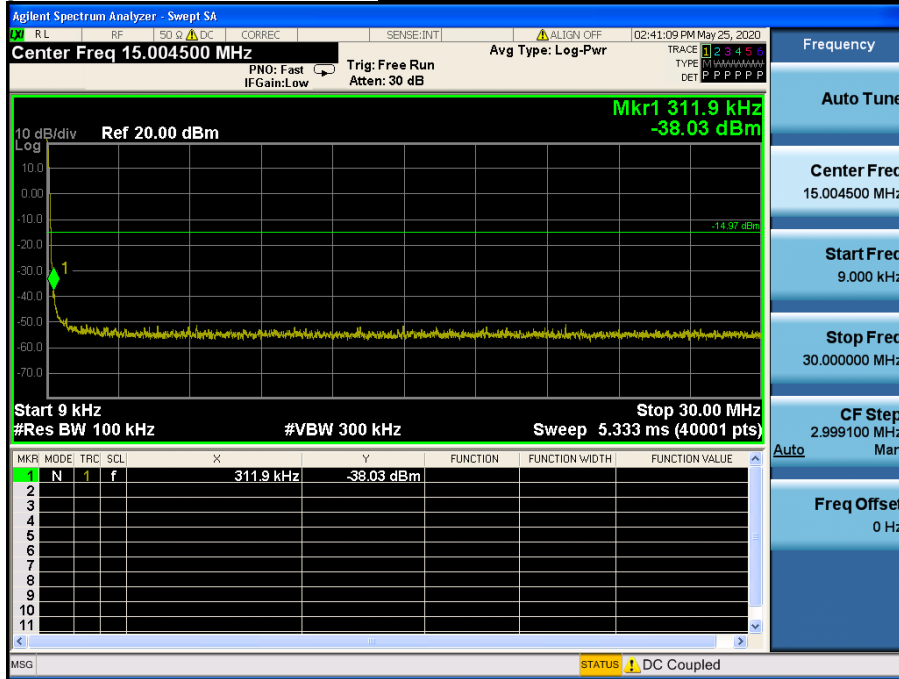

**Conducted Spurious Emissions** *Lowest Channel & Modulation : GFSK*



Reference for limit

Middle Channel & Modulation : GFSK

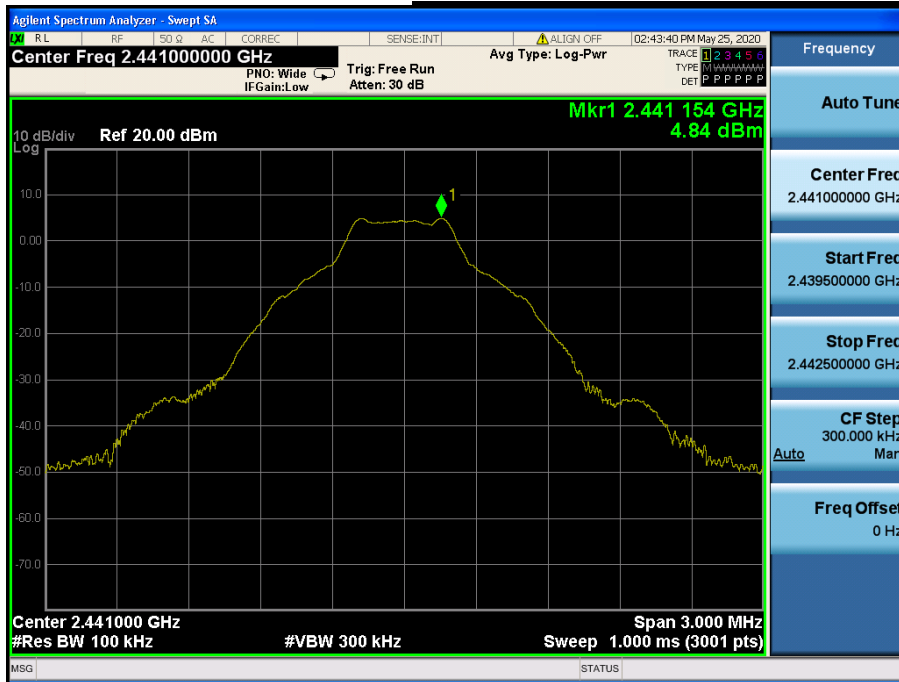

Conducted Spurious Emissions

Middle Channel & Modulation : GFSK

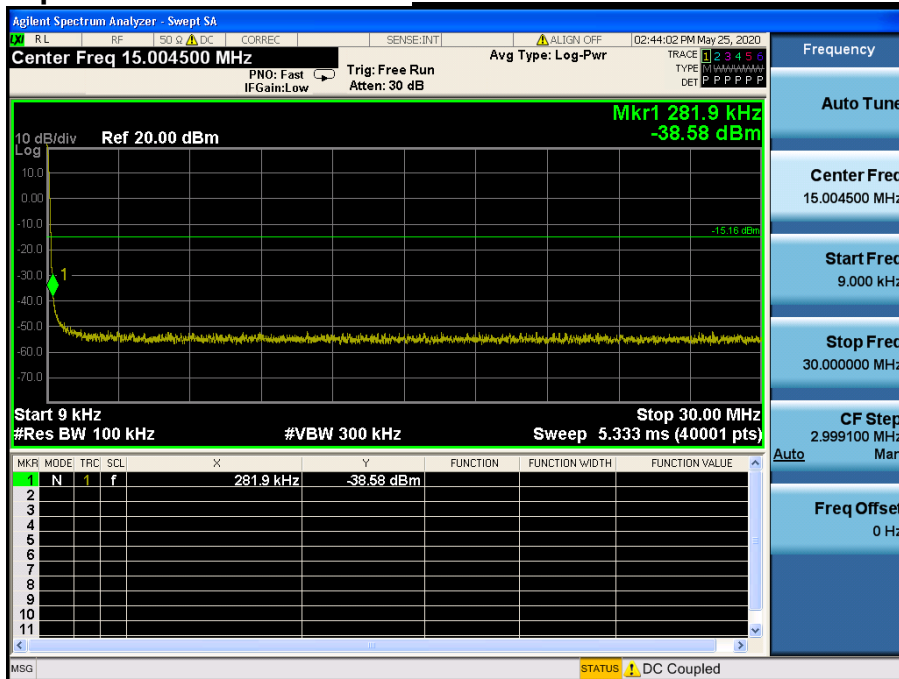

Conducted Spurious Emissions *Middle Channel & Modulation : GFSK*

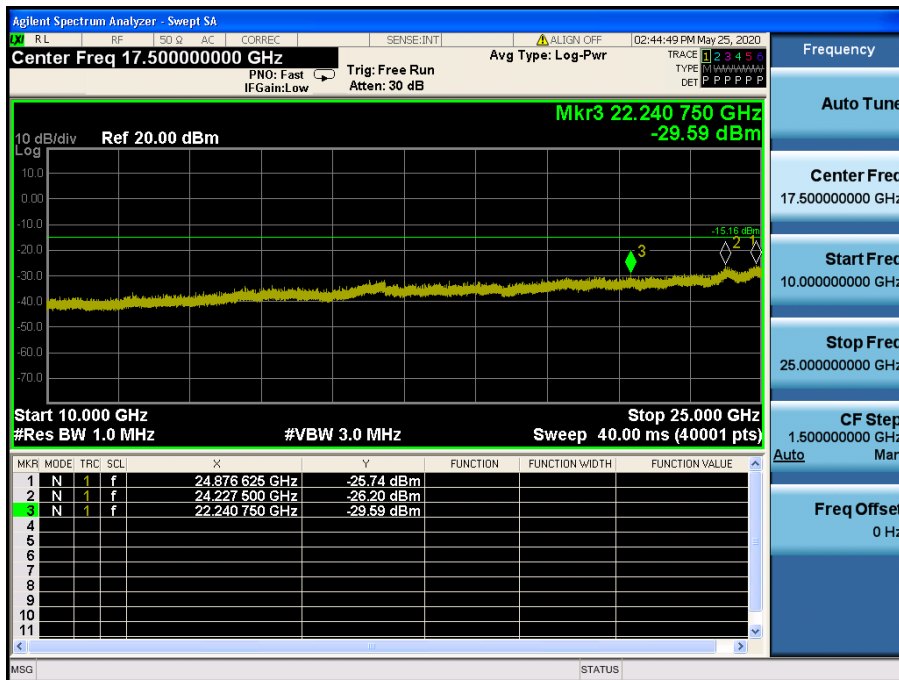
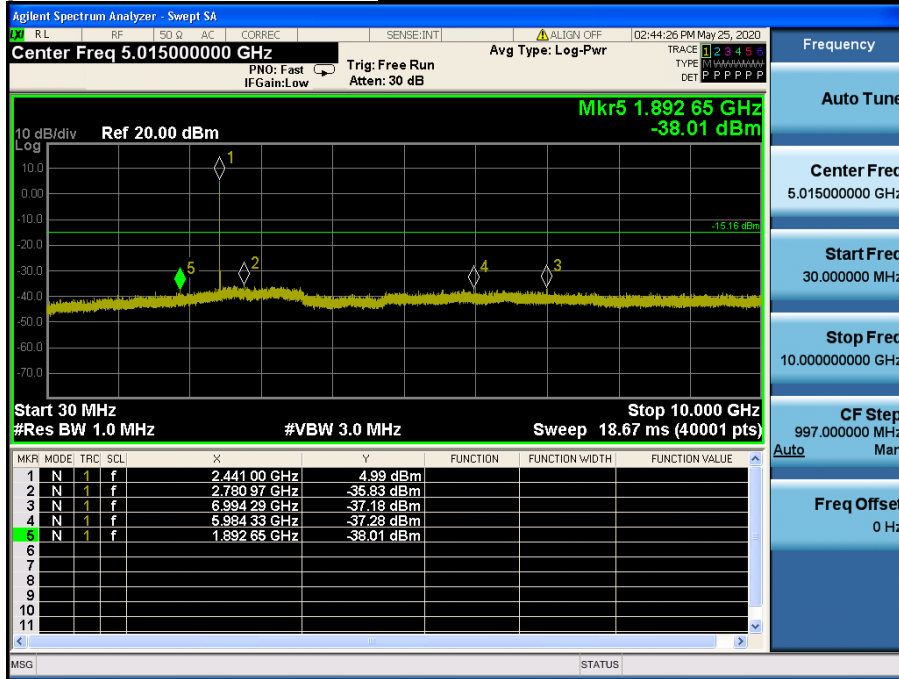

High Band-edge

Highest Channel & Modulation : GFSK

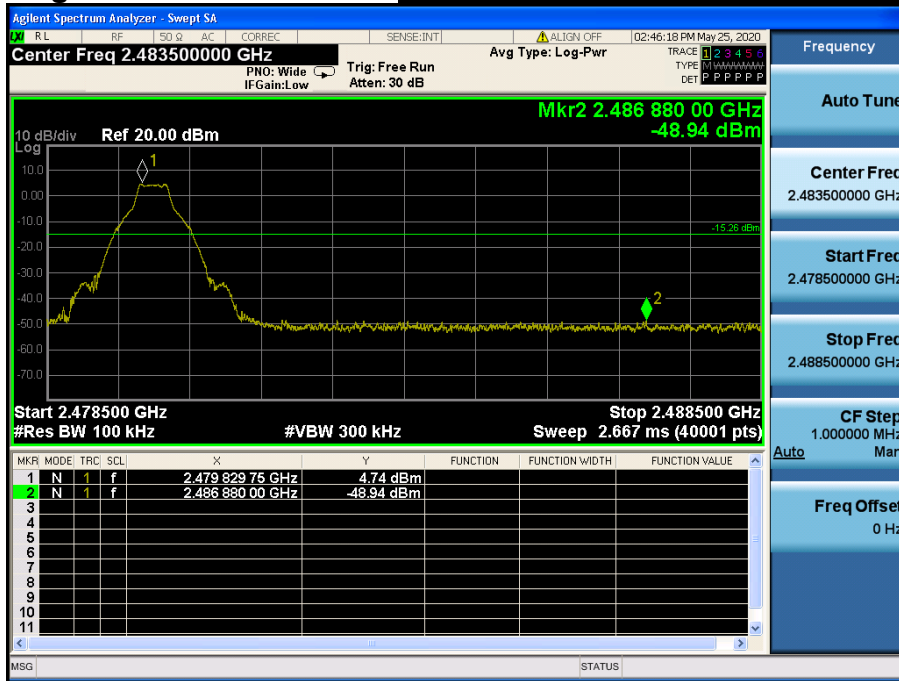

High Band-edge

Hopping mode & Modulation : GFSK

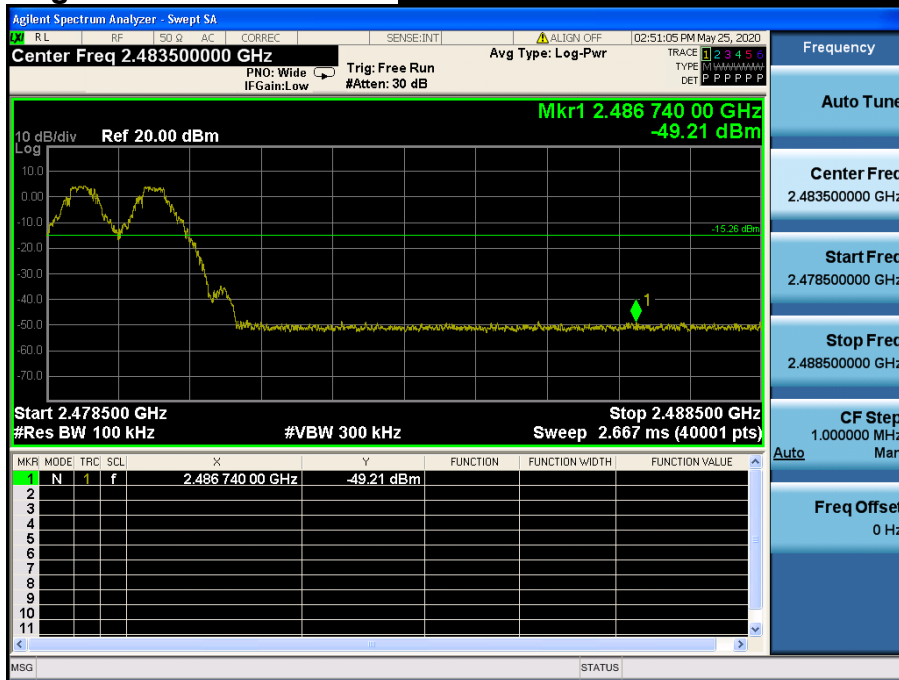

Conducted Spurious Emissions **Highest Channel & Modulation : GFSK**

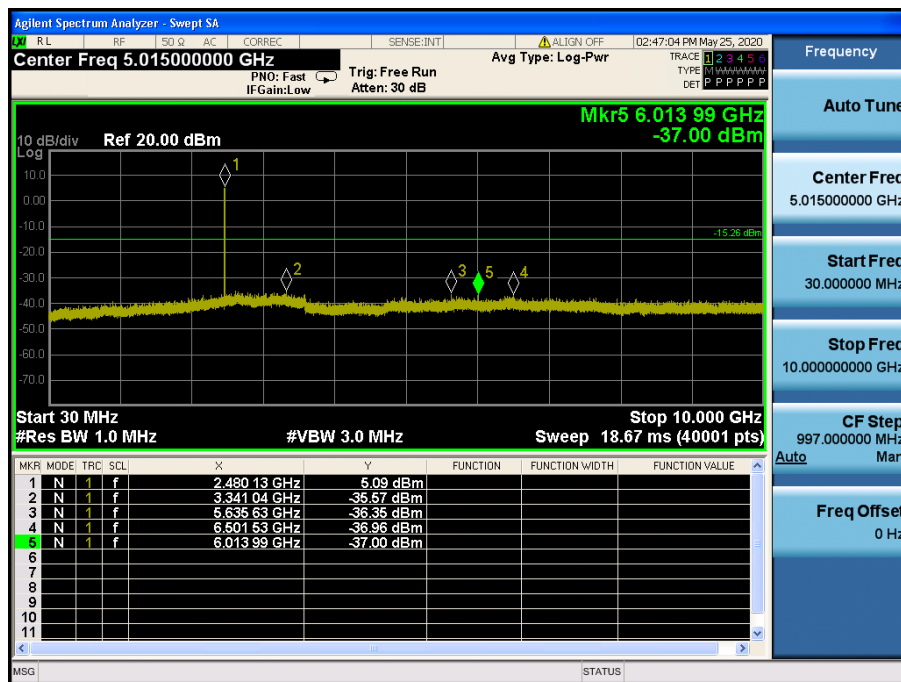
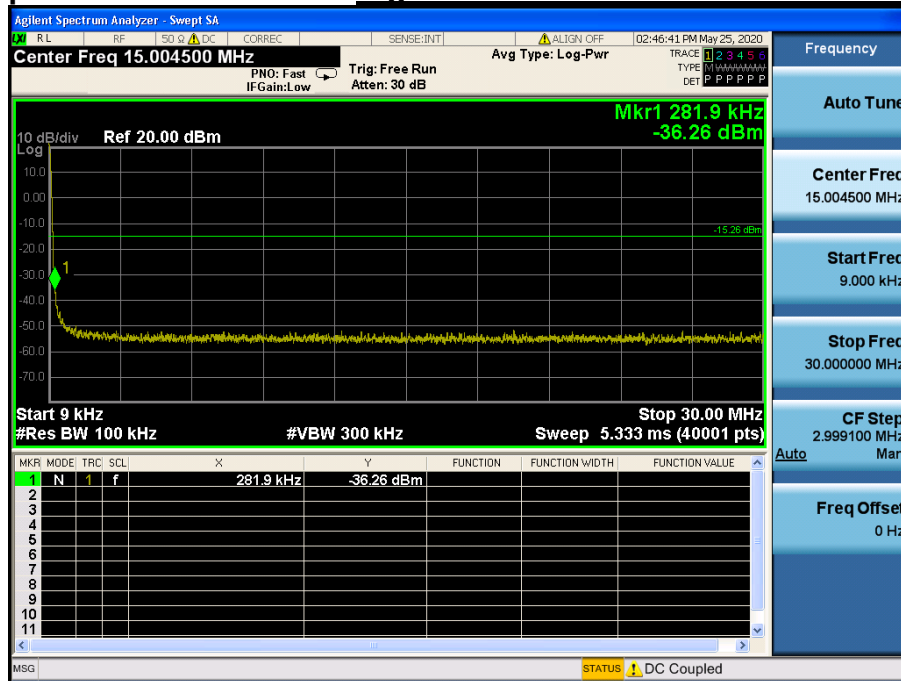

**Conducted Spurious Emissions**      **Highest Channel & Modulation : GFSK**

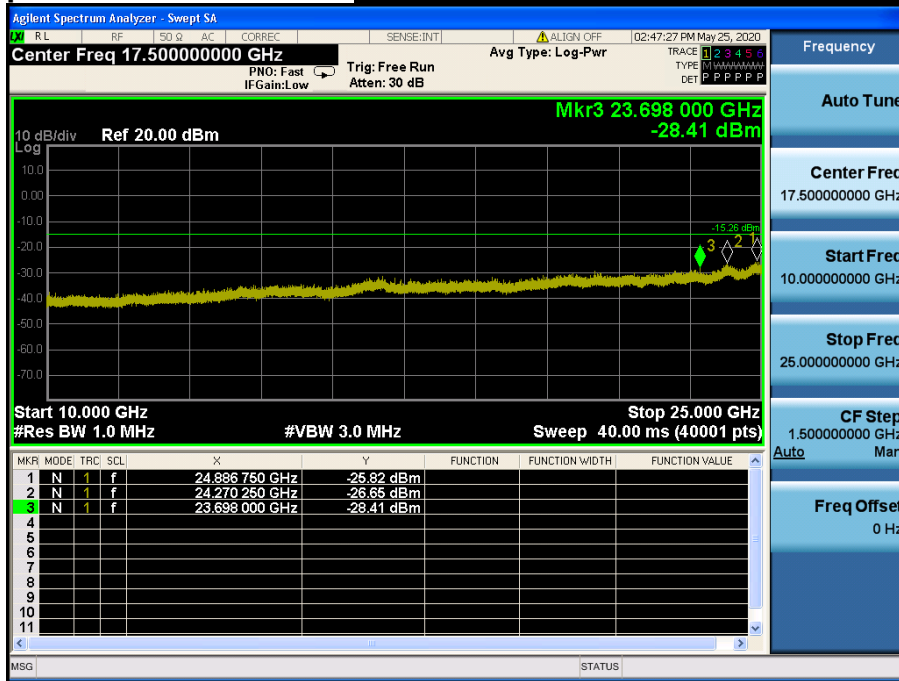



Low Band-edge

**Lowest Channel & Modulation :  $\pi/4$ DQPSK**

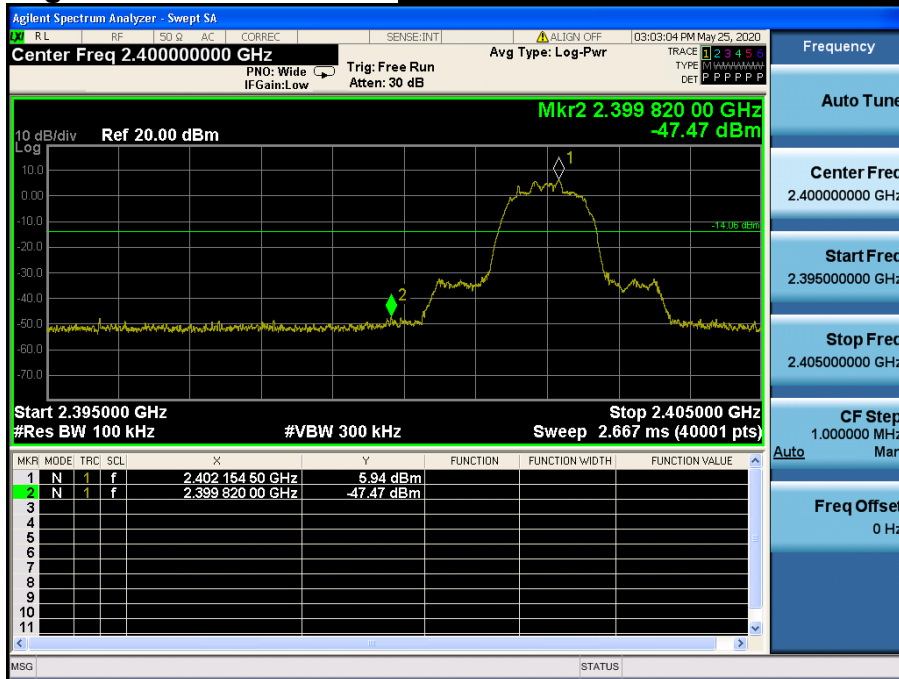

Low Band-edge

**Hopping mode & Modulation :  $\pi/4$ DQPSK**

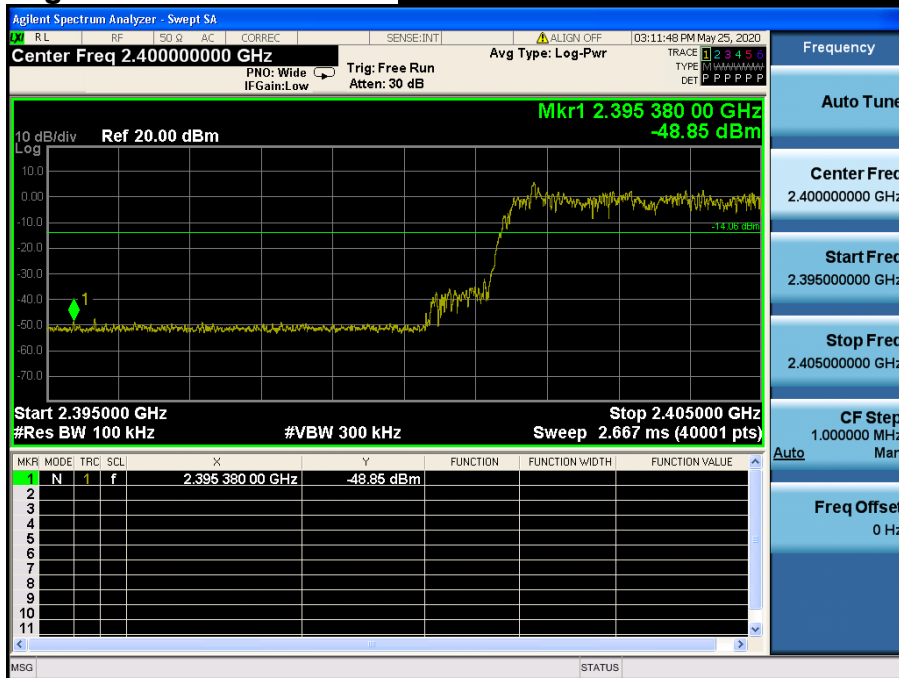

Conducted Spurious Emissions **Lowest Channel & Modulation :  $\pi/4$ DQPSK**

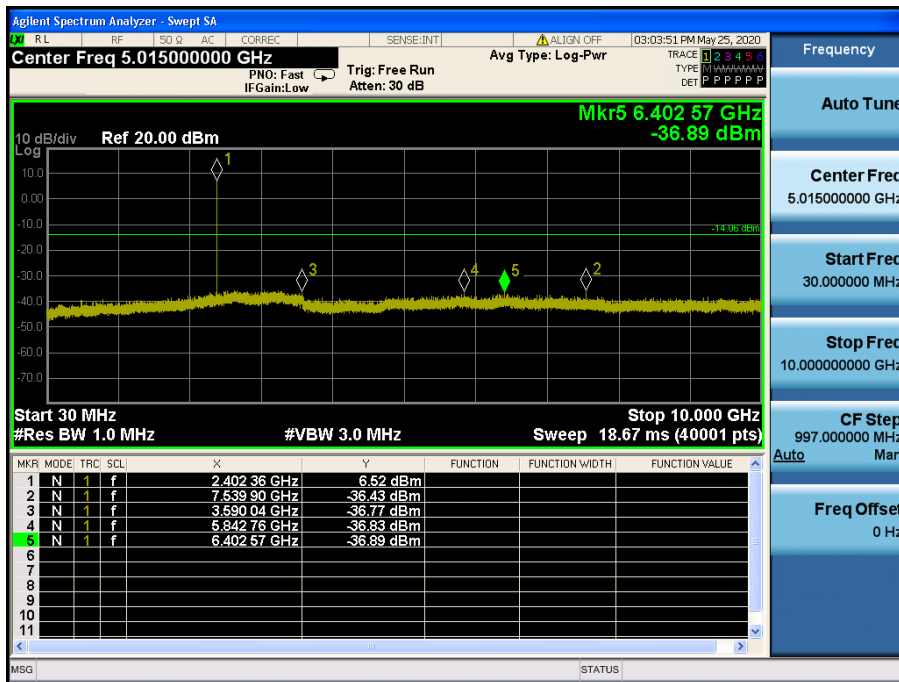
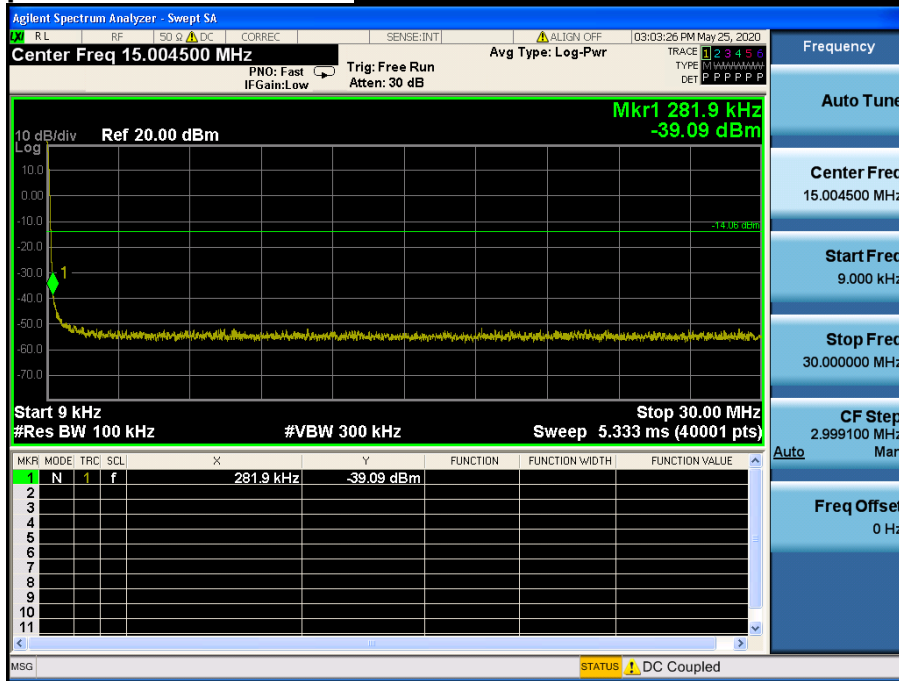

Conducted Spurious Emissions Lowest Channel & Modulation :  $\pi/4$ DQPSK

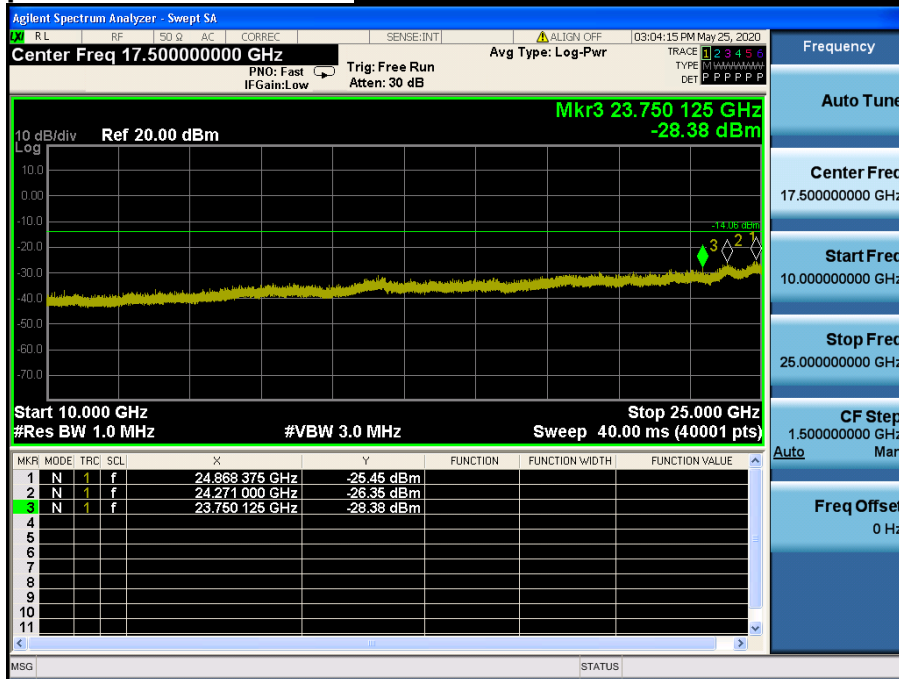

Reference for limit

Middle Channel & Modulation :  $\pi/4$ DQPSK

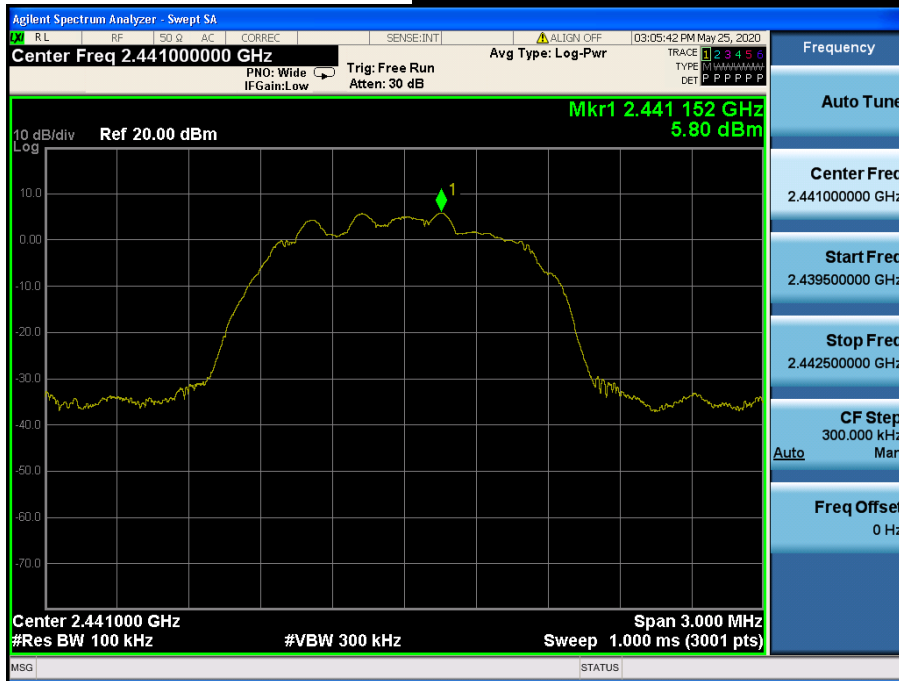

Conducted Spurious Emissions

Middle Channel & Modulation :  $\pi/4$ DQPSK

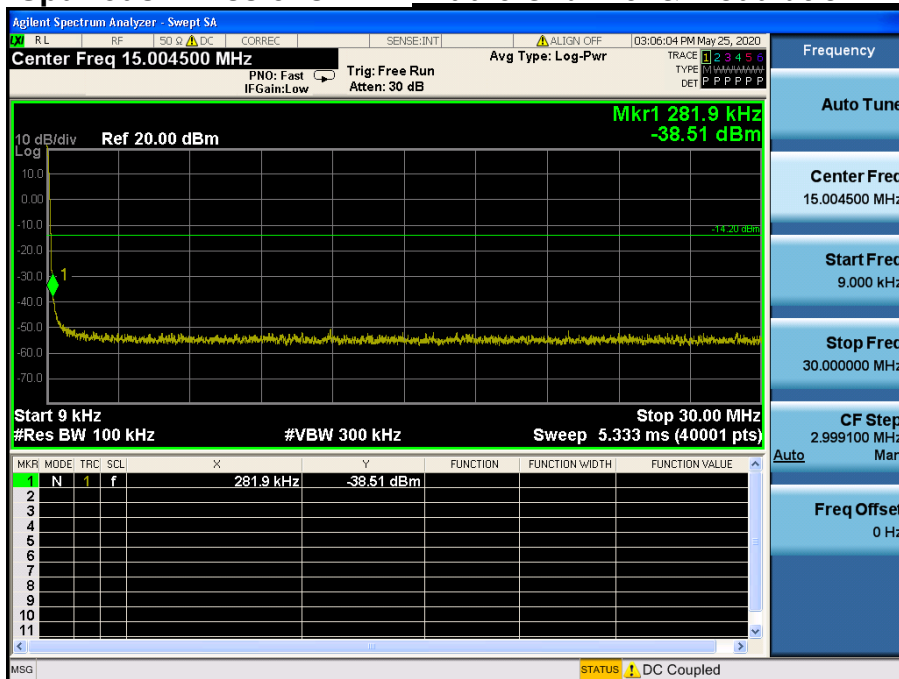

Conducted Spurious Emissions ***Middle Channel & Modulation :  $\pi/4$ DQPSK***

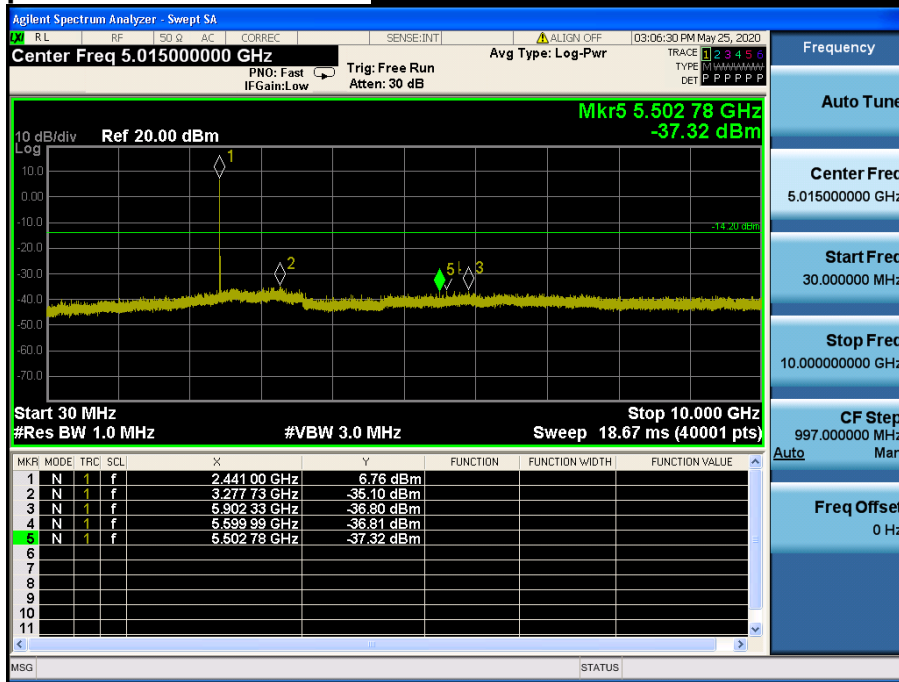

High Band-edge

**Highest Channel & Modulation :  $\pi/4$ DQPSK**

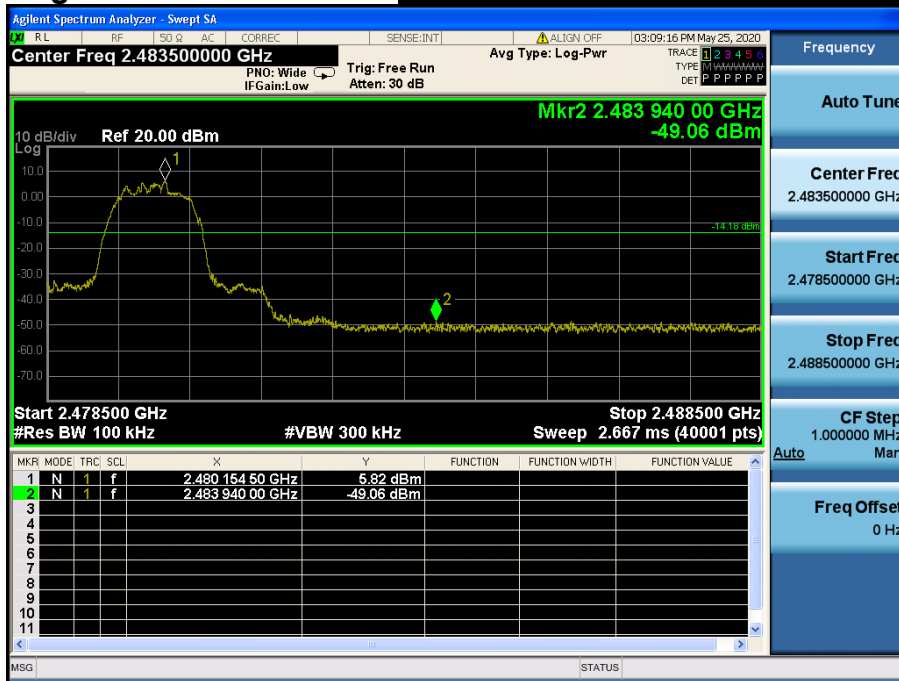

High Band-edge

**Hopping mode & Modulation :  $\pi/4$ DQPSK**

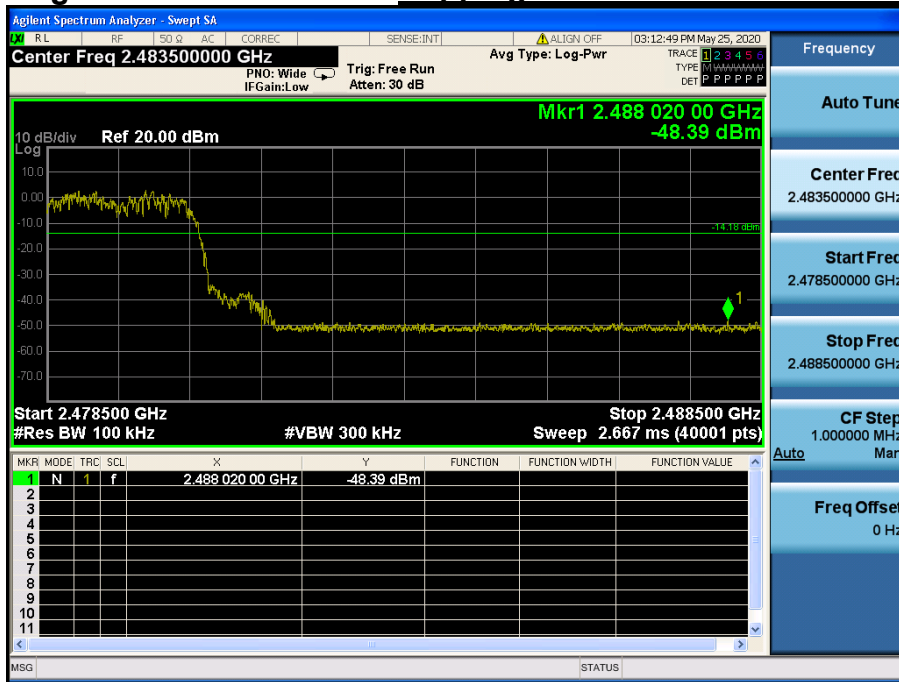

Conducted Spurious Emissions **Highest Channel & Modulation :  $\pi/4$ DQPSK**

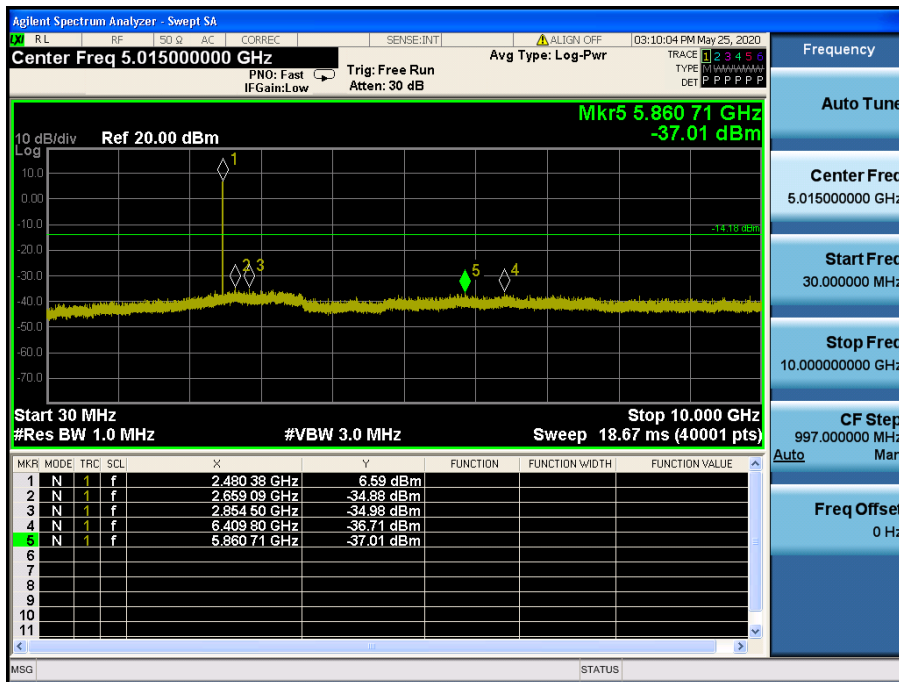
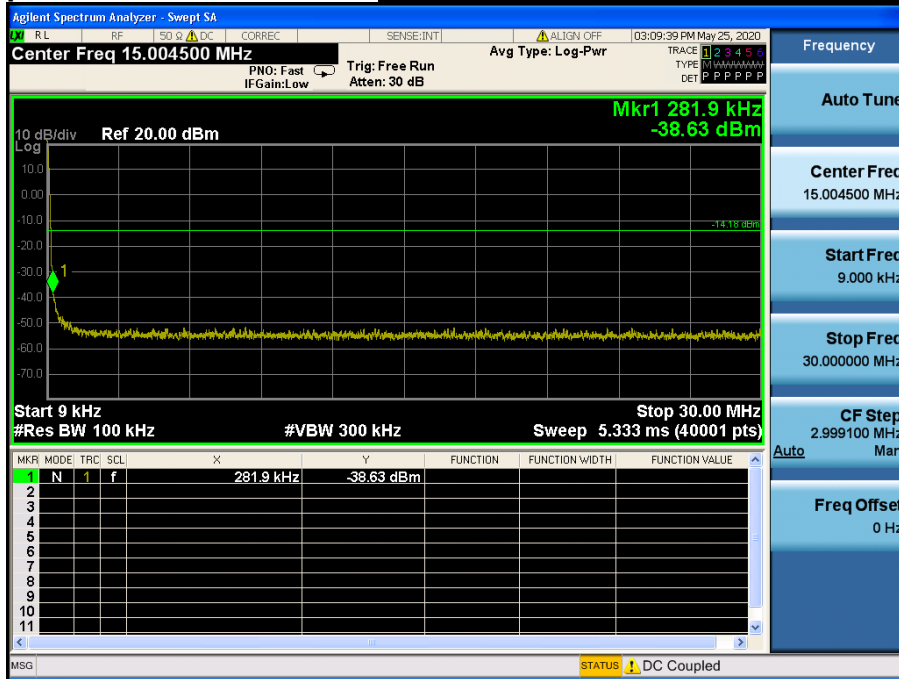

Conducted Spurious Emissions **Highest Channel & Modulation :  $\pi/4$ DQPSK**

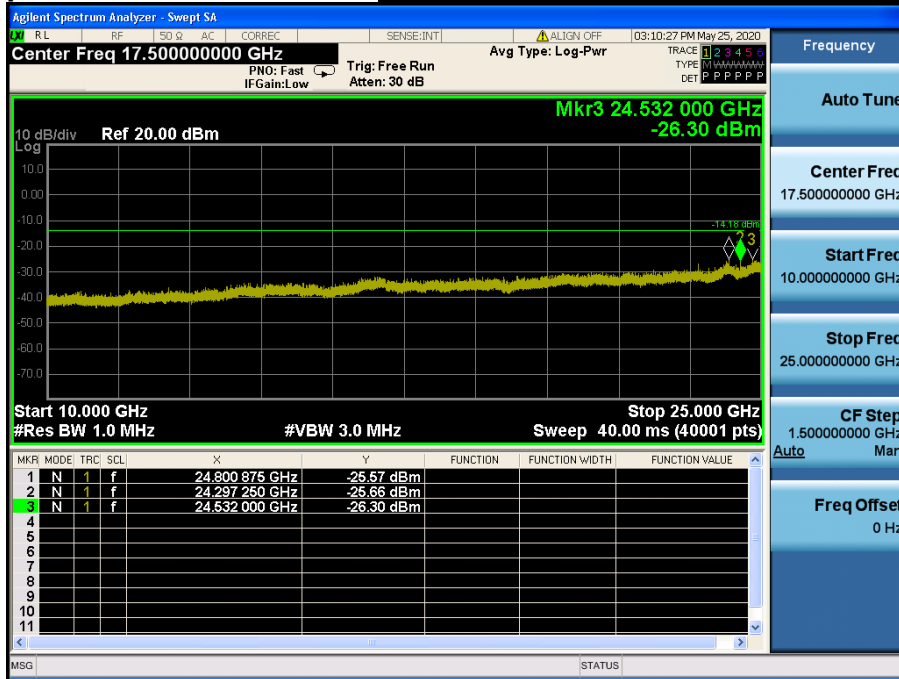



Low Band-edge

**Lowest Channel & Modulation : 8DPSK**

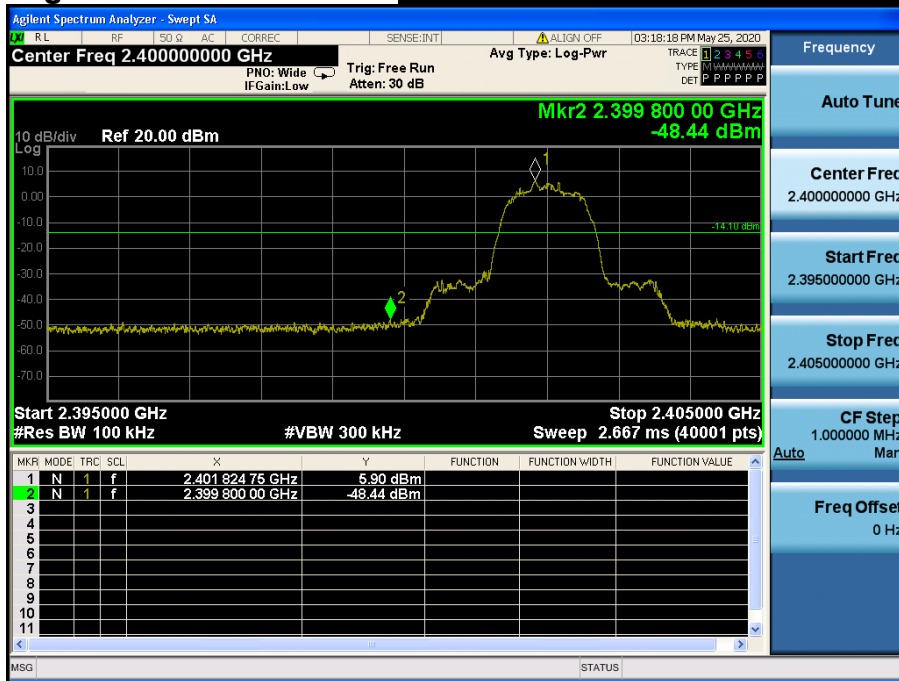

Low Band-edge

**Hopping mode & Modulation : 8DPSK**

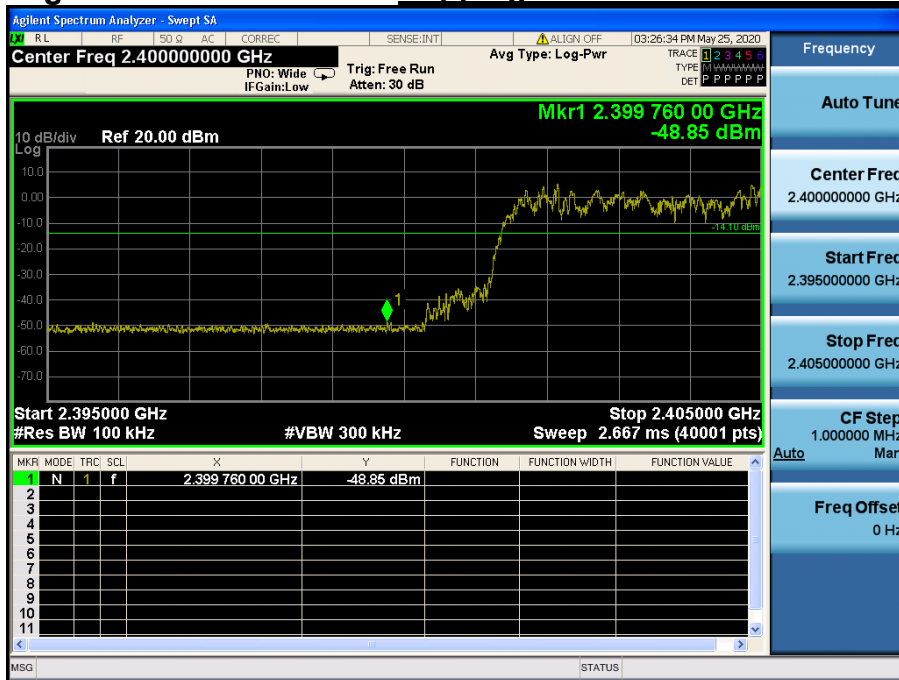

Conducted Spurious Emissions **Lowest Channel & Modulation : 8DPSK**

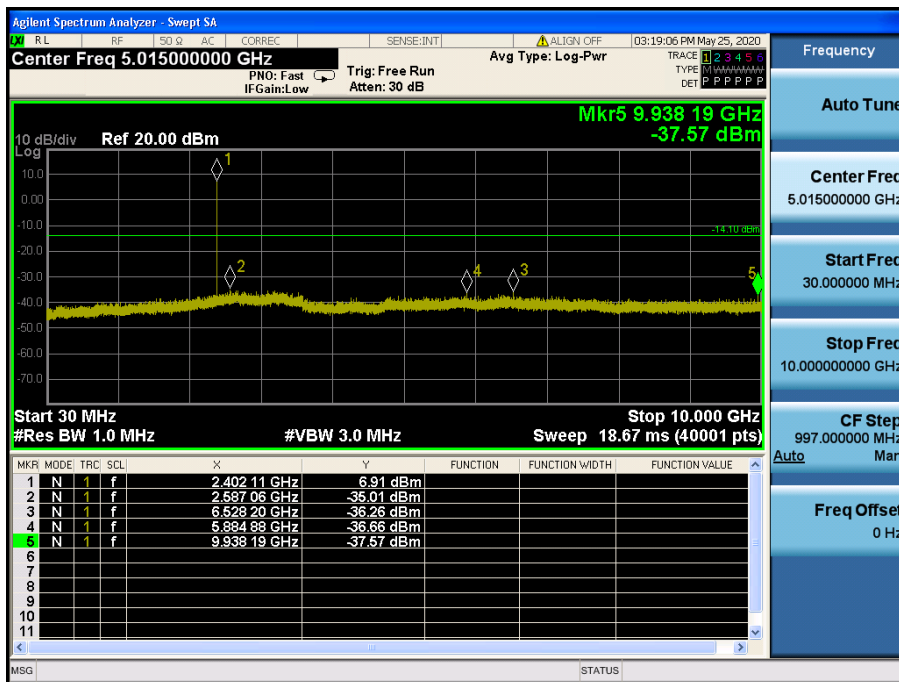
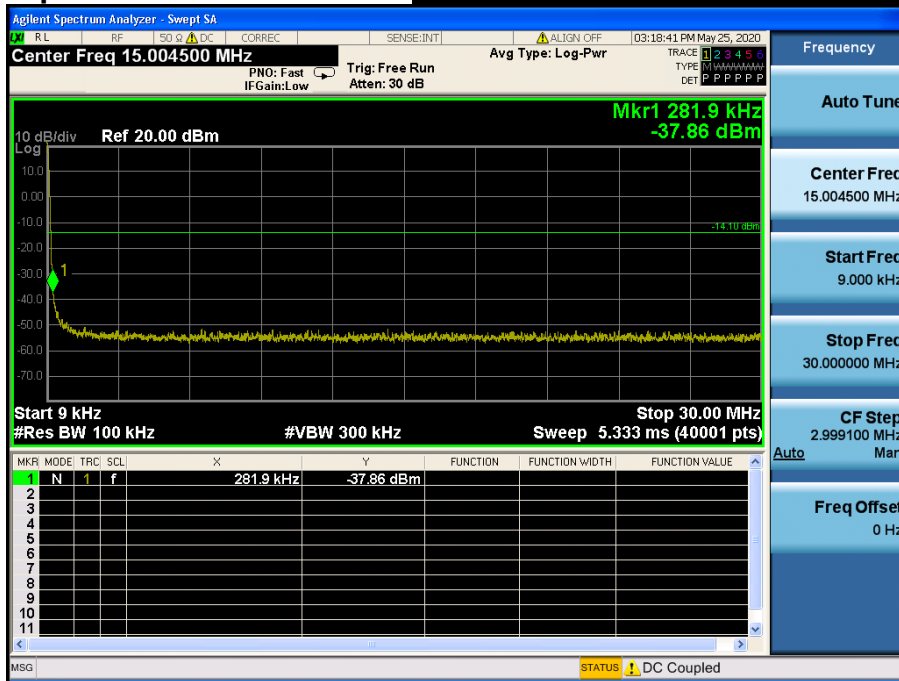

**Conducted Spurious Emissions**      **Lowest Channel & Modulation : 8DPSK**

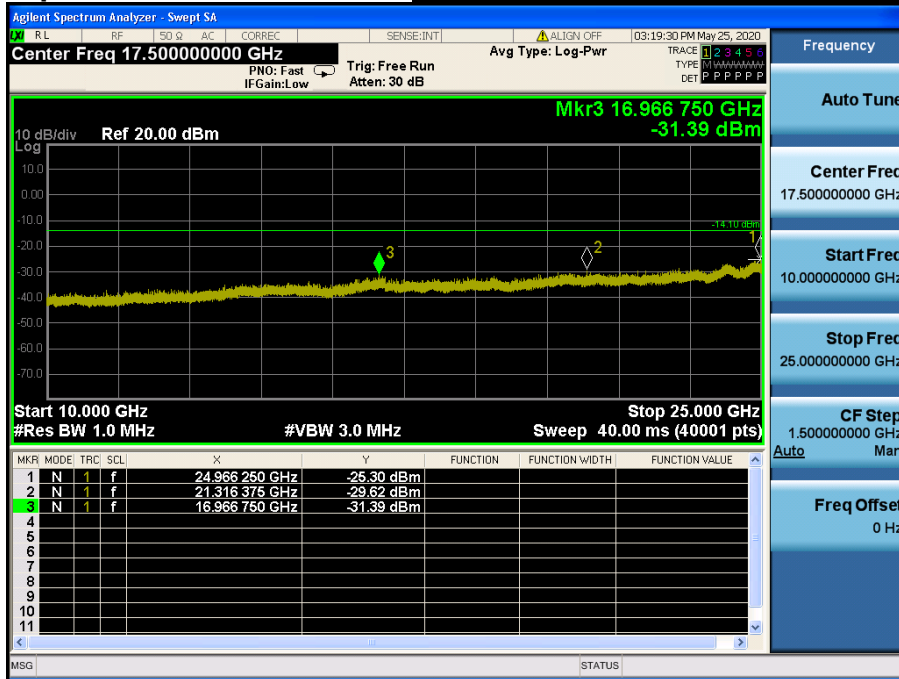

Reference for limit

**Middle Channel & Modulation : 8DPSK**

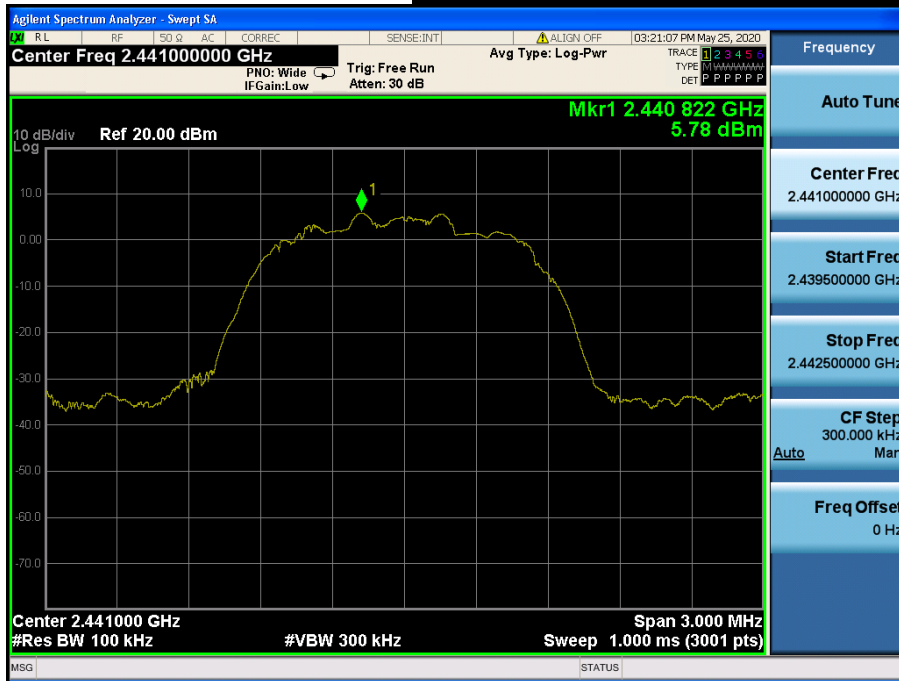

Conducted Spurious Emissions

**Middle Channel & Modulation : 8DPSK**

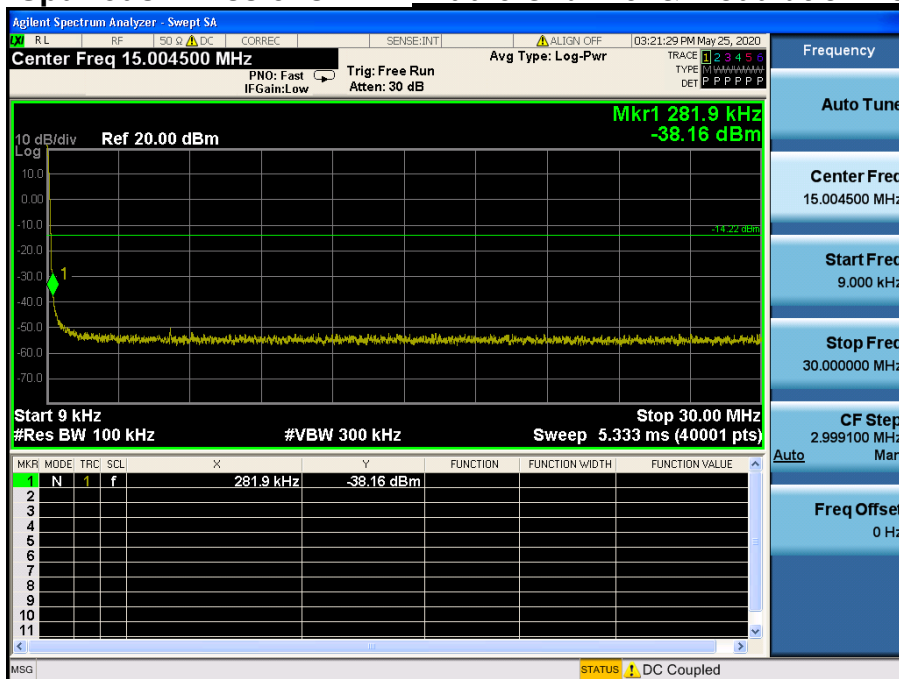

**Conducted Spurious Emissions Middle Channel & Modulation : 8DPSK**

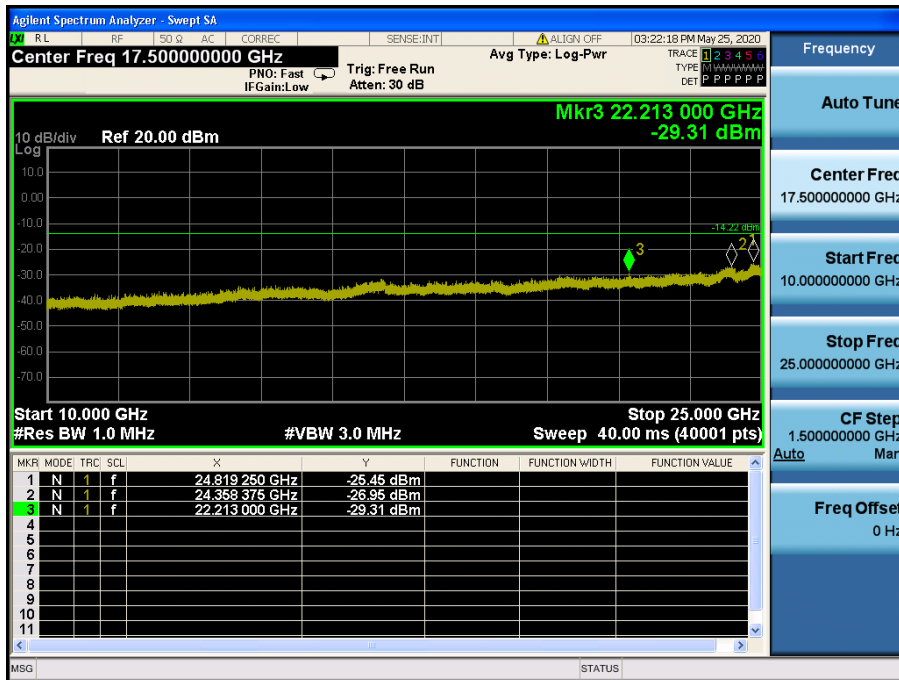
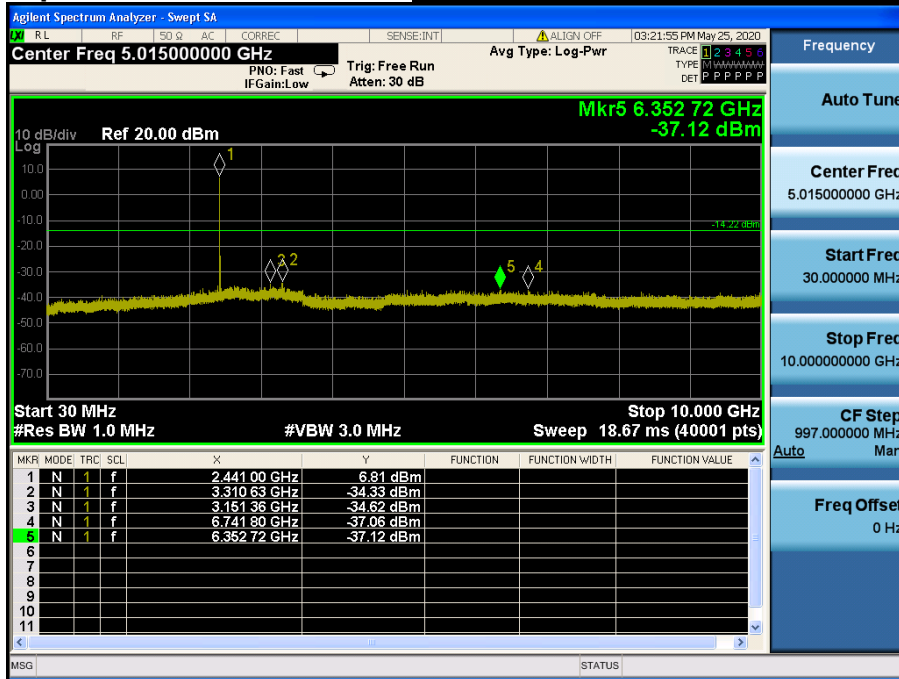

High Band-edge

**Highest Channel & Modulation : 8DPSK**

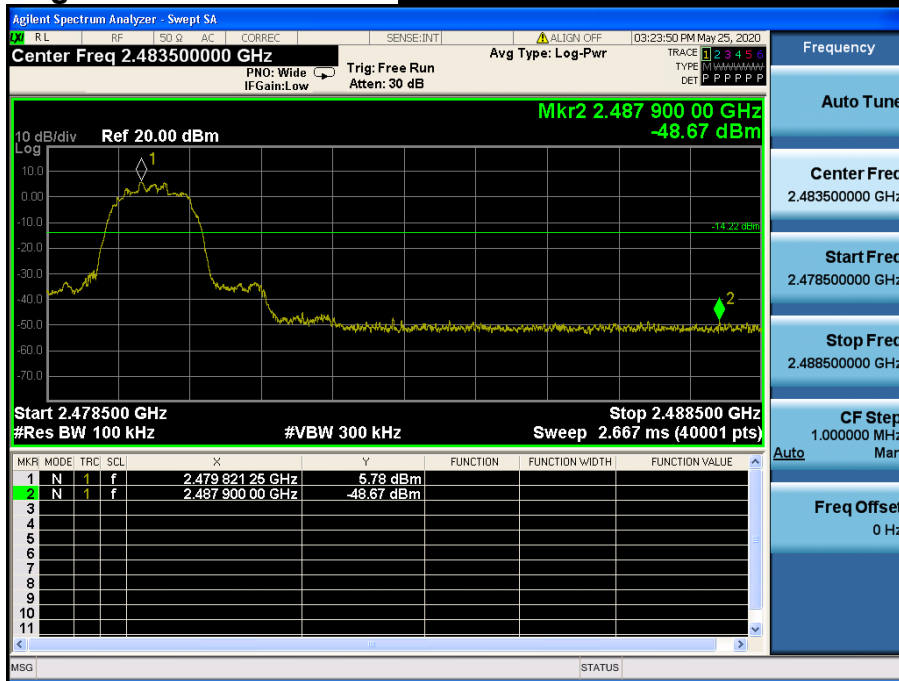

High Band-edge

**Hopping mode & Modulation : 8DPSK**

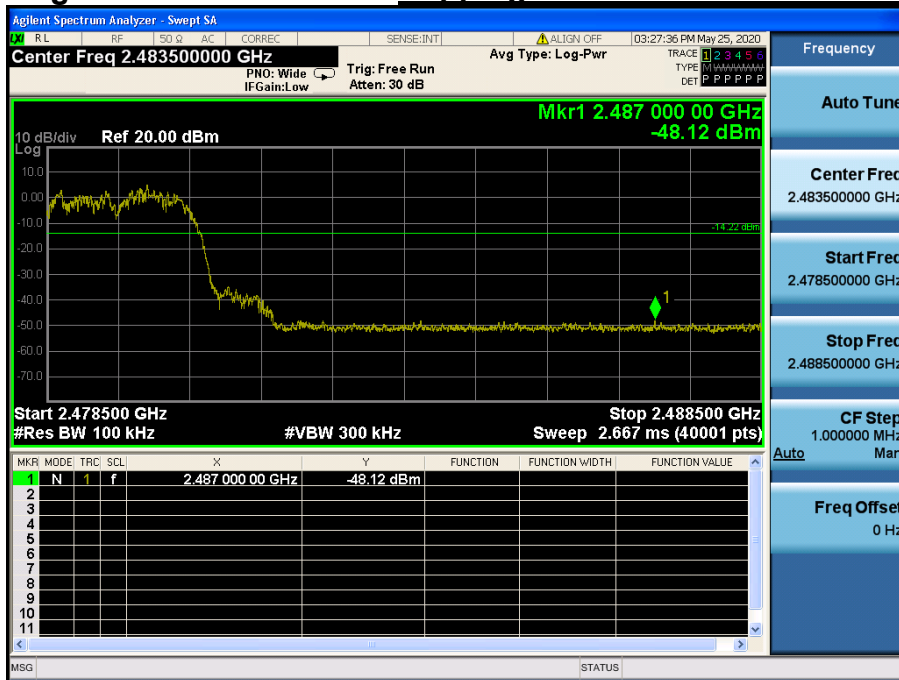

Conducted Spurious Emissions **Highest Channel & Modulation : 8DPSK**

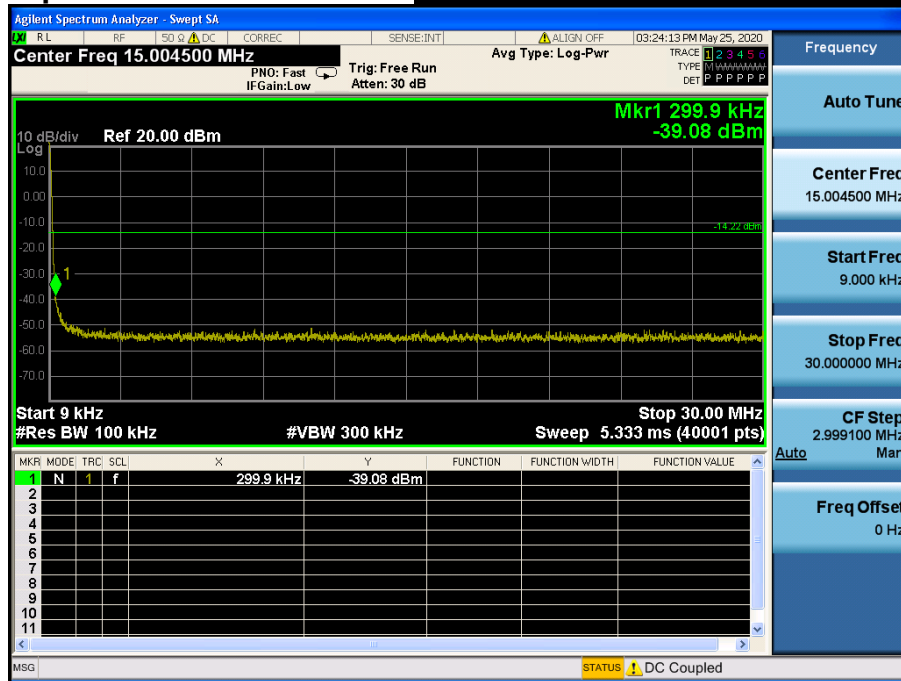

**Conducted Spurious Emissions Highest Channel & Modulation : 8DPSK**

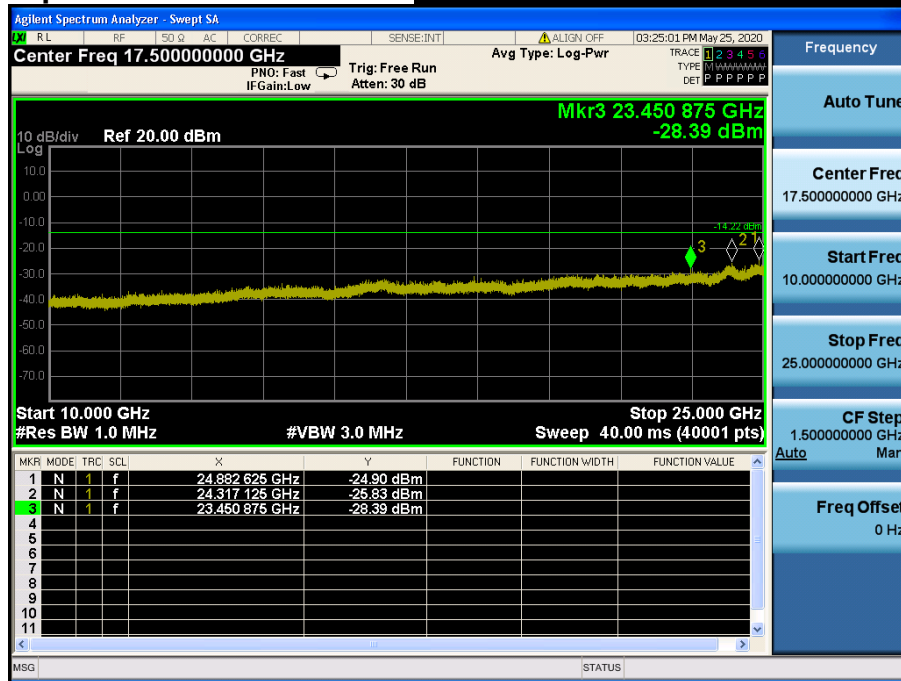



## 8. Transmitter AC Power Line Conducted Emission

### 8.1 Test Setup

- NA

### 8.2 Limit

According to §15.207(a) for an intentional radiator that is designed to be connected to the public utility (AC) power line, the radio frequency voltage that is conducted back onto the AC power line on any frequency or frequencies, within the band 150 kHz to 30 MHz, shall not exceed the limits in the following table, as measured using a 50 uH/50 ohm line impedance stabilization network (LISN).

Compliance with the provision of this paragraph shall on the measurement of the radio frequency voltage between each power line and ground at the power terminal. The lower applies at the boundary between the frequency ranges.

Frequency Range (MHz)	Conducted Limit (dBuV)	
	Quasi-Peak	Average
0.15 ~ 0.5	66 to 56 *	56 to 46 *
0.5 ~ 5	56	46
5 ~ 30	60	50

\* Decreases with the logarithm of the frequency

### 8.3 Test Procedures

Conducted emissions from the EUT were measured according to the ANSI C63.10.

1. The test procedure is performed in a 6.5 m × 3.5 m × 3.5 m (L × W × H) shielded room. The EUT along with its peripherals were placed on a 1.0 m (W) × 1.5 m (L) and 0.8 m in height wooden table and the EUT was adjusted to maintain a 0.4 meter space from a vertical reference plane.
2. The EUT was connected to power mains through a line impedance stabilization network (LISN) which provides 50 ohm coupling impedance for measuring instrument and the chassis ground was bounded to the horizontal ground plane of shielded room.
3. All peripherals were connected to the second LISN and the chassis ground also bounded to the horizontal ground plane of shielded room.
4. The excess power cable between the EUT and the LISN was bundled. The power cables of peripherals were unbundled. All connecting cables of EUT and peripherals were moved to find the maximum emission.

### 8.4 Test Results

- NA

## 9. Antenna Requirement

Describe how the EUT complies with the requirement that either its antenna is permanently attached, or that it employs a unique antenna connector, for every antenna proposed for use with the EUT.

**Conclusion: Comply**

**The antenna type is a SMD antenna. The antenna is attached permanently using soldering.  
(Refer to Internal Photo file.)**

**Therefore this E.U.T Complies with the requirement of §15.203**

### - Minimum Standard :

An intentional radiator shall be designed to ensure that no antenna other than that furnished by the responsible party shall be used with the device. The use of a permanently attached antenna or of an antenna that uses a unique coupling to the intentional radiator shall be considered sufficient to comply with the provisions.
--

**APPENDIX I**

**Test set up diagrams**

**▪ Radiated Measurement**

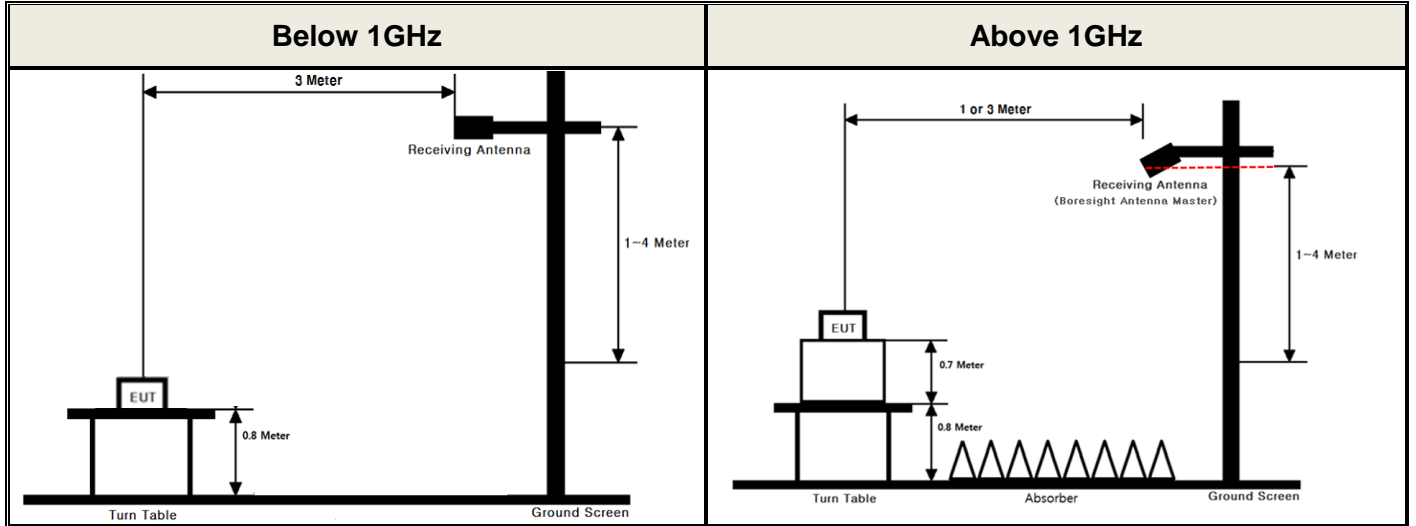

**▪ Conducted Measurement**

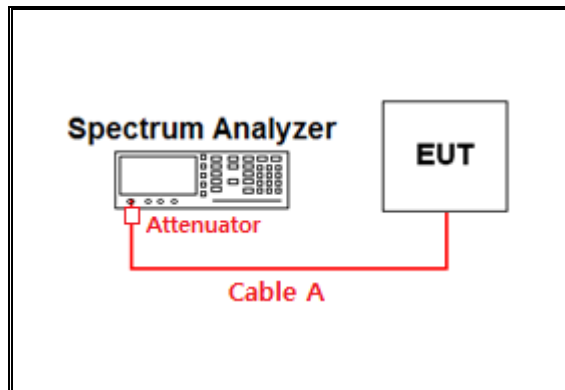

**Path loss information**

Frequency (GHz)	Path Loss (dB)	Frequency (GHz)	Path Loss (dB)
0.03	9.63	15	11.10
1	9.91	20	12.53
2 402 & 2 440 & 2 480	10.56	25	13.01
5	10.72	-	-
10	10.82	-	-

Note 1 : The path loss from EUT to Spectrum analyzer were measured and used for test.

Path loss ( S/A's Correction factor) = Cable A + Power splitter

## APPENDIX II

### Unwanted Emissions (Radiated) Test Plot

- Tested Power Supply: 12 V

GFSK & Lowest & X & Hor

Detector Mode : PK

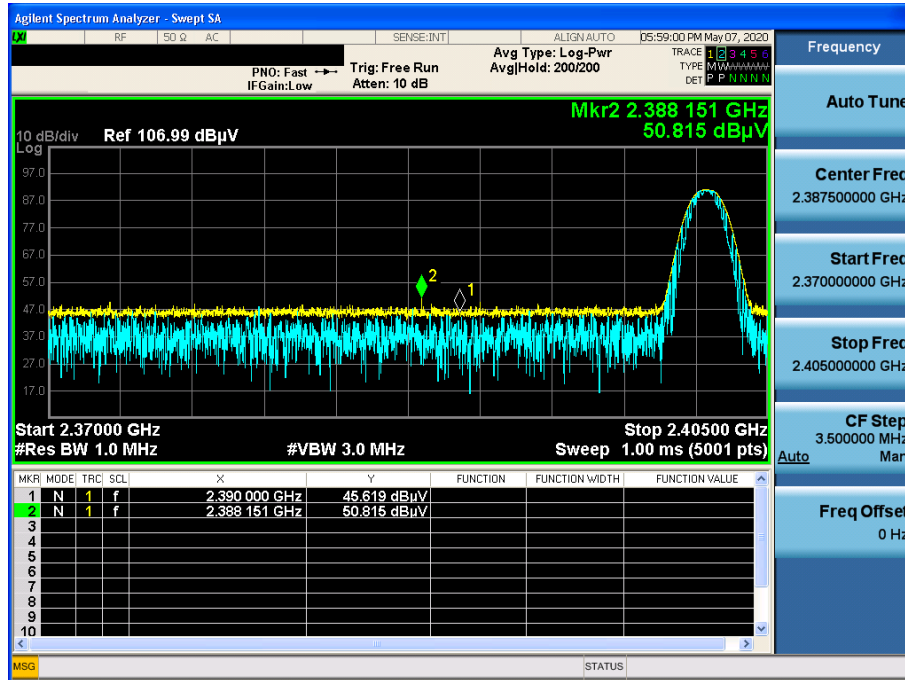

GFSK & Highest & X & Hor

Detector Mode : PK

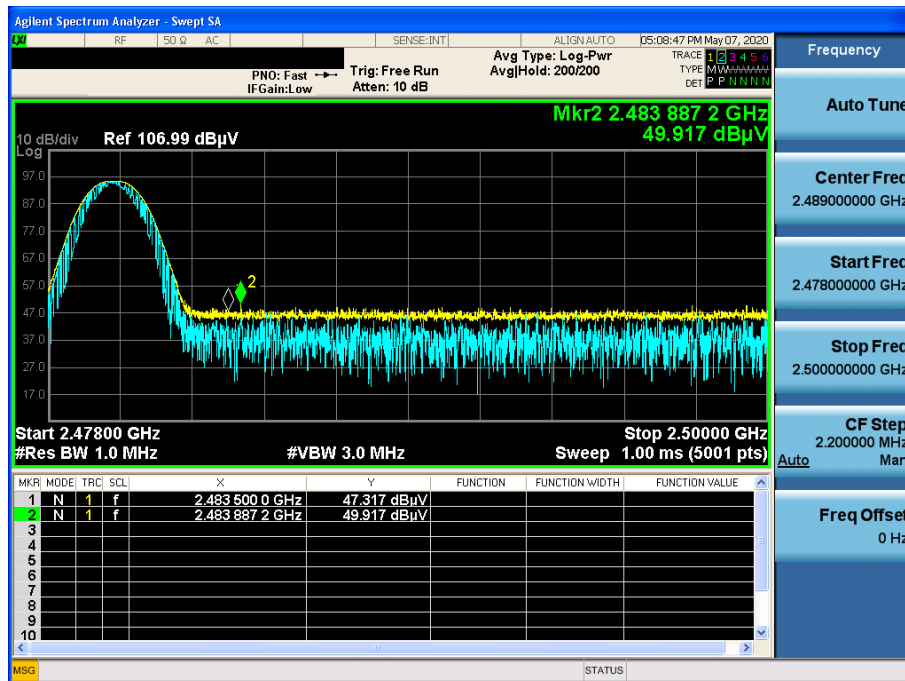

$\pi/4$ DQPSK & Lowest & X & Hor

Detector Mode : PK

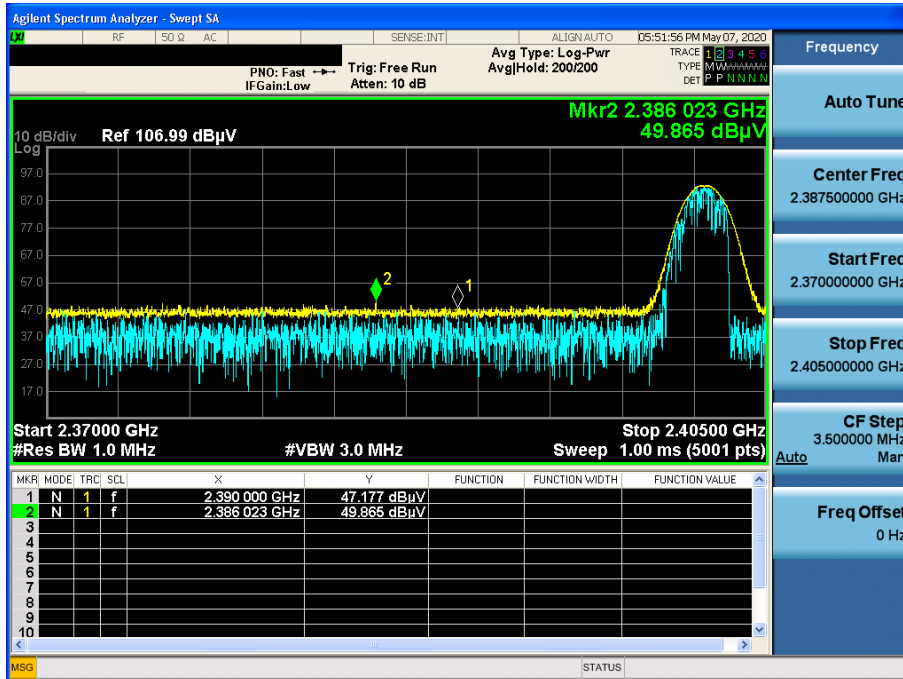

$\pi/4$ DQPSK & Highest & X & Hor

Detector Mode : PK

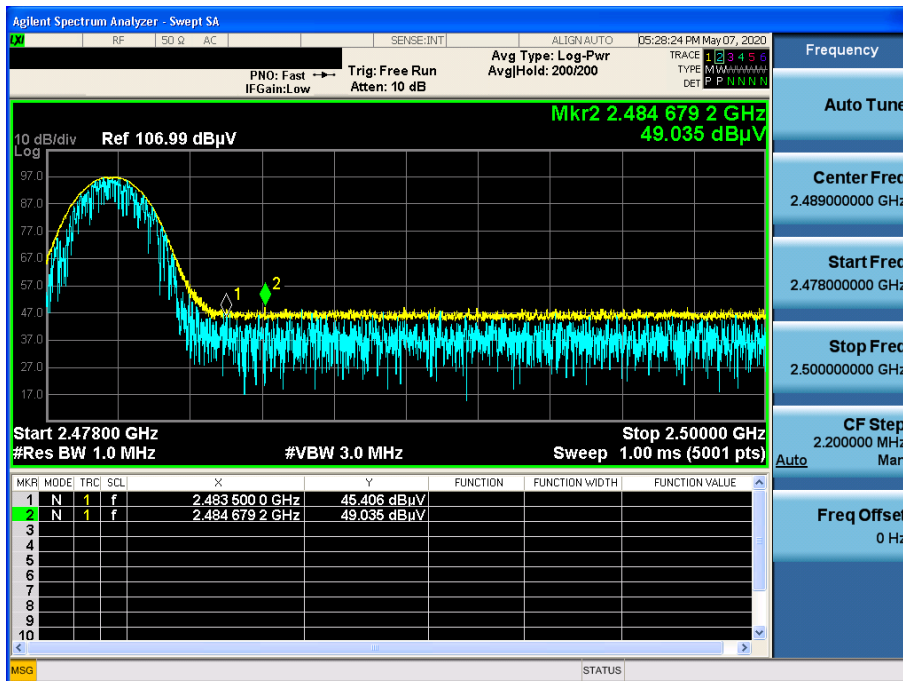

8DPSK & Lowest & X & Hor

Detector Mode : PK

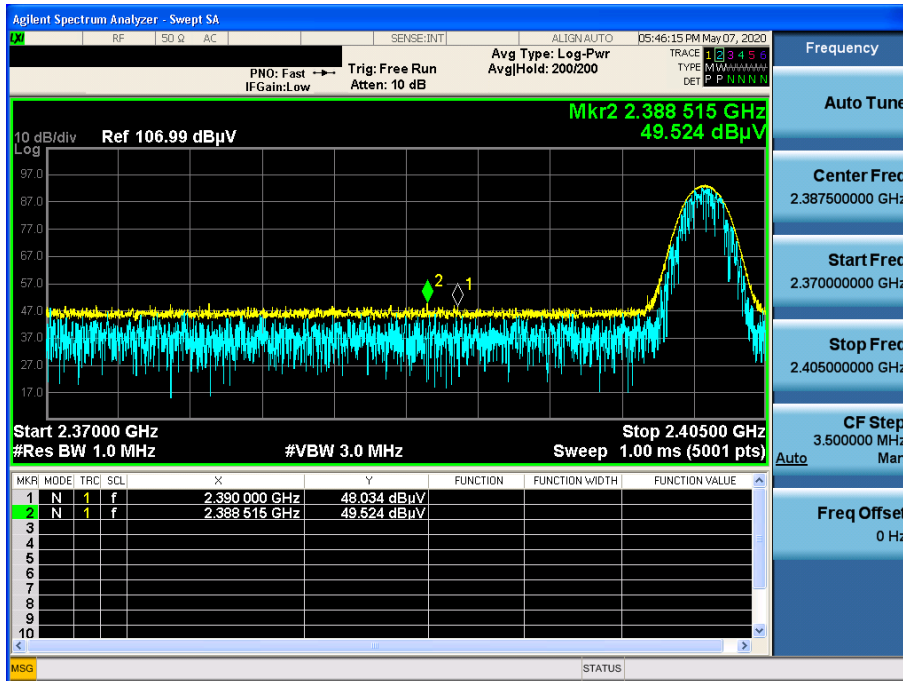

8DPSK & Highest & X & Hor

Detector Mode : PK

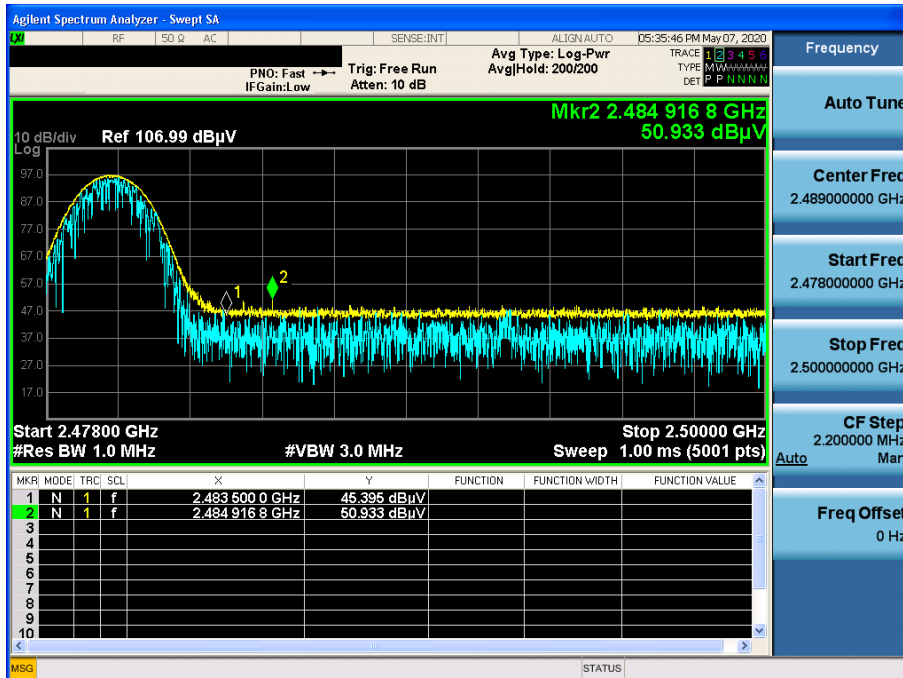

GFSK & Highest & X & Ver

Detector Mode : PK

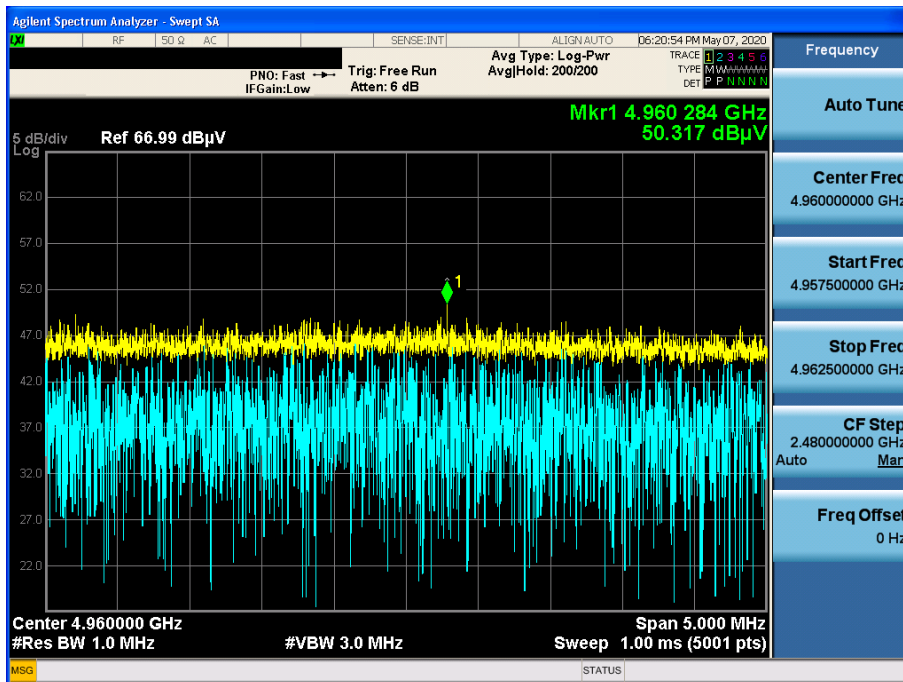

$\pi/4$ DQPSK & Middle & X & Ver

Detector Mode : PK

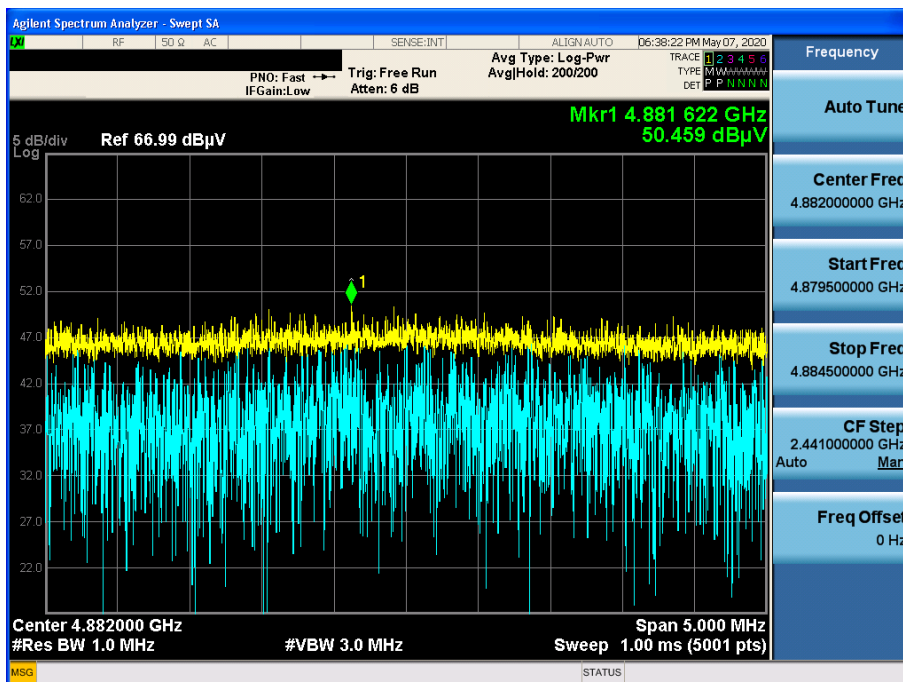

8DPSK & Middle & X & Ver

Detector Mode : PK

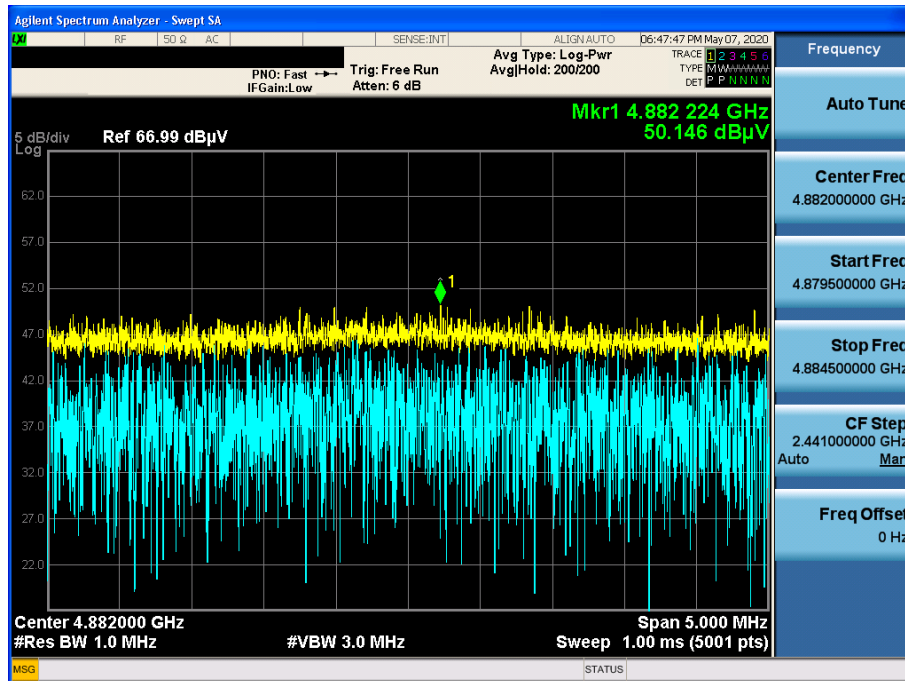



- Tested Power Supply: 24 V

GFSK & Lowest & X & Hor

Detector Mode : PK

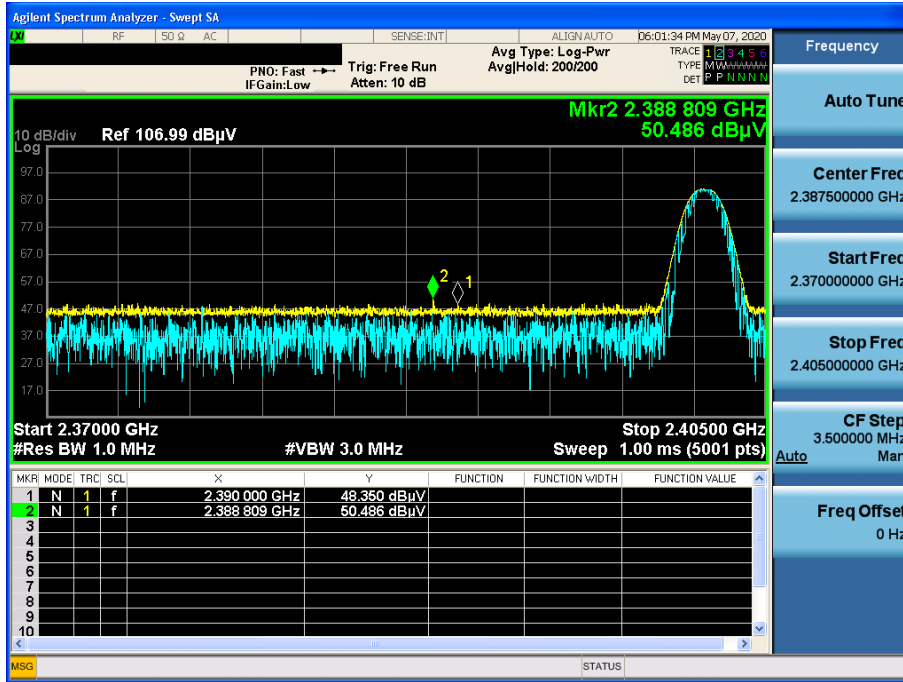

GFSK & Highest & X & Hor

Detector Mode : PK

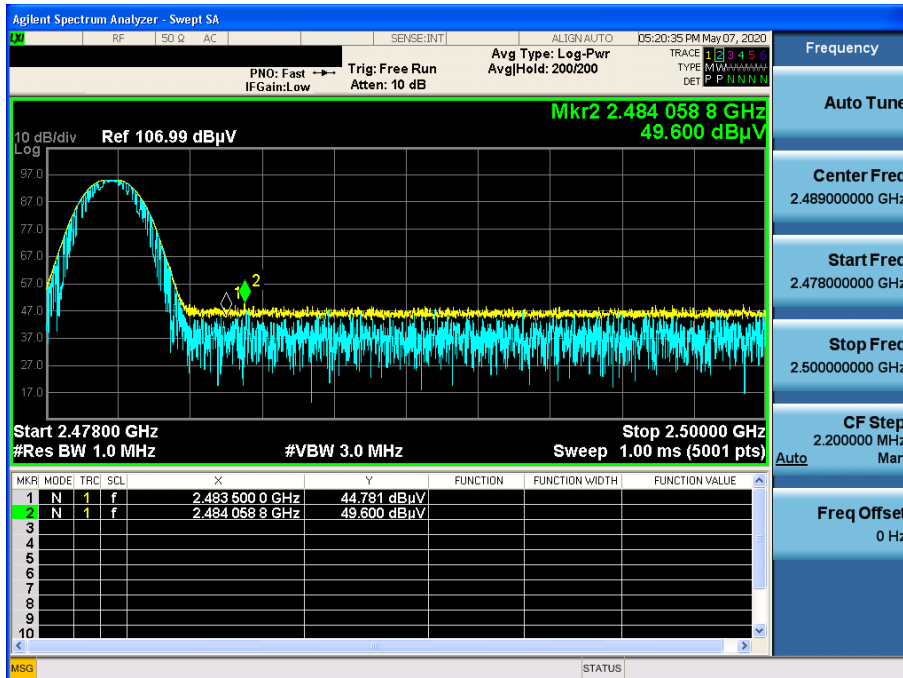

$\pi/4$ DQPSK & Lowest & X & Hor

Detector Mode : PK

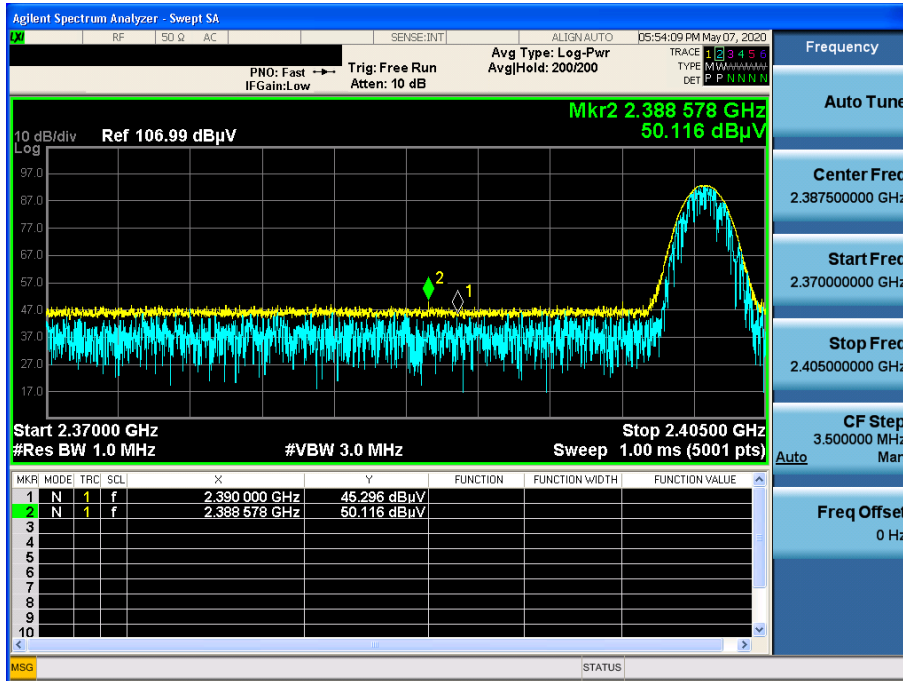

$\pi/4$ DQPSK & Highest & X & Hor

Detector Mode : PK

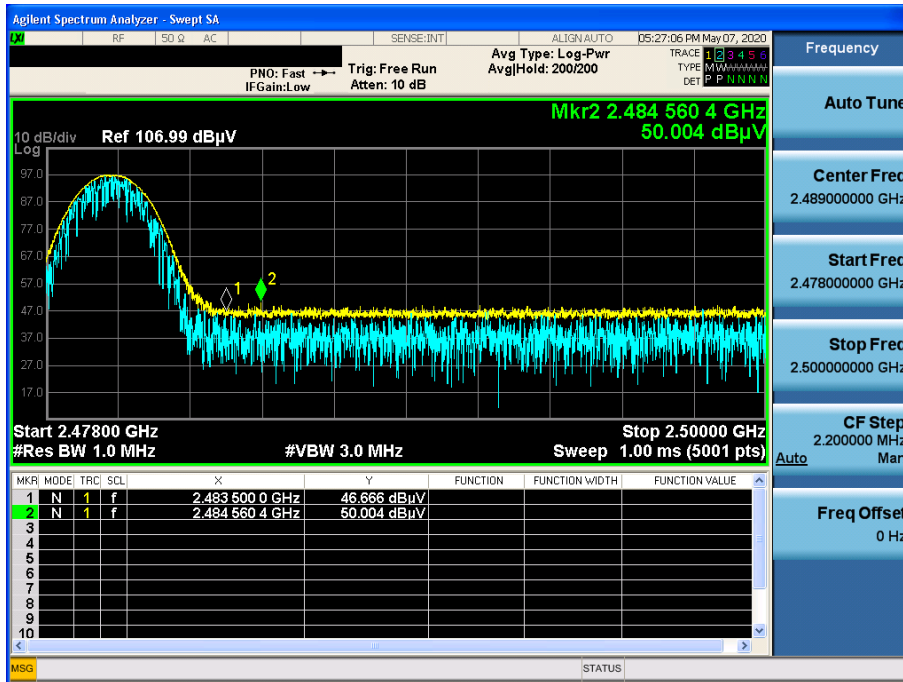

8DPSK & Lowest & X & Hor

Detector Mode : PK

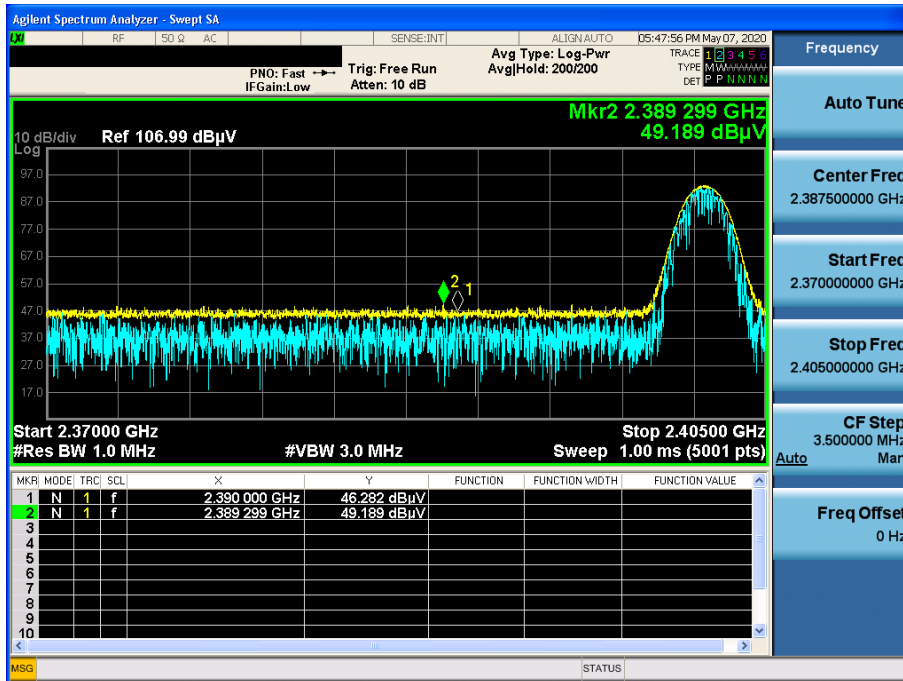

8DPSK & Highest & X & Hor

Detector Mode : PK

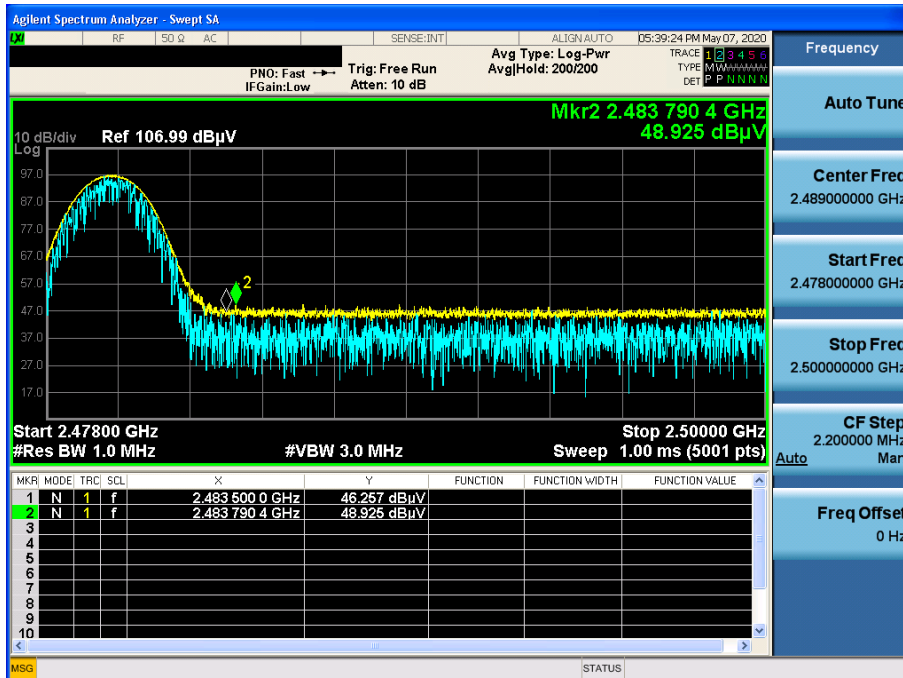

GFSK & Lowest & X & Ver

Detector Mode : PK

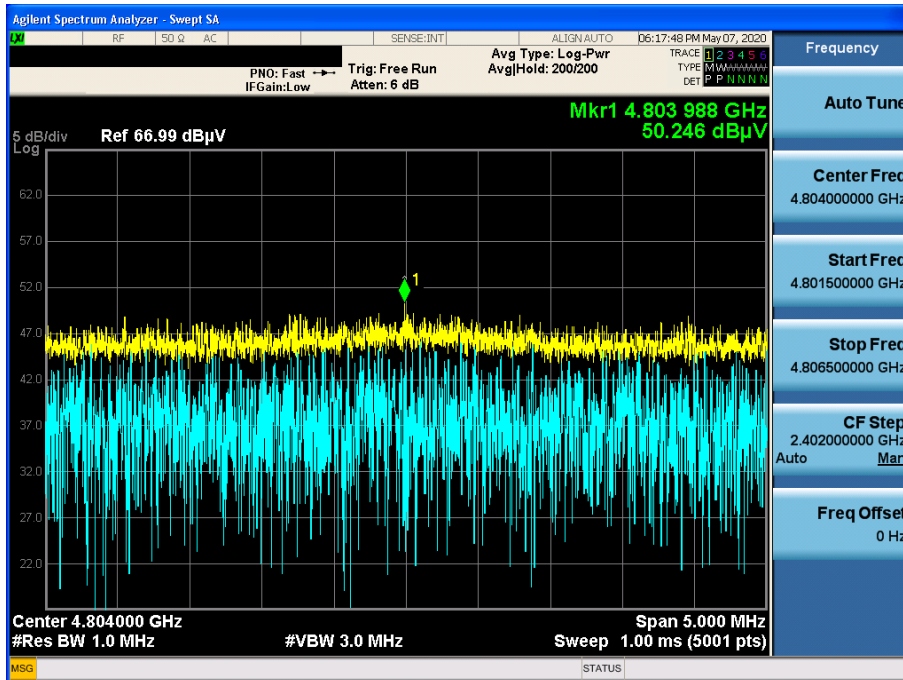

$\pi/4$ DQPSK & Middle & X & Ver

Detector Mode : PK

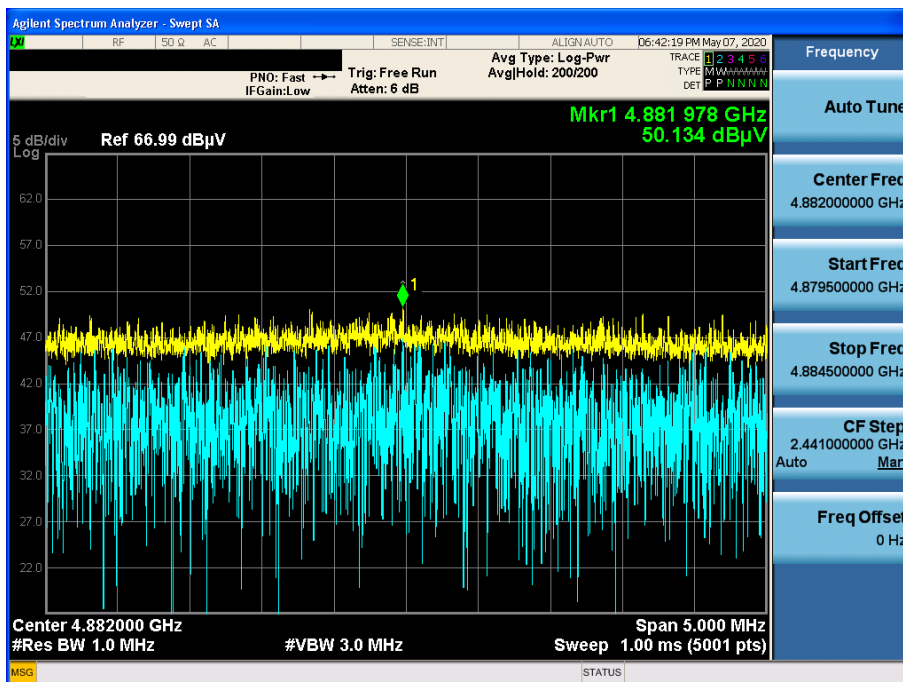

8DPSK & Middle & X & Ver

Detector Mode : PK

