



BLACKVUE™
Over the Cloud

DR750-2CH LTE
Manual



ENGLISH

www.blackvue.com

Table of Contents

Introduction	5
Important safety information	6
Overview	9
In the box.....	9
At a glance.....	10
Front camera	10
Removing and inserting the front camera	13
Rear camera.....	14
Removing and inserting the rear camera.....	14
Installation	15
Installing the BlackVue dashcam	15
Playing and Managing Videos	19
Playing and managing video files using your smartphone (Android/iOS)	19
Opening video files.....	19
BLACKVUE WI-FI screen composition.....	21
Playing video	22
Playing back videos	22
Identify video files by recording type	22
Checking the displayed time & GPS data	24
Real-time streaming video (Live View)	25
Managing videos	26
Managing videos in BLACKVUE WI-FI	26
Copy to Internal Memory	26
Managing videos in INTERNAL MEMORY	27
Deleting videos	28
Creating a new folder	28
Copying and pasting videos	28
Moving videos	29
Renaming a video	29
Uploading, sharing or emailing a video	29

Playing and managing video files using your computer (Windows/Mac)	30
Removing the microSD card	30
Opening video files in BlackVue Viewer	31
Viewer screen composition	32
Windows Viewer	32
Mac Viewer	33
Playing video	34
Playing back videos	34
Identify video files by recording type	34
Checking the displayed time	36
Using BlackVue Viewer.....	36
Exploring the timeline and G-Sensor graph	37
Zoom options	38
Checking the GPS data.....	39
Managing videos	40
Capturing or printing a still image from video.....	40
Deleting videos	40
For Windows users	40
For Mac users	41
Exporting videos	42
For Windows users	42
Copying videos.....	43
For Windows users	43
For Mac users	44
Tips for optimal performance	45
Formatting the microSD card	45
Formatting the card in the BlackVue.....	45
Format using BlackVue Viewer (Windows).....	45
Format using BlackVue Viewer (macOS).....	46
Upgrading the firmware	48
Upgrading the firmware using an iOS or Android device (Firmware Over The Air)	48
Upgrading the firmware using a computer (Windows or macOS)	54

Changing settings56

Changing settings using your smartphone (Android/iOS).. 56

Basic settings57

Time settings..... 58

Video settings 60

Image quality 60

Enhanced night vision..... 61

Brightness (Front) 61

Brightness (Rear) 61

Recording settings 62

Normal recording..... 62

Parking mode recording 62

Rear camera recording in parking mode..... 63

Voice recording..... 63

Date & time display..... 63

Speed unit 63

Lock event files 63

Front camera rotation 63

Rear camera orientation 63

Sensitivity settings64

G-Sensor (Normal mode)/G-Sensor (Parking mode)..... 65

Motion detection (Parking mode) 66

System settings67

LED 67

Recording status 67

Front security (Normal mode) 67

Front security (Parking mode)..... 67

Rear security 68

LTE/Wi-Fi 68

Proximity Sensor 68

Voice guidance 68

Impact detected in parking mode 68

Volume 68

Scheduled Reboot..... 69

Speed alert 69

User text overlay 69

LTE/Wi-Fi70

Wi-Fi login credentials..... 70

Wi-Fi auto turn off 70

Cloud settings.....71

Push notification settings..... 72

FW Language73

Changing settings using your computer (Windows/Mac) ... 74

BlackVue Viewer settings.....75

Select language..... 75

Speed unit on map..... 75

Select map service 75

Picture-in-picture(PIP)playback 75

Firmware settings76

Basic settings 77

Time settings..... 77

Video settings 78

Recording settings 78

Sensitivity settings 81

G-Sensor (Normal mode)/G-Sensor (Parking mode)..... 81

Motion detection (Parking mode) 82

Advanced sensitivity settings for normal and parking mode 82

Advanced motion detection settings (Region selection)..... 84

System settings 85

LED 85

Proximity Sensor 86

Voice guidance 86

Volume 87

Scheduled Reboot..... 87

Speed alert 87

User text overlay 87

LTE/Wi-Fi settings 88

Wi-Fi login credentials..... 88

Wi-Fi auto turn off 88

LTE Setting 88

Cloud settings..... 89

Push notification settings..... 89

Applying the settings 90

Setting up Cloud Service.....	91
Connect to BLACKVUE CLOUD	91
Activate the SIM card	93
Optional accessories	96
Parking mode kit (Optional)	96
Parking mode battery (Optional)	97
Power Magic Battery (B-112)	97
Power Magic Ultra Battery (B-124X).....	98
Troubleshooting	99
Changing/resetting direct Wi-Fi SSID and password	99
Change Wi-Fi SSID and password over the Cloud.....	99
Change the Wi-Fi password using BlackVue Viewer (Windows or Mac)	102
Product specifications.....	103
Recording time	105
Disposal and recycling information	107

Introduction

Thank you for purchasing this BlackVue dashcam made by Pittasoft Co., Ltd.

This instruction manual contains information on how to operate your dashcam.

Before using your dashcam, we recommend that you read through this manual to ensure correct usage.

To improve the performance of the product, the contents of this manual are subject to change without prior notice.

 **Note**

- A formatted microSD card is provided with the BlackVue dashcam when you purchase the product. Insert the microSD card in the dashcam and power it up. The microSD card will be initialized.

Important safety information

For user safety and to avoid property damage, read through this manual and follow these safety instructions to use the product correctly.



DANGER

Failure to observe the following directions could result in death or property damage:

- **Do not disassemble, repair, or modify the product yourself.**
Doing so may cause fire, electric shock, or malfunction. For internal inspection and repair, contact the service center.
- **If any foreign matter gets inside the product, detach the power cord immediately.**
Contact the service center for repair.
- **Do not adjust the product while driving.**
Doing so may cause an accident. Stop or park your car in a safe place before installing and setting up the product.
- **Do not install the product in a location where the product can interfere with the driver's field of vision.**
Doing so may cause an accident.
- **Do not use a damaged or modified power cord. Only use the cords provided by the manufacturer.**
Damaged or modified power cords may cause an explosion, fire, or malfunction.
- **Do not operate the product with wet hands.**
Doing so may cause electric shock.
- **Do not install the product in an environment with high humidity, or combustible gases or liquids.**
Doing so may cause an explosion and/or fire.



WARNING Failure to observe the following directions could result in death or serious injury:

- **Do not leave the product near infants, children, or pets.**

There is a risk of them swallowing small components, and/or their saliva may get into the product, causing an explosion due to a short circuit.

- **Do not spray water or wax directly onto the product while cleaning the inside of the car.**

Doing so may cause fire, electric shock, or malfunction.

- **If smoke or an unusual smell is emitted from the power cord, detach the power cord immediately.**

Contact the service center or your distributor.

- **Keep the terminals of the power cord clean.**

Failure to do so may cause excessive heat and fire.

- **Use the correct input voltage.**

Failure to do so may cause explosion, fire, or malfunction.

- **Plug in the power cord firmly so that it cannot easily be disconnected.**

Failure to do so may cause fire.

- **Do not cover the product with any material.**

Doing so may cause external deformation of the product or fire. Use the product and peripherals in a well-ventilated location.

**CAUTION**







Failure to observe the following directions could result in injury or property damage:

- **Do not spray cleaning products directly onto the product.**
Doing so may cause discoloration, cracks, or malfunction.
- **If the product is used outside the optimal temperature range (-20°C – 70°C/-4°F – 158°F), performance can decline or malfunctions may occur.**
- **Make sure that the product is installed properly.**
If installed incorrectly, vibrations may cause the product to fall, and may cause physical injury.
- **When entering or exiting a tunnel, when directly facing into bright sunlight, or when recording at night without lighting the quality of recorded video may deteriorate.**
- **If the product is damaged or the power supply is cut due to an accident, video may not be recorded.**
- **Excessively tinted windshield glass can distort the recorded video or cause recorded video to be indistinct.**
- **Prolonged use of the product can increase the interior temperature and cause burns.**
- **microSD cards are consumables, so replace microSD cards after prolonged use.**
microSD cards may not record video correctly after extended use, so check the microSD card's recording capability periodically and replace as necessary.
- **Clean the lens regularly.**
Foreign material attached to the lens can affect the recording quality.
- **Do not remove the microSD card while the microSD card is saving or reading data.**
The data can be damaged or malfunctions may occur.
- **It is recommended that you install the software and firmware from the BlackVue downloads page (www.blackvue.com).**
- **It is recommended that you remove the power cord if the product (BlackVue dashcam/Parking Mode Hardwiring Kit) is not used for an extended period of time.**

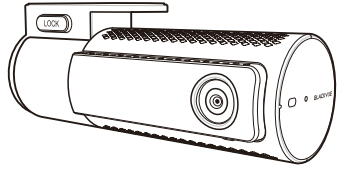
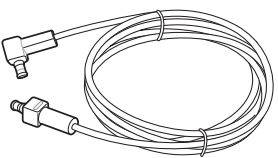
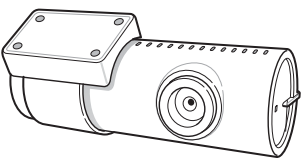
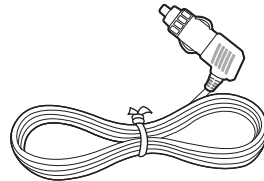
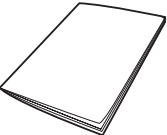
Overview

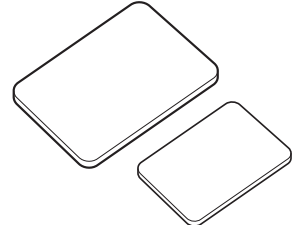
In the box

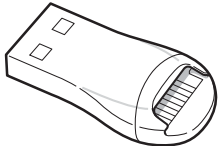
Check the box for each of the following items before installing the BlackVue dashcam.

 <p>Front camera</p>	 <p>Rear camera connection cable</p>	 <p>Rear camera</p>
 <p>Power cord</p>	 <p>Quick start guide</p>	 <p>Pry tool</p>
 <p>Double-sided tape for the Mounting Brackets</p>	 <p>Cable clips (8 EA)</p>	 <p>SIM eject tool</p>
 <p>microSD card reader</p>	 <p>microSD Card</p>	 <p>SIM card (optional)</p>

Note

- The illustrations in this manual may differ from the product.
- To improve the performance of the product, the contents of this manual are subject to change without prior notice.
- For more information about the package components and accessories, visit the BlackVue website (www.blackvue.com).

➤ At a glance

The following diagrams explain each part of the BlackVue dashcam.

□ Front camera

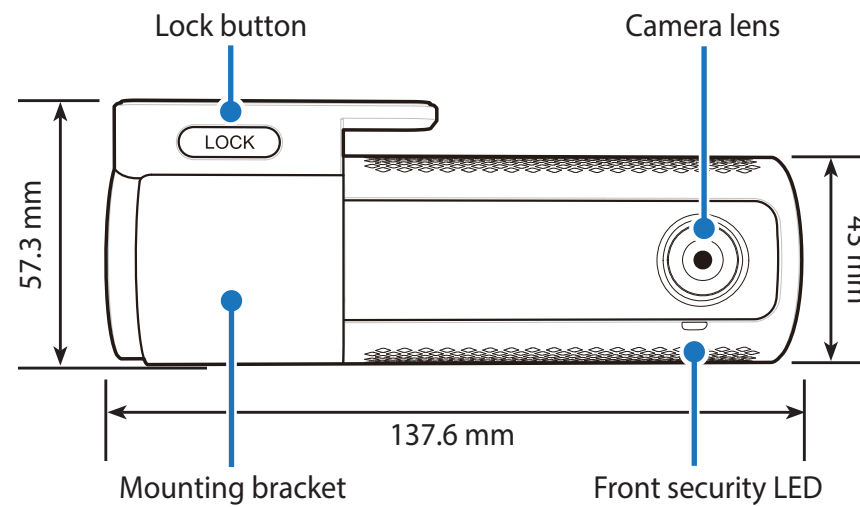

Front security LED

■ : Light on during normal mode, time-lapse parking mode and time-lapse recording, motion detection standby in parking mode.

◻ : Blinks slowly when Standby recoding (i) in Normal, Manual, Event mode (ii) and time-lapse/motion in parking mode.

LTE/Wi-Fi LED

- : LTE is connected
- : LTE is disconnected
- : Wi-Fi is connected
- : Blinks slowly when it trying to connect to Wi-Fi. Blinks quickly when (i) it is function error , or (ii) when LTE/Wi-Fi is turning on/off

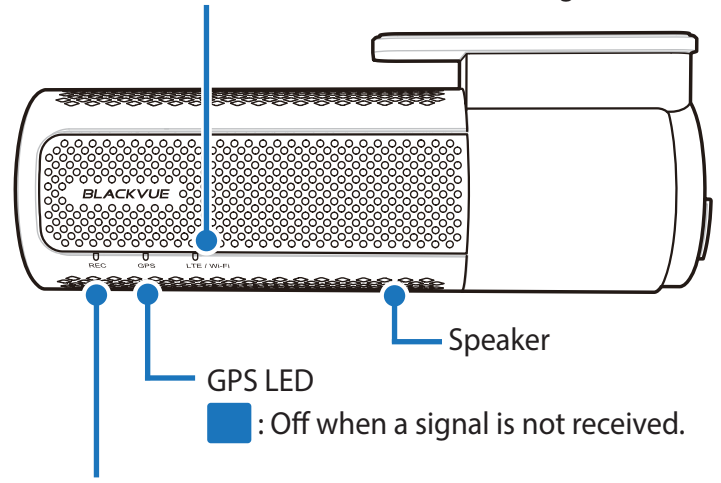

Recording LED

- : Light Orange in Normal mode.
- : Blinks Orange in standby recoding.
- : Light Red in Manual and Event mode.
- : Light Green in Time-lapse and motion in parking mode.

Proximity Sensor LED

- : On when proximity sensor is triggered

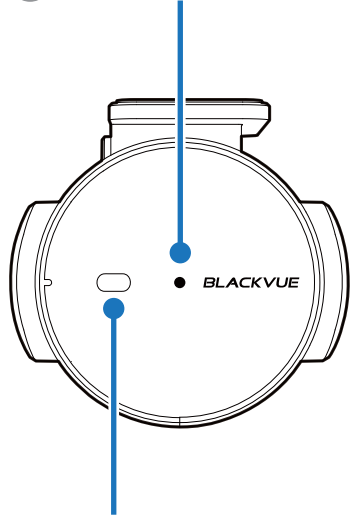

Proximity Sensor:
 Touch or wave a finger within 20mm of the sensor to trigger a customizable function. Available options are:
 - Turn on/off audio recording (default)
 - Manual recording trigger
 The sensor can also be disabled completely.

Format button:

- Press and hold for 5 seconds and once voice instructions start, release the button. Then press and hold for 5 seconds again to format the microSD card.

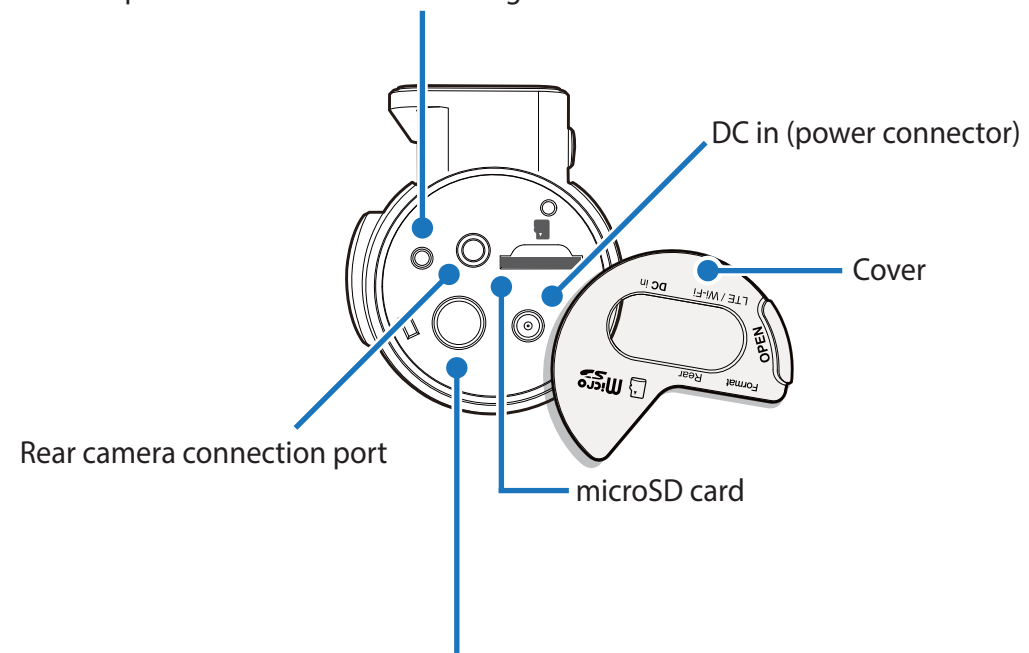

Wi-Fi button:

- Press once and voice commands start to turn on/off Wi-Fi.

□ Removing and inserting the front camera

Connectivity details label:

- Default Wi-Fi SSID
- Default Wi-Fi password
- Cloud code
- Serial number
- QR code

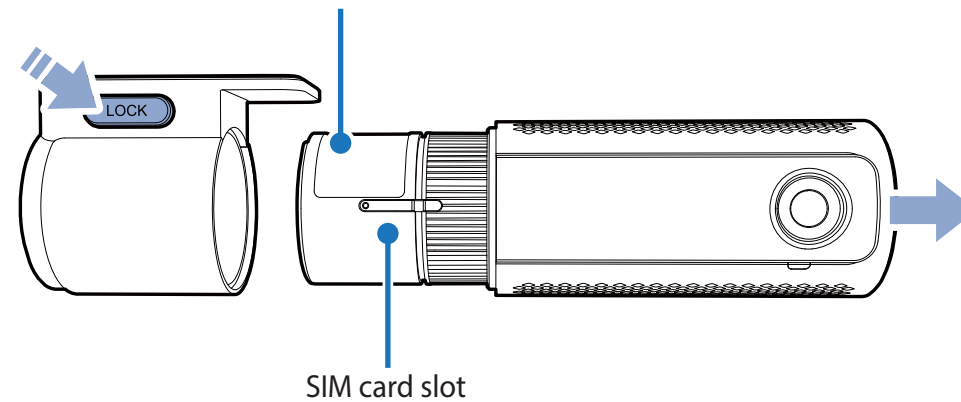

- To remove the dashcam from its bracket, press the LOCK button and pull the dashcam out of the mounting bracket.
- To insert the dashcam into its bracket, push the dashcam into the mounting bracket until it "clicks" in.
- To use the LTE service, insert the SIM card in SIM card slot.

□ Rear camera

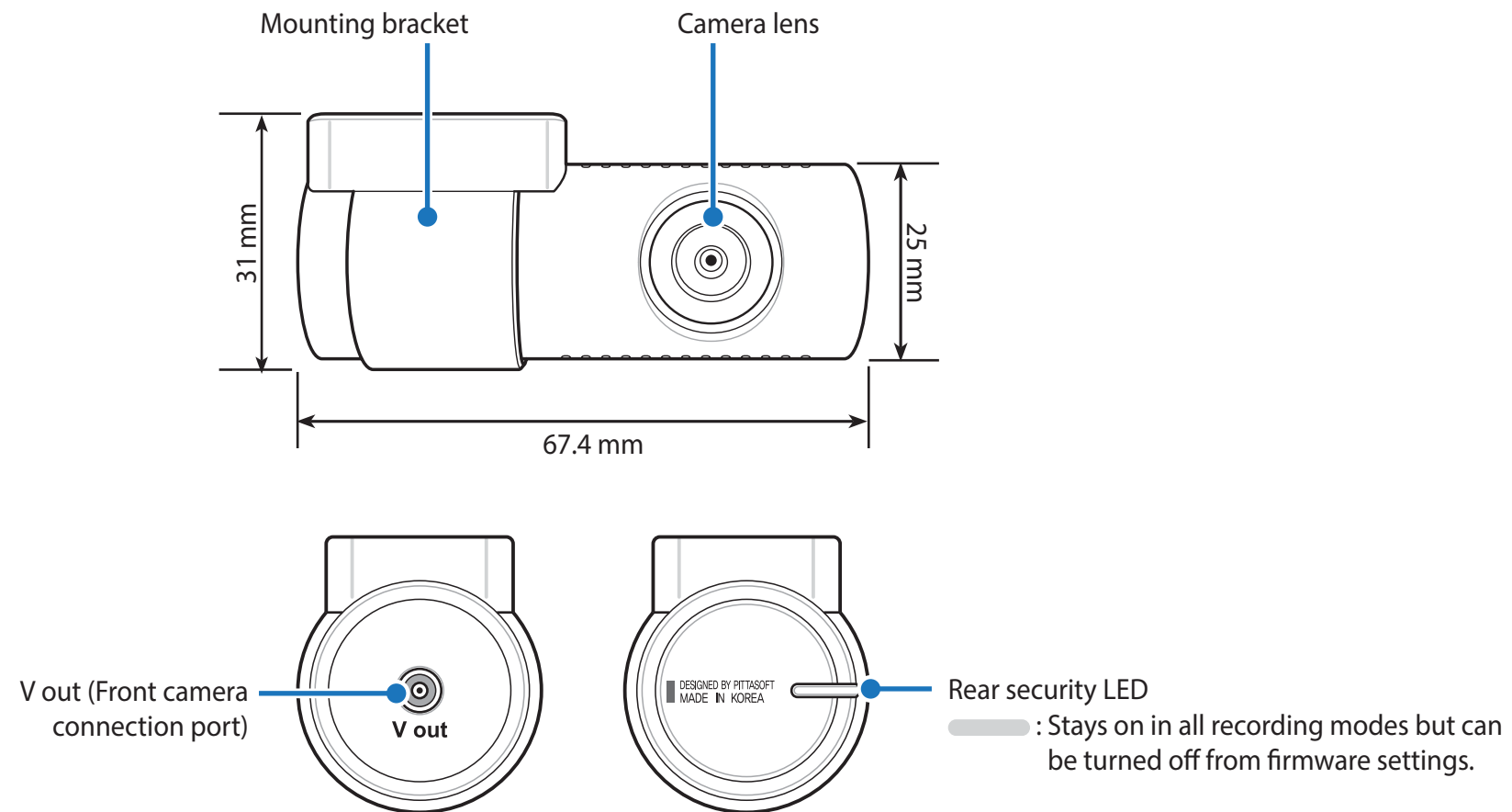

□ Removing and inserting the rear camera

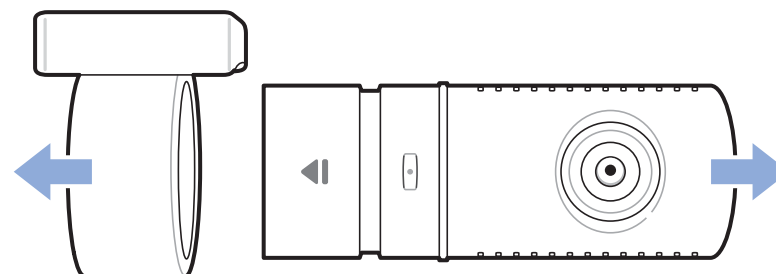

- To remove the rear camera from its bracket, hold the mounting bracket and pull the rear camera out.
- To insert the rear camera into its bracket, push the rear camera into the mounting bracket until it "clicks" in.

Installation

▶ Installing the BlackVue dashcam

Install the front camera behind the rear view mirror. Install the rear camera at the top of the back windshield. Remove any foreign matter and clean and dry the windshield before installation.

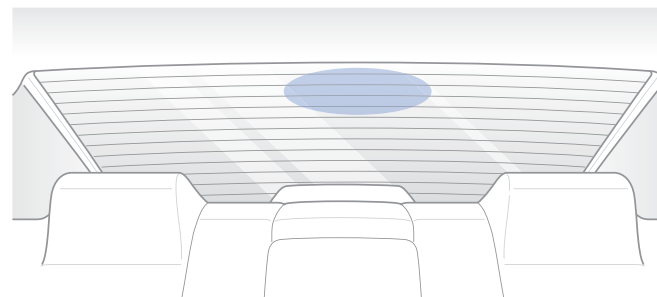
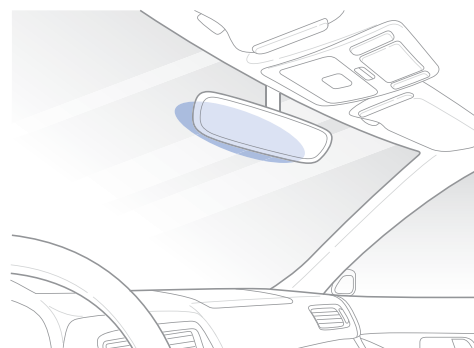

⚠ Warning

- Do not install the product in a location where it can obstruct the driver's field of vision.

Turn off the engine. Open the cover of the microSD card slot, gently push the card into the slot until it locks into place and close the cover.

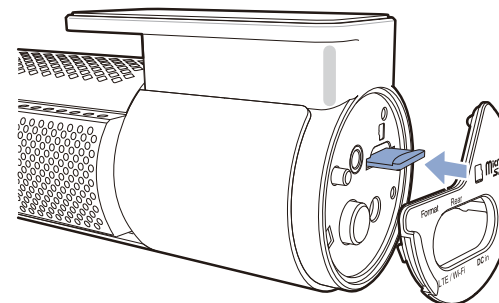
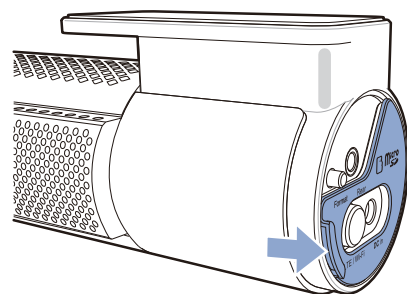

To insert the SIM card, remove the bracket from front camera. Then open SIM slot by using SIM eject tool.

 **Note**

For detailed information about activation of SIM card, please check page 93 and 94.

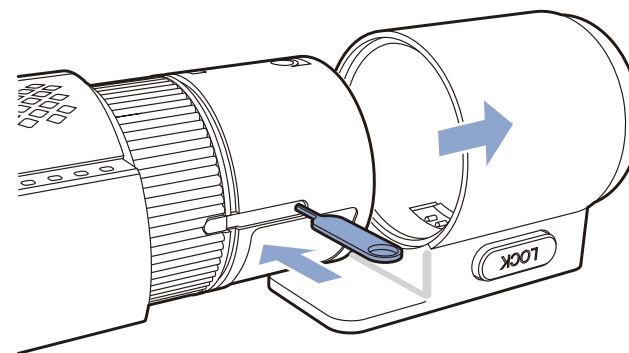
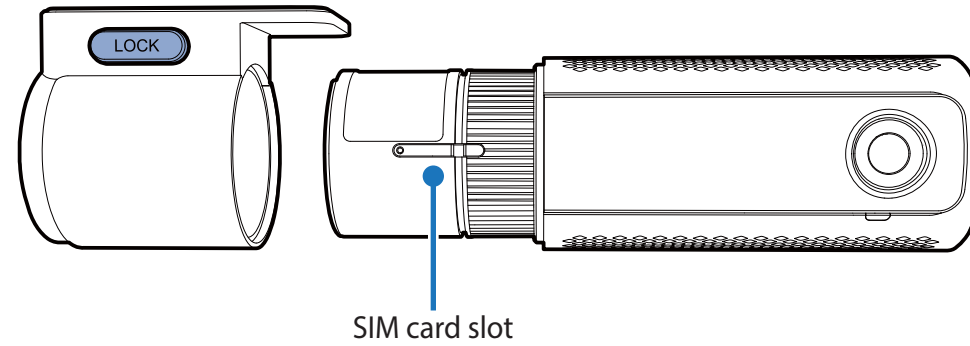

Open slot by SIM eject tool which is included in the box

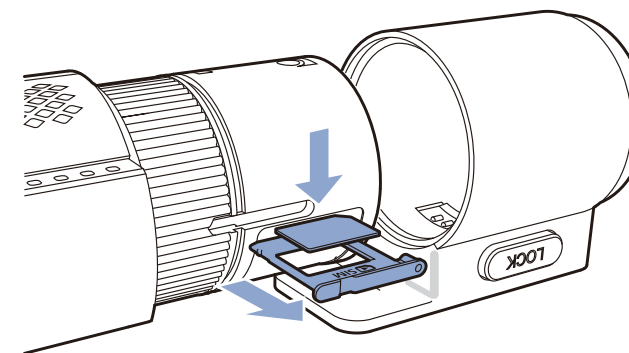

Insert your SIM card

Peel off the protective film from the double-sided tape and attach the front camera to the windshield behind the rear-view mirror.

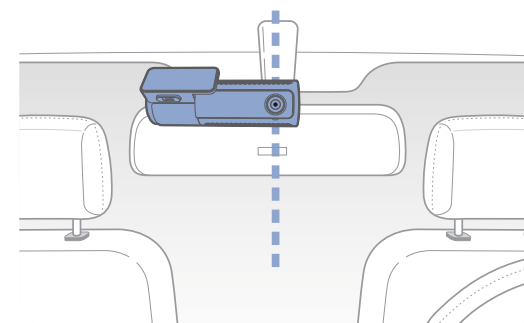
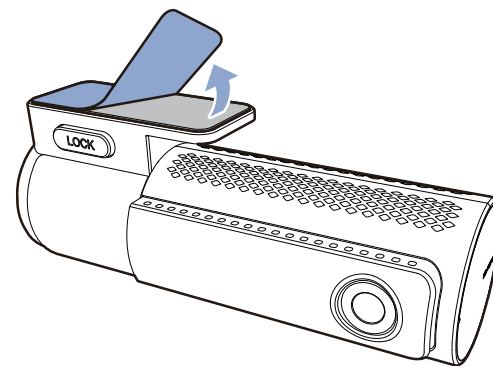

Adjust the angle of the lens by rotating the body of the front camera. We recommend pointing the lens slightly downwards ($\approx 10^\circ$ below horizontal), so as to record video with a 6:4 road to background ratio.

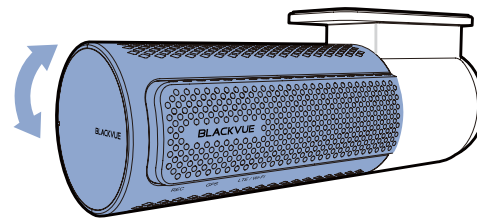

Peel off the protective film from the double-sided tape and attach the rear camera to the rear windshield. Adjust the angle of the lens by rotating the body of the rear camera.

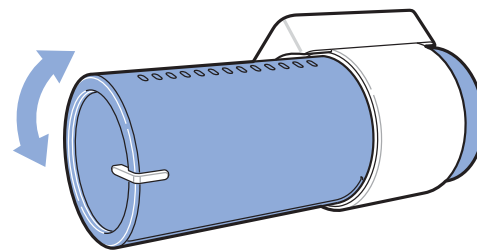

Connect the front camera ('Rear' port) and the rear camera ('V out') using the rear camera connection cable.

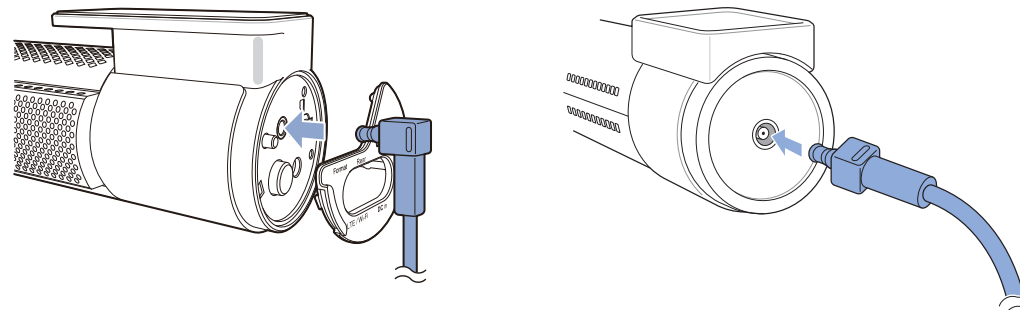

Use the pry tool to lift the edges of the rubber window sealing and molding and tuck in the rear camera connection cable.

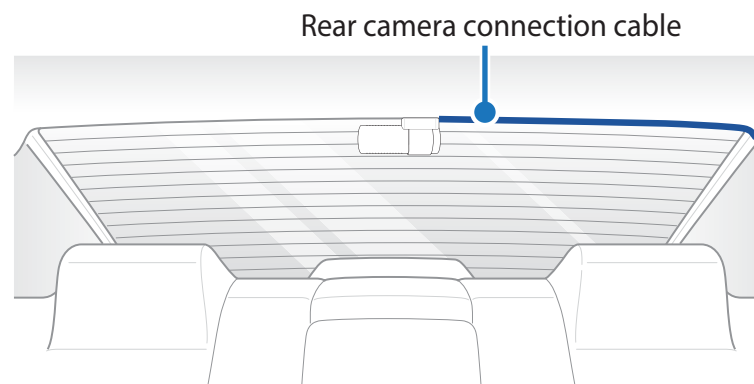

Plug the power cord into the cigarette lighter socket and the front camera.

Use the pry tool to lift the edges of the windshield trim/molding and tuck in the power cord.

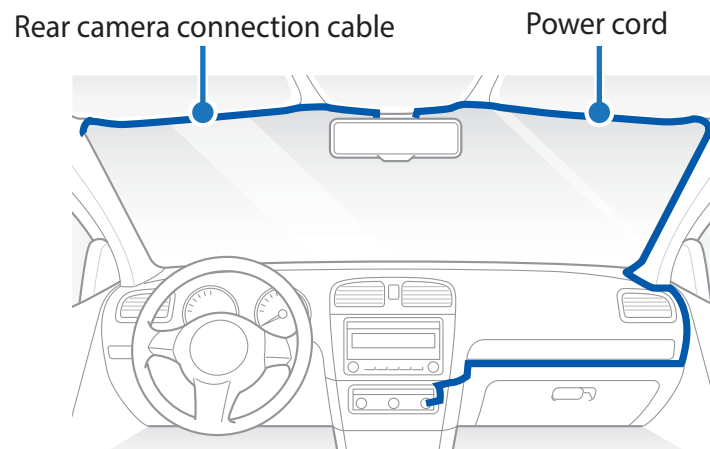

Turn on the engine. The BlackVue dashcam will power up and start recording. Video files are stored on the microSD card. When the microSD card fills up, the newest video files will start to replace the oldest video files (called loop recording) – so you will always have the most recent video files.

Turn off the engine. The dashcam will automatically stop recording and power down. To record in parking mode while the engine is off please install a parking mode kit/battery from the **BlackVue Power Magic** range of accessories (sold separately).

Note

- Up to 50 event recordings (impact, manual) can be locked from being overwritten. By default, this feature is disabled. You can enable it from firmware settings and choose to either overwrite them with new event files when the event file storage is full or lock the 50 event files and save the new event files in loop recording storage. Please note that formatting the microSD card deletes all the recordings including the locked event files.
- The recording LED blinks while recording (default setting) and the GPS LED is on when a GPS signal is received. There are 4 recording modes: Normal, Event, Parking and Manual. The dashcam starts recording in normal mode, switches to event mode when an impact is detected, and switches to parking mode if the vehicle is stationary for 5 minutes. Touching the proximity sensor turns on/off audio recording or triggers manual recording depending on the firmware settings.
- When you run the dashcam for the first time the firmware is automatically loaded onto the microSD card. After the firmware has been loaded onto the microSD card you can customize settings using BlackVue Viewer on a computer.

Playing and Managing Videos

▶ Playing and managing video files using your smartphone (Android/iOS)

➤ Opening video files

Search for the BlackVue app in the Google Play Store or Apple App Store and install it on your smartphone.

“Pair” your smartphone with the BlackVue dashcam via direct Wi-Fi:

- a. Press the Wi-Fi button once to turn on Wi-Fi.
- b. Go to your smartphone's **Settings** then select **Wi-Fi**, and make sure Wi-Fi is turned on.

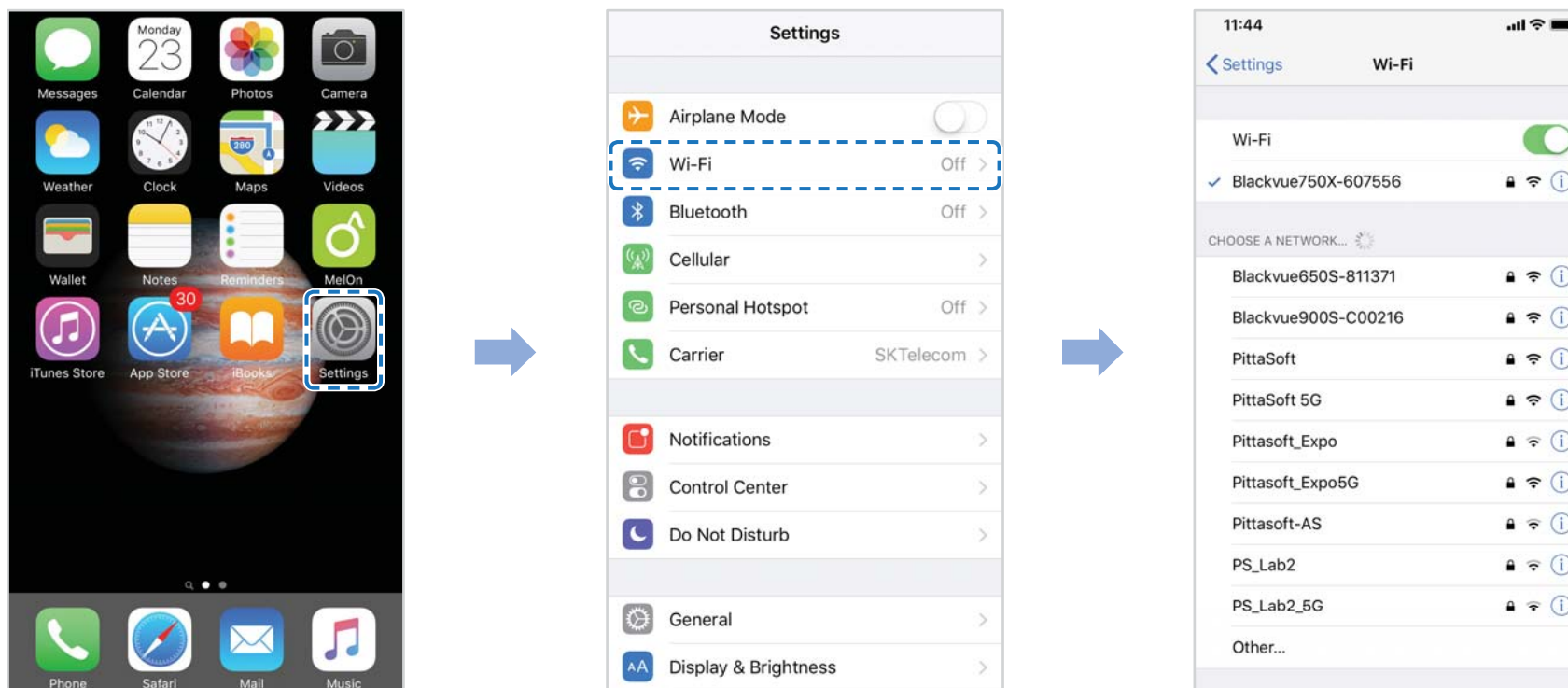

- c. Choose your BlackVue dashcam from the network list. The dashcam's default SSID begins with its model number (e.g. BlackVue ****_*****).
- d. Enter the password and tap join.
- * The default Wi-Fi SSID and password are printed on the dashcam's label or on the product pad inside the packaging box.
- e. Open the BlackVue app and select BLACKVUE WI-FI.

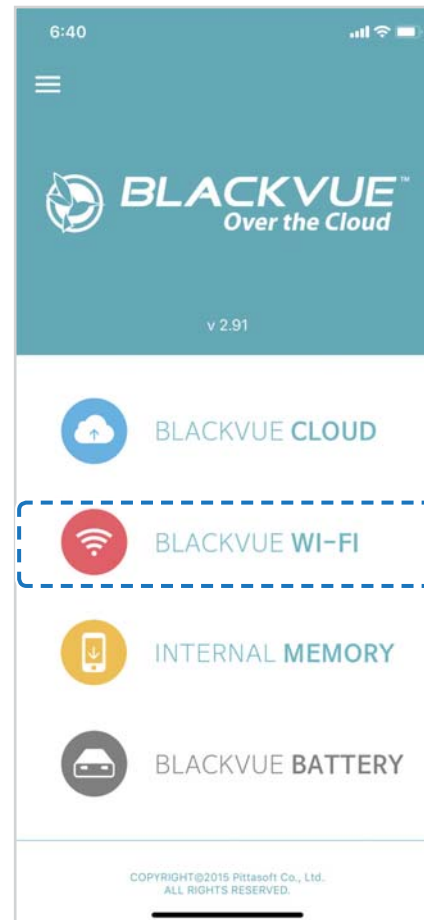

 **Note**

- Direct Wi-Fi lets you directly connect your smartphone to your dashcam via Wi-Fi within a range of 10m.
- The BlackVue app is available for devices running Android 4.4.2 and higher, or iOS 9.0 and higher.
- You can change the Wi-Fi SSID and password as described on page **99** and **102**.

▶ BLACKVUE WI-FI screen composition

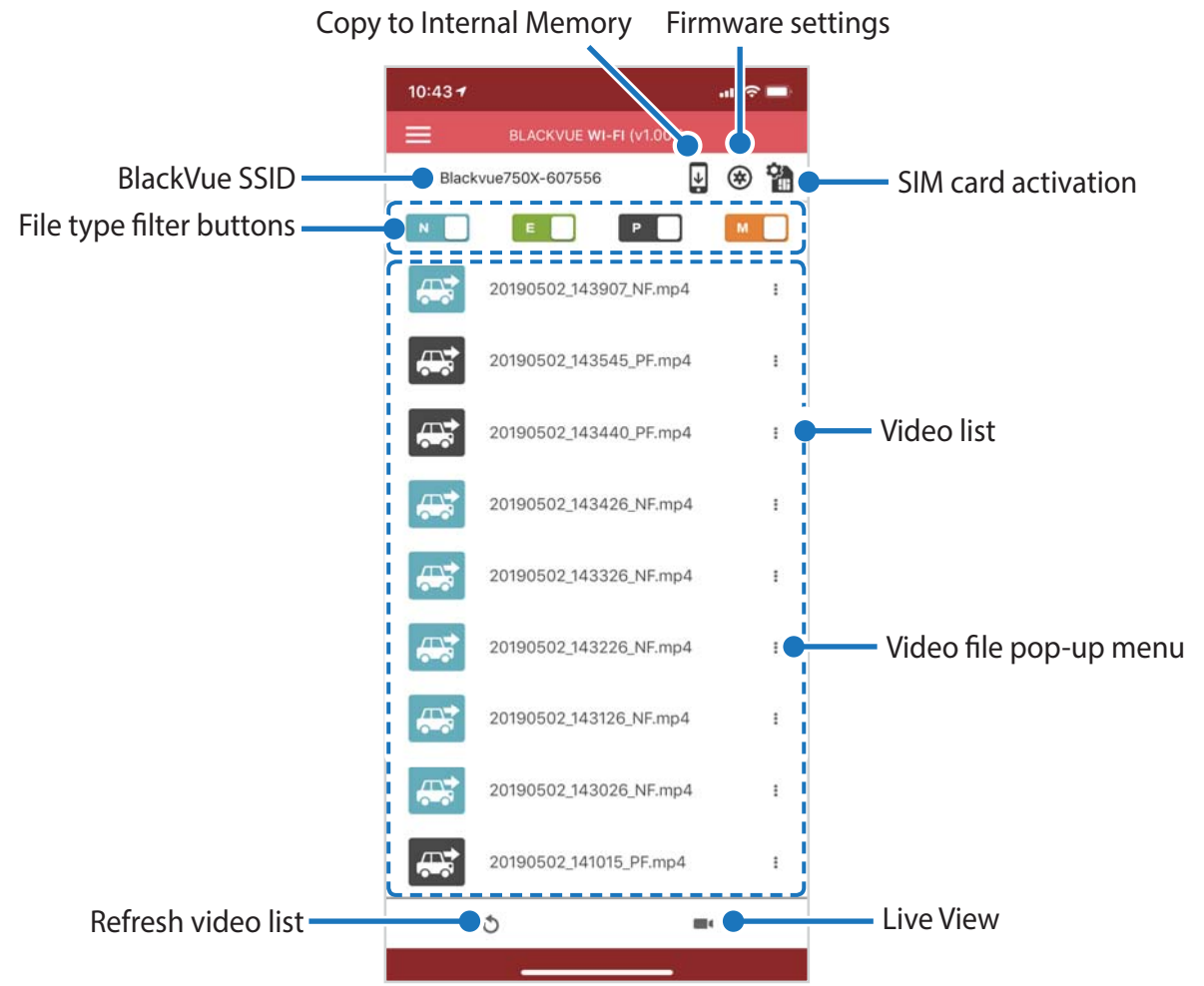

Note

- All images shown are for illustration purposes only. Actual app may differ from images shown.
- For details on LTE/Wi-Fi and Cloud settings, see page **70** and **71**.

Playing video

Playing back videos





Select the video file you want to play from the video list.

Press the refresh button  to refresh the video list.

Note

- The playback of 'Highest' image quality videos depends on your device's hardware and software. Older devices may not support 'Highest' image quality playback. If you encounter issues please select "Quick play file" and check your device's video playback capabilities.
- For quick playback and download of the recordings, you can select the "Quick play file" option from App settings.

Identify video files by recording type

	Normal	The dashcam records in normal mode by default.
	Event	When the dashcam detects an impact while in normal or parking mode, it switches to event mode and saves an event recording beginning 5 seconds before the event trigger. Exceeding the set speed limit will also trigger an event recording.
	Parking	There are two parking mode options. In Motion Detection Parking Mode the dashcam continuously buffers video. When motion is detected in the dashcam's field of view, it saves a parking recording beginning 5 seconds before the motion detection. In Time-Lapse Parking Mode the dashcam records at 1 frame per second and saves recordings that playback at 30 times normal speed.
	Manual	If proximity sensor is set as a manual recording trigger in the firmware settings, touching or waving a finger within 20 mm of the sensor will turn on manual recording.

Tap the car icon to load the thumbnail of a recording.

The car icon with an arrow pointing to the right indicates a front dashcam recording.





The car icon with an arrow pointing to the left indicates a rear dashcam recording.



Recording file names include the date, time, recording type and camera direction.

- **Recording type:**
 - N: Normal
 - E: Event
 - P: Parking
 - M: Manual
- **Camera direction:**
 - F: Front camera
 - R: Rear camera
- **Example file name:** 20170104_150838_NF.mp4
 Date & time: 4th January 2017, 03:08:38 PM
 Recording type: Normal
 Camera direction: Front camera

Note

- Use the , , ,  buttons to filter the video list by recording type (Normal, Event, Parking and Manual). The  filter button displays both E (Event) and I (Impact event while parked) recordings.
- The dashcam requires a constant power source to record in parking mode. See "**Optional accessories**" on page 96 for more information.

☐ Checking the displayed time & GPS data

The time the video was recorded is displayed in the lower left corner of the video in the playback screen. If the displayed time in the recorded videos is incorrect please see **"Time settings" on page 58 or 77.**

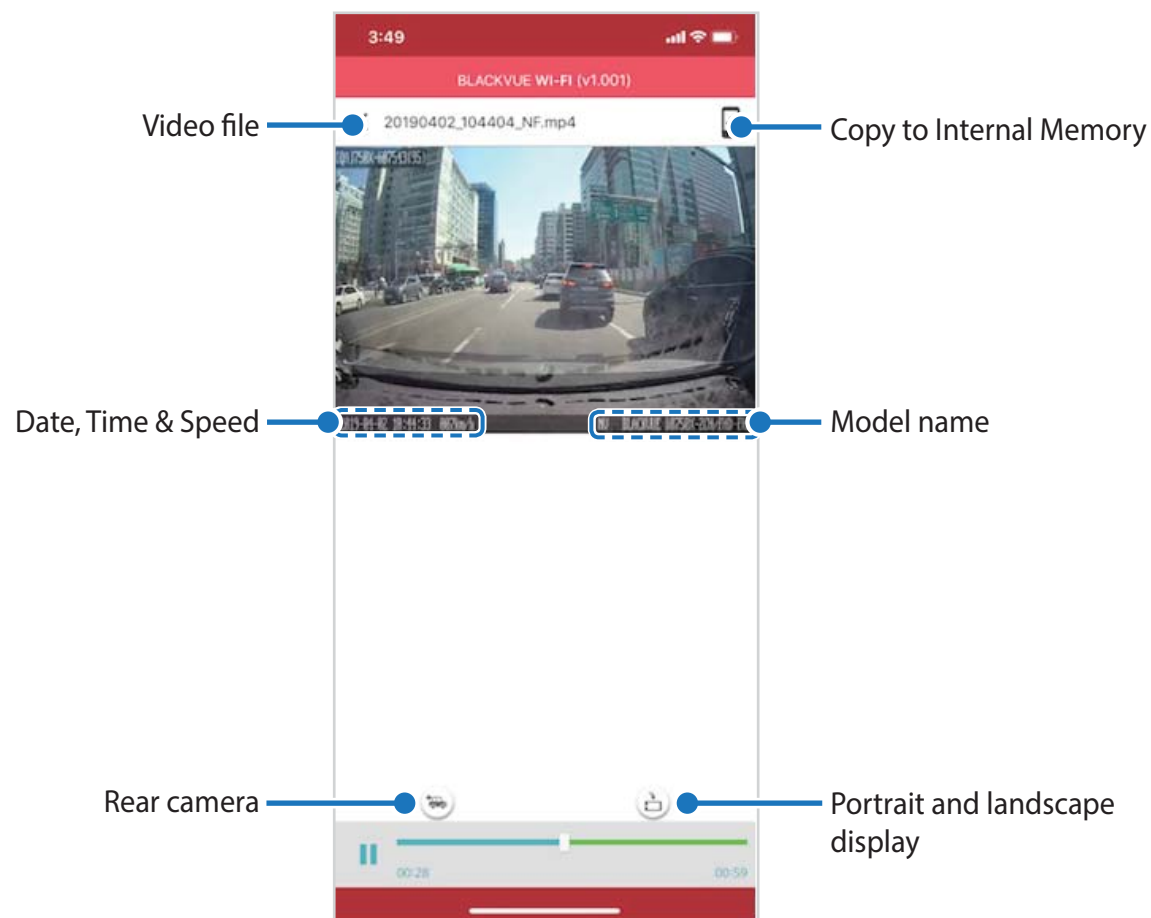

The vehicle's speed is displayed in the lower-left corner of the video.

Rotate your smartphone or press the rotate button  to switch between portrait and landscape display modes.

Press the rear button  to switch to the rear dashcam view.

➤ Real-time streaming video (Live View)

You can view in real-time the video currently being recorded by connecting your smartphone to the dashcam via direct Wi-Fi.

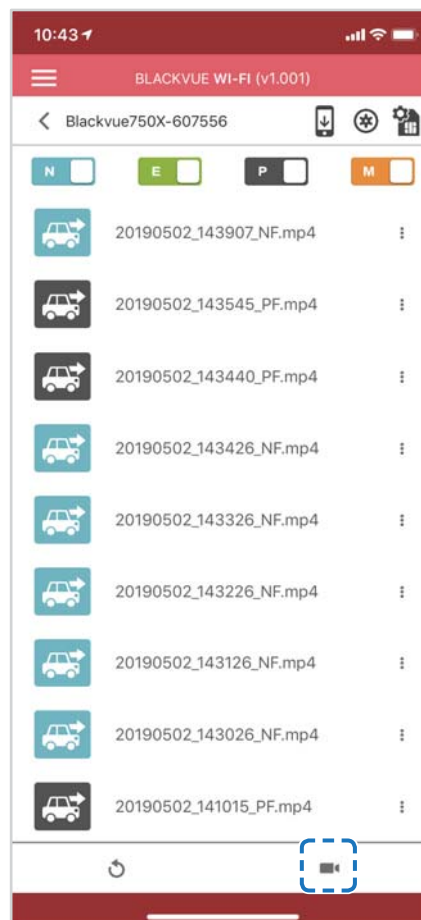

Go to your smartphone's **Settings** > **Wi-Fi** and connect to your dashcam.

Open the BlackVue app. Select **BLACKVUE WI-FI** and tap the  button.

Rotate your smartphone or press the rotate button  to switch between portrait and landscape display modes.

Press the rear button  to switch to the rear dashcam view.

Note

- When watching Live View via direct Wi-Fi, map data isn't displayed because your smartphone can't access the internet as long as it is connected to the dashcam's Wi-Fi.

➤ Managing videos

☐ Managing videos in BLACKVUE WI-FI

You can manage the recorded videos using the BlackVue app.

📝 Note

- When the microSD card fills up, the newest video files will start to replace the oldest video files (called loop recording) – so you will always have the most recent video files.

■ Copy to Internal Memory

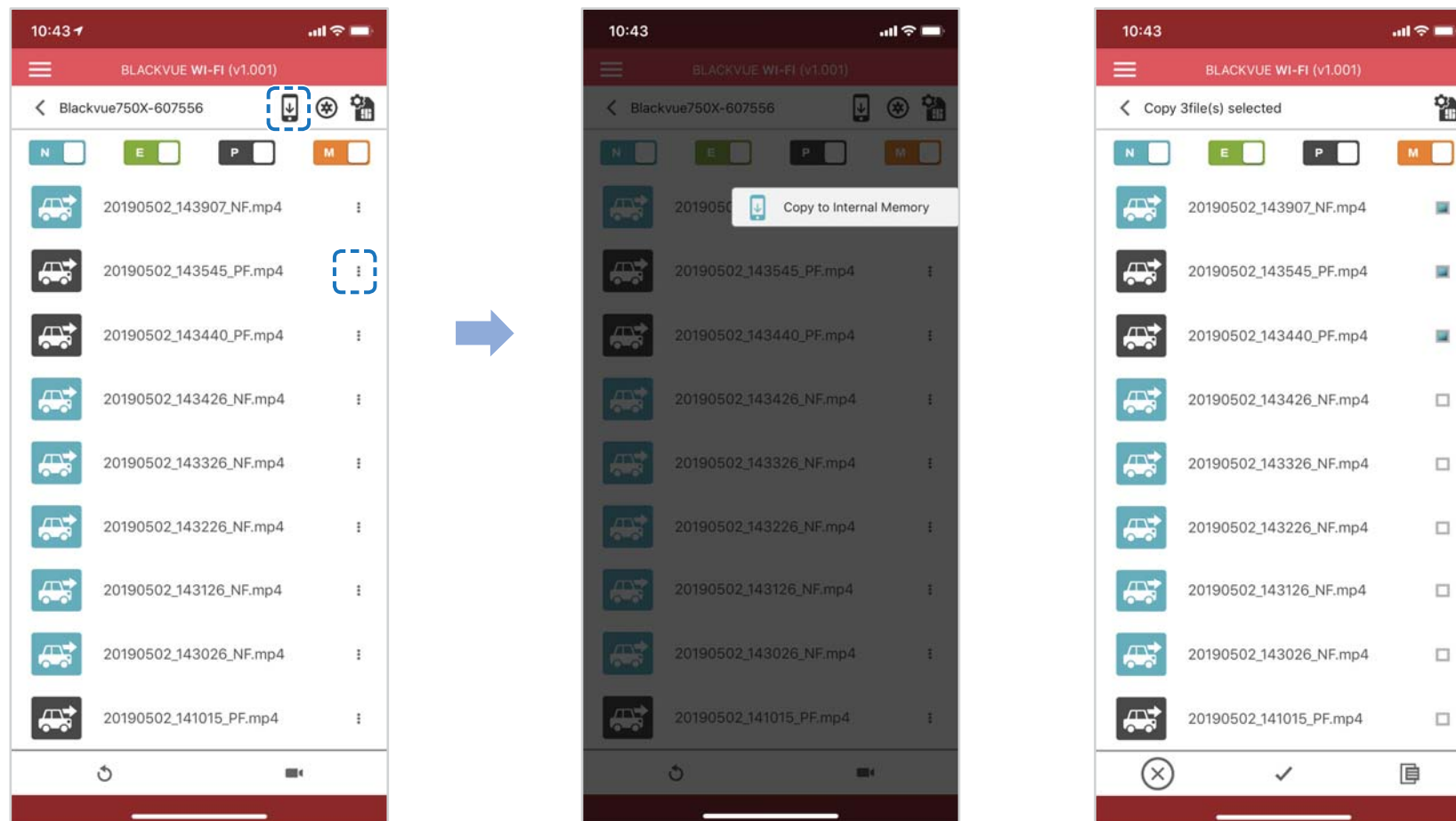



To copy individual files to your smartphone, tap  next to the video you want to copy. Select Copy to Internal Memory.

To copy multiple files to your smartphone in one go tap . Select which files to copy, or tap  to select all files. Tap  to begin copying.

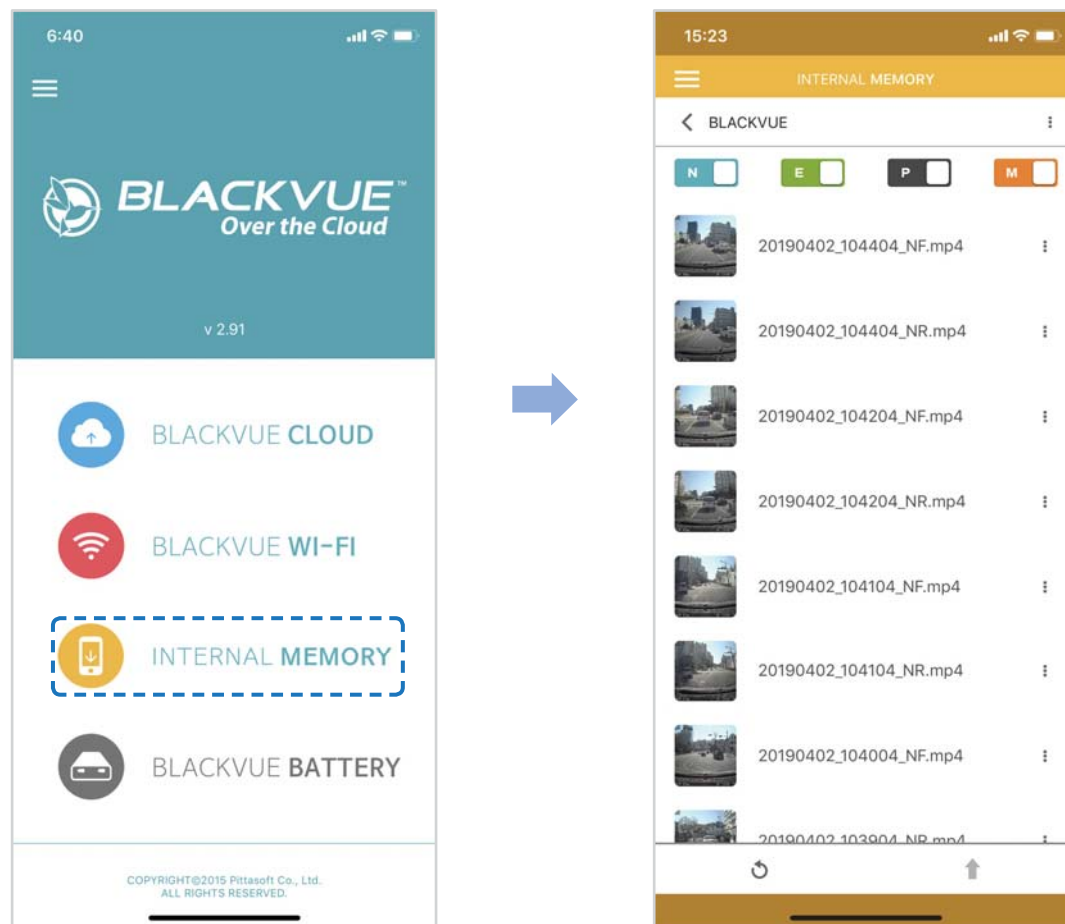

Managing videos in INTERNAL MEMORY

Open the BlackVue app and select INTERNAL MEMORY.



Tap  to see file options. You can delete, copy or move files, change the name of files and share files.

■ Deleting videos

To delete multiple files from your smartphone in one go, tap  at the top of the screen and select **Delete**. Select which files to delete, or tap  to select all files. Tap  to delete the selected files.



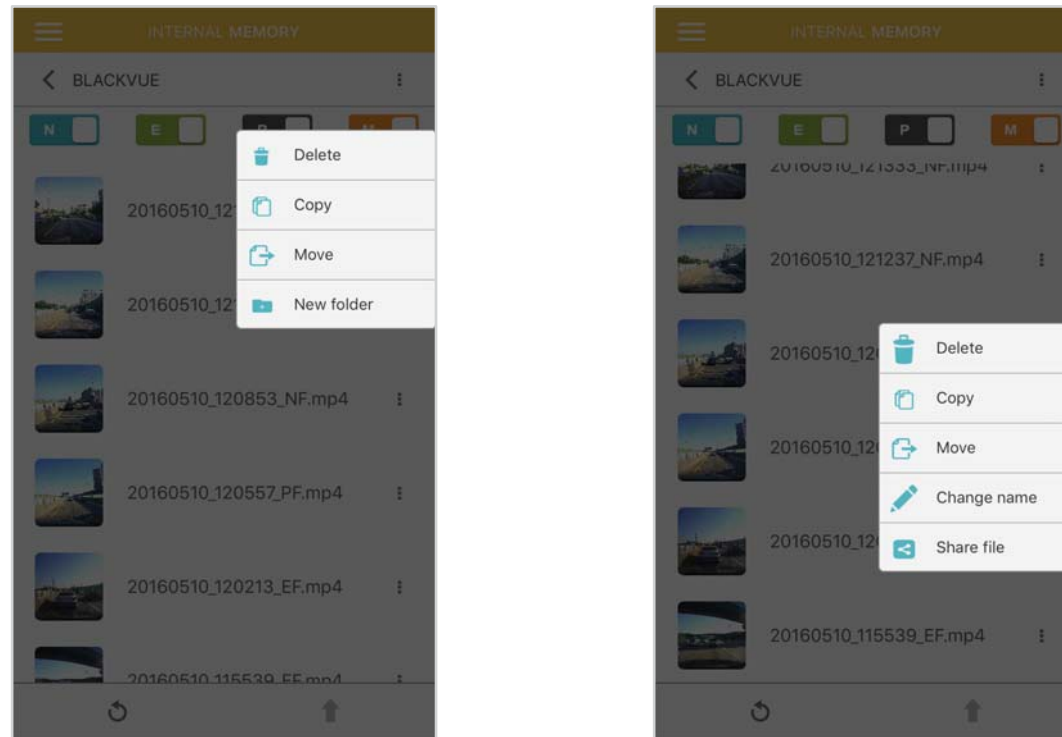

To delete individual files, tap  next to the video you want to delete. Select **Delete**.



■ Creating a new folder





To create a new folder tap  at the top of the screen and select **New folder**. Enter a new folder name and press OK.

■ Copying and pasting videos

To copy multiple files in one go, tap  at the top of the screen and select **Copy**. Select which files to copy, or tap  to select all files. Tap  to copy the selected files. Go to another folder and tap  to paste the selected files there.

To copy individual files, tap  next to the video you want to copy. Select **Copy**. Go to another folder and tap  to paste the file there.

■ Moving videos

To move multiple files in one go, tap  at the top of the screen and select **Move**. Select which files to move, or tap  to select all files. Tap  and go to another folder and tap  to move the selected files there.

To move individual files, tap  next to the video you want to move. Select **Move**. Go to another folder and tap  to move the file there.

■ Renaming a video

To rename a video, tap  next to the video you want to rename. Select **Change name**. Enter a new name and tap **OK**.

■ Uploading, sharing or emailing a video

Tap  next to the video you want to share. Select **Share file**. Choose the app you want to share with. The available options will depend on what apps you have installed on your smartphone.

▶ Playing and managing video files using your computer (Windows/Mac)

➤ Removing the microSD card

Unplug the power cord to turn off the dashcam.

Open the cover of the microSD card slot.

To remove the microSD card, gently press on the card to release the lock then carefully pull the card out.

To insert the microSD card, gently push the card into the slot until it locks into place and close the cover.

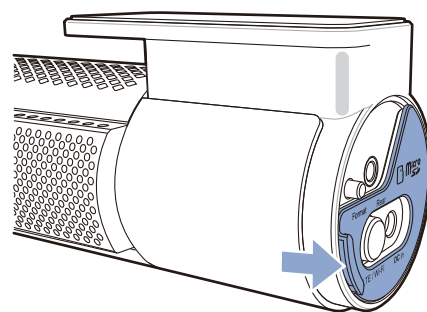

Open side cover

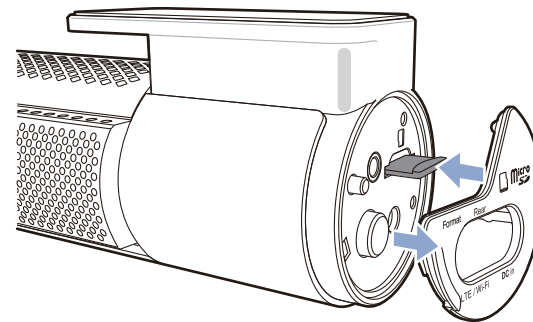

To remove

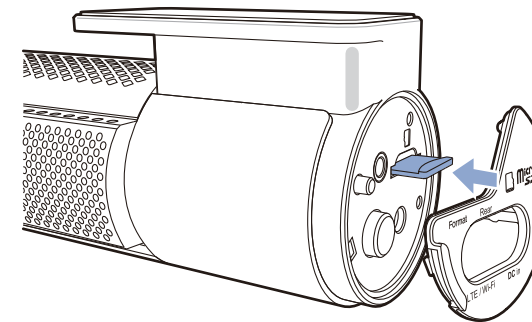

To insert

➤ Opening video files in BlackVue Viewer

Remove the microSD card from the dashcam.

Insert the card into the microSD card reader and connect it to a computer.

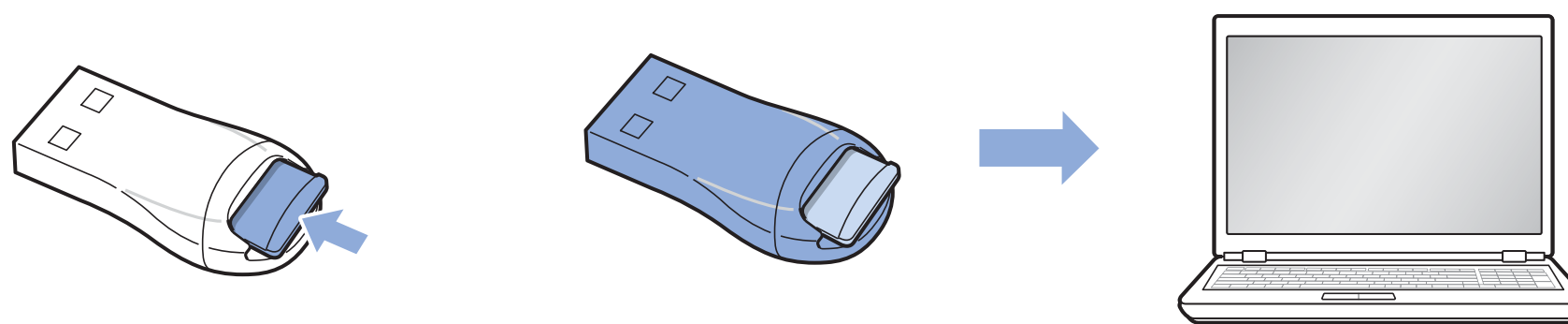

Download BlackVue Viewer from www.blackvue.com > **Support** > **Downloads** and install it on your computer.

Run BlackVue Viewer. To play, select a video and click on the play button or double click the selected video.

Viewer screen composition

Windows Viewer

When you launch the program, you will see the SD card Viewer window. To open Cloud Viewer, click the  button.

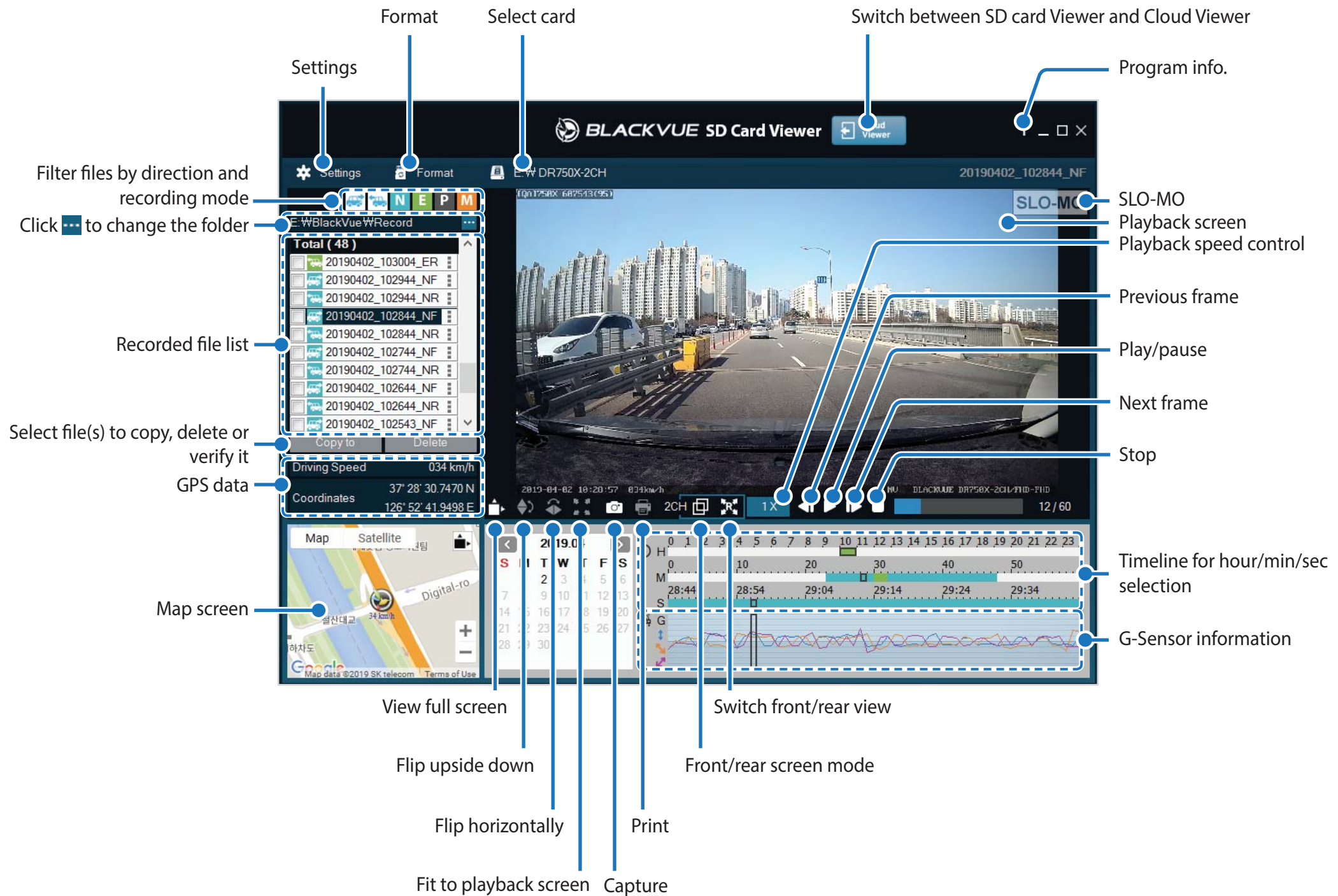

Note

- All images shown are for illustration purposes only. Actual program may differ from images shown.

Mac Viewer

When you launch the program, you will see the SD card Viewer window. To open Cloud Viewer, click the  button.

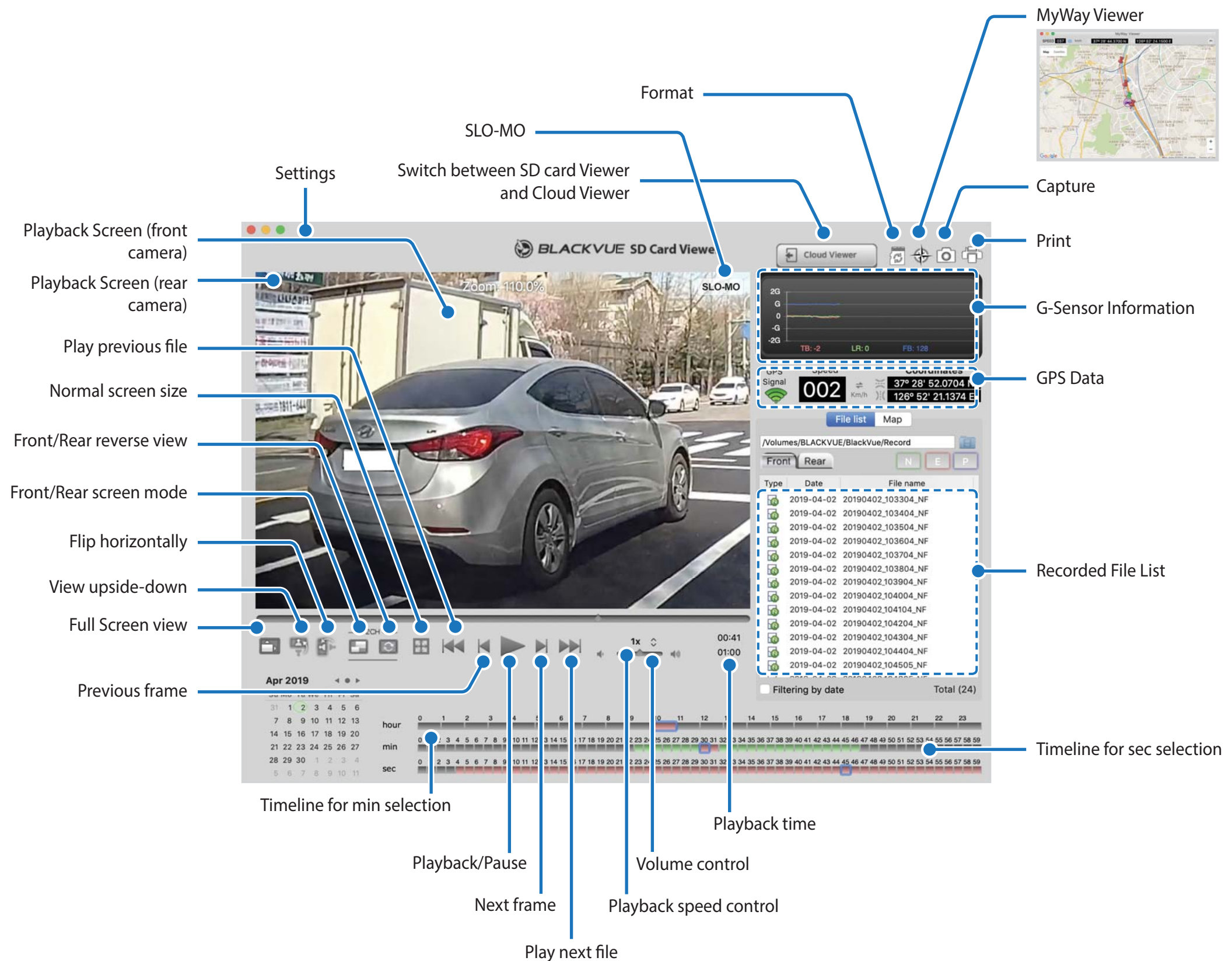

▶ Playing video

□ Playing back videos

In BlackVue Viewer double click a video file to play.

BlackVue Viewer shows by default the files in the microSD card. To see files in another folder click the  button and browse to the folder.



Note



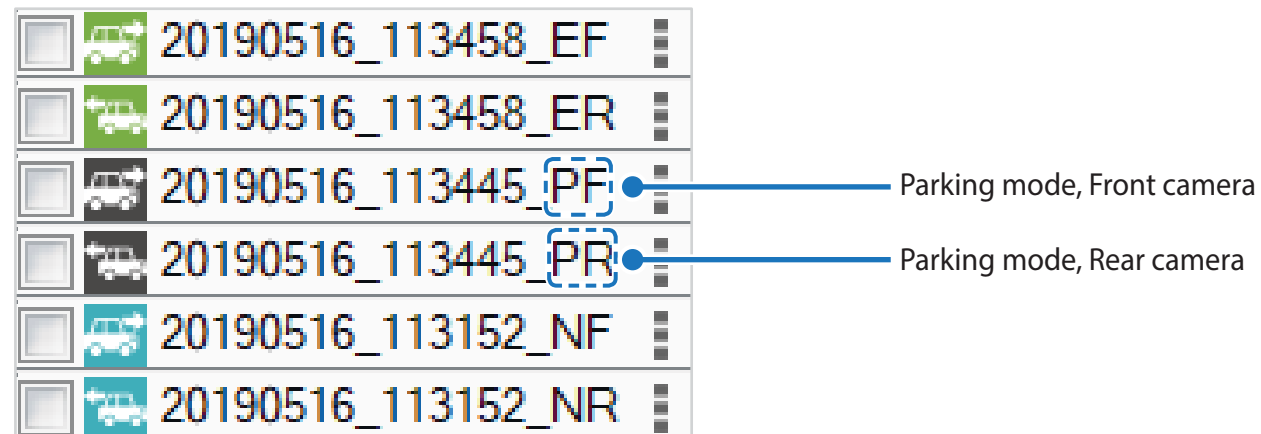

- Depending on your computer's hardware and software, the dashcam videos that are recorded at 60fps may not play smoothly at higher speeds (2x, 4x, etc.).

□ Identify video files by recording type



- **Recording type:** N: Normal
E: Event
P: Parking
M: Manual
- **Camera direction:** F: Front camera
R: Rear camera
- **Example file name:** 20170104_150838_NF.mp4
Date & time: 4th January 2017, 03:08:38 PM
Recording type: Normal
Camera direction: Front camera

Use the  buttons to filter the video list by recording type. The  filter button displays both E (Event) and I (Impact event while parked) recordings.

	Normal	The dashcam records in normal mode by default.
	Event	When the dashcam detects an impact while in normal or parking mode, it switches to event mode and saves an event recording beginning 5 seconds before the event trigger. Exceeding the set speed limit will also trigger an event recording.
	Parking	There are two parking mode options. In Motion Detection Parking Mode the dashcam continuously buffers video. When motion is detected in the dashcam's field of view, it saves a parking recording beginning 5 seconds before the motion detection. In Time-Lapse Parking Mode the dashcam records at 1 frame per second and saves recordings that playback at 30 times normal speed.
	Manual	If proximity sensor is set as a manual recording trigger in the firmware settings, touching or waving a finger within 20mm of the sensor will turn on manual recording.

The car icon with an arrow pointing to the right indicates a front dashcam recording.

The car icon with an arrow pointing to the left indicates a rear dashcam recording.

 **Note**

- The dashcam requires a constant power source to record in parking mode. See "**Optional accessories**" on page 96 for more information.

☐ Checking the displayed time

The time the video was recorded is displayed in the lower left corner of the video in the playback screen. If the displayed time in the recorded videos is incorrect please see **"Time settings" on page 58 or 77.**

☐ Using BlackVue Viewer

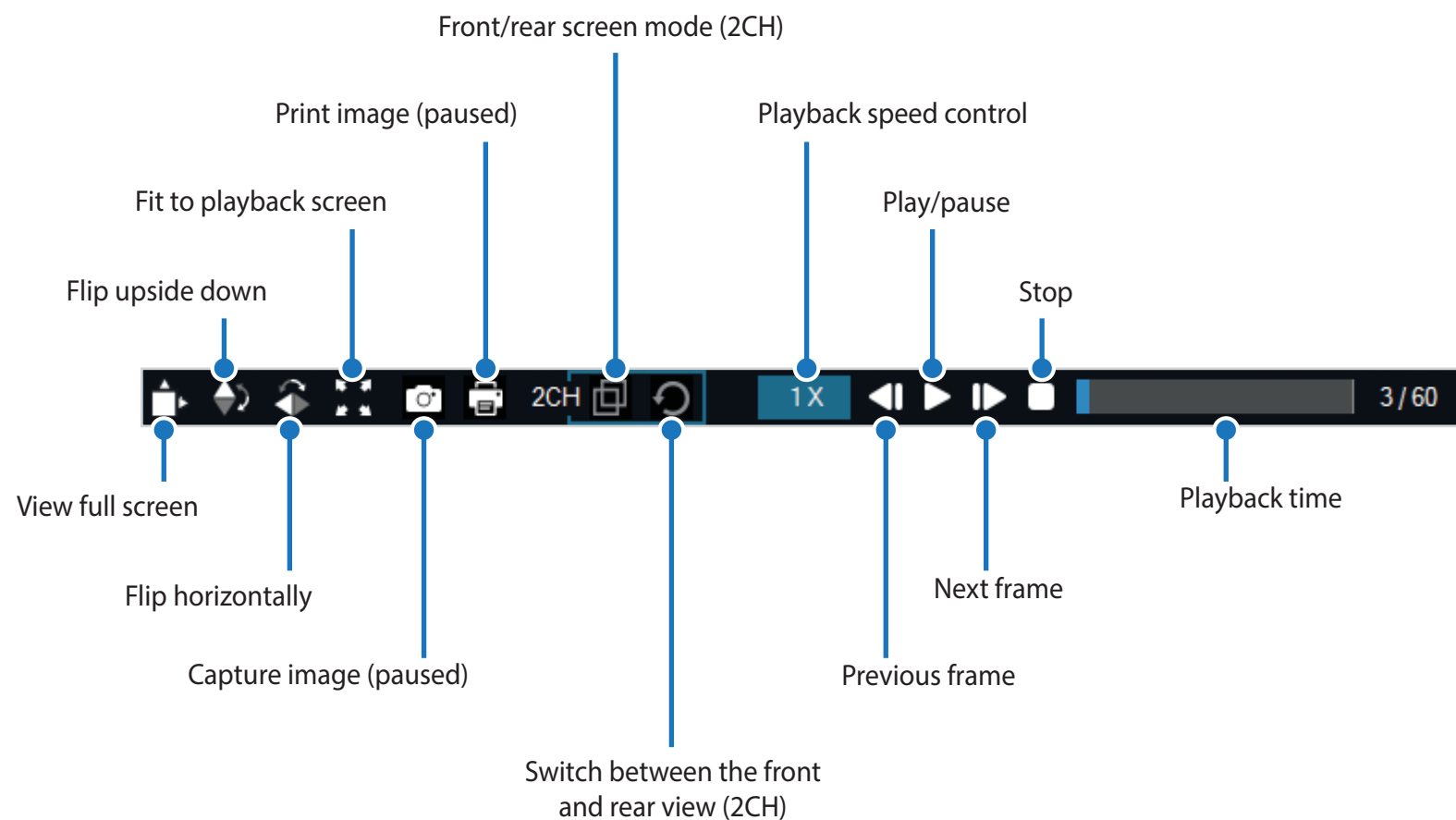

Exploring the timeline and G-Sensor graph

You can explore the timeline for the playback of the recorded videos by date, hour, minute and second using the timeline.

You can check the impact sensitivity (G-Sensor) information in the line graph.

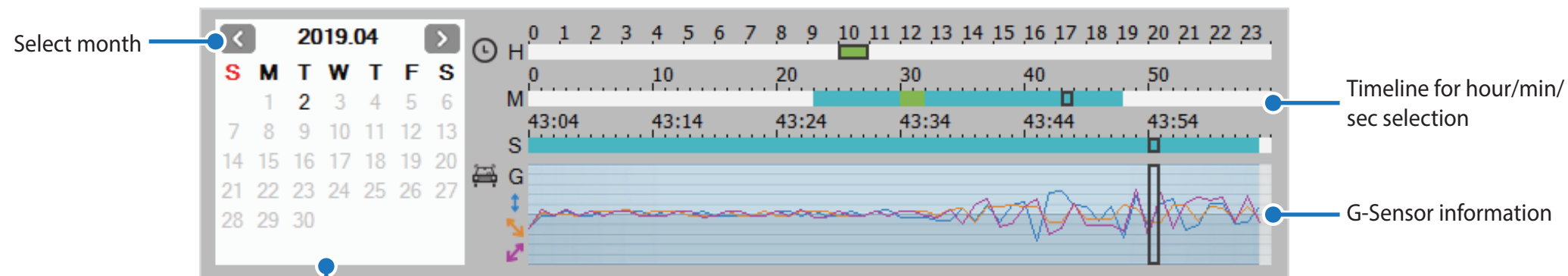

- Select date
- Dates with recordings are black
 - Click a date to filter recordings (date changes to red and circled)

Zoom options

- Use the mouse scroll wheel zoom. Right clicking will restore the video to the default size.
- You can resize the playback frame or the BlackVue Viewer window by dragging the borders.
- **Full-screen view:** Double click on the video image to enter full-screen view. Double click again or tap ESC to return to the default view.

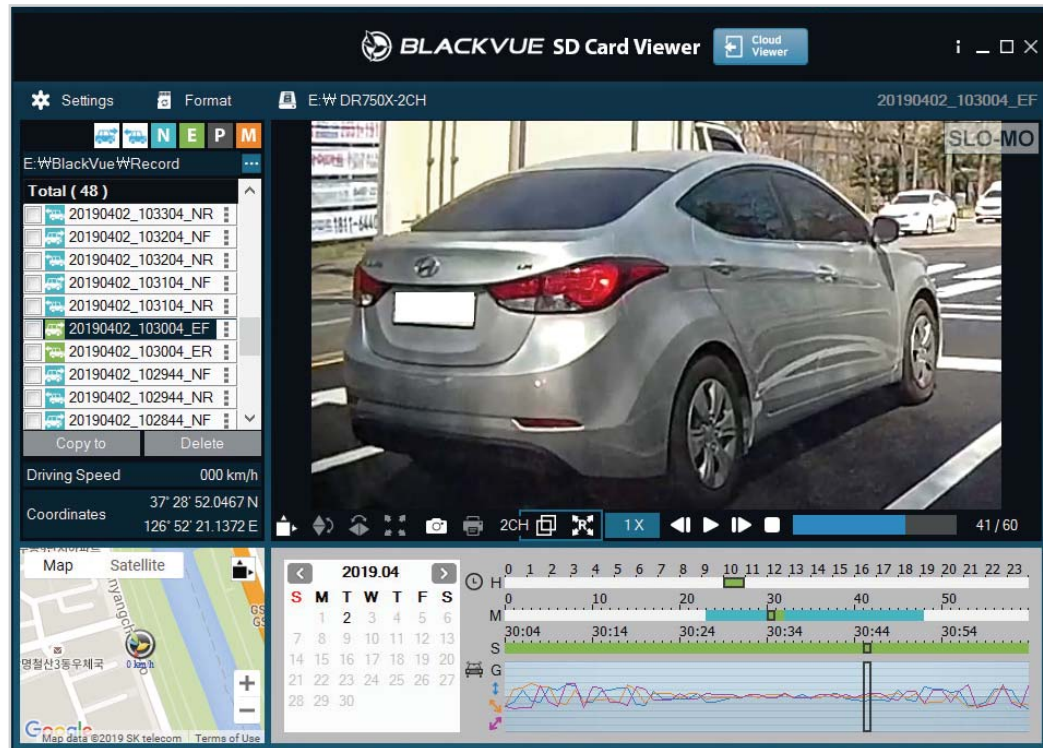

Windows

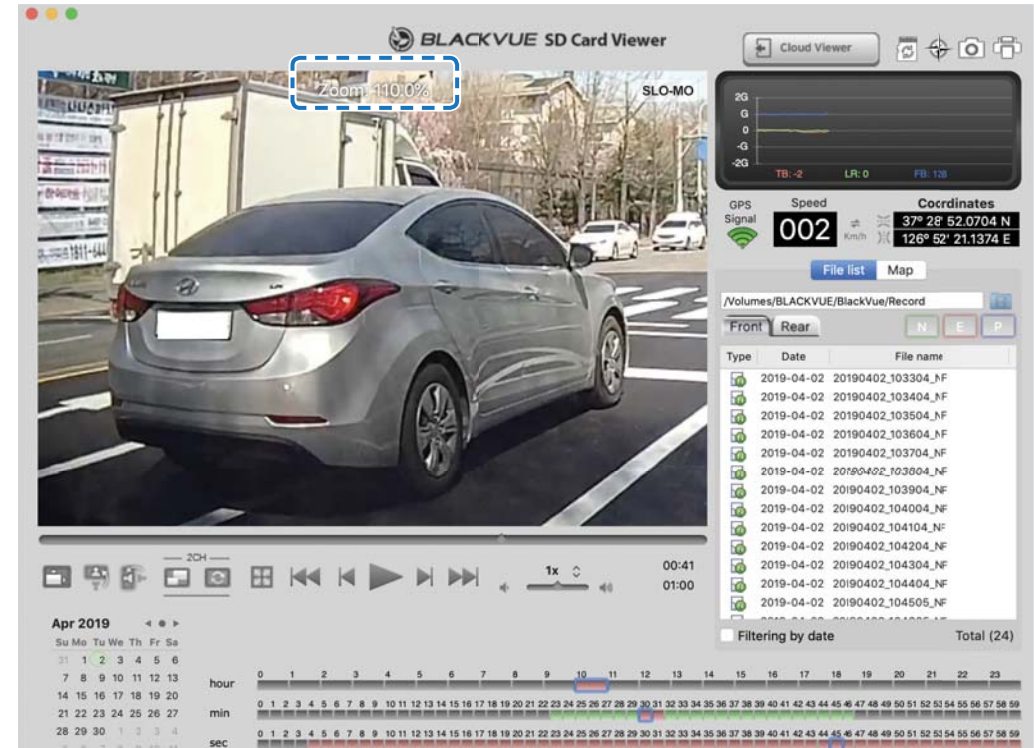

Mac

☐ Checking the GPS data

You can check the GPS data of the recorded video in BlackVue Viewer while video is playing back. The driving speed and coordinates are displayed above the map frame.

📝 Note

- GPS data is not recorded during parking mode. Map data cannot be displayed for parking mode recordings.

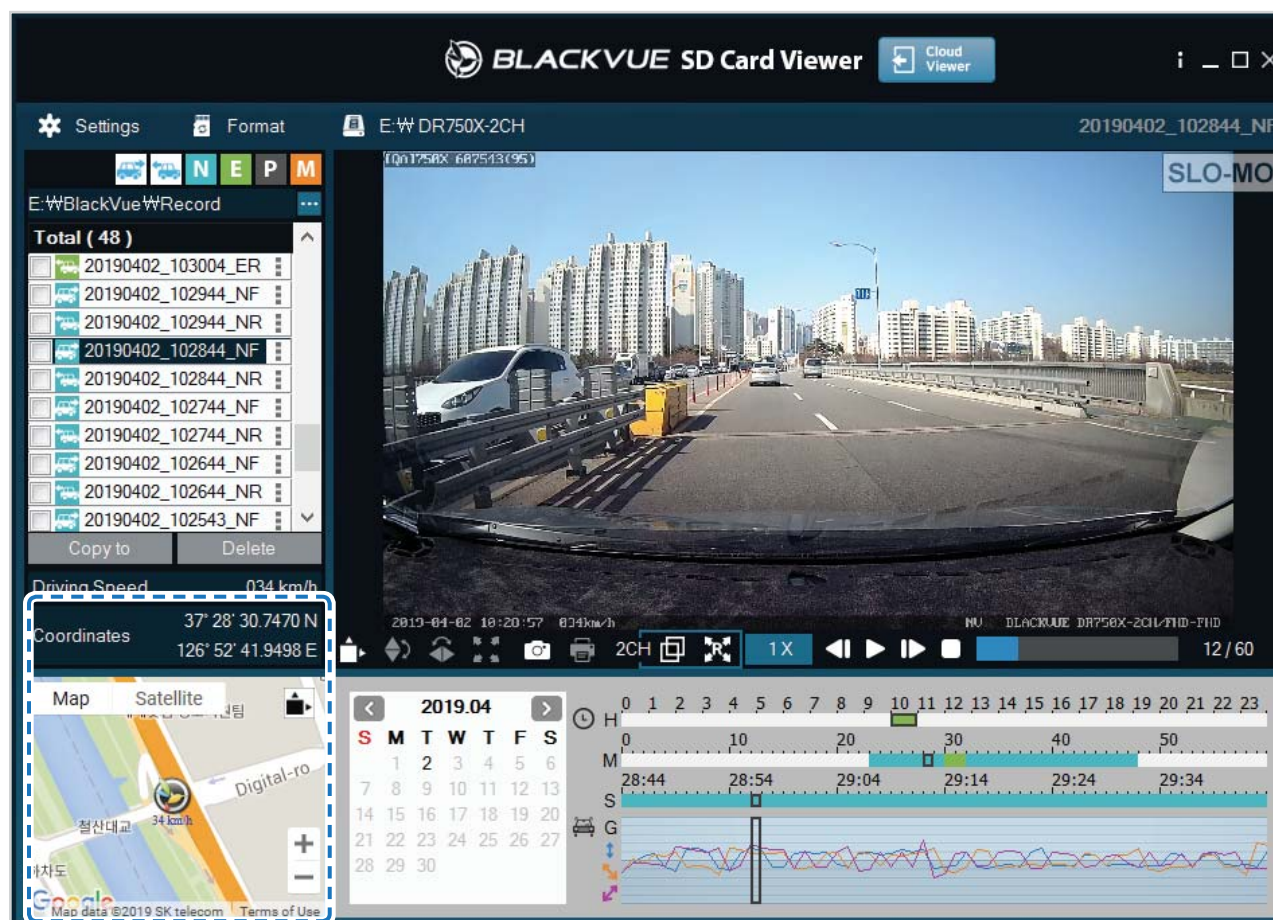

Managing videos

You can manage the recorded videos through the BlackVue Viewer program. You can also format the microSD card.





Note

- If the microSD card is full, by default the dashcam will record over the oldest videos first.

Capturing or printing a still image from video

Double click a file in the file list to play.

Click the  pause button to pause the video.

Select the  capture button to capture the image or the  print button to print directly.

Deleting videos

For Windows users

Select the video, or videos using the checkboxes, from the recorded video list.

Click **Delete**.

- You can also delete individual files by clicking  next to a video in the recorded video list and selecting **Delete**.

■ For Mac users

Go to \BlackVue\Record\.

Select the video from the recorded video list.

Click Move to Trash.

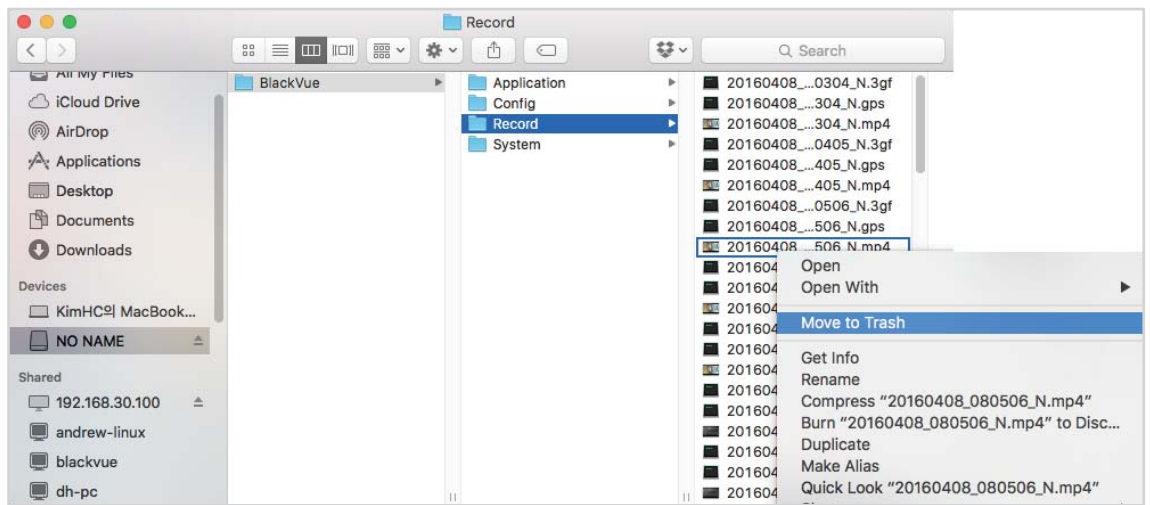

Exporting videos

For Windows users

Click  next to a video in the recorded video list.

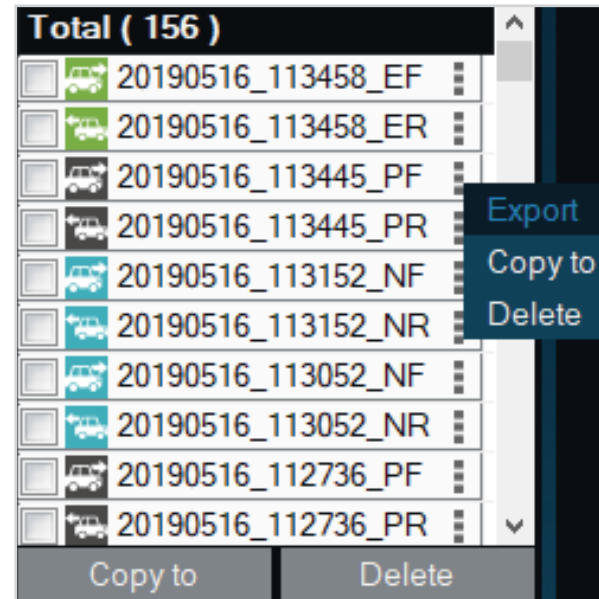

Click **Export**.

If you want to extract a segment of a file select **Save segment** and edit the start and end second points. To export without audio select **Sound Off**.

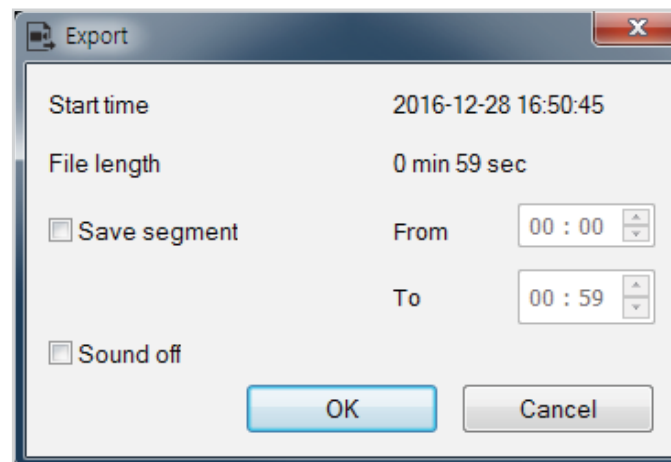

Click the **OK** button.

Select the folder in which to save the file and enter the file name.

Click the **Save** button.

Copying videos

For Windows users

Click  next to a video in the recorded video list.

Click **Copy to**.

Select the folder in which to copy the file and enter the file name.

Click the **Select folder** button.

- To copy multiple files at once check the boxes next to the file names and press the **Copy to** button
- When copying files the segment adjustment and sound off tools are not available.

■ For Mac users

Go to \BlackVue\Record\.

Select the video from the recorded video list.

Click Copy "*file name*".

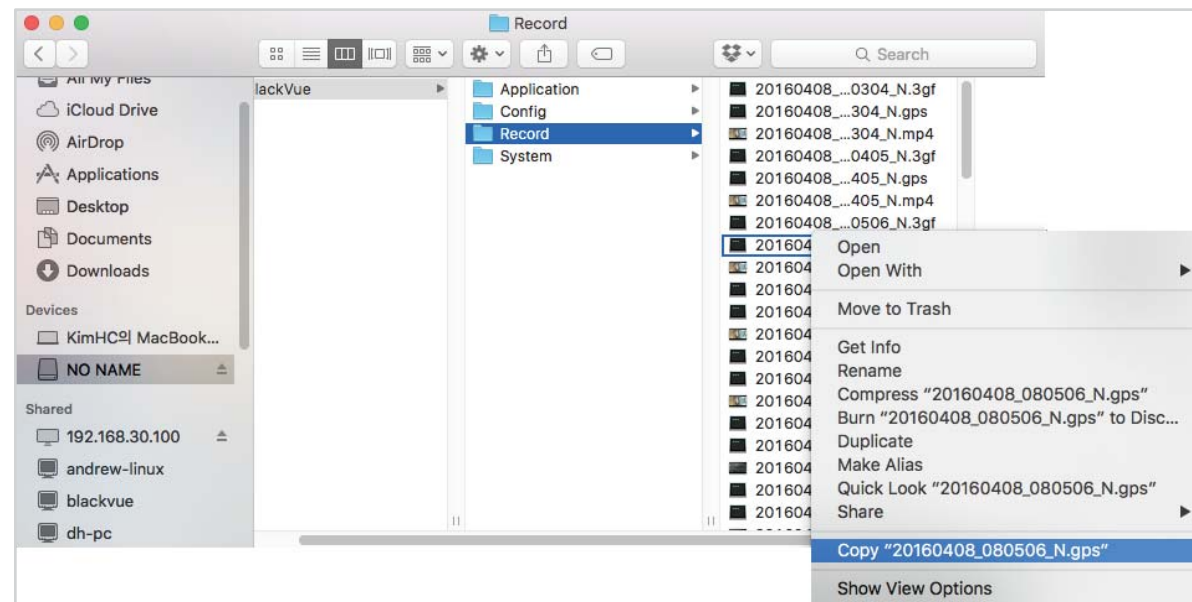

Tips for optimal performance

▶ Formatting the microSD card

⚠ Caution

- Back up necessary video files before formatting the microSD card. If you format the microSD card, all the video files stored in the microSD card will be deleted including the locked event files. Your saved settings will not be affected.

▶ Formatting the card in the BlackVue

Press and hold the Format button for 5 seconds and once voice instructions start, release the button. Then press and hold again for 5 seconds to format the microSD card.

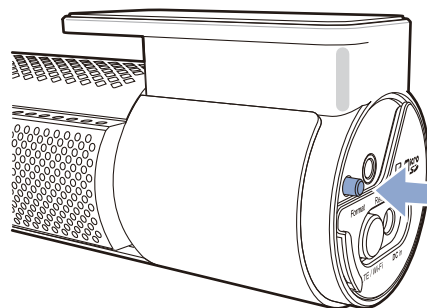

▶ Format using BlackVue Viewer (Windows)

Insert the microSD card into the microSD card reader and connect the reader to your computer.

Download **BlackVue Viewer (Windows)** from www.blackvue.com > **Support** > **Downloads** and install it on your computer.

Launch the **BlackVue Viewer** that is installed on your computer.

Click the  **Format** button, select the card drive and click OK.

➤ Format using BlackVue Viewer (macOS)

Insert the microSD card into the microSD card reader and connect the reader to your computer.

Download **BlackVue Viewer (Mac)** from www.blackvue.com > **Support** > **Downloads** and install it on your computer.

Launch the **BlackVue Viewer** that is installed on your computer.

Click the  Format button and select the microSD card from the list of drives in the left frame.

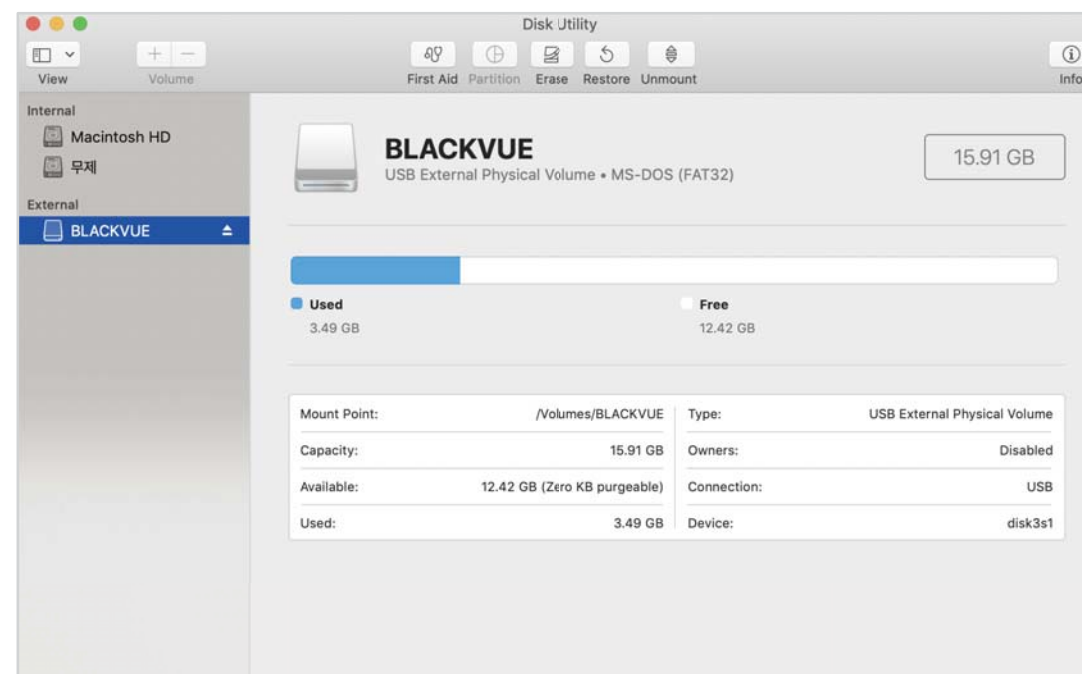

After selecting your microSD card select the Erase tab in the main window.

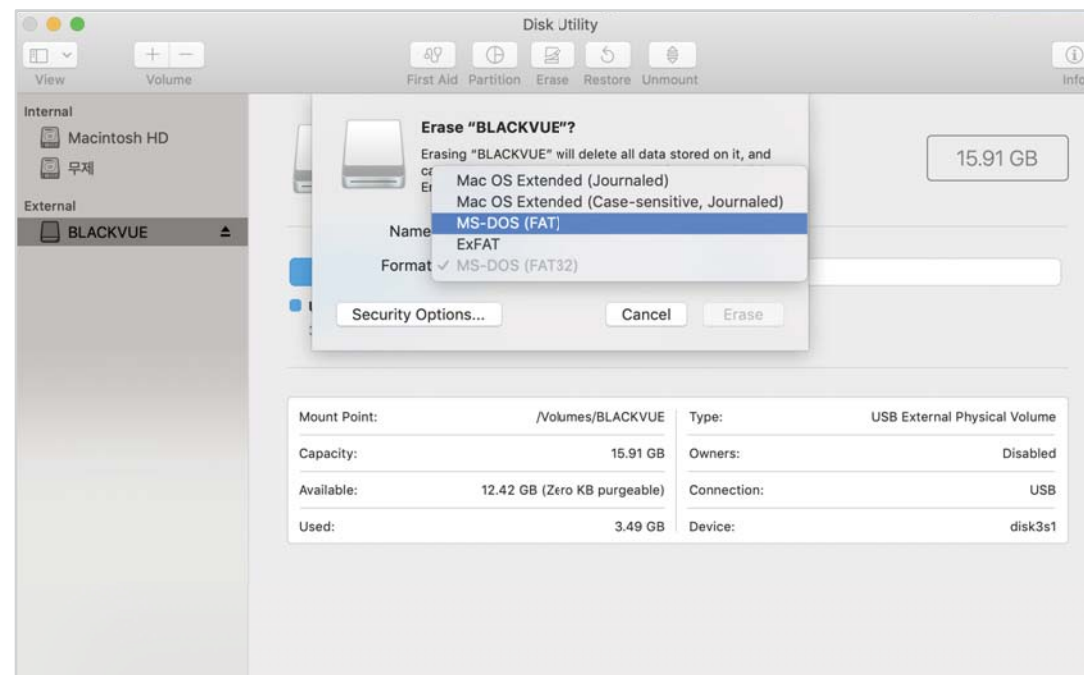

Select "MS-DOS (FAT)" from the Volume Format drop-down menu and click Erase.

Note

- Formatting the microSD card once a month is recommended.
- Format the microSD card if the recorded video quality appears to be poor.
- Only use official BlackVue microSD cards. Other cards may have compatibility issues. PittaSoft Co., Ltd. will not be held responsible for any problems caused by using another manufacturer's microSD card.
- For Windows users: To format the microSD card directly from "My Computer", right-click the microSD card drive and select Format. Select File system as FAT32 and Allocation unit size as 64KB then click Start. If FAT32 is not available or can't be selected, please format the microSD card using BlackVue Viewer.

Upgrading the firmware

Regularly upgrade the firmware for performance improvements and updated features. Firmware updates will be made available for download at www.blackvue.com > **Support** > **Downloads**.

Your saved settings are not affected by firmware upgrade.

Upgrading the firmware using an iOS or Android device (Firmware Over The Air)

Via Direct Wi-Fi

[Click here for a step-by-step video tutorial](#), or go to the main menu and select **Help** > **Video tutorials**.

Makes sure your smartphone has a stable internet connection.

Open the BlackVue app

Tap  and select **Firmware download**.

Select your dashcam model and the firmware language and tap **OK**.



Note

- Please select the firmware language currently installed in your dashcam. Once upgrade is completed, you can change the firmware language from dashcam settings as described on page **73** or **76**.

Check the firmware version and release notes and tap **OK** to start downloading.

After the download completes tap **OK** to be taken back to the home screen.

Make sure your BlackVue dashcam is on and nearby.

Go to your smartphone's **Settings** then select **Wi-Fi**, and make sure Wi-Fi is turned on.

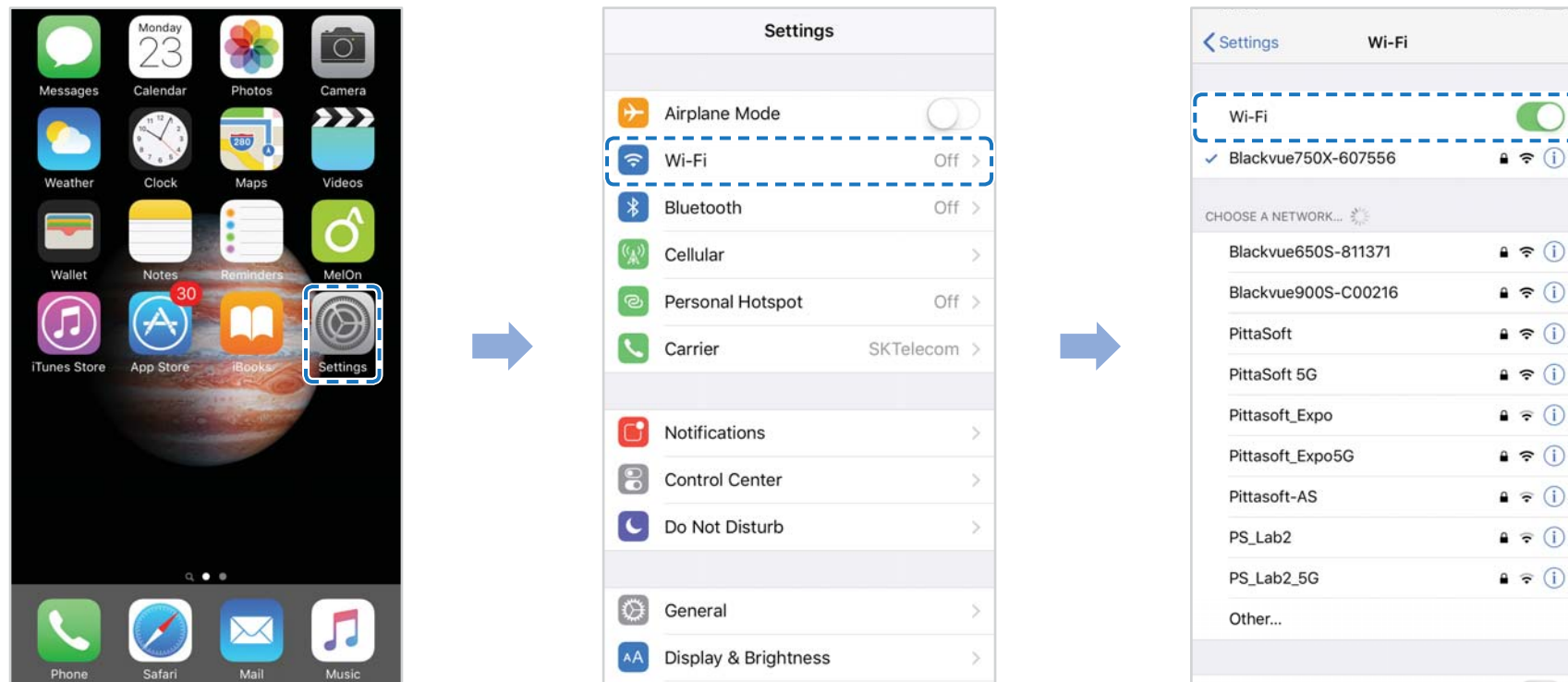

Choose your BlackVue dashcam from the network list. The dashcam's default SSID begins with its model number (e.g. BlackVue****_*****).

Enter the password and tap join.

* The default Wi-Fi SSID and password are labeled on the dashcam and product pad in the packaging box. To find them on the dashcam, unplug the cables and remove the front camera from its mount.

Open the BlackVue app. Select **BLACKVUE WI-FI** >  > **Firmware upgrade**.

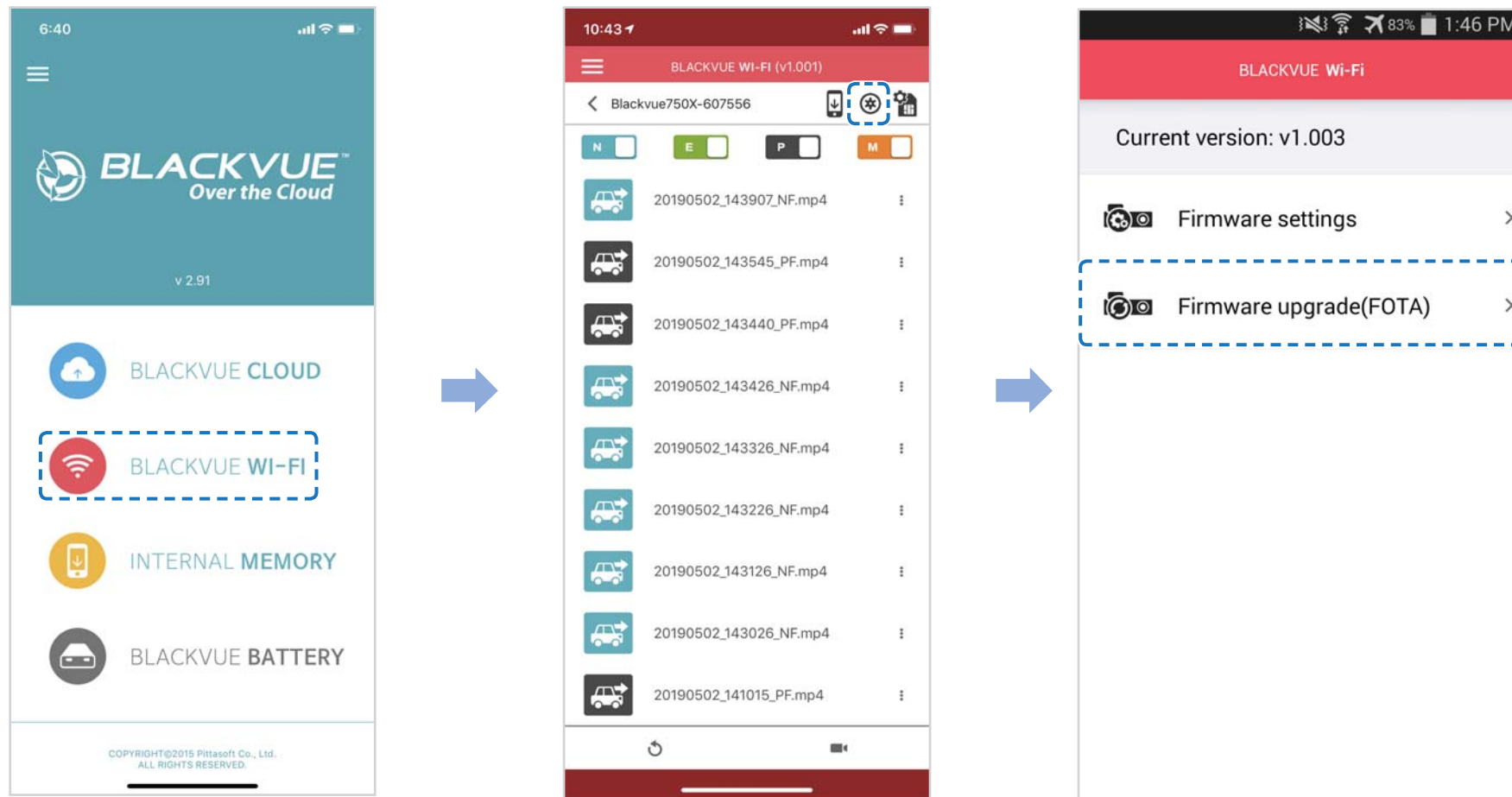

 **Note**

- The firmware version currently installed on the microSD card is shown first. Below it, the firmware version you downloaded in step 4 is shown.

Tap **OK** to apply the firmware upgrade.

The dashcam's firmware will be upgraded – this may take a few minutes. The dashcam will automatically reboot to complete the firmware upgrade.

 **Caution**

Please make sure the dashcam is powered on until normal recording starts after the upgrade is completed. Any power interruption may prevent the firmware upgrade from completing, resulting in malfunction of the dashcam.

»» Over the Cloud (Remote FW upgrade)

Note

- When a new firmware is available, an icon will show near your dashcam's name.
- The Firmware can only be upgraded when the dashcam is connected to Cloud.

Open the BlackVue app. Select BLACKVUE CLOUD. Tap the 3-dot icon.

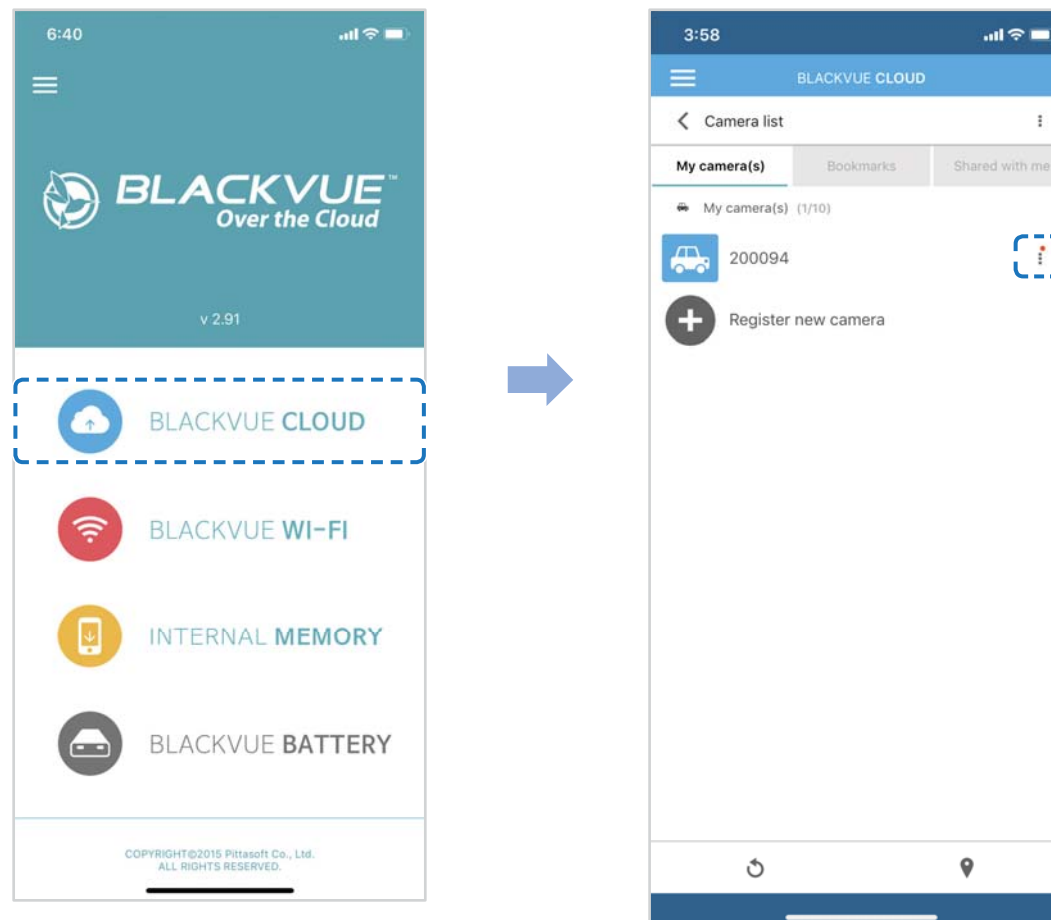

Remote firmware update > Update Now.

The dashcam will start downloading the firmware and automatically apply it.

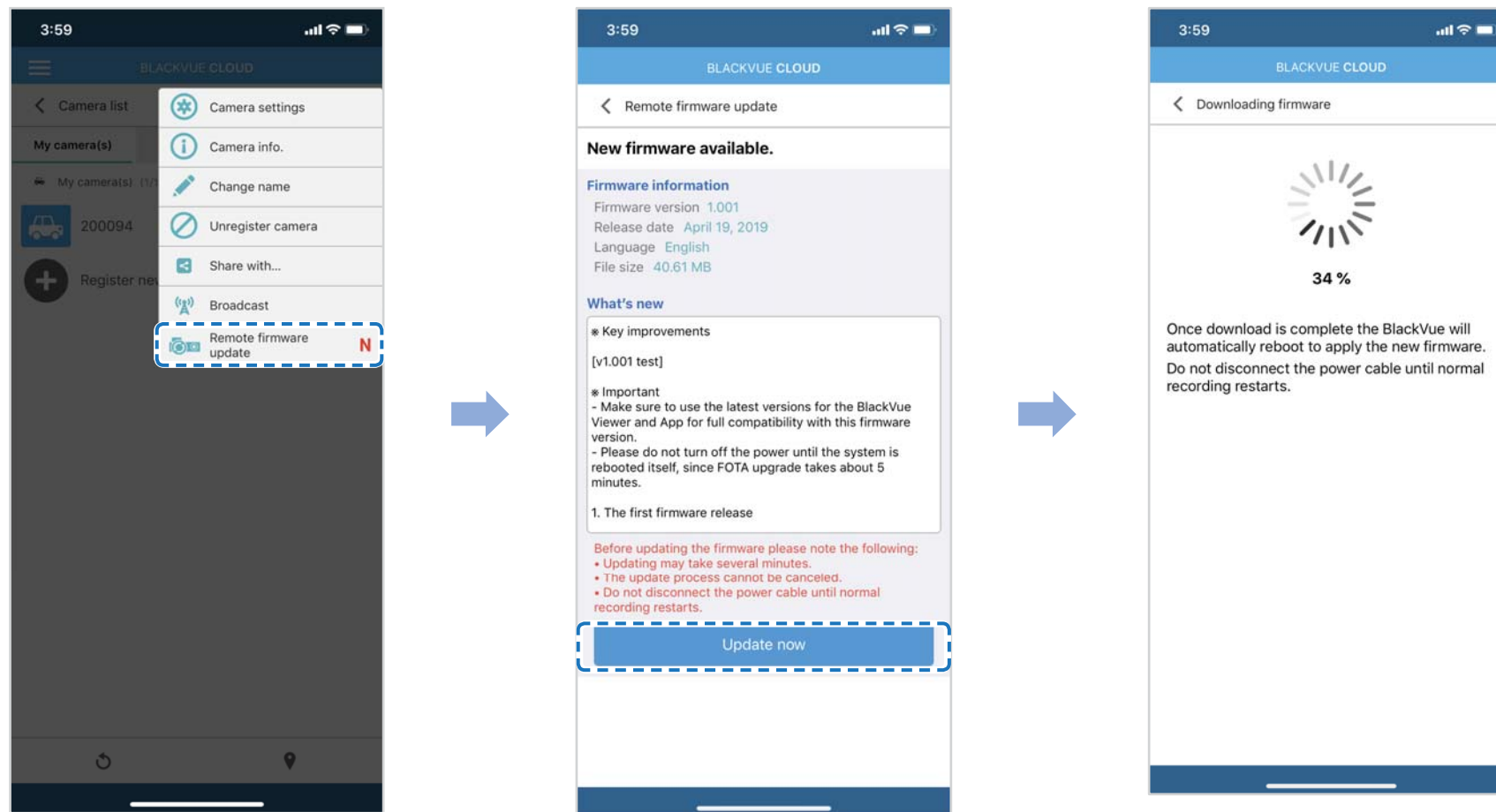

 **Caution**

Please make sure the dashcam is powered on until normal recording starts after the upgrade is completed. Any power interruption may prevent the firmware upgrade from completing, resulting in malfunction of the dashcam.

You will be notified once the upgrade is successful.

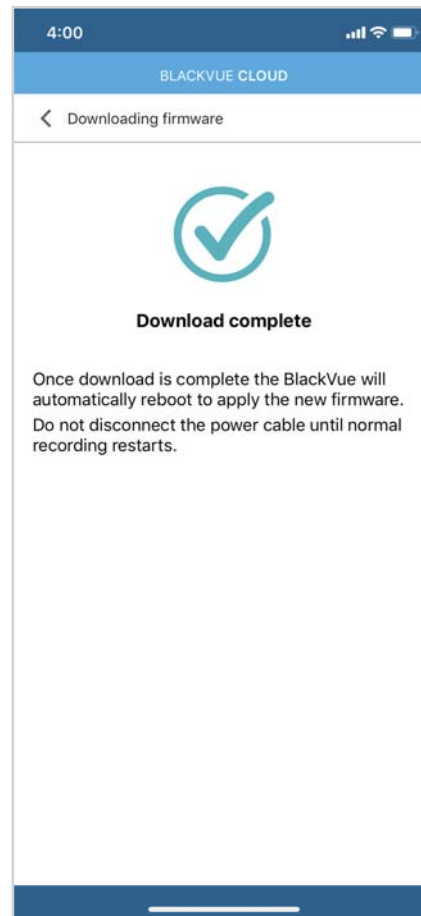

➤ Upgrading the firmware using a computer (Windows or macOS)

Keep your BlackVue dashcam updated by upgrading the firmware to the latest version. Visit the BlackVue website (www.blackvue.com) to check for any new firmware releases for your BlackVue dashcam model.

Insert the microSD card into the microSD card reader.

Connect the microSD card reader to a computer.

Launch BlackVue Viewer and click on the About  button.

- For Mac users, click  **BlackVue Viewer** and select About BlackVue from the menu.

Check the current firmware version of your BlackVue dashcam and proceed only if your version is not the latest one.

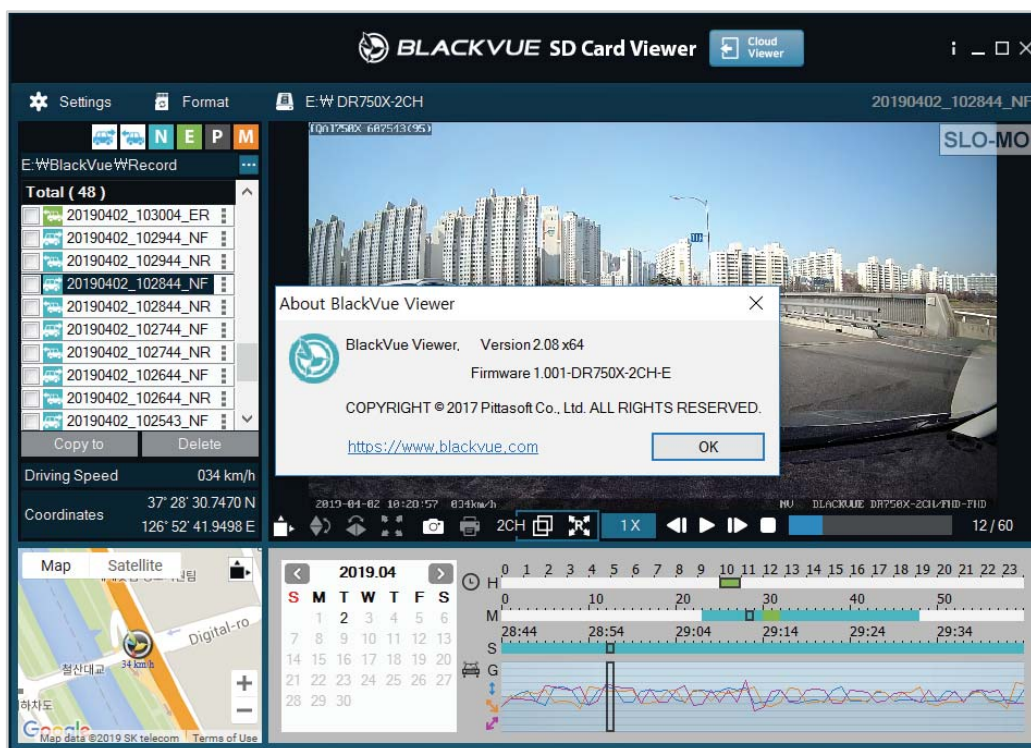

Windows

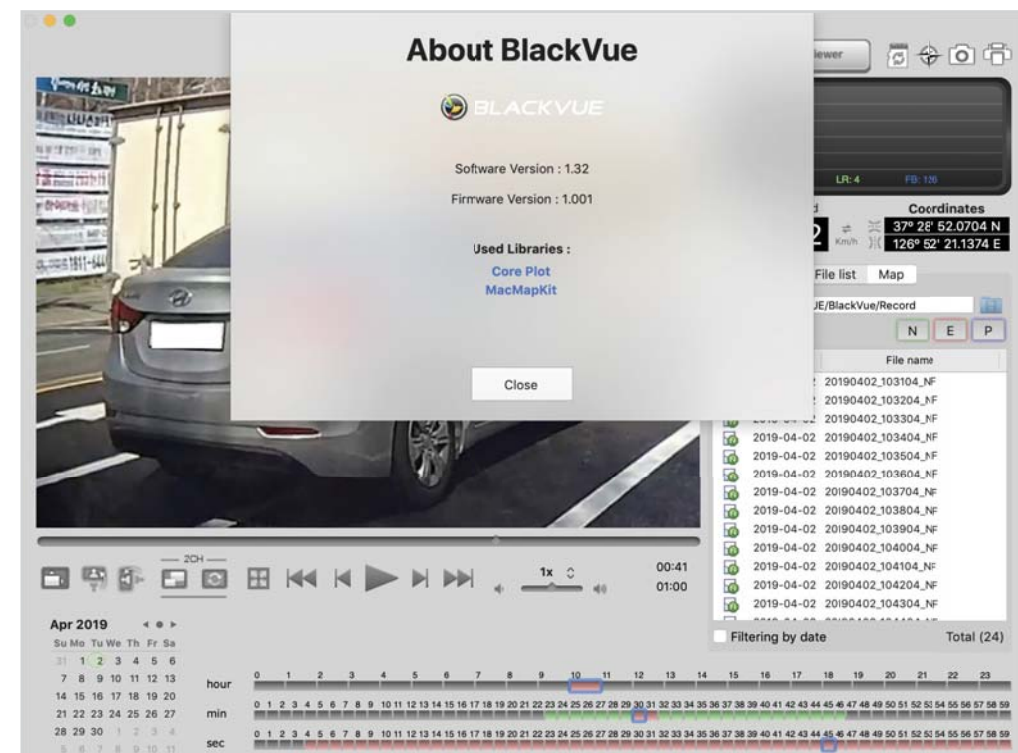

Mac

Format the microSD card. See "**Formatting the microSD card**" on page 45.

Go to the BlackVue website (www.blackvue.com > Support > Download) and download the latest firmware for your BlackVue dashcam model in zip format.

Unzip the downloaded file and copy the BlackVue folder to the microSD card.

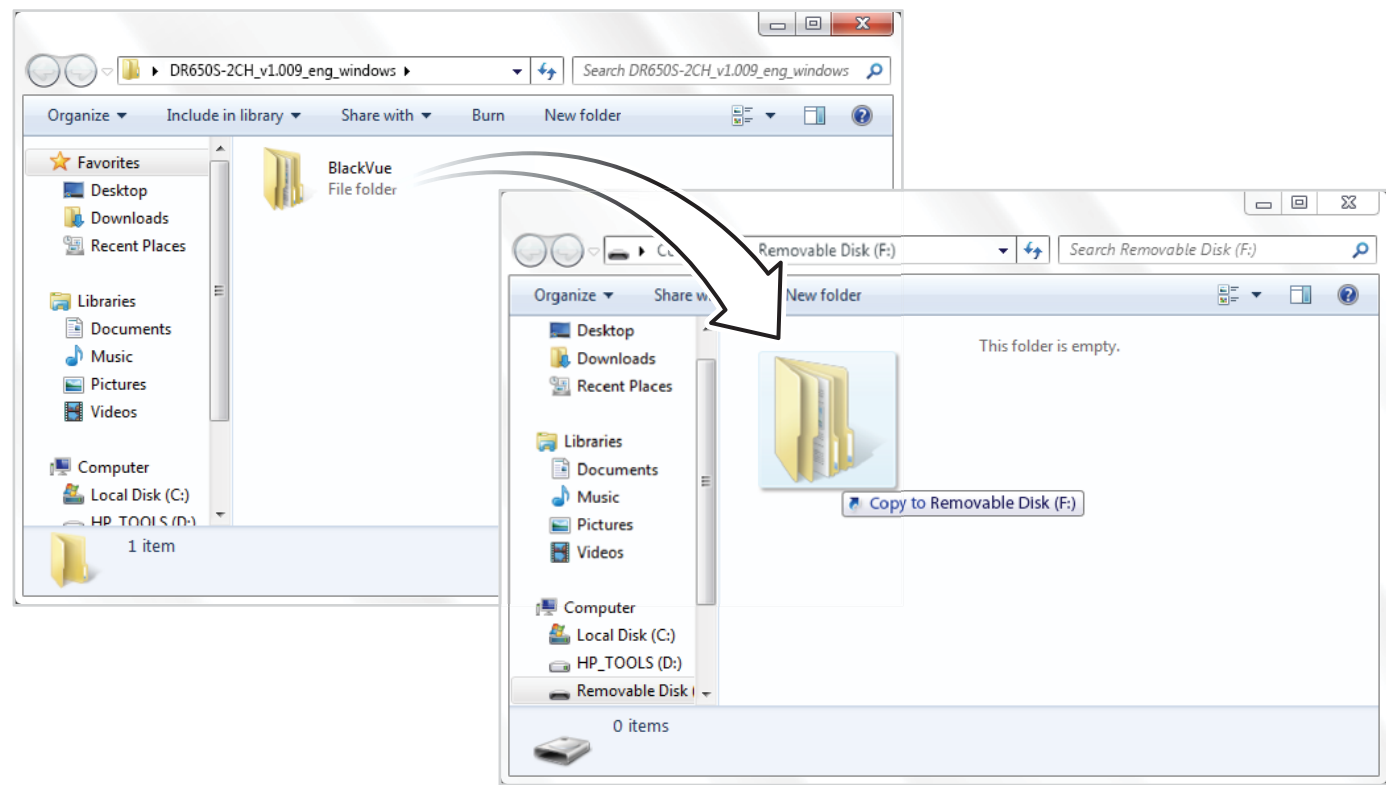

Insert the microSD card into the dashcam and connect the power to initiate the firmware upgrade. Make sure the power remains on until the upgrade is completed. **Any power interruption may prevent the firmware upgrade from completing, resulting in malfunction.**

 **Note**

- Do not insert or remove the microSD card when the dashcam is turned on. Doing so may damage the data and cause a malfunction of the microSD card.
- Your saved settings are not affected by firmware upgrade.
- The firmware is upgraded to the previously saved language. If you want to change it, please refer to page **73** or **76**.

Changing settings

▶ Changing settings using your smartphone (Android/iOS)

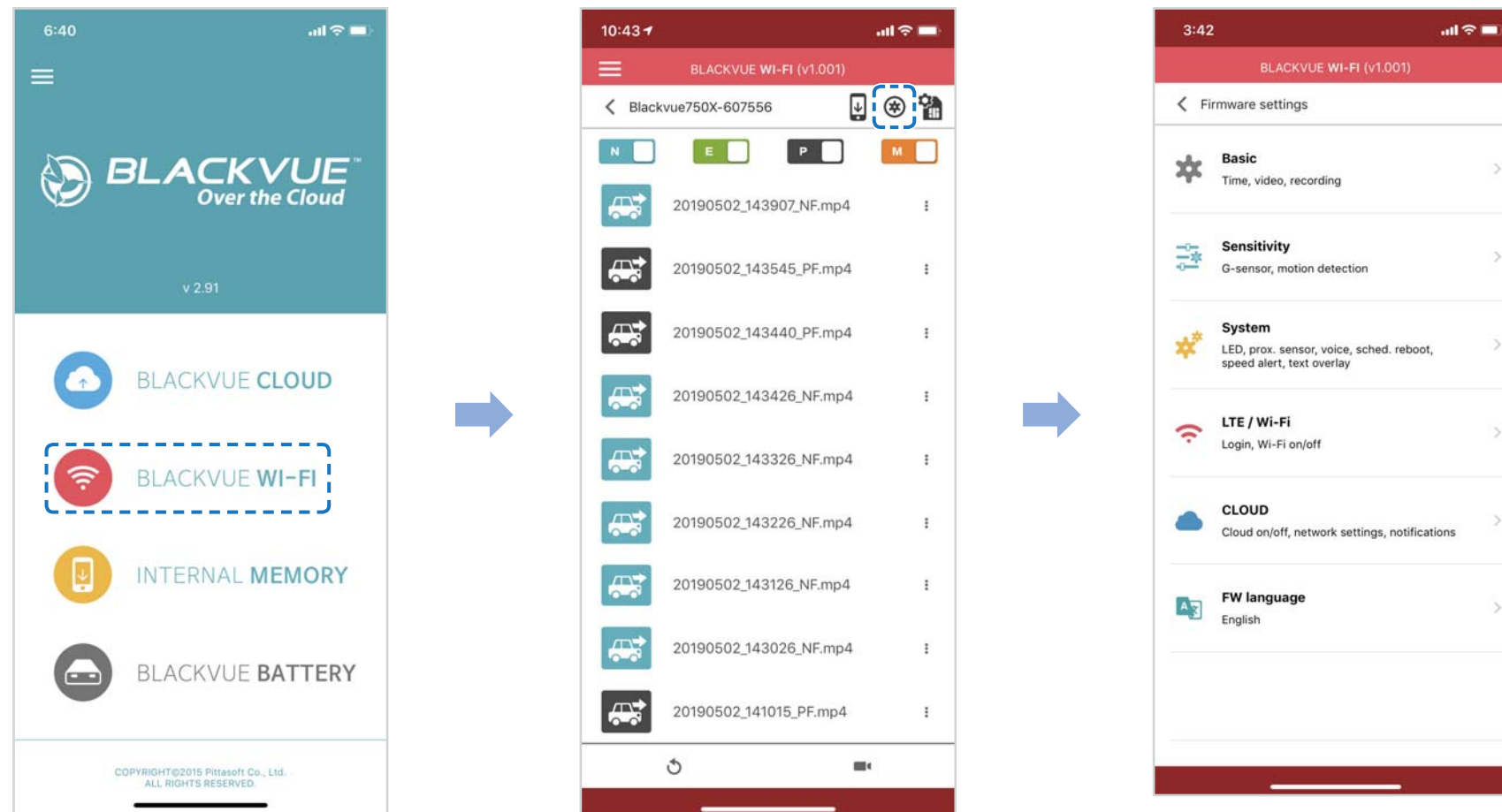

“Pair” your smartphone with the BlackVue dashcam via direct Wi-Fi (for details see **"Opening video files" on page 19**).

Go to your smartphone's **Settings** > **Wi-Fi** and connect to your dashcam.

Open the BlackVue app. Select **BLACKVUE WI-FI** >  to access the Firmware settings menu.

After making any changes, go back to the Firmware settings menu, tap  and tap **Save and close**.

 **Caution**

- Please backup necessary recordings before changing **time** and **image quality** settings. If any of the aforementioned settings are changed and saved, the dashcam will format the microSD card and delete all recordings stored on the card including locked event files in order to ensure optimal performance.

 **Basic settings**

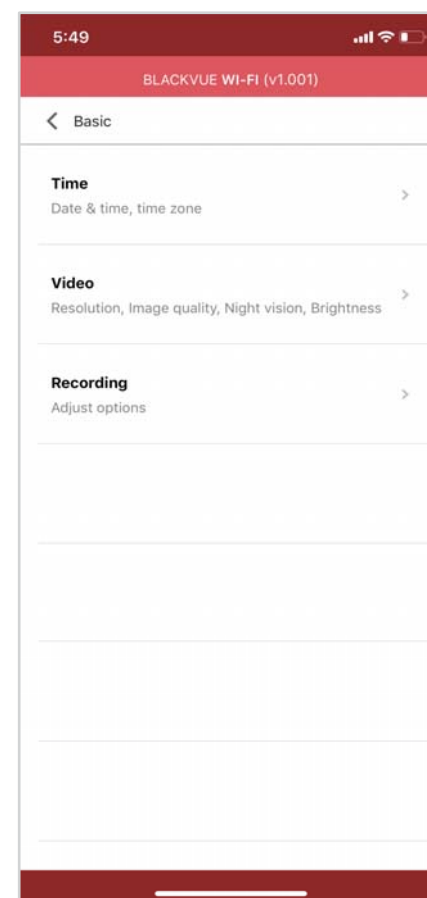
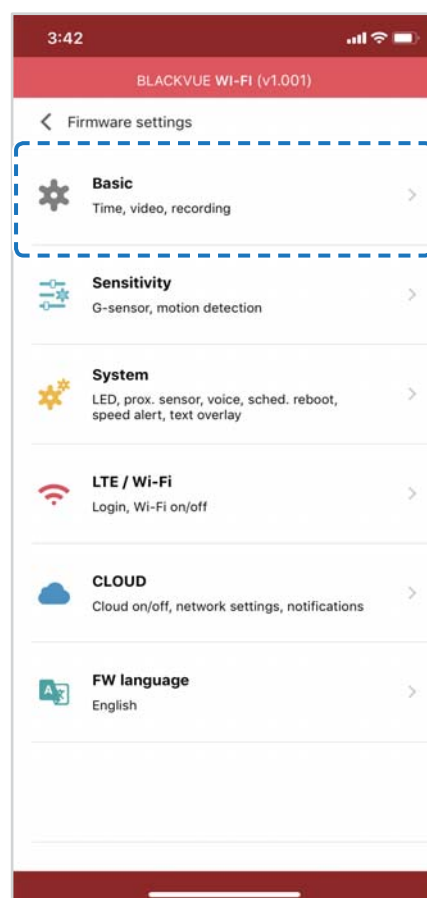

Time settings

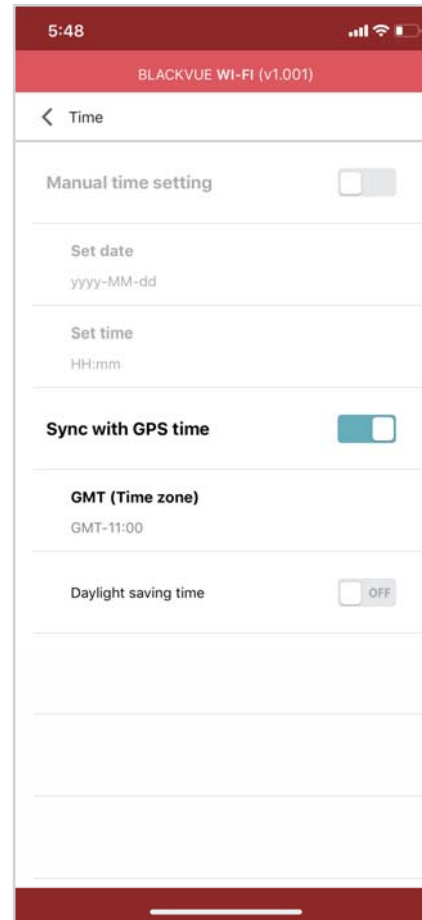

Select your time zone to auto-sync with GPS time or you can set the time and date manually after enabling **Manual time setting**.

 **Note**

- The factory setting is GMT -11.

Some examples of GMT time offsets are:

- GMT-7: Los Angeles
- GMT-4: New York
- GMT+0: London
- GMT+1: Paris
- GMT+3: Moscow
- GMT+8: Singapore
- GMT+9: Seoul
- GMT+10: Sydney

If you are unsure of your GMT offset please look up your city on <https://greenwichmeantime.com/>

* Selecting **Daylight saving time** will advance the clock by one hour.

- When setting the time manually, please set to the expected time you will use the BlackVue (not the present time).

Video settings

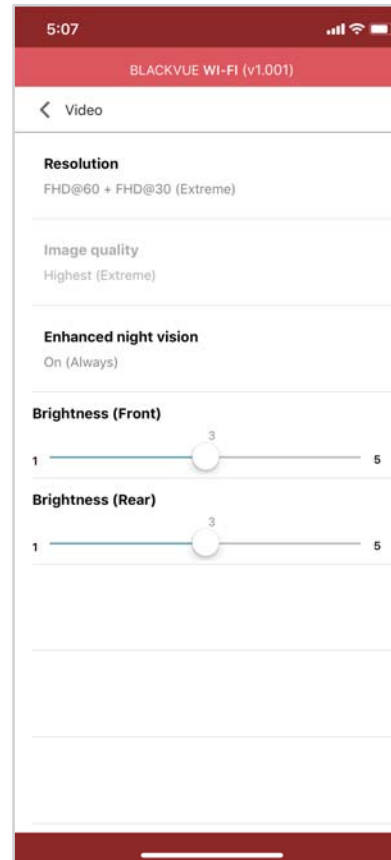

Image quality

At "FHD@60 + FHD@30" resolution is fixed. You can adjust the recording image quality (bit rate). Choose between:

- Highest(Extreme) (Front:25 Mbit/s, Rear: 10 Mbit/s)
- Highest (Front: 12 Mbit/s, Rear: 10 Mbit/s)
- High (Front: 10 Mbit/s, Rear: 8 Mbit/s)
- Normal (Front: 8 Mbit/s, Rear: 6 Mbit/s)

Increasing the image quality will increase the size of the video files. Loading and copying time will increase accordingly. If your phone does not support video streaming at the 'highest' image quality setting, please copy the recording to your phone and play from internal memory. Alternatively, you can choose "Quick playback" option from the App settings.

■ **Enhanced night vision**

The dashcam has an intrinsic night vision feature. If you want to enhance it, enable Enhanced night vision - you can choose to have it turned on all the time, or have it active only in parking mode.

■ **Brightness (Front)**

You can adjust the recording brightness level of the front camera.

■ **Brightness (Rear)**

You can adjust the recording brightness level of the rear camera.

Recording settings

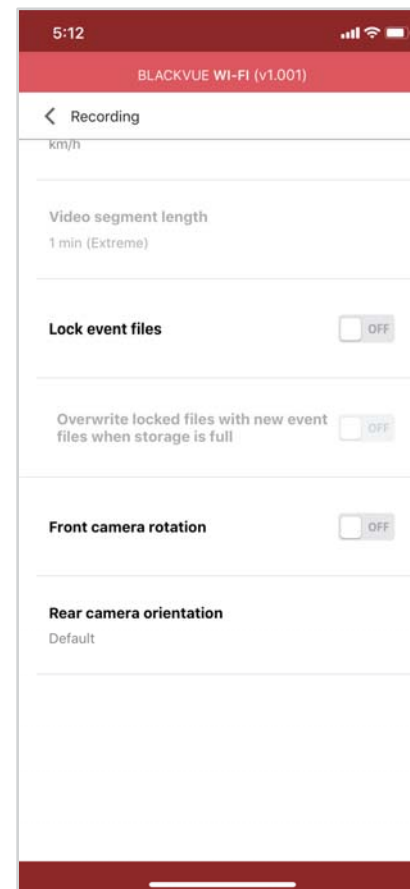
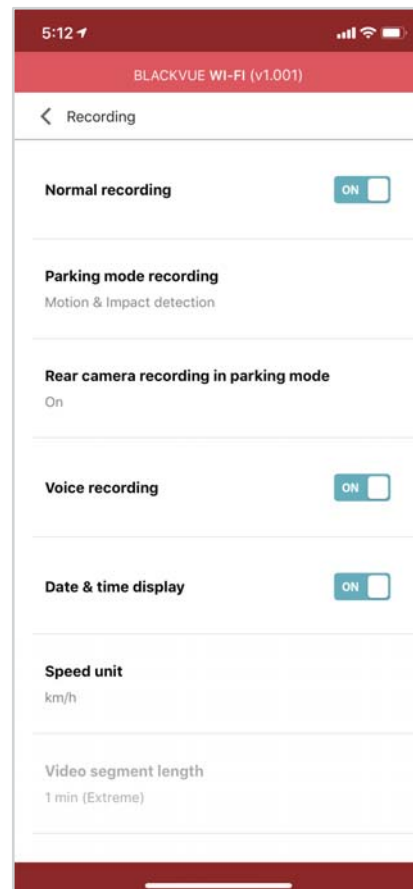

Normal recording

When turned off the dashcam does not record in normal mode.

Parking mode recording

If enabled, the dashcam switches from normal mode to parking mode when the vehicle is stationary for 5 minutes. There are two parking mode options. Choose "Motion & Impact detection" to save a parking recording when motion is detected in the dashcam's field of view. If the G-sensor detects an impact/bump the dashcam saves a separate event recording file.

Alternatively, if you choose "Time-Lapse" the camera continuously records 1 frame per second and saves recordings that playback at 30 times normal speed. If the G-sensor detects an impact/bump the camera saves a separate event recording file at normal speed.

■ Rear camera recording in parking mode

When turned on, the front and rear camera record together.

When turned off, the rear camera stops recording 5 minutes after entering parking mode. Rear camera recording restarts when entering normal mode.

■ Voice recording

When turned off the dashcam does not record audio.

■ Date & time display

Turn on/off the date and time display on videos.

■ Speed unit

Select km/h, MPH, or turn off.

■ Lock event files

Turning on this option will lock the following recording types and stop them from being overwritten by newer recordings:

- Impact event recordings during normal and parking mode (E); and
- Manual recordings (M).

A maximum of 50 files can be locked. Once this limit is reached, to lock new recordings please review locked files on the microSD card and free up space, or enable 'Overwrite locked files with new event files when storage is full' to allow the oldest locked files to be overwritten.

■ Front camera rotation

If you installed the front camera in a flipped position, use this setting to rotate the front camera image 180°.

■ Rear camera orientation

Use this setting to rotate the rear camera image 180° or mirror the video.

Sensitivity settings

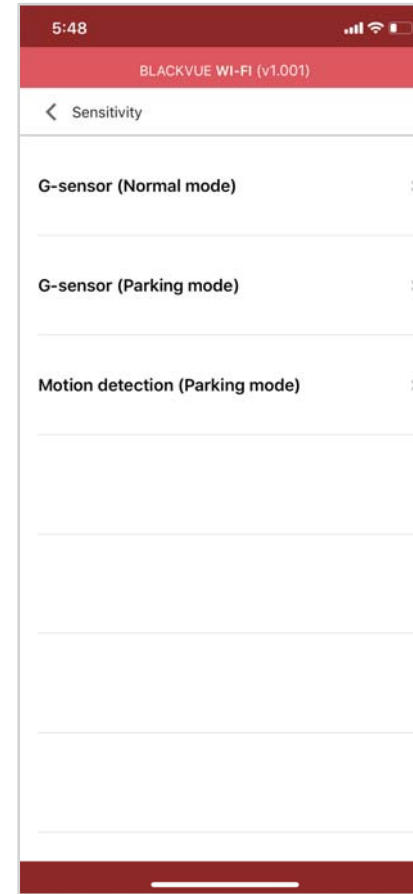
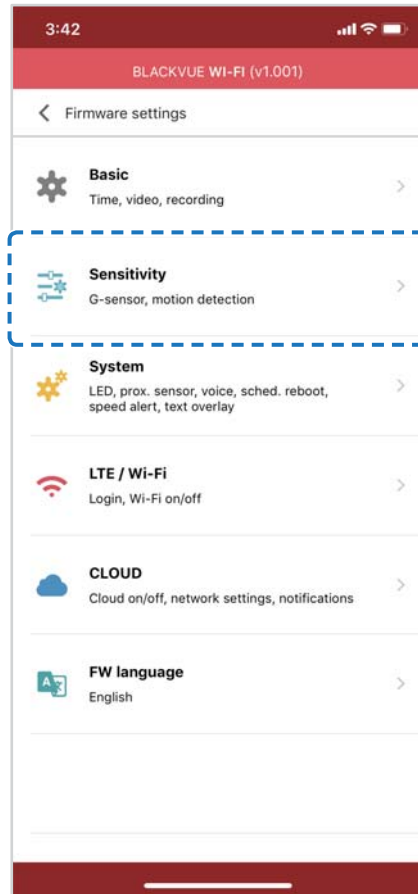

□ G-Sensor (Normal mode)/G-Sensor (Parking mode)

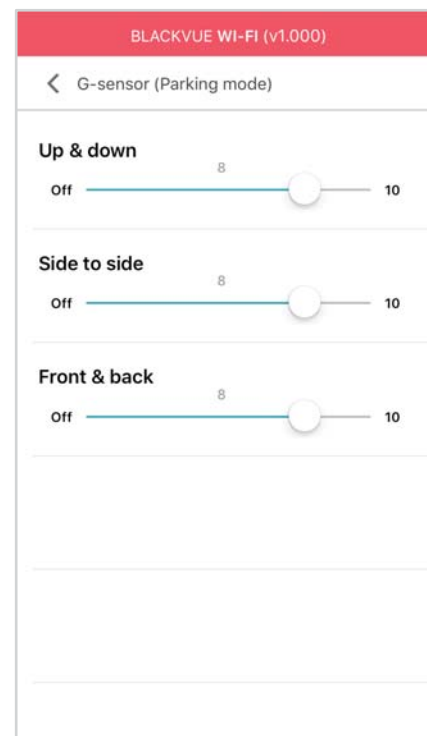
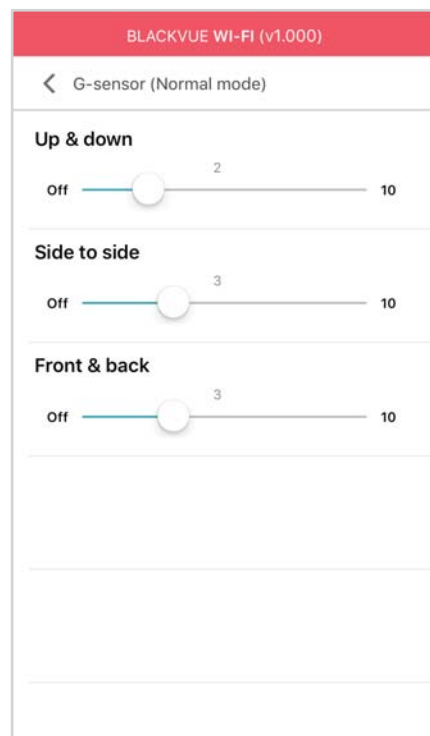

The G-sensor measures the movement of your vehicle through 3 axes – up and down, side to side, and front and back. When the G-sensor detects significant or sudden movement (such as an impact or collision) it will trigger an event recording. You can adjust the sensitivity so minor incidents and bumps don't trigger an event recording. To turn off event recordings by impact detection set the G-sensor sensitivity to off.

Motion detection (Parking mode)

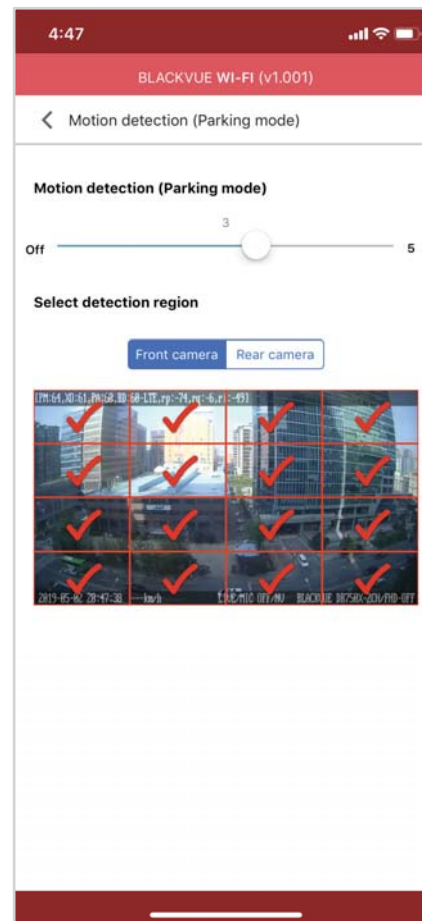

In Motion Detection Parking Mode the dashcam continuously buffers video and saves a parking recording when motion is detected in the dashcam's field of view.

You can adjust the sensitivity of the motion detection so minor motion caused by wind or rain doesn't trigger a recording. Please take into account your vehicle's surroundings when adjusting the sensitivity. You can also choose the detection regions to reduce the risk of triggering unwanted motion recordings due to trees swaying in the wind, far-away moving objects, etc. By default, all the regions are selected. If you want to ignore motion detection in particular region(s), unselect them.

System settings

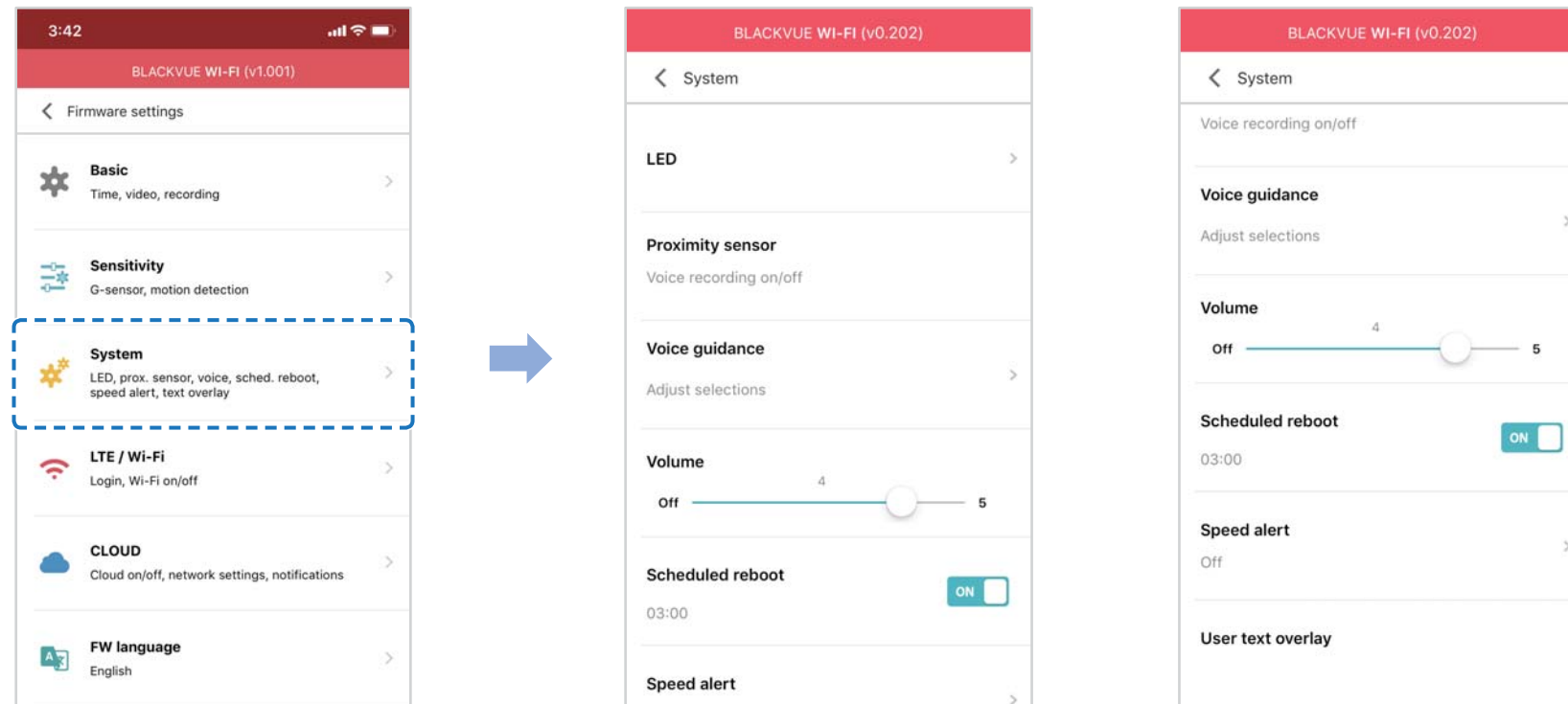

LED

Recording status

You can turn the recording status LED on/off.

Front security (Normal mode)

You can turn the front security LED on/off for normal mode.

Front security (Parking mode)

You can turn the front security LED on/off for parking mode.

Rear security

You can turn the rear security LED on/off.

LTE/Wi-Fi

You can turn the LTE/Wi-Fi LED on/off.

Proximity Sensor

You can choose the function of the proximity sensor. Available options are:

- Turn on/off audio recording (default)
- Manual recording trigger

The sensor can also be disabled completely.

Voice guidance

You can adjust the voice guidance (announcements) you want to hear.

Impact detected in parking mode

Notifies when exiting parking mode if an impact had been detected during parking mode, however, it ignores any impact detected within three minutes before exiting parking mode.

Volume

You can adjust the volume of the voice guidance (announcements).

Scheduled Reboot

The dashcam reboots automatically once-a-day if in parking mode at the set time for improved stability. If the dashcam is recording at the set time, the scheduled reboot is skipped.

You can enable/disable and change the time for scheduled rebooting. Default time is 03:00 am.

Speed alert

Set a speed limit (up to 300 km/h or 200 MPH) for the speed alert. When the vehicle exceeds the specified speed limit, the dashcam beeps and switches to event recording. After saving one event recording file the dashcam switches back to normal mode recording.

User text overlay

You can create a user text overlay of up to 20 characters using a combination of English letters (A – Z, a – z), numbers (0 – 9), and symbols (:;'/+_-)\$#). The text is overlaid in the top-left corner of the recorded videos.

LTE/Wi-Fi

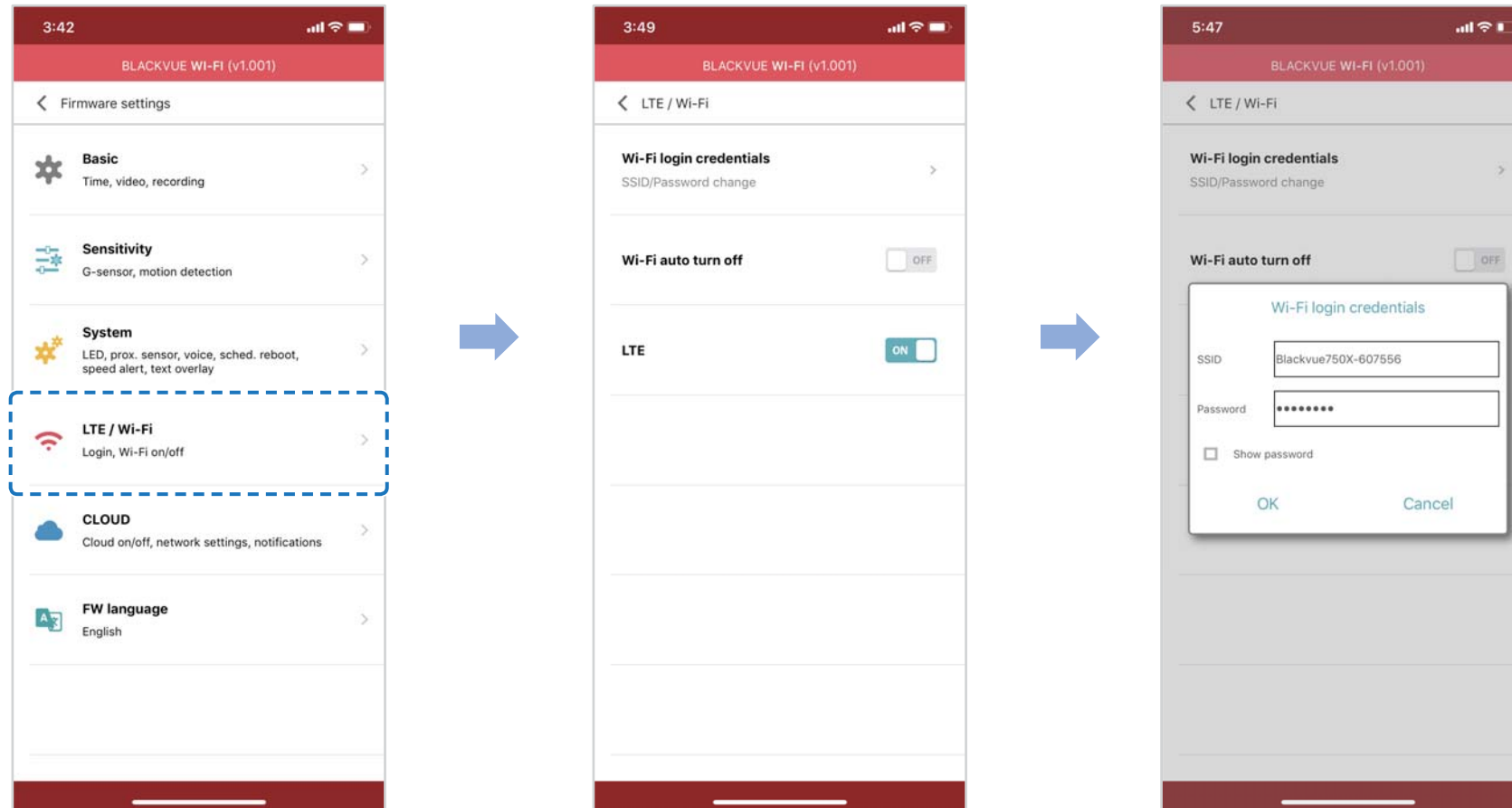

Wi-Fi login credentials

You can change the dashcam's SSID and Wi-Fi login password.

Wi-Fi auto turn off

When "Wi-Fi Auto turn off" is enabled, the Wi-Fi will automatically turn off if it is inactive for 10 minutes. If disabled, the Wi-Fi stays on all the time.

You can press the physical Wi-Fi button on the dashcam anytime to manually switch the Wi-Fi on/off.

➤ Cloud settings

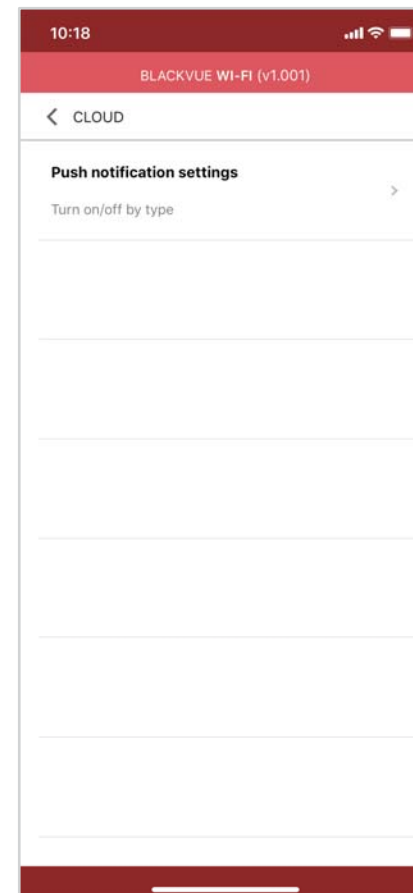
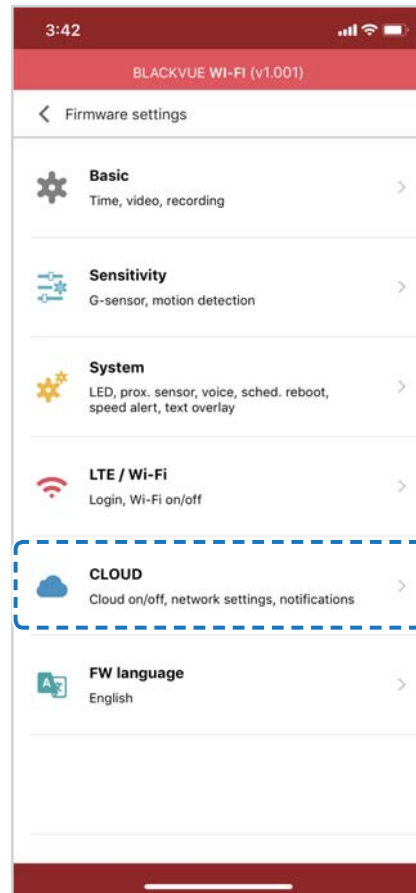

ENGLISH

Push notification settings

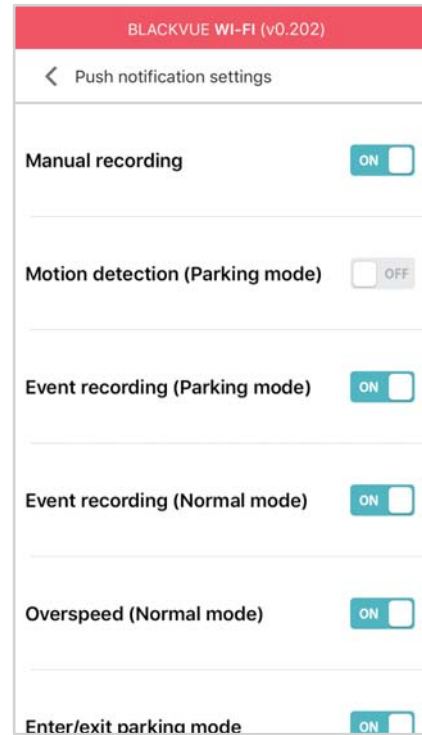

You can customize when you want to receive push notifications.

➤ FW Language

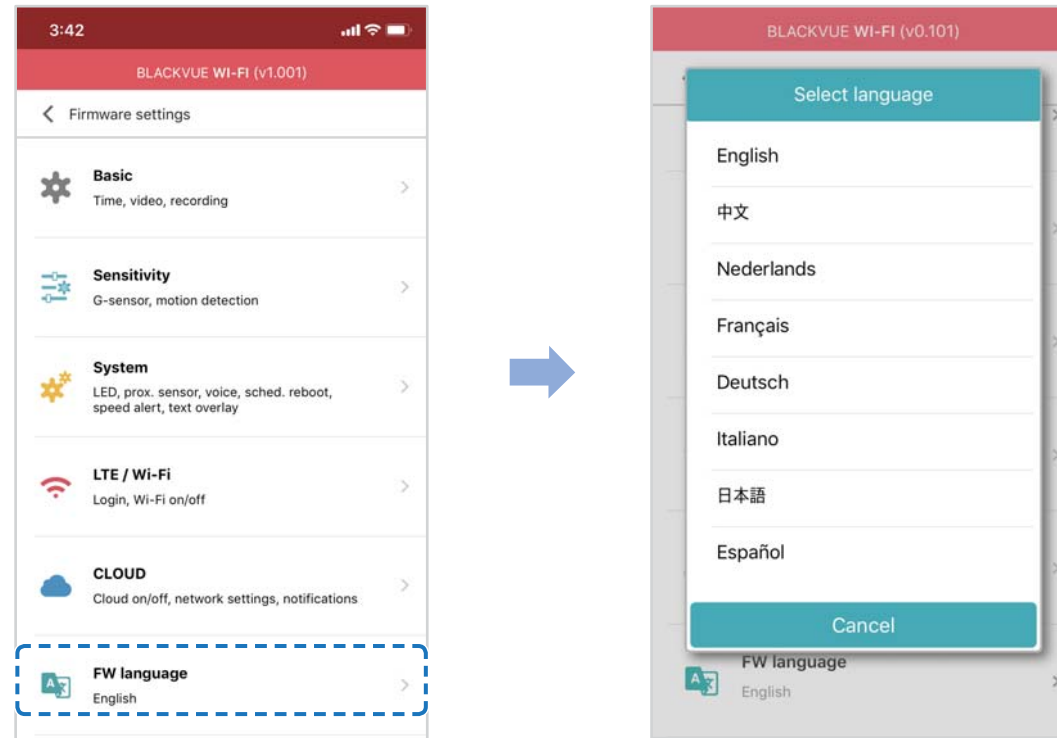

You can change the Firmware language of your dashcam.

ENGLISH

▶ Changing settings using your computer (Windows/Mac)

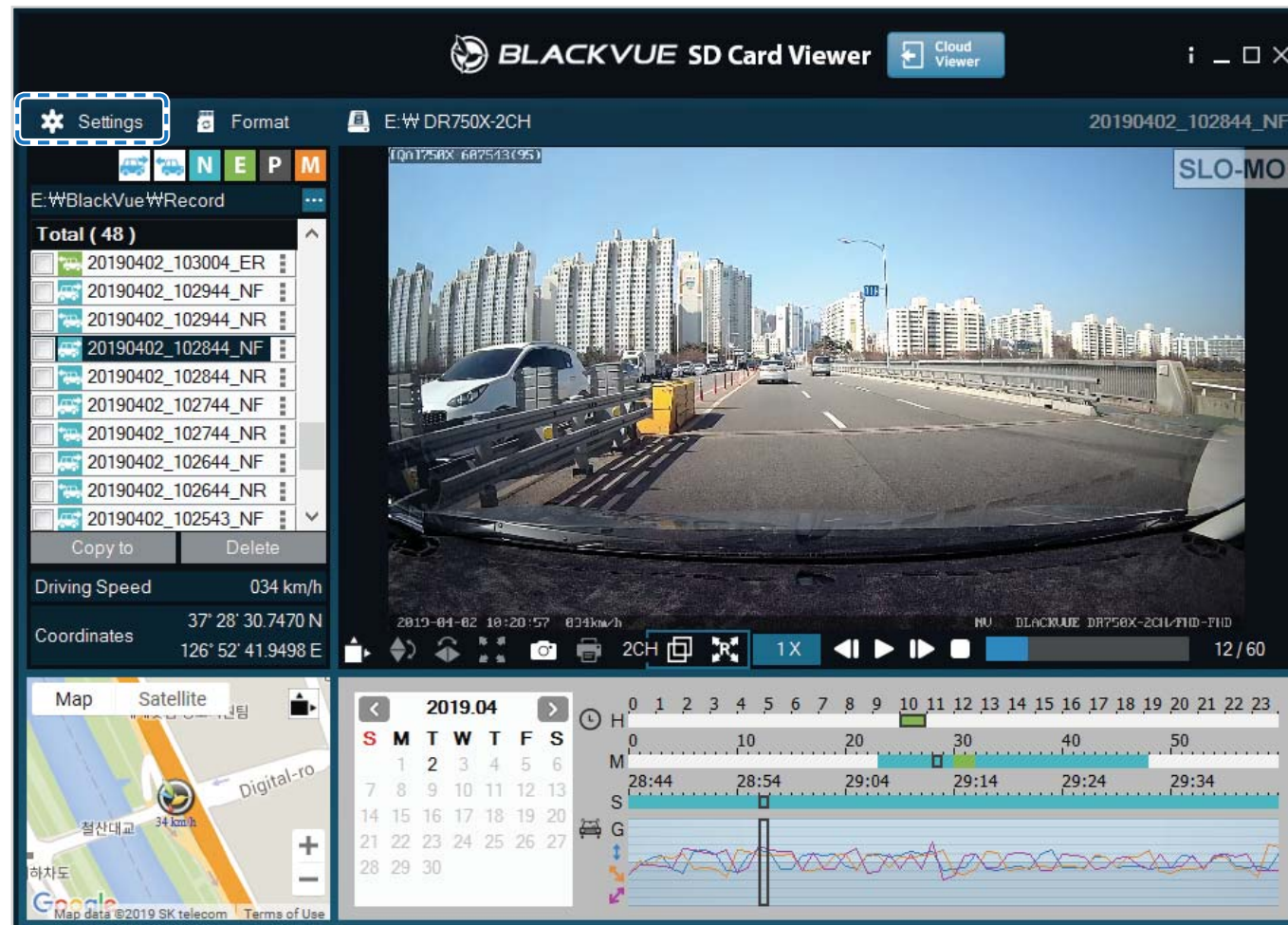

Click on the **Settings** Settings button (Windows) or the **BlackVue Viewer** menu (mac OS) to open the BlackVue settings panel. You will be able to change most of the BlackVue settings to customize its operation.

BlackVue Viewer settings

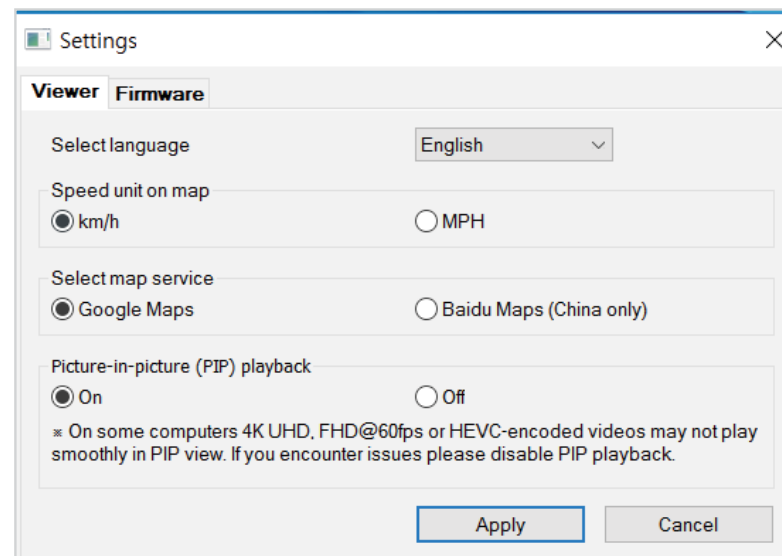

Select language

Select your preferred language for the BlackVue Viewer interface from the dropdown list.

Speed unit on map

Change the speed unit displayed on the map.

Select map service

Change the mapping service used.

Picture-in-picture(PIP)playback

On some computers videos may not play smoothly in PIP view. If you encounter issues please disable PIP playback.

Firmware settings

Select your preferred language for the firmware from the FW language dropdown list. The audio announcements by the dashcam will be in the selected language.

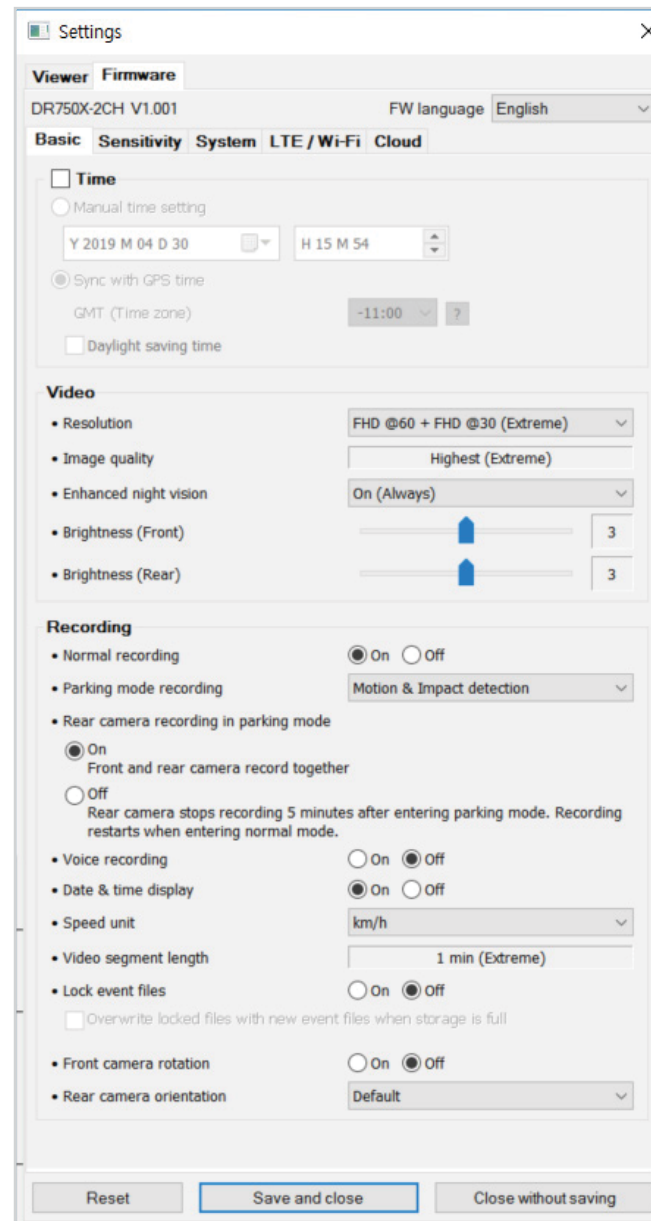

Caution

- Please backup necessary recordings before changing **time** and **image quality** settings. If any of the aforementioned settings are changed and saved, the dashcam will format the microSD card and delete all recordings stored on the card including locked event files in order to ensure optimal performance.

Basic settings

Time settings

Select your time zone to auto-sync with GPS time or you can set the time and date manually after enabling **Manual time setting**.

 **Note**

- The factory setting is GMT -11.

Some examples of GMT time offsets are:

- GMT-7: Los Angeles
- GMT-4: New York
- GMT+0: London
- GMT+1: Paris
- GMT+3: Moscow
- GMT+8: Singapore
- GMT+9: Seoul
- GMT+10: Sydney

If you are unsure of your GMT offset please look up your city on <https://greenwichmeantime.com/>

* Selecting **Daylight saving time** will advance the clock by one hour.

- When setting the time manually, please set to the expected time you will use the BlackVue (not the present time).

■ Video settings

– Image quality

At "FHD@60+FHD@30" solution is fixed. You can adjust the recording image quality (bit rate). Choose between:

- Highest(Extreme) (Front:25 Mbit/s, Rear: 10 Mbit/s)
- Highest (Front: 12 Mbit/s, Rear: 10 Mbit/s)
- High (Front: 10 Mbit/s, Rear: 8 Mbit/s)
- Normal (Front: 8 Mbit/s, Rear: 6 Mbit/s)

Increasing the image quality will increase the size of the video files. Loading and copying time will increase accordingly.

– Enhanced night vision

The dashcam has an intrinsic night vision feature. If you want to enhance it, enable Enhanced night vision - you can choose to have it turned on all the time, or have it active only in parking mode.

– Brightness (Front)

You can adjust the recording brightness level of the front camera.

– Brightness (Rear)

You can adjust the recording brightness level of the rear camera.

■ Recording settings

– Normal recording

When turned off the dashcam does not record in normal mode.

– **Parking mode recording**

If enabled, the dashcam switches from normal mode to parking mode when the vehicle is stationary for 5 minutes. There are two parking mode options. Choose "Motion & Impact detection" to save a parking recording when motion is detected in the dashcam's field of view. If the G-sensor detects an impact/bump the dashcam saves a separate event recording file.

Alternatively, if you choose "Time lapse" the camera continuously records 1 frame per second and saves recordings that playback at 30 times normal speed. If the G-sensor detects an impact/bump the camera saves a separate event recording file at normal speed.

– **Rear camera recording in parking mode**

When turned on, the front and rear camera record together.

When turned off, the rear camera stops recording 5 minutes after entering parking mode. Rear camera recording restarts when entering normal mode.

– **Voice recording**

When turned off the dashcam does not record audio.

– **Date & time display**

Turn on/off the date and time display on videos.

– **Speed unit**

Select km/h, MPH, or turn off.

– **Lock event files**

Turning on this option will lock the following recording types and stop them from being overwritten by newer recordings:

- Impact event recordings during normal and parking mode (E); and
- Manual recordings (M).

A maximum of 50 files can be locked. Once this limit is reached, to lock new recordings please review locked files on the microSD card and free up space, or enable 'Overwrite locked files with new event files when storage is full' to allow the oldest locked files to be overwritten.

– **Front camera rotation**

If you installed the front camera in a flipped position, use this setting to rotate the front camera image 180°.

– **Rear camera orientation**

Use this setting to rotate the rear camera image 180° or mirror the video.

□ Sensitivity settings

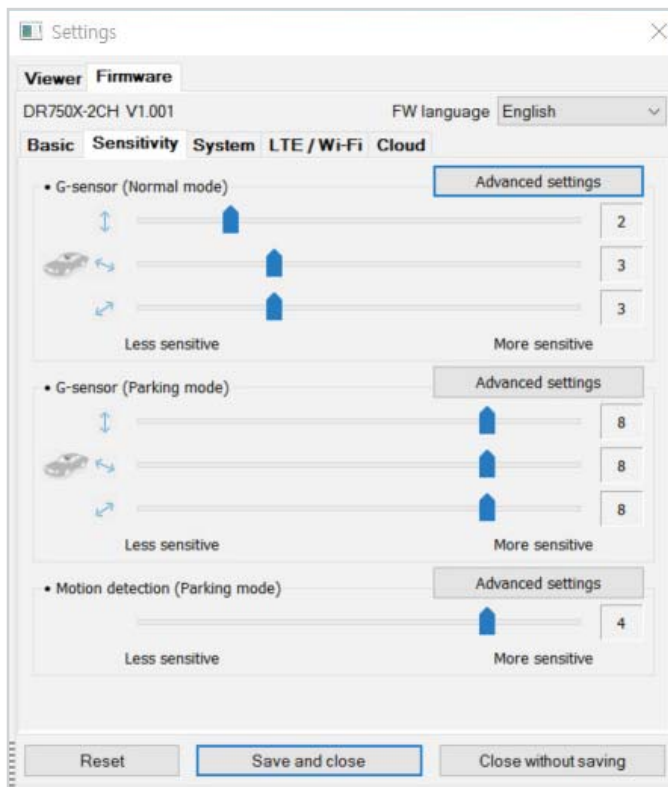

■ G-Sensor (Normal mode)/G-Sensor (Parking mode)

The G-sensor measures the movement of your vehicle through 3 axes – up and down, side to side, and front and back. When the G-sensor detects significant or sudden movement (such as an impact or collision) it will trigger an event recording. You can adjust the sensitivity so minor incidents and bumps don't trigger an event recording. To turn off event recordings by impact detection set the G-sensor sensitivity to off.

■ Motion detection (Parking mode)

In Motion Detection (Parking mode), the dashcam continuously buffers video and saves a parking recording when motion is detected in the dashcam's field of view.

You can adjust the sensitivity of the motion detection. Please take into account your vehicle's surroundings when adjusting the sensitivity.

■ Advanced sensitivity settings for normal and parking mode

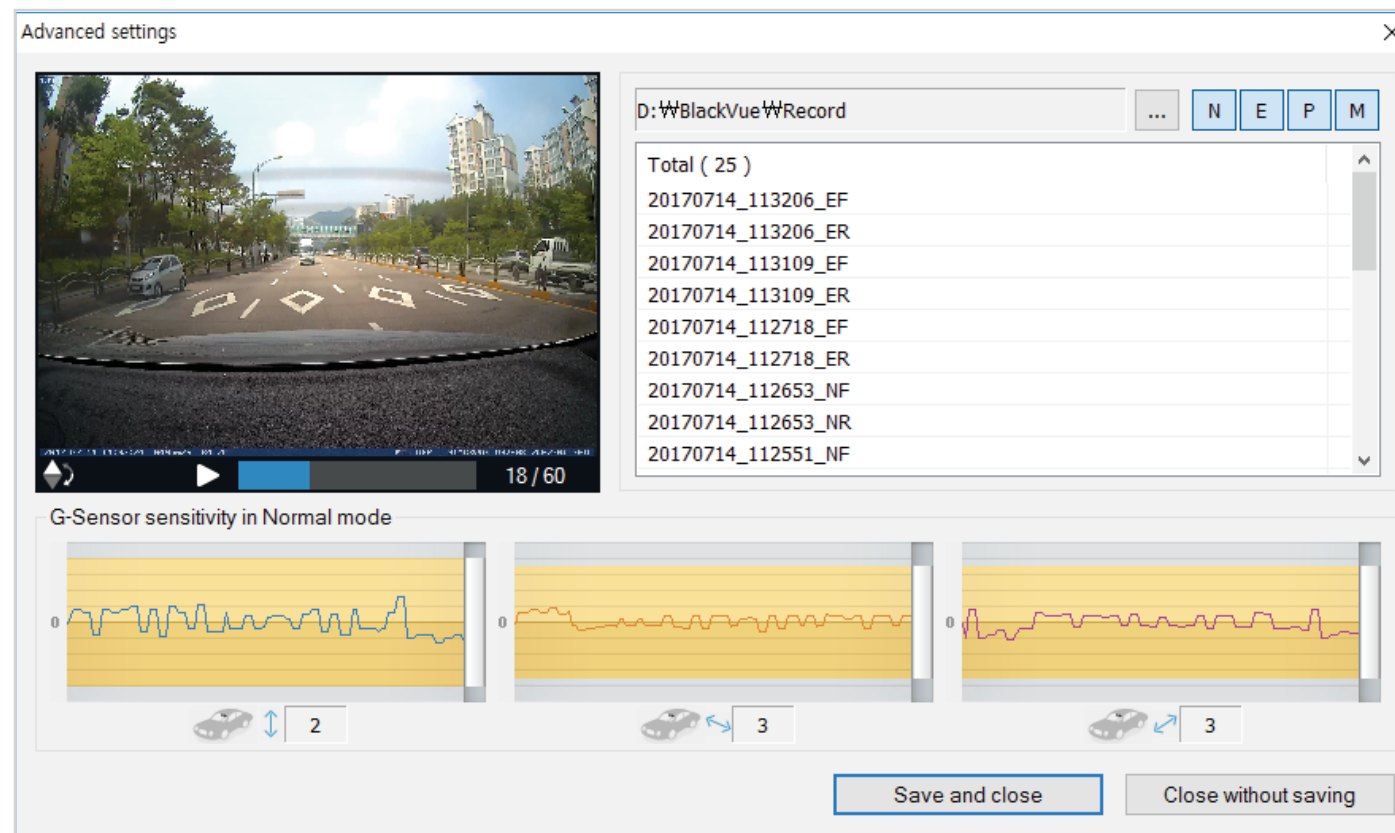

Advanced sensitivity settings allows you to fine-tune the event recording G-Sensor threshold, while watching pre-recorded G-Sensor data and video as a reference.

Click the **Advanced settings** button.

Double click the video from the list that you want to use as a G-Sensor data reference.

Set the thresholds by adjusting the control bars next to each G-Sensor axis. Any G-Sensor data that crosses over the threshold on any of the 3 axes will trigger an Event recording.

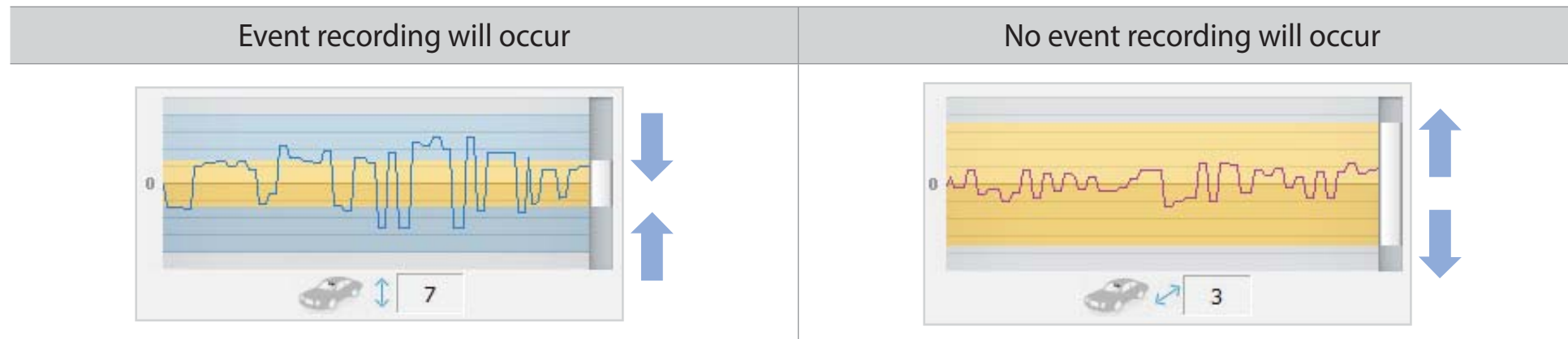

Click **Save and close**.

■ Advanced motion detection settings (Region selection)

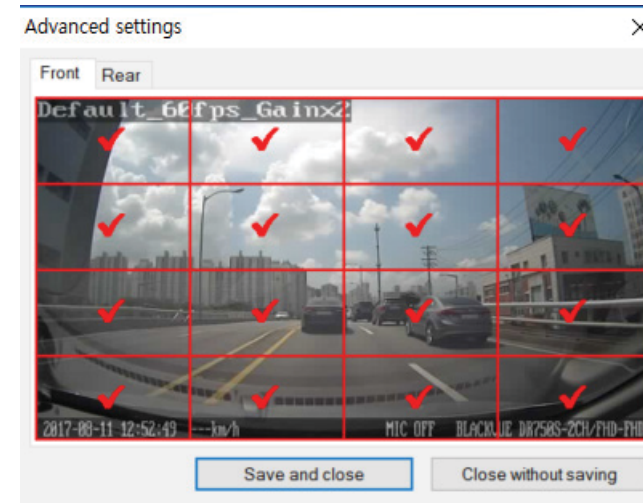
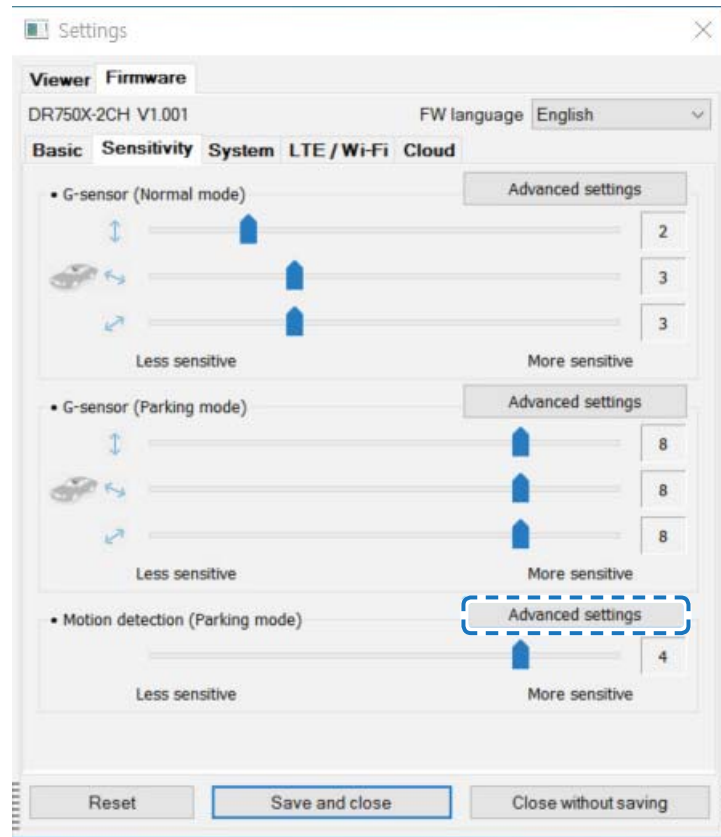

You can manually choose the detection regions to reduce the risk of triggering unwanted motion recordings due to trees swaying in the wind, far-away moving objects, etc. By default, all the regions are selected. If you want to ignore motion detection in particular region(s), unselect them.

System settings



LED

– Recording status

You can turn the recording status LED on/off.

– Front security (Normal mode)

You can turn the front security LED on/off for normal mode.

– **Front security (Parking mode)**

You can turn the front security LED on/off for parking mode.

– **Rear security**

You can turn the rear security LED on/off.

– **LTE/Wi-Fi (Parking mode)**

You can turn the LTE/Wi-Fi LED on/off for parking mode.



Note

Pittasoft is not responsible for any traffic law violations due to changing the default LED settings.

■ **Proximity Sensor**

You can choose the function of the proximity sensor. Available options are:

- Turn on/off audio recording (default)
- Manual recording trigger

The sensor can also be disabled completely.

■ **Voice guidance**

You can adjust the voice guidance (announcements) you want to hear.



Note:

Impact detected in parking mode voice alert notifies when exiting parking mode if an impact had been detected during parking mode, however, it ignores any impact detected within three minutes before exiting parking mode.

■ Volume

You can adjust the volume of the voice guidance (announcements).

■ Scheduled Reboot

The dashcam reboots automatically once-a-day if in parking mode at the set time for improved stability. If the dashcam is recording at the set time, the scheduled reboot is skipped.

You can enable/disable and change the time for scheduled rebooting. Default time is 03:00 am.

■ Speed alert

Set a speed limit (up to 300 km/h or 200 MPH) for the speed alert. When the vehicle exceeds the specified speed limit, the dashcam beeps and switches to event recording. After saving one event recording file the dashcam switches back to normal mode recording.

■ User text overlay

You can create a user text overlay of up to 20 characters using a combination of English letters (A – Z, a – z), numbers (0 – 9), and symbols (:;'/+_-)\$#). The text is overlaid in the top-left corner of the recorded videos.

LTE/Wi-Fi settings

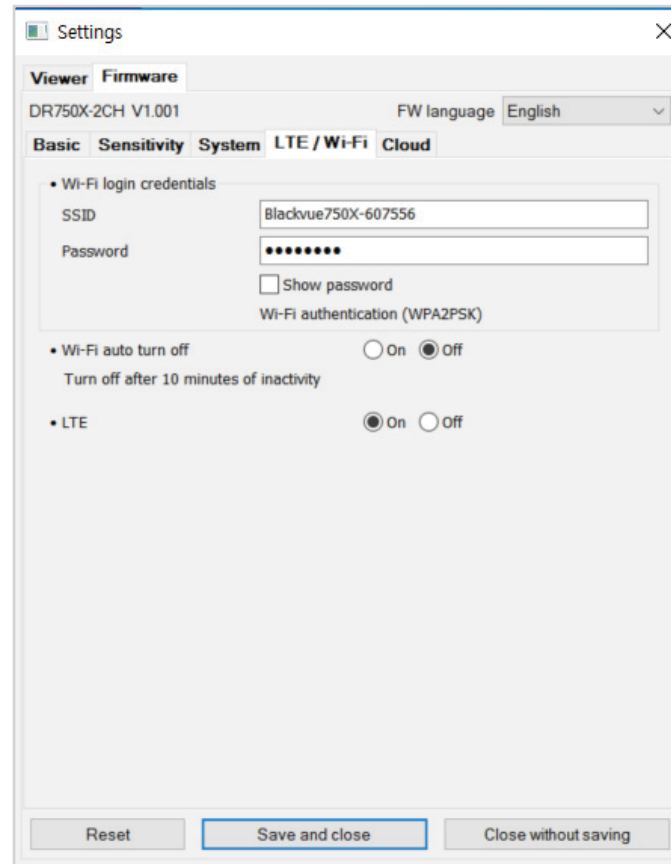

Wi-Fi login credentials

You can change the dashcam's SSID and Wi-Fi login password.

Wi-Fi auto turn off

When "Wi-Fi Auto turn off" is enabled, the Wi-Fi will automatically turn off if it is inactive for 10 minutes. If disabled, the Wi-Fi stays on all the time.

You can press the physical Wi-Fi button on the dashcam anytime to manually switch the Wi-Fi on/off.

LTE Setting

Default setting value is ON, if you do not want to use LTE service, please turn Off.

☐ Cloud settings

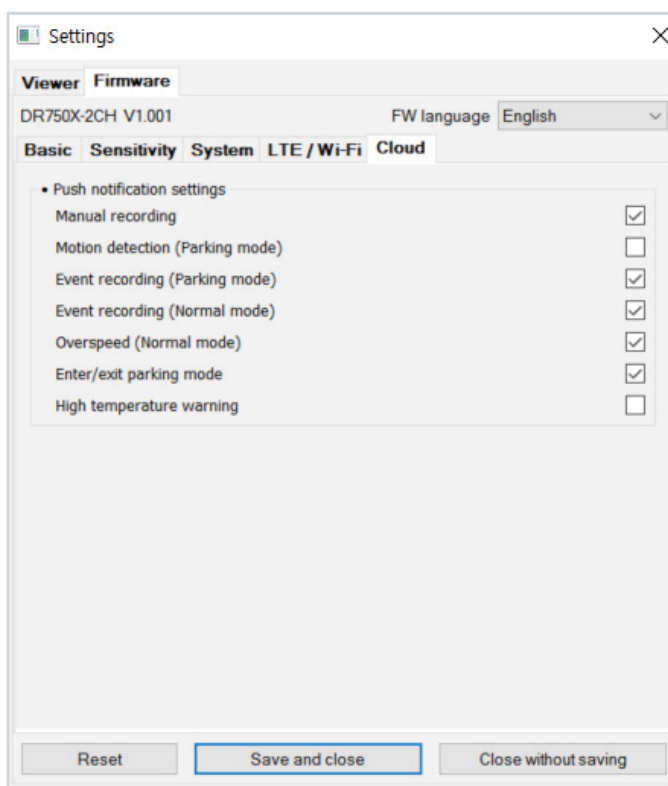

■ Push notification settings

You can customize when you want to receive push notifications.

Applying the settings

You can automatically apply the configuration by inserting the microSD card into the BlackVue dashcam and turning it on. Configure the settings before using the dashcam.

To reset the settings in the current tab to their defaults press the **Reset** button at the bottom of the settings panel.

Setting up Cloud Service

Activate the SIM card and choose a SIM data plan to get your LTE dashcam online!

Once your dashcam is connected to internet, take advantage of the following features in the BlackVue app and BlackVue Cloud Viewer:

Live View – See what's going on around your vehicle (just like a CCTV camera) anywhere, anytime

Remote Video Playback – Play videos stored in the dashcam or Cloud from your phone or computer

Push Notification Alerts – Receive notifications on your phone or computer when specified events occur

Real-time Location – Track your private or commercial vehicle's route, speed and parking location

Video Backup – Copy important footage to Cloud storage or to your phone or computer

Auto-upload – Automatically upload event recordings to the Cloud

Two-way Voice Communication – Talk to the driver or passengers using your phone or computer

GPS Tracking – View vehicles' routes, GPS logs and play mapped Event videos instantly, export tracking data

Geo-fencing – Create virtual boundaries on the map that trigger notifications when crossed

Driving Reports – Check the total distance travelled, travel time, etc. and export/print out tables

Remote Firmware Update – An easy way to update the dashcam's firmware over the Cloud

Connect to BLACKVUE CLOUD

For more information about using the BlackVue app, please download the BlackVue app Manual from www.blackvue.com > **Support** > **Downloads**.

Create an account

- (i) Open the BlackVue app.
- (ii) Tap the  button in the top-left corner and select **Create account**.
- (iii) Enter your email address and choose a password. Re-enter your password and press **Next**.
- (iv) After reading the Terms & Policies, check the boxes and press the **Create account** button to continue.
- (v) You will receive an e-mail. Click the link in the email to finish creating your account.

Register your dashcam with your account

- (i) In the BlackVue app select **BLACKVUE CLOUD** and login to your account.
- (ii) Tap **Yes** to enable push notifications (this setting can be adjusted at any time later).
- (iii) Select **Register new camera**.
- (iv) Register your camera using one of the following methods:

QR Code: Press **Scan QR Code** and line up the QR Code on your smartphone's screen.

*The QR code can be found labeled on the front camera when you remove it from its mount or on the product pad inside the packaging box.

or

Manual registration: Enter your camera's Serial number and Cloud code and press **Register**.

- (v) The app will ask for your permission to access your dashcam's GPS data. If you **allow** access the app will be able to show you your dashcam's location and speed. If you **don't allow** access you won't be able to see your dashcam's location and speed (you can allow access later in Privacy settings).

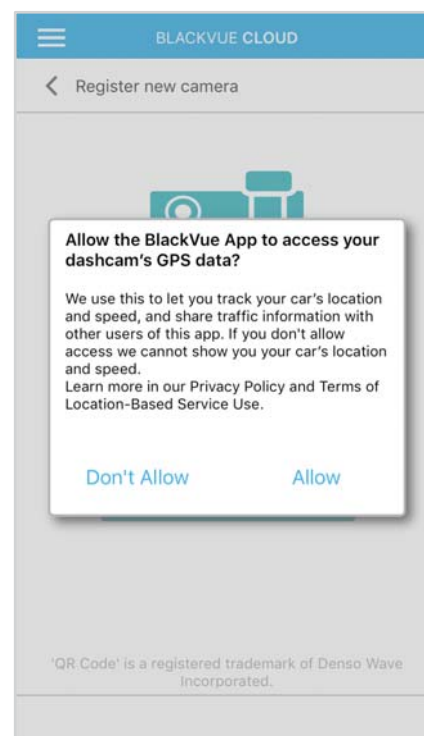

▶ Activate the SIM card

To use the BlackVue Cloud service, SIM card must be activated for internet access via LTE network

Register SIM card settings

- (i) Open the BlackVue app and select BLACKVUE WIFI -> SIM card activation

 **Note**

SIM card activation during parking mode may require 20 seconds to retrieving SIM information.

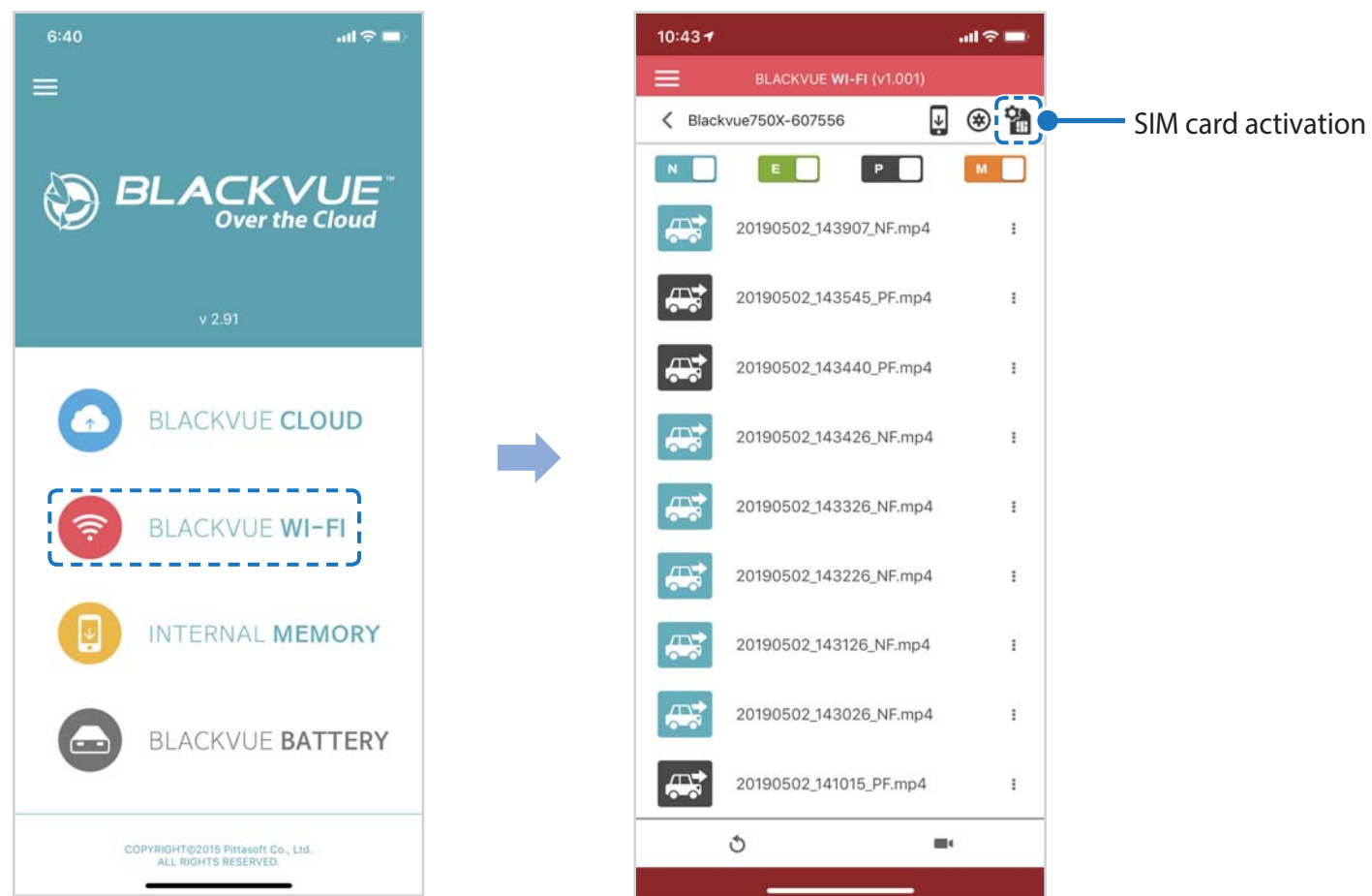

(ii) In the "APN settings" menu, choose "Vodafone AU" and press OK.



PUK registration

2 Once the settings are saved, the dashcam should connect to cloud within few seconds. If dashcam fails to connect to Cloud, please check the APN settings or contact the customer support.

Now you can go to BlackVue app > BLACKVUE CLOUD and start using Cloud service features such as remote Live View and Video playback, Real-time location, push notification, Auto-upload, remote Firmware update etc.

For detailed information regarding BlackVue Cloud Service, please visit our homepage (www.blackvue.com)

 **Note**

- Vodafone SIM cards are highly recommended for optimal performance.
- If the SIM card is PIN or PUK locked, the app would show as following.

Your SIM card package includes the PIN code and PUK code. Enter the PIN code or PUK code as provided and press okay to continue.

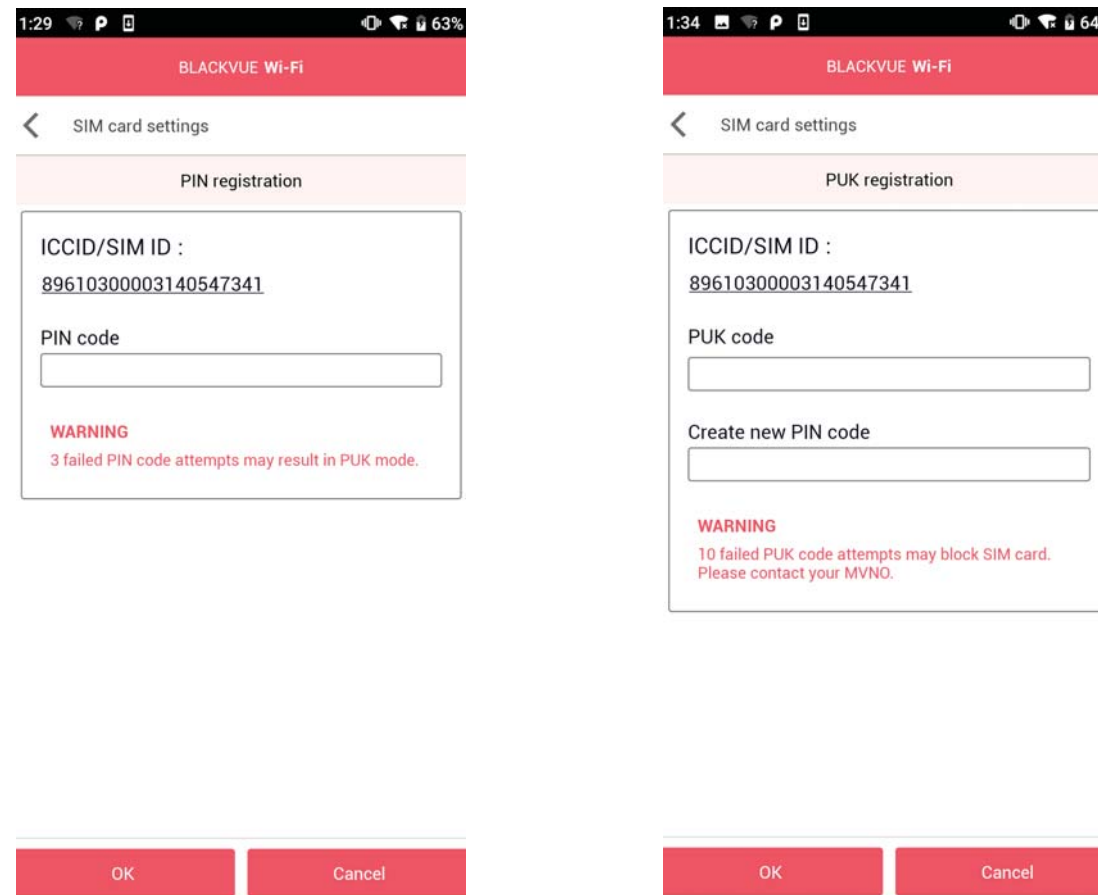

- To use the BlackVue Cloud Service, SIM card must be properly activated for Internet access via LTE network.
- Some Cloud features may not work when surrounding temperature is high or/and LTE speed is slow.

Optional accessories

▶ Parking mode kit (Optional)

The BlackVue dashcam will turn off when the engine is turned off. To record video while the engine is turned off, a parking mode kit (such as the Power Magic Pro or Power Magic EZ) is required. The Power Magic Pro powers your dashcam when the engine is off by hardwiring it to the automotive battery. A low voltage power cut-off function and a parking mode timer protect your vehicle's battery from discharge.

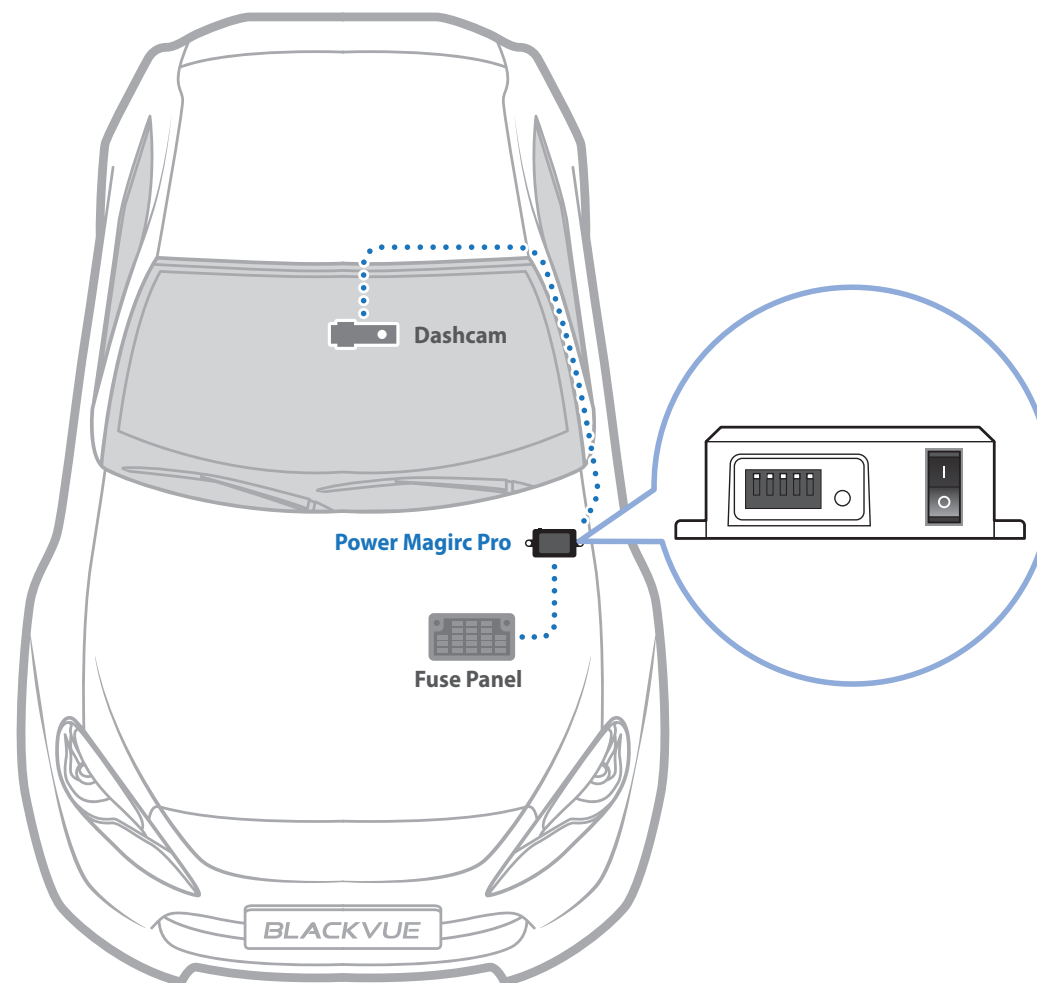

▶ Parking mode battery (Optional)

To record Video when the engine is turned off without using the vehicle's battery, you can install a parking mode battery (such as the Power Magic Ultra Battery or Power Magic Battery Pack)

▶ Power Magic Battery (B-112)

The Power Magic Battery pack B-112 powers a single dashcam for up to 12 hours after 1 hour of rapid charging. When the engine is off the battery pack powers the dashcam. When the engine is on the dashcam is powered directly from the vehicle's battery and the battery pack charges.

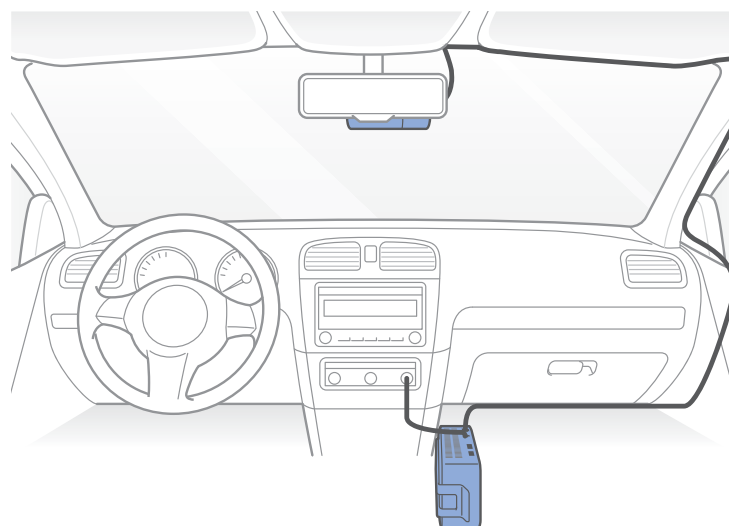

➤ Power Magic Ultra Battery (B-124X)

Power Magic Ultra Battery reaches a full charge in a record 40minutes when hardwired. Parking mode can last more than 24hours with a single-channel BlackVue. Compatible with the free BlackVue Battery Manager app.

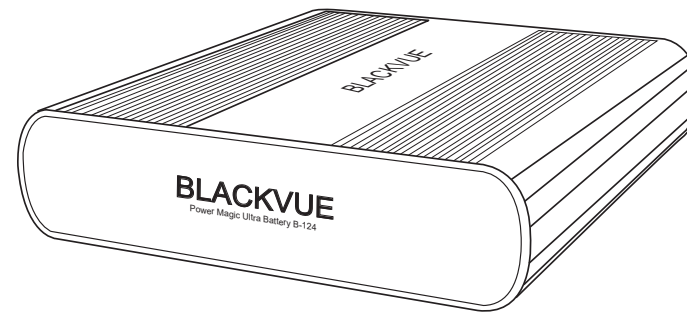

Note

- Double you capacity with the optional Expansion battery.
- Power Magic Ultra Battery recharges with ignition on and powers your dashcam when ignition off.
- For more detailed information, please check Blackvue homepage(www.blackvue.co.kr)

Changing/resetting direct Wi-Fi SSID and password

The dashcam's Wi-Fi SSID and password can be changed/reset using the following methods.

*The default Wi-Fi SSID and password can be found labeled on the front camera when you remove it from its mount or on the product pad inside the packaging box.

Change Wi-Fi SSID and password over the Cloud

Login to the BlackVue app.

Select **BLACKVUE CLOUD**.

Note

- You can access FW settings Over the Cloud only when the dashcam is ON and connected to the internet (Cloud). A blue colored icon means the dashcam is connected to the Cloud while a grey colored icon means that the dashcam is not connected to the Cloud.

Tap  next to your camera name and select **Camera settings** > **Firmware settings** > **Wi-Fi** > **Login credentials**.

You can change the camera's SSID and Wi-Fi login password.

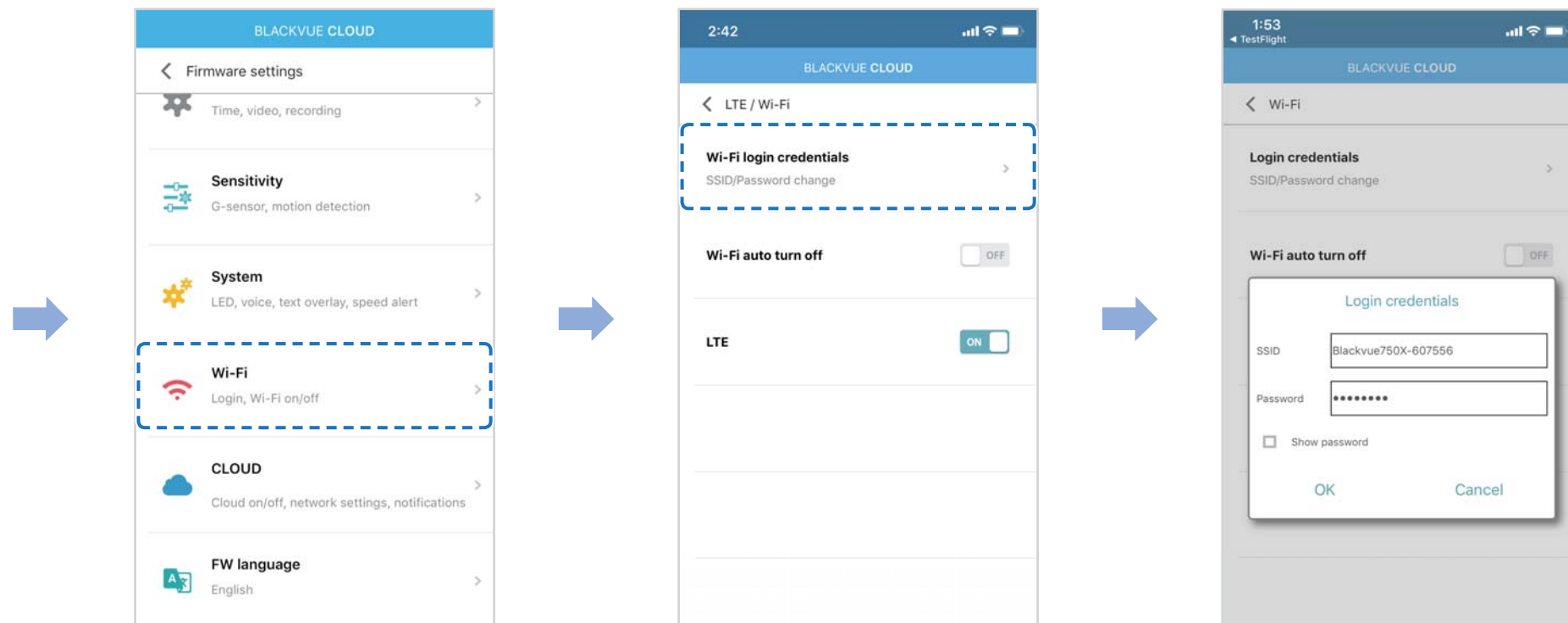
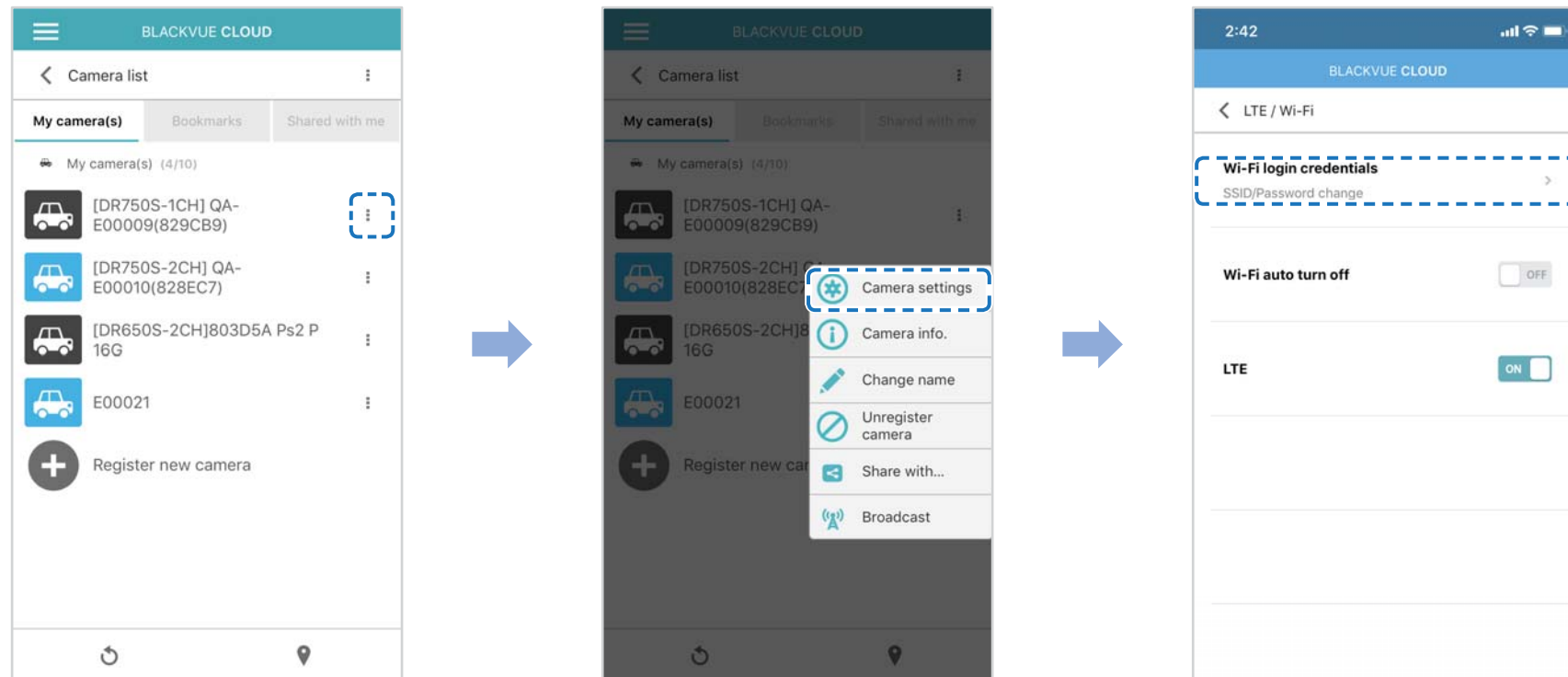

Go back to the Firmware settings menu, tap  and tap **Save and close**.

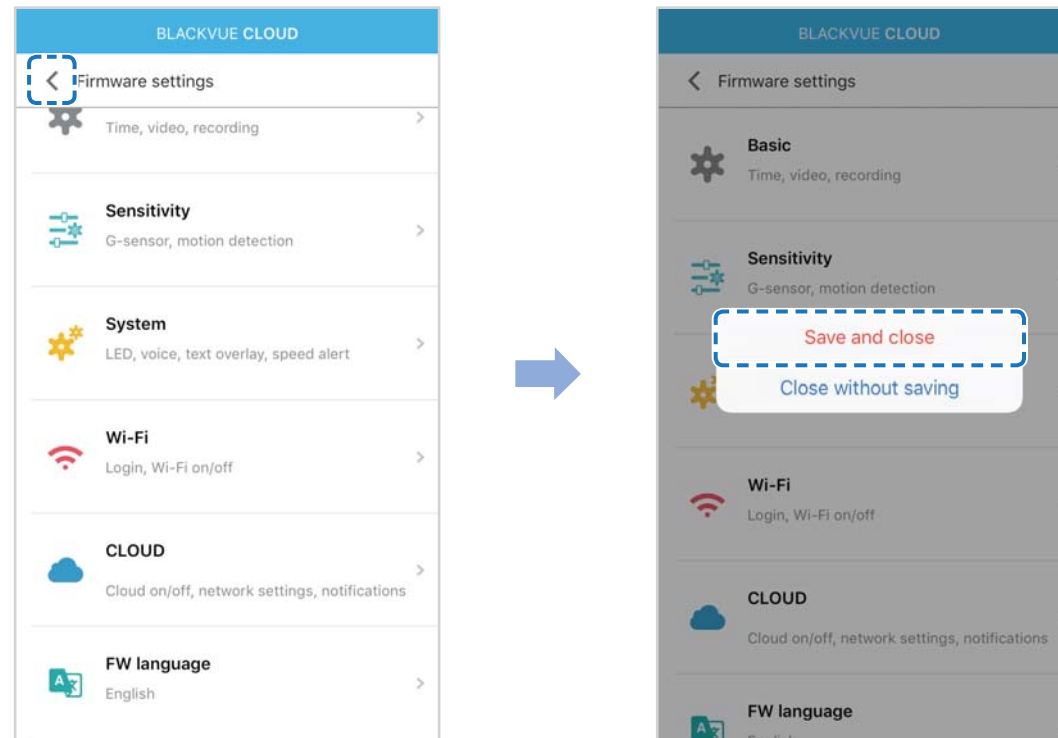



Change the Wi-Fi password using BlackVue Viewer (Windows or Mac)

Remove the microSD card from the dashcam.

Insert the card into the microSD card reader and connect it to a computer.

Launch BlackVue Viewer.

*You can download **BlackVue Viewer** from www.blackvue.com > **Support** > **Downloads** and install it on your computer.

In BlackVue Viewer click on the  **Settings** button (Windows) or the  **BlackVue Viewer** menu (macOS) to open the BlackVue settings panel.

Click the **Firmware** tab, then the **Wi-Fi** tab and under **Login credentials** change the password.

Click **Save and close**.

Product specifications

Model Name	DR750-2CH LTE
LTE	Built - In 4G LTE module compatible with nano SIM Frequency Bands : North America B2, B4, B12
Color/Size/Weight	Front: Black/Width 137.6 mm x Height 43 mm/166 g Rear: Black/Width 67.4 mm x Height 25 mm/25 g
Memory	microSD Card (16 GB/32 GB/64 GB/128 GB/256 GB)
Recording Modes	Normal recording, Event recording (when impact is detected in normal and parking mode), Manual recording and Parking recording. * For Parking mode recording, a Parking mode Battery Pack (Power Magic Battery Pack) or a Parking Mode Hardwiring Kit (Power Magic Pro) is required.
Camera	Front: STARVIS™ CMOS Sensor (Approx. 2.1 M Pixel) Rear: STARVIS™ CMOS Sensor (Approx. 2.1 M Pixel)
Viewing Angle	Front: Diagonal 139°, Horizontal 116°, Vertical 61° Rear: Diagonal 139°, Horizontal 116°, Vertical 61°
Resolution/Frame Rate	<Front - Rear> Full HD (1920x1080) @60fps - Full HD (1920x1080) @30fps * Frame rate may vary during Wi-Fi streaming.
Image Quality	Highest(Extreme)/Highest/High/Normal
Video Compression Mode	MP4
Wi-Fi	802.11b/g/n(HT20) (2.412 ~ 2.472 GHz), (802.11n(HT40) (2.422 ~ 2.462 GHz)
Bluetooth	BDR/EDR/LE (2.402 ~ 2.48 GHz)
GPS	Built-in
Microphone	Built-in
Speaker (Voice Guidance)	Built-in

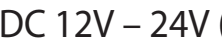
LED Indicators	Front: Recording LED, GPS LED, LTE/Wi-Fi LED, Front Security LED Rear: Rear Security LED
Sensor	3-Axis Acceleration Sensor
Button	<p>Format button: Press and hold for 5 seconds and once voice commands start, release the button. Then press and hold for 5 seconds again to format the microSD card.</p> <p>Wi-Fi button: Press once and Voice commands start to turn on/off Wi-Fi.</p> <p>Proximity sensor: Touching the proximity sensor turns on/off audio recording or triggers manual recording depending on the firmware settings</p>
Backup Battery	Built-in super capacitor
Input Power	DC 12V – 24V (DC Plug:  (Ø3.5 x Ø1.35), MAX 1A/12V)
Power Consumption	<p>Avg. 350 mA (4.2 W at 12 V, when GPS and Wi-Fi is On) Avg. 300 mA (3.6 W at 12 V, when GPS and Wi-Fi is Off) * Actual power consumption may vary depending on use conditions and environment.</p>
Operation Temperature	-20 °C – 70 °C (-4 °F – 158 °F)
Storage Temperature	-20 °C – 70 °C (-4 °F – 158 °F)
High Temperature Cut-Off	Approx. 80 °C (176 °F)
Certifications	Front: FCC, ISED, CE, RCM, TELEC Rear: FCC, CE, RoHS, WEEE
Software	BlackVue Viewer * Windows XP or higher and Mac OS X Yosemite 10.10 or higher
Application	BlackVue Application (Android 4.2.2 or higher, iOS 9.0 or higher)
Others	Adaptive Format Free File Management System

* STARVIS is a trademark of Sony Corporation.

Recording time

Your dashcam will automatically turn on and start recording when it is connected to a power source.

Memory Capacity	Image Quality	Resolution (Front+Rear)
		Full HD @60+ Full HD@30
16GB	Extreme	55 MIN
	Highest	1 HR 25 MIN
	High	1 HR 50 MIN
	Normal	2 HR 20 MIN
32GB	Extreme	1 HR 50 MIN
	Highest	2 HR 50 MIN
	High	3 HR 40 MIN
	Normal	4 HR 40 MIN
64GB	Extreme	3 HR 40 MIN
	Highest	5 HR 40 MIN
	High	7 HR 20 MIN
	Normal	9 HR 20 MIN
128GB	Extreme	7 HR 20 MIN
	Highest	11 HR 20 MIN
	High	15 HR 40 MIN
	Normal	18 HR 40 MIN
256GB	Extreme	14 HR 40 MIN
	Highest	22 HR 40 MIN
	High	29 HR 20 MIN
	Normal	37 HR 20 MIN
Bitrate (Mbps) Front + Rear	Extreme	25 + 10
	Highest	12 + 10
	High	10 + 8
	Normal	8 + 6

 **Note**

- If the microSD card is full, older files are deleted first to make space for newly-recorded videos.
- Total recording time is different depending on the memory capacity of the microSD card and the image quality of the video.

Disposal of your BlackVue dashcam



1. All electrical and electronic products should be disposed of separately from the municipal waste stream via designated collection facilities appointed by the government or the local authorities. Contact local authorities to learn about disposal and recycling options available in your area.
2. The correct disposal of your BlackVue dashcam will help prevent potential negative consequences for the environment and human health.
3. For more detailed information about disposal of your BlackVue dashcam, please contact your city office, waste disposal service or the shop where you purchased the product.

Customer Support

For customer support and firmware updates please visit www.blackvue.com

You can also email a Customer Support expert at cs@pittasoft.com

Before Requesting Service

Please back up all important files and data before requesting service. In order to service the dashcam it may be necessary to delete all files and data from the dashcam. All servicing is provided on the basis that the user has backed up all necessary files and data before requesting service. Therefore Pittasoft Co., Ltd. will not be responsible for the loss of any files or data.

Copyright & Trademark

- This instruction manual is protected by Copyright Law, and all rights to it are protected by law.
- It is prohibited to reproduce, copy, modify, or translate this instruction manual without permission.

 **BLACKVUE** BlackVue is the registered trademark of Pittasoft Co., Ltd. Pittasoft Co., Ltd. reserves all rights regarding all works related to the BlackVue brand such as product design, trademarks, and product-promotional videos. It is prohibited to reproduce, copy, modify, or use related works without permission. Any violation may be penalized in accordance with the relevant regulations.



Product | Car Dashcam
Model Name | DR750-2CH LTE
Manufacturer | Pittasoft Co., Ltd.
Address | 7F, BYC HIGHCITY Building A 131, Gasan Digital 1-ro, Geumcheon-gu, Seoul, Republic of Korea, 08506
Customer Support | cs@pittasoft.com
Product Warranty | One-Year Limited Warranty
[f](https://www.facebook.com/BlackVueOfficial)facebook.com/BlackVueOfficial
[@](https://www.instagram.com/BlackVueofficial)instagram.com/BlackVueofficial
www.blackvue.com
Made in Korea

FCC Compliance Information

This equipment has been tested and found to comply with the limits for a Class B digital device, pursuant to Part 15 of the FCC Rules. These limits are designed to provide reasonable protections against harmful interference in a residential installation.

This equipment generates, uses and can radiate radio frequency energy and, if not installed and used in accordance with the instructions, may cause harmful interference to radio communications. However, there is no guarantee that interference will not occur in a particular installation.

If this equipment does cause harmful interference to radio or television reception which can be determined by turning the equipment off and on, the user is encouraged to try to correct the interference by one or more of the following measures.

- Reorient or relocate the receiving antenna.
- Increase the separation between the equipment and receiver.
- Connect the equipment into an outlet on a circuit different from that to which the receiver is connected.
- Consult the dealer or an experienced radio, TV technician for help.
- Only shielded interface cable should be used.

Finally, any changes or modifications to the equipment by the user not expressly approved by the grantee or manufacture could void the user's authority to operate such equipment.

This device complies with Part 15 of the FCC Rules. Operation is subject to the following two conditions:

- (1) This device may not cause harmful interference, and
- (2) This device must accept any interference received, including interference that may cause undesired operation of this device.

FCC RF Radiation Exposure Statement: This equipment complies with FCC RF Radiation exposure limits set forth for an uncontrolled environment. This device and its antenna must not be co-located or operating in conjunction with any other antenna or transmitter. This equipment should be installed and operated with a minimum distance of 20 cm between the radiator and your body.

ICC Compliance

This Class [B] digital apparatus complies with Canadian ICES-003.

This radio transmitter has been approved by Industry Canada to operate with the antenna types listed below with the maximum permissible gain and required antenna impedance for each antenna type indicated. Antenna types not included in this list, having a gain greater than the maximum gain indicated for that type, are strictly prohibited for use with this device.

- IC Warning

This device complies with Industry Canada licence-exempt RSS standard(s).

Operation is subject to the following two conditions:

- (1) this device may not cause interference, and
- (2) this device must accept any interference, including interference that may cause undesired operation of the device.

Le présent appareil est conforme aux CNR d'Industrie Canada applicable aux appareils radio exempts de licence.

L'exploitation est autorisée aux deux conditions suivantes:

- (1) l'appareil ne doit pas produire de brouillage, et
- (2) l'utilisateur de l'appareil doit accepter tout brouillage radioélectrique subi, même si le brouillage est susceptible d'encompromettre le fonctionnement.