

# Electromagnetic Emission

## FCC MEASUREMENT REPORT

### CERTIFICATION OF COMPLIANCE

#### FCC Part 15 Certification Measurement

**PRODUCT** : Car Dashcam  
**MODEL/Serial No.** : DR590W-2CH / Proto type  
**MULTIPLE MODEL** : DR590W-1CH, DR590W-2CH IR, DR590W-2CH Truck,  
DR590S-1CH, DR590S-2CH, DR590S-2CH IR, DR590S-2CH Truck  
**FCC ID** : YCK-DR590W-2CH  
**BRAND NAME** : **BLACKVUE**  
**APPLICANT** : Pittasoft Co., Ltd.  
7F, BYC HIGH CITY Building A 131, Gasan Digital-ro,  
Geumcheon-gu, Seoul, 08506, South Korea  
Attn.: Minho Shin / Senior Research Engineer  
**MANUFACTURER** : Pittasoft Co., Ltd.  
7F, BYC HIGH CITY Building A 131, Gasan Digital-ro,  
Geumcheon-gu, Seoul, 08506, South Korea  
**FACTORY** : Keeper Technology. Inc  
5F, Sanho Technovill, 1115, Siheung-daero, Siheung-si,  
Gyeonggi-do, Republic of Korea, 14950  
**EQUIPMENT CLASSIFICATION** : DTS (Part 15 Digital Transmission System)  
**TYPE OF MODULATION** : OFDM  
**FREQUENCY CHANNEL** : 2 412 MHz to 2 462 MHz and Channel Spacing 5 MHz (11 Ch)  
**ANTENNA TYPE** : Internal Antenna (Integral)  
**ANTENNA GAIN** : 3.70 dBi max  
**RF POWER** : 2.01 mW  
**RULE PART(S)** : FCC Part 15 Subpart C  
**FCC PROCEDURE** : ANSI C63.10-2013  
**TEST REPORT No.** : ETLT180206.0021  
**DATES OF TEST** : February 26, 2018 to March 06, 2018  
**REPORT ISSUE DATE** : March 23, 2018  
**TEST LABORATORY** : ETL Inc. (FCC Designation Number : KR0022)

The Car Dashcam, Model DR590W-2CH has been tested in accordance with the measurement procedures specified in ANSI C63.10-2013 at the ETL Test Laboratory and has been shown to be complied with the electromagnetic radiated emission limits specified in FCC Rule Part15 Subpart C section 15.247. I attest to the accuracy of data. All measurement herein was performed by me or was made under my supervision and is correct to the best of my knowledge and belief. I assume full responsibility for the completeness of these measurements and vouch for the qualifications of all persons taking them. The results of testing in this report apply to the product/system which was tested only. Other similar equipment will not necessarily produce the same results due to production tolerance and measurement uncertainties.

Prepared by:   
Dong Jin, Seo (Test Engineer)  
March 23, 2018

Reviewed by:   
Kug Kyoung, Yoon (Chief Engineer)  
March 23, 2018

#### ETL Inc.

Head office: #371-51, Gasan-dong, Geumcheon-gu, Seoul, 153-803, Korea  
Open site: #499-1, Sagot-ri, Seosin-myeon, Hwaseong-si, Gyeonggi-do, 445-882, Korea  
Tel: 82-2-858-0786 Fax: 82-2-858-0788

*The test report merely corresponds to the test sample(s).  
This report shall not be reproduced, in whole or in part without the written approval of ETL Inc.*

## Table of Contents

### FCC Measurement Report

- 1. Introduction**
- 2. Product Information**
- 3. Description of Tests**
- 4. Test Condition**
- 5. Test Results**
  - 5.1 Summary of Test Results**
  - 5.2 6 dB Bandwidth**
  - 5.3 Maximum Peak Output Power**
  - 5.4 Bandwidth of Frequency Band Edges**
  - 5.5 Power Spectral Density**
  - 5.6 Spurious Emissions**
  - 5.7 Conducted Emissions Test**
  - 5.8 Radio Frequency Exposure**
- 6. Sample Calculation**
- 7. List of test Equipment used for Measurement**

## FCC MEASUREMENT REPORT

**Scope** – Measurement and determination of electromagnetic emission (EME) of radio frequency devices including intentional radiators and/or unintentional radiators for compliance with the technical rules and regulations of the U.S Federal Communications Commission(FCC)

### General Information

<b>Applicant Name</b>	<b>: Pittasoft Co., Ltd.</b>
<b>Address</b>	<b>: 7F, BYC HIGH CITY Building A 131, Gasan Digital-ro, Geumcheon-gu, Seoul, 08506, South Korea</b>
<b>Attention</b>	<b>: Minho Shin / Senior Research Engineer</b>

- **EUT Type** : Car Dashcam
- **Model Number** : DR590W-2CH
- **S/N** : Proto type
- **Modulation Technique** : OFDM
- **Frequency Channel** : 2 412 MHz to 2 462 MHz and Channel Spacing 5 MHz (11 Ch)
- **Antenna Type** : Internal Antenna (Integral)
- **Antenna Gain** : 3.70 dBi max
- **RF Power** : 2.01 mW
- **Environmental of Tests** : Temperature: (12.2 ± 10.7) °C  
Humidity: (35 ± 13) % R.H.  
Atmospheric Pressure: (102.2 ± 0.8) kPa
- **FCC Rule Part(s)** : FCC Part 15 Subpart C
- **Test Procedure** : ANSI C63.10-2013
- **EQUIPMENT CLASS** : DTS (Part 15 Digital Transmission System)
- **Place of Tests** : ETL Inc. Testing Lab. (FCC Designation Number : KR0022)

Radiated Emission test 1;  
#499-1, Sagot-ri, Seosin-myeon, Hwaseong-si,  
Gyeonggi-do, 445-882, Korea

Radiated Emission test 2 and Conducted Emission test;  
#371-51, Gasan-dong, Geumcheon-gu, Seoul, 153-803, Korea

## 1. INTRODUCTION

The measurement test for radiated and conducted emission test was conducted at the ETL Inc. The site is constructed in conformance with the requirements of the ANSI C63.10-2013 and CISPR Publication 16. The ETL has site descriptions on file with the FCC for 3 m and 10 m site configurations. Detailed description of test facility was found to be in compliance with FCC Rules according to the ANSI C63.10-2013 and registered to the Federal Communications Commission (FCC Designation Number : KR0022).

The measurement procedure described in American National Standard for Method of Measurement of Radio-Noise Emission from Low-Voltage Electrical and Electronic Equipment in the Range of 9 kHz to 40 GHz (ANSI C63.10-2013) was used in determining radiated and conducted emissions from the Pittasoft Co., Ltd. Model: DR590W-2CH

## 2. PRODUCT INFORMATION

### 2.1 Equipment Description

The Equipment Under Test (EUT) is the Car Dashcam (model: DR590S-2CH).

The model DR590W-2CH is basic model that was tested.

The multiple models DR590W-1CH, DR590W-2CH IR, DR590W-2CH Truck, DR590S-1CH, DR590S-2CH, DR590S-2CH IR and DR590S-2CH Truck are identical to basic model, except for model designation.

### 2.2 General Specification

Item	Specification
Color / Size / Weight	Black / 111.8 mm (W) x 34 mm (H) / 64 g
Memory	microSD Card (16 GB/32 GB/64 GB/128 GB)
Recording Modes	Normal recording, Event recording (when impact is detected in normal and parking mode) and Parking recording (when motion is detected) * For Parking mode recording, a Parking Mode Battery Pack (Power Magic Battery Pack) or a Parking Mode Hardwiring Kit (Power Magic Pro) is required.
Camera	STARVIS™ CMOS Sensor (Approx. 2.1 megapixels)
Viewing Angle	Diagonal 139°, Horizontal 116°, Vertical 61°
Resolution / Frame Rate	Full HD (1 920 x 1 080) @ 30 fps HD (1 280 x 720) @ 30 fps
Image Quality	Highest, High, Normal
Video Compression Mode	MP4
Wi-Fi	Built-in (802.11n (2.4 GHz ~ 2.483 5 GHz))
GPS	External (Optional)
Microphone	Built-in
Speaker (Voice Guidance)	Built-in
LED Indicators	Front Security, REC, GPS, Wi-Fi
Button	Short press: Wi-Fi on/off Press and hold: Format microSD Card
Sensor	3-Axis Acceleration Sensor
Backup Battery	Built-in super capacitor
Input Power	DC 12 V – DC 24 V (DC Plug: ø3.5 x ø1.35, Max 1 A/12 V)

Item	Specification
Power Consumption	<p>Avg. 350 mA (3.60 W at 12 V, when Wi-Fi is off and no external GPS receiver is connected)</p> <p>Avg. 320 mA (3.84 W at 12 V, when Wi-Fi is on and an external GPS receiver is connected)</p> <p>* Actual power consumption may vary depending on use conditions and environment.</p>
Operation Temperature	(25 ± 45) °C ((77 ± 81) °F)
Storage Temperature	(30 ± 50) °C ((86 ± 90) °F)
High Temperature Cut-Off	Approx. 80 °C (176 °F)
Software	<p>BlackVue Viewer</p> <p>* Windows XP or higher and Mac Yosemite OS X (10.10) or higher</p>
Application	BlackVue Application (Android 4.4.2 or higher, iOS 8.0 or higher)
Others	Adaptive Format Free File Management System
High Internal Frequency	X-tal → 40 MHz

## 3. DESCRIPTION OF TESTS

The tests documented in this report were performed in accordance with ANSI C63.10-2013 and FCC CFR 47 2.1046, 2.1047, 2.1049, 2.1051, 2.1053, 2.1055, 2.1057, 15.207, 15.209 and 15.247.

### 3.1 Radiated Emission Measurement

Radiated emission measurements were made in accordance with § 13 in ANSI C63.10-2013 "Measurement of Intentional radiators" The measurements were performed over the frequency range of 30 MHz to 40 GHz using antenna as the input transducer to a Spectrum analyzer or a Field Intensity Meter. The measurements were made with the detector set for "Peak, Quasi-peak, Average" within a bandwidth of 120 kHz and above 1 GHz is 1 MHz.

Preliminary measurements were made at 3 m using broadband antennas, and spectrum analyzer to determine the frequency producing the maximum emission in shielded room. Appropriate precaution was taken to ensure that all emission from the EUT were maximized and investigated. The system configuration, mode of operation, turntable azimuth and height with respect to the antenna were noted for each frequency found. The spectrum was scanned from 30 MHz to 1 000 MHz using Log-Bicon antenna. Above 1 GHz, linearly polarized double ridge horn antennas were used. Final measurements were made open site or SVSWR chamber at 3 m. The test equipment was placed on a styrofoam table. Sufficient time for the EUT, support equipment, and test equipment was allowed in order for them to warm up to their normal operating condition. Each frequency found during pre-scan measurements was re-examined by manual. The EUT, support equipment and interconnecting cables were re-configured to the set-up producing the maximum emission for the frequency and were placed on top of a table height for below 1GHz is 0.8 m, and for above 1GHz is 1.5 m. nonmetallic 1.0 m x 1.5 m table. The EUT, support equipment, and interconnecting cables were re-arranged and manipulated to maximize each emission. The turntable containing the system was rotated; the antenna height was varied 1 m to 4 m and stopped at the azimuth or height producing the maximum emission.

Varying the mode of operating frequencies of the EUT maximized each emission. The system was tested in all the three orthogonal planes and changing the polarity of the antenna. The worst-case emissions are recorded in the data tables. If necessary, the radiated emission measurement could be performed at a closer distance to ensure higher accuracy and the results were extrapolated to the specified distance using an inverse linear distance extrapolation factor (20 dB/decade) as per section 15.31(f).

Photographs of the worst-case emission can be seen in Photographs of the worst-case emission test setup can be seen in Appendix B.

## 3.2 Conducted Emission Measurement

Conducted emissions measurements were made in accordance with section § 13 in ANSI C63.10-2013 "measurement of intentional radiators" The measurements were performed over the frequency range of 0.15 MHz to 30 MHz using a 50  $\Omega$ /50  $\mu$ H LISN as the input transducer to a Spectrum Analyzer or a Test Receiver. The measurements were made with the detector set for "Peak" amplitude within a bandwidth of 9 kHz or for "quasi-peak" within a bandwidth of 9 kHz.

The line-conducted emission test is conducted inside a shielded anechoic chamber room with 1 m x 1.5 m x 0.8 m wooden table which is placed 0.4 m away from the vertical wall and 1.5 m away from the side wall of the chamber room. Two LISN are bonded to the shielded room. The EUT is powered from the LISN and the support equipment is powered from the other LISN. Power to the LISNs are filtered by a noise cut power line filters. All electrical cables are shielded by braided tinned steel tubing with inner  $\phi$  1.2 cm. If the EUT is a DC-powered device, power will be derived from the source power supply it normally will be powered from and these supply lines will be connected to the LISN. Non-inductive bundling to a 1 m length shortened all interconnecting cables more than 1 m. Sufficient time for the EUT, support equipment, and test equipment was allowed in order for them to warm up to their normal operating condition. The RF output of the LISN was connected to the EMI Test Receiver to determine the frequency producing the maximum emission from the EUT. The frequency producing the maximum level was reexamined using to set Quasi-Peak mode by manual, after scanned by automatic Peak mode from 0.15 MHz to 30 MHz. The bandwidth of the spectrum analyzer was set to 9 kHz. The EUT, support equipment, and interconnecting cables were arranged and manipulated to maximize each emission.

Photographs of the worst-case emission can be seen in Photographs of the worst-case emission test setup can be seen in Appendix B.



### 3.3 FCC Part 15.205 Restricted Bands of Operations

(a) Except as shown in paragraph (d) of this section, only spurious emissions are permitted in any of the frequency bands listed below:

MHz	MHz	MHz	GHz
0.090 - 0.110	16.42 - 16.423	399.9 - 410	4.5 - 5.15
<sup>1</sup> 0.495 - 0.505	16.694 75 - 16.695 25	608 - 614	5.35 - 5.46
2.173 5 - 2.190 5	16.804 25 - 16.804 75	960 - 1 240	7.25 - 7.75
4.125 - 4.128	25.5 - 25.67	1 300 - 1 427	8.025 - 8.5
4.177 25 - 4.177 75	37.5 - 38.25	1 435 - 1 626.5	9.0 - 9.2
4.207 25 - 4.207 75	73 - 74.6	1 645.5 - 1 646.5	9.3 - 9.5
6.215 - 6.218	74.8 - 75.2	1 660 - 1 710	10.6 - 12.7
6.267 75 - 6.268 25	108 - 121.94	1 718.8 - 1 722.2	13.25 - 13.4
6.311 75 - 6.312 25	123 - 138	2 200 - 2 300	14.47 - 14.5
8.291 - 8.294	149.9 - 150.05	2 310 - 2 390	15.35 - 16.2
8.362 - 8.366	156.524 75 - 156.525 25	2 483.5 - 2 500	17.7 - 21.4
8.376 25 - 8.386 75	156.7 - 156.9	2 690 - 2 900	22.01 - 23.12
8.414 25 - 8.414 75	162.012 5 - 167.17	3 260 - 3 267	23.6 - 24.0
12.29 - 12.293	167.72 - 173.2	3 332 - 3 339	31.2 - 31.8
12.519 75 - 12.520 25	240 - 285	3 345.8 - 3 358	36.43 - 36.5
12.576 75 - 12.577 25	322 - 335.4	3 600 - 4 400	( <sup>2</sup> )
13.36 - 13.41			

<sup>1</sup> Until February 1, 1999, this restricted band shall be 0.490 MHz - 0.510 MHz.

<sup>2</sup> Above 38.6

(b) Except as provided in paragraphs (d) and (e), the field strength of emissions appearing within these frequency bands shall not exceed the limits shown in Section 15.209. At frequencies equal to or less than 1 000 MHz, compliance with the limits in Section 15.209 shall be demonstrated using measurement instrumentation employing a CISPR quasi-peak detector. Above 1 000 MHz, compliance with the emission limits in Section 15.209 shall be demonstrated based on the average value of the measured emissions. The provisions in Section 15.35 apply to these measurements.

### 3.4 Antenna connection requirement

#### (1) According to §15.203

An intentional radiator shall be designed to ensure that no antenna other than that furnished by the responsible party shall be used with the device. The use of a permanently attached antenna or of an antenna that uses a unique coupling to the intentional radiator shall be considered sufficient to comply with the provisions of this Section. The manufacturer may design the unit so that a broken antenna can be replaced by the user, but the use of a standard antenna jack or electrical connector is prohibited. This requirement does not apply to carrier current devices or to devices operated under the provisions of Sections 15.211, 15.213, 15.217, 15.219, or 15.221. Further, this requirement does not apply to intentional radiators that must be professionally installed, such as perimeter protection systems and some field disturbance sensors, or to other intentional radiators which, in accordance with Section 15.31(d), must be measured at the installation site. However, the installer shall be responsible for ensuring that the proper antenna is employed so that the limits in this Part are not exceeded.

## 4. TEST CONDITION

### 4.1 Test Configuration

The device was configured for testing in a typical fashion (as a customer would normally use it). During the tests, the following conditions and configurations were used.

\* This test was applied to X, Y, Z. and the worst result were investigated and reported.

### 4.2 Description of Test modes

Car Dashcam that has the control software.

### 4.3 The setup drawing(s)

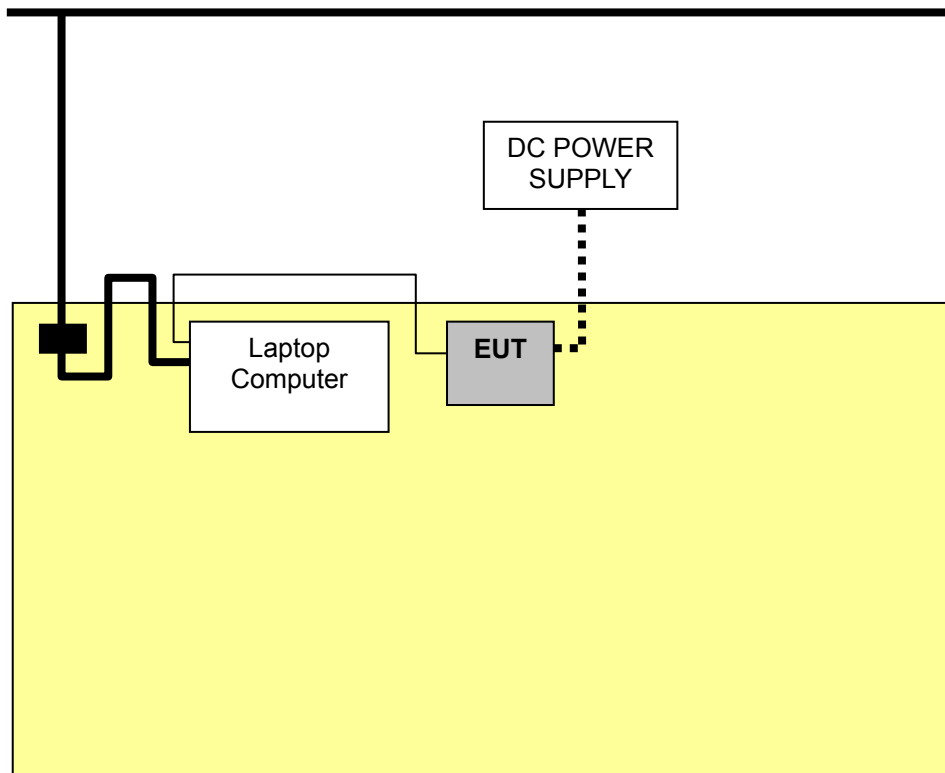

- : Signal line
- : AC Power line
- ..... : DC Power line (Cigar Jack)
- : Adapter

## 4.4 Support Equipment Used

Description	Model Name	Serial No.	Manufacturer
Notebook Computer	CQ35	CND9322TYH	HEWLET-PACKARD COMPANY
Adapter (for Notebook Computer)	PPP009C	F220881413024952	CHICONY POWER TECHNOLOGY (Chong QIng) CO., LTD.
DC POWER SUPPLY	SDP 60-5D	605DOD 002	SM Techno

## 5. TEST RESULTS

### 5.1 Summary of Test Results

The measurement results were obtained with the EUT tested in the conditions described in this report. Detailed measurement data and plots showing the maximum emission of the EUT are reported.

47 CFR Part 15, Subpart C	Measurement Required	Result
15.247(a)(2)	6 dB Bandwidth	Pass
15.247(b)(3)	Maximum Peak Output Power	Pass
15.247(d)	Bandwidth of Frequency Band Edges	Pass
15.247(e)	Power Spectral Density	Pass
15.209(a)	Spurious Emissions	Pass
15.207	Conducted Emissions	N/A *
15.203	Antenna connection requirement	Integral antenna which is permanently attached and cannot be replaced.
1.1307(b)(1)	RF Exposure	Pass

\* This test was not applied. Because, EUT power supplies from an automotive battery. (DC 12 V - DC 24 V)

The data collected shows that the **Pittasoft Co., Ltd. / Car Dashcam / DR590W-2CH** complied with technical requirements of above rules part 15.207, 209 and 15.247 Limits.

The equipment is not modified anything, mechanical or circuits to improve EMI status during a measurement. No EMI suppression device(s) was added and/or modified during testing.

## 5.2 6 dB Bandwidth

EUT	Car Dashcam / DR590W-2CH
Limit apply to	FCC Part 15.247(a)(2)
Test Date	March 06, 2018
Environmental of Test	(22.5 ± 0.0) °C, (39 ± 0) % R.H., (103.0 ± 0.0) kPa
Operating Condition	RF transmitting continuously during the tested.
Result	Passed

### Limit

The maximum 6 dB bandwidth shall be at least 500 kHz.

### Test Data

Mode	Frequency [MHz]	6 dB Bandwidth [MHz]	Limit
802.11n(HT20)	2 412	17.732	> 500 kHz
	2 437	17.732	
	2 462	17.732	

### NOTES:

1. This test was applied both to DC 12 V and DC 24 V. (Worst case: DC 12 V)
2. Measure frequency separation of relevant channel using spectrum analyzer.
3. RBW 100 kHz, VBW 300 kHz, Sweep 1 s.
4. Please see the measured plot in next page.

## Plots of 6 dB Bandwidth (802.11n(HT20))

[2 412 MHz]

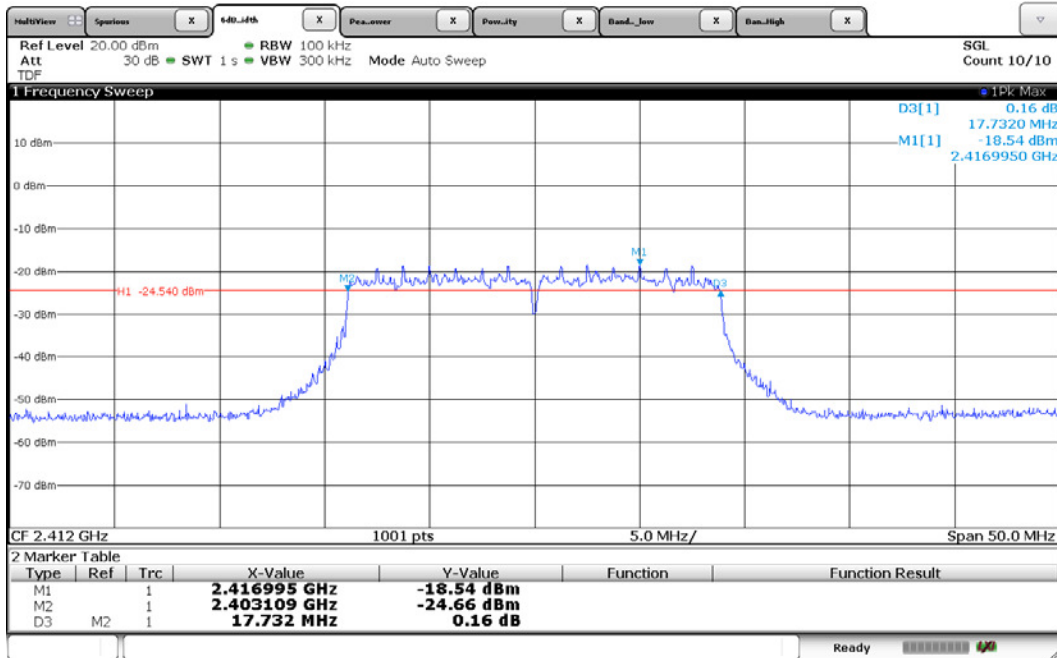

[2 437 MHz]

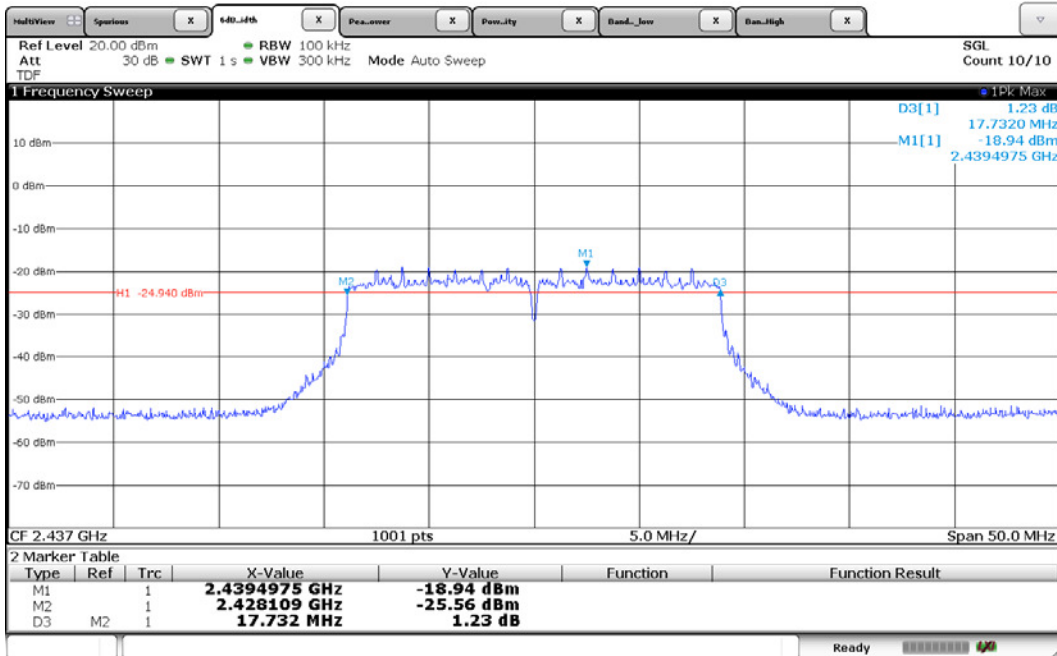

[2 462 MHz]

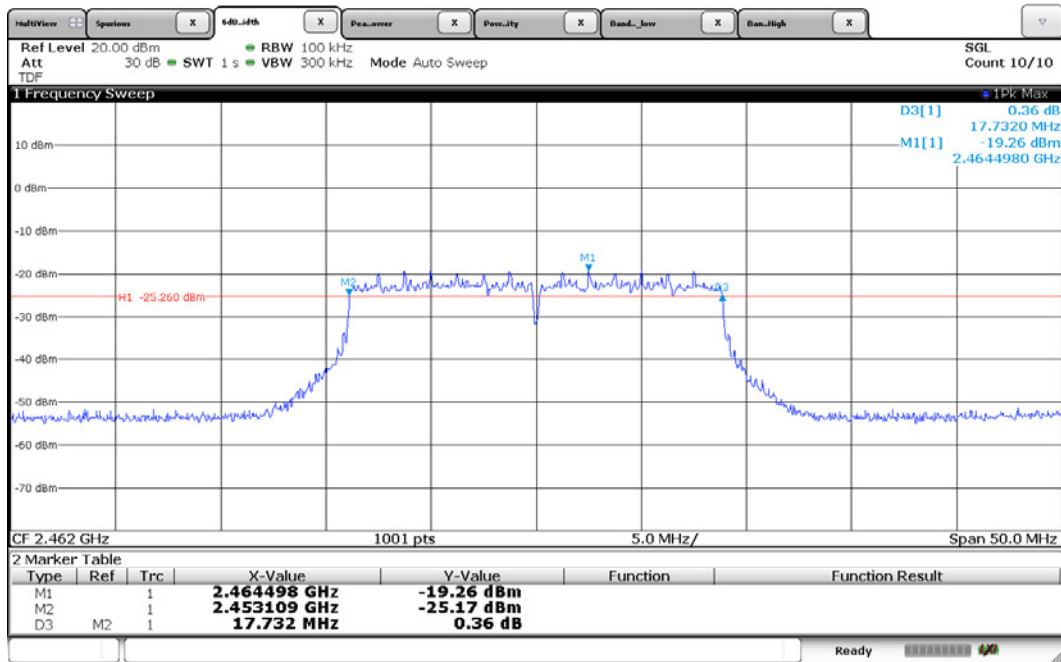

## 5.3 Maximum Peak Conducted Output Power

EUT	Car Dashcam / DR590W-2CH
Limit apply to	FCC Part 15.247(b)(3)
Test Date	March 06, 2018
Environmental of Test	(22.5 ± 0.0) °C, (39 ± 0) % R.H., (103.0 ± 0.0) kPa
Operating Condition	RF transmitting continuously during the tested.
Result	Passed

### Limit

The maximum peak conducted output power of the intentional radiator shall not exceed the following:

For frequency hopping systems operating in the 2 400.0 MHz - 2 483.5 MHz band: 1 Watt

### Test Data

Mode	Frequency [MHz]	Output Power [dBm]	Limit
802.11n(HT20)	2 412	3.04	< 30.00 dBm (1 W)
	2 437	2.80	
	2 462	2.95	

### NOTES:

1. This test was applied both to DC 12 V and DC 24 V. (Worst case: DC 12 V)
2. Please see the measured plot in next page.



## Plots of Output Power (802.11n(HT20))

[2 412 MHz]

Maximum value (Output Power)



[2 437 MHz]

Maximum value (Output Power)

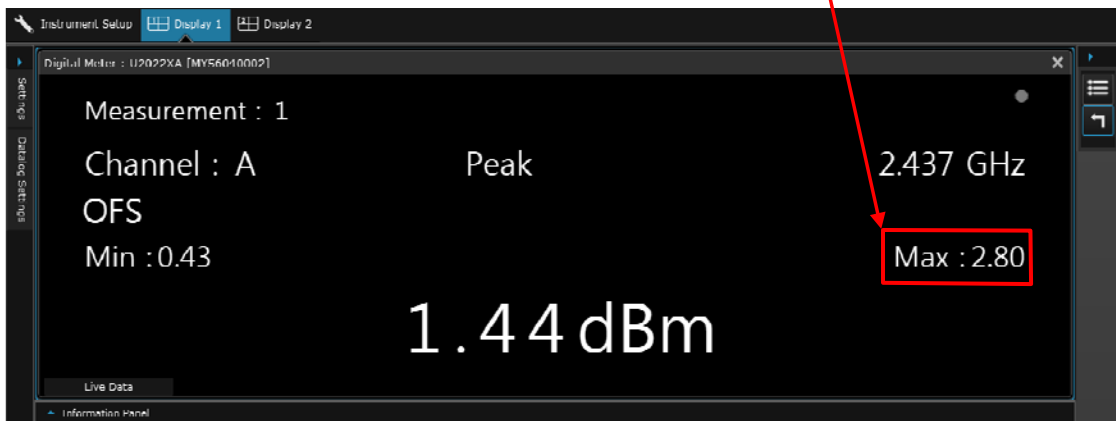

[2 462 MHz]

Maximum value (Output Power)

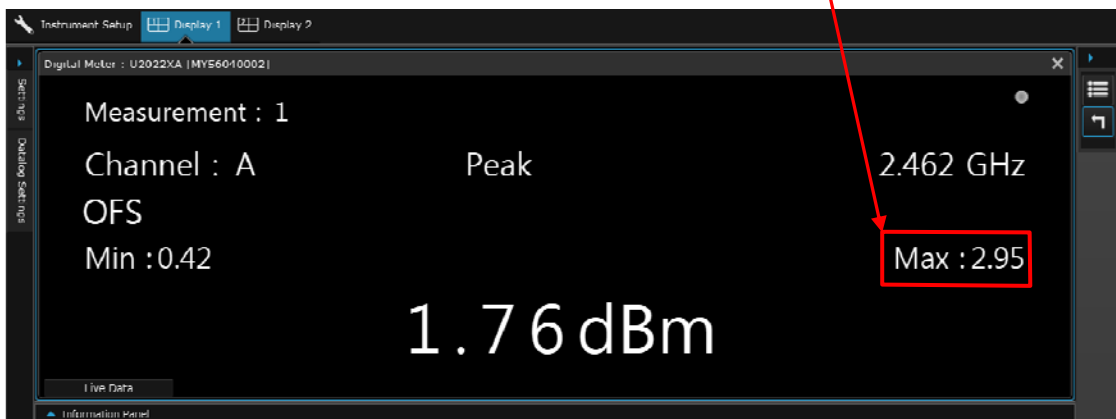

## 5.4 Bandwidth of Frequency Band Edges

EUT	Car Dashcam / DR590W-2CH
Limit apply to	FCC Part 15.247(d)
Test Date	February 26, 2018
Environmental of Test	(22.7 ± 0.2) °C, (38 ± 0) % R.H., (102.5 ± 0.0) kPa
Operating Condition	RF transmitting continuously during the tested.
Result	Passed

### Limit

In any 100 kHz bandwidth outside the frequency band in which the spread spectrum or digitally modulated intentional radiator is operating, the radio frequency power that is produced by the intentional radiator shall be at least 20 dB below that in the 100 kHz bandwidth within the band that contains the highest level of the desired power, based on either an RF conducted or a radiated measurement, provided the transmitter demonstrates compliance with the peak conducted power limits. If the transmitter complies with the conducted power limits based on the use of RMS averaging over a time interval, as permitted under paragraph (b)(3) of this section, the attenuation required under this paragraph shall be 30 dB instead of 20 dB. Attenuation below the general limits specified in Section 15.209(a) is not required. In addition, radiated emissions which fall in the restricted bands, as defined in Section 15.205(a), must also comply with the radiated emission limits specified in Section 15.209(a) (see Section 15.205(c)).

### Test Results

- Refer to see the measured plot in next page.

### NOTES:

1. This test was applied both to DC 12 V and DC 24 V. (Worst case: DC 12 V)
2. The test was performed to make a direct field strength measurement at the band edge frequencies.

## Plots of Bandwidth of Frequency Band Edges (802.11n(HT20))

Conducted

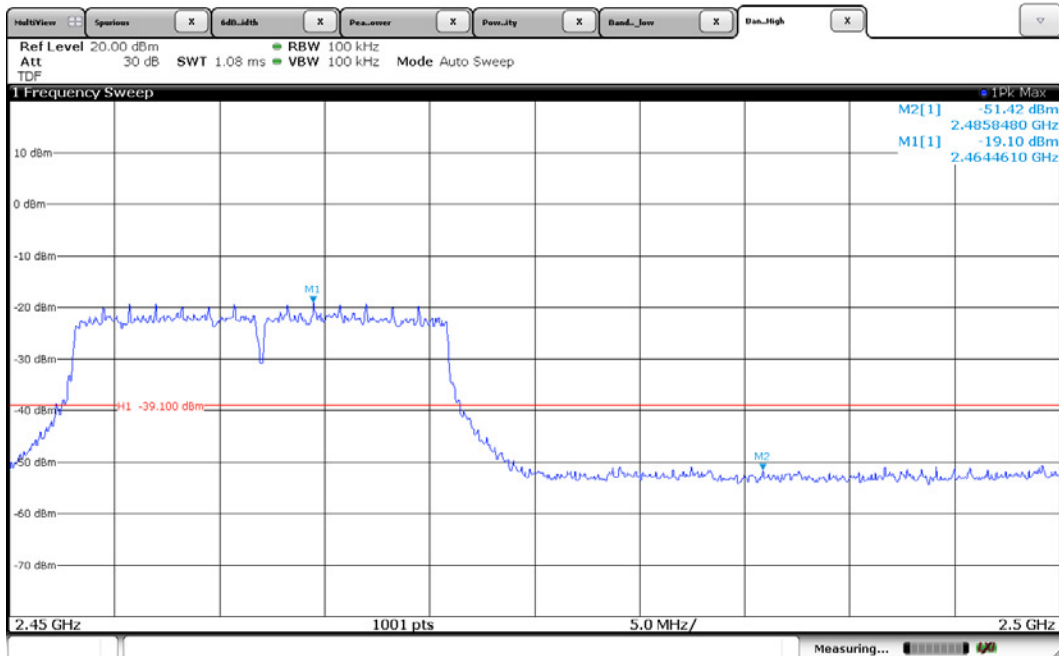
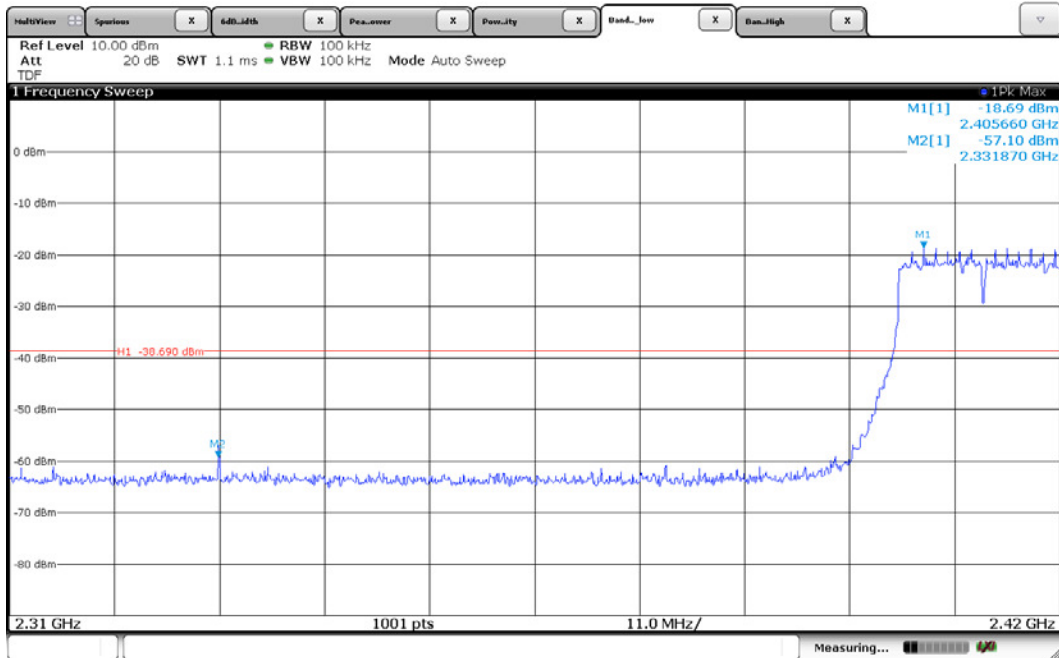

## Radiated

Peak Detector: RBW: 1 MHz, VBW: 1 MHz (2 310 MHz - 2 390 MHz), Worst case (Low, Horizontal)

— Peak Limit Line  
— AV Limit Line

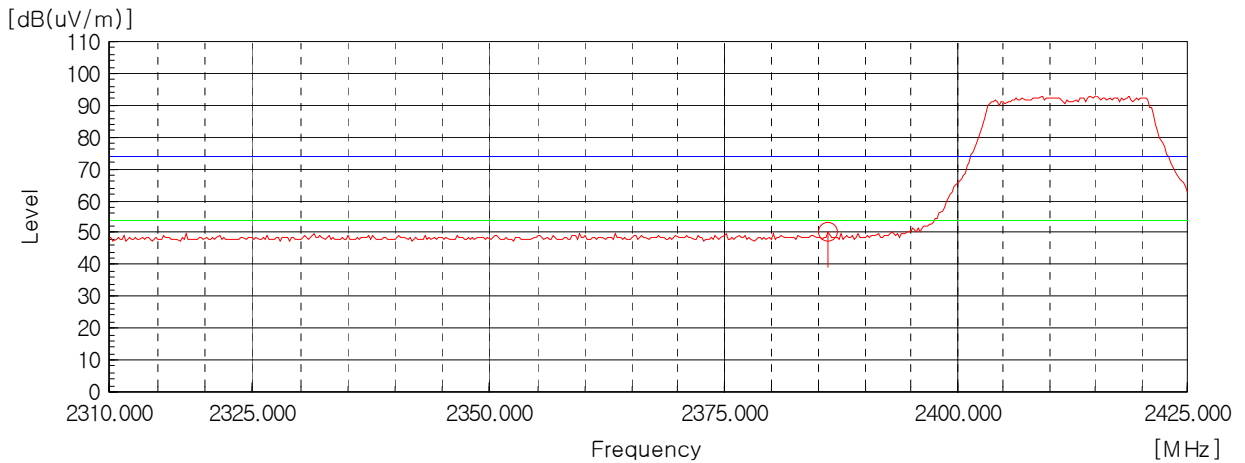

AV Detector: RBW: 1 MHz, VBW: 10 Hz (2 310 MHz - 2 390 MHz), Worst case (Low, Horizontal)

— Peak Limit Line  
— AV Limit Line

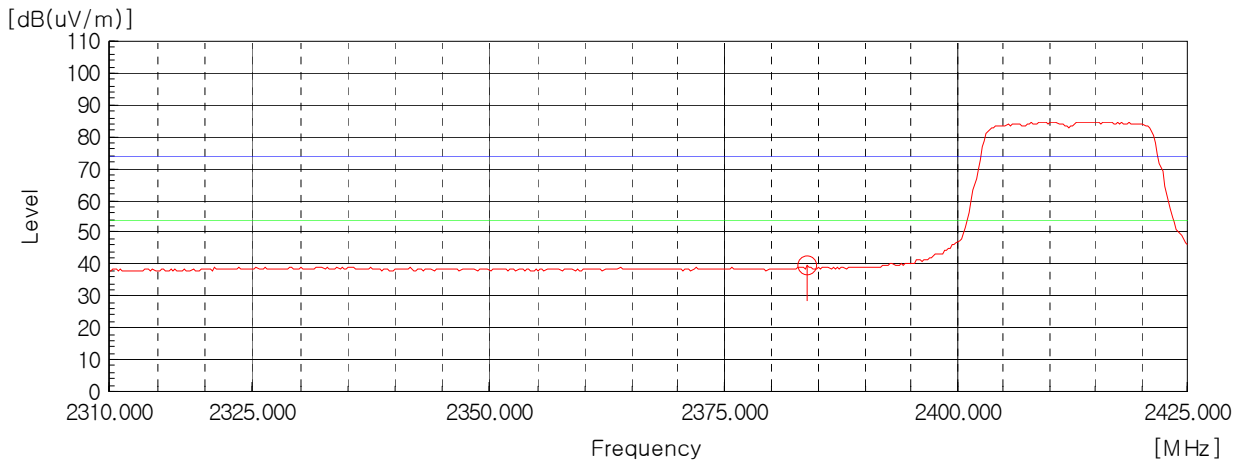

Peak Detector: RBW: 1 MHz, VBW: 1 MHz (2 483.5 MHz - 2 500 MHz), Worst case (High, Horizontal)

— Peak Limit Line  
— AV Limit Line

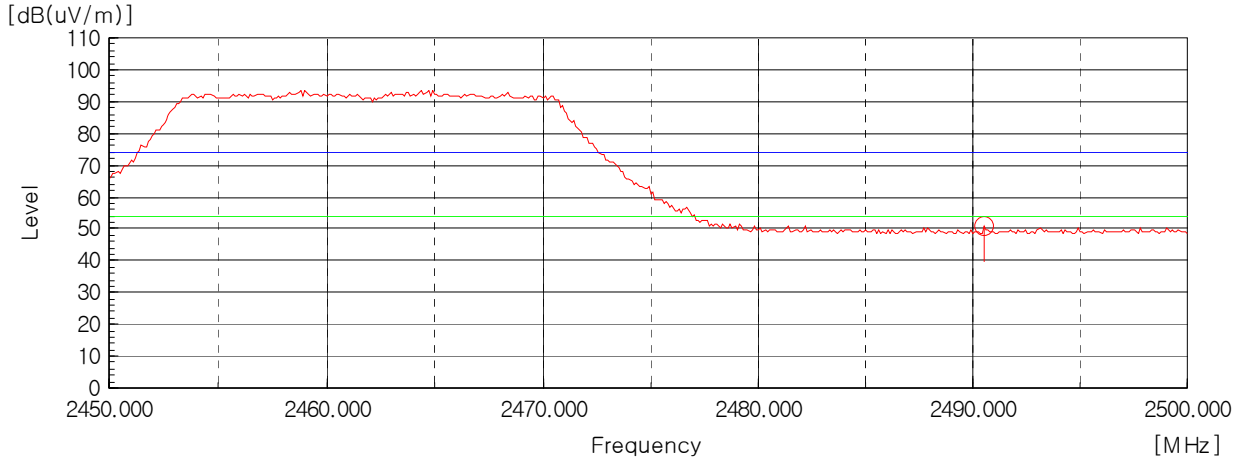

AV Detector: RBW: 1 MHz, VBW: 10 Hz (2 483.5 MHz - 2 500 MHz), Worst case (High, Horizontal)

— Peak Limit Line  
— AV Limit Line

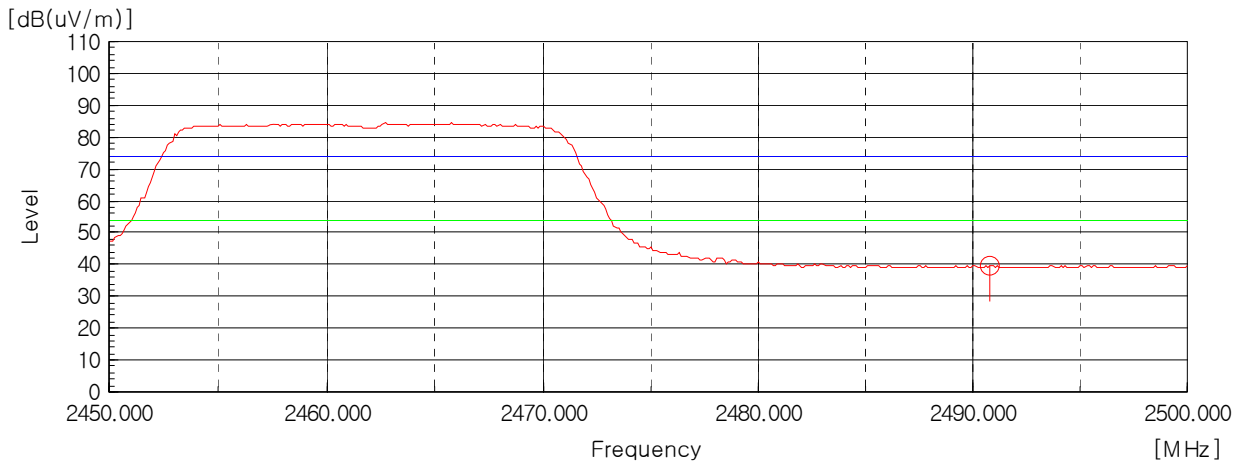

## 5.5 Power Spectral Density

EUT	Car Dashcam / DR590W-2CH
Limit apply to	FCC Part 15.247(e)
Test Date	March 06, 2018
Environmental of Test	(22.5 ± 0.0) °C, (39 ± 0) % R.H., (103.0 ± 0.0) kPa
Operating Condition	RF transmitting continuously during the tested.
Result	Passed

### Limit

For digitally modulated systems, the power spectral density conducted from the intentional radiator to the antenna shall not be greater than 8 dBm in any 3 kHz band during any time interval of continuous transmission. This power spectral density shall be determined in accordance with the provisions of paragraph (b) of this section. The same method of determining the conducted output power shall be used to determine the power spectral density.

### Test Data

Mode	Frequency [MHz]	PSD [dBm]	Limit
802.11n(HT20)	2 412	-18.40	8.00 dBm
	2 437	-18.88	
	2 462	-19.15	

### NOTES:

1. This test was applied both to DC 12 V and DC 24 V. (Worst case: DC 24 V)
2. Measure power spectral density of relevant channel using spectrum analyzer.
3. RBW 100 kHz, VBW 300 kHz, span (6 dB bandwidth x 1.5), Sweep time (auto couple).
4. Please see the measured plot in next page.

## Plots of Power Spectral Density (802.11n(HT20))

[2 412 MHz]

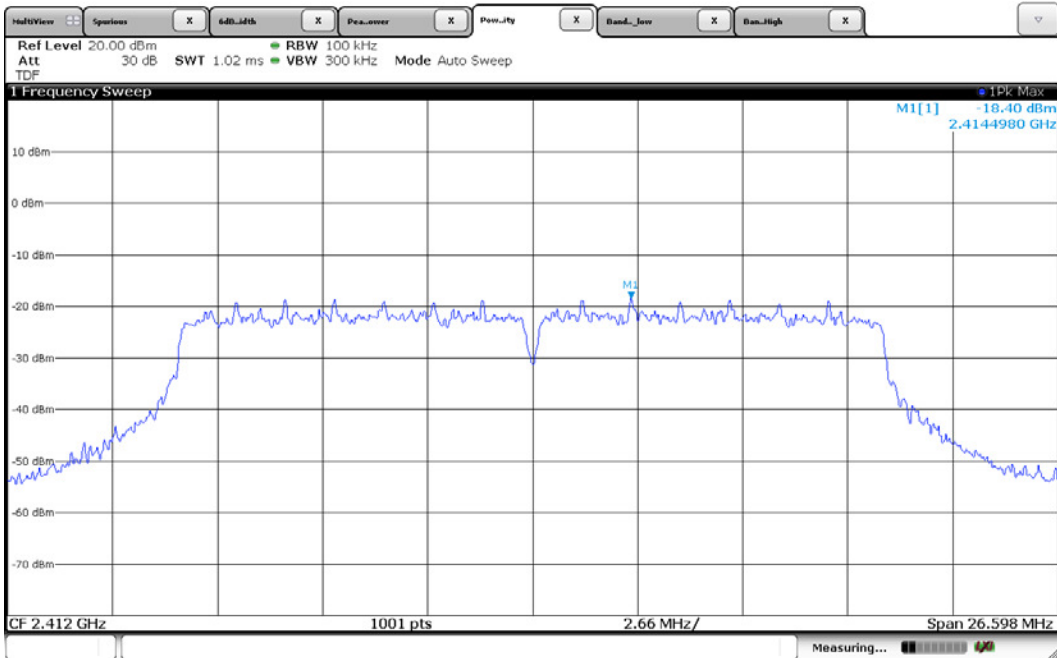

[2 437 MHz]

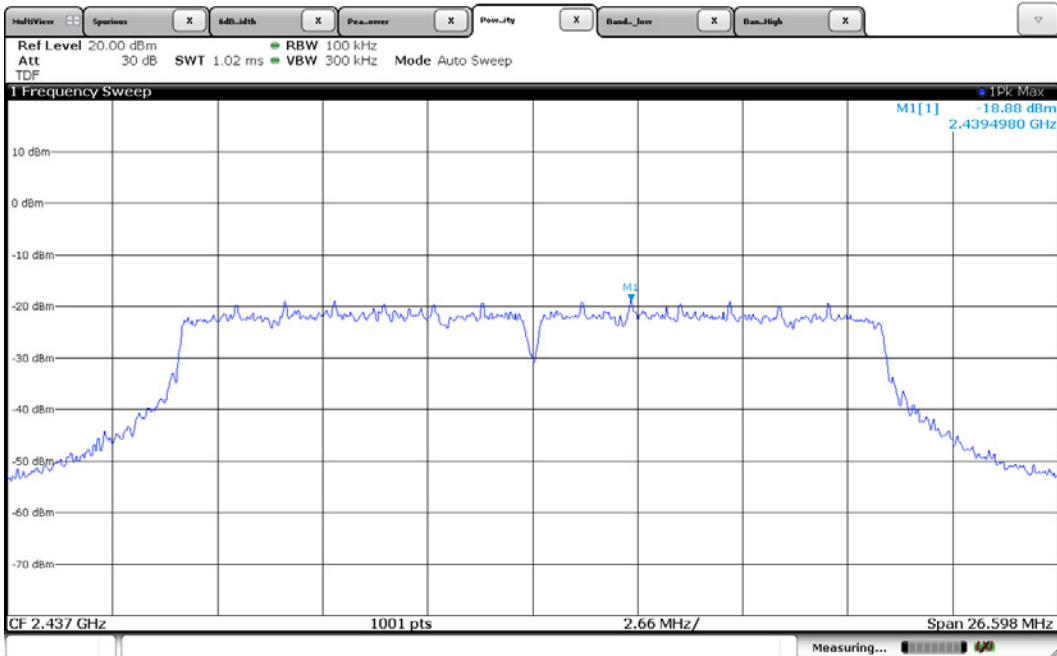

[2 462 MHz]

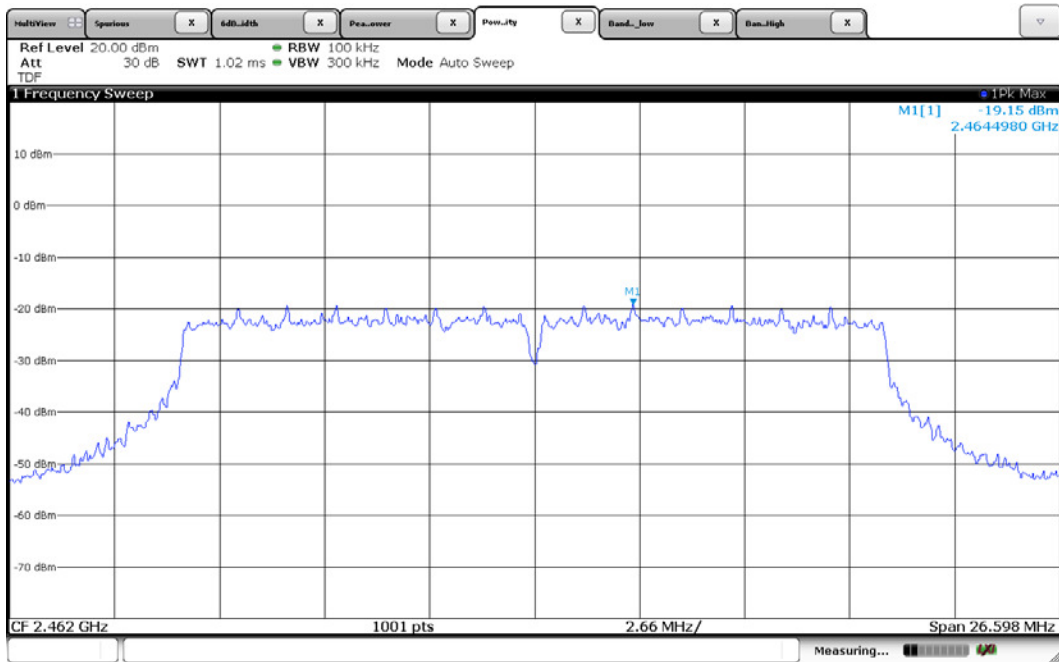



## 5.6 Spurious Emissions

EUT	Car Dashcam / DR590W-2CH
Limit apply to	FCC Part 15.209
Operating Condition	Low CH, Middle CH, High CH Transmission
Result	Passed

### Limit

Except as provided elsewhere in this Subpart, the emissions from an intentional radiator shall not exceed the field strength levels specified in the following table:

Frequencies [MHz]	Field Strength [ $\mu$ V/m]	Measurement Distance [m]
0.009 - 0.490	2 400/F(kHz)	300
0.490 - 1.705	24 000/F(kHz)	30
1.705 - 30.0	30	30
30 - 88	100	3
88 - 216	150	3
216 - 960	200	3
Above 960	500	3

\* Except as provided in paragraph (g), fundamental emissions from intentional radiators operating under this Section shall not be located in the frequency bands 54 MHz - 72 MHz, 76 MHz - 88 MHz, 174 MHz - 216 MHz or 470 MHz - 806 MHz. However, operation within these frequency bands is permitted under other sections of this Part, e.g., Sections 15.231 and 15.241.

### Test Results

- Refer to see the measured plot in next page.

## Radiated Emissions Test data

### - 9 kHz to 1 GHz

Test Date	March 02, 2018
Environmental of Test	(6.9 ± 5.4) °C, (38 ± 9) % R.H., (101.8 ± 0.2) kPa

### - 802.11n(HT20) mode

The following table shows the highest levels of radiated emissions on both polarizations of horizontal and vertical. Detector mode: CISPR Quasi-Peak mode (100 Hz, 9 kHz) (6 dB Bandwidth: 120 kHz)

Frequency [MHz]	Reading [dB(μV)]	Polarization (*H/**V)	Ant. Factor [dB/m]	Cable Loss [dB(μV)]	Height [cm]	Result [dB(μV/m)]	Limit [dB(μV/m)]	Margin [dB]
40.63	40.36	V	12.37	-32.59	105	20.14	40.00	19.86
129.70	50.82	V	8.51	-32.02	126	27.31	43.50	16.19
148.77	48.82	V	7.96	-31.84	126	24.94	43.50	18.56
299.98	49.71	V	13.69	-31.68	140	31.72	46.00	14.28
307.22	41.20	H	13.86	-31.66	285	23.40	46.00	22.60
399.96	52.87	V	16.00	-31.39	150	37.48	46.00	8.52

### NOTES:

1. This test was applied both to DC 12 V and DC 24 V. (Worst case: DC 12 V)
2. \* H : Horizontal polarization, \*\* V : Vertical polarization
3. The cable loss value was included the Amp. Gain.
4. Result = Reading + Antenna factor + Cable loss
5. Margin = Limit - Result
6. The measurement was performed for the frequency range above 9 kHz according to FCC Part 15.209.

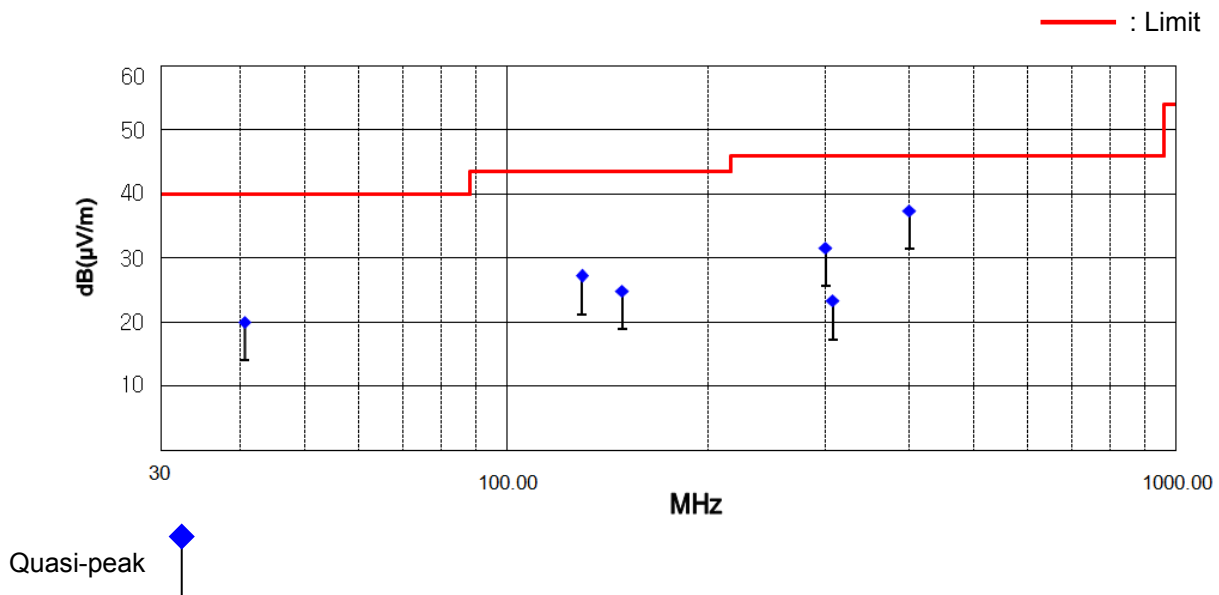

**- Above 1 GHz (1 GHz to 25 GHz)**

Test Date	March 02, 2018
Environmental of Test	(13.3 ± 4.5) °C, (27 ± 5) % R.H., (101.5 ± 0.1) kPa

- 802.11n(HT20) mode

**1. Low CH (2 412 MHz)**

Frequency [MHz]	Reading [dB(μV)]		Polarity (*H/**V)	Ant. Factor [dB/m]	Cable - AMP Loss [dB]	Height [cm]	Result [dB(μV/m)]		Limit [dB(μV/m)]		Margin [dB]	
	Peak	Average					Peak	Average	Peak	Average	Peak	Average
2 379.50	81.34	62.05	H	27.33	-46.06	150	62.61	43.32	73.97	53.97	11.36	10.65
4 201.80	67.06	51.26	V	29.95	-45.21	150	51.80	36.00	73.97	53.97	22.17	17.97
5 993.43	49.77	36.37	V	32.47	-43.34	150	38.90	25.50	73.97	53.97	35.07	28.47
14 754.68	43.78	30.54	H	41.80	-35.57	150	50.01	36.77	73.97	53.97	23.96	17.20
19 402.69	41.81	29.02	H	37.52	-32.06	150	47.27	34.48	73.97	53.97	26.70	19.49
24 928.50	42.09	29.48	V	38.33	-28.11	150	52.31	39.70	73.97	53.97	21.66	14.27

**2. Middle CH (2 437 MHz)**

Frequency [MHz]	Reading [dB(μV)]		Polarity (*H/**V)	Ant. Factor [dB/m]	Cable - AMP Loss [dB]	Height [cm]	Result [dB(μV/m)]		Limit [dB(μV/m)]		Margin [dB]	
	Peak	Average					Peak	Average	Peak	Average	Peak	Average
2 378.42	78.63	60.72	H	27.33	-46.06	150	59.90	41.99	73.97	53.97	14.07	11.98
4 201.80	65.70	49.80	V	29.95	-45.21	150	50.44	34.54	73.97	53.97	23.53	19.43
10 875.65	45.50	32.33	H	40.59	-38.45	150	47.64	34.47	73.97	53.97	26.33	19.50
13 716.65	43.82	30.93	H	42.07	-36.53	150	49.36	36.47	73.97	53.97	24.61	17.50
19 425.42	41.76	29.12	H	37.52	-32.04	150	47.24	34.60	73.97	53.97	26.73	19.37
24 621.73	42.26	29.43	V	38.19	-28.38	150	52.07	39.24	73.97	53.97	21.90	14.73

### 3. High CH (2 462 MHz)

Frequency [MHz]	Reading [dB(μV)]		Polarity (*H/**V)	Ant. Factor [dB/m]	Cable - AMP Loss [dB]	Height [cm]	Result [dB(μV/m)]		Limit [dB(μV/m)]		Margin [dB]	
	Peak	Average					Peak	Average	Peak	Average	Peak	Average
2 502.52	85.59	67.73	H	27.73	-45.61	150	67.71	49.85	73.97	53.97	6.26	4.12
4 201.77	65.96	49.29	V	29.95	-45.21	150	50.70	34.03	73.97	53.97	23.27	19.94
10 861.43	45.38	32.29	H	40.57	-38.46	150	47.49	34.40	73.97	53.97	26.48	19.57
14 295.38	43.95	30.77	H	42.24	-36.00	150	50.19	37.01	73.97	53.97	23.78	16.96
19 153.99	42.18	29.25	H	37.53	-32.23	150	47.48	34.55	73.97	53.97	26.49	19.42
24 044.06	42.13	29.16	V	37.92	-28.71	150	51.34	38.37	73.97	53.97	22.63	15.60

**NOTES:**

1. This test was applied both to DC 12 V and DC 24 V. (Worst case: DC 12 V)
2. \* H : Horizontal polarization, \*\* V : Vertical polarization
3. Factor = Antenna factor + Cable loss - Amp. Gain
4. Result = Reading + Factor
5. Margin value = Limit - Result
6. Measuring frequencies from 1 GHz to the 10<sup>th</sup> harmonic of highest fundamental frequency.
7. Measurements above show only up to 6 maximum emissions noted, or would be lesser if no specific emissions from the EUT are recorded (ie: margin > 20 dB from the applicable limit) and considered that's already beyond the background noise floor.
8. Spectrum setting:
  - a. Peak Setting 1 GHz to 10<sup>th</sup> harmonics of fundamental, RBW = 1 MHz, VBW = 1 MHz, Sweep = Auto
  - b. AV Setting 1 GHz to 10<sup>th</sup> harmonics of fundamental, RBW = 1 MHz, VBW = 10 kHz, Sweep = Auto

## Plots of Spurious Emissions (Conducted Measurement)

Test Date	March 06, 2018
Environmental of Test	(22.4 ± 0.1) °C, (39 ± 0) % R.H., (103.0 ± 0.0) kPa

### - 802.11n(HT20) mode

[CH Low]

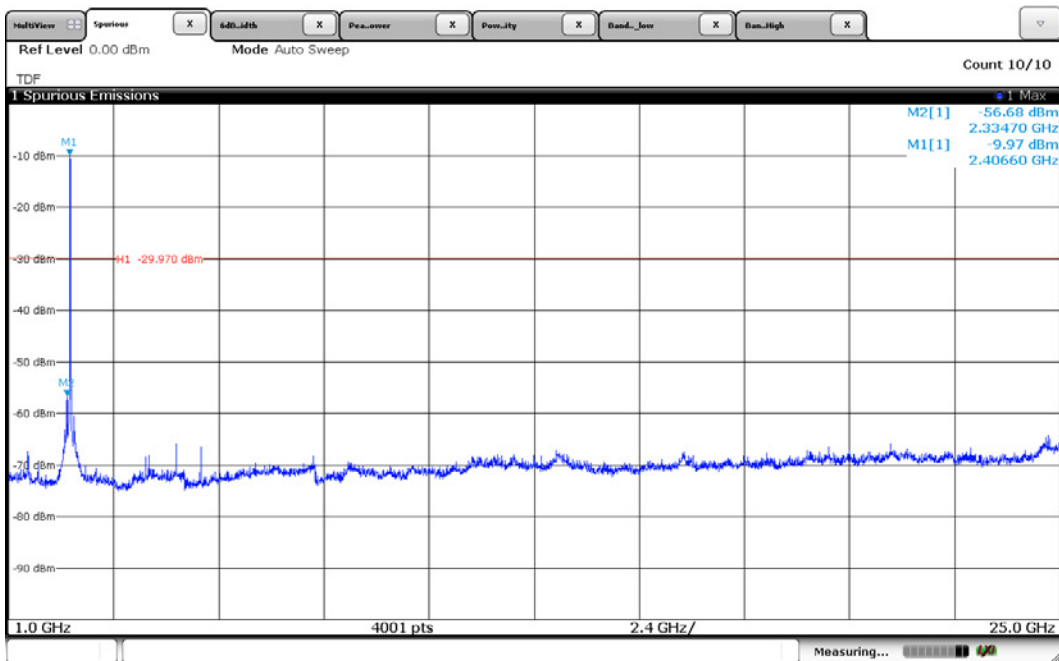
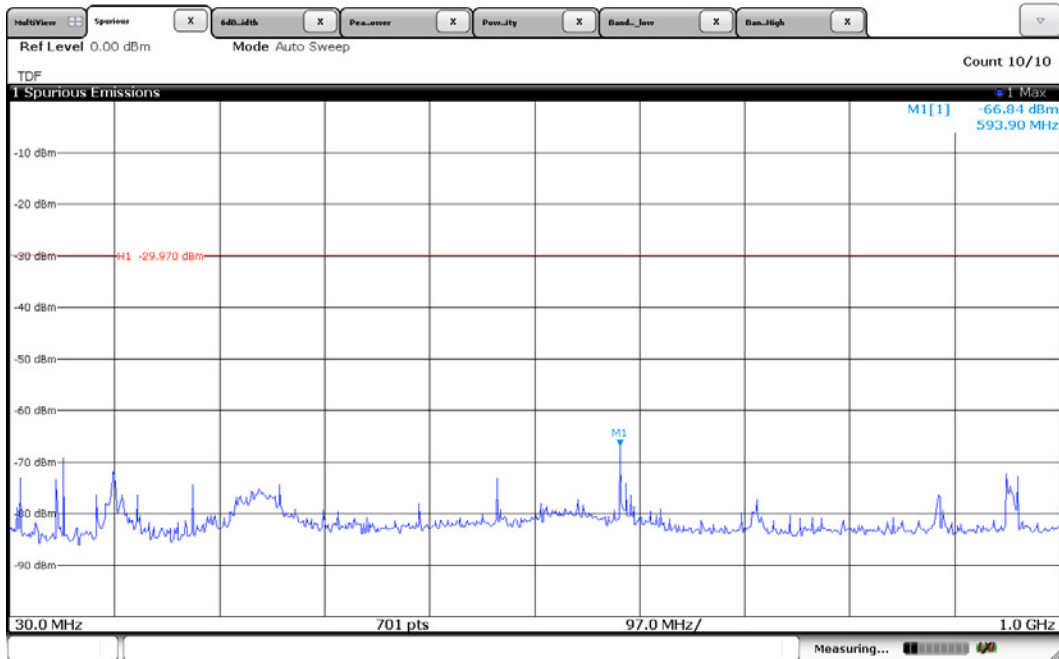

[CH Mid]

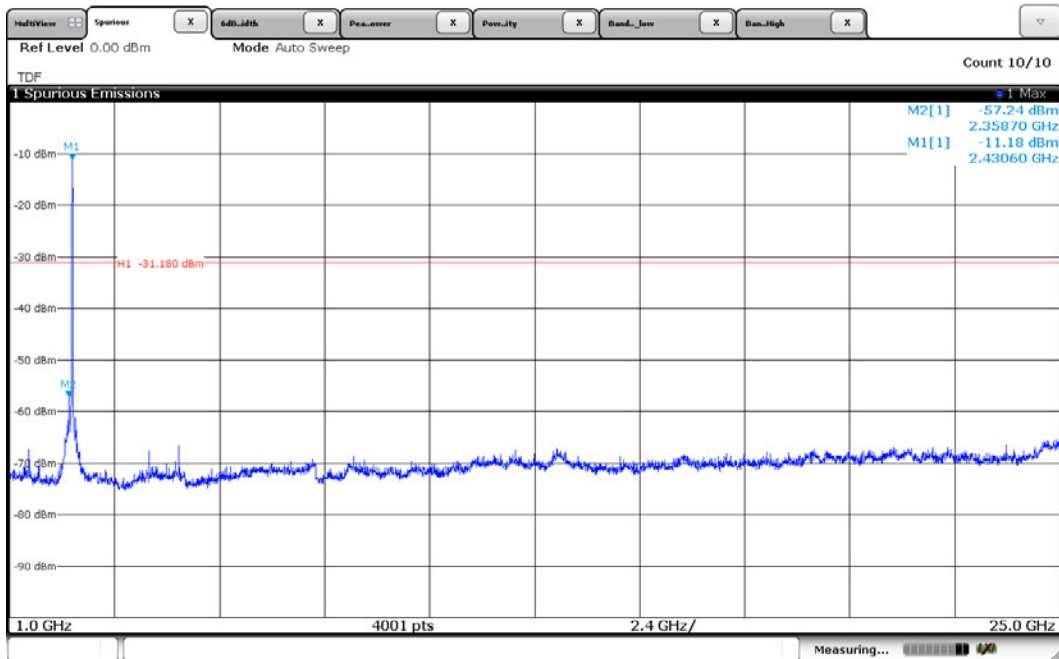
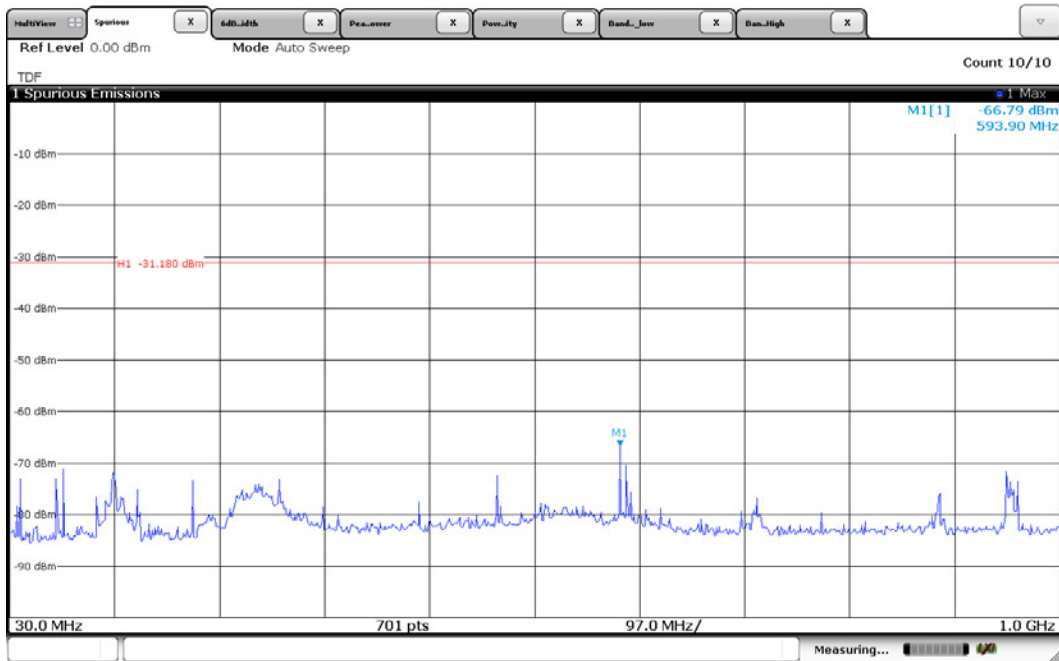

[CH High]

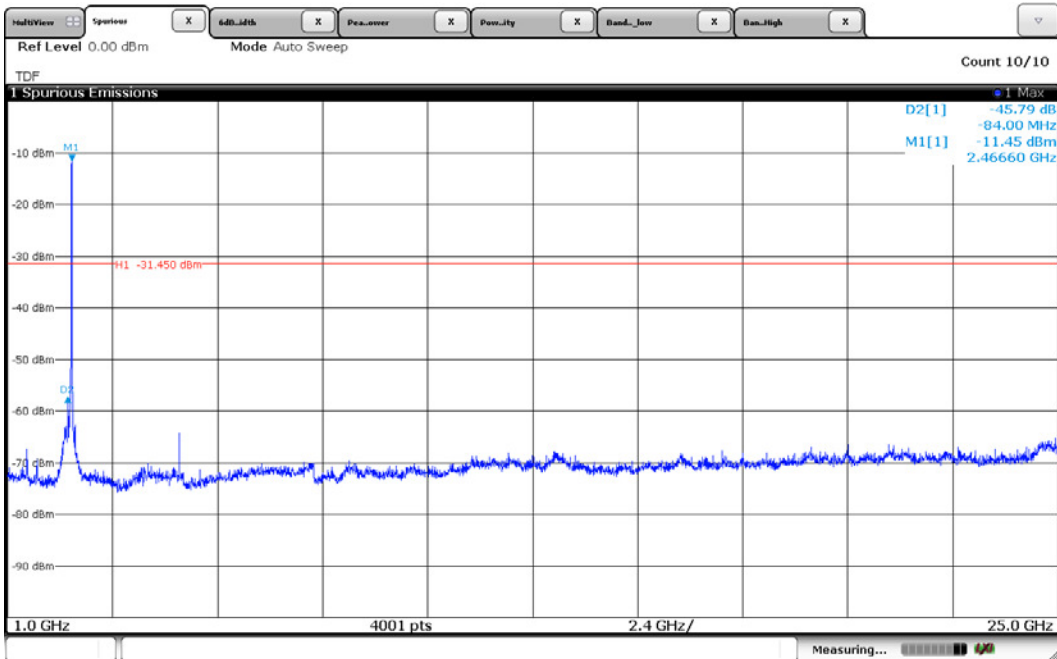
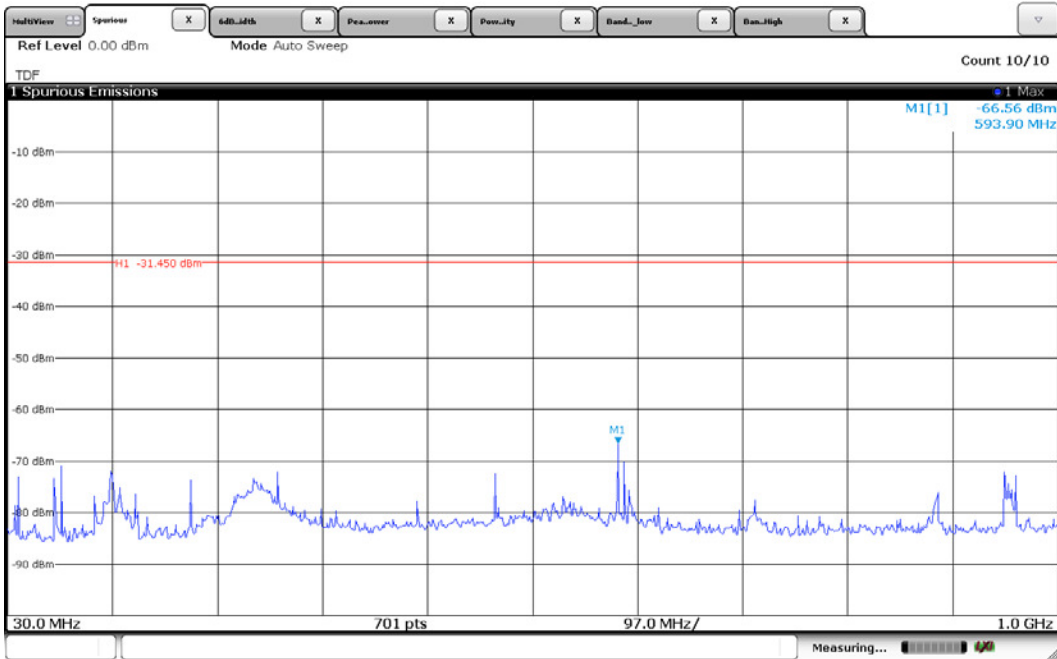

## 5.7 Conducted Emissions Measurement

EUT	Car Dashcam / DR590W-2CH
Limit apply to	FCC Part 15.207
Test Date	-
Environmental of Test	-
Operating Condition	-
Result	-

### Limit

For an intentional radiator that is designed to be connected to the public utility (AC) power line, the radio frequency voltage that is conducted back onto the AC power line on any frequency or frequencies within the band 150 kHz to 30 MHz shall not exceed the limits in the following table, as measured using a 50  $\mu$ H/50 ohms line impedance stabilization network (LISN). Compliance with the provisions of this paragraph shall be based on the measurement of the radio frequency voltage between each power line and ground at the power terminal. The lower limit applies at the boundary between the frequencies ranges.

Frequency of Emission [MHz]	Conducted limit [dB( $\mu$ V)]	
	Quasi-peak	Average
0.15 - 0.5	66 to 56 *	56 to 46 *
0.5 - 5	56	46
5 - 30	60	50

\* Decreases with the logarithm of the frequency.

### Test Results

- *This test was not applied. Because, EUT Power supplies from an automotive battery. (DC 12 V – DC 24 V)*



## 5.8 Radio Frequency Exposure

### Standard Applicable:

According to §1.1307(b)(1), systems operating under the provisions of this section shall be operated in a manner that ensure that the public is not exposed to radio frequency energy level in excess of the Commission's guideline.

This is a Portable device with its physical nature to be used nearby, the distance between radiating structure and human is less than 20 cm.

As per KDB 447498 D01, The 1-g and 10-g SAR test exclusion thresholds for 100 MHz to 6 GHz at test separation distances  $\leq 50$  mm are determined by:

$$[(\text{max. power of channel, including tune-up tolerance, mW}) / (\text{min. test separation distance, mm})] * \sqrt{f(\text{GHz})} \leq 3.0 \text{ for 1-g SAR and } \leq 7.5 \text{ for 10-g extremity SAR, where}$$

f (GHz) is the RF channel transmit frequency in GHz  
 Power and distance are rounded to the nearest mW and mm before calculation  
 The result is rounded to one decimal place for comparison

### Measurement Result:

This is a portable device and the Max tune up power is (**2.24 mW**) lower than the threshold given and derived as above, where

$$= 2.24 \text{ (mW)} / 5 \text{ (mm)} * \sqrt{2.412 \text{ (GHz)}} = 0.70 < 3.00$$

As the result of calculation result indicates, the RF exposure generating from given transmitter (transmitter employed digital modulation) can be excluded from SAR measurement, and is deemed compliant with RF exposure as per FCC.

Type of Modulation	Frequency [MHz]	Output Power [dBm]	Target power [dBm]	Allowed tolerance [dB]	Max tune up power [dBm]	Max tune up power [mW]	Separation distance [mm]	RF exposure	Limit
802.11n (HT20)	2 412	3.04	1.50	± 2.00	3.50	2.24	5	0.70	3.00
	2 437	2.80	1.00	± 2.00	3.00	2.00	5	0.62	3.00
	2 462	2.95	1.00	± 2.00	3.00	2.00	5	0.63	3.00

ex) Target power[dBm] = Max tune up power[dBm] – Allowed tolerance[dB]

## 6. SAMPLE CALCULATION

### Sample Field Strength Calculation

The field strength is calculated by adding the Antenna Factor and Cable Factor.  
The basic equation with a sample calculation is as follows:

$$FS = RA + AF + CF$$

Where FS = Field Strength

RA = Receiver Amplitude

AF = Antenna Factor

CF = Cable Attenuation Factor - Preamplifier Factor

$$\text{dB}(\mu\text{V}) = 20 \log_{10} (\mu\text{V}) : \text{Equation}$$

$$\text{dB}(\mu\text{V}) = \text{dBm} + 107$$

Example : @ 2 502.52 MHz

$$\text{Limit} = 53.97 \text{ dB}(\mu\text{V}/\text{m}) \text{ (Average)}$$

$$\text{Reading} = 67.73 \text{ dB}(\mu\text{V})$$

$$\text{Antenna Factor} + (\text{Cable Loss} - \text{Amp Gain}) = 27.73 + (-45.61) = -17.88 \text{ dB}(\mu\text{V}/\text{m})$$

$$\text{Total} = 49.85 \text{ dB}(\mu\text{V}/\text{m})$$

$$\text{Margin} = 53.97 - 49.85 = 4.12 \text{ dB}$$

$$= 4.12 \text{ dB below Limit}$$

## 7. List of test equipments used for measurements

Test Equipment	Model	Mfg.	Serial No.	Cal. Date	Cal. Due Date
<input checked="" type="checkbox"/> EMI Test Receiver	ESCI7	R&S	100851	17.08.31	18.08.31
<input checked="" type="checkbox"/> Spectrum Analyzer	E4440A	Agilent	US40420382	17.09.01	18.09.01
<input checked="" type="checkbox"/> EMI Test Receiver	ESPI3	R&S	100478	17.08.31	18.08.31
<input checked="" type="checkbox"/> Spectrum Analyzer	FSW43	ROHDE & SCHWARZ.	103794	17.09.05	18.09.05
<input checked="" type="checkbox"/> Wideband Power Sensor	U2022XA	Agilent	MY56040002	17.09.05	18.09.05
<input checked="" type="checkbox"/> Attenuator	BW-S10-2W263+	Mini-Circuits	-	18.03.14	19.03.14
<input checked="" type="checkbox"/> DC Power Supply	SDP 60-5D	SM Techno	605DOD 002	18.03.12	19.03.12
<input checked="" type="checkbox"/> Bi-Log Antenna	VULB9163	Schwarzbeck	01069	17.02.17	19.02.17
<input checked="" type="checkbox"/> Loop Antenna	6502	EMCO	00033743	16.09.05	18.09.05
<input checked="" type="checkbox"/> Horn Antenna	BBHA 9120D	Schwarzbeck	277	16.10.12	18.10.12
<input checked="" type="checkbox"/> Horn Antenna	BBHA 9170	Schwarzbeck	BBHA9170440	17.12.04	19.12.04
<input checked="" type="checkbox"/> Amplifier	TK-PA18	TESTEK	120020	17.09.01	18.09.01
<input checked="" type="checkbox"/> Amplifier	BLWA 0310-1	BONN Elektronik	045672	18.01.31	19.01.31
<input checked="" type="checkbox"/> Amplifier	JS44-18004000-45-8P	MITEQ Inc.	1568695	17.09.05	18.09.05
<input checked="" type="checkbox"/> Amplifier	TK-PA18H	TESTEK	170010-L	18.03.12	19.03.12
<input checked="" type="checkbox"/> Highpass Filter	WHKX3.0 /18G-6SS	Wainwright Instrument	15	18.03.13	19.03.13
<input checked="" type="checkbox"/> Highpass Filter	WHNX6-4740-6000 -26500-40CC	WAINWRIGHT INSTRUMENT GmbH	1	17.09.04	18.09.04
<input checked="" type="checkbox"/> Band Reject Filter	WRCGV 2402/2480-2382/2500-52/10SS	Wainwright Instrument	2R	17.08.31	18.08.31
<input checked="" type="checkbox"/> TURN-TABLE	TT 1.35 SI	SES	-	N/A	N/A
<input checked="" type="checkbox"/> Antenna Master	AM 4.5	SES	-	N/A	N/A
<input checked="" type="checkbox"/> TURN-TABLE	DS1200-S	Innco Systems GmbH	2740311	N/A	N/A
<input checked="" type="checkbox"/> Antenna Master	MA4000	AUDIX	N/A	N/A	N/A
<input checked="" type="checkbox"/> Controller	HD 2000	HD GmbH	C/125	N/A	N/A