



KCC-CMM-PTA-DR550GW-2CH  
KCC-REM-PTA-RC550

**Name** | Car Dashcam      **Manufacturer** | PittaSoft Co., Ltd. / Korea  
**Address** | BYC HIGH CITY A- 7th floor, 371-17, Gasan-Dong, Geumcheon-Gu, Seoul, 153-803, Korea  
**Sales Headquarter** Tel: +82-2-6947-4670(#3) | Fax: +82-2-6947-4699  
e-mail: sales@pittasoft.com

[www.blackvue.com](http://www.blackvue.com)

**BLACKVUE**

Car Dashcam  
DR550GW-2CH



**PITTASOFT**

# BLACKVUE Wi-Fi 2CH

---

For your safe driving

**PITTASOFT**

# BLACKVUE Wi-Fi 2CH

---

DR550GW-2CH

## Table of Contents

<b>Introduction to the Manual</b>	4	
<b>Getting started</b>	5	Cautions for Safety
	8	Checks for GPS
	8	Checks for the microSD Cards
	9	Product Features
	11	Package Components
	12	Names of Each Part
	14	How to Attach & Detach the Mounting Bracket of the Front Camera
	14	How to Attach & Detach the Mounting Bracket of the Rear Camera
<b>How to Install the BlackVue</b>	15	Checking Installation Position
	16	How to Insert & Remove the microSD Card
	17	Installation
<b>Video Recording</b>	19	Normal Recording
	19	Parking Mode Recording
	20	Event Recording
<b>Simple Video Playback</b>	21	Normal Recording
	24	How to Playback using the BlackVue App
<b>How to use the BlackVue Viewer</b>	26	Installation & Execution
	28	Screen Description
	30	Video Playback
	36	Configuration
<b>Firmware Upgrade</b>	42	
<b>Product Specifications &amp; Standards</b>	44	Product Specifications
	46	LED Indicators
	46	microSD Card Standard

## Introduction to the Manual

Thank you for purchasing a BlackVue by PittaSoft Co., Ltd.

This instruction manual contains information on how to operate your BlackVue.

Before using the product, make sure to read through this manual so as to use the product in the correct way.

To enhance the performance of the product, the contents of this instruction manual may be changed without prior notice.

### Warranty & Support

- **This product records and saves videos of vehicle accidents, but it is not guaranteed to record all accidents. Accidents with light impact that is not enough to activate the impact detection sensor may not be recorded.**
- In accordance with Personal Information Security Law & related legislation, PittaSoft Co., Ltd. will not be held responsible for any problem due to illegal use of this product.
- The recorded video produced by this product constitutes the secondary data that may help to determine the circumstances of an accident. PittaSoft Co., Ltd. will not be held responsible for any loss or damage caused by any accident.

### Copyright & Trademark

- This instruction manual is protected by Copyright Law, and all rights to it are protected by law.
- It is prohibited to reproduce, copy, modify, or translate this instruction manual without permission.
-  **BLACKVUE** BlackVue is the registered trademark of PittaSoft Co., Ltd. PittaSoft Co., Ltd. reserves the rights regarding all works related to the BlackVue brand such as product design, trademarks, and product-promotional videos. It is prohibited to reproduce, copy, modify, or use related works without permission. Any violation may be penalized in accordance with the relevant regulations.

## Getting started

### Cautions for Safety

The purpose of these cautions is to maintain user safety and avoid damage to property. Please make sure to read through this manual so as to use the product in the correct way.



#### **DANGER**

Death or property damage can be caused for users if the following directions are not followed:

- **Do not disassemble, repair, or modify the product yourself.**  
It can cause fire, electric shock, or malfunction. For internal inspection and repair, call your customer service center.
- **If any foreign matter gets inside the product, detach the power cord straightaway.**  
Call the customer service center for repair.
- **Do not operate the product while driving.**  
It can cause an accident. Stop or park your car in a safe place to operate it.
- **Do not install the product where it can interfere with the driver's vision.**  
It can cause an accident.
- **Do not use a damaged or modified power cord. Use the cords provided by the manufacturer.**  
Otherwise it can cause explosion, fire, or malfunction.
- **Do not operate the product with wet hands.**  
It can cause electric shock.
- **Do not install it in an environment with high humidity, or combustible gases or liquids.**  
It can cause explosion & fire.

**WARNING**

Death or serious injury can be caused for users if the following directions are not followed:

- **Do not leave the product where infants, children, or pets can reach it.**

They might swallow small components, or their saliva could get into it and cause an explosion due to a short circuit.

- **While cleaning the inside of the car, do not spray water or wax directly onto the product.**

It can cause fire, electric shock, or malfunction.

- **If smoke or an unusual smell is emitted from the power cord, detach it immediately.**

Call the customer service center or the dealer.

- **Keep the terminal of the power cord clean.**

A dirty terminal can cause excessive heat and fire.

- **Use the correct input voltage.**

Otherwise it can cause explosion, fire, or malfunction.

- **Connect the power cord firmly so that it cannot easily be disconnected.**

Otherwise it can cause fire.

- **Do not cover the product with any material.**

It can cause external deformation of the product or fire. Use the product and peripherals where ventilation is ensured.



## CAUTION

Injury or property damage can be caused for users if the following directions are not followed:

- **Do not spray cleaning products directly onto the outside of the product.**

It can cause discoloration, cracks, or malfunction.

- **If the product is used outside the optimal temperature range (0°C ~ 60°C), performance can decline or malfunction can be caused.**

- **Make sure that the product is installed properly.**

The product can fall as a result of vibration, and may cause physical injury.

- **While entering or exiting a tunnel, during daytime in the face of bright sunlight, or at night with no light, the quality of recorded video can deteriorate.**

- **If the product is damaged or the power supply is cut due to an accident, video may not be recorded.**

- **Excessively tinted windshield glass can distort the recorded video or cause it to be indistinct.**

- **Prolonged use of the product can increase the interior temperature and cause burns.**

- **microSD cards are a consumable so replace them after prolonged use.**

They may not record video correctly after a long time in use, so check their recording capability periodically and replace it as necessary.

- **Clean the lens regularly.**

Foreign material attached to the lens can affect the recording quality.

- **Do not remove the microSD card while it is saving or reading data.**

The data may be damaged or malfunction caused.

- **Do not use the product with its cover opened.**

- **It is recommended to install the product at the BlackVue installation center. You can check the the BlackVue installation center from the BlackVue homepage ([www.blackvue.com](http://www.blackvue.com)).**

- **It is recommended to remove the power cord if the product (BlackVue/Battery Discharge Prevention Device) is not used for a long time.**



## Checks for GPS

Even if the GPS isn't working, video is recorded, but position coordinates and driving speed are not recorded. When used for the first time, or when the product is not used for 3 consecutive days, it will take some time for the GPS to find the current position.

If there is an error with the GPS time when checking recorded video with a viewer program or the BlackVue App, turn the GPS off and on after a signal is received.

Make sure to observe the following for an uninterrupted GPS signal.

- Do not have the windshield glass tinted with a metallic component.
- Be careful with the installation of devices that may interfere with GPS reception (e.g. some wireless starters & alarms and MP3/CD players).
- Do not use it simultaneously with other devices that use GPS signal.
- Cloudy weather can interfere with GPS reception.
- GPS reception can be poor in tunnels, underpasses, or streets with many Skyscrapers or high rise buildings, and generating stations, military bases, or broadcasting transmitters etc.

## Checks for the microSD Cards

Refer to the followings for trouble-free use of your microSD card.

- It is recommended to format it once a week.
- If the recorded video suffers from break-up, format the microSD card.
- For stable function, format it with programs recommended by the SD card association. For more details, refer to the BlackVue web site ([www.blackvue.com](http://www.blackvue.com)).
- Before formatting it, copy important files to other storage media to store them.
- Press the **Wi-Fi** button on the side for 10 seconds to format the microSD card without using a PC.
- Insert the formatted microSD card into the product so that the microSD card is automatically initialized and the firmware is installed on it.
- Insert or remove the microSD card only when the product is turned off.
- microSD cards are consumables and they are guaranteed for 6 months.
- Other manufacturer's microSD cards can cause compatibility problems so it is recommended to use a PittoSoft microSD card.

## Product Features



### Ultra-high quality and smooth video

Full HD (1920x1080) 30-frame ultra-high quality front video  
HD (1280x720) 30-frame high quality rear video



### High-class design with functionality

Simple but luxurious design with the functionality of a 360-degree revolution to set any angle freely and simple but luxurious design



### 2CH Wi-Fi Video Shooting

Checking the front video as well as rear video through the built-in Wi-Fi



### SONY Exmor CMOS Sensor, Megapixel Lens

Clearer vision with high image quality Sony image sensor and high-resolution megapixel lens during both day/night-time driving



### VOD & real-time live view function

With the BlackVue app, video can be played regardless of place and time (iOS/Android supported)



### G-sensor & highly-sensitive GPS

Detailed driving record such as vehicle speed and recording location information can be checked with BlackVue viewer



### High-quality wide-angle lens (139°)

Maximized viewing angle to record accurate video of any accident



#### **Diverse recording options (Normal/Event/Parking)**

Event recording and automatic conversion & deactivation of parking mode



#### **High-compression recording mode to extend microSD card life**

Efficient memory usage with high-compression storage method



#### **Support of viewer programs for Windows PC and Mac**

BlackVue viewer program which allows you to configure various settings including resolution, voice recording and Wi-Fi and play back the recorded video

## Package Components



Front Camera

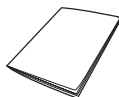

Quick Guide



Power Cord



Cable Clips (8 EA)

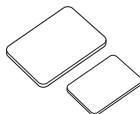

Double-sided Tape for the Mounting Bracket



microSD Card  
(Including BlackVue  
Viewer and Manual)

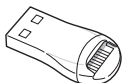

microSD Card Reader

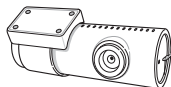

Rear Camera



Rear Camera  
Connection Cable

### Note

- Pictures of the components may differ from the actual ones.
- To enhance the performance of the product, components may be changed without prior notice.
- The package components can be purchased additionally from the BlackVue homepage ([www.blackvue.com](http://www.blackvue.com)).

## Names of Each Part

### Front Camera

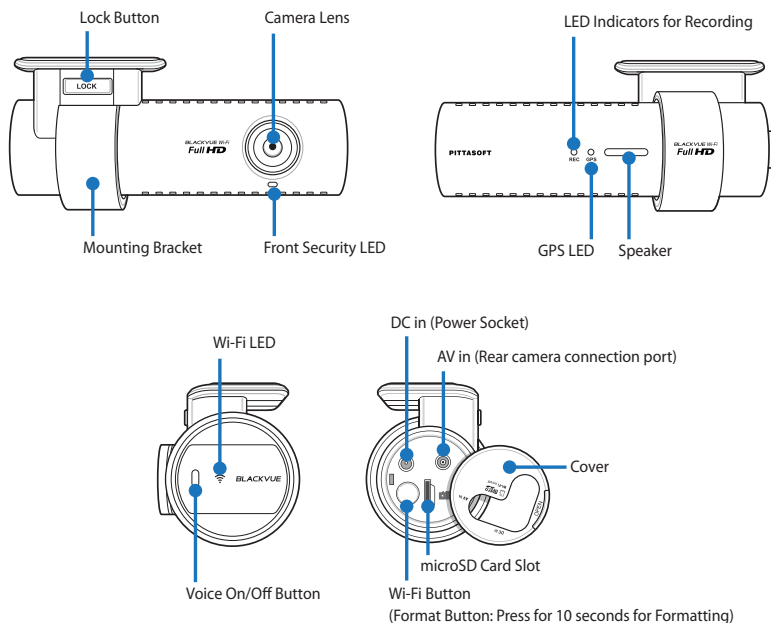

### Note

- Tap the voice On/Off button to turn the voice recording function on or off.
- Press the **Wi-Fi** button on the side for 10 seconds to format the microSD card without using a PC.

## □ Rear Camera

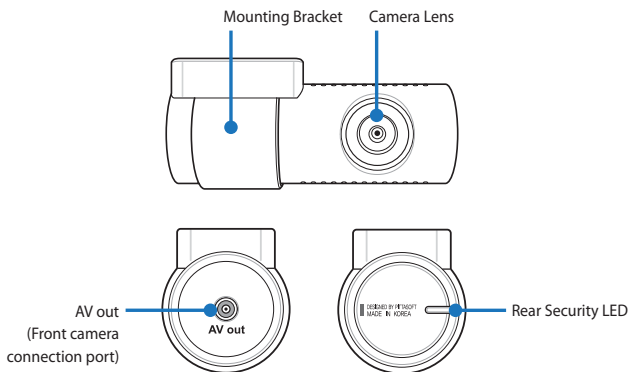

## ➤ How to Attach & Detach the Mounting Bracket of the Front Camera

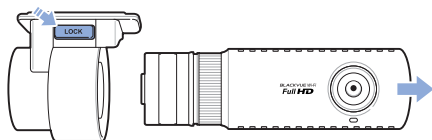

- 1 Pull the the front camera out of the mounting bracket with the **Lock** button pressed.
- 2 Insert the front camera into the mounting bracket until you hear clicking sound, to attach it.

## ➤ How to Attach & Detach the Mounting Bracket of the Rear Camera

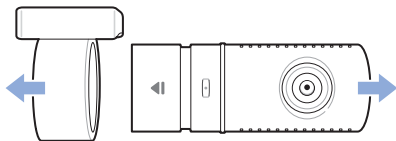

- 1 Hold the mounting bracket and pull the the front camera out of the mounting bracket.
- 2 Insert the rear camera into the Mounting Bracket until you hear clicking sound, to attach it.

## How to Install the BlackVue

### ▶ Checking Installation Position

- 1 It is recommended to install the front camera at the back of rear view mirror. Clean any foreign matter and moisture from the place where the product will be installed.

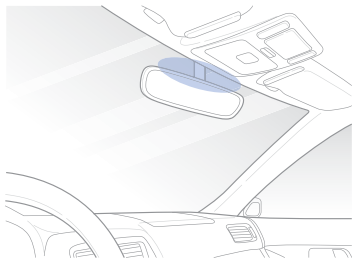

- 2 It is recommended to install the rear camera at the top of the rear window of the vehicle.

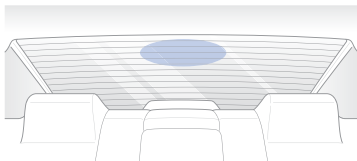

#### Note

- Do not install the product where it can interfere with the driver's vision.
- It is recommended to install the product at the designated BlackVue installation center.



## ▶ How to Insert & Remove the microSD Card

- 1 Open the cover on the side of the front camera.
- 2 Insert the microSD card into the microSD card slot, as shown in the picture.
- 3 To remove the microSD card, press the microSD card once and then pull it out. Make sure that the microSD card doesn't pop out while trying to remove it.

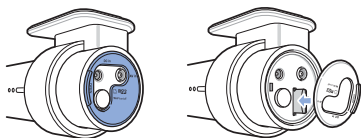

### ⚠ Caution

- Do not remove the microSD card while it is saving or reading data. The data may be damaged or malfunction caused.
- Copy important data to other storage media to store. PittaSoft Co., Ltd. will not be held responsible for data loss due to user negligence.

### 📝 Note

- Insert or remove the microSD card only when the product is turned off.
- microSD cards are consumables. Replace them after prolonged use.

## Installation

- 1 Stop the engine where there is some light and in a safe place, and then remove the key.
- 2 Attach the front camera to the windshield glass with the camera lens located in the middle of the vehicle using the double-sided tape. After installing the product, remove the lens cap.

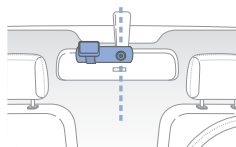
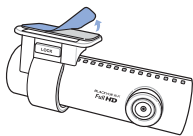

- 3 Use the power cord to connect the DC in of the front camera to car's power socket.

### Note

- It is necessary to use Power Magic (the Battery Discharge Prevention Device) to record video while the car is parked.
- To use BlackVue with other equipment that uses a power cable, purchase and use a dual power outlet adaptor.

- 4 Attach the rear camera to the rear window glass with the camera lens located in the middle of the vehicle using the double-sided tape.
- 5 Use the rear camera connection cable to connect the AV in of the front camera to the AV Out of the rear camera.
- 6 Use the cable clip to organize the cable so that it doesn't interfere with the driver's vision.

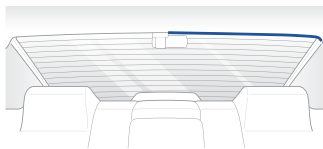
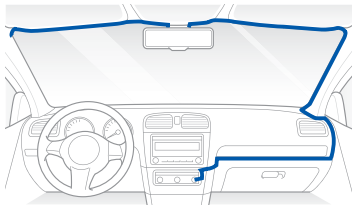

## 7 Adjust the lens angle of the camera.

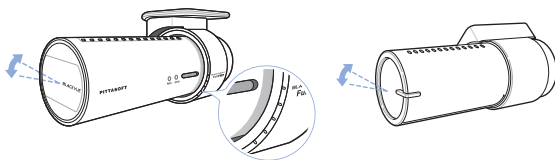

### Note

- After adjusting the angle of the camera lens, remember the angle of the mounting bracket so that it can be installed at the same angle next time.
- With smartphone and Wi-Fi connections, it is possible to adjust the angle of the camera lens while watching real-time video. (24 page)

## 8 Start the engine and check if the product works properly.

### Caution

- Do not remove the microSD card while it is saving or reading data. The data may be damaged or malfunction caused.
- Set the time (time zone) first before using the BlackVue for the first time. (36 page)

### Note

- After a test drive, check if video was correctly recorded.
- Recorded video is saved in the MP4 format.

## Video Recording

### ▶ Normal Recording

- 1 When the engine is started, the BlackVue is turned on automatically.
- 2 When the BlackVue is turned on, normal recording is automatically started.



#### Note

- If Power Magic (Battery Discharge Prevention Device) is connected, the BlackVue is not turned off.
- The normal recording function can be disabled in the BlackVue viewer configuration. (36 page)

### ▶ Parking Mode Recording

- 1 If the car doesn't move for 10 min or longer when in normal mode, it is automatically converted to parking mode recording.
- 2 In parking mode recording, if movement or impact is detected by the camera, video is recorded.



#### Note

- To use parking mode recording while the engine is stopped, connect Power Magic (Battery Discharge Prevention Device).
- Automatic conversion function of parking mode recording can be disabled in the BlackVue viewer configuration. (36 page)

## Event Recording

1 If an impact is detected in normal or parking mode recording, event recording is started.

2 It records video for 5 seconds before and 55 seconds after the impact.



### Note

- Sensitivity to impact can be adjusted in the BlackVue viewer configuration. (38 page)
- Event recording time can be adjusted in the BlackVue viewer configuration. (36 page) If you set the event recording time for 2 minute, it records video for 5 seconds before and 115 seconds after the impact.

### Normal Recording

#### Playback Using a Smartphone

With a smartphone that supports microSD cards video can be played back.

- 1 Turn off the BlackVue and remove the microSD card.

#### Note

- For the details on how to remove the microSD card, refer to **How to Insert & Remove the microSD Card**. (16 page)

- 2 Insert the microSD card into the smartphone.

- 3 Open an App to play back recorded videos and select the movie you want to play back.

#### Note

- How to play back recorded videos may differ between smartphones, so refer to your instruction manual for the details.
- If there are many recorded videos in the microSD card, it may take a long time to load the file.
- Not all smartphones support full HD video playback. For a list of smartphones that support full HD video playback, refer to the BlackVue website ([www.blackvue.com](http://www.blackvue.com)).
- With the BlackVue App, it's easy to play back videos and the Live View function can be used. For details of the BlackVue App, refer to **How to Playback using the BlackVue App**. (24 page)

## □ Watching with a GPS navigation

Recorded videos can be played back using a GPS navigation

- 1 Insert the provided microSD card into a microSD card reader.

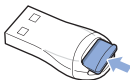

- 2 Connect the microSD card reader to the GPS navigation.



- 3 Open an application to play back recorded videos and select the movie you want to play back from the removable drive.

### 📄 Note

- How to play back recorded videos may differ between navigators, so refer to your instruction manual for the details.
- If there are many recorded videos in the microSD card, it may take a long time to load the file.
- Some navigation systems don't support full HD video playback.

## □ How to Playback using a PC

Recorded videos can be played back with a movie playback program on a PC.

- 1 Insert the provided microSD card into a microSD card reader.

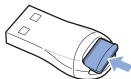

- 2 Connect the microSD card reader to the PC.



- 3 Open an application to play back recorded videos and select the movie you want to play back from the removable drive.

### 📄 Note

- For how to play back using the BlackVue viewer, refer to **Video Playback**. (30 page)



## ▶ How to Playback using the BlackVue App

- 1 Install the BlackVue App and open it in the smartphone. The BlackVue App can be downloaded from the Google Play store and Apple App Store.



### Note

- The BlackVue application can be used with Android 2.3 or later and iOS 5.0 or later.
- Some functions may not be supported depending on the smartphone.

- 2 Press the **Wi-Fi** button on the side of the product, to turn on Wi-Fi.

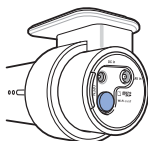

- 3 Tap the **Wi-Fi** button in the BlackVue App. The Wi-Fi SSID is 'DR550GW-last 6-digit number of MAC Address' and MAC address printed on the sticker attached to the product box. (e.g. DR550GW-A682DE). Select the device you want to connect and, enter the password. Tap the **OK** button to connect it to the selected device.



#### Note

- If you save the connection information when connecting using Wi-Fi, you can tap the **Wi-Fi** button in the BlackVue App to connect it without turning on the Wi-Fi function of the smartphone.
- The initial password is **blackvue**, but the user can change it.
- For the Live View function, Wi-Fi can be used within a 10 m range, although the range may vary in some circumstances.
- For playback of recorded videos using Wi-Fi, reception may vary according to the data transfer rate.
- For details about how to configure Wi-Fi, refer to **Wi-Fi & Other Configuration**. (40 page)

#### 4 Select the recorded video in the video list you want to play back.



#### Note

- Tap the **Live View** button to check the video in real time.
- If the Live View or VOD playback & copy function is used while it is connected via Wi-Fi and recording Full HD (1920x1080) @30fps, the recording frame is reduced to 20 fps.

## How to use the BlackVue Viewer

### Installation & Execution

#### How to Install

Dedicated BlackVue viewer can be installed in a PC.

- 1 Insert the provided microSD card into a microSD card reader.

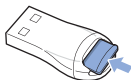

- 2 Connect the microSD card reader to the PC.



- 3 Execute the 'BlackVueSetup(HD).exe' file in the 'BlackVue\Software' folder.
- 4 Install the program according to the installation program instruction. When the installation is finished, the BlackVue viewer icon is displayed on the desktop.
- 5 Double-click the BlackVue Viewer icon to execute the program.

#### Note

- Only the English version of BlackVue viewer is available for Mac, and the functions & screen may be different from the BlackVue viewer for Windows.

## □ How to Execute Without Installation

It is possible to execute the dedicated BlackVue viewer without installation.

- 1 Insert the provided microSD card into a microSD card reader.

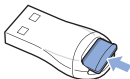

- 2 Connect the microSD card reader to the PC.





- 3 Double-click 'BlackVue.exe' in the 'BlackVue\Application' folder.

## ➤ Screen Description



No.	Name	Description
1	Playback Screen for Recorded Videos	Videos can be played back using this screen. The mouse can be used to zoom in/out.
2	G-Sensor Information	G-sensor information can be checked, at the time the video was recorded.
3	GPS Information	GPS information can be checked, at the time the video was recorded.

No.	Name	Description
4	Recorded Video List	<p>Using the file list and map tab, the recorded video list, and where a video was recorded can be checked.</p> <p>You can display only the rear camera files in the recorded video list by clicking Front, and You can display only the front camera files in the recorded video list by clicking Rear.</p> <p> : This is an normal recording file and marked with green in the timeline.</p> <p> : This is an event recording file and marked with orange in the timeline.</p> <p> : This is a parking mode recording file and marked with blue in the timeline.</p>
5	Timeline	<p>Video can be explored with the date, hr, min, and sec of when a video was recorded. For details on the timeline, refer to the <b>Timeline</b>. (31 page)</p>
6	Playback Option Button	<p>You can adjust the screen, playback speed or volume while a recorded video is played back. For the details on the playback option buttons, refer to <b>How to Control the Playback of Recorded Video</b>. (30 page)</p>

## ▶ Video Playback

### □ How to Control the Playback of Recorded Video

The recorded video can be played back in full screen mode and be reversed upside down. The playback speed can be adjusted.

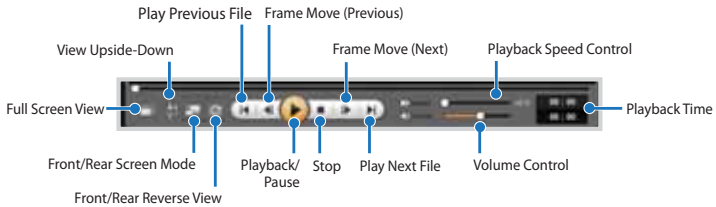

#### 📄 Note

- While a recorded video is played back, double-click the screen to switch to full screen view. Double-click the screen again or press ESC to return to default view.
- While playing back a recorded video, use the mouse wheel to zoom in/out.
- While playing back a recorded video, right-click the screen to view 100 % zoom-in screen.

## □ Magnifying Glass

Some parts of a recorded video can be zoomed in while playing back.

Left-click the screen while a recorded video is being played back to see a partial zoom-in window and to use it to identify the number plate of a car while moving it.



## □ Timeline

Video can be explored with the date, hr, min, and sec of when a video was recorded.

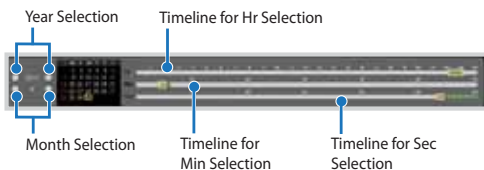

### 📄 Note

- In the date selection area, the date with a recorded video is marked by a red circle and the currently-selected date is marked by a yellow circle.



## □ How to Manage Files

With the recorded video list, a file can be deleted or saved with a different name.

- 1 Select a file from the recorded video list and right-click it.



- 2 To delete a file, click **Delete**.
- 3 To save it with different name, click **Export** and select the option you want.



### 📄 Note

- When you select **Sound Off**, the voice is removed from the recorded video to be saved.

- 4 Press the **OK** button and select the file name you want, together with the path.
- 5 Press the **Save** button to finish.

## □ How to Check the Map

Where a video was recorded can be checked with the map.

- 1 Select a file from the recorded video list and play it back.
- 2 Press the **Map** tab.
- 3 With the +/- button or mouse wheel, the map can be zoomed in/out.



### 📄 Note

- To use the map service, an Internet connection is required.
- Only for the recorded file with GPS information, the data can be checked.

## □ How to Check MyWay Viewer

The driving route of a recorded video can be checked.

- 1 Select a file from the recorded video list and play it back.
- 2 Press the  button. The driving route will be displayed on the map.
- 3 Double-click the map to play back the recorded video of the nearest driving route from the clicked point.

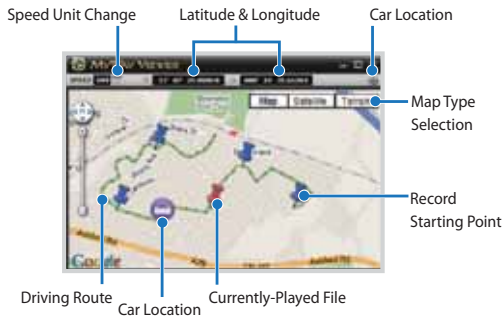

### Note

- To use the map service, an Internet connection is required.
- Only for the recorded file with GPS information, the data can be checked.

## □ How to Save as an Image

While playing back a recorded video, some parts can be saved as images if you want.

- 1 Select a file from the recorded video list and play it back.
- 2 From the image to be saved, click the  button.

### Note

- Use the timeline or press the  /  button to explore detailed images.

- 3 Press the  button.
- 4 Select the file name you want, together with the path, and click the **Save** button.

### Note

- JPG and BMP formats are supported for image files.

## □ How to Print Out an Image

While playing back a recorded video, some parts can be printed out as images if you want.

- 1 Select a file from the recorded video list and play it back.
- 2 From the image to be saved, click the  button.

### Note

- Use the timeline or press the  /  button to explore detailed images.

- 3 Press the  button.
- 4 Select the printer and click the **OK** button.

## Configuration

### Basic Configuration

Time, video, and recording configurations can be changed.

- 1 Click the  button and click the **Basic** tab.
- 2 After changing the configuration, click **Save & Close**.



No.	Function	Description
1	Time Configuration	The time zone can be configured for where it is used. The configured time zone is used as information for recorded video.
2	Image Setting	The quality and brightness of the recorded front/rear video can be configured. For details on the recording time, refer to <b>microSD Card Standard</b> . (46 page)

No.	Function	Description
3	Recording Configuration	<b>Normal Record, Voice Record, Date and Time Display</b> and <b>Auto Switching to Parking Mode</b> function can be turned on/off. <b>Speed Display</b> and recording mode, <b>Record File Unit</b> and <b>Recording Storage Setting</b> can be changed.

 **Note**

- With the **normal recording function disabled**, only event and parking mode recording videos are saved.
- With the **speed display unit disabled**, the vehicle speed is not displayed when the recorded videos are played back.
- On microSD cards, older files are deleted first to mark space for newly-recorded videos. Copy and store important files such as even recording files to other storage media.
- Tap the voice On/Off button to turn the voice recording function on or off.

## □ How to Configure Sensitivity

It is possible to configure the G-sensor sensitivity to start event recording during normal recording and the G-sensor & motion detection sensitivity to start event recording during parking mode recording, respectively.

- 1 Click the  button and click the **Sensitivity** tab.
- 2 After changing the configuration, click **Save & Close**.

### Note

- For details about advanced sensitivity configuration, refer to **Advanced Sensitivity Configuration**. (39 page)



No.	Function	Description
1	Apply to Always-on Recording	It is possible to configure the G-sensor sensitivity to start event recording during always-on recording.
2	Apply to Parking Mode	It is possible to configure the G-sensor and motion detection sensitivity to start event recording during parking mode recording.

## □ Advanced Sensitivity Configuration

The sensitivity can be configured while watching a recorded video.

- 1 Click the  button and click the **Sensitivity** tab.
- 2 Click the **Advanced Setting** button of the configuration you want.
- 3 Play back a recorded video. Saved G-sensor information is displayed at the bottom of the recorded video which is played back.





- 4 Move the control bar up/down to adjust the sensitivity range. If the range is wide, it is less sensitive, and if the range is narrow, it is more sensitive.

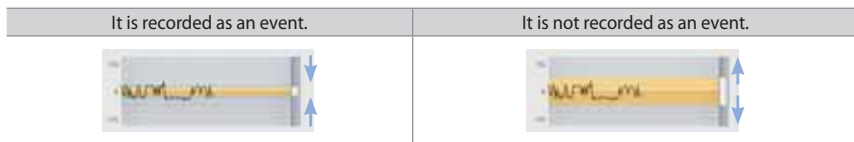

 **Note**

- If an event recording is started due to the sensitivity configured while a recorded video is being played back, the edge of the playback screen blinks in orange.

- 5 After changing the configuration, click **Save & Close**.

**Wi-Fi & Other Configuration**

Configurations for Wi-Fi, LED indication, and voice direction can be changed.



No.	Function	Description
1	Wi-Fi Setting	You can change SSID and your password for the Wi-Fi connection. The BlackVue App can be accessed with the SSID and password chosen by the user and you can also reset the password if you have forgotten it.
2	Etc.	For video recording status, normal recording mode, and parking mode recording, the LED indicators can be turned on/off. Voice direction item or the volume can be changed.

## How to Apply Configuration

The user's configuration can be applied to the product.

- 1 Insert the microSD card into the product. For details on how to insert the microSD card, refer to **How to Insert & Remove the microSD Card**. (16 page)
- 2 When the power is turned on, the user's configuration is automatically applied.



### Note

- Insert the microSD card only when the product is turned off.

## Firmware Upgrade

You can upgrade the firmware version by connecting the microSD card into the PC. You can also upgrade the firmware version with the BlackVue App, and for details, refer to the BlackVue App manual.

- 1 Connect the microSD card to the PC. For details on how to connect, refer to **How to Playback using a PC** (23 page)
- 2 Access the BlackVue web site ([www.blackvue.com](http://www.blackvue.com)) and download the firmware upgrade file.
- 3 Double-click the firmware upgrade file to execute it and perform the upgrade according to instructions provided in the program.



### Note

- After firmware upgrade, all the user's configurations including the Wi-Fi setting are initiated.
- When the firmware upgrade is finished, the BlackVue viewer is automatically installed. If you don't want it to be installed, click the **Cancel** button.

**4** After the firmware upgrade is finished, insert the microSD card into the BlackVue.

 **Note**

- For details on how to insert the microSD card, refer to **How to Insert & Remove the microSD Card**. (16 page)
- Insert the microSD card only when the product is turned off.

**5** When the power is turned on, it is automatically upgraded.

 **Caution**

- Make sure that the power is never turned off while firmware upgrade is in progress

## Product Specifications & Standards

### Product Specifications

<b>Model Name</b>	DR550GW-2CH												
<b>Color/Size/Weight</b>	Front: Pearl Black / Length 118.5mm x Diameter 36mm / 120g Rear: Pearl Black / Length 67.4mm x Diameter 27.6mm / 30g												
<b>Memory</b>	microSD Card (16GB/ 32GB)												
<b>Recording Mode</b>	Normal Recording, Event Recording (Impact Detection), and Parking mode Recording (Motion+Impact Detection) ※ For Parking mode recording, a battery discharge prevention device is required.												
<b>Camera</b>	Front: CMOS Sensor (Approx. 2.4M Pixel) Rear: CMOS Sensor (Approx. 1M Pixel)												
<b>Viewing Angle</b>	Front: Opposite Angle 139°, Horizontal 116°, Vertical 61° Rear: Opposite Angle 139°, Horizontal 116°, Vertical 61°												
<b>Resolution/Frame</b>	<table border="1"><thead><tr><th>Front</th><th>Rear</th></tr></thead><tbody><tr><td>Full HD(1920x1080)@30Fps</td><td>HD(1280x720)@30Fps</td></tr><tr><td>Full HD(1920x1080)@15Fps</td><td>HD(1280x720)@15Fps</td></tr><tr><td>HD(1280x720)@30Fps</td><td>HD(1280x720)@30Fps</td></tr><tr><td>HD(1280x720)@15Fps</td><td>HD(1280x720)@15Fps</td></tr><tr><td>D1(720x480)@30Fps</td><td>HD(1280x720)@30Fps</td></tr></tbody></table> ※ Resolution/frame can be changed	Front	Rear	Full HD(1920x1080)@30Fps	HD(1280x720)@30Fps	Full HD(1920x1080)@15Fps	HD(1280x720)@15Fps	HD(1280x720)@30Fps	HD(1280x720)@30Fps	HD(1280x720)@15Fps	HD(1280x720)@15Fps	D1(720x480)@30Fps	HD(1280x720)@30Fps
Front	Rear												
Full HD(1920x1080)@30Fps	HD(1280x720)@30Fps												
Full HD(1920x1080)@15Fps	HD(1280x720)@15Fps												
HD(1280x720)@30Fps	HD(1280x720)@30Fps												
HD(1280x720)@15Fps	HD(1280x720)@15Fps												
D1(720x480)@30Fps	HD(1280x720)@30Fps												
<b>Video Compression Mode</b>	Video MP4												
<b>Wi-Fi</b>	Built-in (802.11b/g/n(2.4~2.4835GHz), Max150Mbps, OFDM/CCK/16-QAM/64-QAM)												
<b>GPS</b>	Built-in												
<b>Microphone</b>	Built-in												

<b>Speaker</b>	Built-in ※ Voice Directions
<b>LED Indicators</b>	Front: Recording LED, GPS LED, Wi-Fi LED, Front Security LED Rear: Rear Security LED
<b>Sensor</b>	3-Axis Acceleration Sensor
<b>Button</b>	Wi-Fi On/Off Button ※ Self-format Function: Press it for 10 seconds to format the microSD card
	Voice On/Off Button ※ The proximity sensor is built-in so that voice recording can be turned on/off by approaching it with a hand ※ Touch the button or it recognizes when a hand approaches to within about 2 cm
<b>Backup Battery</b>	Built-in super capacitor
<b>Input Power</b>	DC 12V-24V
<b>Current Consumption</b>	Approx. 4.8W ※ Varies depending on Wi-Fi usage
<b>Operation Temperature</b>	-20°C~ 70°C
<b>Certificates</b>	KC, FCC, CE, RoHS, Telec
<b>Software</b>	BlackVue Viewer ※ Windows XP or later (Up to Windows 8), Mac Leopard OS X(10.5) or later
<b>Application</b>	BlackVue App (Android 2.3 or later & iOS 5.0 or later)

## LED Indicators

State \ LED	Recording State (REC)	GPS	Wi-Fi	Front Security	Rear Security
<b>Boot-up</b>	Blinking				White Blinking
<b>Recording</b>	<b>Normal</b>	Orange Blinking		White Blinking	White Blinking
	<b>Event</b>	Red Blinking		Fast White Blinking	Fast White Blinking
	<b>Parking</b>	Green Blinking		White Blinking	White Blinking
<b>Wi-Fi ON</b>			Lighting	White Blinking	White Blinking
<b>Wi-Fi ON/OFF Change</b>			Blinking		
<b>GPS ON</b>		Blue Light		White Blinking	White Blinking
<b>Software Control</b>	Available	Unavailable	Unavailable	Available	

## microSD Card Standard

Resolution (Front+Rear) \ Memory Capacity	Full HD + HD @30fps	Full HD + HD @15fps	HD + HD @30fps	HD + HD @15fps	D1 + HD @30fps
<b>16GB</b>	4 HR 30 MIN	5 HR 10 MIN	5 HR 10 MIN	6 HR	7 HR 30 MIN
<b>32GB</b>	9 HR	10 HR 30 MIN	10 HR 30 MIN	12 HR	15 HR



### Note

- There may be some variation with actual recording time depending on the user's environment.

## Before Requesting A/S Service

- It is required for users to back up important data regularly from storage device (to other separate media). Depending on the situation, it will be necessary to delete the data from the internal storage device (component). It might be needed to delete all the data from the product for A/S. So it is required for users to back up important data by themselves before requesting A/S. For all the A/S products, it is regarded that the user already backed up the data so there is no additional back-up process. Therefore, it is important to note that we are not responsible for any data lost during A/S.

## FCC Compliance Information (FCC ID: YCK-DR550GW-2CH)

THIS DEVICE COMPLIES WITH PART 15 OF THE FCC RULES.

Operation is subject to the following two conditions; (1) This device may not cause harmful interference, and (2) This device must accept any interference received, including interference that may cause undesired operation.

- CAUTION : Changes or modifications not expressly approved by the party responsible for compliance could void the user's authority to operate the equipment.

- Note: This equipment has been tested and found to comply with the limits for a Class B digital device, pursuant to part 15 of the FCC Rules. These limits are designed to provide reasonable protection against harmful interference in a residential installation. This equipment generates, uses and can radiate radio frequency energy and, if not installed and used in accordance with the instructions, may cause harmful interference to radio communications. However, there is no guarantee that interference will not occur in a particular installation. If this equipment does cause harmful interference to radio or television reception, which can be determined by turning the equipment off and on, the user is encouraged to try to correct the interference by one or more of the following measures:

- Reorient or relocate the receiving antenna.
- Increase the separation between the equipment and receiver.
- Connect the equipment into an outlet on a circuit different from that to which the receiver is connected.
- Consult the dealer or an experienced radio/TV technician for help.

Modifications not expressly approved by the manufacturer could void the user's authority to operate the equipment under FCC rules.

This equipment complies with FCC radiation exposure limits set forth for an uncontrolled environment.

This equipment should be installed and operated with minimum 20 cm between the radiator and your body.

This transmitter must not be collocated or operating in conjunction with any other antenna or transmitter unless authorized to do so by the FCC.



# Product Warranty

- The term of this product warranty is 1 year from the purchase date.

(Accessories such as Battery/microSD Card : 6 Months)

- We, PittoSoft Co., Ltd., provide the product warranty according to Consumer Dispute Settlement Regulations (drawn up by the Fair Trade Commission). PittoSoft or designated partners will provide the service upon request.

Product Name (Model Name)		Serial No.	
Purchased When		Purchased Where	
Customer Information		Address / Call Number	

Consumer Injury		Warranty		
		Within the Term	Out of the Term	
For performance/functional problems under normal use conditions	For serious repair required within 10 days of purchase	Exchange/Refund	N/A	
	For serious repair required within 1 month of purchase	Exchange		
	For serious repair required within 1 month of exchange	Exchange/Refund		
	When not exchangeable	Refund	Paid Repair/ Paid Product Exchange	
	Repair If Available	For Defect		Free Repair
		Repeated problem with the same defect (up to 3 times)		Exchange/ Refund
		Repeated trouble with different parts (up to 5 times)		
	For the loss of a product while in A/S	Exchange/ Refund after depreciation plus an additional 10% Maximum purchase price)		
	Repair If Unavailable			When repair is unavailable due to lack of spare parts within the component holding period
			When repair is unavailable even with spare parts	Exchange/ Refund after depreciation
1) Malfunction due to customer fault - Malfunction & damage caused by user negligence (fall, shock, damage, unreasonable operation, etc) or careless use - Malfunction & damage occurred after a repair conducted by the consumer of the third person, not our A/S engineer. - Malfunction & damage due to used of unauthorized components, consumables, or separately sold parts 2) Other Cases - Malfunction due to natural disasters (fire, flood, earthquake, etc) - Expired life span of a consumable part - Malfunction due to external reasons		Paid Repair	Paid Repair	

- This warranty is only valid in the country where you purchased the product.