



**Electromagnetic Emission**  
**FCC MEASUREMENT REPORT**  
**CERTIFICATION OF COMPLIANCE**  
**FCC Part 15 Certification Measurement**

**PRODUCT** : Driving Recorder  
**MODEL/Serial No.** : DR550GW-2CH / Proto type  
**MULTIPLE MODEL** : -  
**FCC ID** : YCK-DR550GW-2CH  
**APPLICANT** : Pittasoft Co., Ltd.  
BYC HIGH CITY A-7th floor, 371-17 Gasan-Dong,  
Geumcheon-Gu, Seoul, 153-803, Korea  
Attn.: Doyun Kim / Team Manager  
**MANUFACTURER** : Pittasoft Co., Ltd.  
BYC HIGH CITY A-7th floor, 371-17 Gasan-Dong,  
Geumcheon-Gu, Seoul, 153-803, Korea  
**FCC CLASSIFICATION** : DTS (Part 15 Digital Transmission System)  
**TYPE OF MODULATION** : DSSS (CCK), OFDM (QAM)  
**FREQUENCY CHANNEL** : 802.11b/g/n(HT20): 2 412 MHz to 2 472 MHz and Channel Spacing 5 MHz (13 Ch)  
802.11n(HT40): 2 422 MHz to 2 462 MHz and Channel Spacing 5 MHz (9 Ch)  
**AIR DATE RATE** : 11 Mbps (802.11b), 54 Mbps (802.11g), 150 Mbps (802.11n)  
**ANTENNA TYPE** : Internal Antenna (Integral)  
**ANTENNA GAIN** : 3.10 dBi max  
**RF POWER** : 1.084 mW  
**RULE PART(S)** : FCC Part 15 Subpart C  
**FCC PROCEDURE** : ANSI C63.4-2003  
**TEST REPORT No.** : ETLE130624.0675  
**DATES OF TEST** : July 01, 2013 to July 04, 2013  
**REPORT ISSUE DATE** : July 26, 2013  
**TEST LABORATORY** : ETL Inc. (FCC Designation Number : KR0022)

The Driving Recorder, Model DR550GW-2CH has been tested in accordance with the measurement procedures specified in ANSI C63.4-2003 at the ETL Test Laboratory and has been shown to be complied with the electromagnetic radiated emission limits specified in FCC Rule Part15 Subpart C section 15.247. I attest to the accuracy of data. All measurement herein was performed by me or was made under my supervision and is correct to the best of my knowledge and belief. I assume full responsibility for the completeness of these measurements and vouch for the qualifications of all persons taking them. The results of testing in this report apply to the product/system which was tested only. Other similar equipment will not necessarily produce the same results due to production tolerance and measurement uncertainties.

Prepared by:   
Hoon Pyo, Lee (Test Engineer)  
July 26, 2013

Reviewed by:   
Kug Kyoung, Yoon (Chief Engineer)  
July 26, 2013

**ETL Inc.**  
**#371-51, Gasan-dong, Geumcheon-gu, Seoul, 153-803, Korea**  
**Tel: 82-2-858-0786 Fax: 82-2-858-0788**

*The test report merely corresponds to the test sample(s).  
This report shall not be reproduced, in whole or in part without the written approval of ETL Inc.*

## Table of Contents

### **FCC Measurement Report**

- 1. Introduction**
- 2. Product Information**
- 3. Description of Tests**
- 4. Test Condition**
- 5. Test Results**
  - 5.1 Summary of Test Results**
  - 5.2 6 dB Bandwidth**
  - 5.3 Maximum Peak Output Power**
  - 5.4 Bandwidth of Frequency Band Edges**
  - 5.5 Power Spectral Density**
  - 5.6 Spurious Emissions**
  - 5.7 Radio Frequency Exposure**
- 6. Sample Calculation**
- 7. List of test Equipment used for Measurement**

**Appendix A. FCC ID Label and Location**

**Appendix B. Test Setup Photographs**

**Appendix C. External Photographs**

**Appendix D. Internal Photographs**

**Appendix E. Block Diagram**

**Appendix F. Circuit Diagram**

**Appendix G. User Manual**

**Appendix H. Operational Description**

**Appendix I. Antenna Requirement**

**Appendix J. Radio Frequency Exposure**

## FCC MEASUREMENT REPORT

**Scope** – Measurement and determination of electromagnetic emission (EME) of radio frequency devices including intentional radiators and/or unintentional radiators for compliance with the technical rules and regulations of the U.S Federal Communications Commission(FCC)

### General Information

<b>Applicant Name</b>	<b>: Pittasoft Co., Ltd.</b>
<b>Address</b>	<b>: BYC HIGH CITY A-7th floor, 371-17 Gasan-Dong, Geumcheon-Gu, Seoul, 153-803, Korea</b>
<b>Attention</b>	<b>: Doyun Kim / Team Manager</b>

- **EUT Type** : Driving Recorder
- **Model Number** : DR550GW-2CH
- **S/N** : Proto type
- **Modulation Technique** : DSSS (CCK), OFDM (QAM)
- **Frequency Channel** : 802.11b/g/n(HT20) : 2 412 MHz to 2 472 MHz and Channel Spacing 5 MHz (13 Ch)  
802.11n(HT40): 2 422 MHz to 2 462 MHz and Channel Spacing 5 MHz (9 Ch)
- **Air Data Rate** : 11 Mbps (802.11b), 54 Mbps (802.11g), 150 Mbps (802.11n)
- **Antenna Type** : Internal Antenna (Integral)
- **Antenna Gain** : 3.10 dBi max
- **RF Power** : 1.084 mW
- **FCC Rule Part(s)** : FCC Part 15 Subpart C
- **Test Procedure** : ANSI C63.4-2003
- **FCC Classification** : DTS (Part 15 Digital Transmission System)
- **Place of Tests** : ETL Inc. Testing Lab.  
Radiated Emission test;  
#499-1, Sagot-ri, Seosin-myeon, Hwaseong-si, Gyeonggi-do,  
445-882, Korea  
  
Conducted Emission test;  
ETL Inc. Testing Lab.  
371-51, Gasan-dong, Geumcheon-gu, Seoul, 153-803, Korea

## **1. INTRODUCTION**

The measurement test for radiated and conducted emission test was conducted at the ETL Inc. The site is constructed in conformance with the requirements of the ANSI C63.4-2003 and CISPR Publication 16. The ETL has site descriptions on file with the FCC for 3 m and 10 m site configurations. Detailed description of test facility was found to be in compliance with FCC Rules according to the ANSI C63.4-2003 and registered to the Federal Communications Commission (FCC Designation Number : KR0022).

The measurement procedure described in American National Standard for Method of Measurement of Radio-Noise Emission from Low-Voltage Electrical and Electronic Equipment in the Range of 9 kHz to 40 GHz (ANSI C63.4-2003) was used in determining radiated and conducted emissions from the Pittasoft Co., Ltd. Model: DR550GW-2CH

## 2. PRODUCT INFORMATION

### 2.1 Equipment Description

The Equipment Under Test (EUT) is the Driving Recorder (model: DR550GW-2CH).

### 2.2 General Specification

Item	Specification
Color	Front: Pearl Black
	Rear: Pearl Black
Size	Front: 118.5 mm (Length) x 36.0 mm (Diameter)
	Rear: 67.4 mm (Length) x 27.6 mm (Diameter)
Weight	Front: 120 g
	Rear: 30 g
Memory	Micro SD Card (16 GB/32 GB)
Recording Mode	Normal Recording, Event Recording (Impact Detection) and Parking Mode Recording (Motion + Impact Detection) * For parking mode recording, a battery discharge prevention device is required.
Camera	Front: CMOS Sensor (Approx. 2.4 M Pixel)
	Rear: CMOS Sensor (Approx. 1 M Pixel)
Viewing Angle	Front: Opposite Angle 139°, Horizontal 116°, Vertical 61°
	Rear: Opposite Angle 139°, Horizontal 116°, Vertical 61°
Resolution / Frame	Front: Full HD (1 920 x 1 080) @ 30 fps, Full HD (1 920 x 1 080) @ 15 fps, HD (1 280 x 720) @ 30 fps, HD (1 280 x 720) @ 15 fps, D1 (720 x 480) @ 30 fps * Resolution / Frame can be changed
	Rear: HD (1 280 x 720) @ 30 fps, HD (1 280 x 720) @ 15 fps, HD (1 280 x 720) @ 30 fps, HD (1 280 x 720) @ 15 fps, HD (1 280 x 720) @ 30 fps * Resolution / Frame can be changed
Compression Mode	Video MP4
Wi-Fi	Built-in (802.11b/g/n (2.4 GHz – 2.483 5 GHz), Max 150 Mbps, OFDM/CCK/16-QAM/64-QAM)
GPS	Built-in
Microphone	Built-in

Item	Specification
Speaker	Built-in * Voice Directions
LED Indicators	Front: Recording LED, GPS LED, Wi-Fi LED, Front Security LED
	Rear: Rear Security LED
Sensor	3-Axis Acceleration Sensor
Button	Wi-Fi on/off Button * Self-format Function: Press it for 10 seconds to format the Micro SD Card
	Voice on/off Button * The proximity sensor is built-in so that voice recording can be turned on/off by approaching it with a hand * Touch the button or it recognizes when a hand approaches to within about 2 cm
Backup Battery	Built-in Super Capacitor
Input Power	DC 12 V – DC 24 V
Current Consumption	Approx. 4.8 W * Varies depending on Wi-Fi usage
Operation Temperature	(25 ± 45) °C
Software	BlackVue Viewer Program * Windows XP or later (Up to Windows 8), Mac Leopard OS X(10.5) or later)
Application	BlackVue App (Android 2.3 or later & iOS 5.0 or later)



## 3. DESCRIPTION OF TESTS

The tests documented in this report were performed in accordance with ANSI C63.4-2003 and FCC CFR 47 2.1046, 2.1047, 2.1049, 2.1051, 2.1053, 2.1055, 2.1057, 15.207, 15.209 and 15.247.

### 3.1 Radiated Emission Measurement

Radiated emission measurements were made in accordance with § 13 in ANSI C63.4-2003 "Measurement of Intentional radiators" The measurements were performed over the frequency range of 30 MHz to 40 GHz using antenna as the input transducer to a Spectrum analyzer or a Field Intensity Meter. The measurements were made with the detector set for "Peak, Quasi-peak, Average" within a bandwidth of 120 kHz and above 1 GHz is 1 MHz.

Preliminary measurements were made at 3 m using broadband antennas, and spectrum analyzer to determine the frequency producing the maximum emission in shielded room. Appropriate precaution was taken to ensure that all emission from the EUT were maximized and investigated. The system configuration, mode of operation, turntable azimuth and height with respect to the antenna were noted for each frequency found. The spectrum was scanned from 30 MHz to 1 000 MHz using Log-Bicon antenna. Above 1 GHz, linearly polarized double ridge horn antennas were used. Final measurements were made open site at 3 m. The test equipment was laced on a wooden turn-table. Sufficient time for the EUT, support equipment, and test equipment was allowed in order for them to warm up to their normal operating condition. Each frequency found during pre-scan measurements was re-examined by manual. The detector function was set to CISPR Quasi-peak mode and the bandwidth of the receiver was set to 120 kHz or 1 MHz depending on the frequency of type of signal. The EUT, support equipment and interconnecting cables were re-configured to the set-up producing the maximum emission for the frequency and were placed on top of a 0.8 m high nonmetallic 1.0 m x 1.5 m table. The EUT, support equipment, and interconnecting cables were re-arranged and manipulated to maximize each emission. The turntable containing the system was rotated; the antenna height was varied 1 m to 4 m and stopped at the azimuth or height producing the maximum emission.

Varying the mode of operating frequencies of the EUT maximized each emission. The system was tested in all the three orthogonal planes and changing the polarity of the antenna. The worst-case emissions are recorded in the data tables. If necessary, the radiated emission measurement could be performed at a closer distance to ensure higher accuracy and the results were extrapolated to the specified distance using an inverse linear distance extrapolation factor (20 dB/decade) as per section 15.31(f).

Photographs of the worst-case emission can be seen in Photographs of the worst-case emission test setup can be seen in Appendix B.

## 3.2 Conducted Emission Measurement

Conducted emissions measurements were made in accordance with section § 13 in ANSI C63.4-2003 "measurement of intentional radiators" The measurements were performed over the frequency range of 0.15 MHz to 30 MHz using a 50  $\Omega$ /50  $\mu$ H LISN as the input transducer to a Spectrum Analyzer or a Test Receiver. The measurements were made with the detector set for "Peak" amplitude within a bandwidth of 9 kHz or for "quasi-peak" within a bandwidth of 9 kHz.

The line-conducted emission test is conducted inside a shielded anechoic chamber room with 1 m x 1.5 m x 0.8 m wooden table which is placed 0.4 m away from the vertical wall and 1.5 m away from the side wall of the chamber room. Two LISN are bonded to the shielded room. The EUT is powered from the LISN and the support equipment is powered from the other LISN. Power to the LISNs are filtered by a noise cut power line filters. All electrical cables are shielded by braided tinned steel tubing with inner  $\phi$  1.2 cm. If the EUT is a DC-powered device, power will be derived from the source power supply it normally will be powered from and these supply lines will be connected to the LISN. Non-inductive bundling to a 1 m length shortened all interconnecting cables more than 1 m. Sufficient time for the EUT, support equipment, and test equipment was allowed in order for them to warm up to their normal operating condition. The RF output of the LISN was connected to the EMI Test Receiver to determine the frequency producing the maximum emission from the EUT. The frequency producing the maximum level was reexamined using to set Quasi-Peak mode by manual, after scanned by automatic Peak mode from 0.15 MHz to 30 MHz. The bandwidth of the spectrum analyzer was set to 9 kHz. The EUT, support equipment, and interconnecting cables were arranged and manipulated to maximize each emission.

Photographs of the worst-case emission can be seen in Photographs of the worst-case emission test setup can be seen in Appendix B.



### 3.3 FCC Part 15.205 Restricted Bands of Operations

(a) Except as shown in paragraph (d) of this section, only spurious emissions are permitted in any of the frequency bands listed below:

MHz	MHz	MHz	GHz
0.090 - 0.110	16.42 - 16.423	399.9 - 410	4.5 - 5.15
<sup>1</sup> 0.495 - 0.505	16.694 75 - 16.695 25	608 - 614	5.35 - 5.46
2.173 5 - 2.190 5	16.804 25 - 16.804 75	960 - 1 240	7.25 - 7.75
4.125 - 4.128	25.5 - 25.67	1 300 - 1 427	8.025 - 8.5
4.177 25 - 4.177 75	37.5 - 38.25	1 435 - 1 626.5	9.0 - 9.2
4.207 25 - 4.207 75	73 - 74.6	1 645.5 - 1 646.5	9.3 - 9.5
6.215 - 6.218	74.8 - 75.2	1 660 - 1 710	10.6 - 12.7
6.267 75 - 6.268 25	108 - 121.94	1 718.8 - 1 722.2	13.25 - 13.4
6.311 75 - 6.312 25	123 - 138	2 200 - 2 300	14.47 - 14.5
8.291 - 8.294	149.9 - 150.05	2 310 - 2 390	15.35 - 16.2
8.362 - 8.366	156.524 75 - 156.525 25	2 483.5 - 2 500	17.7 - 21.4
8.376 25 - 8.386 75	156.7 - 156.9	2 690 - 2 900	22.01 - 23.12
8.414 25 - 8.414 75	162.012 5 - 167.17	3 260 - 3 267	23.6 - 24.0
12.29 - 12.293	167.72 - 173.2	3 332 - 3 339	31.2 - 31.8
12.519 75 - 12.520 25	240 - 285	3 345.8 - 3 358	36.43 - 36.5
12.576 75 - 12.577 25	322 - 335.4	3 600 - 4 400	( <sup>2</sup> )
13.36 - 13.41			

<sup>1</sup> Until February 1, 1999, this restricted band shall be 0.490 MHz - 0.510 MHz.

<sup>2</sup> Above 38.6

(b) Except as provided in paragraphs (d) and (e), the field strength of emissions appearing within these frequency bands shall not exceed the limits shown in Section 15.209. At frequencies equal to or less than 1 000 MHz, compliance with the limits in Section 15.209 shall be demonstrated using measurement instrumentation employing a CISPR quasi-peak detector. Above 1 000 MHz, compliance with the emission limits in Section 15.209 shall be demonstrated based on the average value of the measured emissions. The provisions in Section 15.35 apply to these measurements.

## 4. TEST CONDITION

### 4.1 Test Configuration

The device was configured for testing in a typical fashion (as a customer would normally use it). During the tests, the following conditions and configurations were used.

### 4.2 Description of Test modes

Driving Recorder that has the control software.

### 4.3 The setup drawing(s)

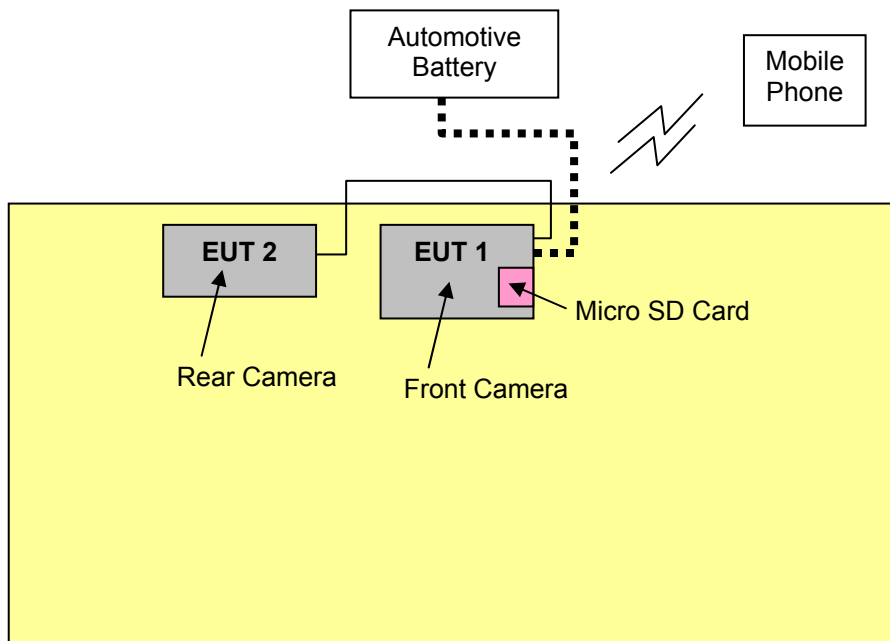

- : Signal line
- : AC Power line
- ..... : DC Power line (Cigar Jack)
- : Adapter

## 5. TEST RESULTS

### 5.1 Summary of Test Results

The measurement results were obtained with the EUT tested in the conditions described in this report. Detailed measurement data and plots showing the maximum emission of the EUT are reported.

47 CFR Part 15, Subpart C	Measurement Required	Result
15.247(a)(2)	6 dB Bandwidth	Pass
15.247(b)(3)	Maximum Peak Output Power	Pass
15.247(d)	Bandwidth of Frequency Band Edges	Pass
15.247(e)	Power Spectral Density	Pass
15.209(a)	Spurious Emissions	Pass
15.207	Conducted Emissions	N/A *
1.1307(b)(1)	RF Exposure	Pass

**\* This test was not applied. Because, EUT power supplies from an automotive battery. (DC 12 V – DC 24 V)**

The data collected shows that the **Pittasoft Co., Ltd. / Driving Recorder / DR550GW-2CH** complied with technical requirements of above rules part 15.207, 209 and 15.247 Limits.

The equipment is not modified anything, mechanical or circuits to improve EMI status during a measurement. No EMI suppression device(s) was added and/or modified during testing.

## 5.2 6 dB Bandwidth

EUT	Driving Recorder / DR550GW-2CH
Limit apply to	FCC Part 15.247(a)(2)
Test Date	July 01, 2013
Operating Condition	RF transmitting continuously during the tested.
Result	Passed

### Limit

The maximum 6 dB bandwidth shall be at least 500 kHz.

### Test Data

Mode	Frequency [MHz]	6 dB Bandwidth [MHz]	Limit
802.11b	2 412	10.10	> 500 kHz
	2 442	10.10	
	2 472	10.13	
802.11g	2 412	16.57	
	2 442	16.57	
	2 472	16.57	
802.11n(HT20)	2 412	17.80	
	2 442	17.83	
	2 472	17.80	
802.11n(HT40)	2 422	36.50	
	2 442	36.50	
	2 462	36.50	

### NOTES:

1. This test was applied both to DC 12 V and DC 24 V. (Worst case: DC 24 V)
2. Measure frequency separation of relevant channel using spectrum analyzer.
3. RBW 300 kHz, VBW 1 MHz, Sweep time Auto.
4. Please see the measured plot in next page.

## Plots of 6 dB Bandwidth (802.11b)

[2 412 MHz]

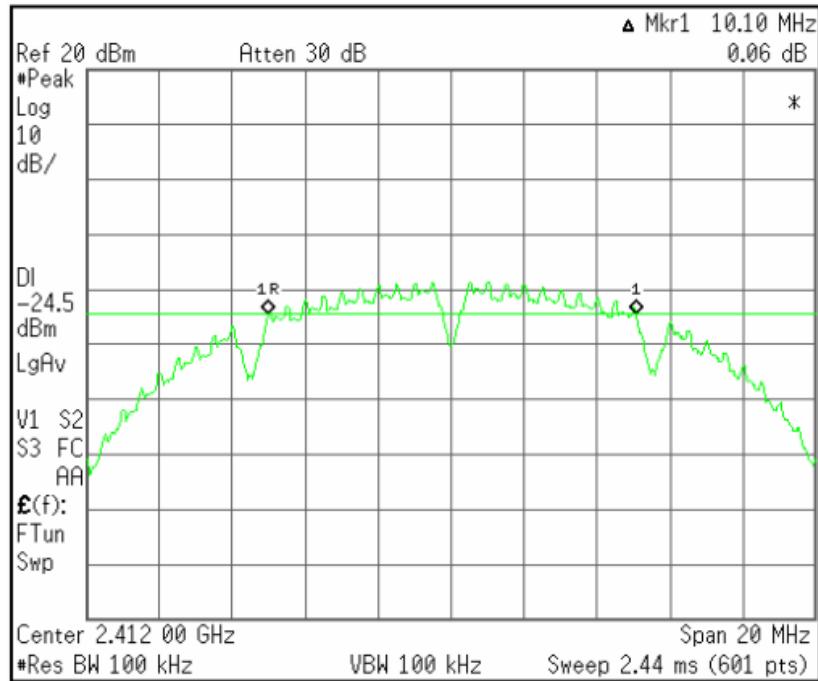

[2 442 MHz]

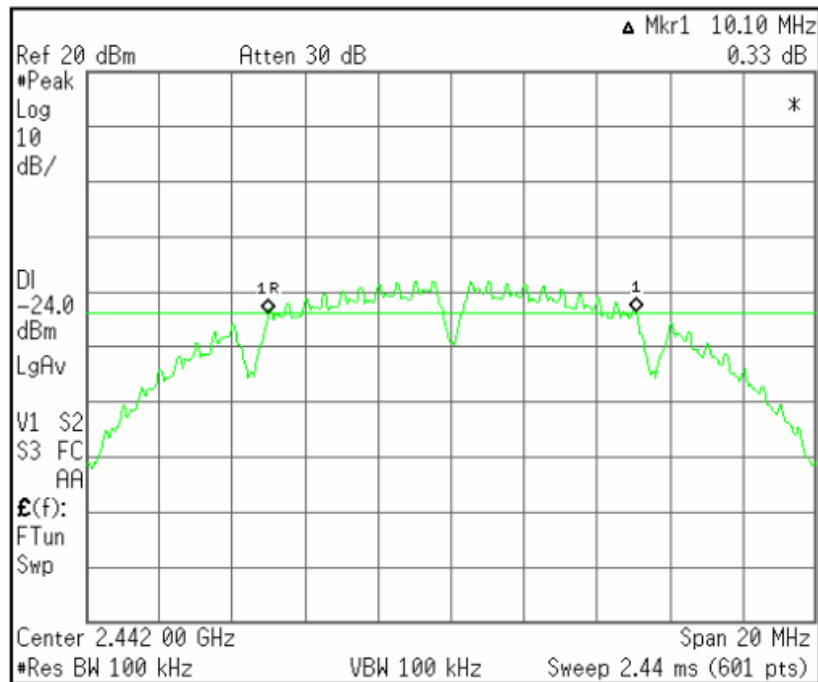

[2 472 MHz]

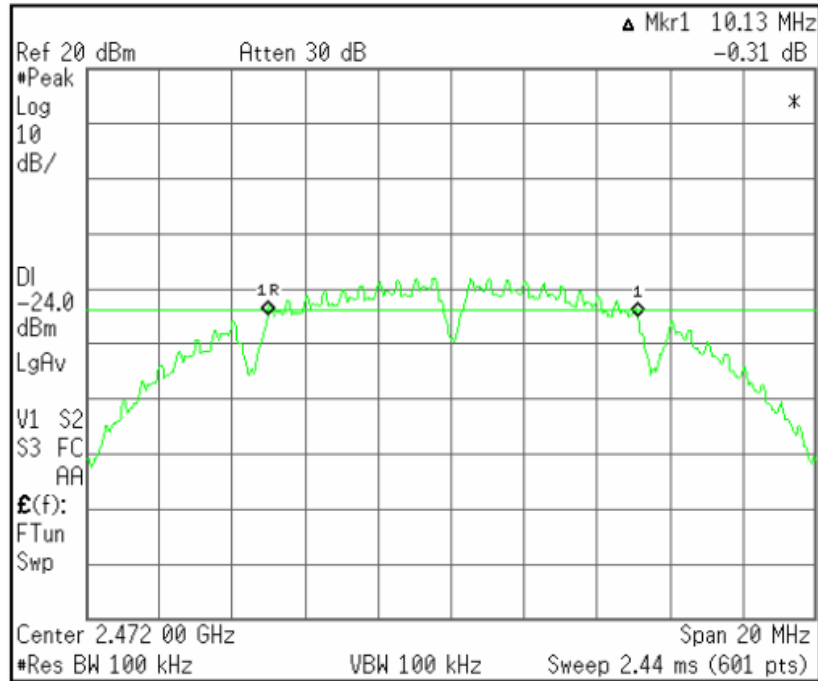

### Plots of 6 dB Bandwidth (802.11g)

[2 412 MHz]

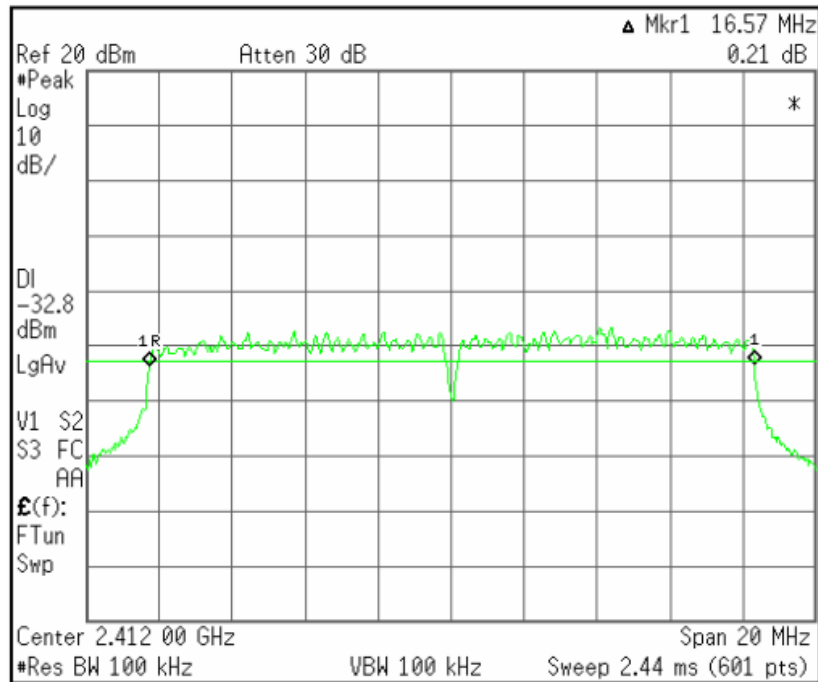



[2 442 MHz]

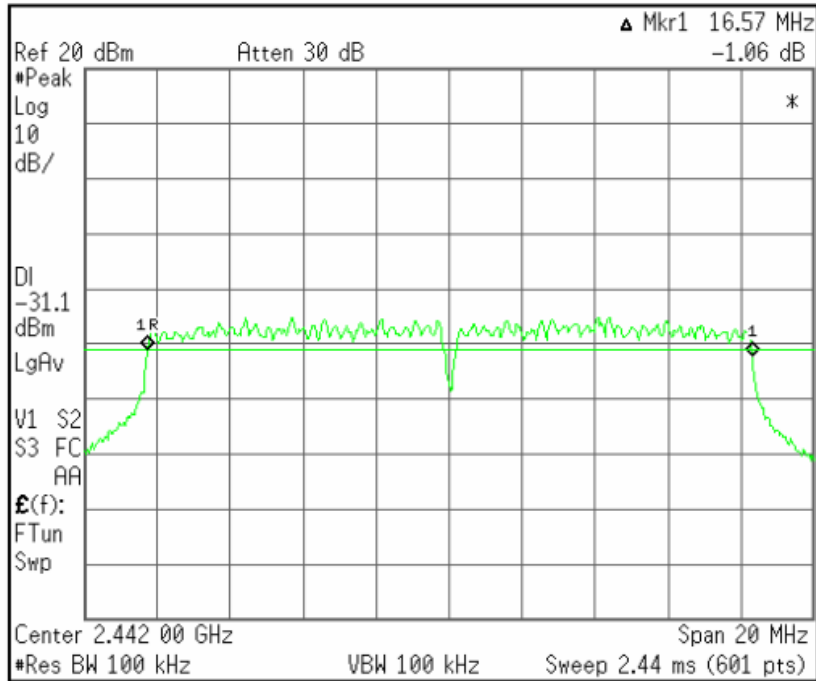

[2 472 MHz]

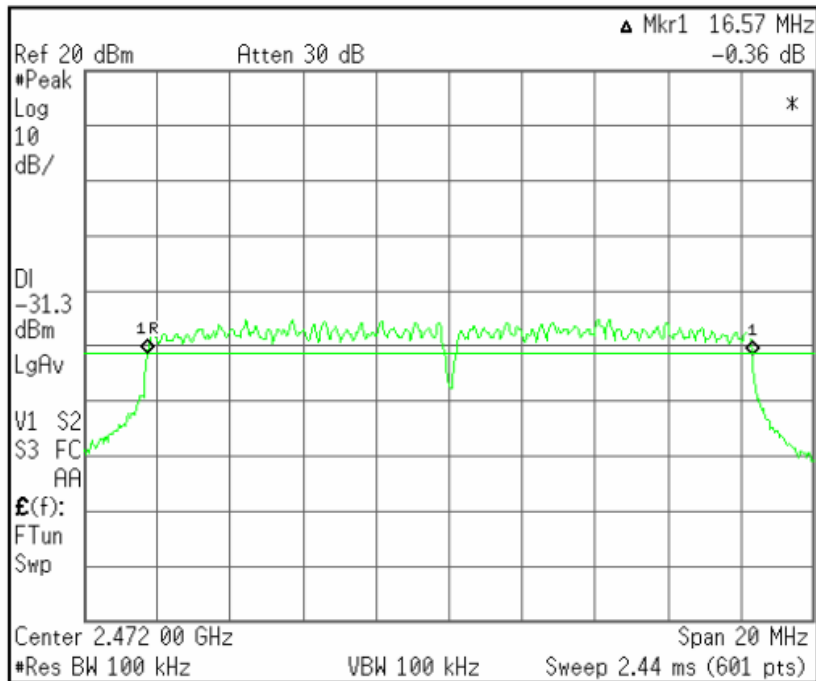

## Plots of 6 dB Bandwidth (802.11n(HT20))

[2 412 MHz]

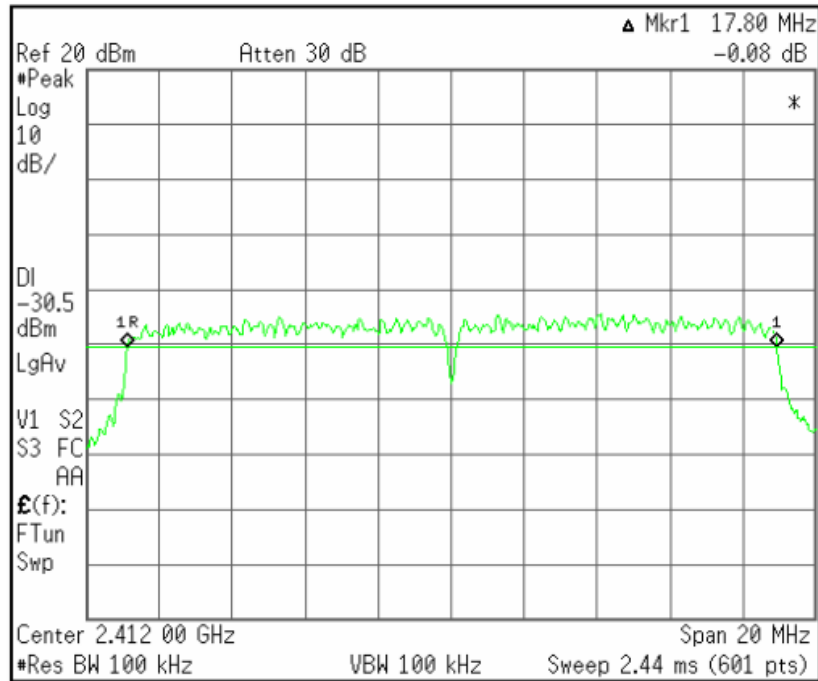

[2 442 MHz]

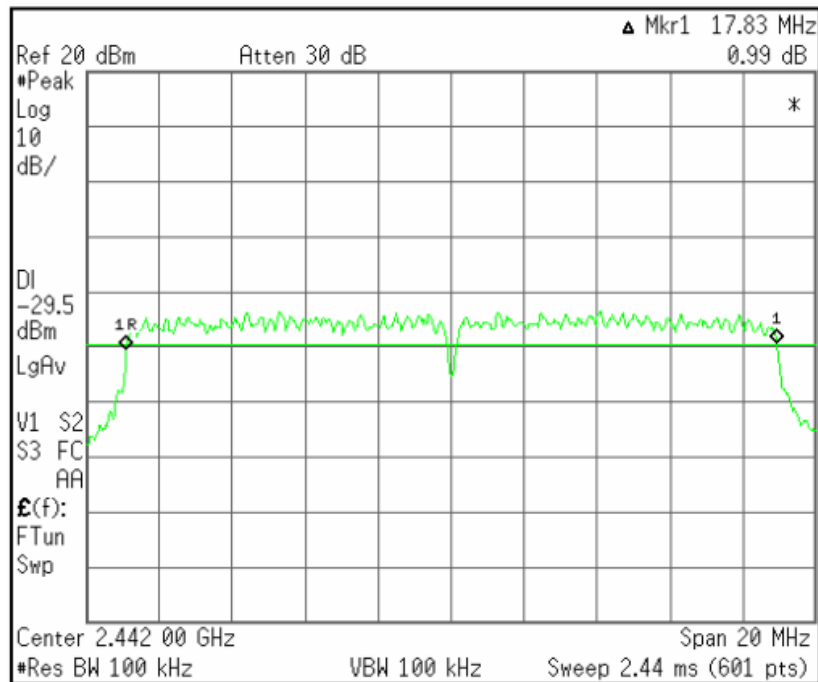

[2 472 MHz]

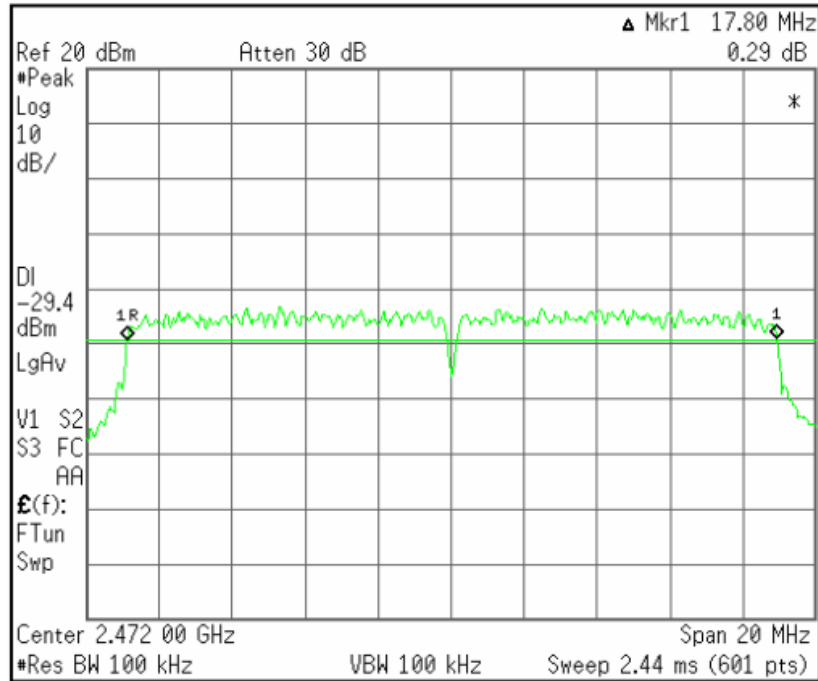

### Plots of 6 dB Bandwidth (802.11n(HT40))

[2 422 MHz]

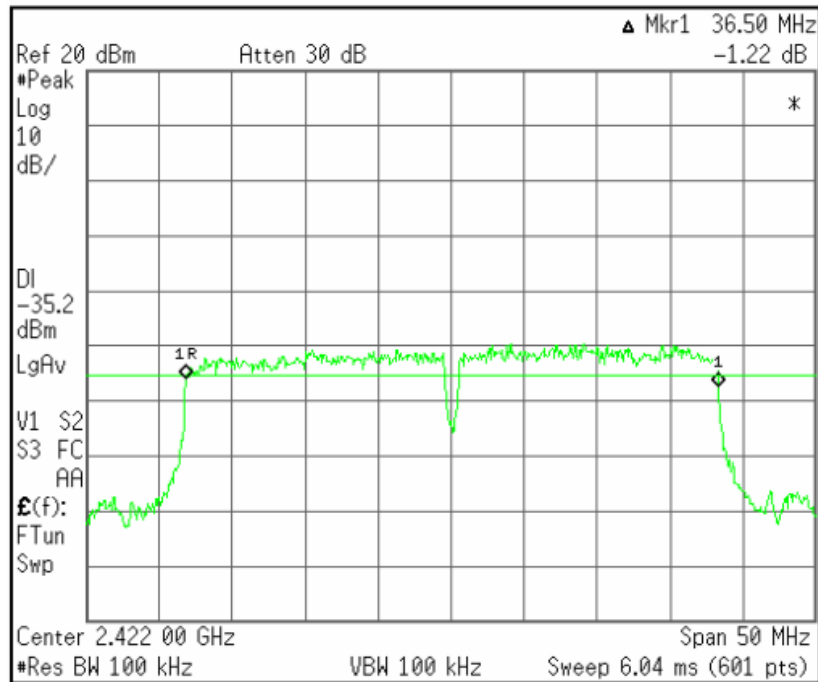

[2 442 MHz]

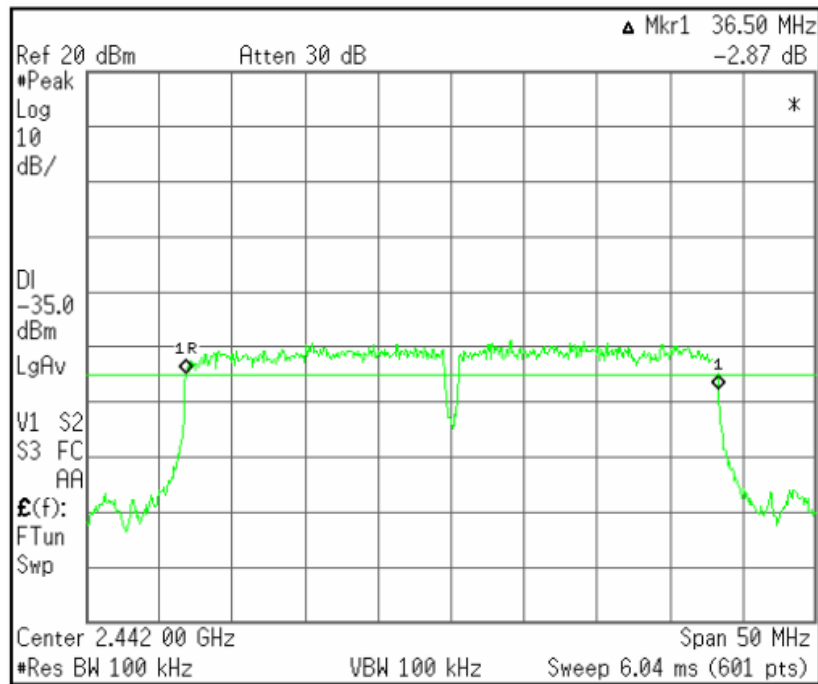

[2 462 MHz]

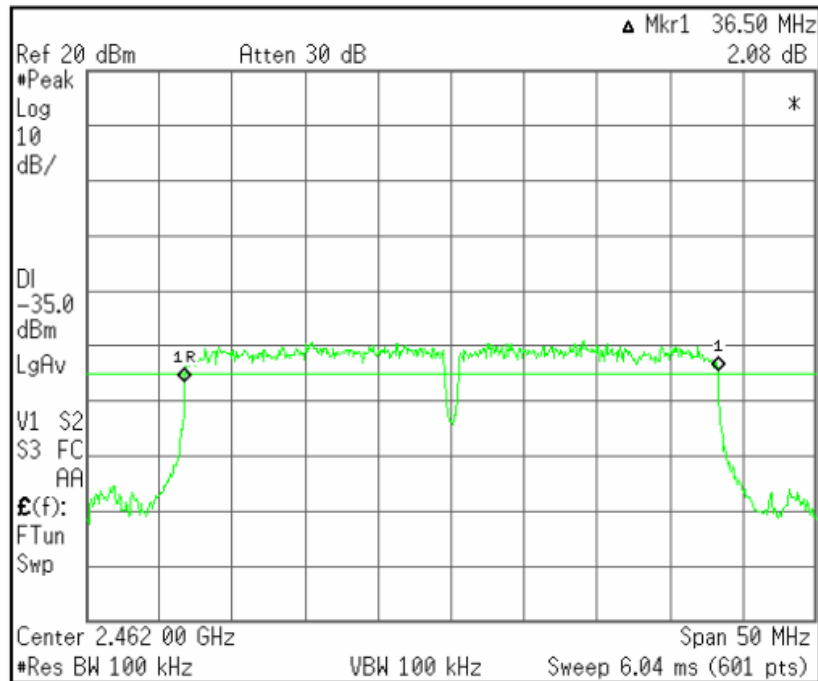

## 5.3 Maximum Peak Conducted Output Power

EUT	Driving Recorder / DR550GW-2CH
Limit apply to	FCC Part 15.247(b)(3)
Test Date	July 01, 2013
Operating Condition	RF transmitting continuously during the tested.
Result	Passed

### Limit

The maximum peak conducted output power of the intentional radiator shall not exceed the following:

For frequency hopping systems operating in the 2 400.0 MHz - 2 483.5 MHz band: 1 Watt

### Test Data

Mode	Frequency [MHz]	Output Power [dBm]	Limit
802.11b	2 412	-2.74	< 30.00 dBm (1 W)
	2 442	0.98	
	2 472	0.35	
802.11g	2 412	-5.67	
	2 442	-3.80	
	2 472	-2.93	
802.11n(HT20)	2 412	-4.41	
	2 442	-3.87	
	2 472	-3.32	
802.11n(HT40)	2 422	-5.47	
	2 442	-3.32	
	2 462	-3.65	

### NOTES:

1. This test was applied both to DC 12 V and DC 24 V. (Worst case: DC 24 V)
2. Measure conducted Channel power of relevant channel using spectrum analyzer.
3. RBW 1 MHz, VBW 8 MHz
4. Please see the measured plot in next page.

## Plots of Maximum Peak Output Power Bandwidth (802.11b)

[2 412 MHz]

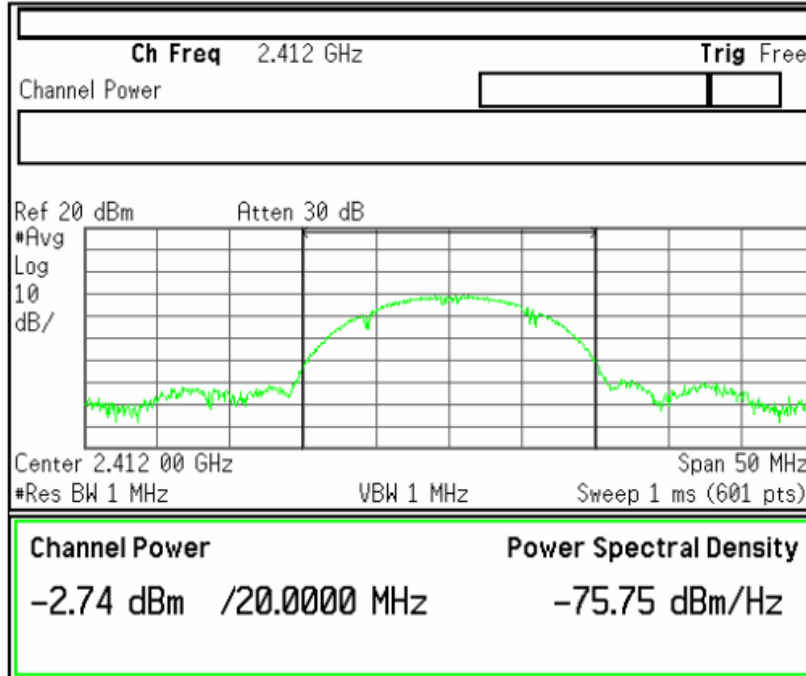

[2 442 MHz]

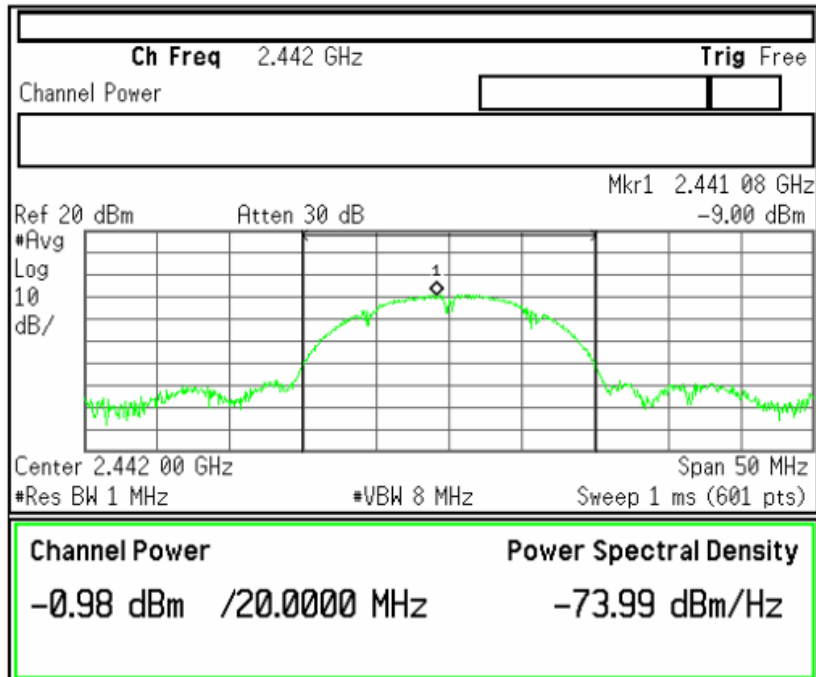



[2 472 MHz]

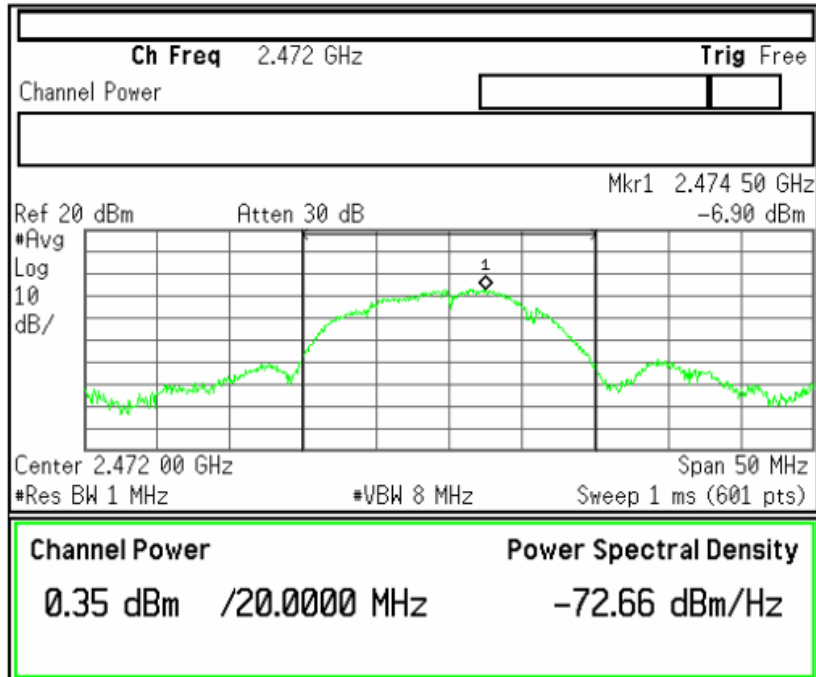

### Plots of Maximum Peak Output Power Bandwidth (802.11g)

[2 412 MHz]

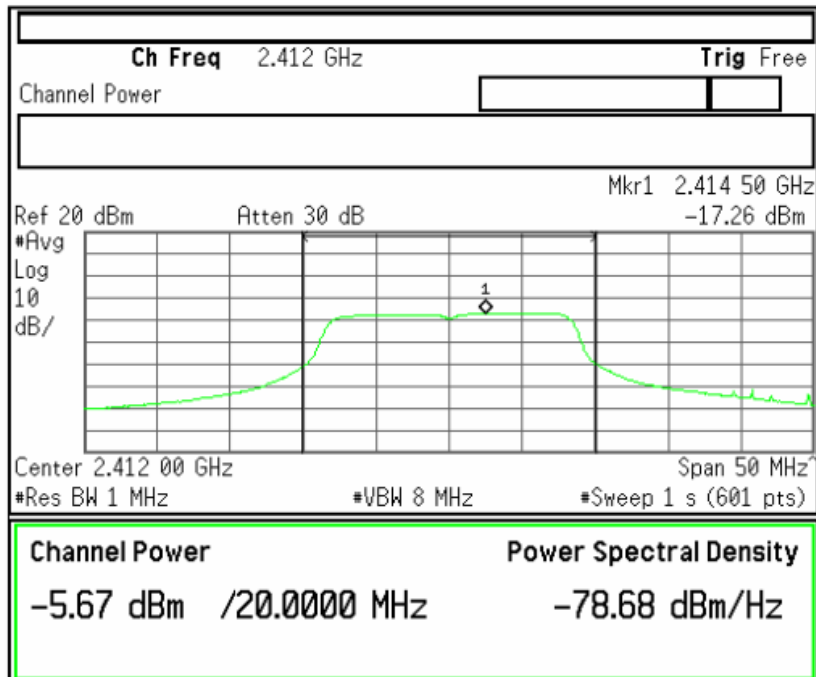

[2 442 MHz]

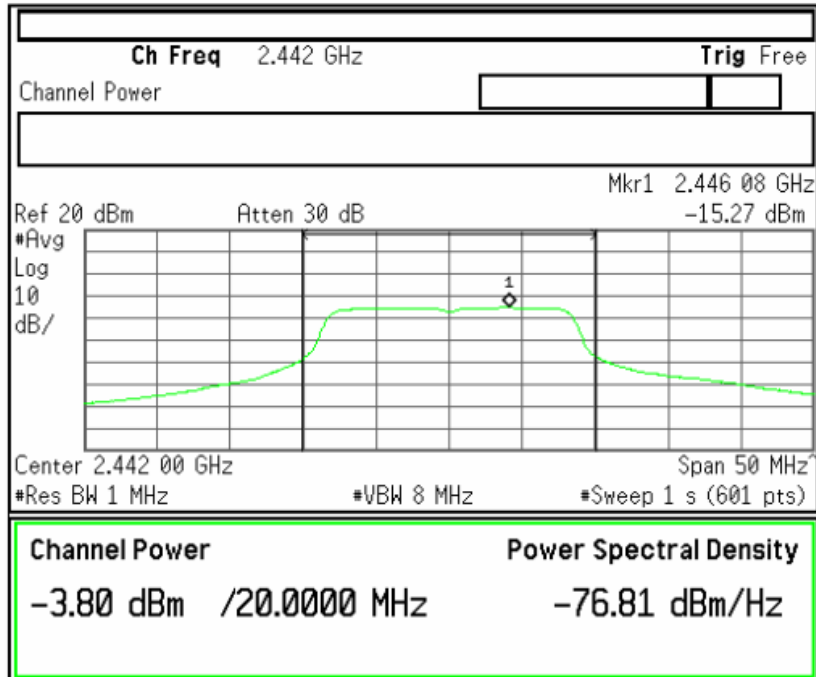

[2 472 MHz]

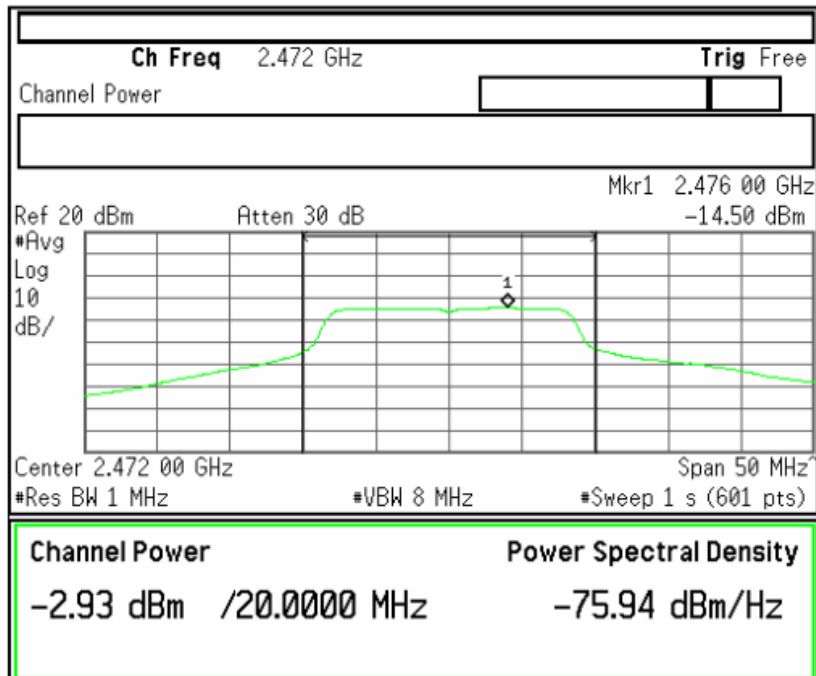

## Plots of Maximum Peak Output Power Bandwidth (802.11n(HT20))

[2 412 MHz]

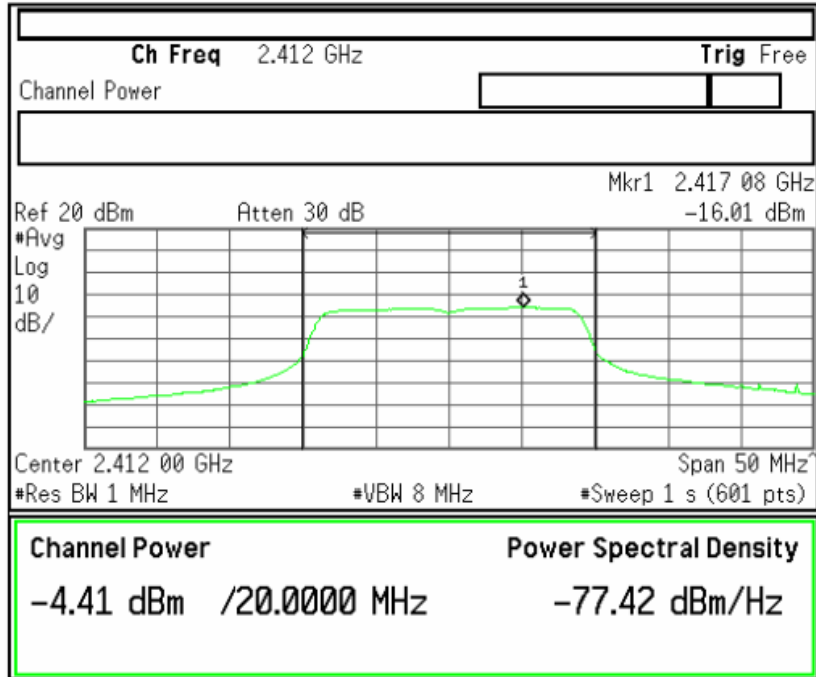

[2 442 MHz]

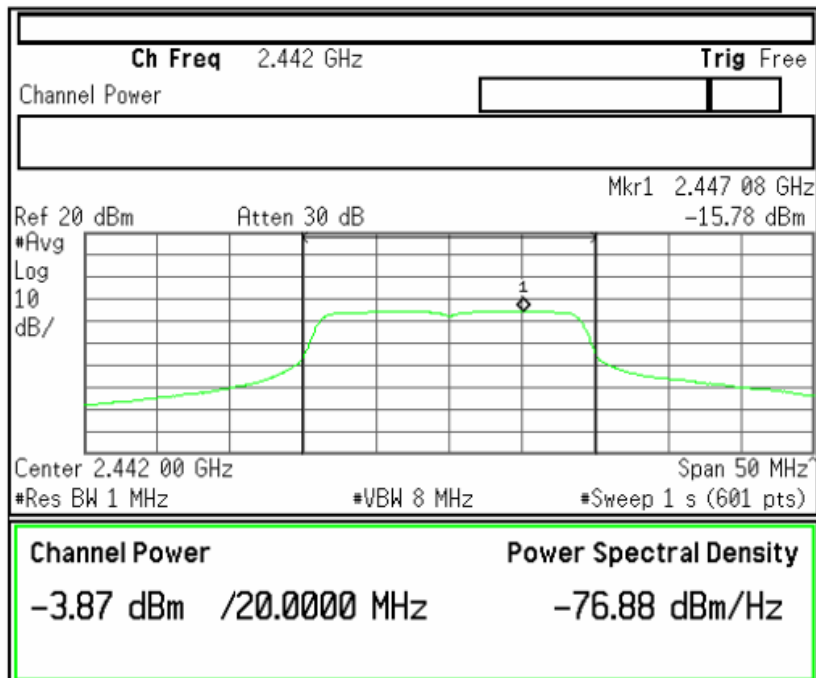

[2 472 MHz]

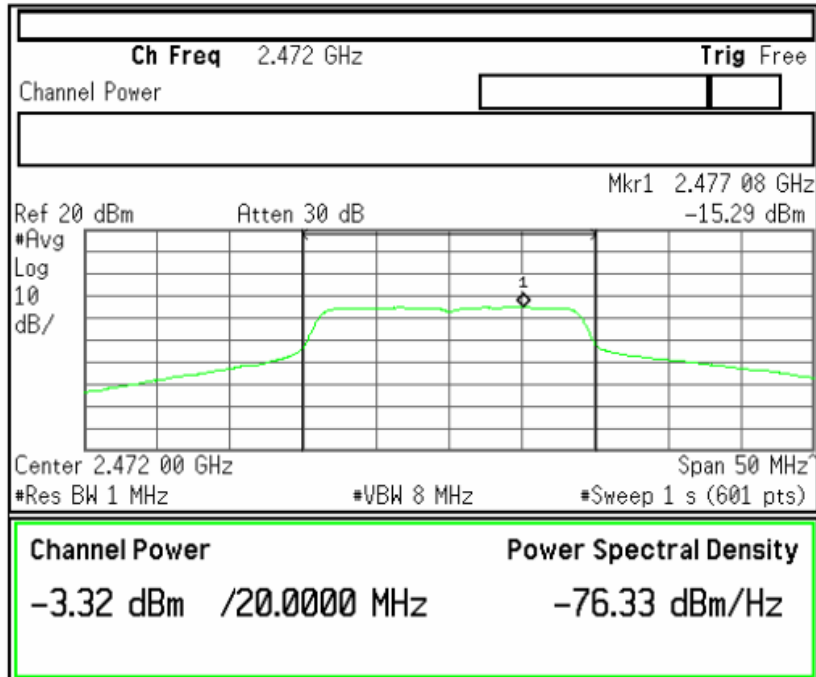

### Plots of Maximum Peak Output Power Bandwidth (802.11n(HT40))

[2 422 MHz]

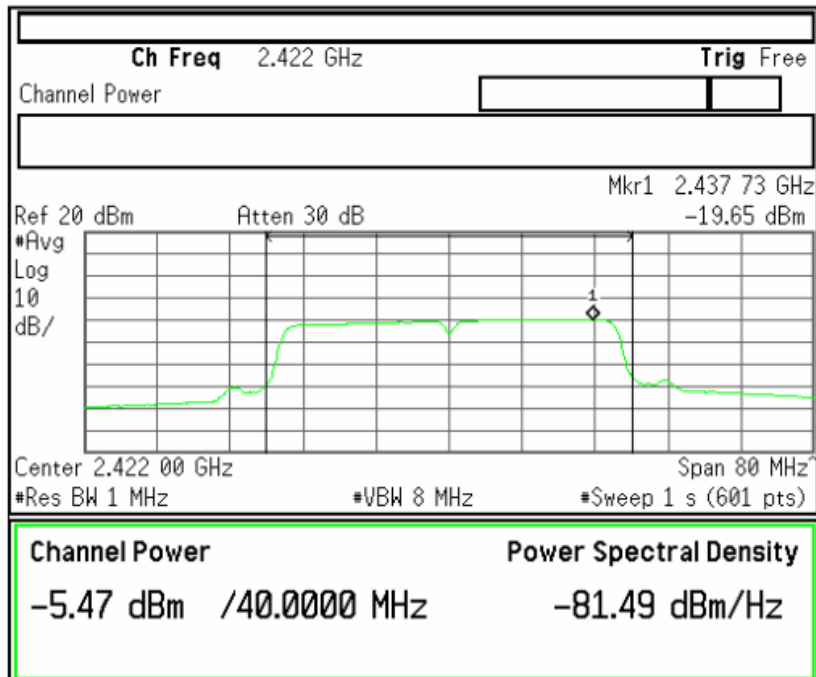

[2 442 MHz]

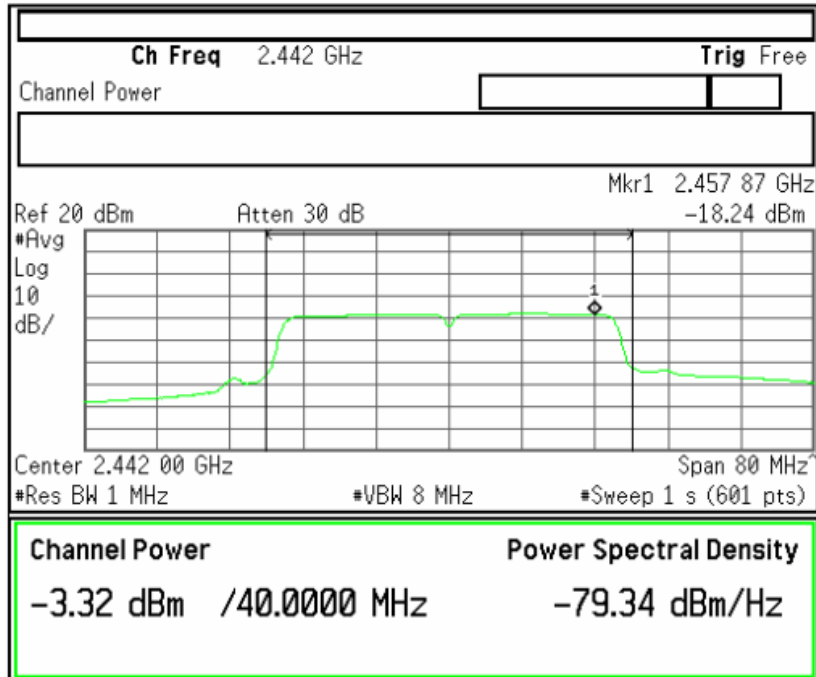

[2 462 MHz]

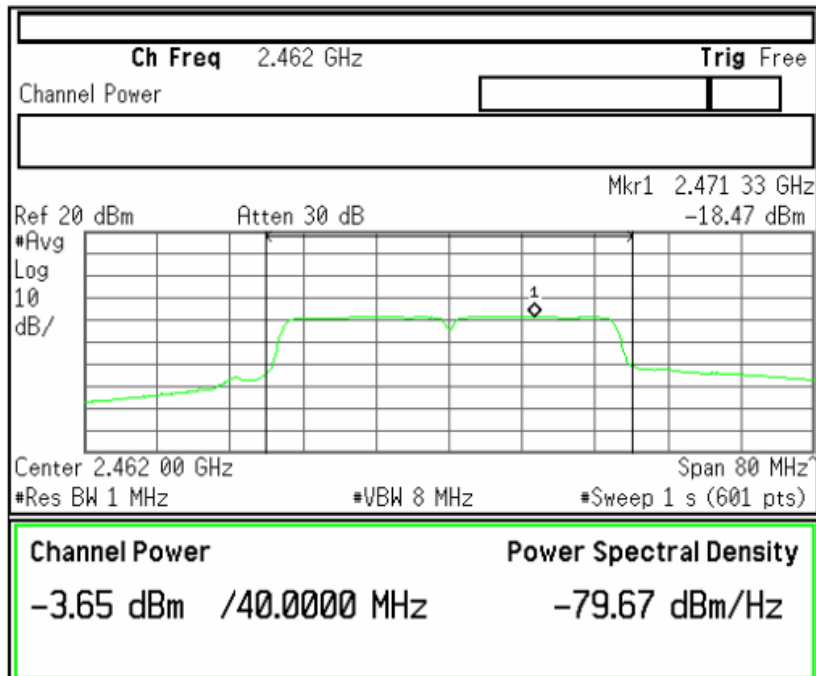

## 5.4 Bandwidth of Frequency Band Edges

EUT	Driving Recorder / DR550GW-2CH
Limit apply to	FCC Part 15.247(d)
Test Date	July 02, 2013
Operating Condition	RF transmitting continuously during the tested.
Result	Passed

### Limit

In any 100 kHz bandwidth outside the frequency band in which the spread spectrum or digitally modulated intentional radiator is operating, the radio frequency power that is produced by the intentional radiator shall be at least 20 dB below that in the 100 kHz bandwidth within the band that contains the highest level of the desired power, based on either an RF conducted or a radiated measurement, provided the transmitter demonstrates compliance with the peak conducted power limits. If the transmitter complies with the conducted power limits based on the use of RMS averaging over a time interval, as permitted under paragraph (b)(3) of this section, the attenuation required under this paragraph shall be 30 dB instead of 20 dB. Attenuation below the general limits specified in Section 15.209(a) is not required. In addition, radiated emissions which fall in the restricted bands, as defined in Section 15.205(a), must also comply with the radiated emission limits specified in Section 15.209(a) (see Section 15.205(c)).

### Test Results

- Refer to see the measured plot in next page.

### NOTES:

1. This test was applied both to DC 12 V and DC 24 V. (Worst case: DC 24 V)
2. The test was performed to make a direct field strength measurement at the band edge frequencies.



## Plots of Bandwidth of Frequency Band Edges (802.11b)

Conducted

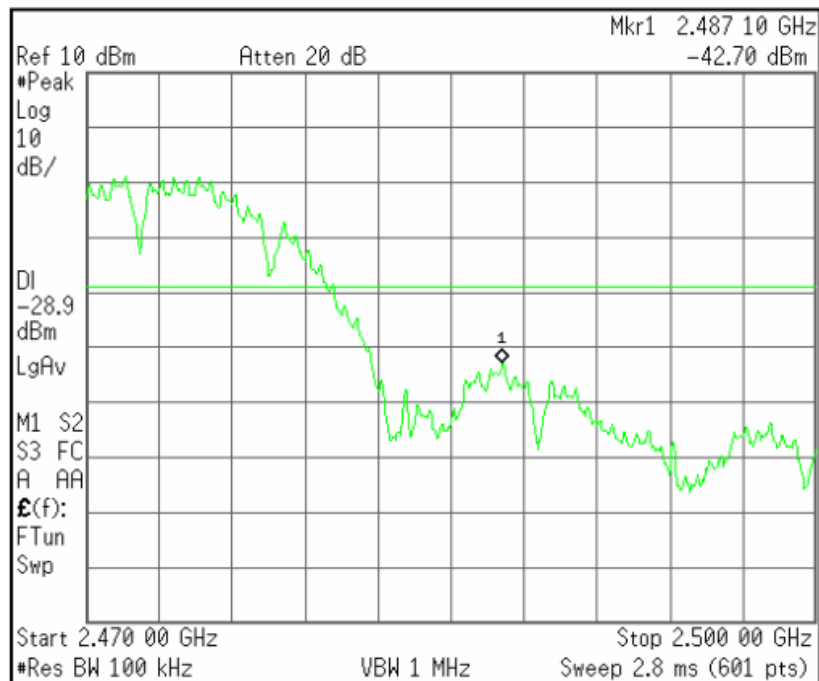
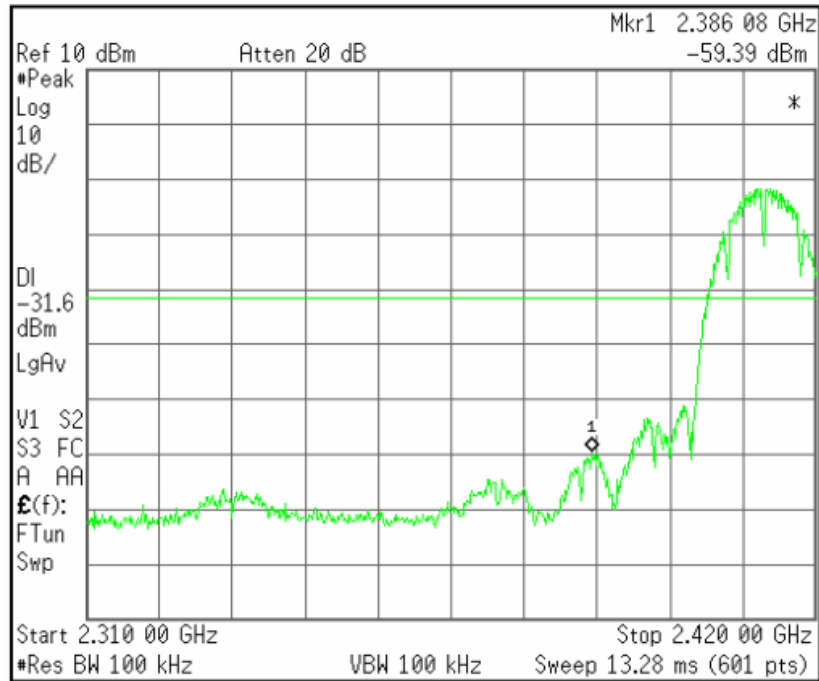

## Radiated

Peak Detector: RBW: 1 MHz, VBW: 1 MHz (2 310 MHz - 2 390 MHz), Worst case (Low, Horizontal)

— Peak Limit Line  
 — AV Limit Line

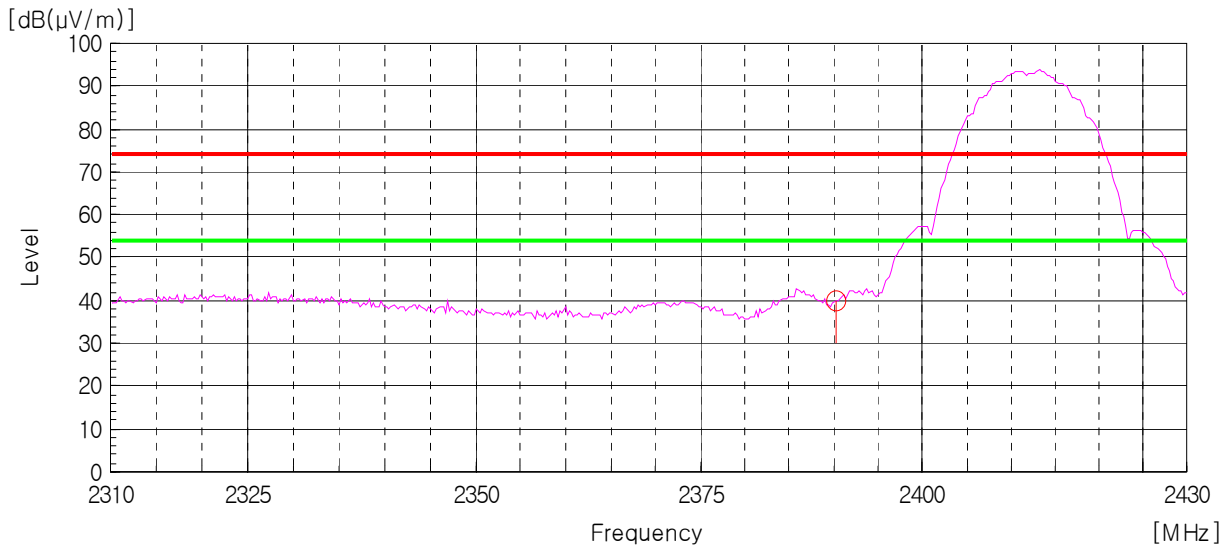

AV Detector: RBW: 1 MHz, VBW: 10 Hz (2 310 MHz - 2 390 MHz), Worst case (Low, Horizontal)

— Peak Limit Line  
 — AV Limit Line

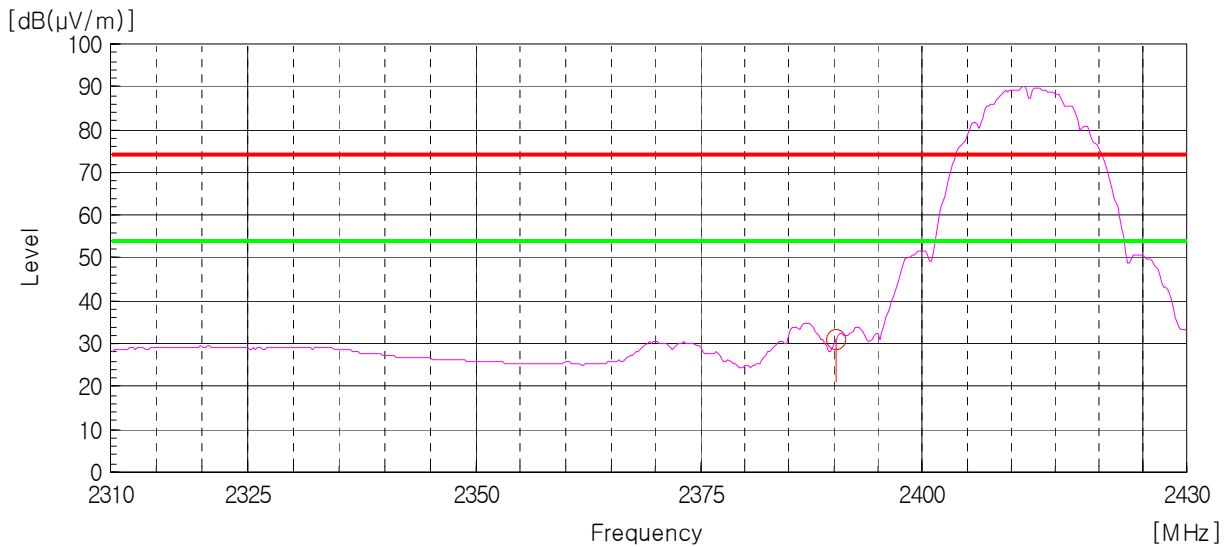

Peak Detector: RBW: 1 MHz, VBW: 1 MHz (2 483.5 MHz - 2 500 MHz), Worst case (High, Horizontal)

— Peak Limit Line  
 — AV Limit Line

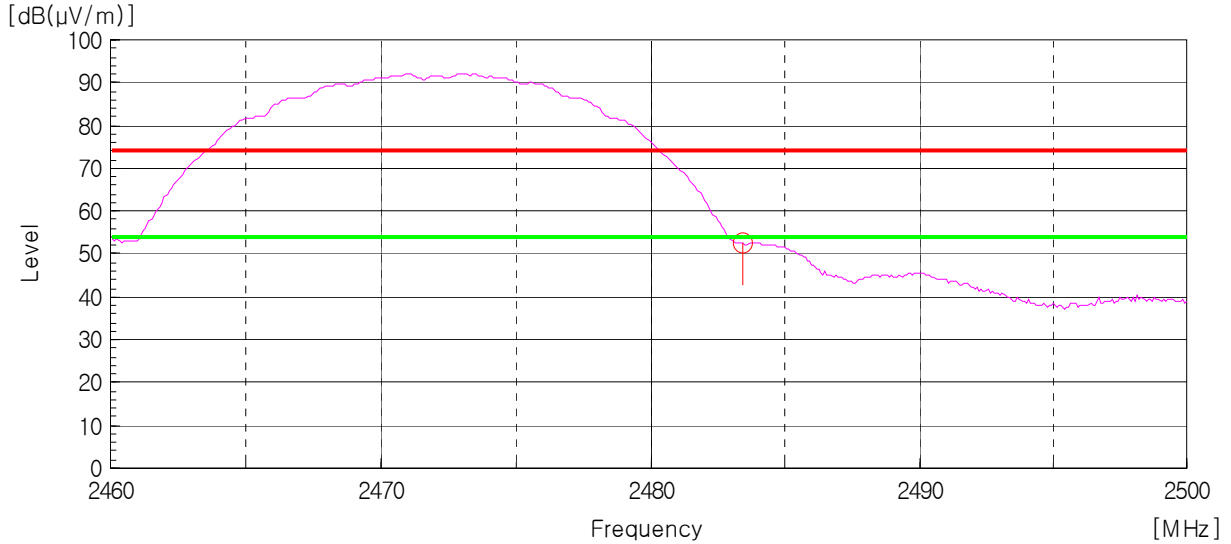

AV Detector: RBW: 1 MHz, VBW: 10 Hz ((2 483.5 MHz - 2 500 MHz), Worst case (High, Horizontal)

— Peak Limit Line  
 — AV Limit Line

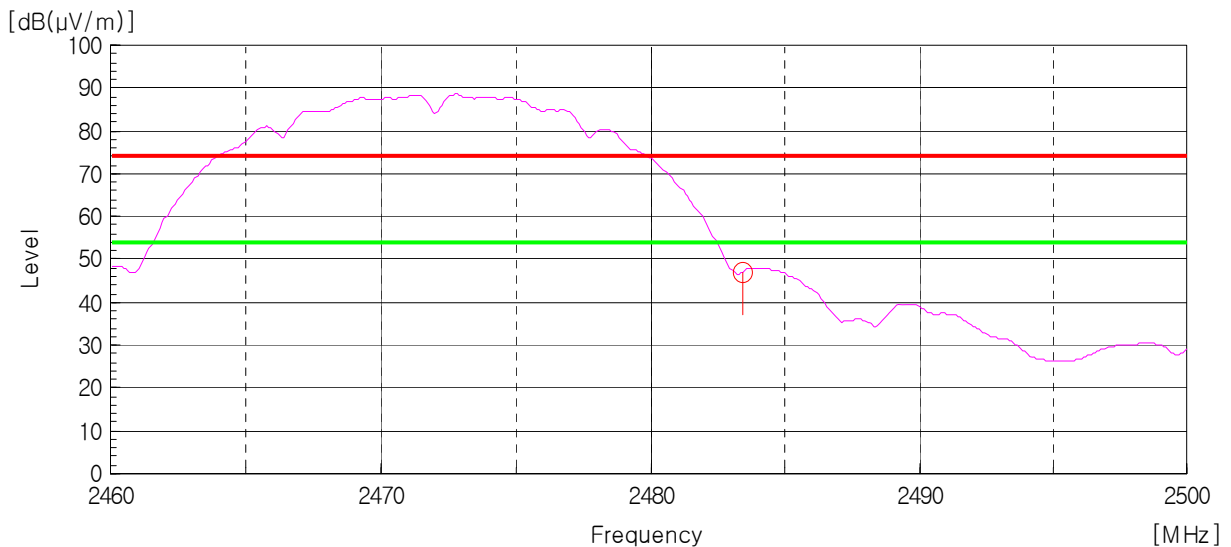

## Plots of Bandwidth of Frequency Band Edges (802.11g)

Conducted

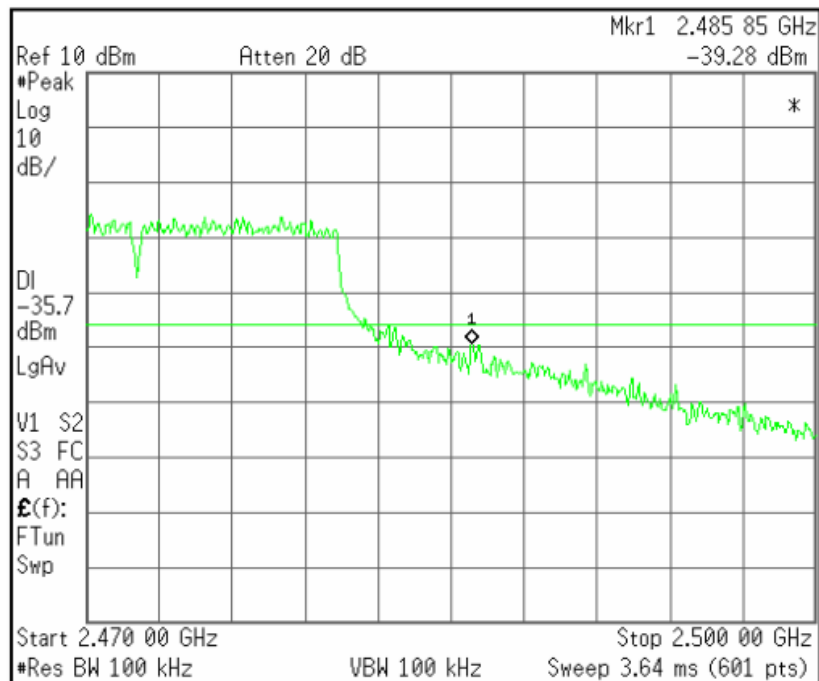
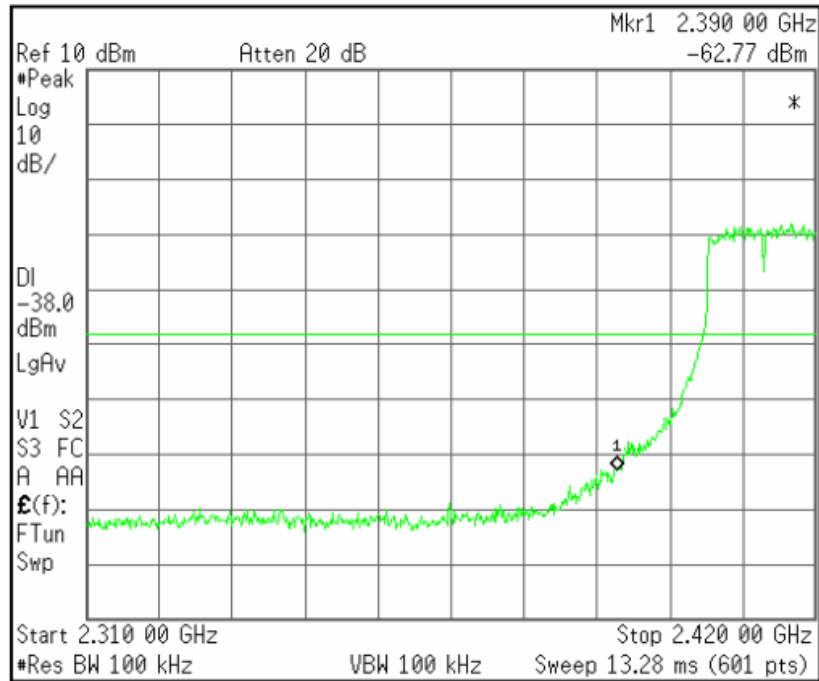

## Radiated

Peak Detector: RBW: 1 MHz, VBW: 1 MHz (2 310 MHz - 2 390 MHz), Worst case (Low, Horizontal)

— Peak Limit Line  
— AV Limit Line

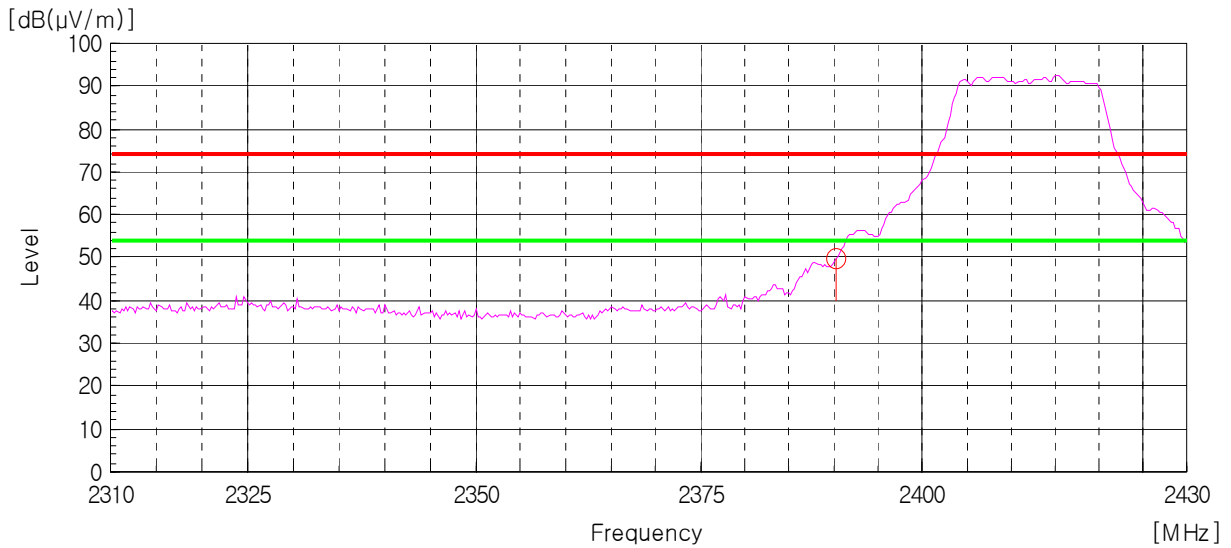

AV Detector: RBW: 1 MHz, VBW: 10 Hz (2 310 MHz - 2 390 MHz), Worst case (Low, Horizontal)

— Peak Limit Line  
— AV Limit Line

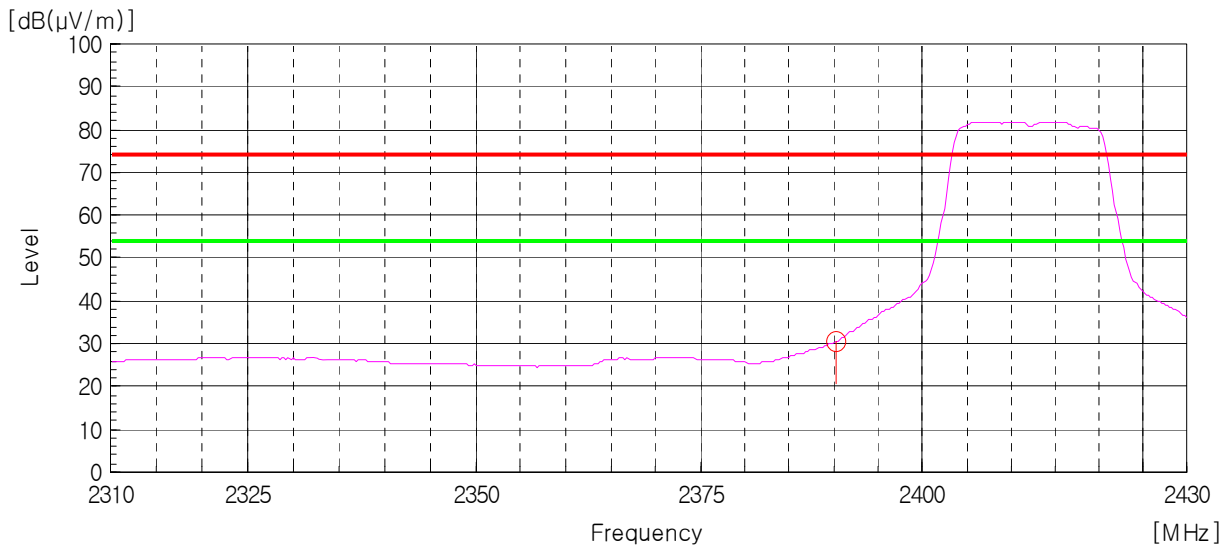

Peak Detector: RBW: 1 MHz, VBW: 1 MHz (2 483.5 MHz - 2 500 MHz), Worst case (High, Horizontal)

— Peak Limit Line  
— AV Limit Line

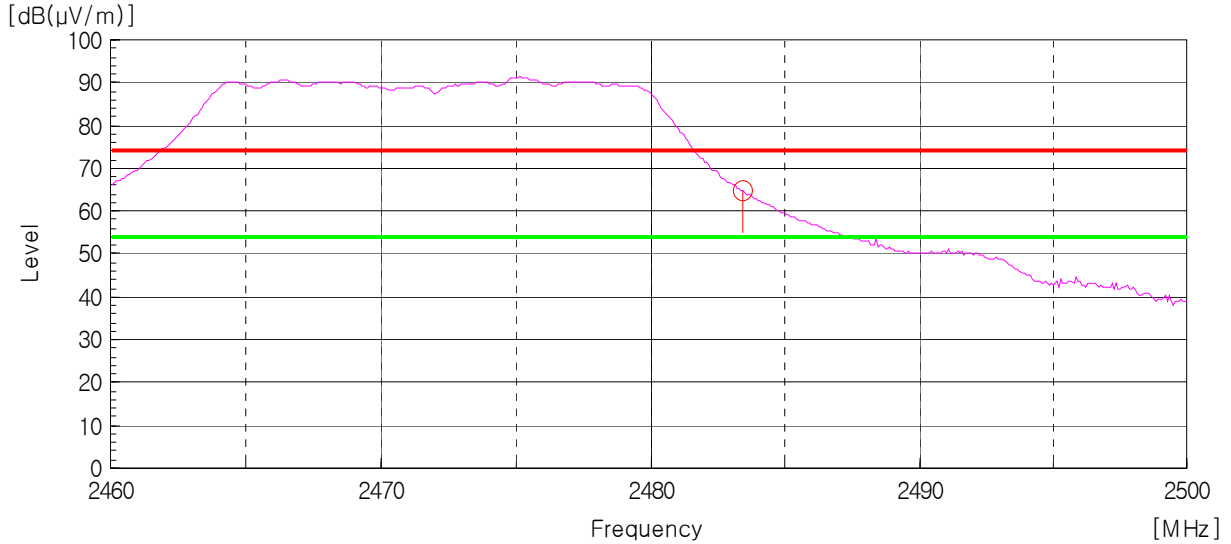

AV Detector: RBW: 1 MHz, VBW: 10 Hz ((2 483.5 MHz - 2 500 MHz), Worst case (High, Horizontal)

— Peak Limit Line  
— AV Limit Line

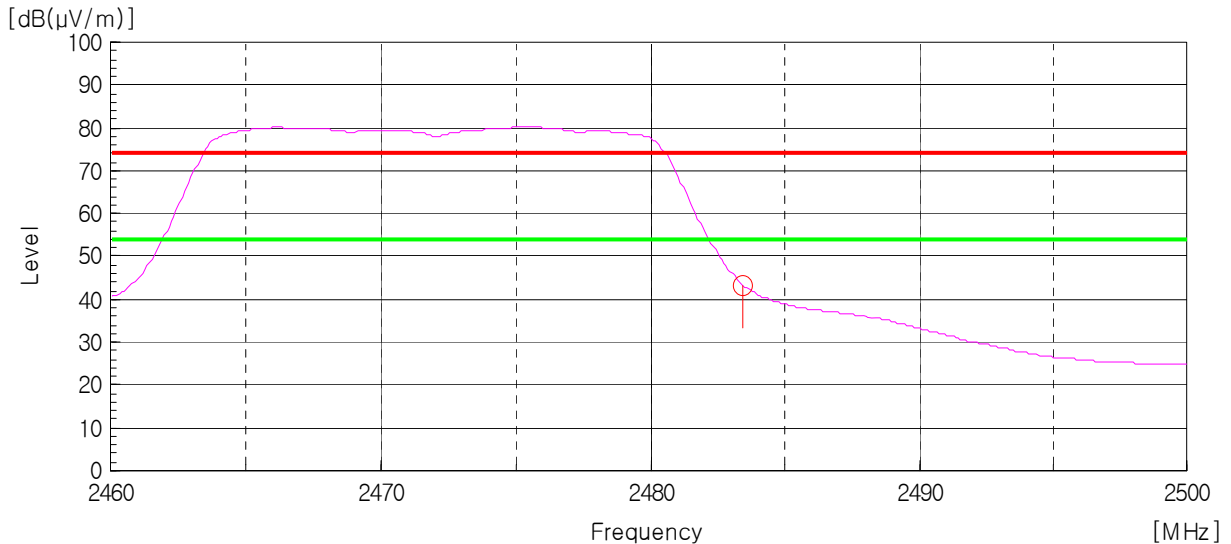

## Plots of Bandwidth of Frequency Band Edges (802.11n(HT20))

Conducted

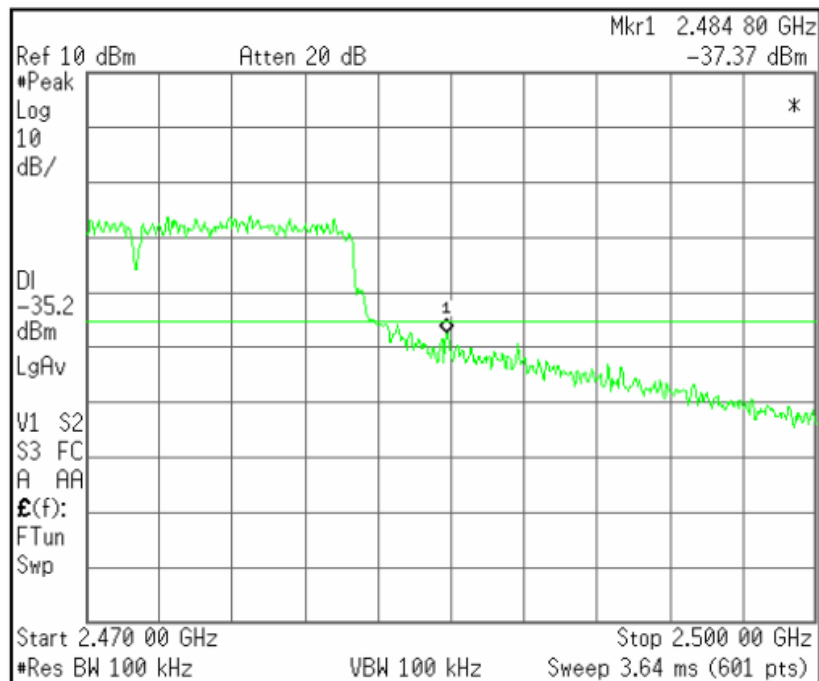
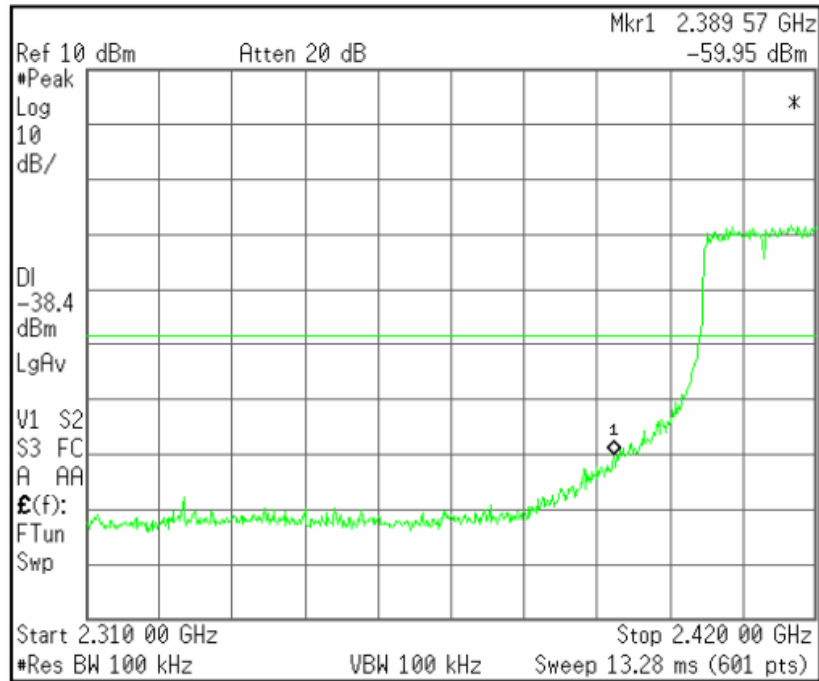

## Radiated

Peak Detector: RBW: 1 MHz, VBW: 1 MHz (2 310 MHz - 2 390 MHz), Worst case (Low, Horizontal)

— Peak Limit Line  
 — AV Limit Line

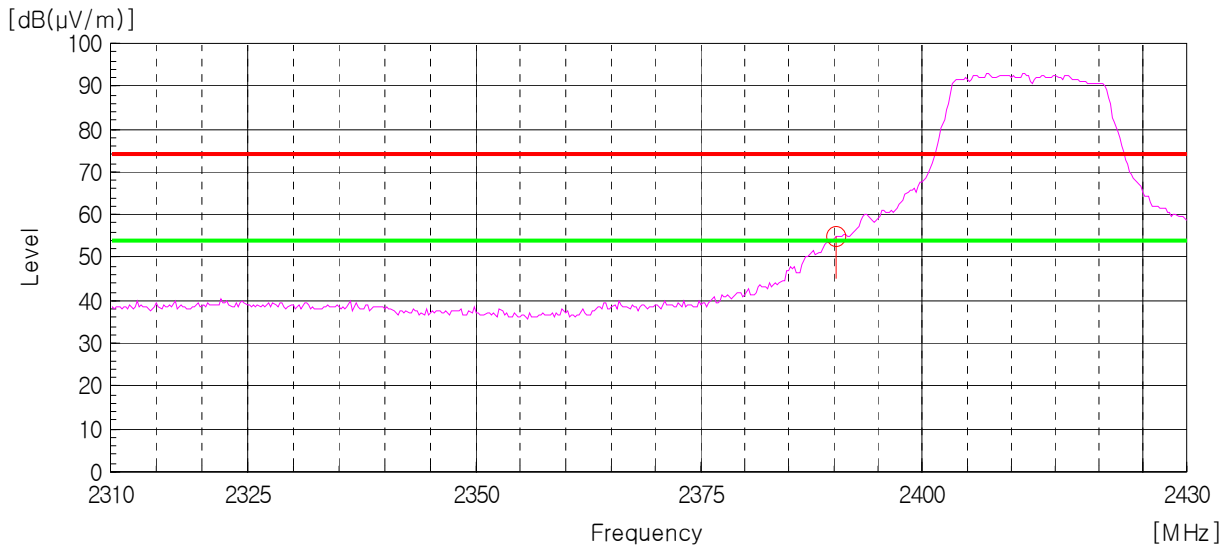

AV Detector: RBW: 1 MHz, VBW: 10 Hz (2 310 MHz - 2 390 MHz), Worst case (Low, Horizontal)

— Peak Limit Line  
 — AV Limit Line

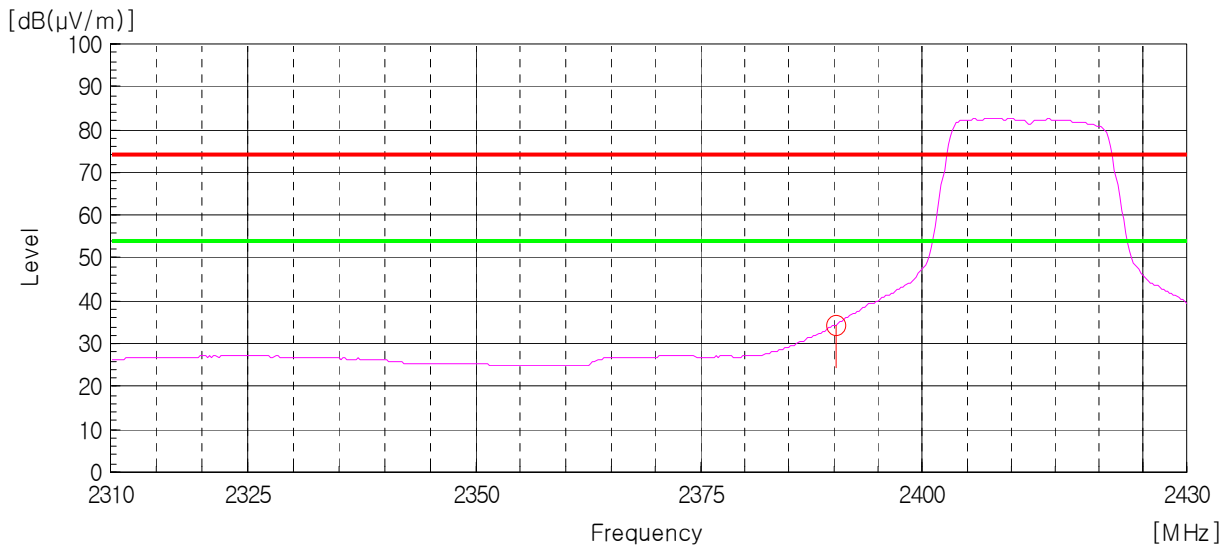



Peak Detector: RBW: 1 MHz, VBW: 1 MHz (2 483.5 MHz - 2 500 MHz), Worst case (High, Horizontal)

— Peak Limit Line  
— AV Limit Line

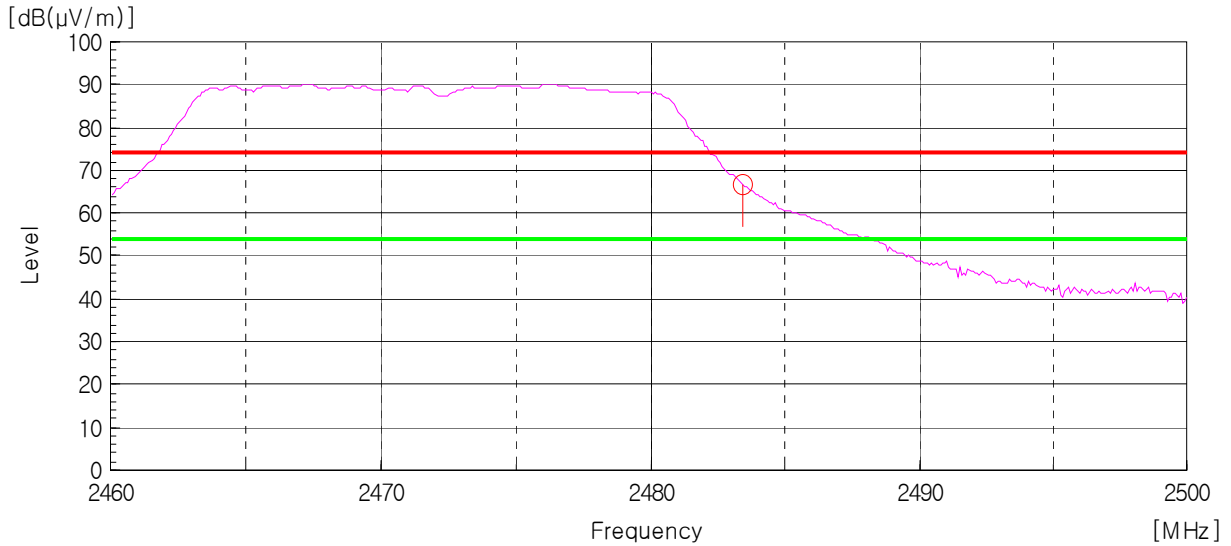

AV Detector: RBW: 1 MHz, VBW: 10 Hz (2 483.5 MHz - 2 500 MHz), Worst case (High, Horizontal)

— Peak Limit Line  
— AV Limit Line

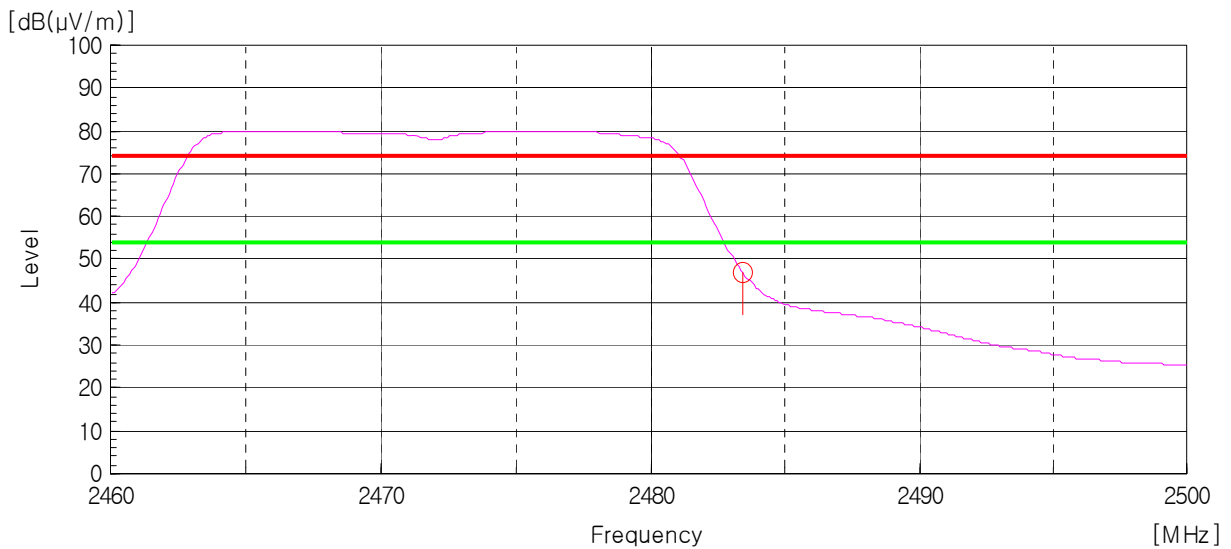

## Plots of Bandwidth of Frequency Band Edges (802.11n(HT40))

Conducted

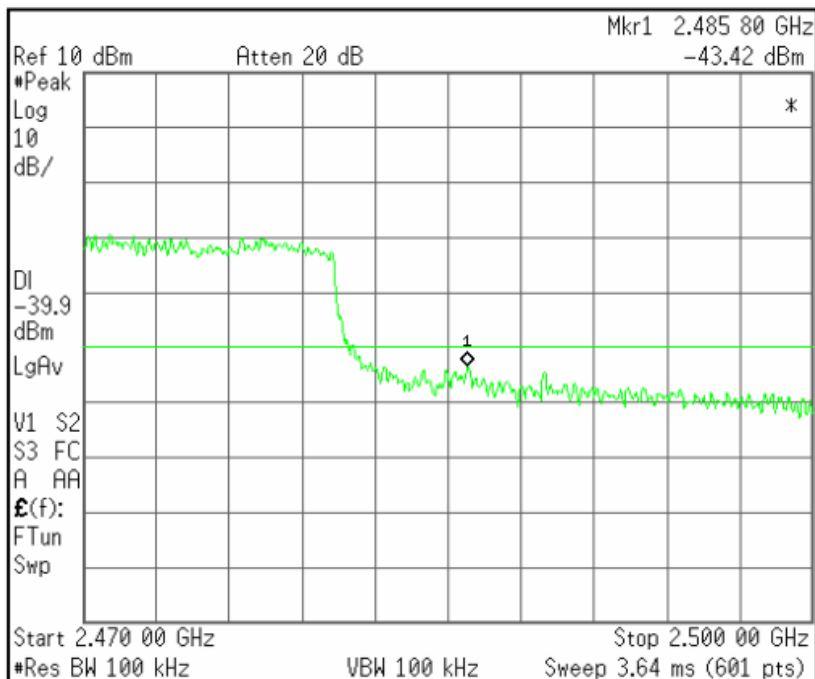
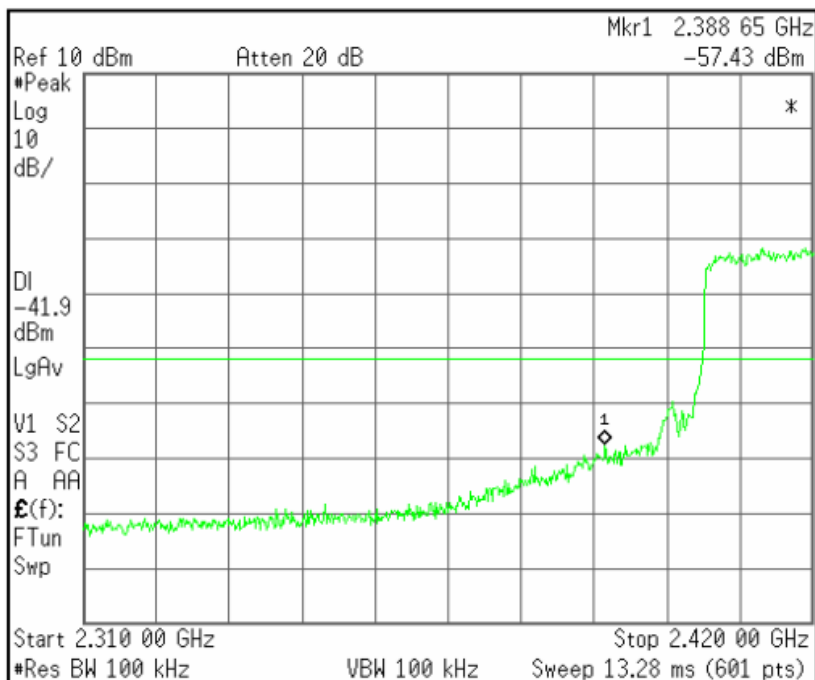

## Radiated

Peak Detector: RBW: 1 MHz, VBW: 1 MHz (2 310 MHz - 2 390 MHz), Worst case (Low, Horizontal)

— Peak Limit Line  
— AV Limit Line

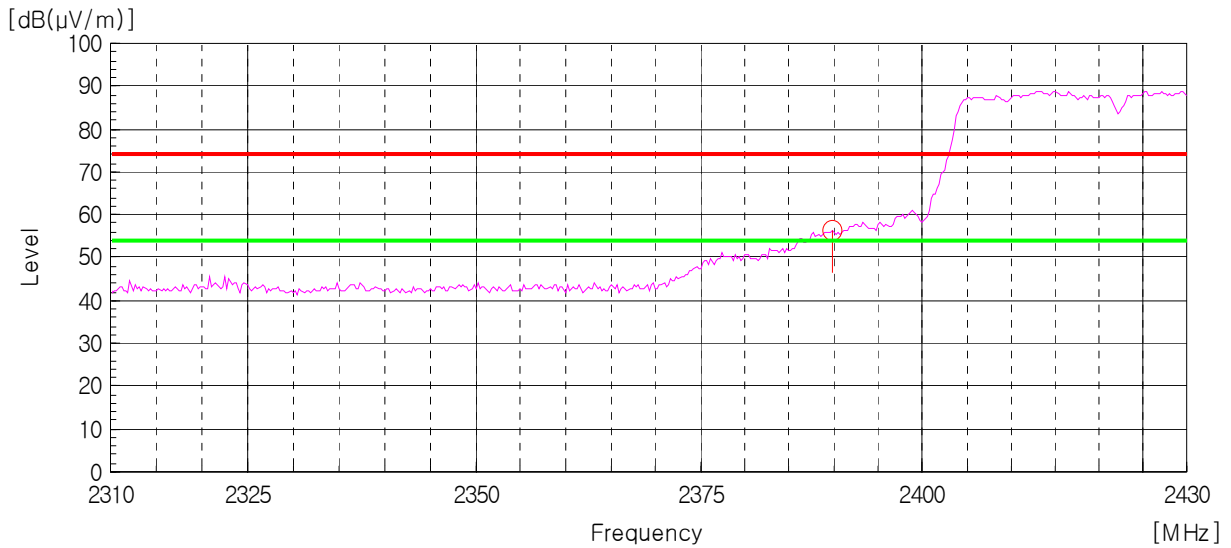

AV Detector: RBW: 1 MHz, VBW: 10 Hz (2 310 MHz - 2 390 MHz), Worst case (Low, Horizontal)

— Peak Limit Line  
— AV Limit Line

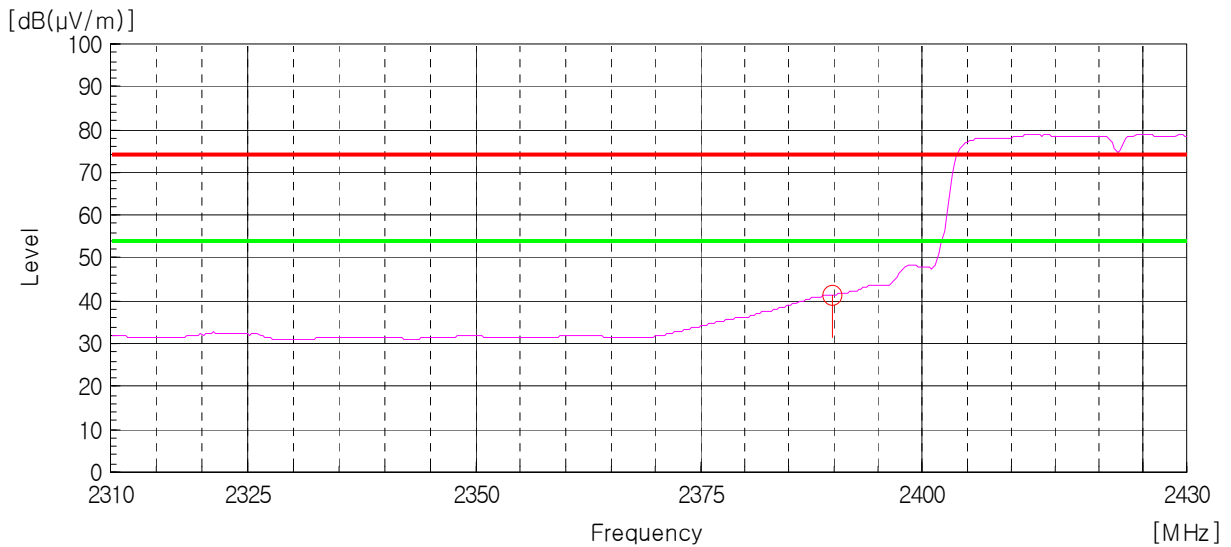

Peak Detector: RBW: 1 MHz, VBW: 1 MHz (2 483.5 MHz - 2 500 MHz), Worst case (High, Horizontal)

— Peak Limit Line  
 — AV Limit Line

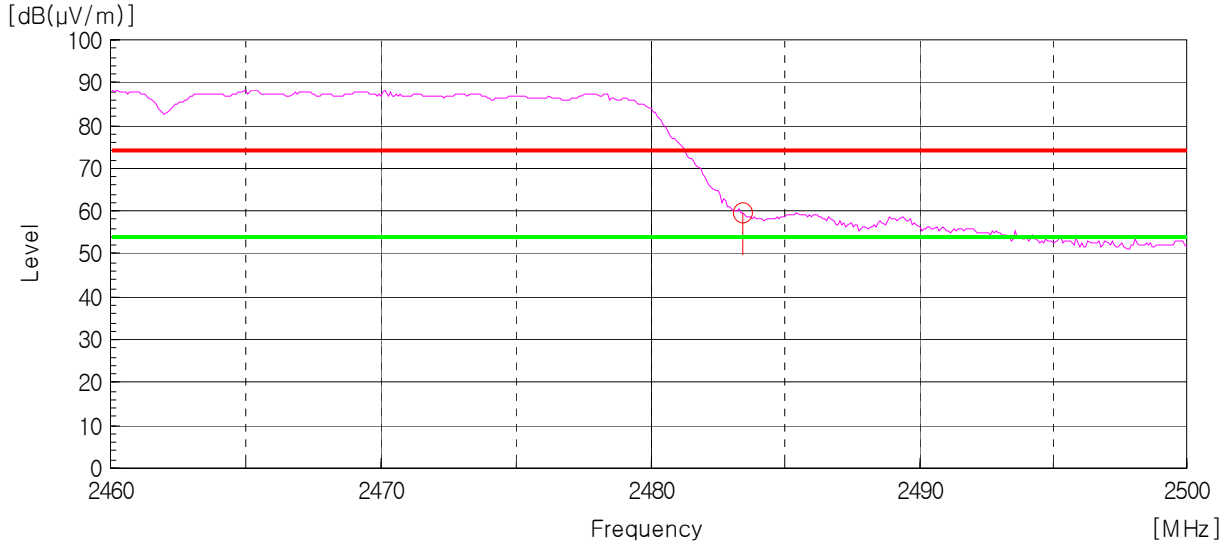

AV Detector: RBW: 1 MHz, VBW: 10 Hz (2 483.5 MHz - 2 500 MHz), Worst case (High, Horizontal)

— Peak Limit Line  
 — AV Limit Line

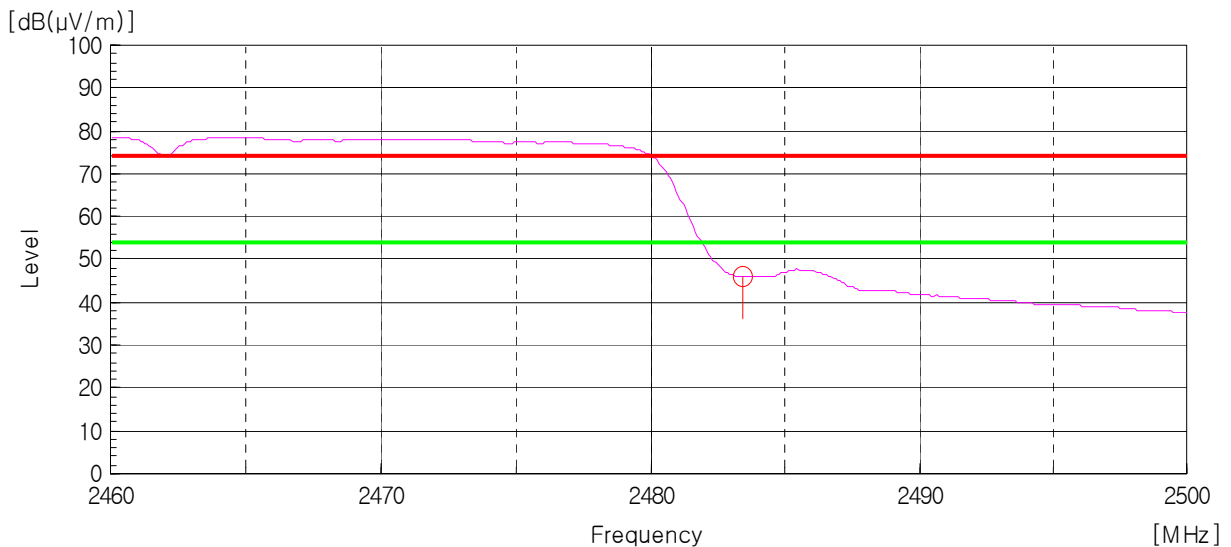

## 5.5 Power Spectral Density

EUT	Driving Recorder / DR550GW-2CH
Limit apply to	FCC Part 15.247(e)
Test Date	July 03, 2013
Operating Condition	RF transmitting continuously during the tested.
Result	Passed

### Limit

For digitally modulated systems, the power spectral density conducted from the intentional radiator to the antenna shall not be greater than 8 dBm in any 3 kHz band during any time interval of continuous transmission. This power spectral density shall be determined in accordance with the provisions of paragraph (b) of this section. The same method of determining the conducted output power shall be used to determine the power spectral density.

### Test Data

Mode	Frequency [MHz]	PSD [dBm]	Limit
802.11b	2 412	-11.77	8.00 dBm
	2 442	-9.62	
	2 472	-8.44	
802.11g	2 412	-17.84	
	2 442	-15.81	
	2 472	-15.57	
802.11n(HT20)	2 412	-18.48	
	2 442	-16.49	
	2 472	-16.52	
802.11n(HT40)	2 422	-19.95	
	2 442	-19.57	
	2 462	-19.30	

### NOTES:

1. This test was applied both to DC 12 V and DC 24 V. (Worst case: DC 24 V)
2. Measure power spectral density of relevant channel using spectrum analyzer.
3. RBW 100 kHz, VBW 300 kHz, span 1 MHz, Sweep time (= span / 3 kHz).
4. Please see the measured plot in next page.

## Plots of Power Spectral Density (802.11b)

[2 412 MHz]

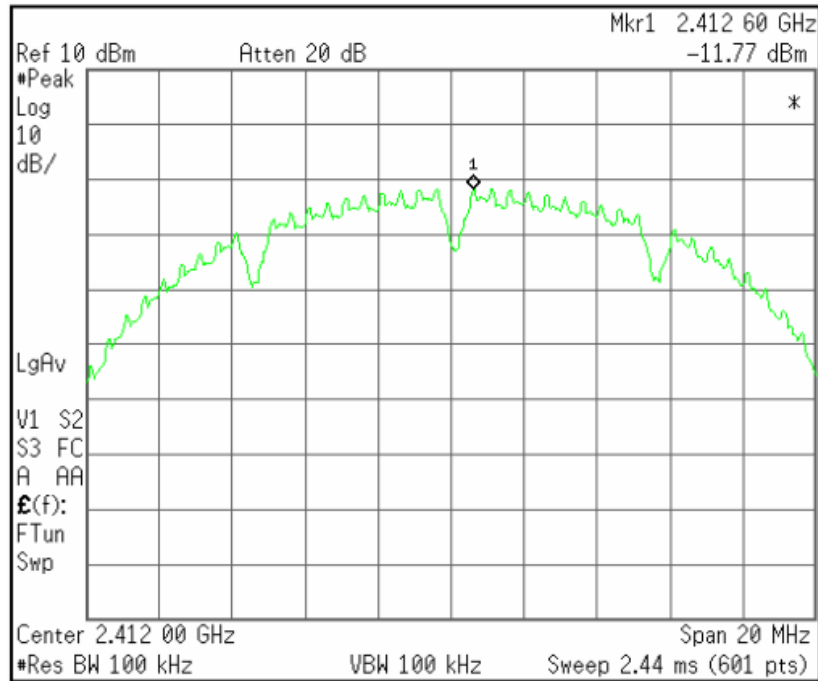

[2 442 MHz]

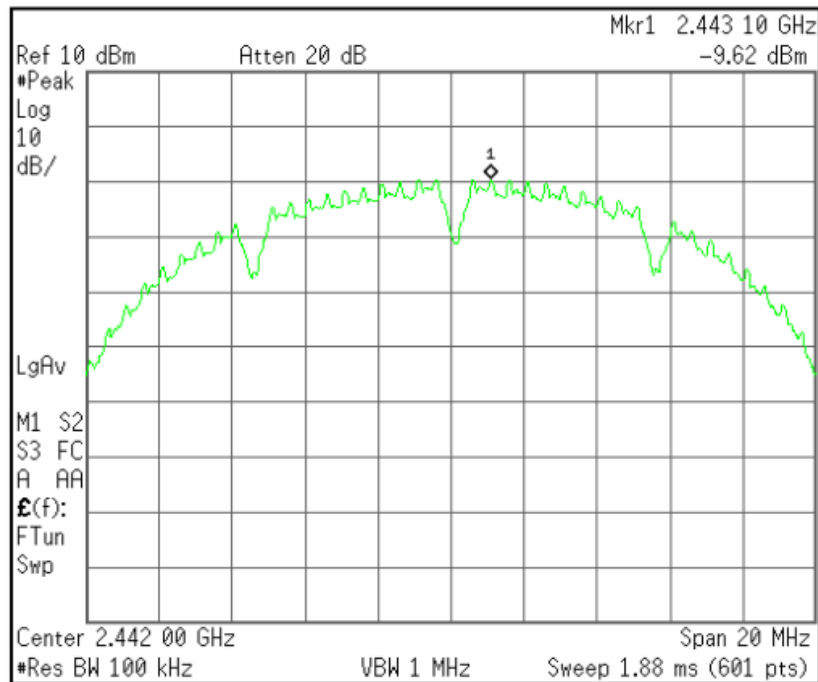

[2 472 MHz]

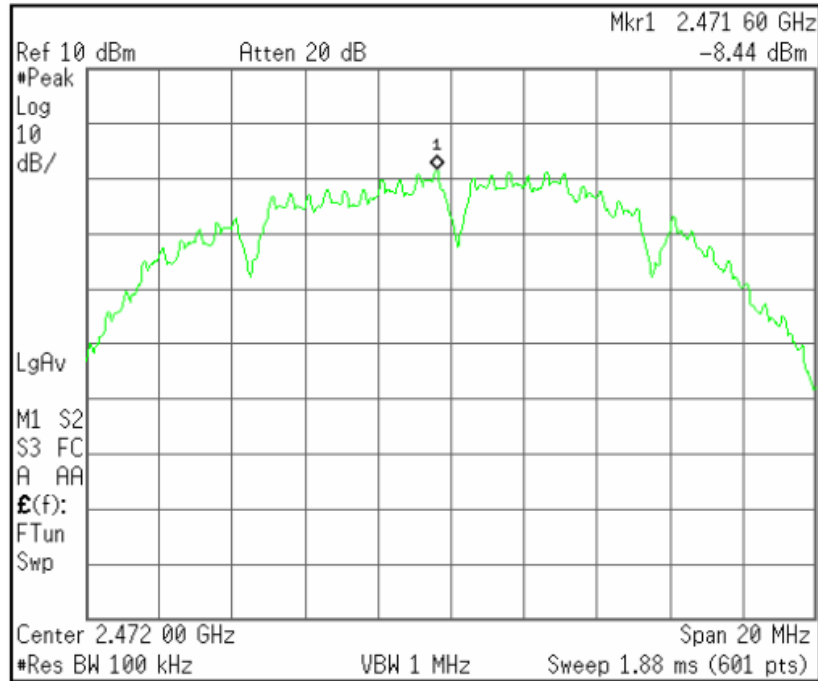

## Plots of Power Spectral Density (802.11g)

[2 412 MHz]

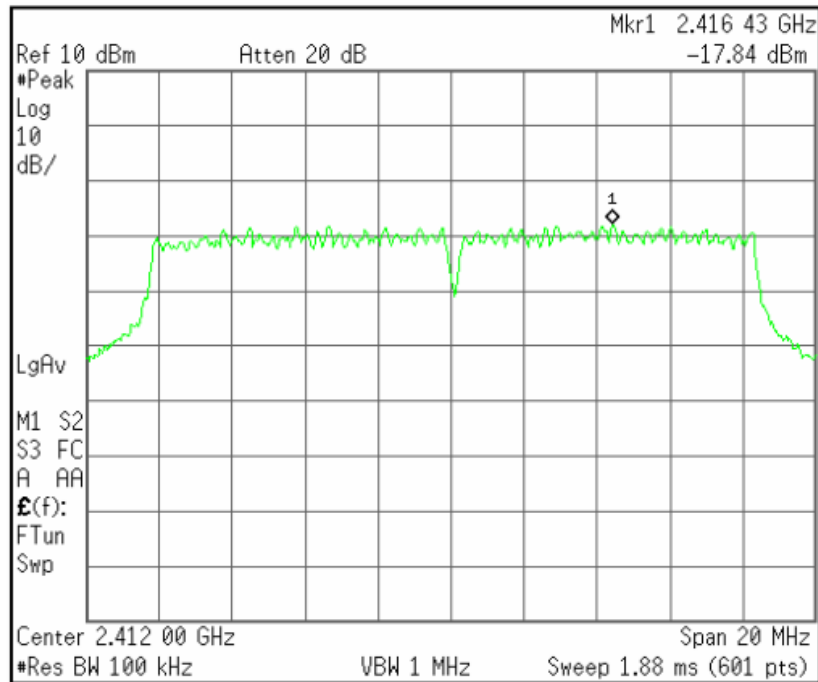

[2 442 MHz]

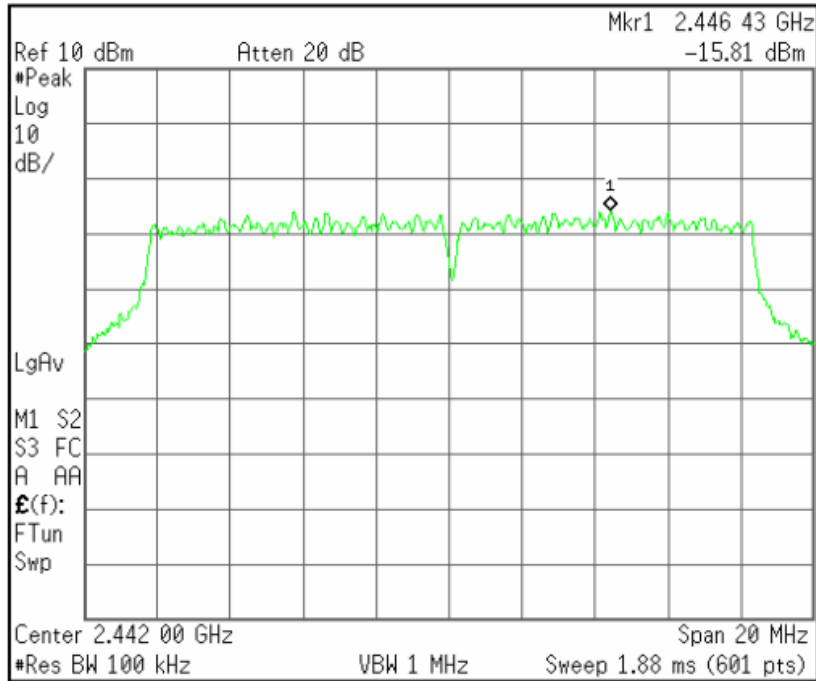

[2 472 MHz]

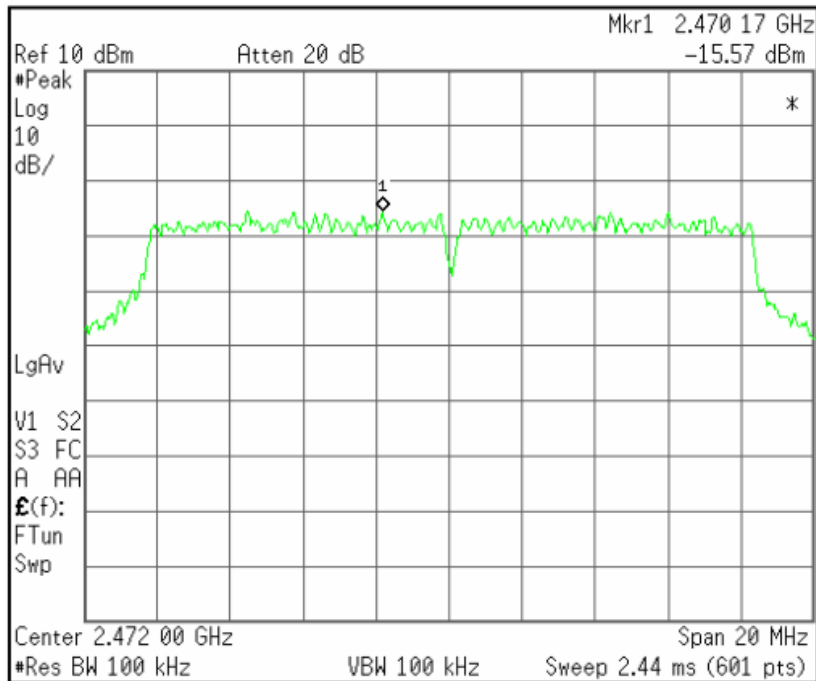



## Plots of Power Spectral Density (802.11n(HT20))

[2 412 MHz]

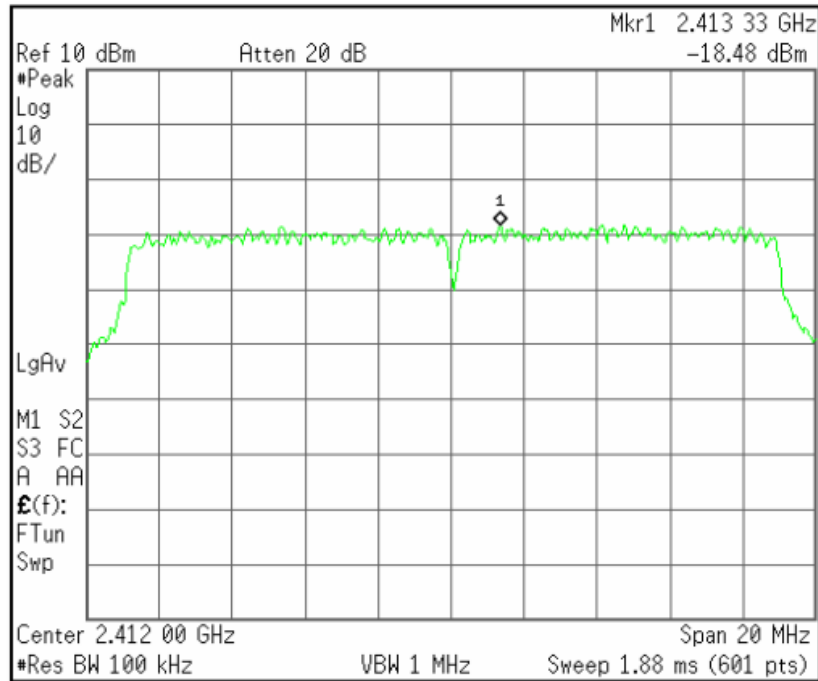

[2 442 MHz]

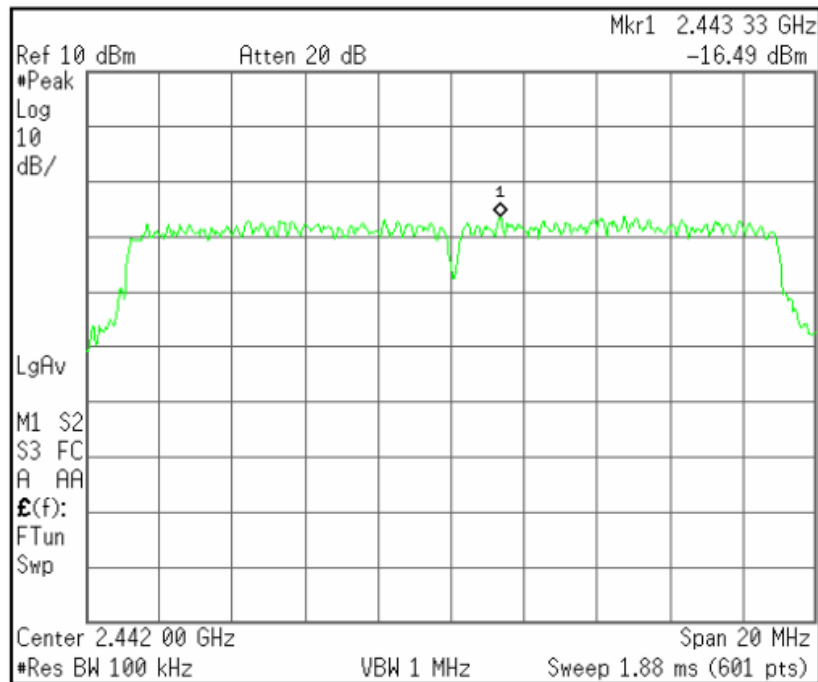

[2 472 MHz]

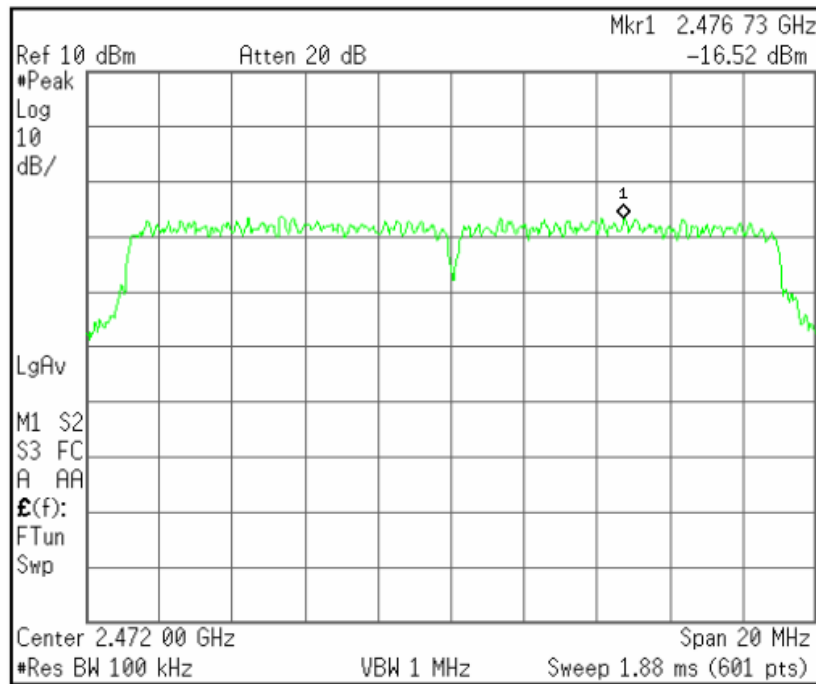

## Plots of Power Spectral Density (802.11n(HT40))

[2 422 MHz]

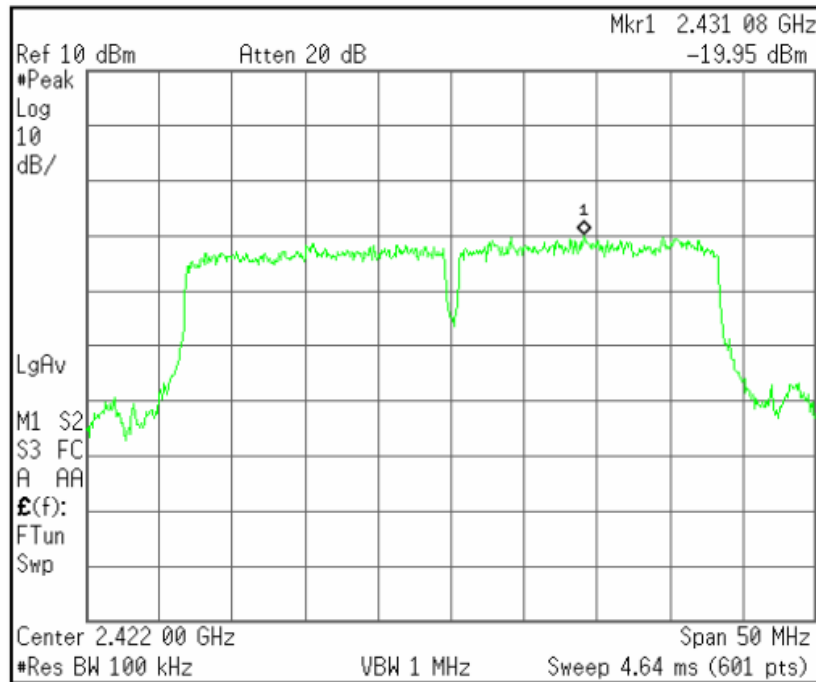

[2 442 MHz]

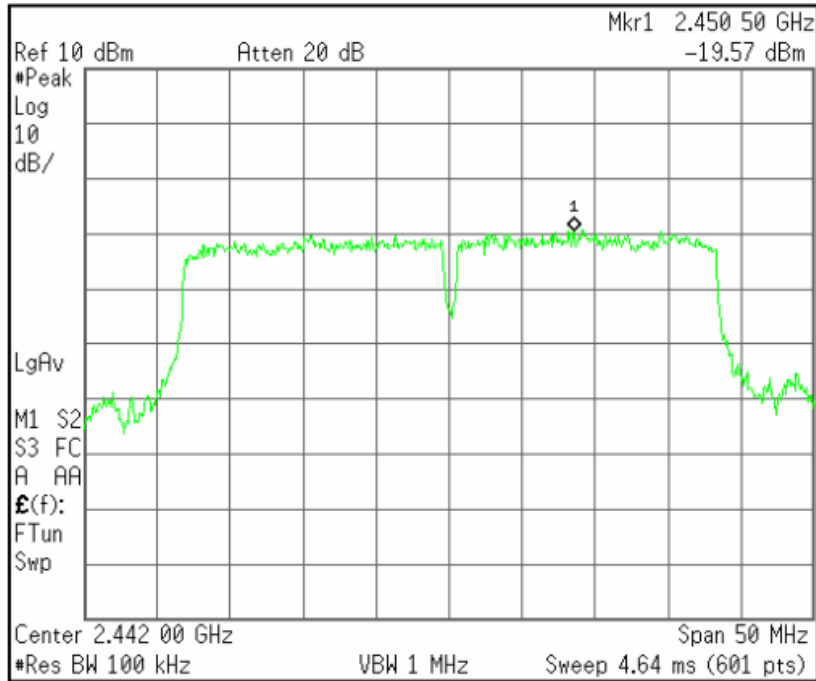

[2 462 MHz]

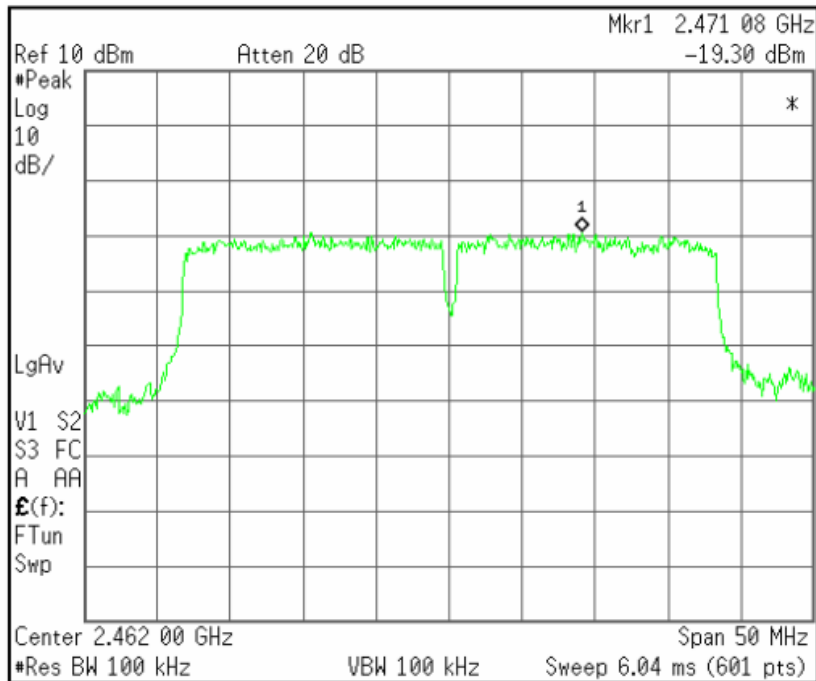

## 5.6 Spurious Emissions

EUT	Driving Recorder / DR550GW-2CH
Limit apply to	FCC Part 15.209
Test Date	July 04, 2013
Operating Condition	Low CH, Middle CH, High CH Transmission
Result	Passed

### Limit

Except as provided elsewhere in this Subpart, the emissions from an intentional radiator shall not exceed the field strength levels specified in the following table:

Frequencies [MHz]	Field Strength [ $\mu$ V/m]	Measurement Distance [m]
0.009 - 0.490	2 400/F(kHz)	300
0.490 - 1.705	24 000/F(kHz)	30
1.705 - 30.0	30	30
30 - 88	100	3
88 - 216	150	3
216 - 960	200	3
Above 960	500	3

\* Except as provided in paragraph (g), fundamental emissions from intentional radiators operating under this Section shall not be located in the frequency bands 54 MHz - 72 MHz, 76 MHz - 88 MHz, 174 MHz - 216 MHz or 470 MHz - 806 MHz. However, operation within these frequency bands is permitted under other sections of this Part, e.g., Sections 15.231 and 15.241.

### Test Results

- Refer to see the measured plot in next page.

## Radiated Emissions Test data

- 9 kHz to 30 MHz (802.11b, 802.11g, 802.11n(HT20) and 802.11n(HT40) mode)

The following table shows the highest levels of radiated emissions on both polarizations of horizontal and vertical.  
 Detector mode: CISPR Quasi-Peak mode (100 Hz, 9 kHz)

Frequency [MHz]	Reading [dB(μV)]	Polarization (*H/**V)	Ant. Factor [dB/m]	Cable Loss [dB]	Result [dB(μV/m)]	Limit [dB(μV/m)]	Margin [dB]
	<b>Emission attenuated more than 20 dB below the limit are not reported.</b>						

**Result: All emissions below noise floor of 20 dB(μV/m).**

NOTES:

1. This test was applied both to DC 12 V and DC 24 V.
2. \* H : Horizontal polarization , \*\* V : Vertical polarization
3. Result = Reading + Antenna factor + Cable loss
4. Margin = Limit - Result
5. The measurement was performed for the frequency range 9 kHz to 30 MHz according to FCC Part 15.209.

**- Below 1 GHz (30 MHz to 1 GHz) (802.11b mode)**

The following table shows the highest levels of radiated emissions on both polarizations of horizontal and vertical. Detector mode: CISPR Quasi-Peak mode (6 dB Bandwidth: 120 kHz)

Frequency [MHz]	Reading [dB(μV)]	Polarization (*H/**V)	Ant. Factor [dB/m]	Cable Loss [dB]	Result [dB(μV/m)]	Limit [dB(μV/m)]	Margin [dB]
52.04	11.72	V	12.27	1.41	25.40	40.00	14.60
142.66	8.24	V	12.59	1.97	22.80	43.50	20.70
145.11	16.84	V	12.67	1.99	31.50	43.50	12.00
176.95	14.68	V	11.77	2.15	28.60	43.50	14.90
228.38	19.09	H	10.96	2.35	32.40	46.00	13.60
250.43	18.97	H	11.69	2.44	33.10	46.00	12.90
333.70	14.19	H	14.11	2.80	31.10	46.00	14.90
409.63	15.71	H	15.86	3.03	34.60	46.00	11.40

NOTES:

1. This test was applied both to DC 12 V and DC 24 V. (Worst case: DC 24 V)
2. \* H : Horizontal polarization , \*\* V : Vertical polarization
3. Result = Reading + Antenna factor + Cable loss
4. Margin value = Limit - Result
5. The measurement was performed for the frequency range above 30 MHz according to FCC Part 15.209.

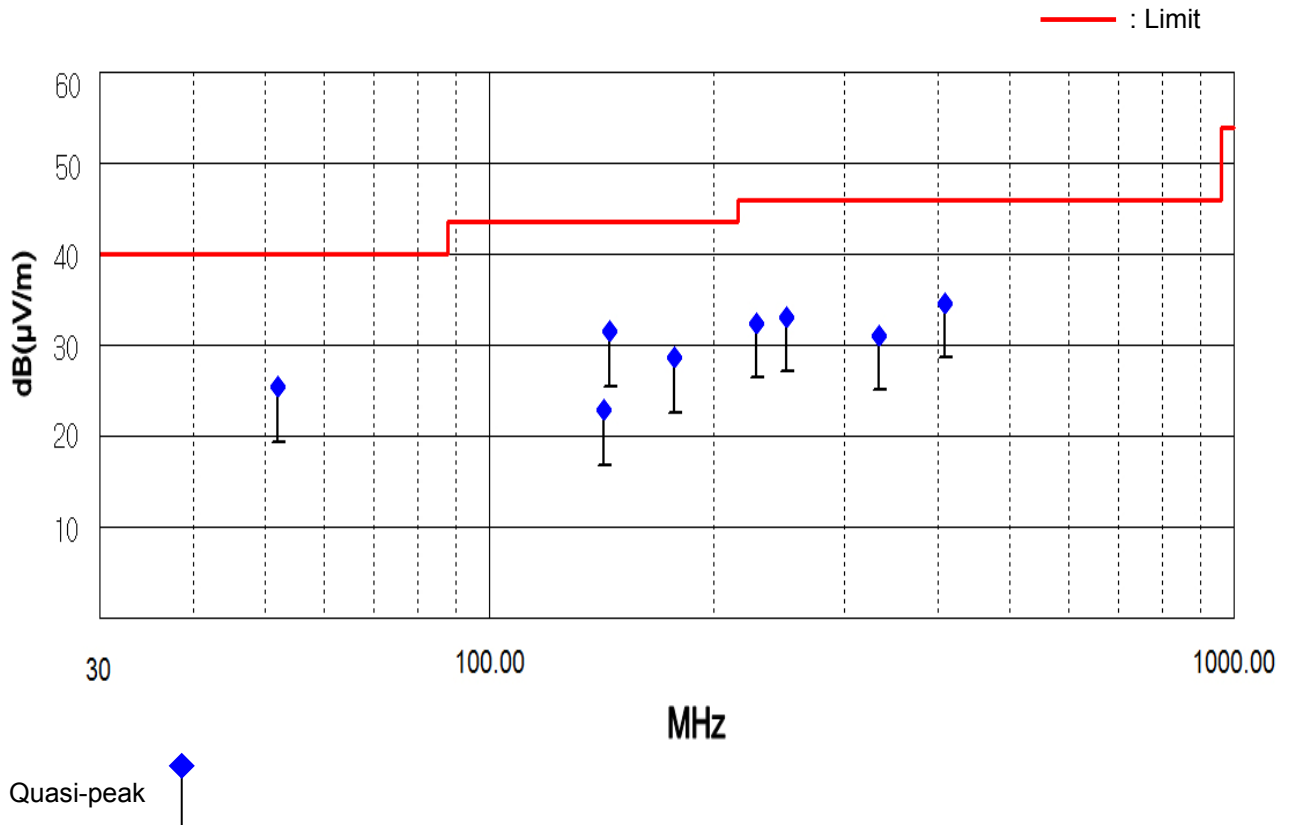

**- Below 1 GHz (30 MHz to 1 GHz) (802.11g mode)**

The following table shows the highest levels of radiated emissions on both polarizations of horizontal and vertical. Detector mode: CISPR Quasi-Peak mode (6 dB Bandwidth: 120 kHz)

Frequency [MHz]	Reading [dB(μV)]	Polarization (*H/**V)	Ant. Factor [dB/m]	Cable Loss [dB]	Result [dB(μV/m)]	Limit [dB(μV/m)]	Margin [dB]
52.04	9.52	V	12.27	1.41	23.20	40.00	16.80
142.71	7.74	V	12.59	1.97	22.30	43.50	21.20
145.10	16.54	V	12.67	1.99	31.20	43.50	12.30
176.98	14.28	V	11.77	2.15	28.20	43.50	15.30
228.40	18.89	H	10.96	2.35	32.20	46.00	13.80
250.43	19.17	H	11.69	2.44	33.30	46.00	12.70
333.50	14.89	H	14.11	2.80	31.80	46.00	14.20
409.65	15.21	H	15.86	3.03	34.10	46.00	11.90

NOTES:

1. This test was applied both to DC 12 V and DC 24 V. (Worst case: DC 24 V)
2. \* H : Horizontal polarization , \*\* V : Vertical polarization
3. Result = Reading + Antenna factor + Cable loss
4. Margin value = Limit - Result
5. The measurement was performed for the frequency range above 30 MHz according to FCC Part 15.209.

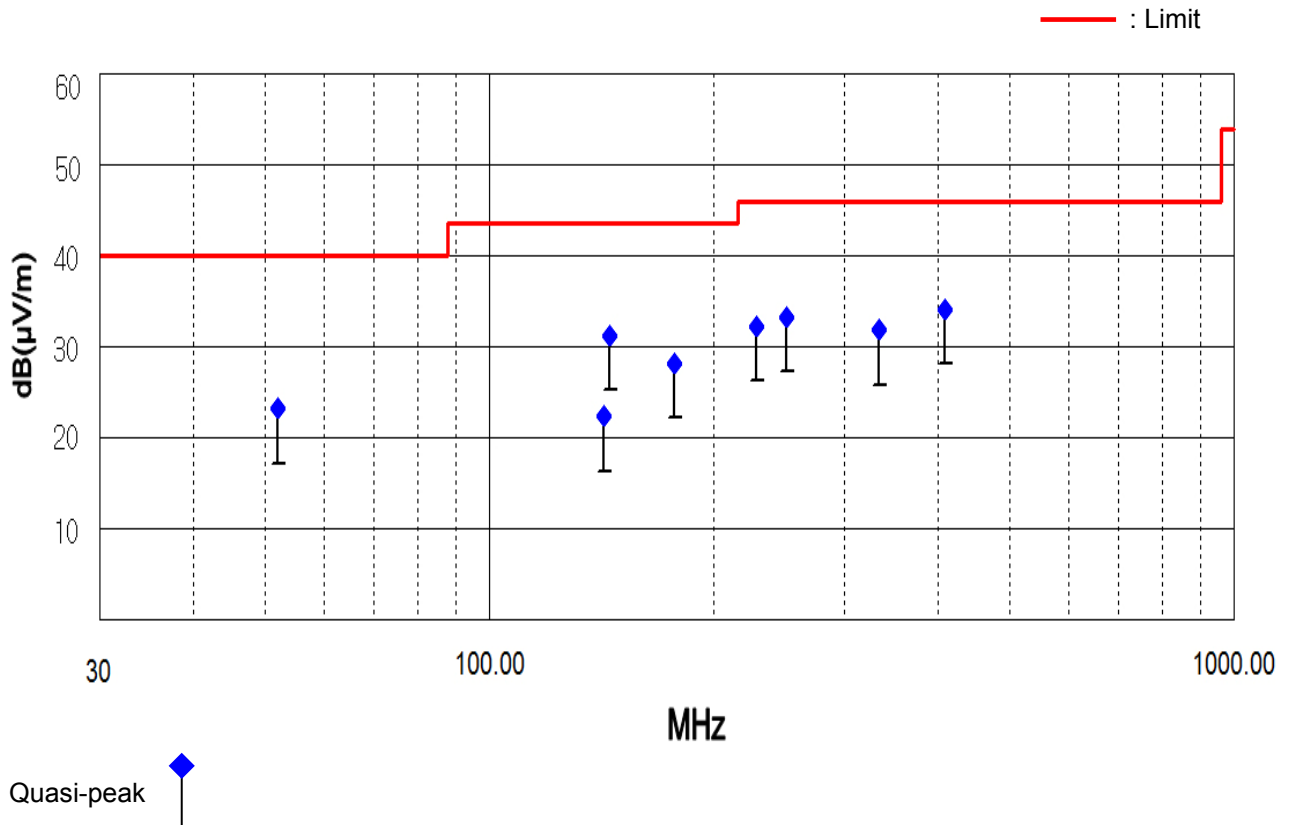

**- Below 1 GHz (30 MHz to 1 GHz) (802.11n(HT20) mode)**

The following table shows the highest levels of radiated emissions on both polarizations of horizontal and vertical. Detector mode: CISPR Quasi-Peak mode (6 dB Bandwidth: 120 kHz)

Frequency [MHz]	Reading [dB(μV)]	Polarization (*H/**V)	Ant. Factor [dB/m]	Cable Loss [dB]	Result [dB(μV/m)]	Limit [dB(μV/m)]	Margin [dB]
52.05	10.22	V	12.27	1.41	23.90	40.00	16.10
142.71	7.54	V	12.59	1.97	22.10	43.50	21.40
145.80	15.41	V	12.70	1.99	30.10	43.50	13.40
176.98	14.28	V	11.77	2.15	28.20	43.50	15.30
228.50	17.38	H	10.97	2.35	30.70	46.00	15.30
250.45	17.97	H	11.69	2.44	32.10	46.00	13.90
332.50	14.53	H	14.08	2.79	31.40	46.00	14.60
409.65	13.71	H	15.86	3.03	32.60	46.00	13.40

**NOTES:**

1. This test was applied both to 802.11n(HT20) and 802.11n(HT40). (Worst case: 802.11n(HT20))
2. This test was applied both to DC 12 V and DC 24 V. (Worst case: DC 24 V)
3. \* H : Horizontal polarization , \*\* V : Vertical polarization
4. Result = Reading + Antenna factor + Cable loss
5. Margin value = Limit - Result
6. The measurement was performed for the frequency range above 30 MHz according to FCC Part 15.209.

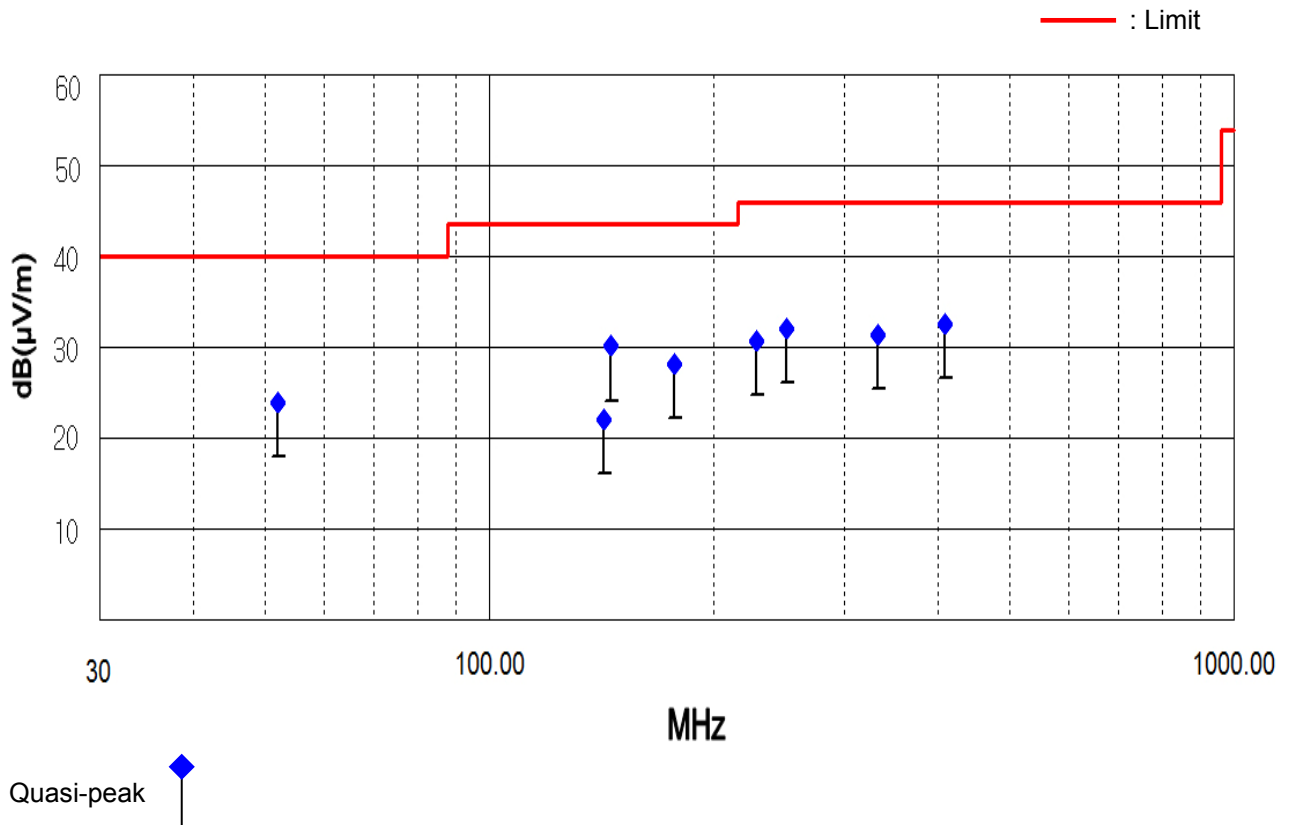



**- Above 1 GHz (1 GHz to 25 GHz)**

- 802.11b mode

1. Low CH

Frequency [MHz]	Reading [dB(μV)]		Polarity (*H/**V)	Ant. Factor [dB/m]	Cable Loss [dB]	Result [dB(μV/m)]		Limit [dB(μV/m)]		Margin [dB]	
	Peak	Average				Peak	Average	Peak	Average	Peak	Average
4 823.92	42.51	34.61	H	31.48	-31.49	42.50	34.60	74.00	54.00	31.50	19.40

2. Middle CH

Frequency [MHz]	Reading [dB(μV)]		Polarity (*H/**V)	Ant. Factor [dB/m]	Cable Loss [dB]	Result [dB(μV/m)]		Limit [dB(μV/m)]		Margin [dB]	
	Peak	Average				Peak	Average	Peak	Average	Peak	Average
4 884.20	49.80	39.20	H	31.60	-31.50	49.90	39.30	74.00	54.00	24.10	14.70

3. High CH

Frequency [MHz]	Reading [dB(μV)]		Polarity (*H/**V)	Ant. Factor [dB/m]	Cable Loss [dB]	Result [dB(μV/m)]		Limit [dB(μV/m)]		Margin [dB]	
	Peak	Average				Peak	Average	Peak	Average	Peak	Average
4 944.15	50.29	41.89	H	31.71	-31.50	50.50	42.10	74.00	54.00	23.50	11.90

**Result: No signal detect above second harmonic.**

- 802.11g mode

1. Low CH

Frequency [MHz]	Reading [dB(μV)]		Polarity (*H/**V)	Ant. Factor [dB/m]	Cable Loss [dB]	Result [dB(μV/m)]		Limit [dB(μV/m)]		Margin [dB]	
	Peak	Average				Peak	Average	Peak	Average	Peak	Average
4 823.96	44.21	32.31	H	31.48	-31.49	44.20	32.30	74.00	54.00	29.80	21.70

2. Middle CH

Frequency [MHz]	Reading [dB(μV)]		Polarity (*H/**V)	Ant. Factor [dB/m]	Cable Loss [dB]	Result [dB(μV/m)]		Limit [dB(μV/m)]		Margin [dB]	
	Peak	Average				Peak	Average	Peak	Average	Peak	Average
4 884.28	50.50	40.10	H	31.60	-31.50	50.60	40.20	74.00	54.00	23.40	13.80

3. High CH

Frequency [MHz]	Reading [dB(μV)]		Polarity (*H/**V)	Ant. Factor [dB/m]	Cable Loss [dB]	Result [dB(μV/m)]		Limit [dB(μV/m)]		Margin [dB]	
	Peak	Average				Peak	Average	Peak	Average	Peak	Average
4 944.18	50.89	41.09	H	31.71	-31.50	51.10	41.30	74.00	54.00	22.90	12.70

**Result: No signal detect above second harmonic.**

- 802.11n(HT20) mode

1. Low CH

Frequency [MHz]	Reading [dB(μV)]		Polarity (*H/**V)	Ant. Factor [dB/m]	Cable Loss [dB]	Result [dB(μV/m)]		Limit [dB(μV/m)]		Margin [dB]	
	Peak	Average				Peak	Average	Peak	Average	Peak	Average
4 823.91	42.11	31.21	H	31.48	-31.49	42.10	31.20	74.00	54.00	31.90	22.80

2. Middle CH

Frequency [MHz]	Reading [dB(μV)]		Polarity (*H/**V)	Ant. Factor [dB/m]	Cable Loss [dB]	Result [dB(μV/m)]		Limit [dB(μV/m)]		Margin [dB]	
	Peak	Average				Peak	Average	Peak	Average	Peak	Average
4 884.32	50.20	39.80	H	31.60	-31.50	50.30	39.90	74.00	54.00	23.70	14.10

3. High CH

Frequency [MHz]	Reading [dB(μV)]		Polarity (*H/**V)	Ant. Factor [dB/m]	Cable Loss [dB]	Result [dB(μV/m)]		Limit [dB(μV/m)]		Margin [dB]	
	Peak	Average				Peak	Average	Peak	Average	Peak	Average
4 944.21	50.49	40.79	H	31.71	-31.50	50.70	41.00	74.00	54.00	23.30	13.00

**Result: No signal detect above second harmonic.**

- 802.11n(HT40) mode

1. Low CH

Frequency [MHz]	Reading [dB(μV)]		Polarity (*H/**V)	Ant. Factor [dB/m]	Cable Loss [dB]	Result [dB(μV/m)]		Limit [dB(μV/m)]		Margin [dB]	
	Peak	Average				Peak	Average	Peak	Average	Peak	Average
4 844.25	39.37	29.57	H	31.52	-31.49	39.40	29.60	74.00	54.00	34.60	24.40

2. Middle CH

Frequency [MHz]	Reading [dB(μV)]		Polarity (*H/**V)	Ant. Factor [dB/m]	Cable Loss [dB]	Result [dB(μV/m)]		Limit [dB(μV/m)]		Margin [dB]	
	Peak	Average				Peak	Average	Peak	Average	Peak	Average
4 884.32	48.50	37.60	H	31.60	-31.50	48.60	37.70	74.00	54.00	25.40	16.30

3. High CH

Frequency [MHz]	Reading [dB(μV)]		Polarity (*H/**V)	Ant. Factor [dB/m]	Cable Loss [dB]	Result [dB(μV/m)]		Limit [dB(μV/m)]		Margin [dB]	
	Peak	Average				Peak	Average	Peak	Average	Peak	Average
4 924.28	48.73	38.53	H	31.67	-31.50	48.90	38.70	74.00	54.00	25.10	15.30

**Result: No signal detect above second harmonic.**

NOTES:

1. This test was applied both to DC 12 V and DC 24 V. (Worst case: DC 24 V)
2. \* H : Horizontal polarization , \*\* V : Vertical polarization
3. Factor = Antenna factor + Cable loss + Preamp
4. Result = Reading + Factor
5. Margin = Limit - Result
6. Measuring frequencies from 1GHz to the 10<sup>th</sup> harmonic of highest fundamental frequency.
7. Measurements above show only up to 6 maximum emissions noted, or would be lesser if no specific emissions from the EUT are recorded (ie: margin > 20 dB from the applicable limit) and considered that's already beyond the background noise floor.
8. Spectrum setting:
  - a. Peak Setting 1 GHz to 10<sup>th</sup> harmonics of fundamental, RBW = 1 MHz, VBW = 1 MHz, Sweep = Auto
  - b. AV Setting 1 GHz to 10<sup>th</sup> harmonics of fundamental, RBW = 1 MHz, VBW = 10 Hz, Sweep = Auto

## Plots of Spurious Emissions (Conducted Measurement) (802.11b)

[CH Low]

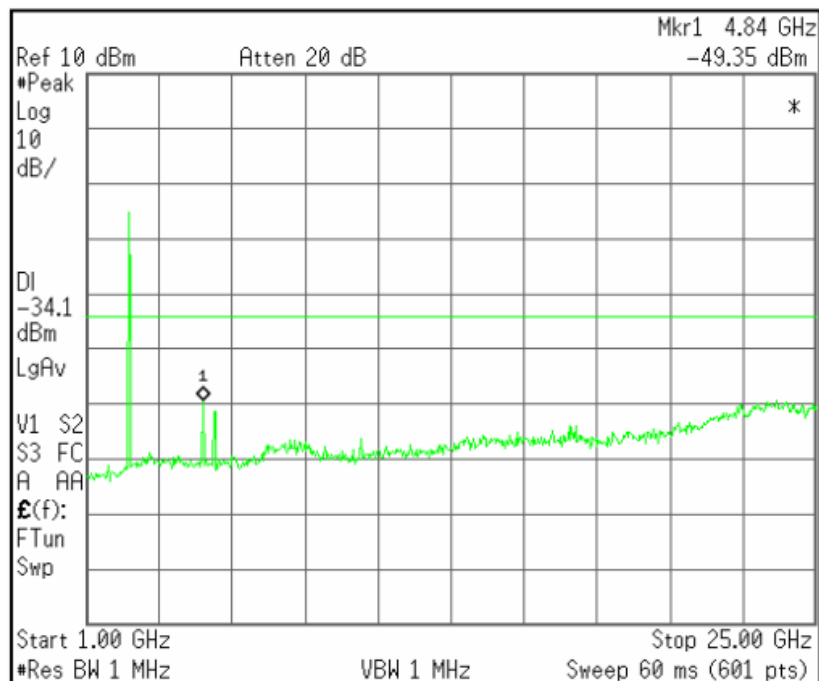
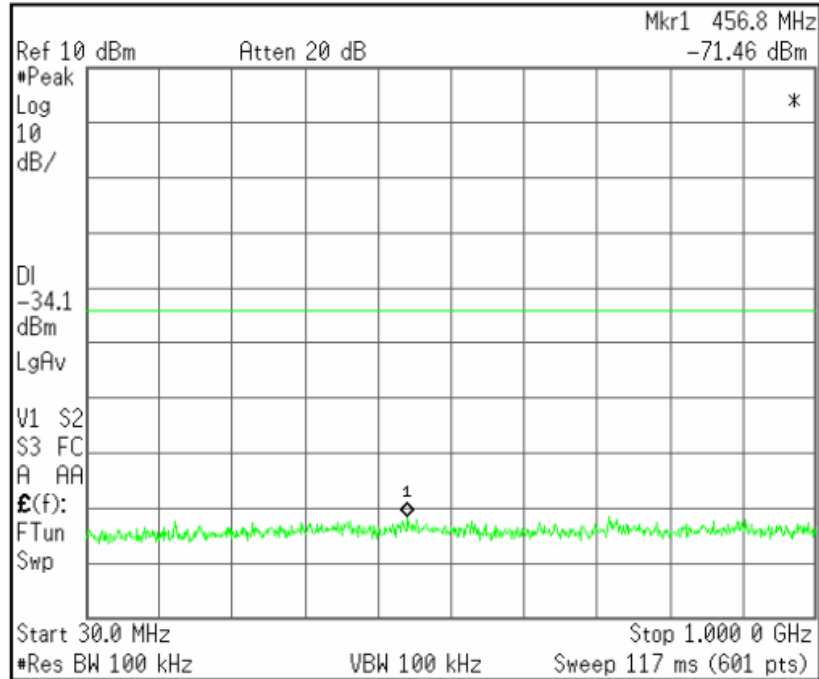

[CH Mid]

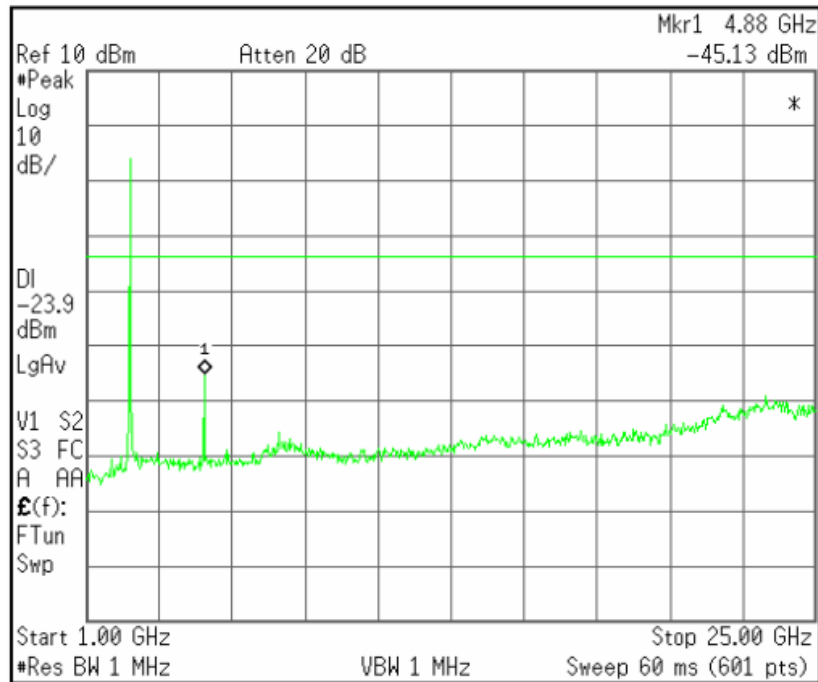
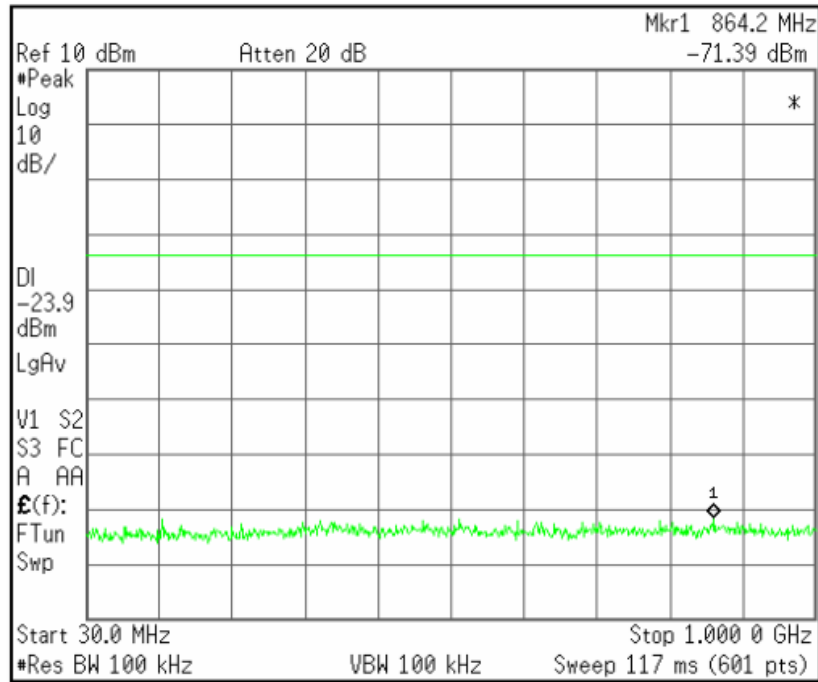

[CH High]

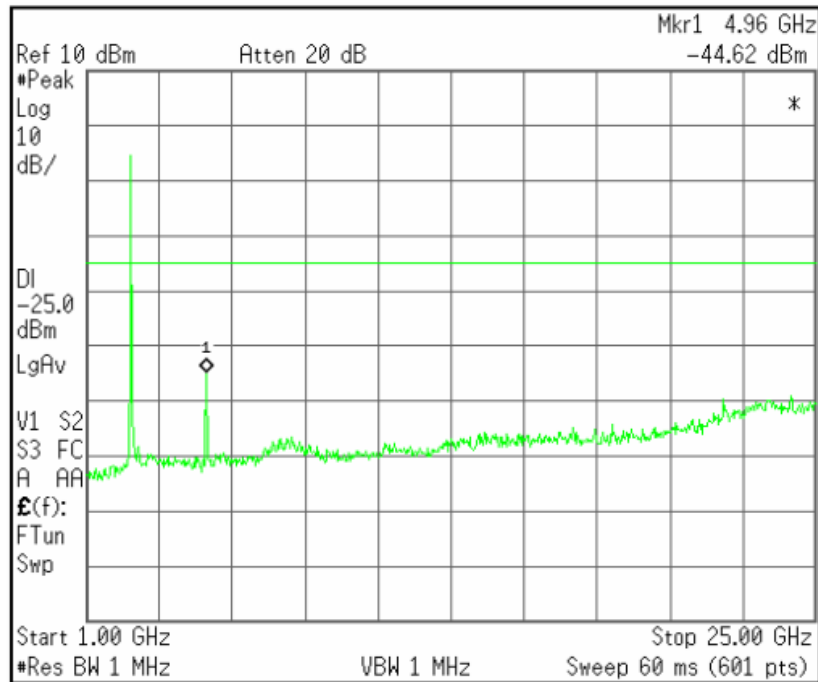
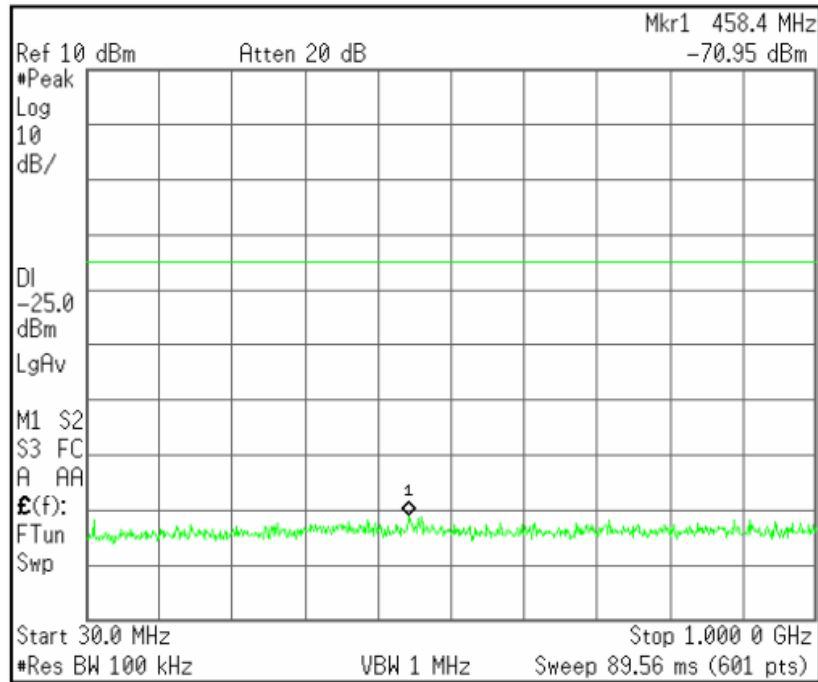

## Plots of Spurious Emissions (Conducted Measurement) (802.11g)

[CH Low]

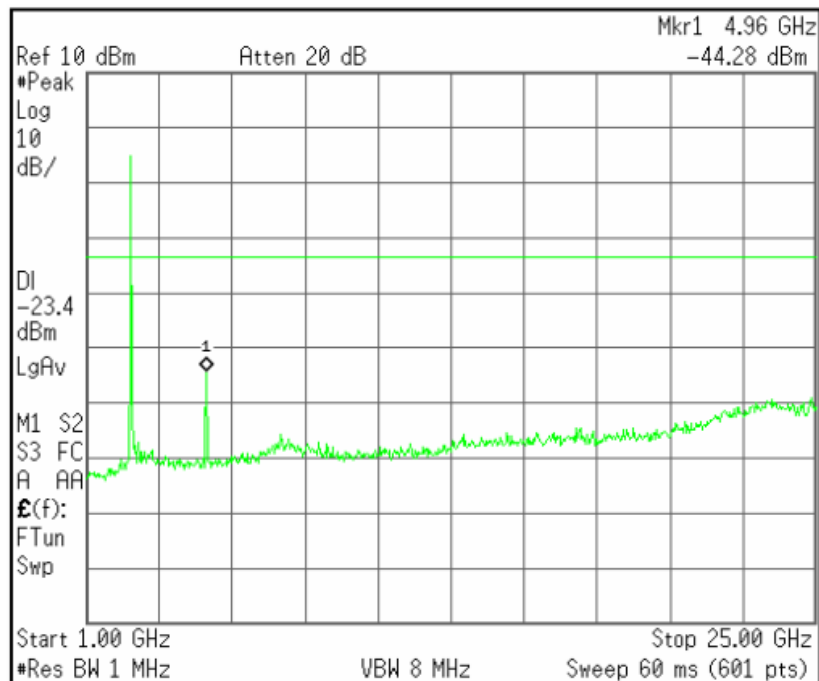
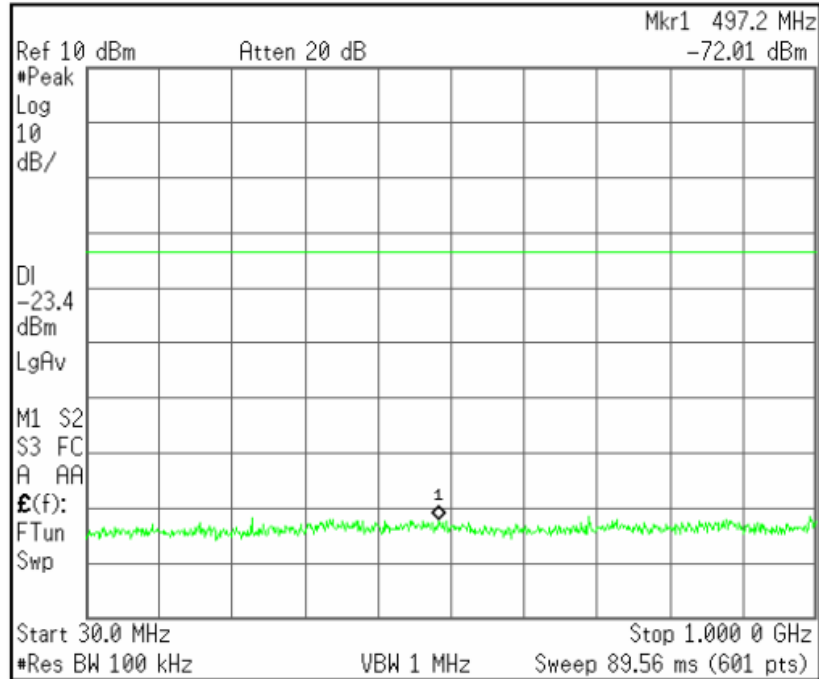



[CH Mid]

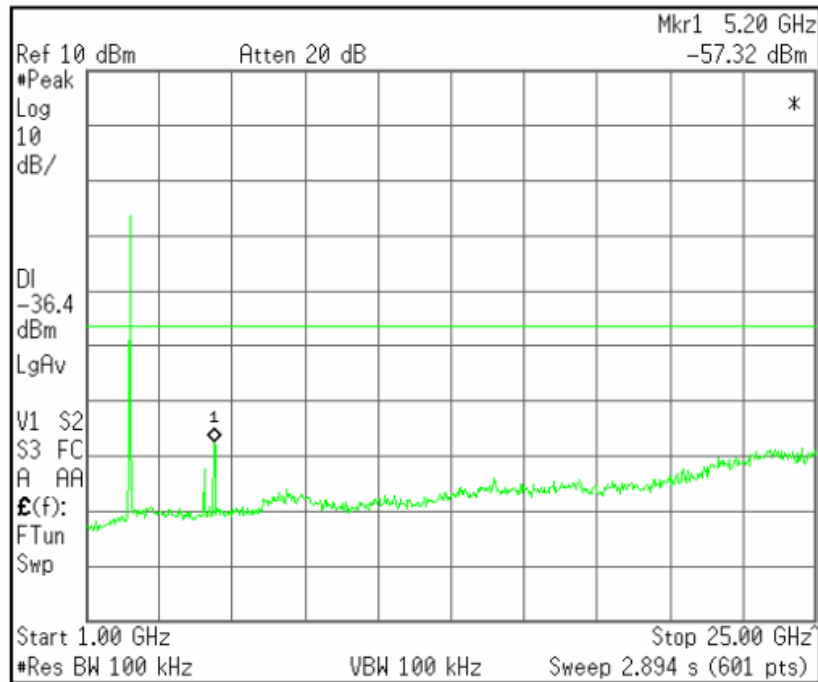
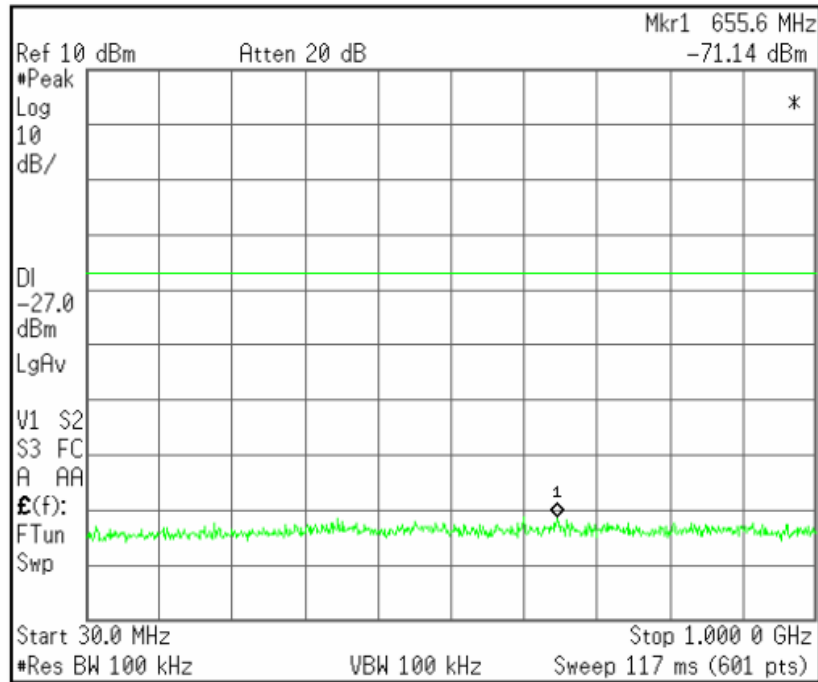

[CH High]

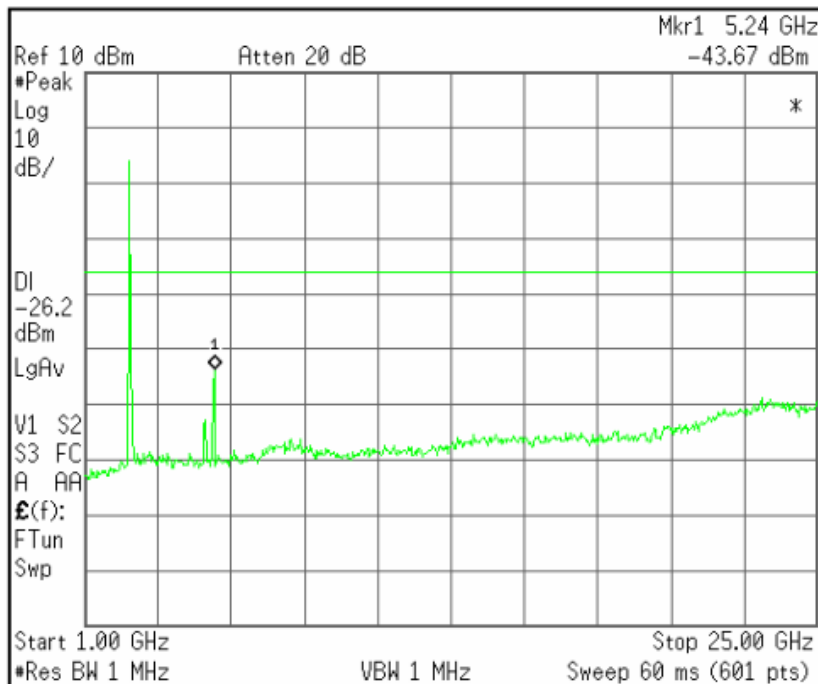
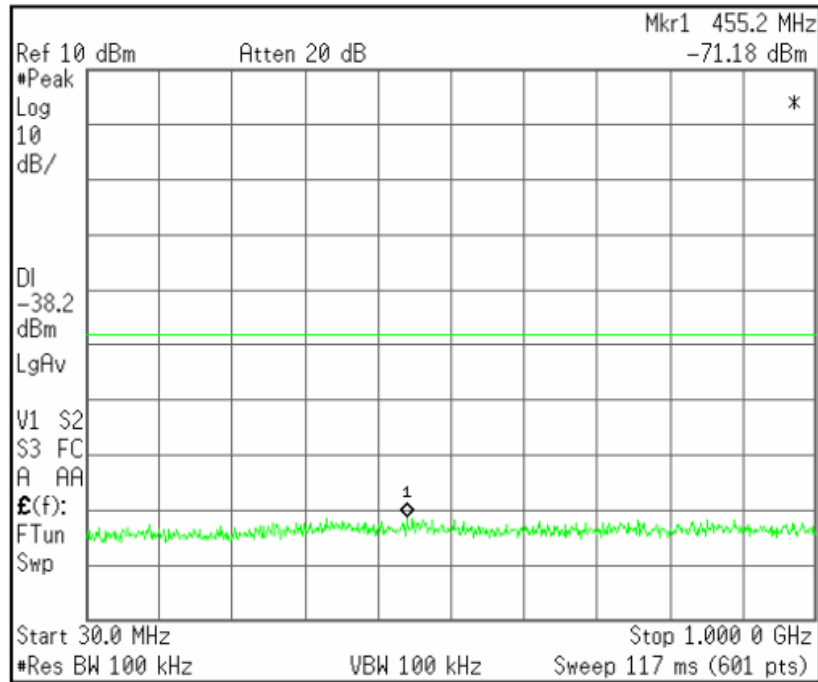

## Plots of Spurious Emissions (Conducted Measurement) (802.11n(HT20))

[CH Low]

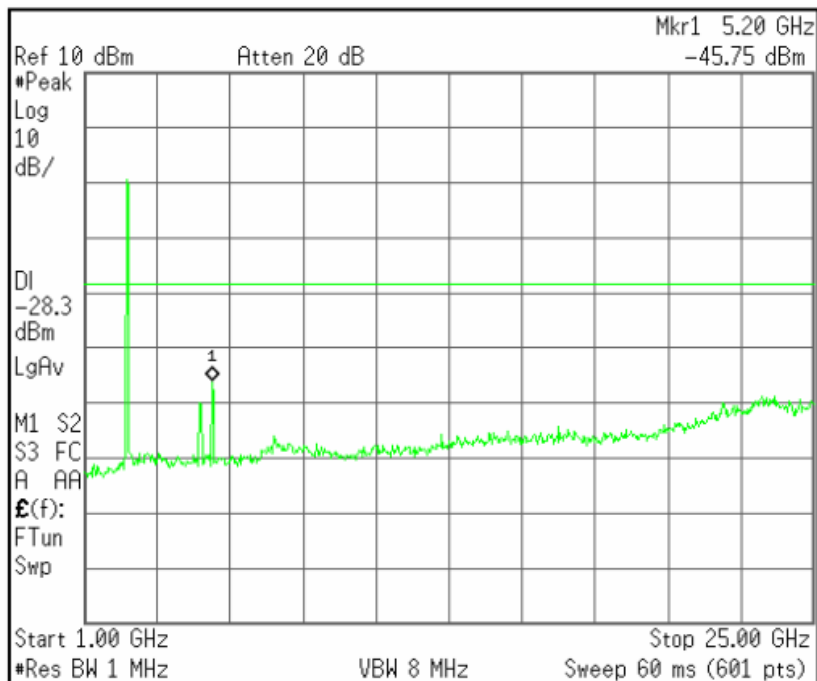
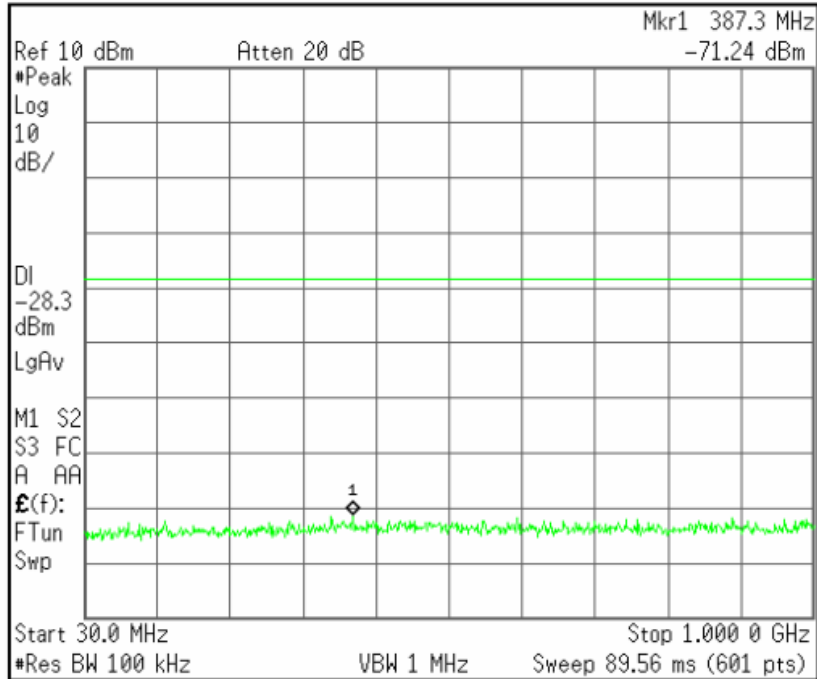

[CH Mid]

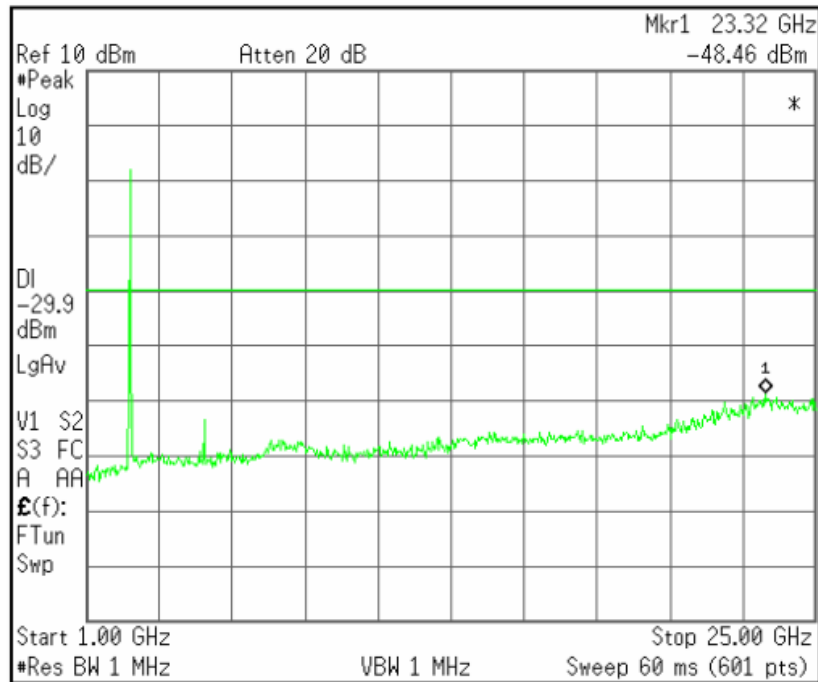
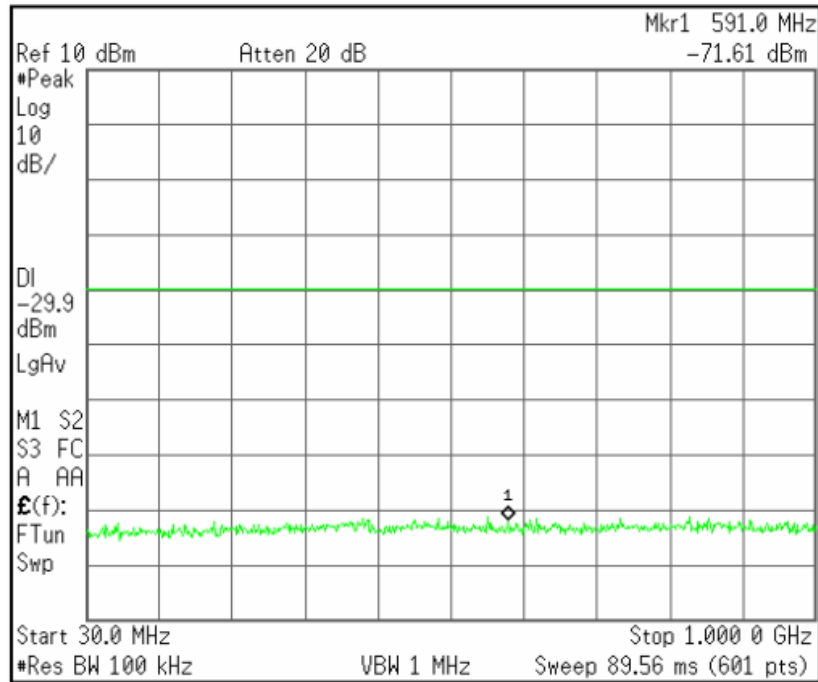

[CH High]

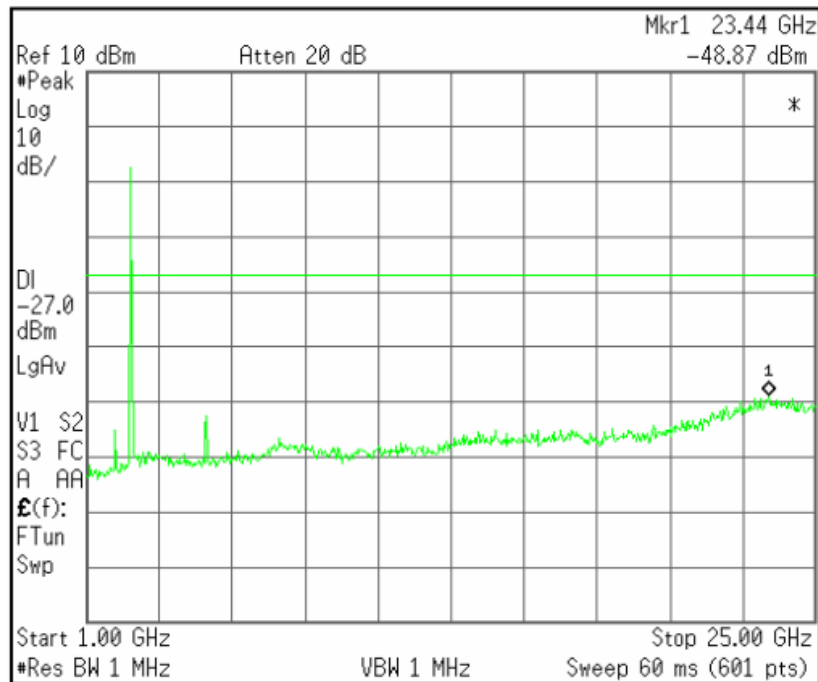
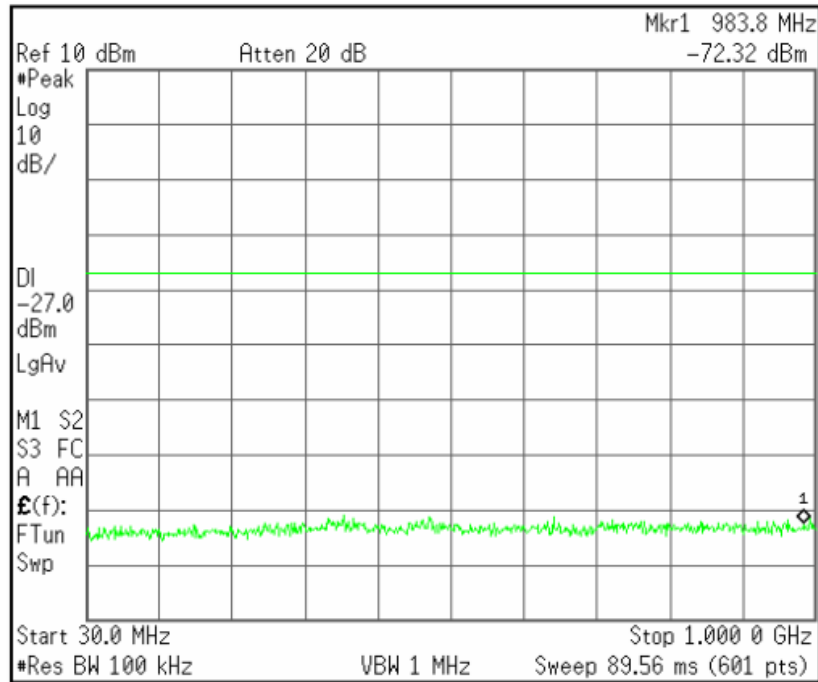

## Plots of Spurious Emissions (Conducted Measurement) (802.11n(HT40))

[CH Low]

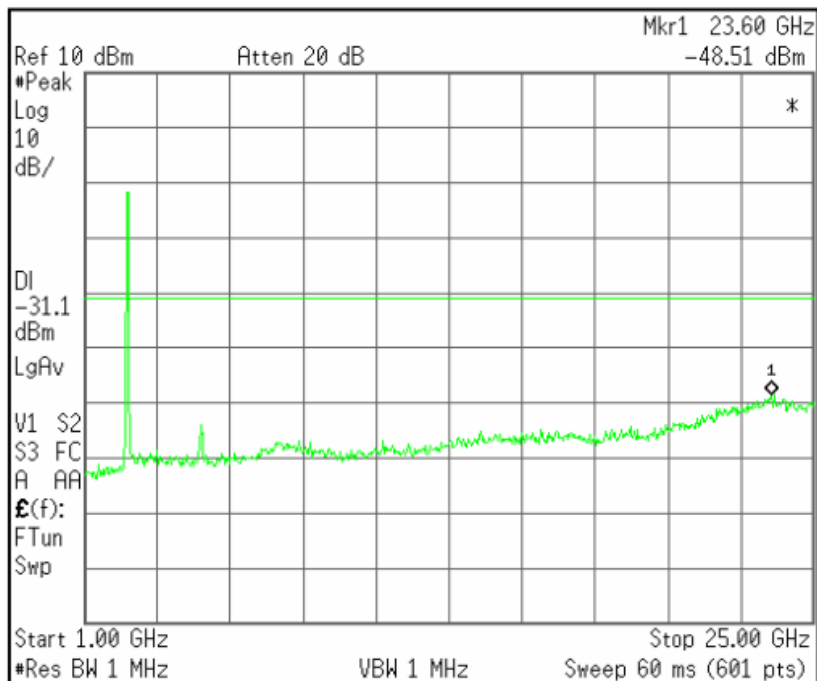
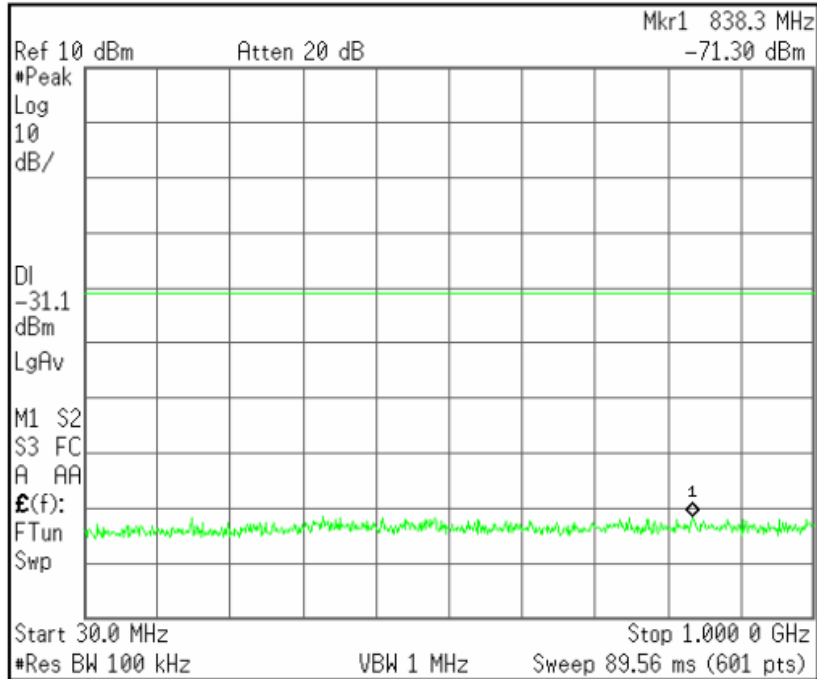

[CH Mid]

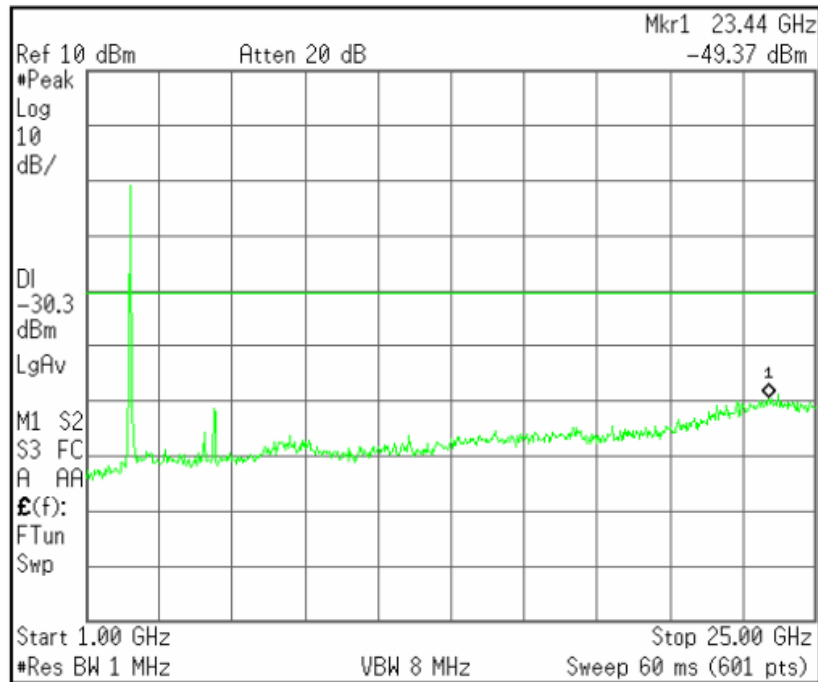
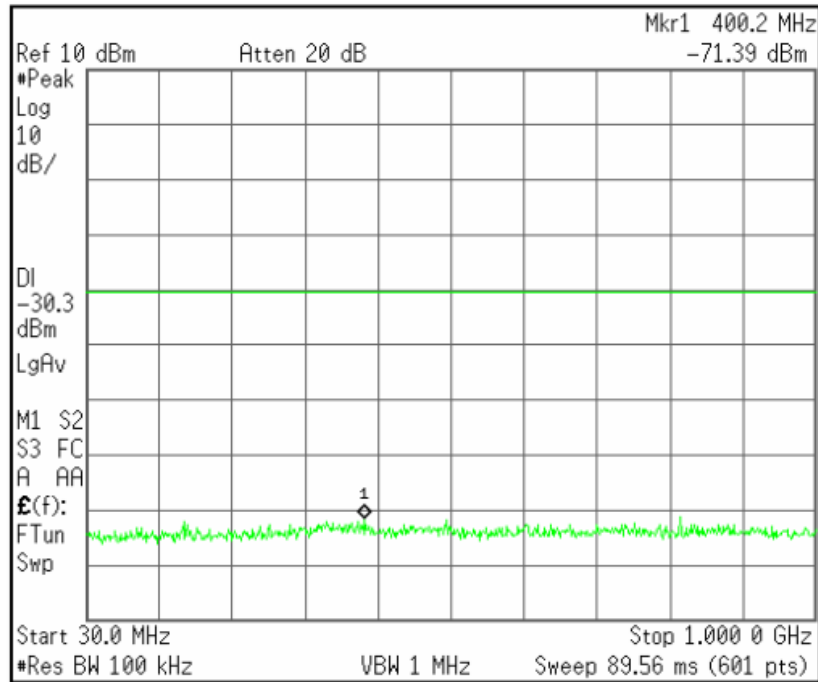

[CH High]

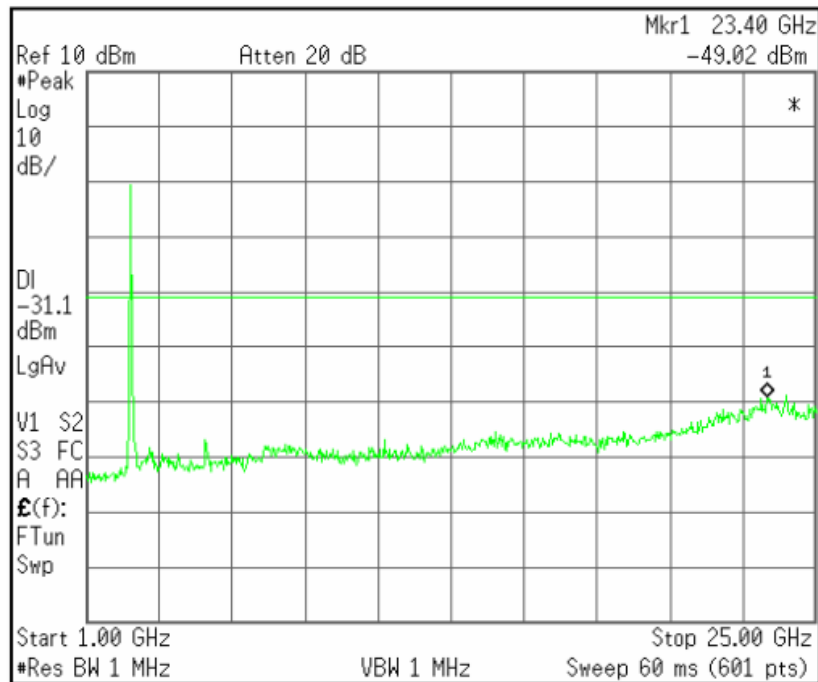
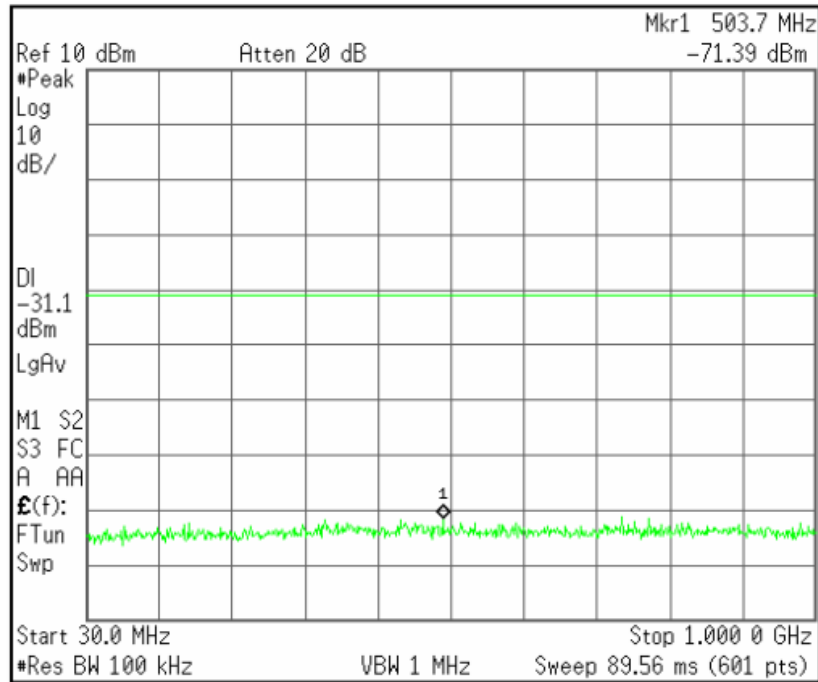



## 5.7 Radio Frequency Exposure

Systems operating under the provisions of this section shall be operated in a manner that ensures that the public is not exposed to radio frequency energy levels in excess of the Commission's guidelines. See § 1.1307(b)(1) of this Chapter.

### Limit

Limits for general population/Uncontrolled exposure

Frequency Range [MHz]	Electric Field Strength (E) [V/m]	Magnetic Field Strength (H) [A/m]	Power Density (S) [mW/cm <sup>2</sup> ]	Averaging Time  E  <sup>2</sup> ,  H  <sup>2</sup> or S [minutes]
0.3 - 1.34	614	1.63	(100)	30
1.34 - 30	824/f	2.19/f	(180/f <sup>2</sup> )	30
30 - 300	27.5	0.073	0.2	30
300 - 1 500	--	--	f/1 500	30
1 500 - 100 000	--	--	1.0	30

f = frequency in MHz

\*Plane-wave equivalent power density

### MPE Prediction

Predication of MPE limit at a given distance.

Equation from page 18 of OET Bulletin 65, Edition 97-01

$$S = PG / 4\pi R^2$$

Where:

- S = power density (in appropriate units, e.g. mW/cm<sup>2</sup>)
- P = power input to the antenna (in appropriate units, e.g., mW)
- G = power gain of the antenna in the direction of interest relative to an isotropic radiator
- R = distance to the center of radiation of the antenna (appropriate units, e.g., cm)

- 802.11b mode

Maximum peak output power at antenna input : 0.35 dBm (1.084 mW)  
Prediction distance : 20 cm  
Predication frequency : 2 472 MHz  
Antenna gain(Max) : 3.10 dBi (2.04 numeric)  
Power density at predication frequency at 20 cm : 0.000440 mW/cm<sup>2</sup>

MPE Limit for : 1 mW/cm<sup>2</sup>

- 802.11g mode

Maximum peak output power at antenna input : -2.93 dBm (0.509 mW)  
Prediction distance : 20 cm  
Predication frequency : 2 472 MHz  
Antenna gain(Max) : 3.10 dBi (2.04 numeric)  
Power density at predication frequency at 20 cm : 0.000206 mW/cm<sup>2</sup>

MPE Limit for : 1 mW/cm<sup>2</sup>

- 802.11n(HT20) mode

Maximum peak output power at antenna input : -3.32 dBm (0.466 mW)  
Prediction distance : 20 cm  
Predication frequency : 2 472 MHz  
Antenna gain(Max) : 3.10 dBi (2.04 numeric)  
Power density at predication frequency at 20 cm : 0.000189 mW/cm<sup>2</sup>

MPE Limit for : 1 mW/cm<sup>2</sup>

- 802.11n(HT40) mode

Maximum peak output power at antenna input : -3.32 dBm (0.466 mW)  
Prediction distance : 20 cm  
Predication frequency : 2 422 MHz  
Antenna gain(Max) : 3.10 dBi (2.04 numeric)  
Power density at predication frequency at 20 cm : 0.000189 mW/cm<sup>2</sup>

MPE Limit for : 1 mW/cm<sup>2</sup>

## Test Result

The power density level at 20 cm is 0.000440 mW/cm<sup>2</sup>, 0.000206 mW/cm<sup>2</sup>, 0.000189 mW/cm<sup>2</sup> and 0.000189 mW/cm<sup>2</sup> which is below the uncontrolled exposure limit of 1 mW/cm<sup>2</sup> at 2 412 MHz to 2 472 MHz.

## 6. SAMPLE CALCULATION

### Sample Field Strength Calculation

The field strength is calculated by adding the Antenna Factor and Cable Factor.  
The basic equation with a sample calculation is as follows:

$$FS = RA + AF + CF - PA$$

Where FS = Field Strength  
 RA = Receiver Amplitude  
 AF = Antenna Factor  
 CF = Cable Attenuation Factor  
 PA\* = Preamplifier Factor

\* PA is only be used for the measuring frequency above 1 GHz.

$$\begin{aligned} \text{dB}(\mu\text{V}) &= 20 \log_{10} (\mu\text{V}) : \text{Equation} \\ \text{dB}(\mu\text{V}) &= \text{dBm} + 107 \end{aligned}$$

Example : @ 409.63 MHz

Class B Limit	= 46.00 dB(μV/m)
Reading	= 15.71 dB(μV)
Antenna Factor + Cable Loss	= 15.86 + 3.03 = 18.89 dB(μV/m)
Total	= 34.60 dB(μV/m)
Margin	= 46.00 – 34.60 = 11.40 dB
	= 11.40 dB below Limit

## 7. List of test equipments used for measurements

	Test Equipment	Model	Mfg.	Serial No.	Cal. Date	Cal. Due Date
<input checked="" type="checkbox"/>	EMI Test Receiver	ESVS 10	R&S	835165/001	13.03.18	14.03.18
<input checked="" type="checkbox"/>	Loop Antenna	AL-130	COM-POWER	121025	12.06.14	14.06.14
<input checked="" type="checkbox"/>	LogBicon Antenna	VULB9160	Schwarzbeck	3128	12.02.22	14.02.22
<input checked="" type="checkbox"/>	Horn Antenna	BBHA 9120D	Schwarzbeck	277	13.02.28	15.02.28
<input checked="" type="checkbox"/>	Spectrum Analyzer	E7405A	H.P.	US41160290	12.09.05	13.09.05
<input checked="" type="checkbox"/>	Amplifier	TK-PA18	TESTEK	120020	12.12.15	13.12.15
<input checked="" type="checkbox"/>	PSA Series Spectrum Analyzer	E4440A	Agilent	MY46185482	13.03.18	14.03.18
<input checked="" type="checkbox"/>	Band Reject Filter	WRCGV 2402/2480-2382/2500-52/10SS	Wainwright Instruments GmbH	2	12.09.06	13.09.06
<input checked="" type="checkbox"/>	DC Power Supply	DP30-05A	Toyo Tech	0300266	12.09.06	13.09.06
<input checked="" type="checkbox"/>	Controller	HD2000	HD GmbH	C/125	N/A	N/A
<input checked="" type="checkbox"/>	Antenna Master	MA2400	HD GmbH	N/A	N/A	N/A
<input checked="" type="checkbox"/>	Turn-Table	TT 1.35 SI	SES	-	N/A	N/A
<input checked="" type="checkbox"/>	Antenna Master	AM 4.5	SES	-	N/A	N/A