

FCC CERTIFICATION TEST REPORT

FOR

Applicant	: Globalscale Technologies Inc
Address	: 5F.No.2 Building, Minxing Industrial Park, Minkang Road, Minzhi Street, Baoan District, Shenzhen, Guangdong, China
Equipment under Test	: GuruPlug
Model No	: 003-GP0XXXXXX
Trade Mark	: /
FCC ID	: YCJ003GP1
Manufacturer	: Globalscale Technologies Inc
Address	: 5F.No.2 Building, Minxing Industrial Park, Minkang Road, Minzhi Street, Baoan District, Shenzhen, Guangdong, China

Issued By: Dongguan Dongdian Testing Service Co., Ltd.

Add: No. 17, Zongbu Road 2, Songshan Lake Sci&Tech, Industry Park, Dongguan City, Guangdong Province, China, 523808

Tel: +86-0769-22891499 [Http://www.dgddt.com](http://www.dgddt.com)

REPORT

TABLE OF CONTENTS

	Test report declares.....	4
1.	Summary of test results	5
2.	General test information	6
2.1.	Description of EUT	6
2.2.	Accessories of EUT.....	6
2.3.	Assistant equipment used for test.....	6
2.4.	Block diagram of EUT configuration for test	7
2.5.	Test environment conditions	7
2.6.	Test laboratory.....	7
2.7.	Measurement uncertainty	8
3.	6dB Bandwidth.....	9
3.1.	Test equipment	9
3.2.	Block diagram of test setup	9
3.3.	Limits	9
3.4.	Test Procedure.....	9
3.5.	Test Result.....	9
3.6.	Original test data	10
4.	Maximum Peak Output Power	17
4.1.	Test equipment	17
4.2.	Block diagram of test setup	17
4.3.	Limits	17
4.4.	Test Procedure.....	17
4.5.	Test Result.....	17
4.6.	Original test data	18
5.	Power Spectral Density	23
5.1.	Test equipment	23
5.2.	Block diagram of test setup	23
5.3.	Limits	23
5.4.	Test Procedure.....	23
5.5.	Test Result.....	23
5.6.	Original test data	24
6.	Emissions outside the specified frequency bands	31
6.1.	Test equipment	31
6.2.	Block diagram of test setup	31
6.3.	Limits	31
6.4.	Test Procedure.....	31

- 6.5. Test Result..... 32
- 6.6. Original test data 32
- 7. Emissions in restricted frequency bands 56
 - 7.1. Test equipment 56
 - 7.2. Block diagram of test setup 56
 - 7.3. Limit 58
 - 7.4. Test Procedure..... 59
 - 7.5. Test result 60
- 8. Band Edge Compliance 135
 - 8.1. Test equipment 135
 - 8.2. Block diagram of test setup 135
 - 8.3. Limit 135
 - 8.4. Test Procedure..... 136
 - 8.5. Test result 136
- 9. Power Line Conducted Emission 153
 - 9.1. Test equipment 153
 - 9.2. Block diagram of test setup 153
 - 9.3. Power Line Conducted Emission Limits(Class B)..... 153
 - 9.4. Test Procedure..... 153
 - 9.5. Test Result..... 154
- 10. Antenna Requirements 157
 - 10.1. Limit 157
 - 10.2. Result..... 157
- 11. Test setup photograph 158
- 12. Photos of the EUT 160

TEST REPORT DECLARE

Applicant	:	Globalscale Technologies Inc
Address	:	5F.No.2 Building, Minxing Industrial Park, Minkang Road, Minzhi Street, Baoan District, Shenzhen, Guangdong, China
Equipment under Test	:	GuruPlug
Model No	:	003-GP0XXXXXX
FCC ID	:	YCJ003GP1
Trade Mark	:	/
Manufacturer	:	Globalscale Technologies Inc
Address	:	5F.No.2 Building, Minxing Industrial Park, Minkang Road, Minzhi Street, Baoan District, Shenzhen, Guangdong, China

Test Standard Used: FCC Rules and Regulations Part 15 Subpart C: 2012

Test procedure used: ANSI C63.10:2009; KDB558074 D01 DTS Meas Guidance V03r01 ANSI C63.4:2003

We Declare:

The equipment described above is tested by Dongguan Dongdian Testing Service Co., Ltd and in the configuration tested the equipment complied with the standards specified above. The test results are contained in this test report and Dongguan Dongdian Testing Service Co., Ltd is assumed of full responsibility for the accuracy and completeness of these tests.

After test and evaluation, our opinion is that the equipment provided for test compliance with the requirement of the above FCC standards.

Report No:	DDT-RE130202		
Date of Test:	2013/08/05~2013/08/12	Date of Report:	2013/08/16

Prepared By:



Leo Liu/Engineer

Approved By:



Jam Yu/EMC Manager

Note: This report applies to above tested sample only. This report shall not be reproduced in parts without written approval of Dongguan Dongdian Testing Service Co., Ltd.

1. Summary of test results

The EUT have been tested according to the applicable standards as referenced below.		
Description of Test Item	Standard	Results
6dB Bandwidth	FCC Part 15: 15.247 KDB558074	PASS
Peak Output Power	FCC Part 15: 15.247 KDB558074	PASS
Power Spectral Density	FCC Part 15: 15.247 KDB558074	PASS
Emissions outside the specified frequency bands	FCC Part 15: 15.247 KDB558074	PASS
Emissions in restricted frequency bands	FCC Part 15: 15.209 FCC Part 15: 15.247 ANSI C63.4:2003; ANSI C63.10:2009 KDB558074	PASS
Band Edge Compliance	FCC Part 15: 15.209 FCC Part 15: 15.247 ANSI C63.4:2003; ANSI C63.10:2009 KDB558074	PASS
Power Line Conducted Emission	FCC Part 15: 15.207 ANSI C63.4:2003; ANSI C63.10:2009	PASS
Antenna requirement	FCC Part 15: 15.203	PASS

2. General test information

2.1. Description of EUT

EUT* Name	:	GuruPlug
Model Number	:	003-GP0XXXXXXX
Difference of Model number	:	“XXXXXX” Represent the different sales regions, Plug and accessories, “X” represent the numbers 1 to 9
EUT function description	:	Please reference user manual of this device
Power supply	:	AC100-240V
FCC ID	:	YCJ003GP1
Radio Technology	:	IEEE802.11b/g/n
FCC Operation frequency	:	IEEE 802.11b: 2412MHz—2462MHz IEEE 802.11g: 2412MHz—2462MHz IEEE 802.11n HT20: 2412MHz—2462MHz IEEE 802.11n HT40: 2422MHz—2452MHz
Modulation	:	IEEE 802.11b: DSSS(CCK,DQPSK,DBPSK) IEEE 802.11g: OFDM(64QAM, 16QAM, QPSK, BPSK) IEEE 802.11n HT20, HT40: OFDM (64QAM, 16QAM, QPSK,BPSK)
Antenna Type	:	Integrated Patch Antenna, 0dBi maximum gain
Date of Receipt	:	2012/08/03
Sample Type	:	Series production

Note1: EUT is the ab.of equipment under test.

2.2. Accessories of EUT

Description of Accessories	Manufacturer	Model number or Type	Serial No.	Other
/	/	/	/	/

2.3. Assistant equipment used for test

Description of Assistant equipment	Manufacturer	Model number or Type	Other	
HP Pro 3330 Small From Factor (PC)	HP	A6T13PA#AB2	1.5m long, unshielded	FCC DOC
LCD COLOR DISPLAY	HP	GV537A	AC Line: 1.5m long, unshielded VGA line: 1.5m long, unshielded	FCC DOC
Keyboard	HP	KB-0316	Signal line: 1.5m long, unshielded	FCC DOC
Mouse	HP	M-SBF96	Signal line: 1.5m long, unshielded	FCC DOC
Router	TP-LINK	TL-WR842N	/	FCC DOC

2.4. Block diagram of EUT configuration for test

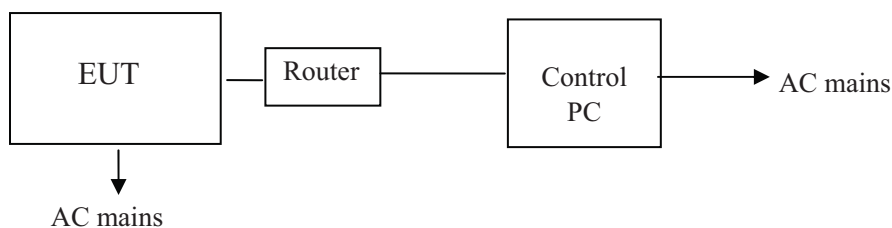

EUT was connected to control PC by LAN cable and router, control PC run “putty_xp.exe” test software and special command provided by manufacturer to control EUT work in Continuous TX mode (>98% duty cycle), and select test channel, wireless mode and data rate.

Tested mode, channel, and data rate information			
Mode	data rate (Mbps) (see Note)	Channel	Frequency (MHz)
IEEE 802.11b	11	Low :CH1	2412
	11	Middle: CH6	2437
	11	High: CH11	2462
IEEE 802.11g	6	Low :CH1	2412
	6	Middle: CH6	2437
	6	High: CH11	2462
IEEE 802.11n HT20	MCS 0	Low :CH1	2412
	MCS 0	Middle: CH6	2437
	MCS 0	High: CH11	2462
IEEE 802.11n HT40	MCS 0	Low :CH3	2422
	MCS 0	Middle: CH6	2437
	MCS 0	High: CH9	2452

Note: According exploratory test, EUT will have maximum output power in those data rate, so those data rate were used for all test.

2.5. Test environment conditions

During the measurement the environmental conditions were within the listed ranges:

Temperature range:	21-25°C
Humidity range:	40-75%
Pressure range:	86-106kPa

2.6. Test laboratory

Dongguan Dongdian Testing Service Co., Ltd

Add: No. 17, Zongbu Road 2, Songshan Lake Sci&Tech, Industry Park, Dongguan City, Guangdong Province, China, 523808 Tel: +86-0769-22891499 <http://www.dgddt.com>

FCC Registration Number: 270092 Industry Canada site registration number: 10288A-1

2.7. Measurement uncertainty

Test Item	Uncertainty
Occupied Channel Bandwidth	±1%
Uncertainty for radio frequency	1×10^{-9}
RF Output power, conducted	±0.6dB
Power Spectral Density, Conducted	±1.2dB
Unwanted Emissions, Conducted	±0.6dB
Temperature	±0.2 °C
Humidity	±1%
DC and Low frequency voltage	±0.5%
Time	±1%
Duty Cycle	±1%
Uncertainty for Radiation Emission test (30MHz-1GHz)	3.14 dB (Polarize: V)
	3.16 dB (Polarize: H)
Uncertainty for Radiation Emission test (1GHz to 25GHz)	2.08dB(Polarize: V)
	2.56dB (Polarize: H)
Uncertainty for Conduction emission test(150KHz-30MHz)	2.44dB
Uncertainty for Radiation Emission test (9KHz-150KHz)	3.89dB
Uncertainty for Radiation Emission test (150KHz-30MHz)	3.21dB

Note: This uncertainty represents an expanded uncertainty expressed at approximately the 95% confidence level using a coverage factor of $k=2$.

3. 6dB Bandwidth

3.1. Test equipment

Item	Equipment	Manufacturer	Model No.	Serial No.	Last Cal.	Cal. Interval
1	Spectrum analyzer	R&S	FSU	1166.1660.26	2012/11/26	1 Year
2	Attenuator	Mini-Circuits	BW-S10W2	101109	2012/11/26	1 Year
3	RF Cable	Micable	C10-01-01-1	100309	2012/11/26	1 Year

3.2. Block diagram of test setup

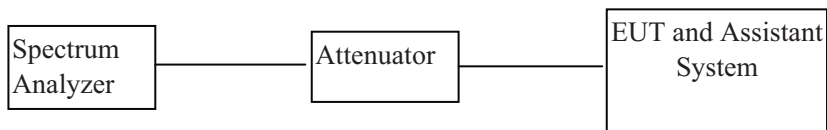

3.3. Limits

For direct sequence systems, the minimum 6dB bandwidth shall be at least 500 KHz

3.4. Test Procedure

- (1) Configure EUT and assistant system according clause 2.4 and 3.2
- (2) Connect EUT's antenna output to spectrum analyzer by RF cable.
- (3) Configure EUT work in test mode as stated in clause 2.4.
- (4) Set the spectrum analyzer as follows:

RBW:	100KHz
VBW:	300KHz
Detector Mode:	Peak
Sweep time:	auto
Trace mode	Max hold

- (5) Allow the trace to stabilize, measure the maximum width of the emission that is constrained by the frequencies associated with the two outermost amplitude points (upper and lower frequencies) that are attenuated by 6 dB relative to the maximum level measured in the fundamental emission.

3.5. Test Result

EUT: GuruPlug M/N: 003-GP0XXXXXX					
EUT Set Mode	CH or Frequency	Result (MHz)	EUT Set Mode	CH or Frequency	Result (MHz)
11b	CH1	10.016	11n HT 20	CH1	17.708
	CH6	10.096		CH6	17.708
	CH11	10.176		CH11	17.706
11g	CH1	16.506	11n HT 40	CH3	36.67

	CH6	16.506		CH6	36.67
	CH11	16.504		CH9	36.67
Limit: >500KHz			Conclusion: PASS		
Test Date : 2013-08-07			Test Engineer : Leo Liu		

3.6. Original test data

11b:

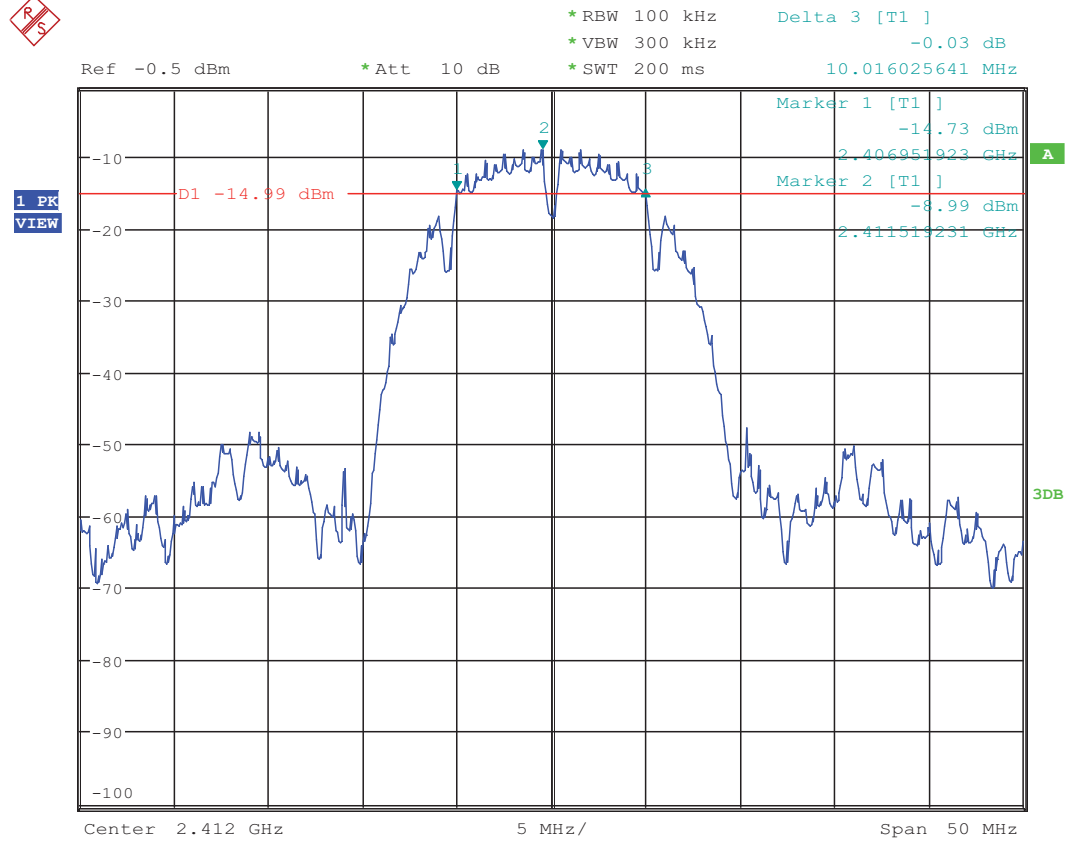

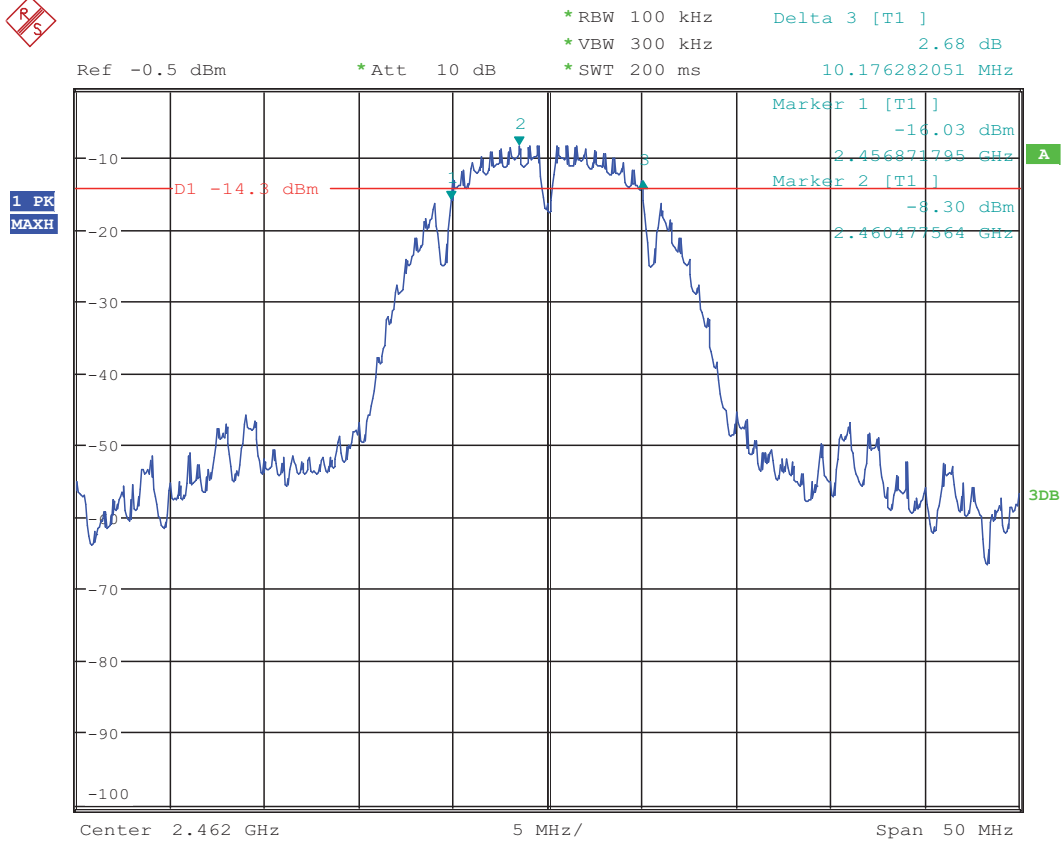
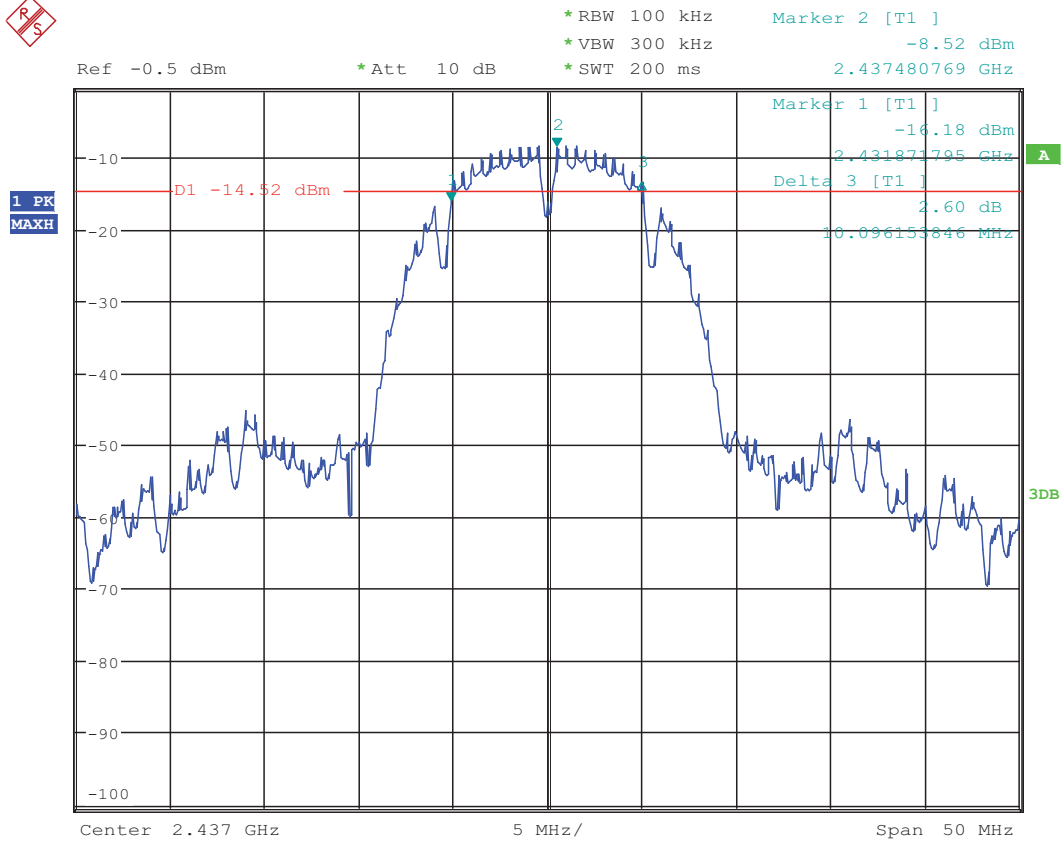

11g:

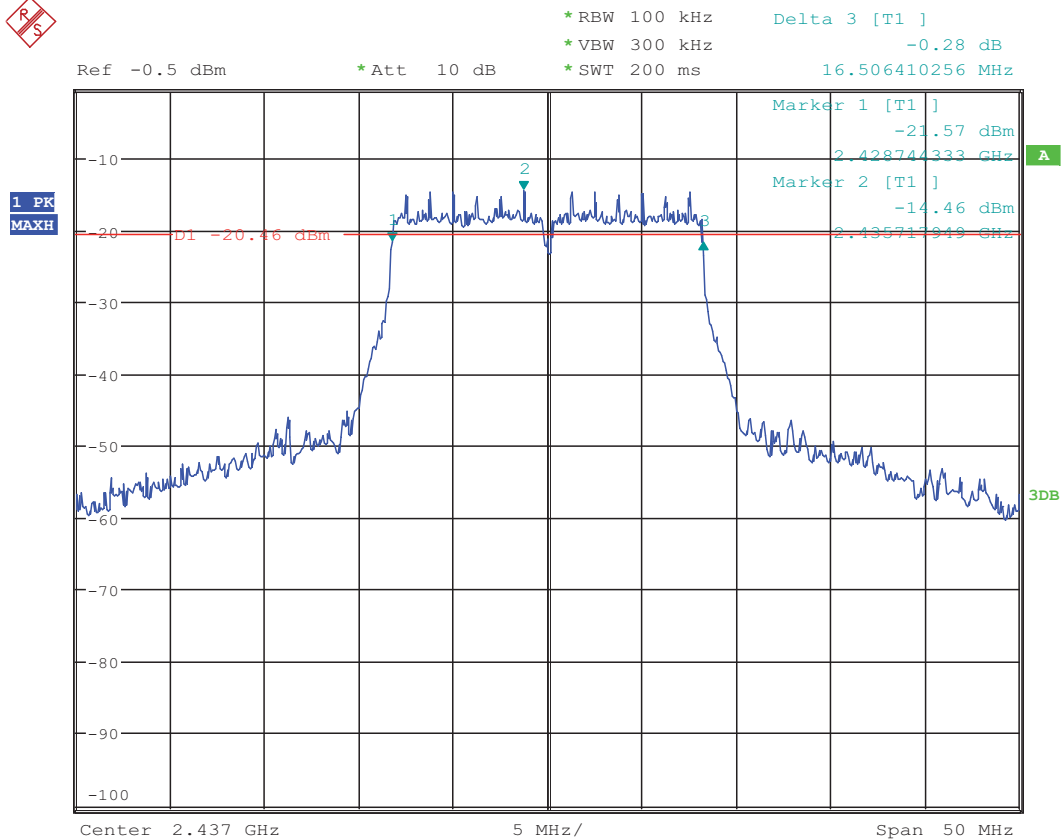
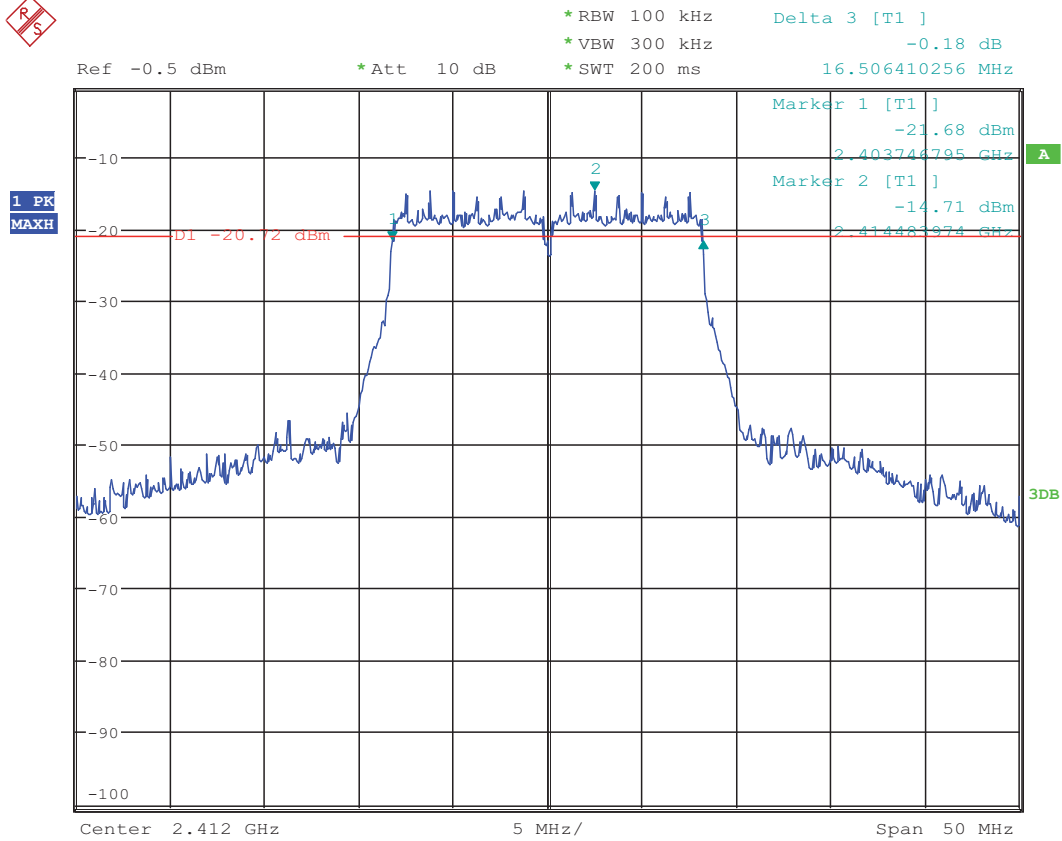

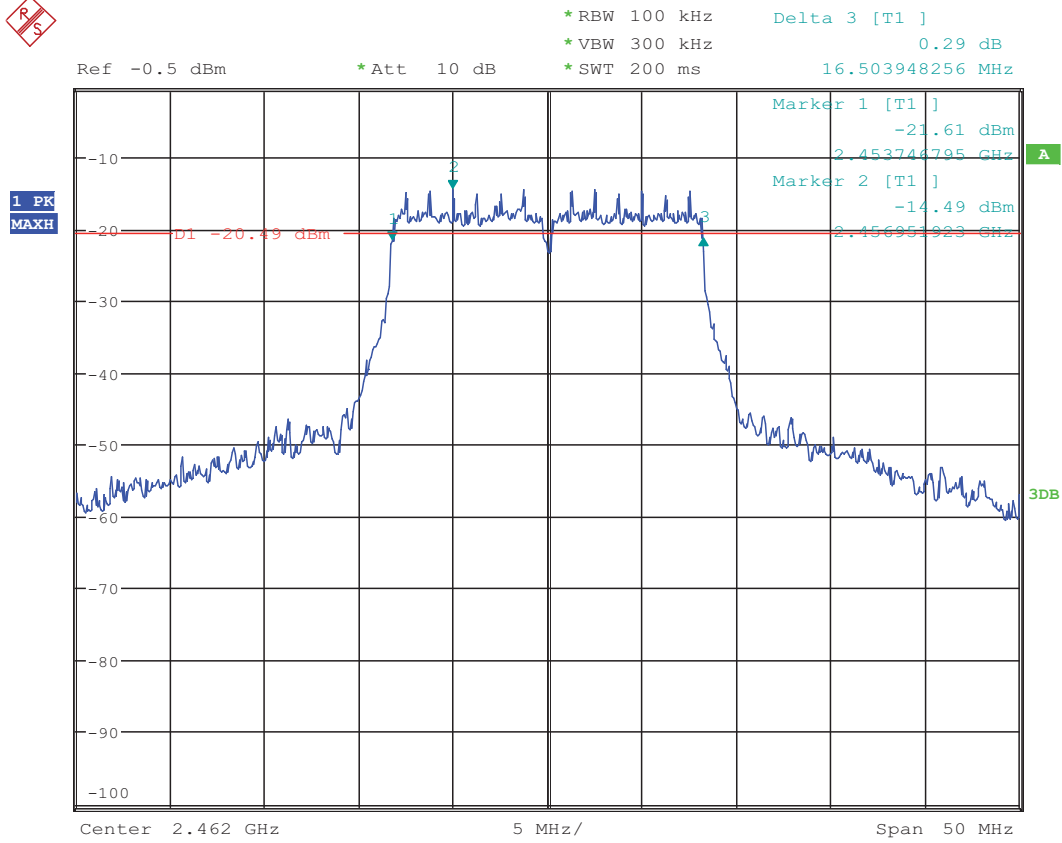

11n HT20:

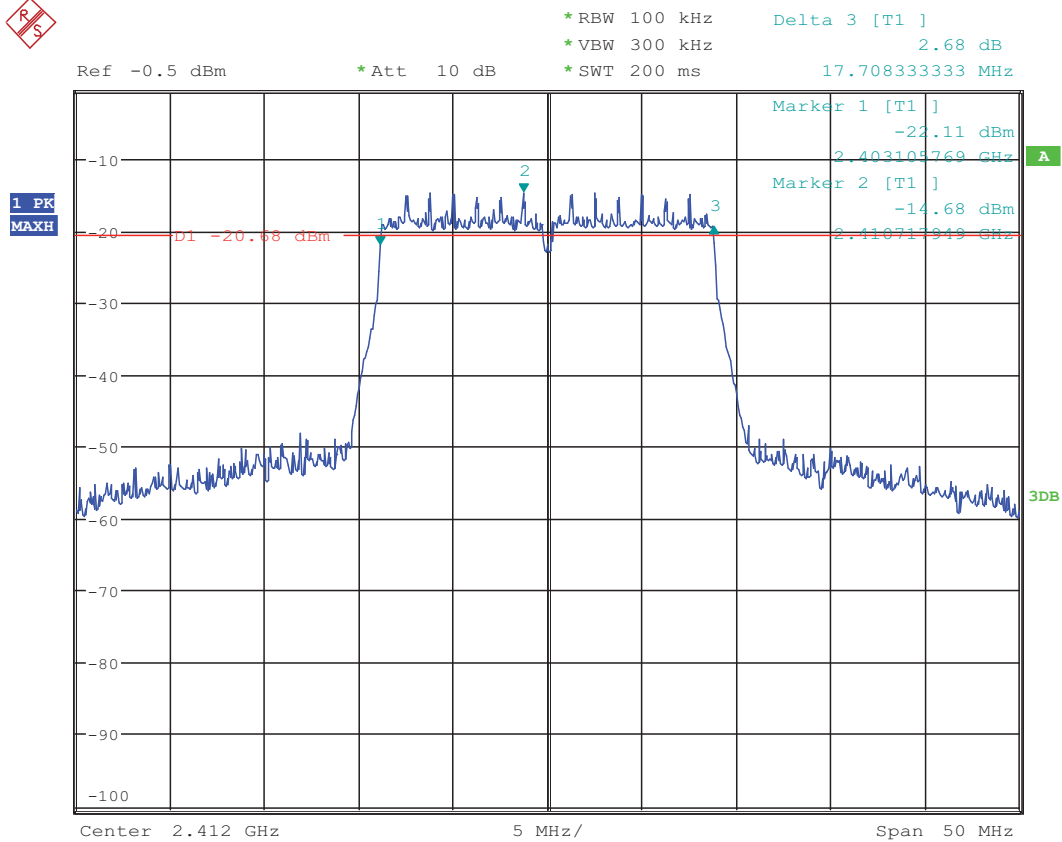

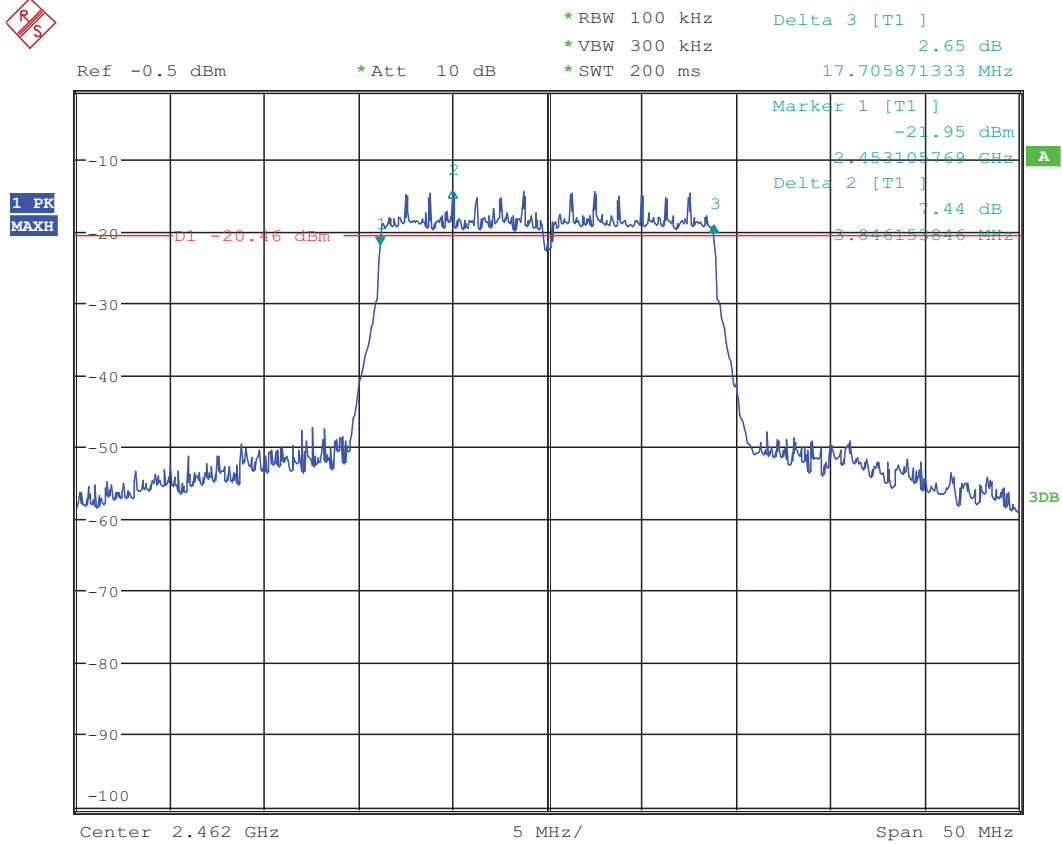
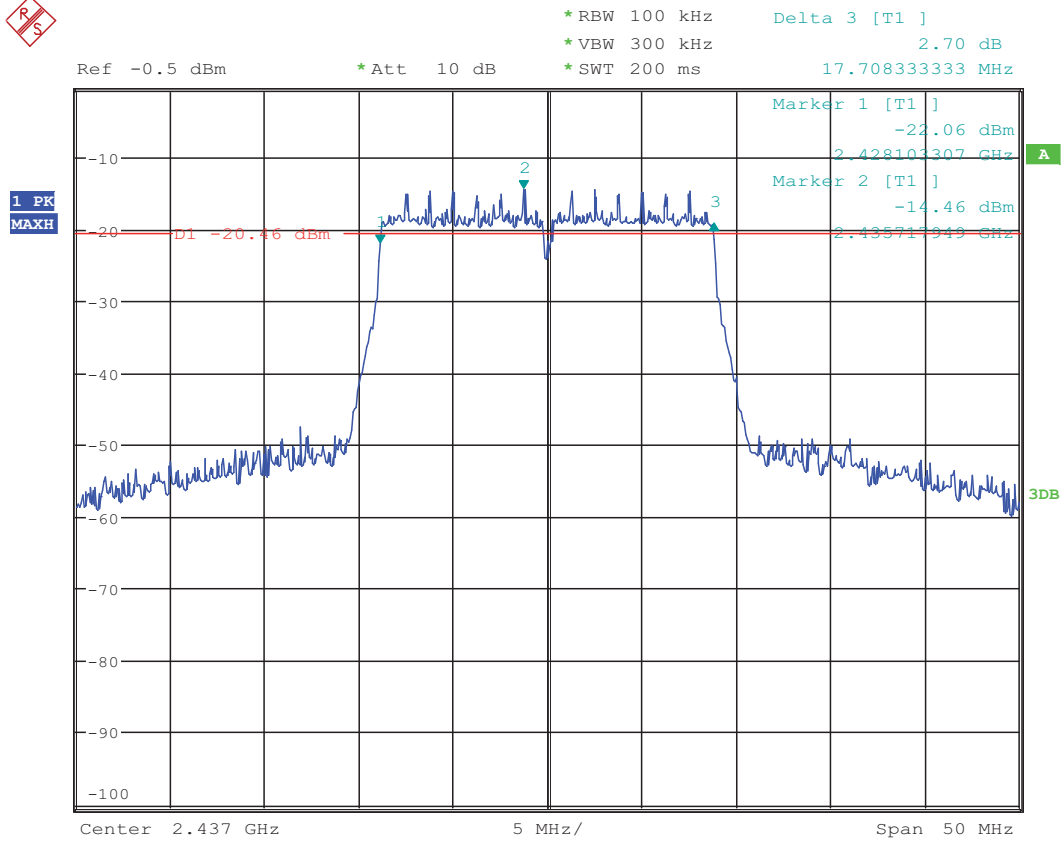

11n HT40:

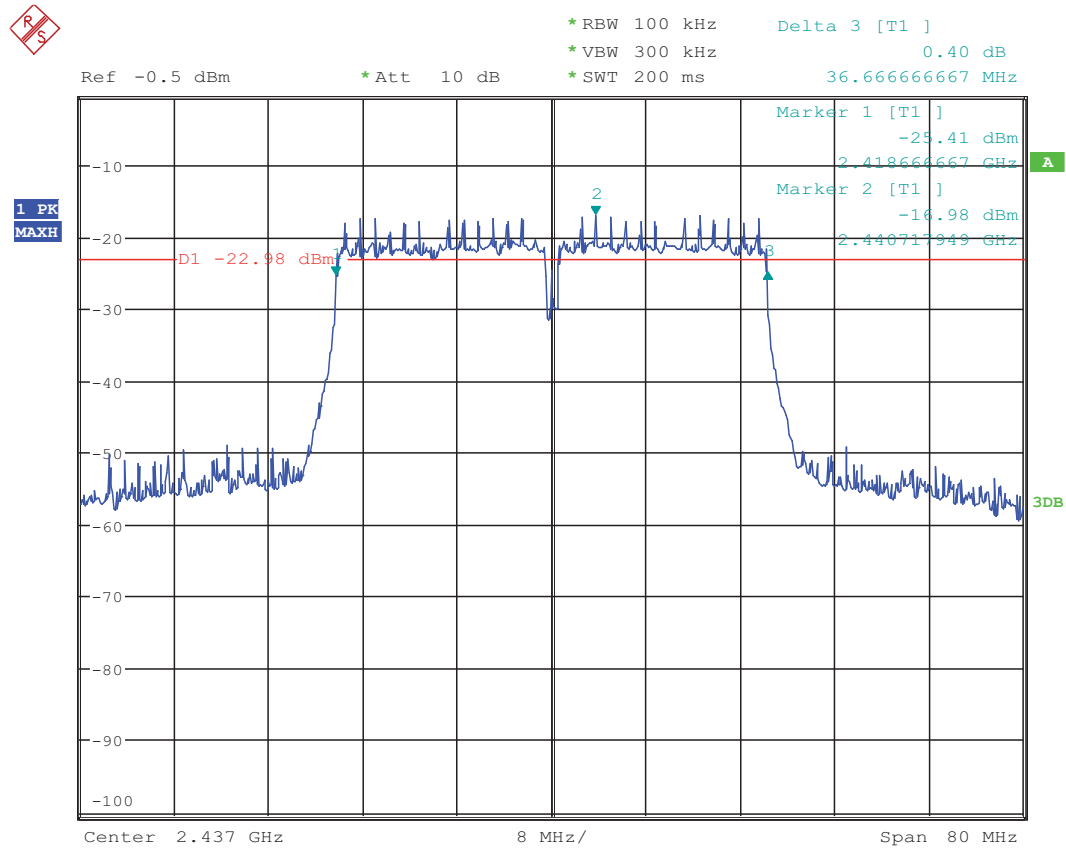
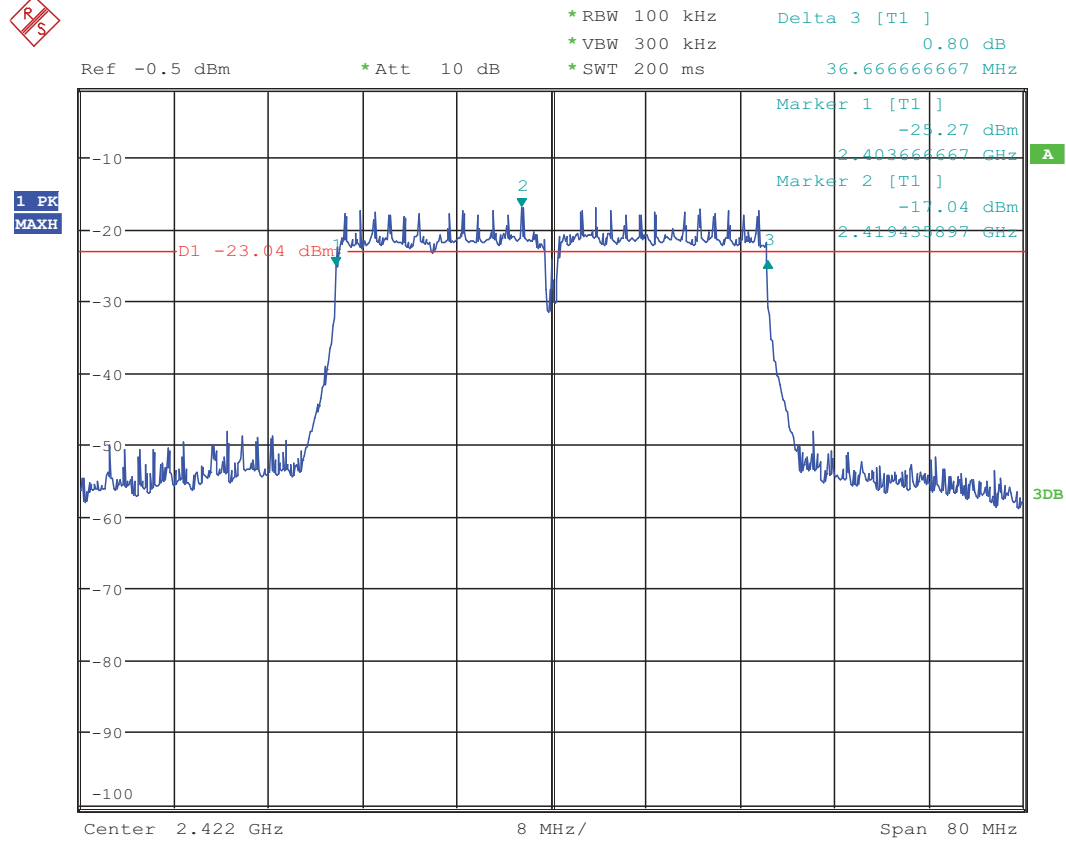



1 PK
MAXH

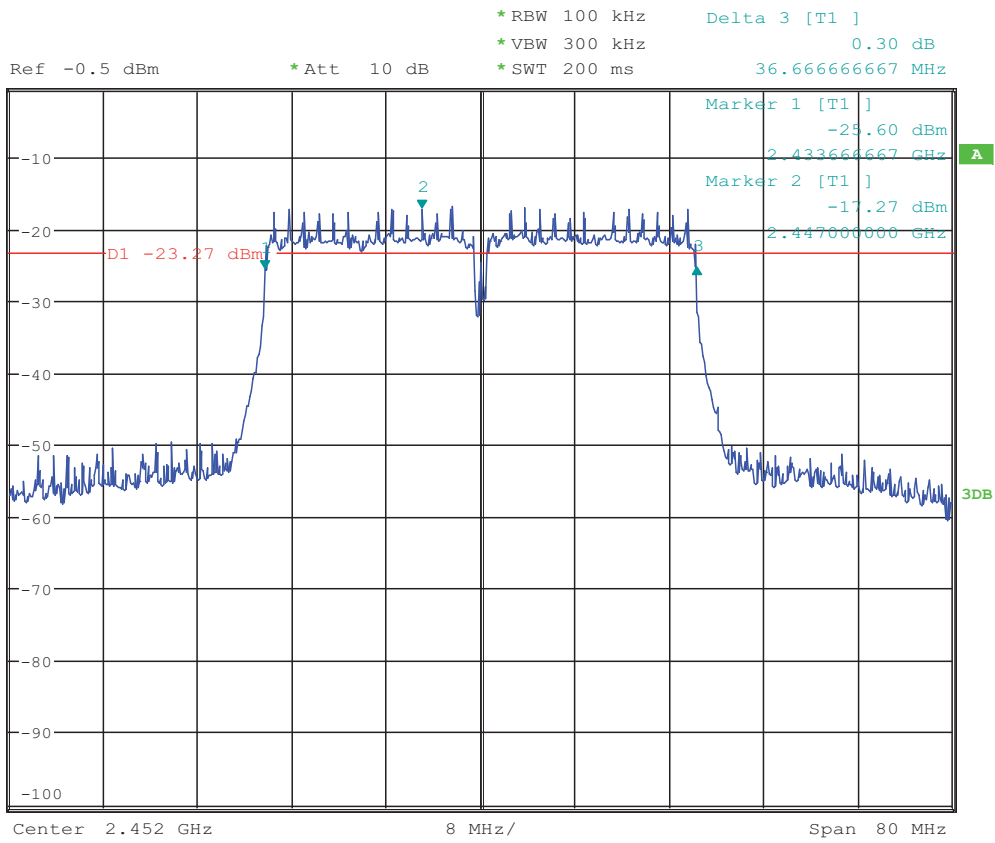

4. Maximum Peak Output Power

4.1. Test equipment

Same with 3.1

4.2. Block diagram of test setup

Same with 3.2

4.3. Limits

For systems using digital modulation in the 902-928 MHz, 2400-2483.5 MHz, and 5725-5850 MHz bands: 1 Watt. If transmitting antennas of directional gain greater than 6 dBi are used, the conducted output power from the intentional radiator shall be reduced below the stated values as appropriate, by the amount in dB that the directional gain of the antenna exceeds 6 dBi.

4.4. Test Procedure

- (1) Configure EUT and assistant system according clause 2.4 and 3.2
- (2) Connect EUT's antenna output to spectrum analyzer by RF cable.
- (3) Configure EUT work in test mode as stated in clause 2.4.
- (4) Set the spectrum analyzer as follows:

RBW:	1MHz
VBW:	3MHz
Span	>1.5x 6dB bandwidth
Detector Mode:	Peak
Sweep time:	auto
Trace mode	Max hold

- (5) Allow the trace to stabilize, Use the instrument's band/channel power measurement function with the band limits set equal to the DTS bandwidth edges measure out the Average and PK output power.

4.5. Test Result

EUT: GuruPlug M/N: 003-GP0XXXXXX				
EUT Set Mode	Soft power set	Data Rate (Mbps)	CH	Result(dBm)
				Peak
11b	18	11	CH1	18.69
			CH6	18.72
			CH11	18.51
11g	13	6	CH1	15.46
			CH6	15.66

11n HT20	13	MCS 0	CH11	15.40
			CH1	15.64
			CH6	15.85
			CH11	15.71
11n HT40	13	MCS0	CH3	15.48
			CH6	15.50
			CH9	15.58
Limit: 30dBm (PK power)			Conclusion: PASS	
Test Date : 2013-08-07			Test Engineer : Leo Liu	

4.6. Original test data

11b CH1:

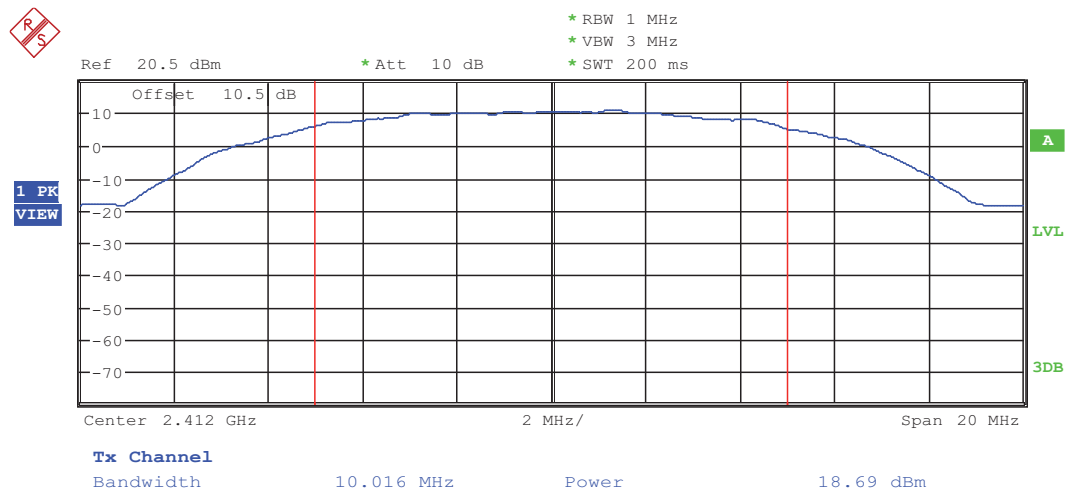

11b CH6:

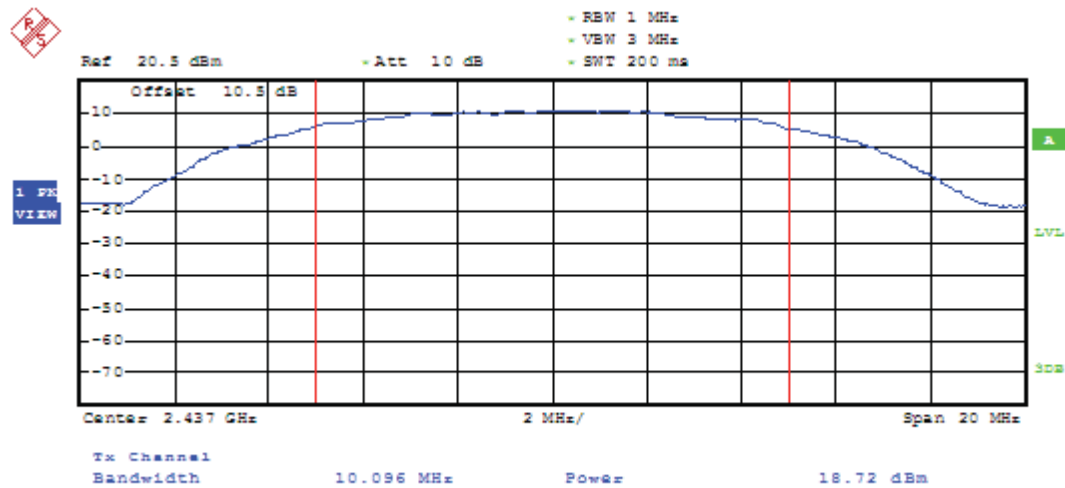

11b CH11:

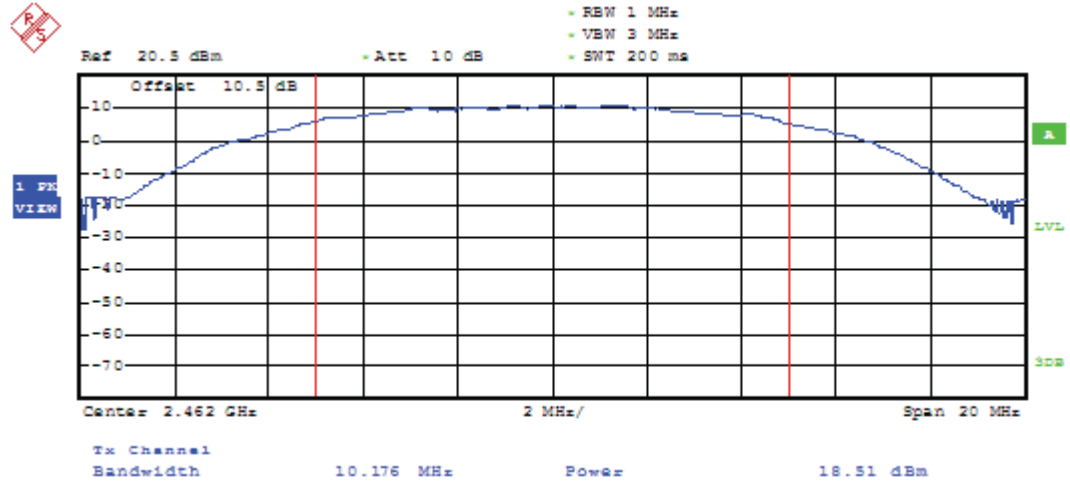

11g CH1:

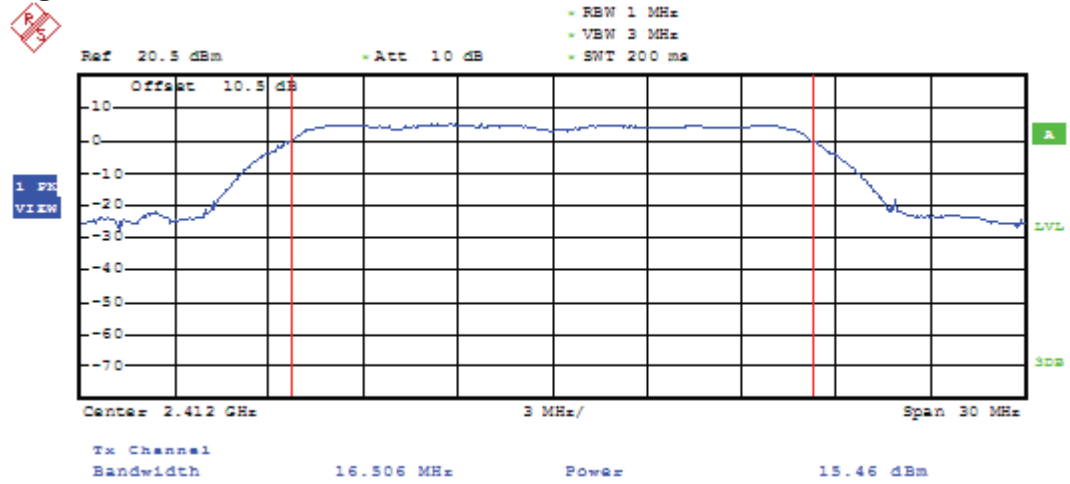

11g CH6:

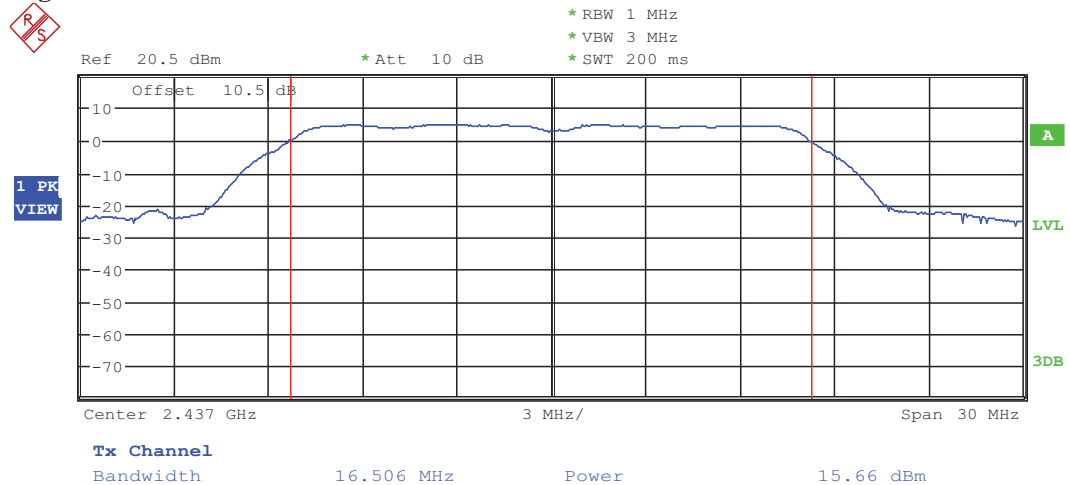

11g CH11:

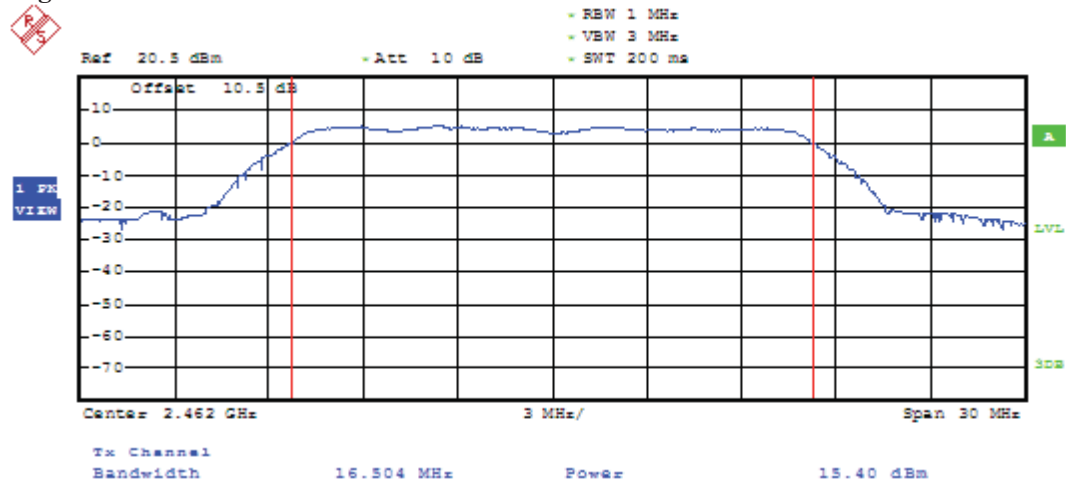

11n HT20 CH1:

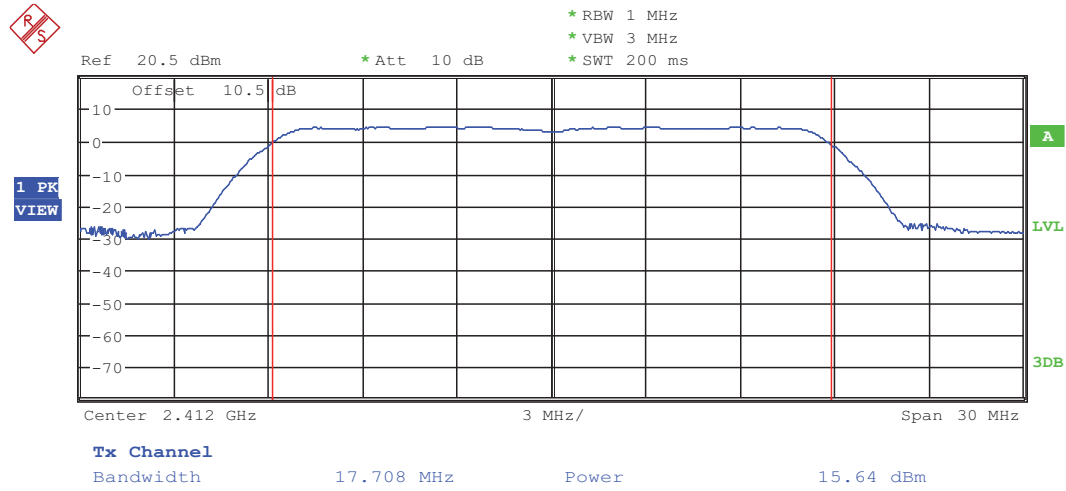

11n HT20 CH6:

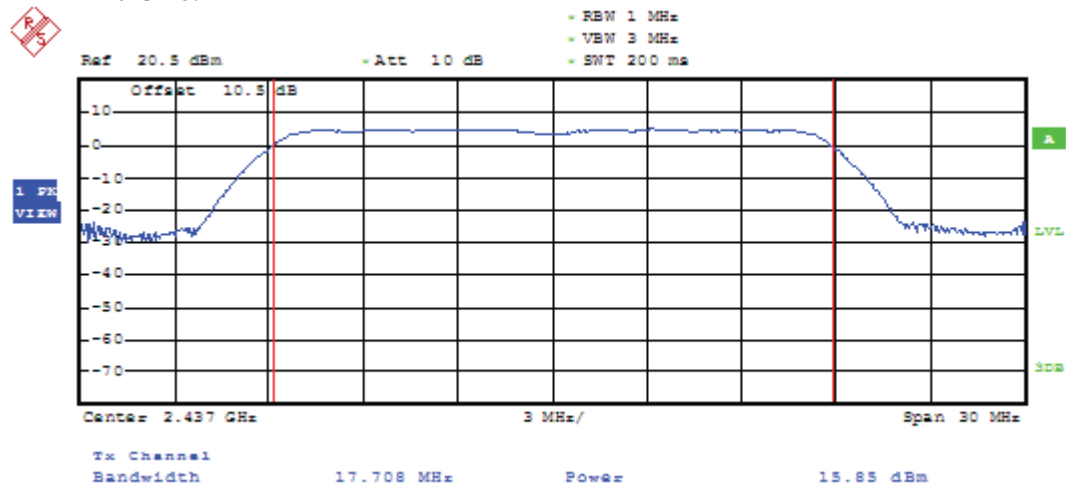

11n HT20 CH11:

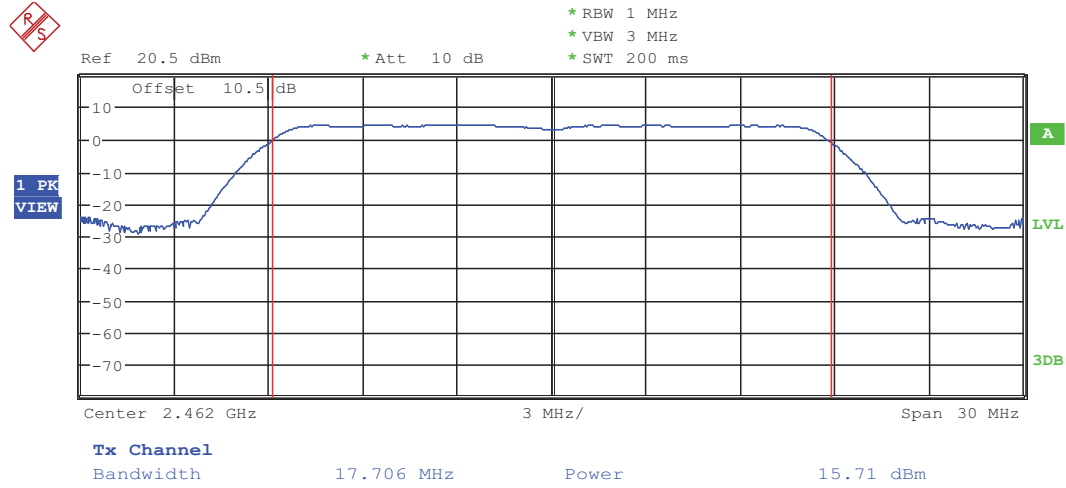

11n HT40 CH3:

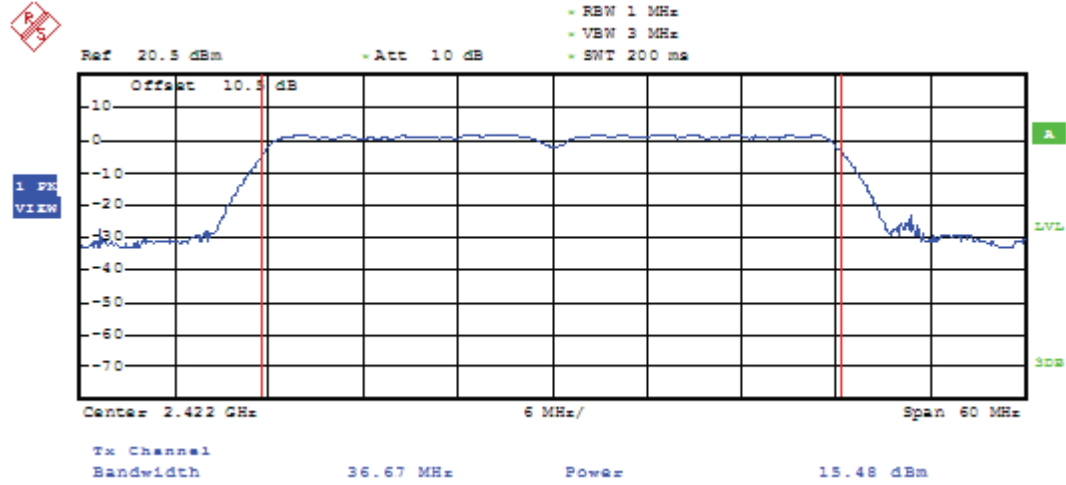

11n HT40 CH6

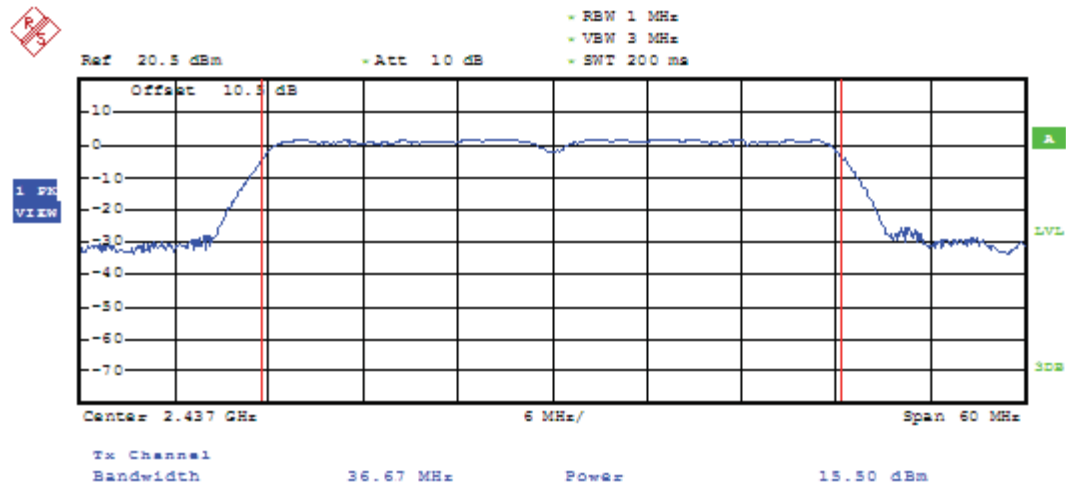

11n HT40 CH9

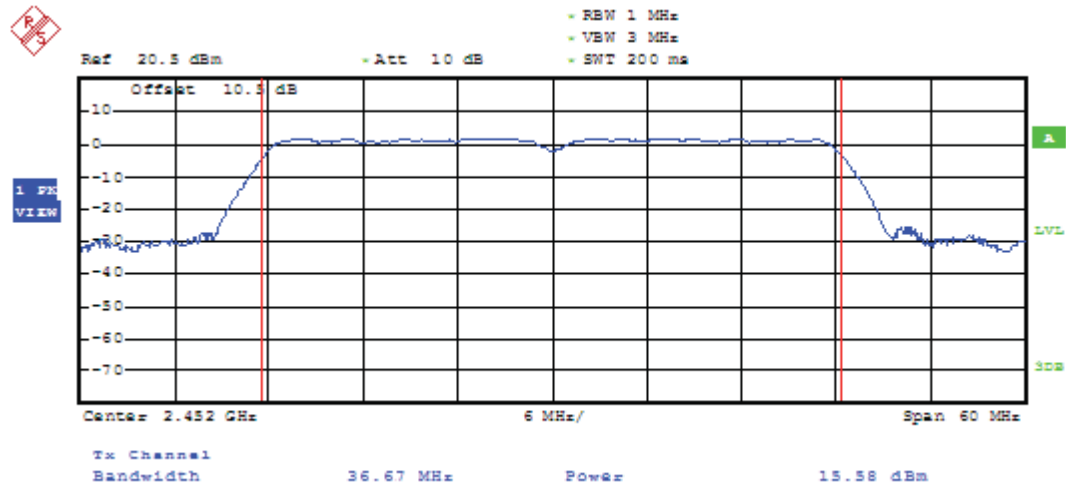

5. Power Spectral Density

5.1. Test equipment

Same with 3.1

5.2. Block diagram of test setup

Same with 3.2

5.3. Limits

For digitally modulated systems, the power spectral density conducted from the intentional radiator to the antenna shall not be greater than 8dBm in any 3 kHz band during any time interval of continuous transmission.

5.4. Test Procedure

- (1) Configure EUT and assistant system according clause 2.4 and 5.2
- (2) Connect EUT's antenna output to spectrum analyzer by RF cable.
- (3) Configure EUT work in test mode as stated in clause 2.4.
- (4) Set the spectrum analyzer as follows:

Center frequency	DTS Channel center frequency
RBW:	$3 \text{ kHz} \leq \text{RBW} \leq 100 \text{ kHz}$
VBW:	$\geq 3\text{RBW}$
Span	1.5times the DTS bandwidth
Detector Mode:	Peak
Sweep time:	auto
Trace mode	Max hold

- (5) Allow the trace to stabilize, use the peak marker function to determine the maximum amplitude level within the RBW.
- (6) If measured value exceeds limit, reduce RBW (no less than 3 kHz) and repeat.

5.5. Test Result

EUT: GuruPlug M/N: 003-GP0XXXXXX					
EUT Set Mode	CH or Frequency	Result	EUT Set Mode	CH or Frequency	Result
11b	CH1	0.4dBm	11n HT 20	CH1	-7.79dBm
	CH6	-0.25dBm		CH6	-7.26dBm

	CH11	-0.72dBm		CH11	-8.43dBm
11g	CH1	-7.47dBm	11n HT 40	CH3	-11.24dBm
	CH6	-7.52dBm		CH6	-11.24dBm
	CH11	-6.61dBm		CH9	-11.54dBm
Limit: <8dBm/3KHz			Conclusion: PASS		
Test Date : 2013-08-07			Test Engineer : Leo Liu		

5.6. Original test data

11b:

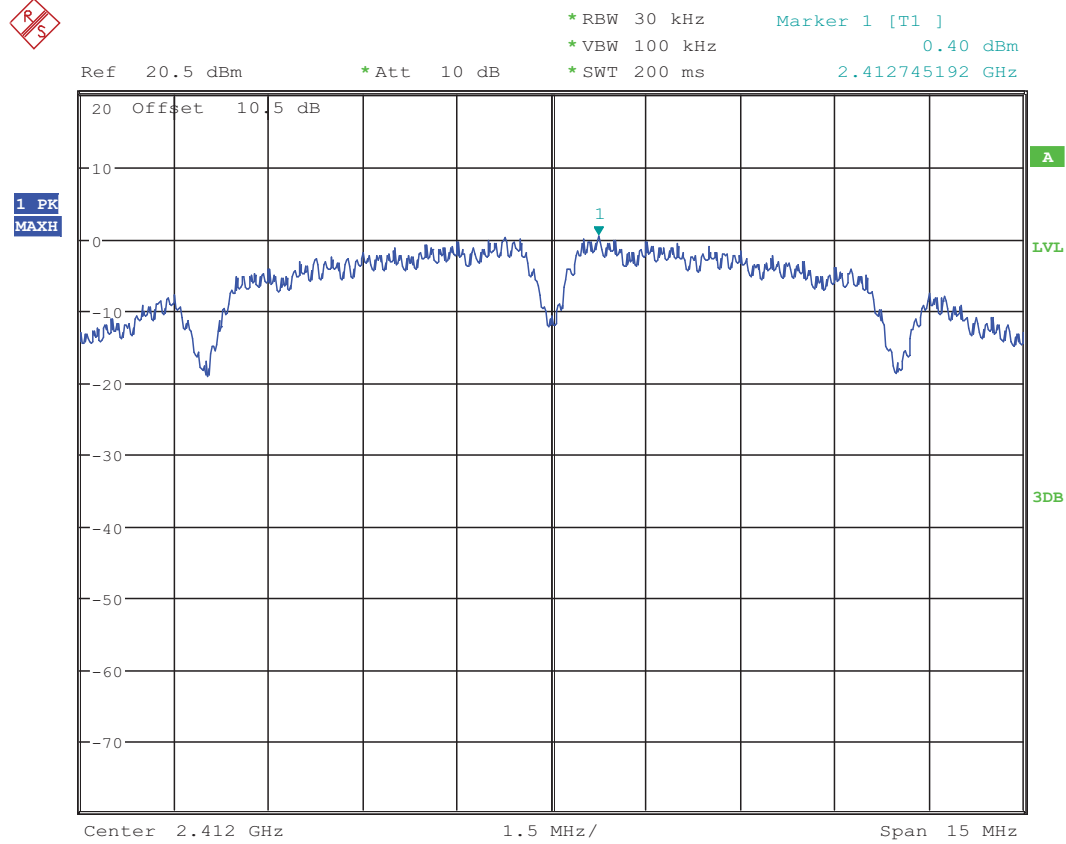



Ref 20.5 dBm *Att 10 dB *RBW 30 kHz Marker 1 [T1]
*VBW 100 kHz -0.25 dBm
*SWT 200 ms 2.436495192 GHz

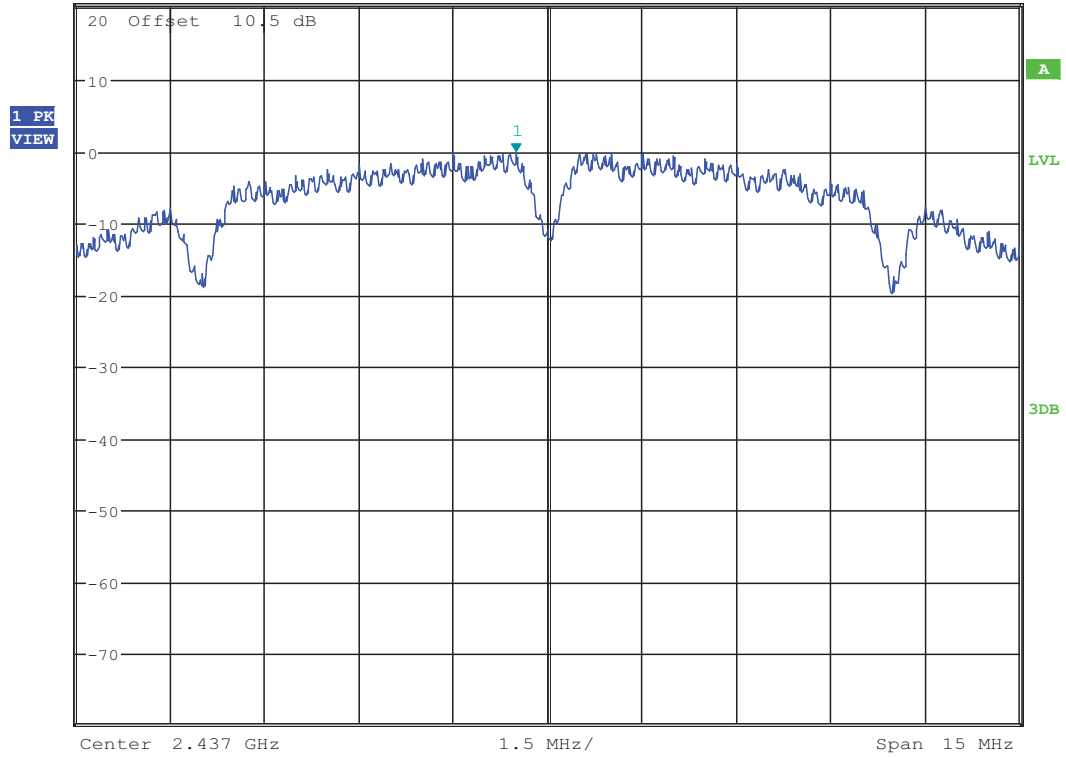

Ref 20.5 dBm *Att 10 dB *RBW 30 kHz Marker 1 [T1]
*VBW 100 kHz -0.72 dBm
*SWT 200 ms 2.463009615 GHz

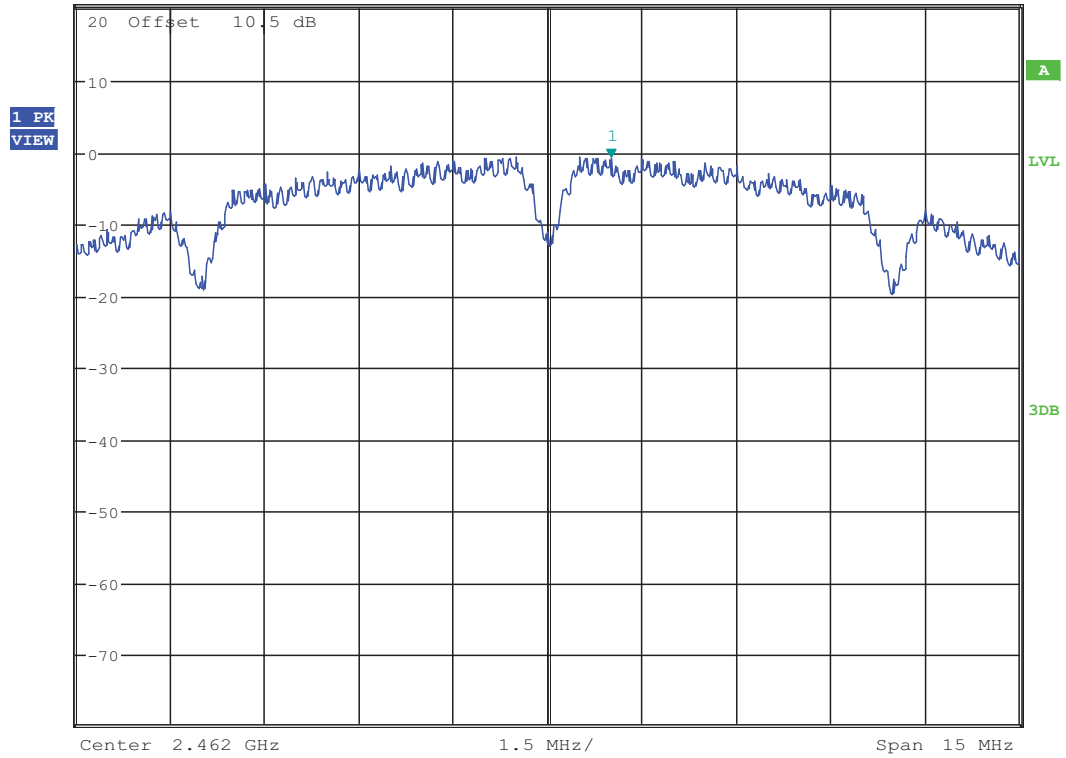

11g:



Ref 20.5 dBm *Att 10 dB *RBW 30 kHz Marker 1 [T1]
*VBW 100 kHz -6.61 dBm
*SWT 200 ms 2.464483974 GHz

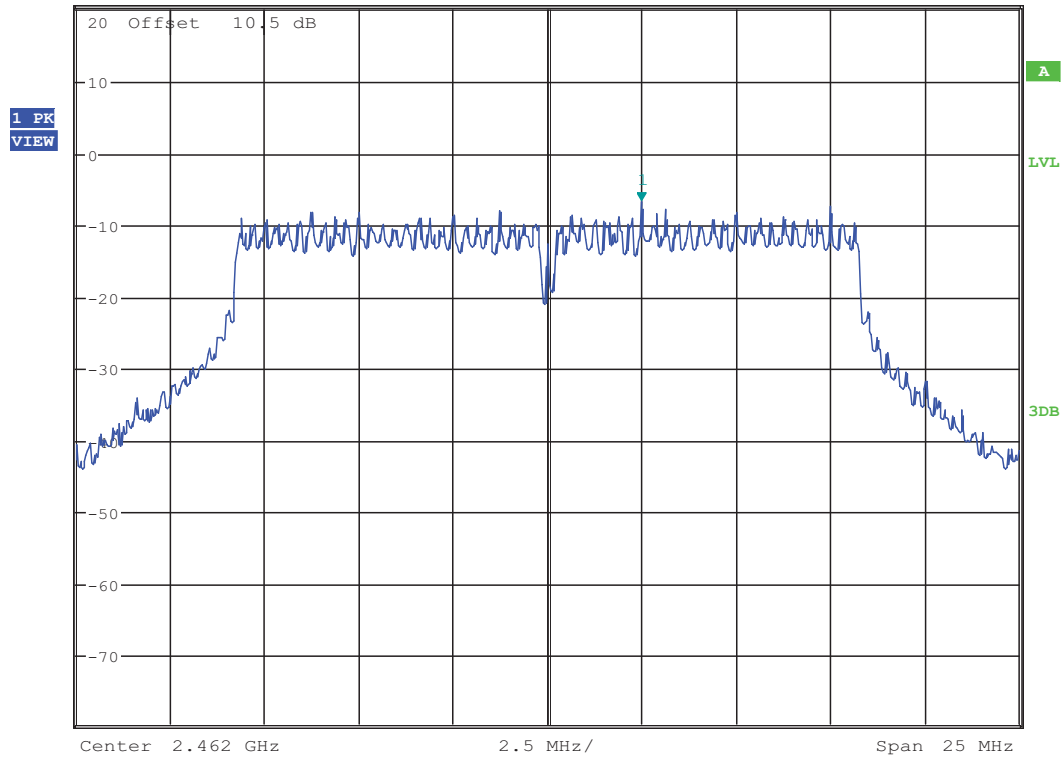

Ref 20.5 dBm *Att 10 dB *RBW 30 kHz Marker 1 [T1]
*VBW 100 kHz -7.47 dBm
*SWT 200 ms 2.414483974 GHz

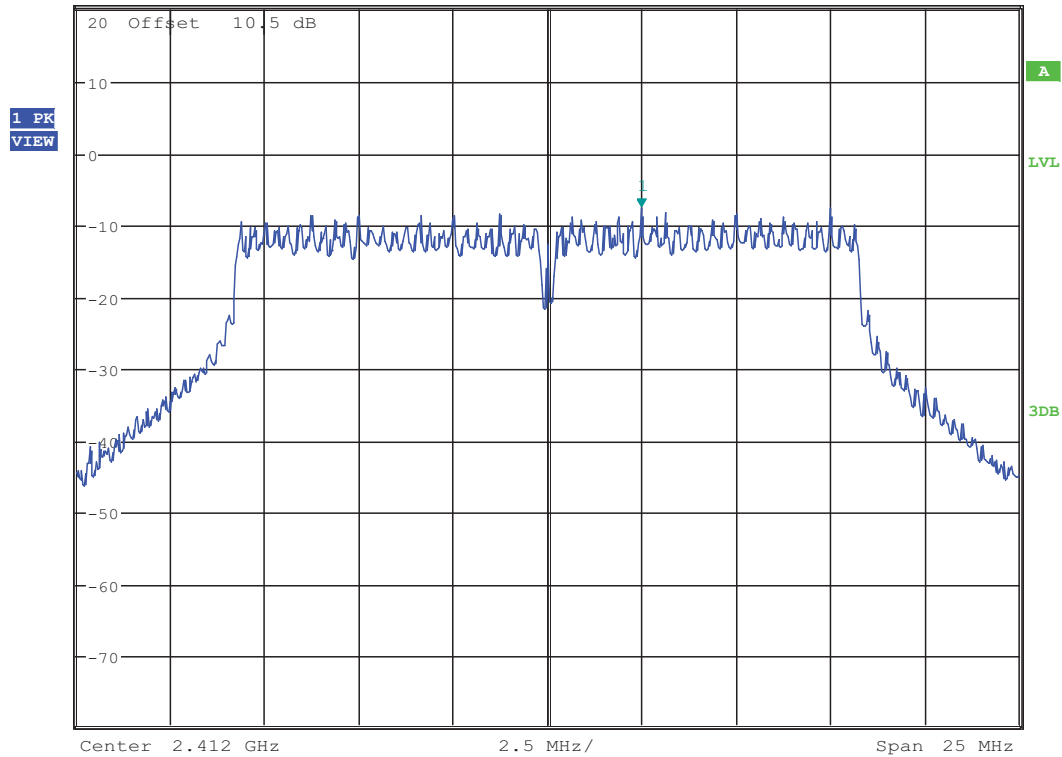



Ref 20.5 dBm *Att 10 dB *RBW 30 kHz Marker 1 [T1]
*VBW 100 kHz -7.52 dBm
*SWT 200 ms 2.439483974 GHz

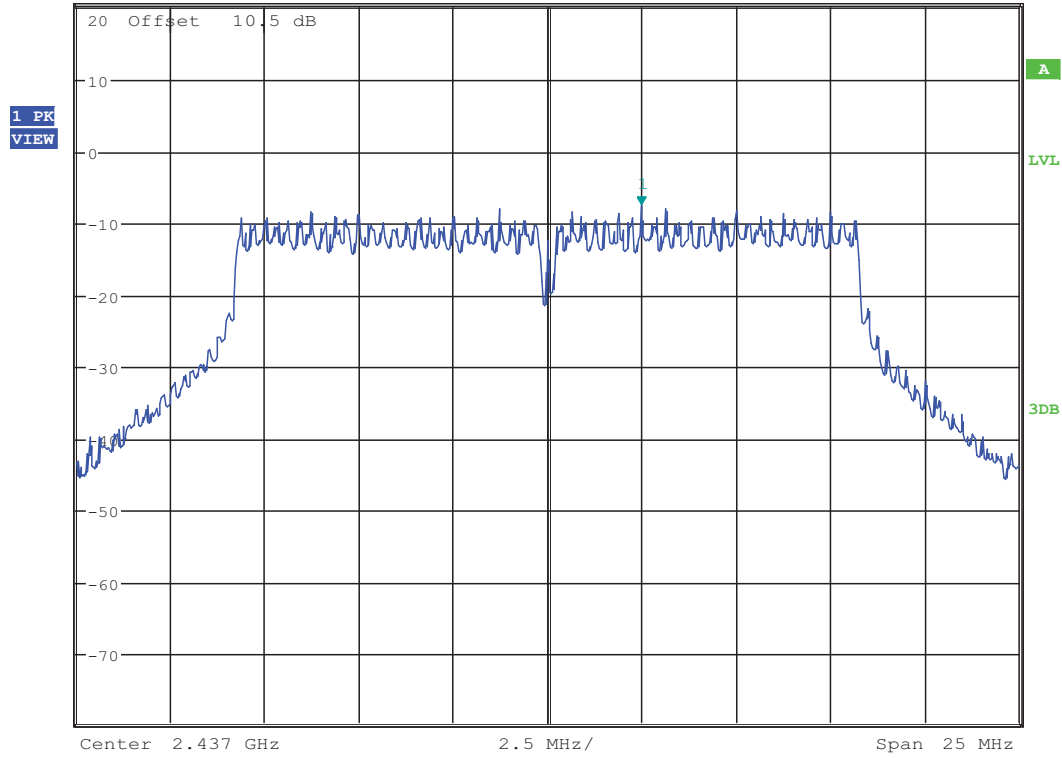

11n HT20:



Ref 20.5 dBm *Att 10 dB *RBW 30 kHz Marker 1 [T1]
*VBW 100 kHz -8.43 dBm
*SWT 200 ms 2.458233974 GHz

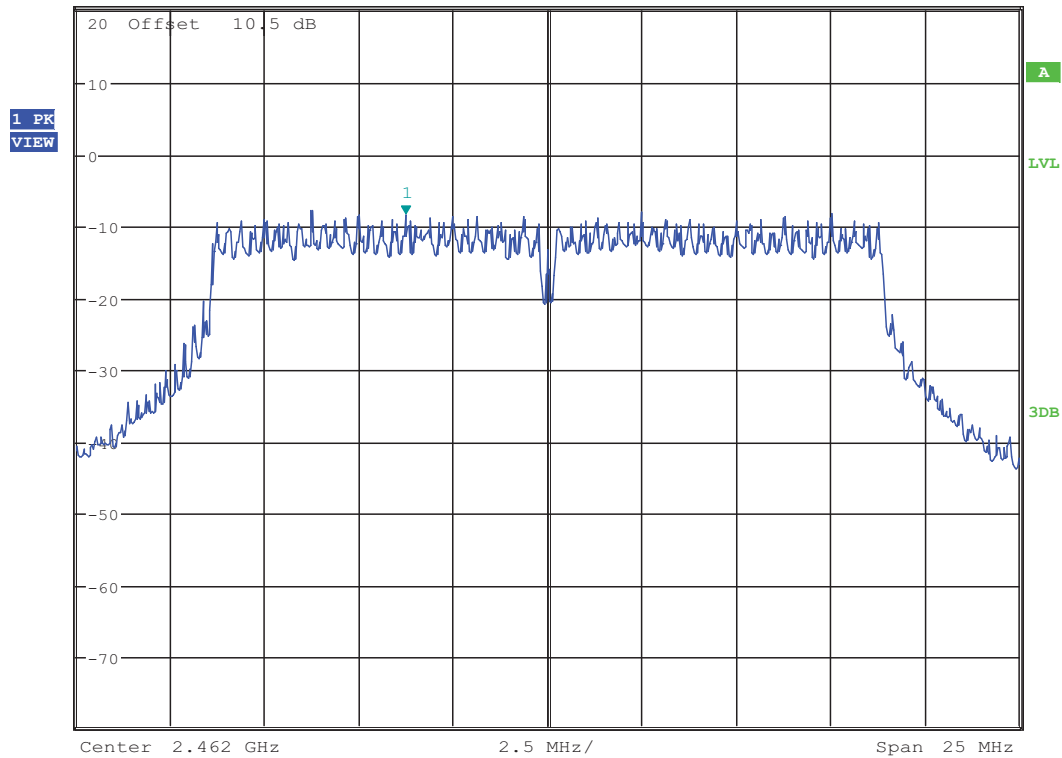



Ref 20.5 dBm *Att 10 dB *RBW 30 kHz Marker 1 [T1]
*VBW 100 kHz -7.26 dBm
*SWT 200 ms 2.444491987 GHz

1 PK
VIEW

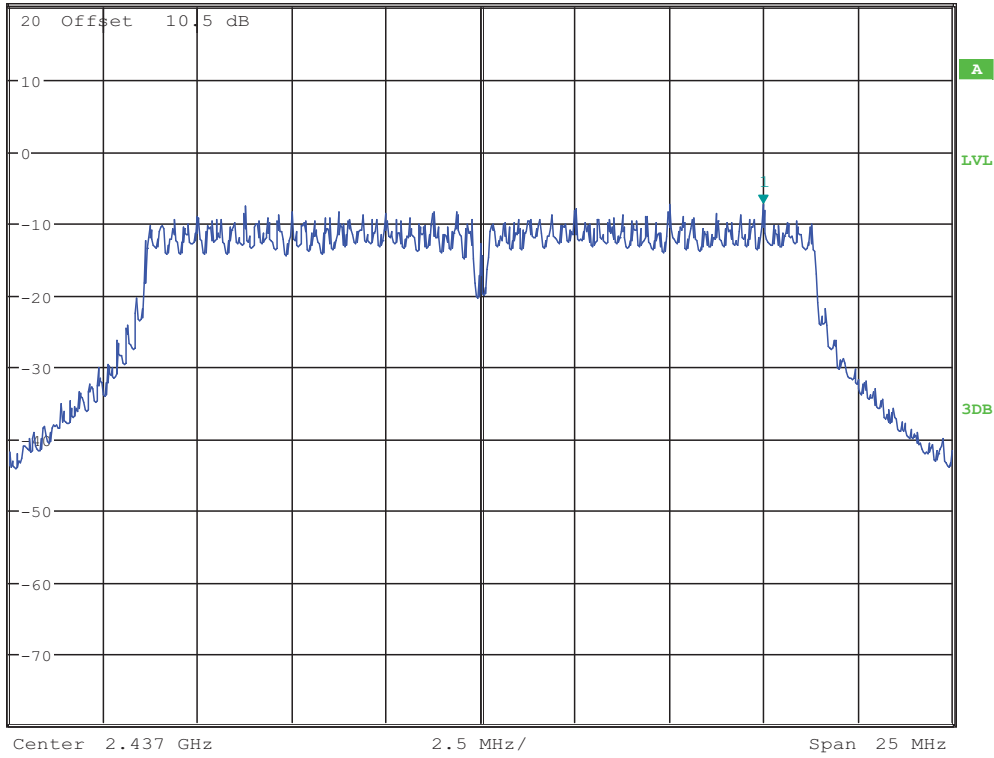

Ref 20.5 dBm *Att 10 dB *RBW 30 kHz Marker 1 [T1]
*VBW 100 kHz -7.79 dBm
*SWT 200 ms 2.419491987 GHz

1 PK
VIEW

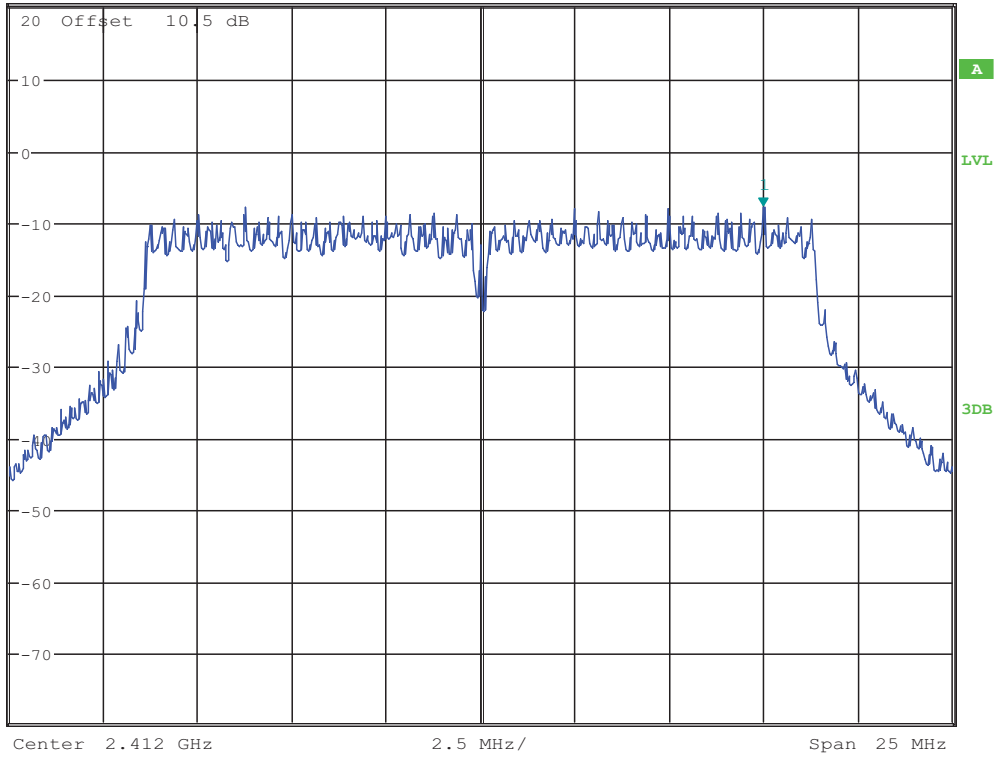

11n HT40:



Ref 20.5 dBm *Att 10 dB *RBW 30 kHz Marker 1 [T1]
*VBW 100 kHz -11.24 dBm
SWT 60 ms 2.414467949 GHz

1 PK
VIEW

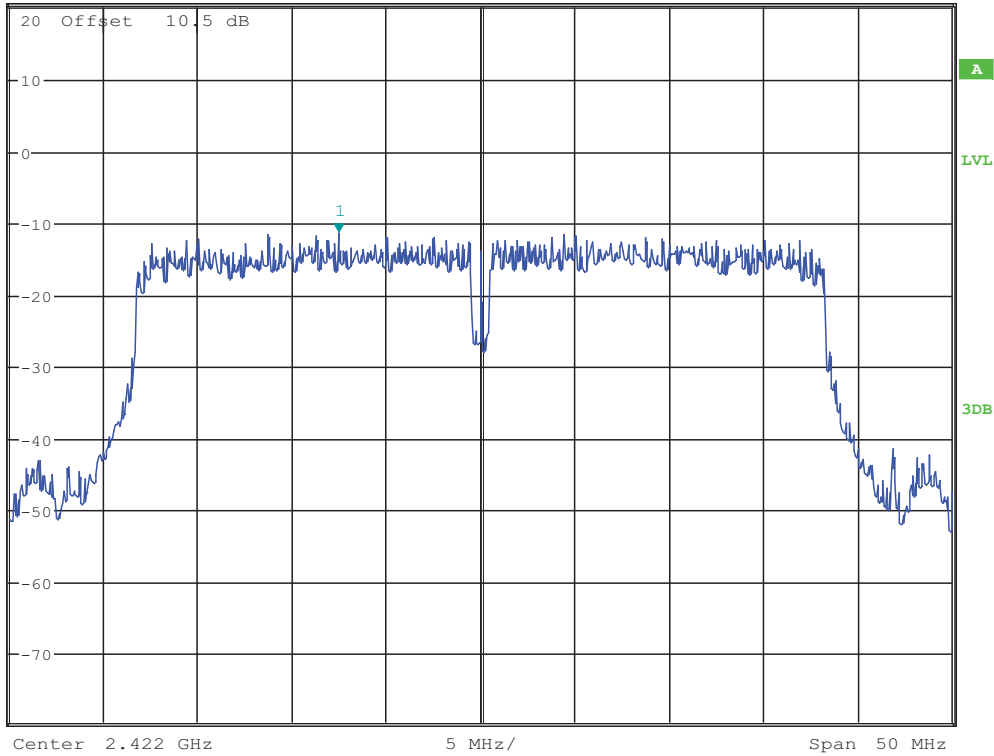

Ref 20.5 dBm *Att 10 dB *RBW 30 kHz Marker 1 [T1]
*VBW 100 kHz -11.54 dBm
SWT 60 ms 2.440701923 GHz

1 PK
VIEW

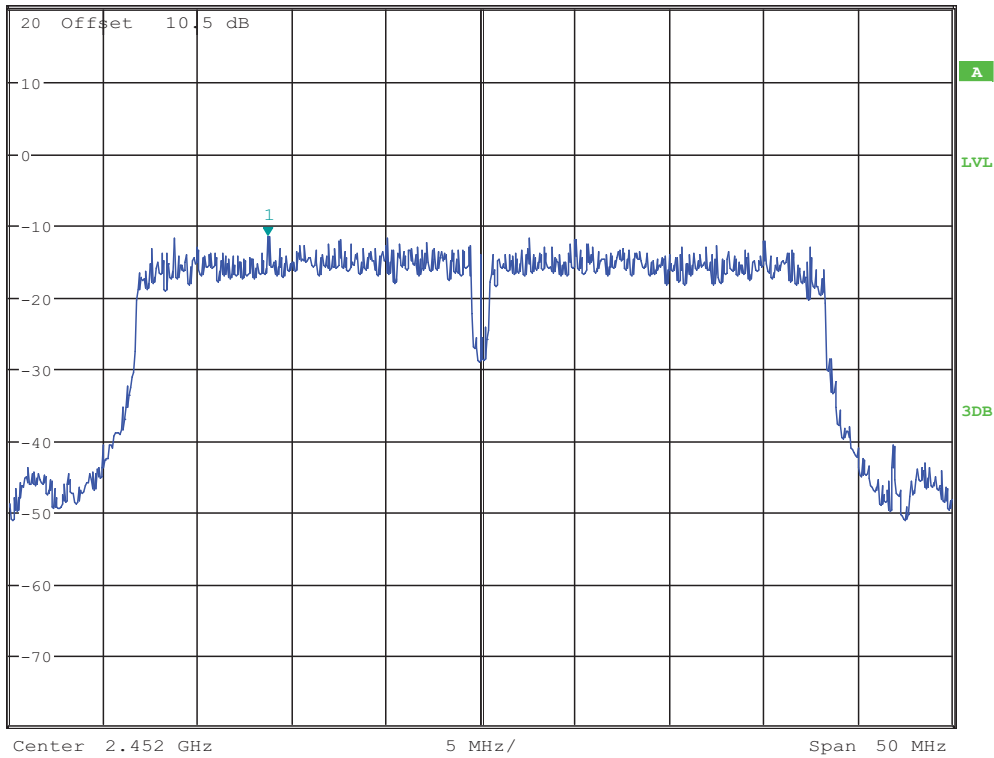

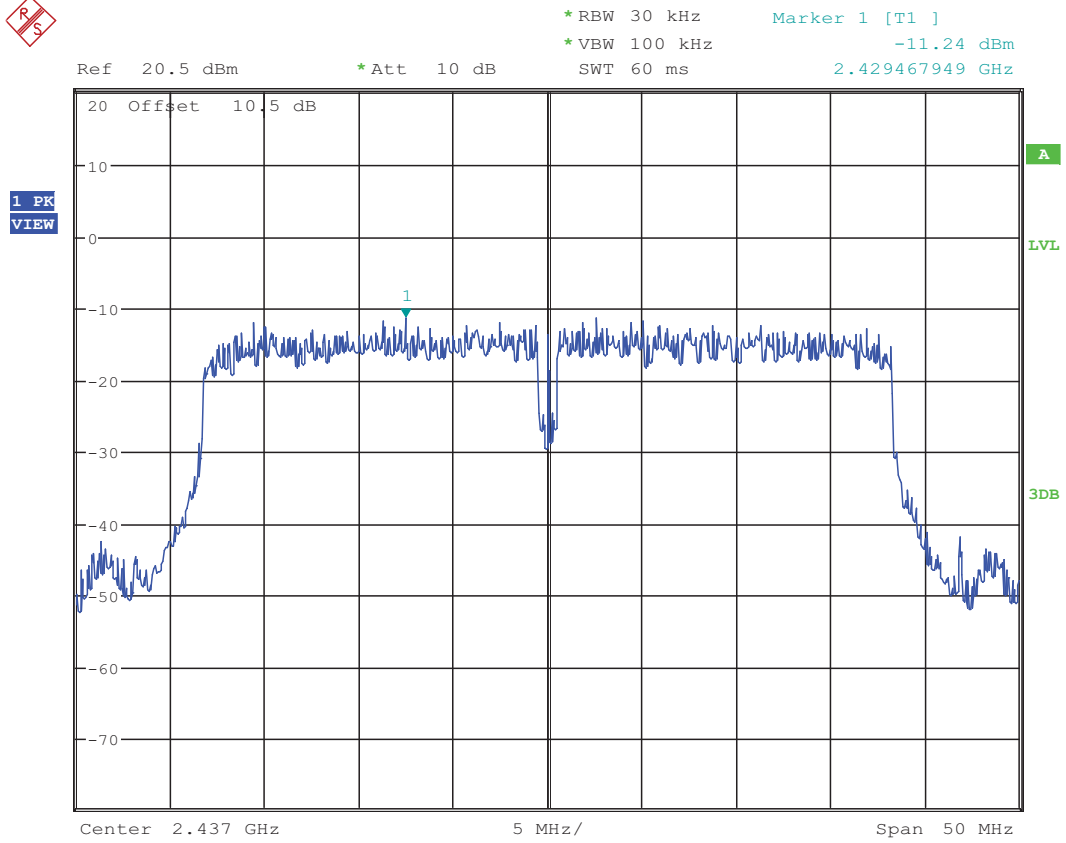

6. Emissions outside the specified frequency bands

6.1. Test equipment

Same with 3.1

6.2. Block diagram of test setup

Same with 3.2

6.3. Limits

In any 100kHz bandwidth outside the frequency bands in which the spread spectrum intentional radiator is operating, the radio frequency power that is produced by the intentional radiator shall be at least 20dB below that in the 100kHz bandwidth within the band that contains the highest level of the desired power.

6.4. Test Procedure

- (1) Configure EUT and assistant system according clause 2.4 and 6.2
- (2) Connect EUT's antenna output to spectrum analyzer by RF cable.
- (3) Configure EUT work in test mode as stated in clause 2.4.
- (4) Establish a reference level by using the following procedure:

Center frequency	DTS Channel center frequency
RBW:	100KHz
VBW:	300KHz
Span	1.5times the DTS bandwidth
Detector Mode:	Peak
Sweep time:	auto
Trace mode	Max hold

- (5) Allow the trace to stabilize, use the peak marker function to determine the maximum peak power level to establish the reference level.
- (6) Set the spectrum analyzer as follows:

RBW:	100KHz
VBW:	300KHz
Span	Encompass frequency range to be measured
Number of measurement points	\geq span/RBW
Detector Mode:	Peak
Sweep time:	auto
Trace mode	Max hold

- (7) Allow the trace to stabilize, use the peak marker function to determine the maximum amplitude of all unwanted emissions outside of the authorized frequency band

6.5. Test Result

EUT: GuruPlug M/N: 003-GP0XXXXXX							
EUT Set Mode	CH or Frequency	Measured Range	Result (dBm)	EUT Set Mode	CH or Frequency	Measured Range	Result (dBm)
11b	CH1	30MHz-1GHz	PASS	11n HT 20	CH1	30MHz-1GHz	PASS
		1GHz-25GHz	PASS			1GHz-25GHz	PASS
		2.3GHz-2.43GHz	PASS			2.3GHz-2.43GHz	PASS
	CH6	30MHz-1GHz	PASS		CH6	30MHz-1GHz	PASS
		1GHz-25GHz	PASS			1GHz-25GHz	PASS
	CH11	30MHz-1GHz	PASS		CH11	30MHz-1GHz	PASS
		1GHz-25GHz	PASS			1GHz-25GHz	PASS
		2.45GHz-2.6GHz	PASS			2.45GHz-2.6GHz	PASS
	11g	CH1	30MHz-1GHz		PASS	11n HT 40	CH3
1GHz-25GHz			PASS	1GHz-25GHz	PASS		
2.3GHz-2.43GHz			PASS	2.3GHz-2.43GHz	PASS		
CH6		30MHz-1GHz	PASS	CH6	30MHz-1GHz		PASS
		1GHz-25GHz	PASS		1GHz-25GHz		PASS
CH11		30MHz-1GHz	PASS	CH9	30MHz-1GHz		PASS
		1GHz-25GHz	PASS		1GHz-25GHz		PASS
		2.45GHz-2.6GHz	PASS		2.43-2.6GHz		PASS
Test Date : 2013-8-07				Test Engineer : Leo Liu			

6.6. Original test data

11b CH1:

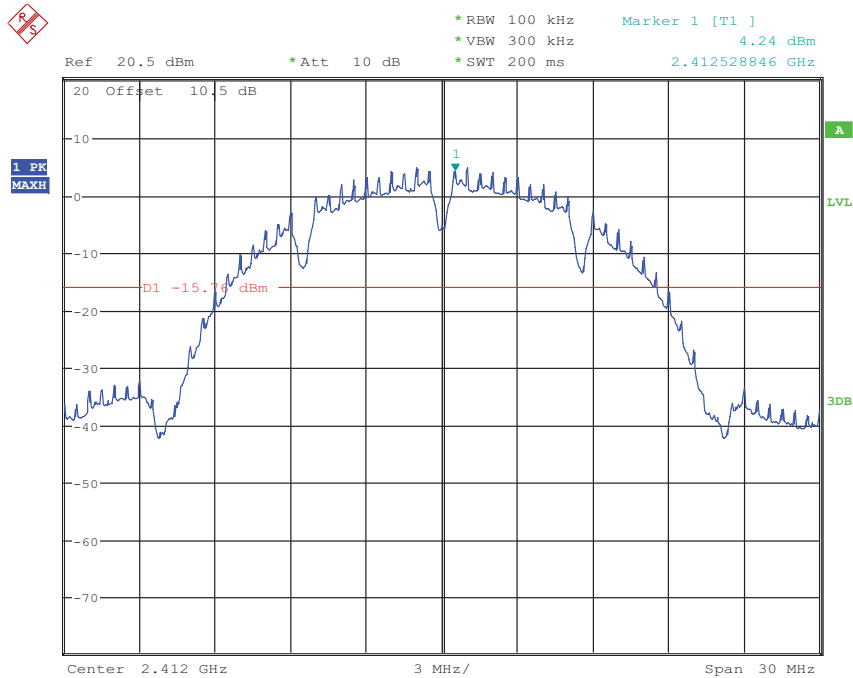

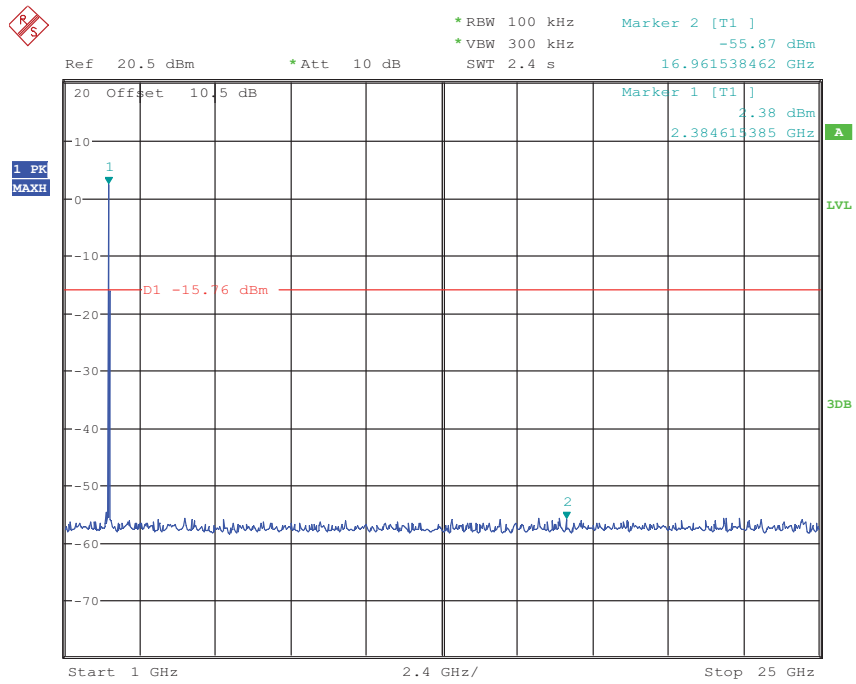
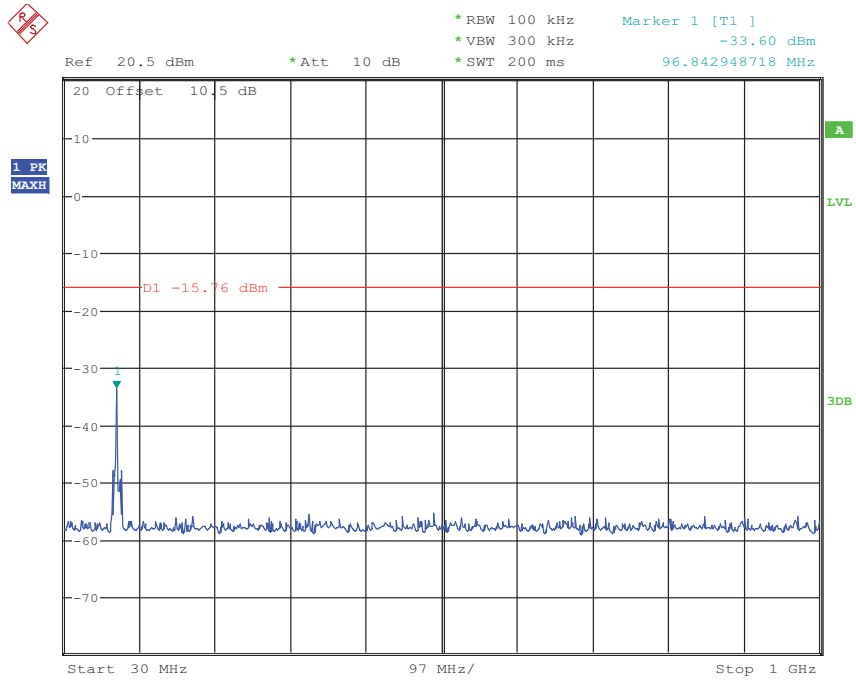

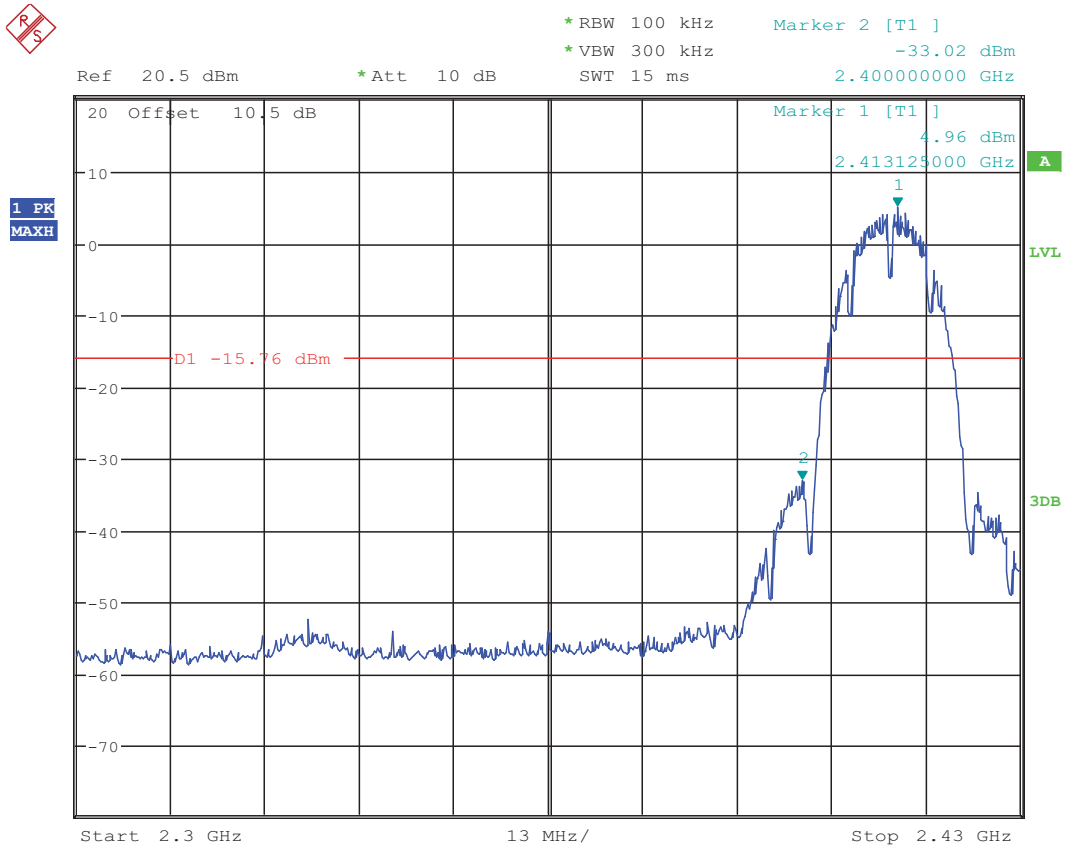

11b CH6:

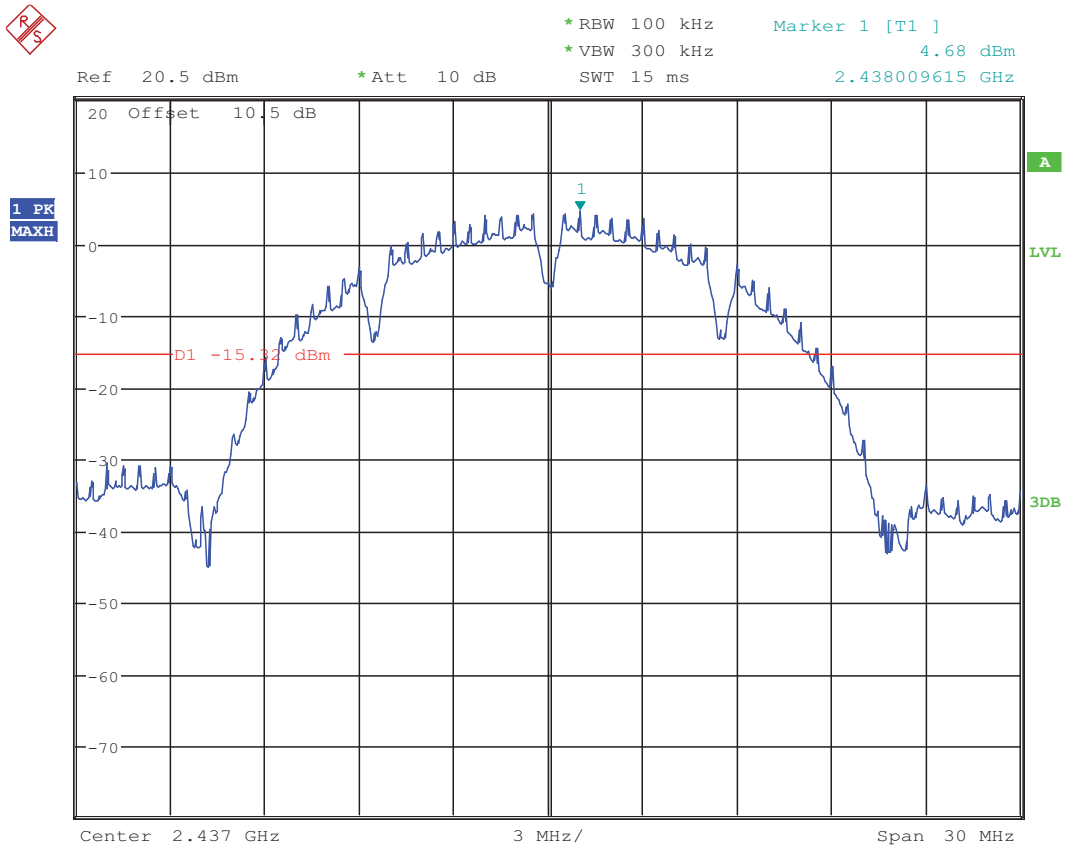

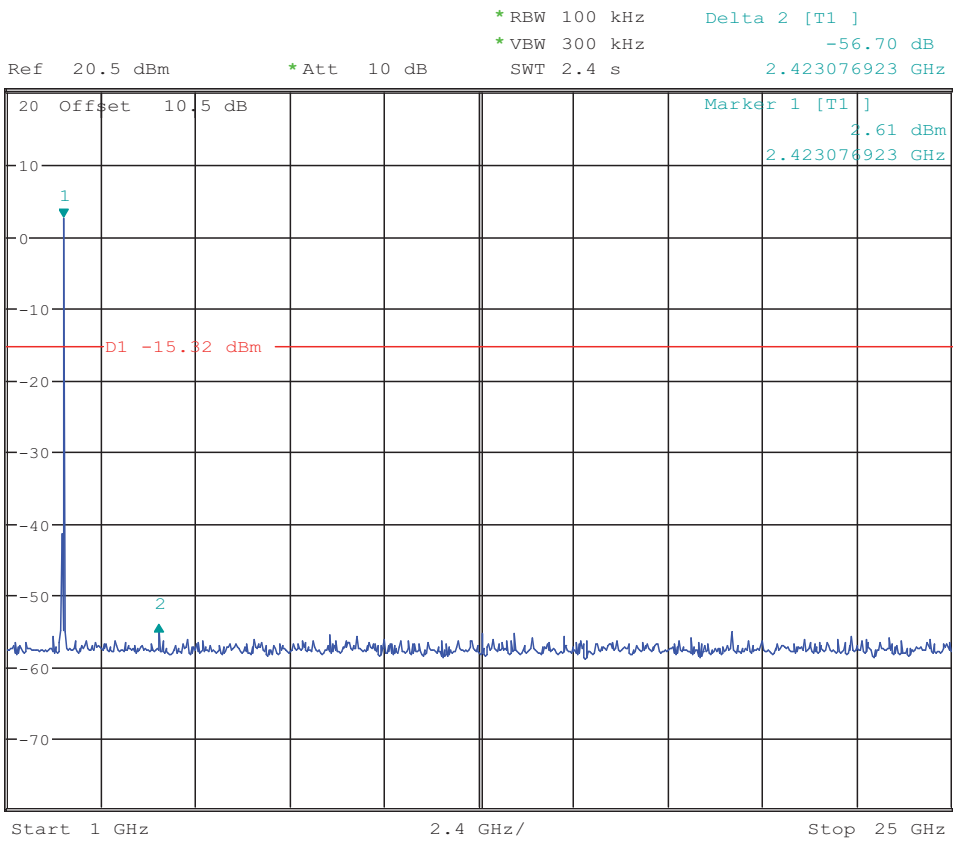
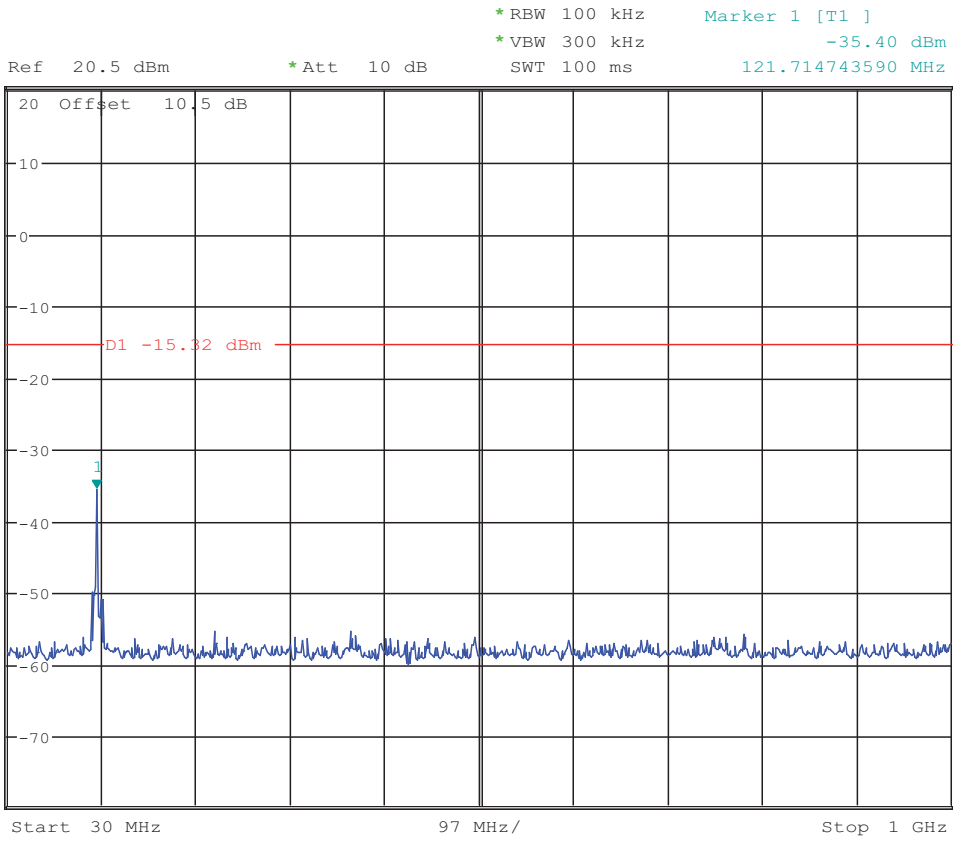

11b CH11:



Ref 20.5 dBm *Att 10 dB *RBW 100 kHz Marker 1 [T1]
*VBW 300 kHz 4.33 dBm
SWT 15 ms 2.461038462 GHz

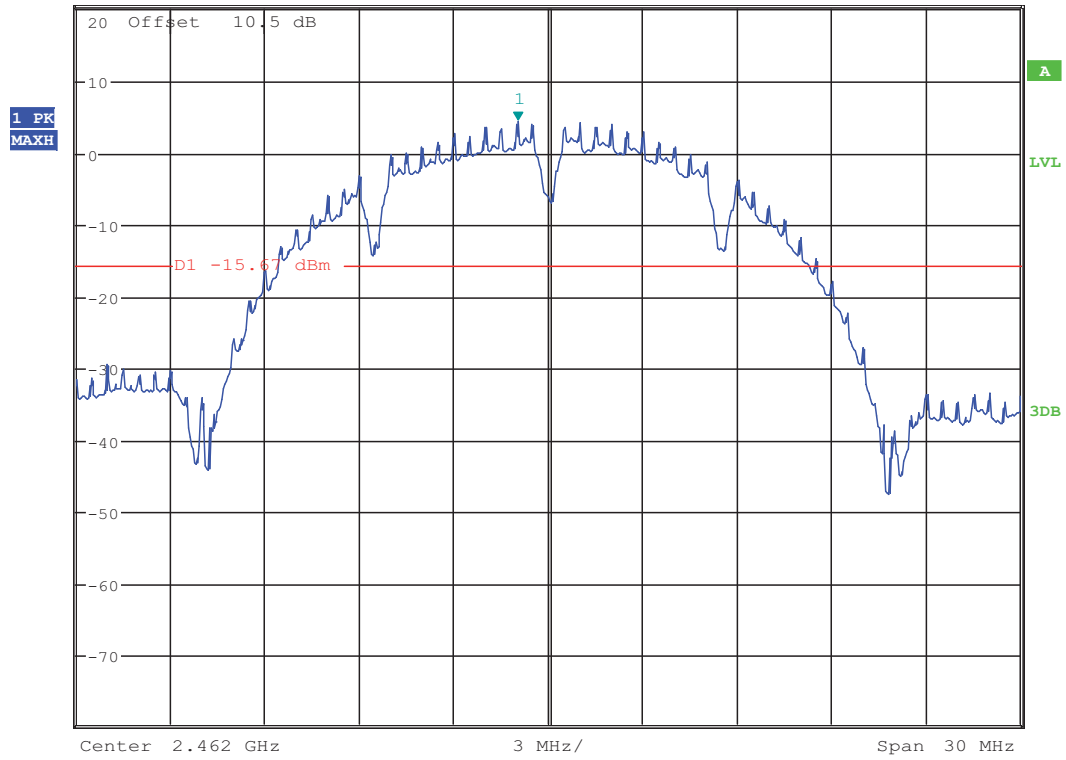

Ref 20.5 dBm *Att 10 dB *RBW 100 kHz Marker 1 [T1]
*VBW 300 kHz -36.75 dBm
SWT 100 ms 146.586538462 MHz

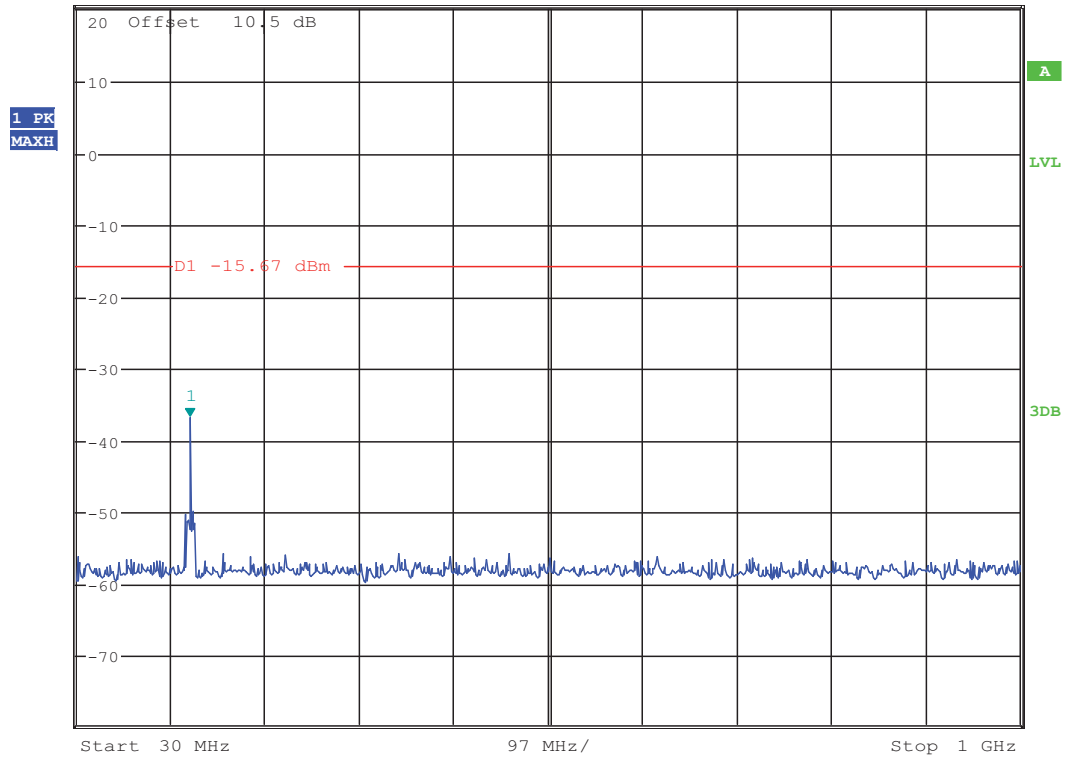



Ref 20.5 dBm *Att 10 dB *RBW 100 kHz Delta 2 [T1]
*VBW 300 kHz -54.85 dB
SWT 2.4 s 2.461538462 GHz

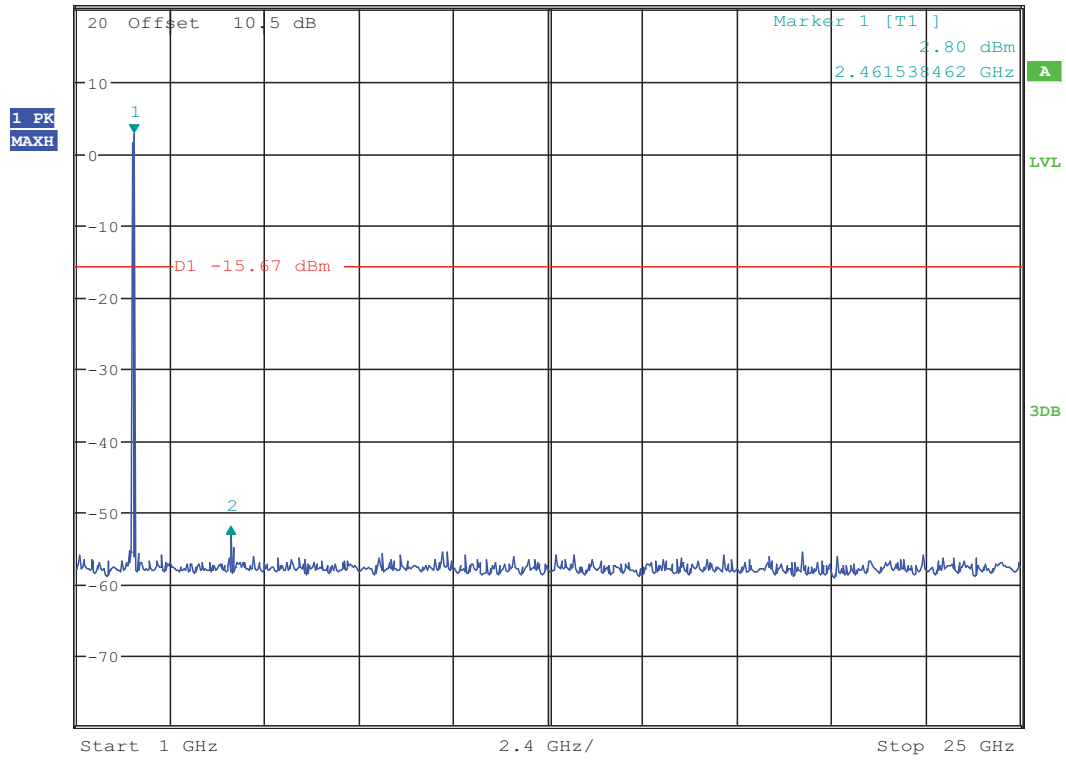

Ref 20.5 dBm *Att 10 dB *RBW 100 kHz Marker 2 [T1]
*VBW 300 kHz -52.54 dBm
SWT 15 ms 2.483500000 GHz

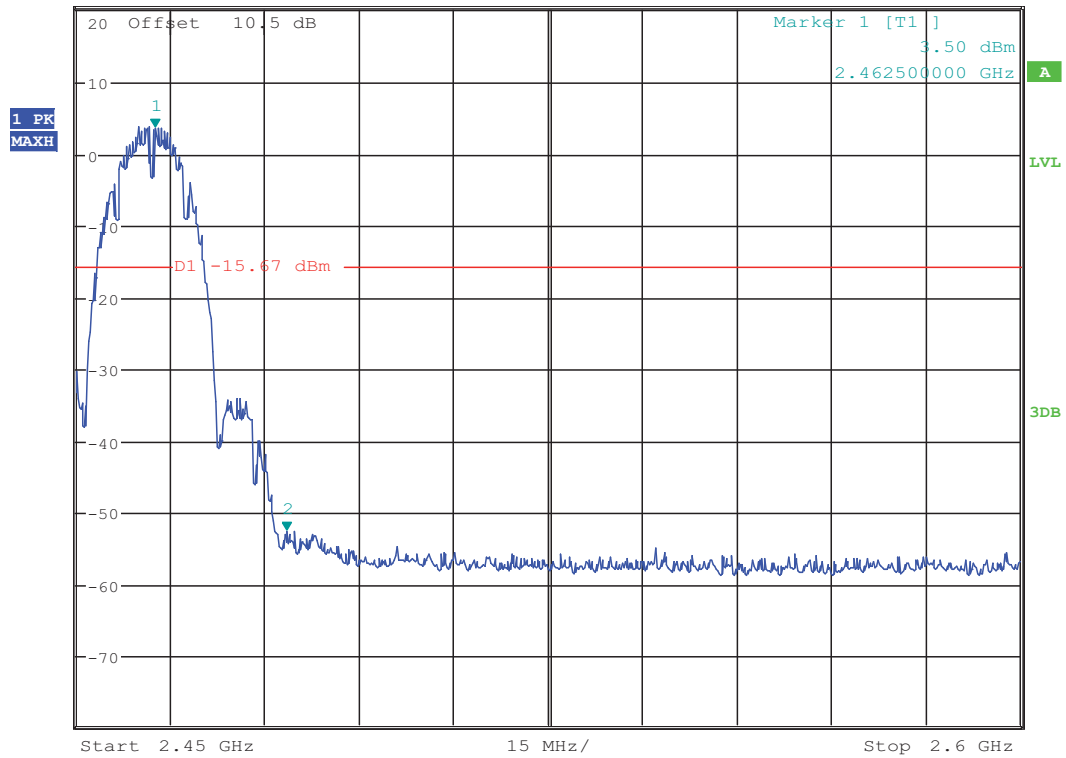

11g CH1:



Ref 20.5 dBm *Att 10 dB *RBW 100 kHz Marker 1 [T1]
*VBW 300 kHz -3.11 dBm
SWT 15 ms 2.407000000 GHz

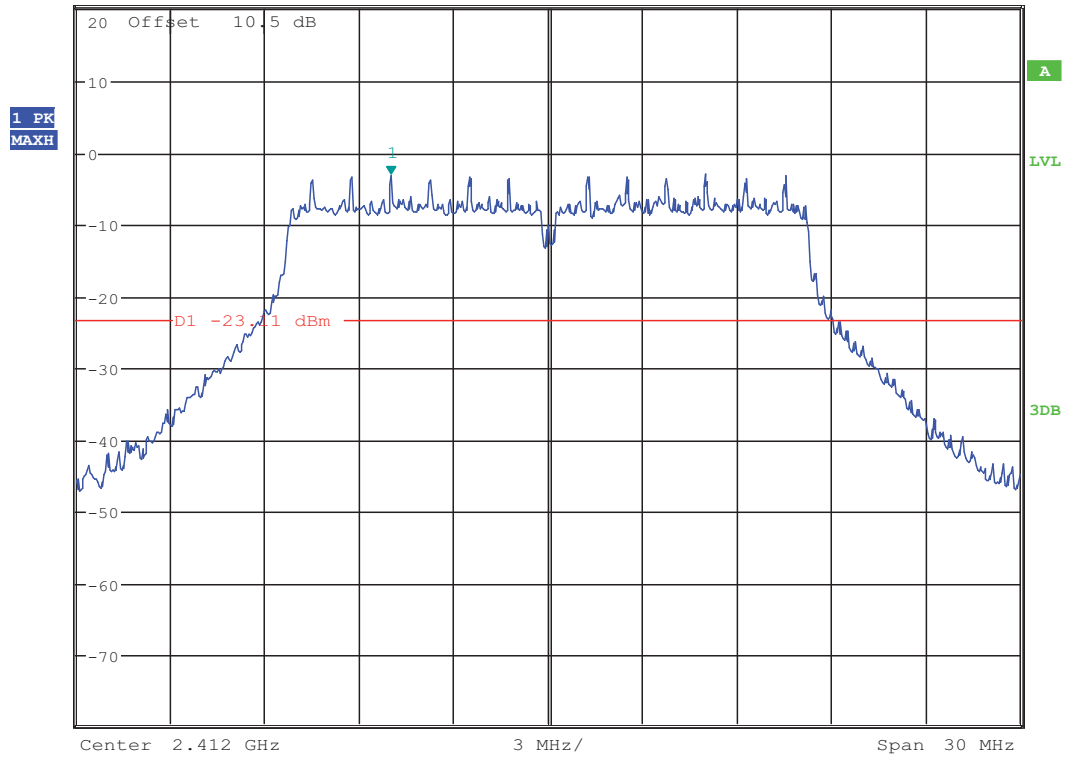

Ref 20.5 dBm *Att 10 dB *RBW 100 kHz Marker 1 [T1]
*VBW 300 kHz -52.78 dBm
SWT 100 ms 98.397435897 MHz

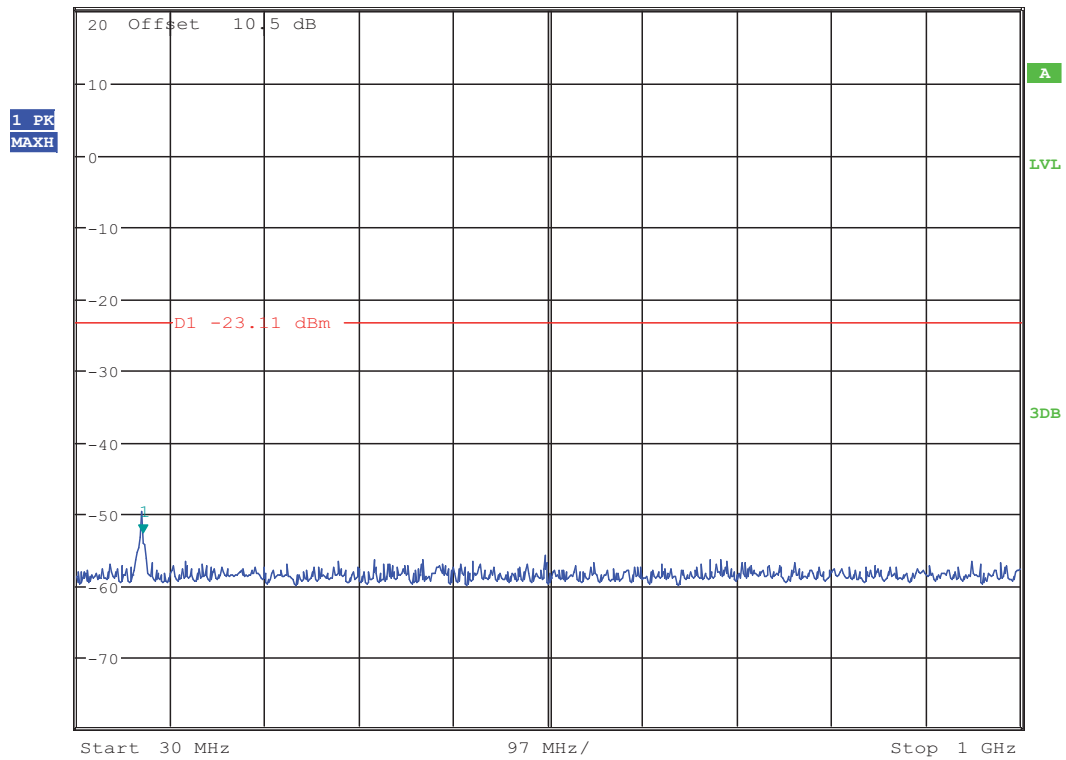



Ref 20.5 dBm *Att 10 dB *RBW 100 kHz Delta 2 [T1] -49.29 dB
*VBW 300 kHz SWT 2.4 s 5.461538462 GHz

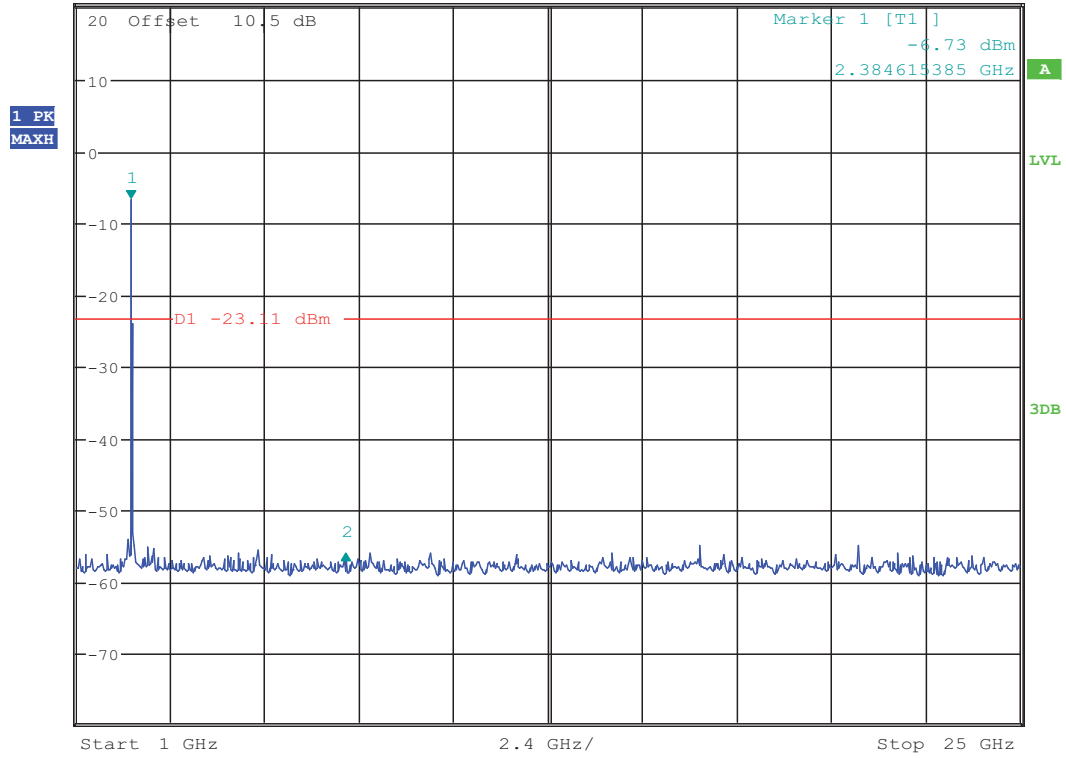

Ref 20.5 dBm *Att 10 dB *RBW 100 kHz Marker 2 [T1] -36.12 dBm
*VBW 300 kHz SWT 15 ms 2.400000000 GHz

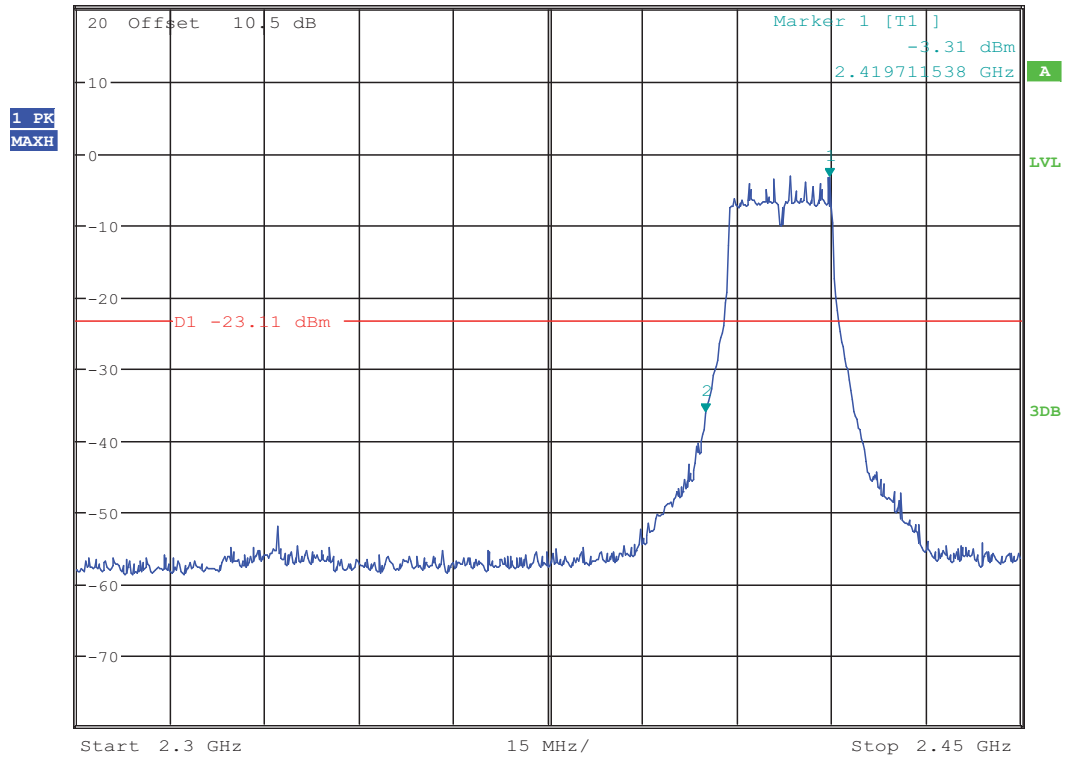

11g CH6:



Ref 20.5 dBm *Att 10 dB *RBW 100 kHz Marker 1 [T1]
*VBW 300 kHz -2.81 dBm
*SWT 15 ms 2.435750000 GHz

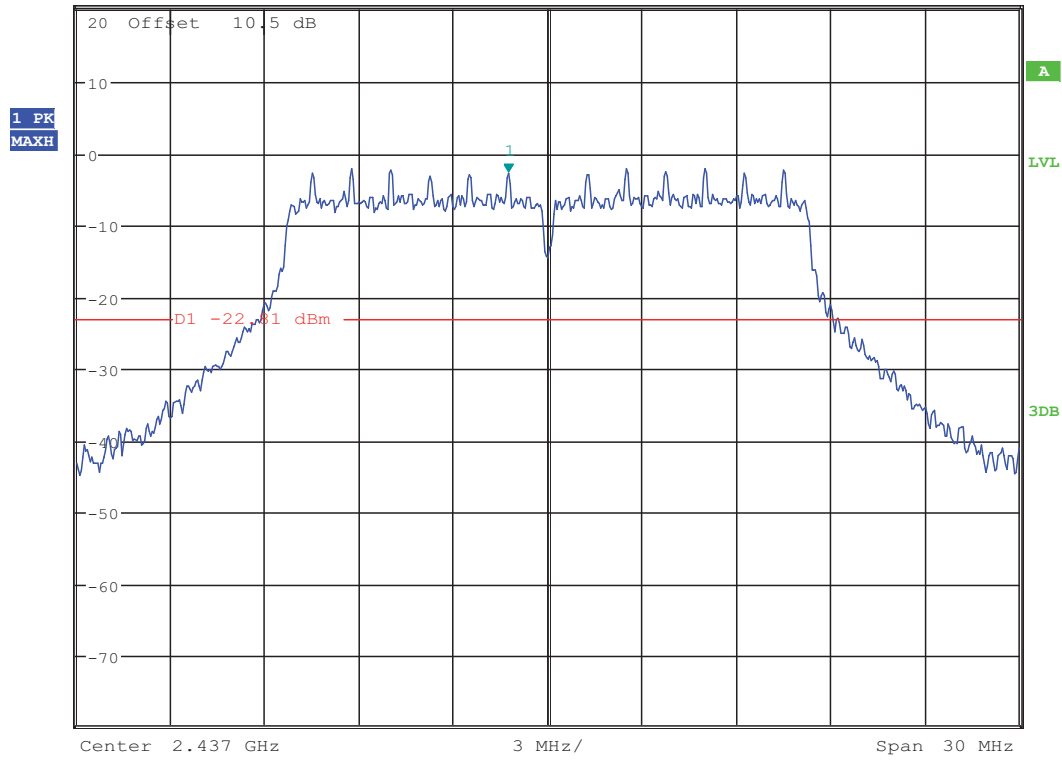

Ref 20.5 dBm *Att 10 dB *RBW 100 kHz Marker 1 [T1]
*VBW 300 kHz -50.93 dBm
SWT 100 ms 122.15000000 MHz

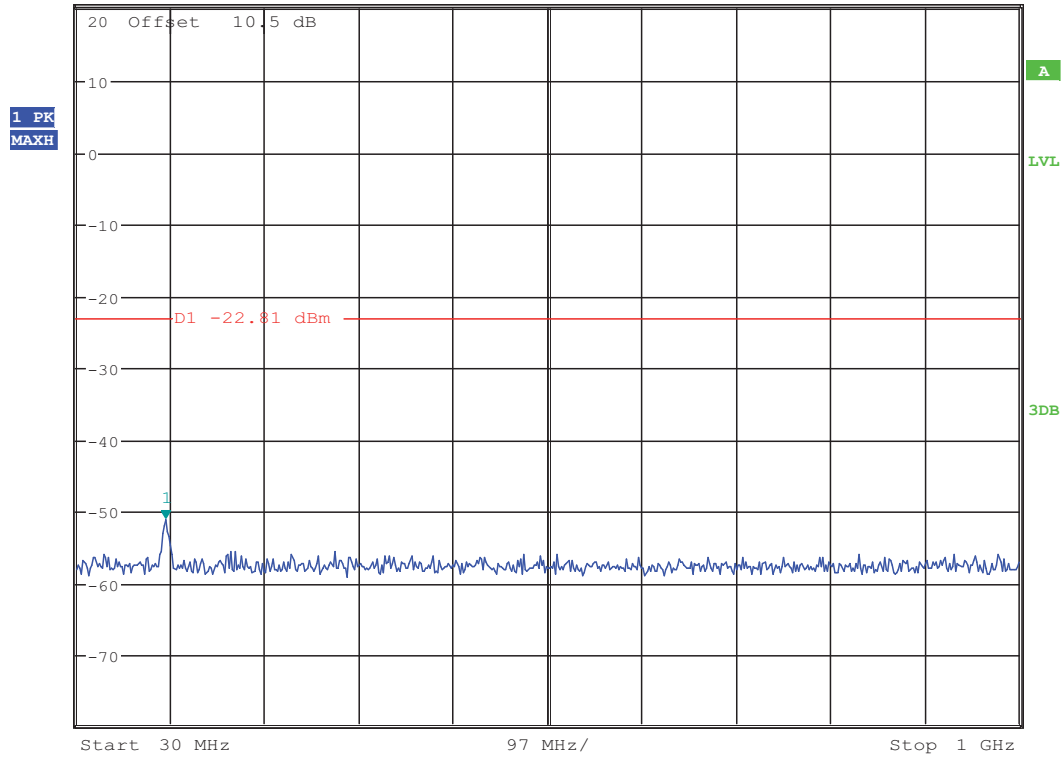



Ref 20.5 dBm *Att 10 dB *RBW 100 kHz Marker 2 [T1]
*VBW 300 kHz -55.48 dBm
SWT 2.4 s 11.093846154 GHz

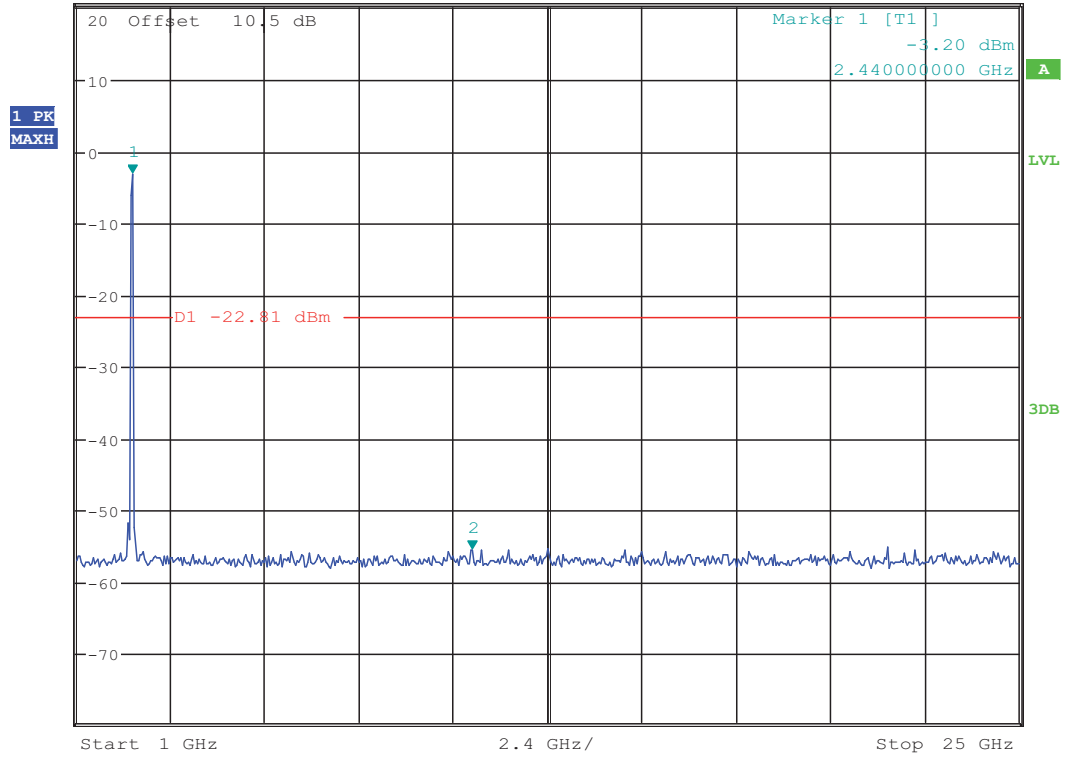

11g CH11:



Ref 20.5 dBm *Att 10 dB *RBW 100 kHz Marker 1 [T1]
*VBW 300 kHz -2.90 dBm
SWT 15 ms 2.455750000 GHz

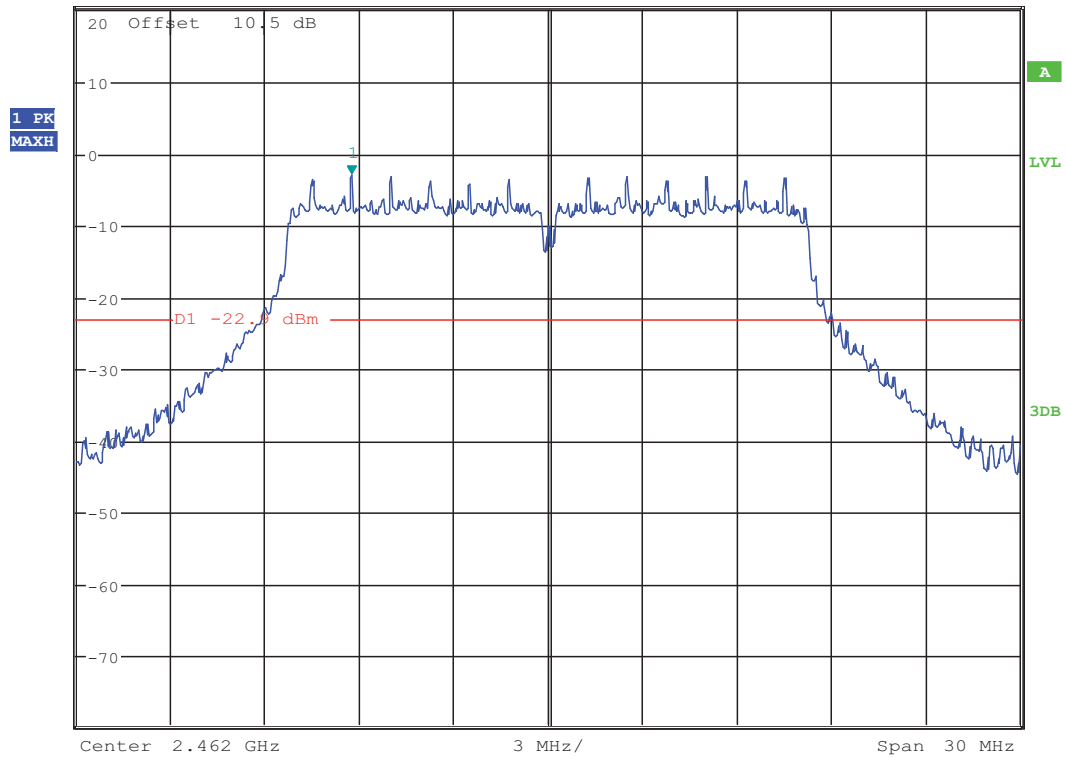

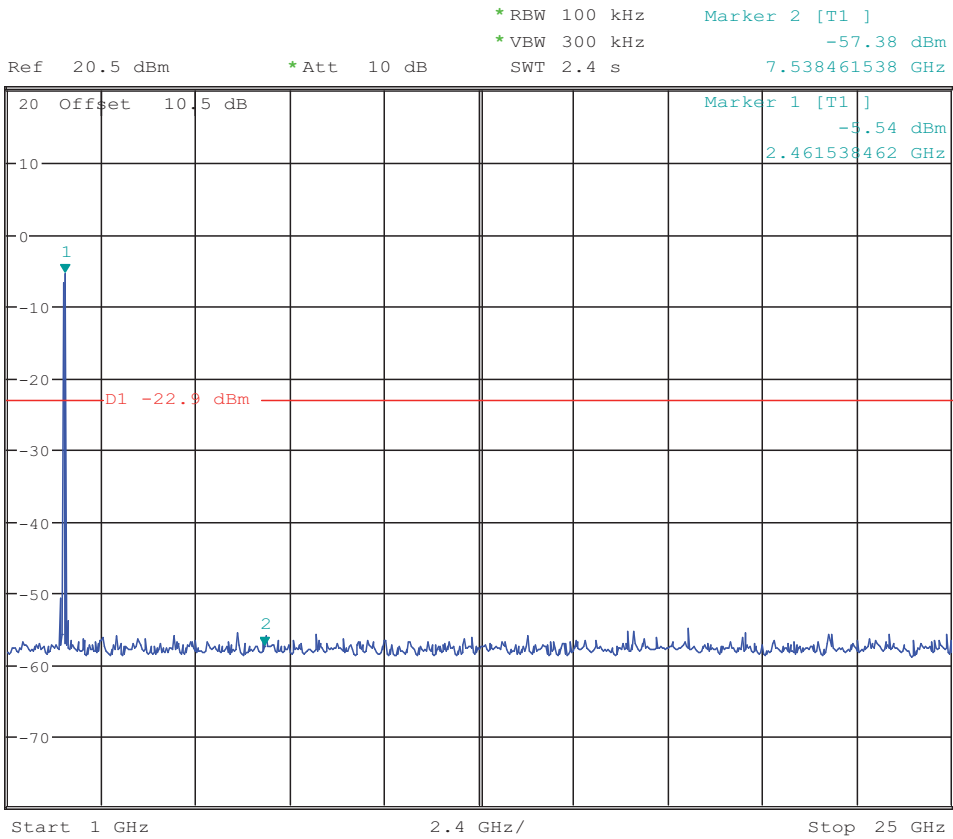
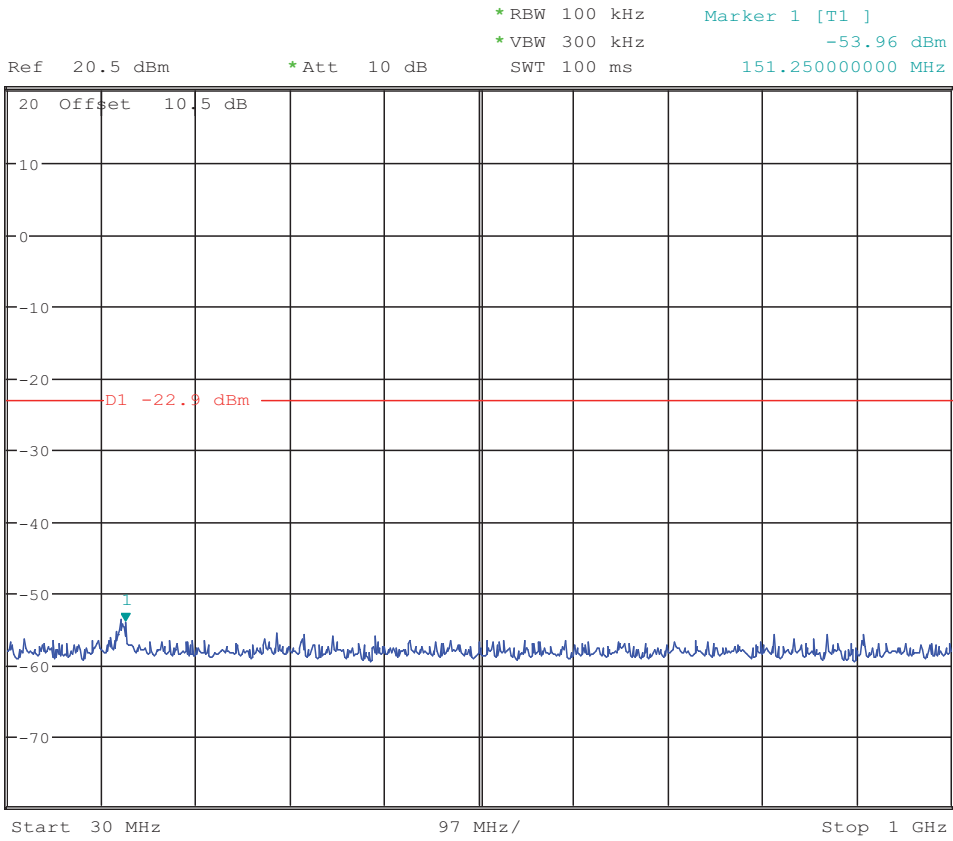



Ref 20.5 dBm *Att 10 dB *RBW 100 kHz Marker 2 [T1]
*VBW 300 kHz -49.91 dBm
SWT 15 ms 2.483500000 GHz

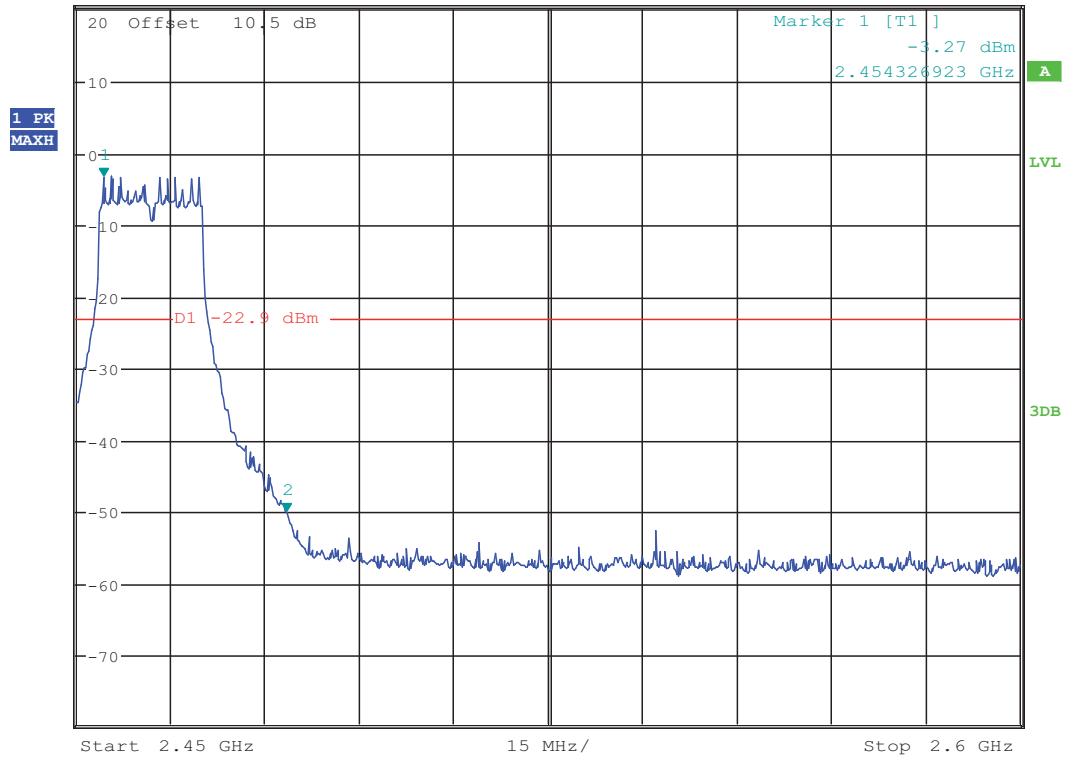

11n HT20 CH1:



Ref 20.5 dBm *Att 10 dB *RBW 100 kHz Marker 1 [T1]
*VBW 300 kHz -2.78 dBm
SWT 15 ms 2.417000000 GHz

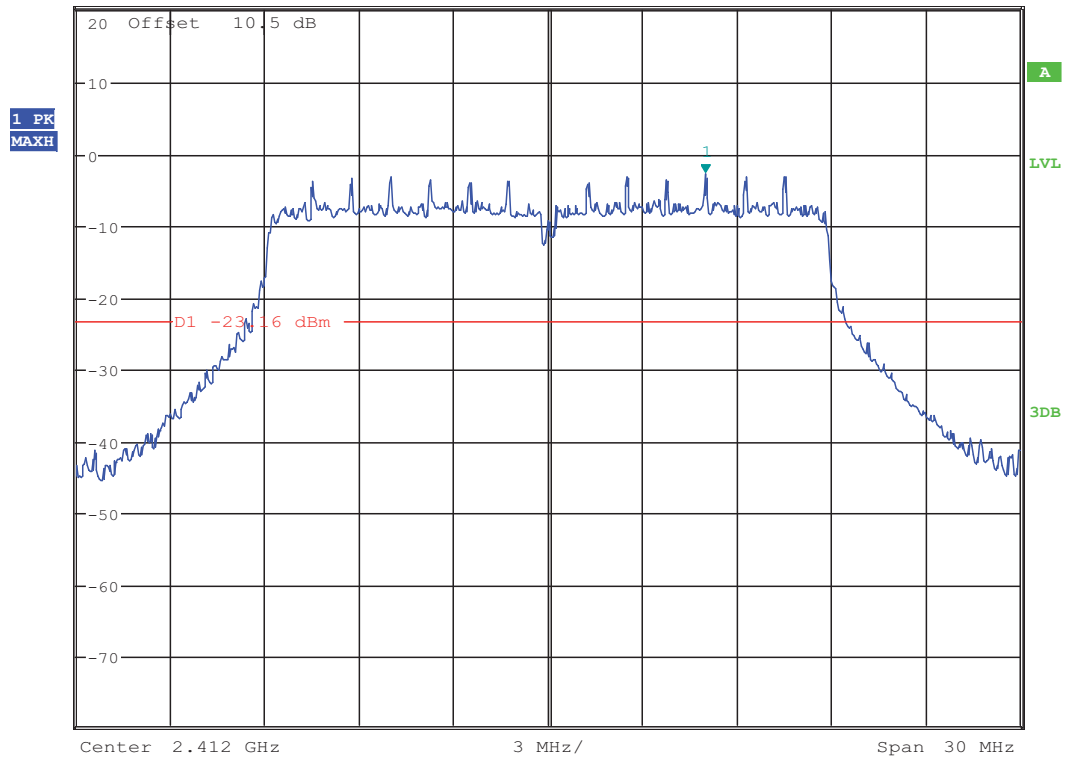

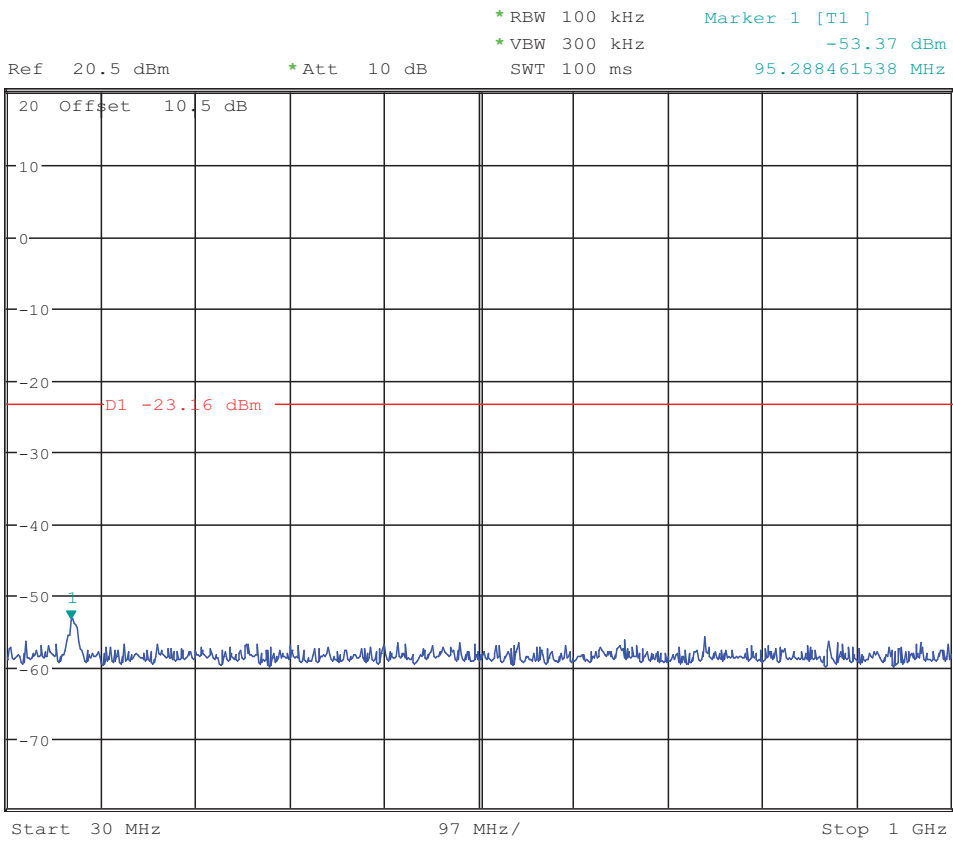
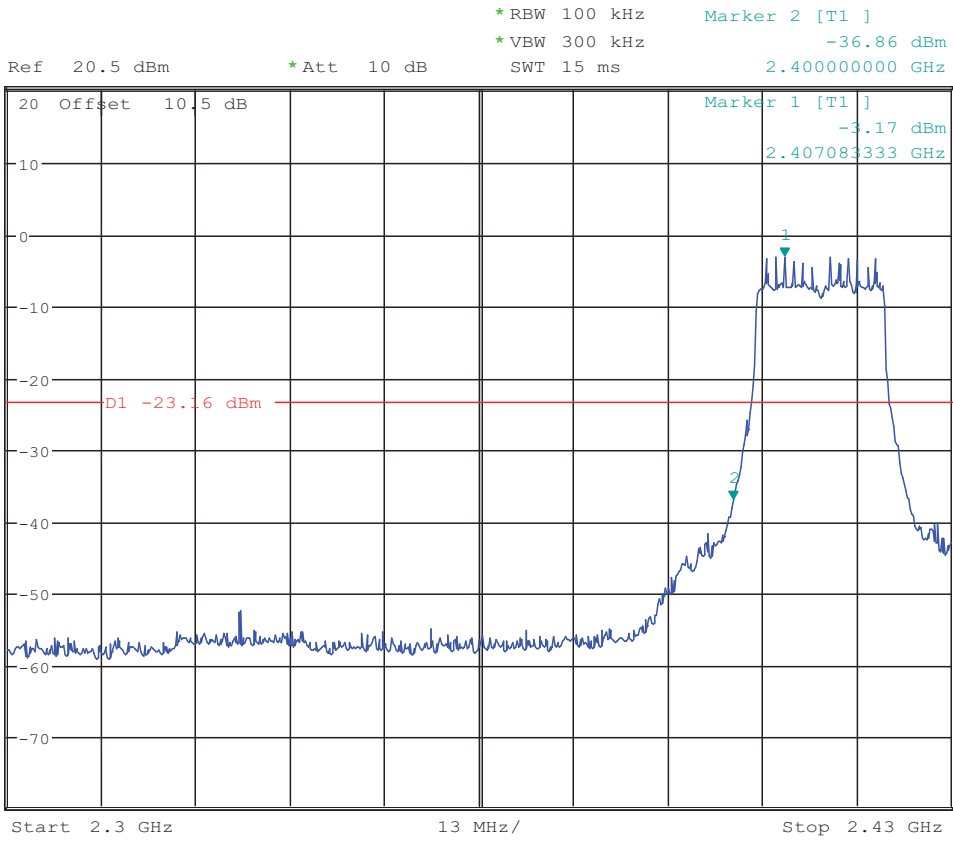



Ref 20.5 dBm *Att 10 dB *RBW 100 kHz Marker 2 [T1]
*VBW 300 kHz -55.50 dBm
SWT 2.4 s 8.576923077 GHz

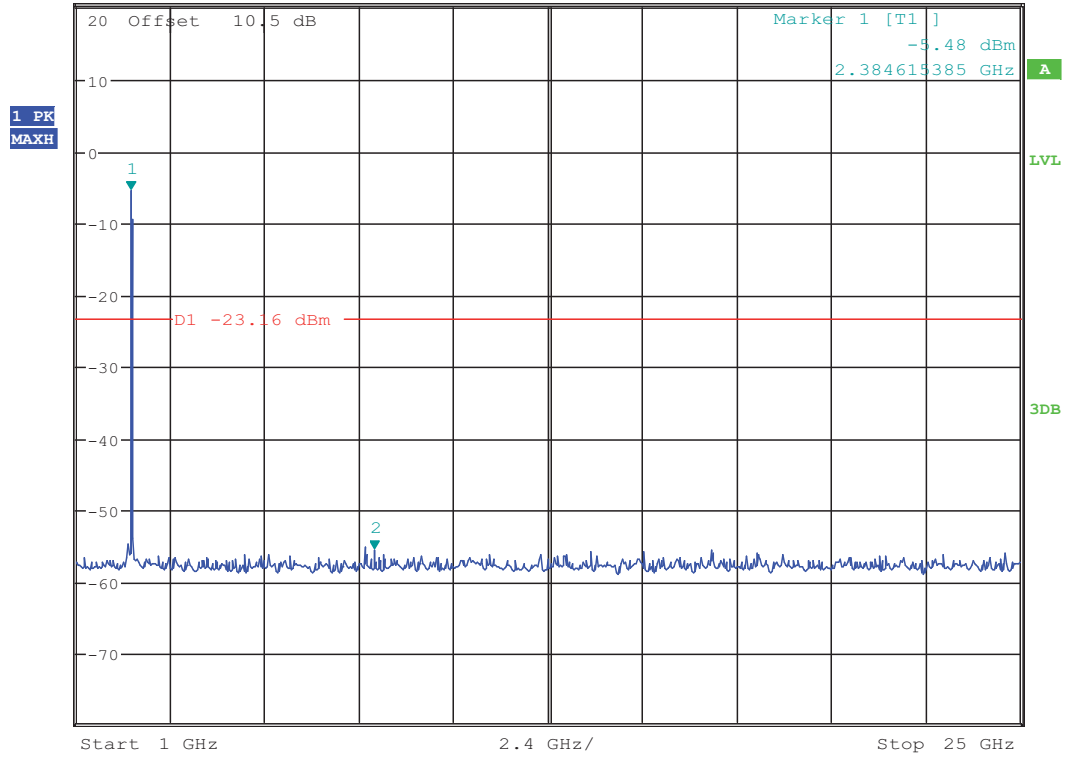

11n HT20 CH6:



Ref 20.5 dBm *Att 10 dB *RBW 100 kHz Marker 1 [T1]
*VBW 300 kHz -2.85 dBm
SWT 15 ms 2.444500000 GHz

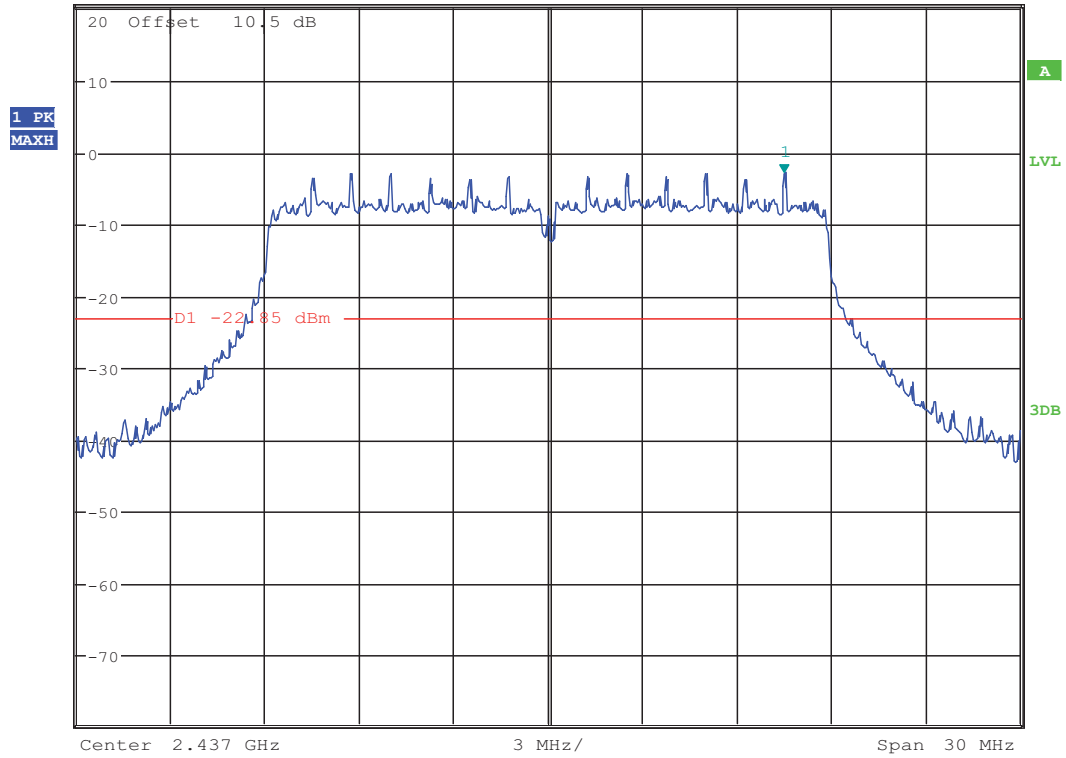

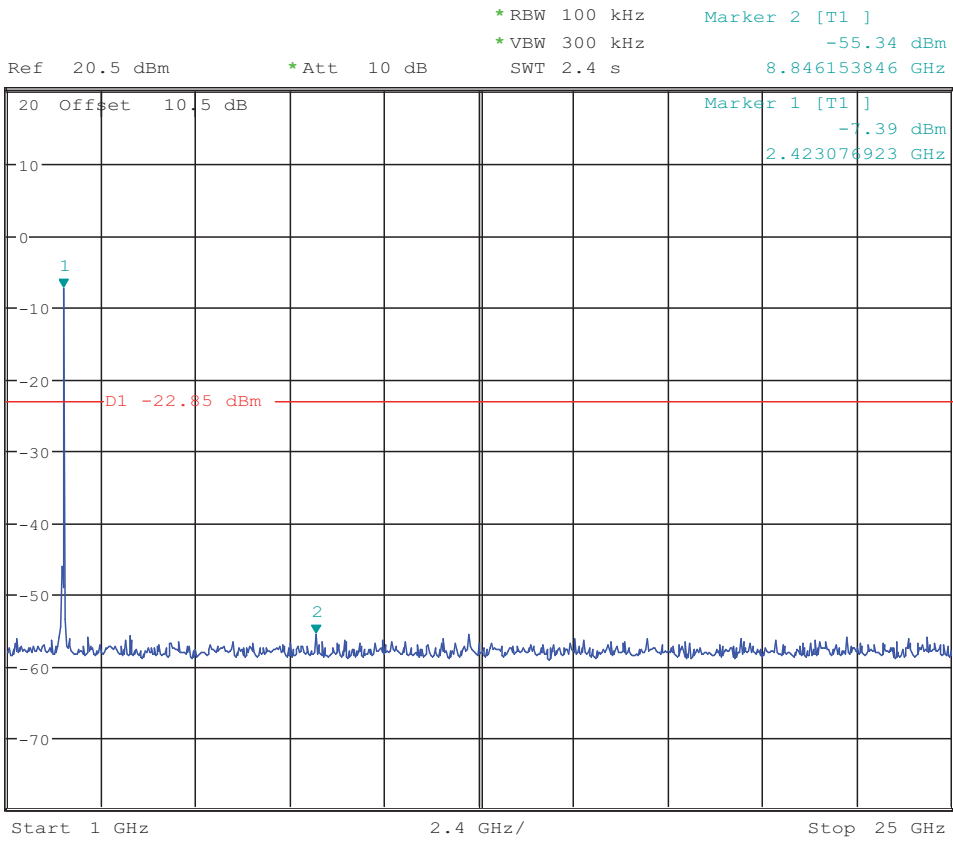
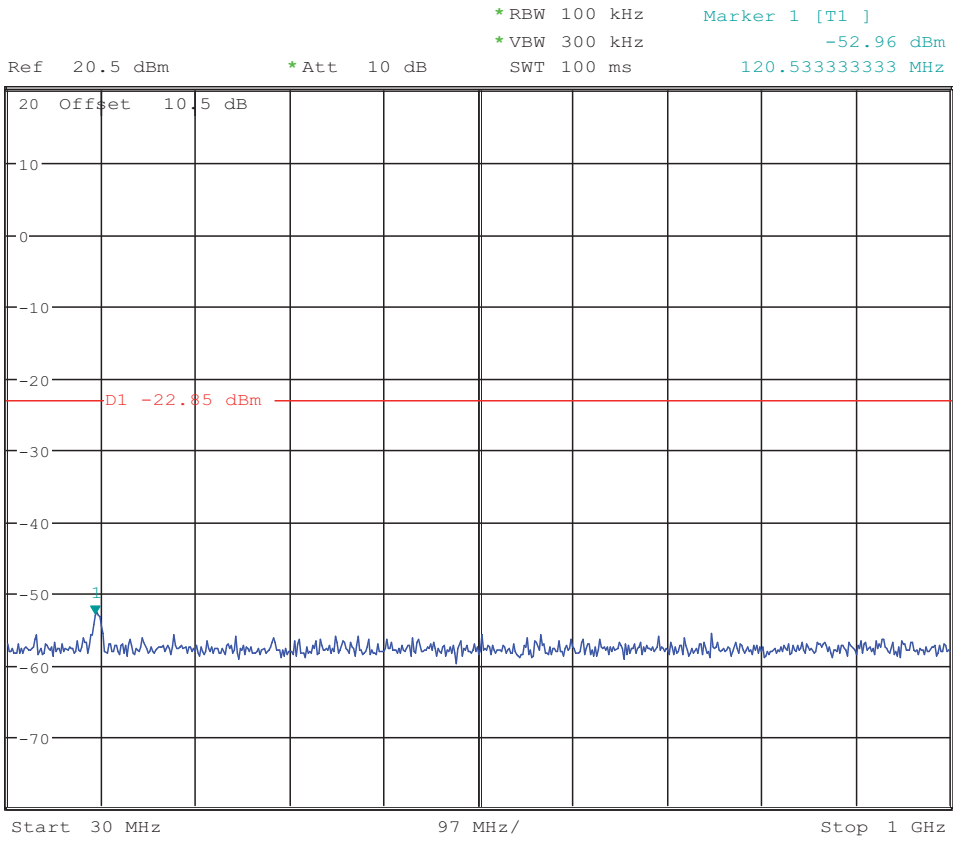

11n HT20 CH11:



*RBW 100 kHz Marker 1 [T1]
*VBW 300 kHz -2.81 dBm
SWT 15 ms 2.455750000 GHz

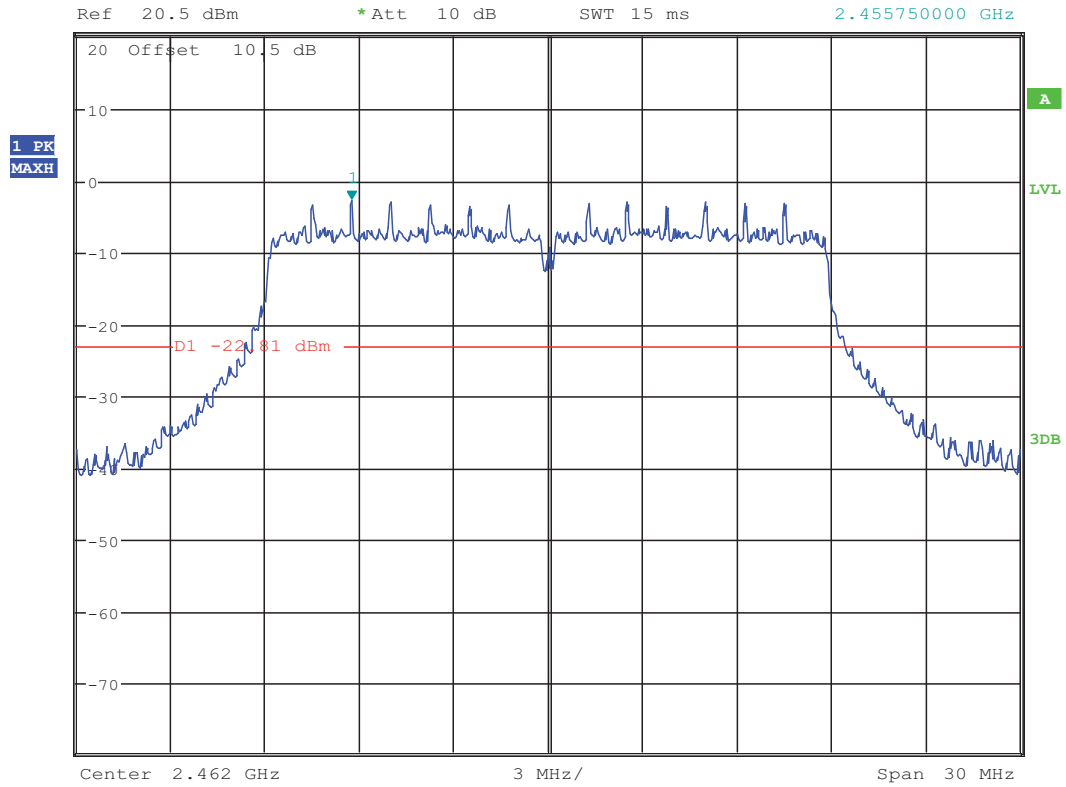

*RBW 100 kHz Marker 1 [T1]
*VBW 300 kHz -53.62 dBm
SWT 100 ms 146.586538462 MHz

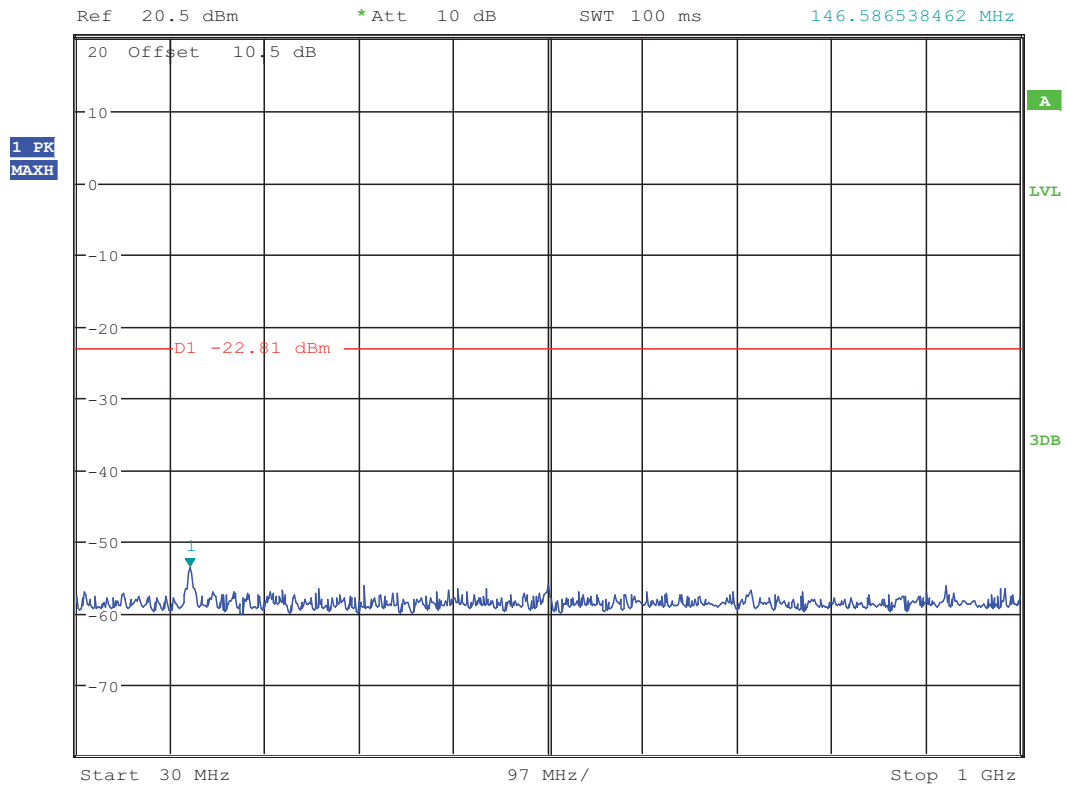

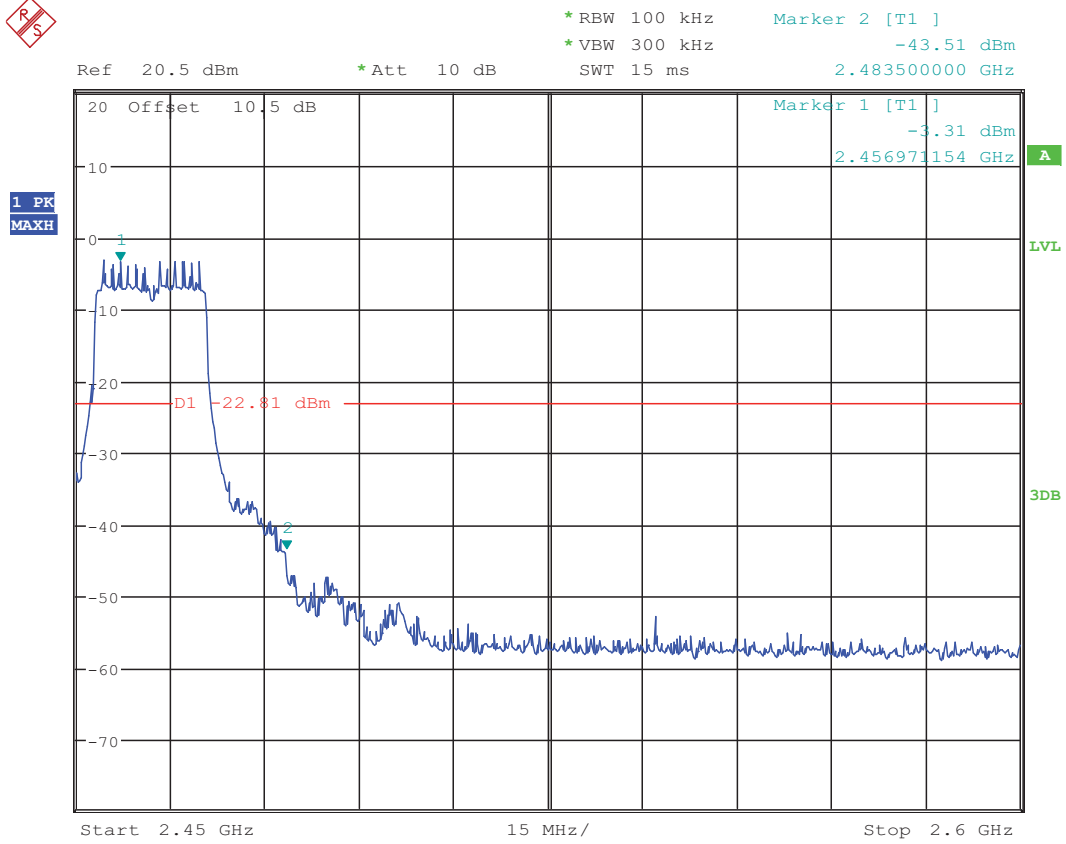
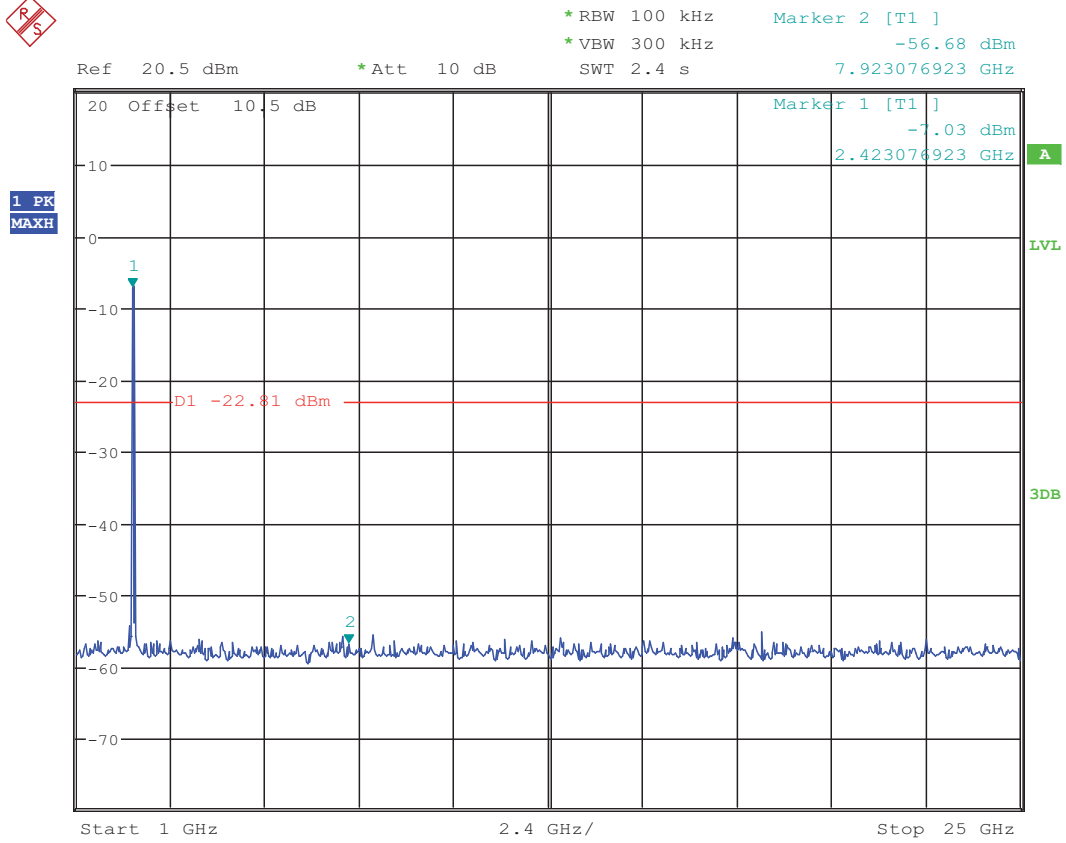

11n HT40 CH3:



Ref 20.5 dBm *Att 10 dB *RBW 100 kHz Marker 1 [T1]
*VBW 300 kHz -5.92 dBm
SWT 20 ms 2.425766026 GHz

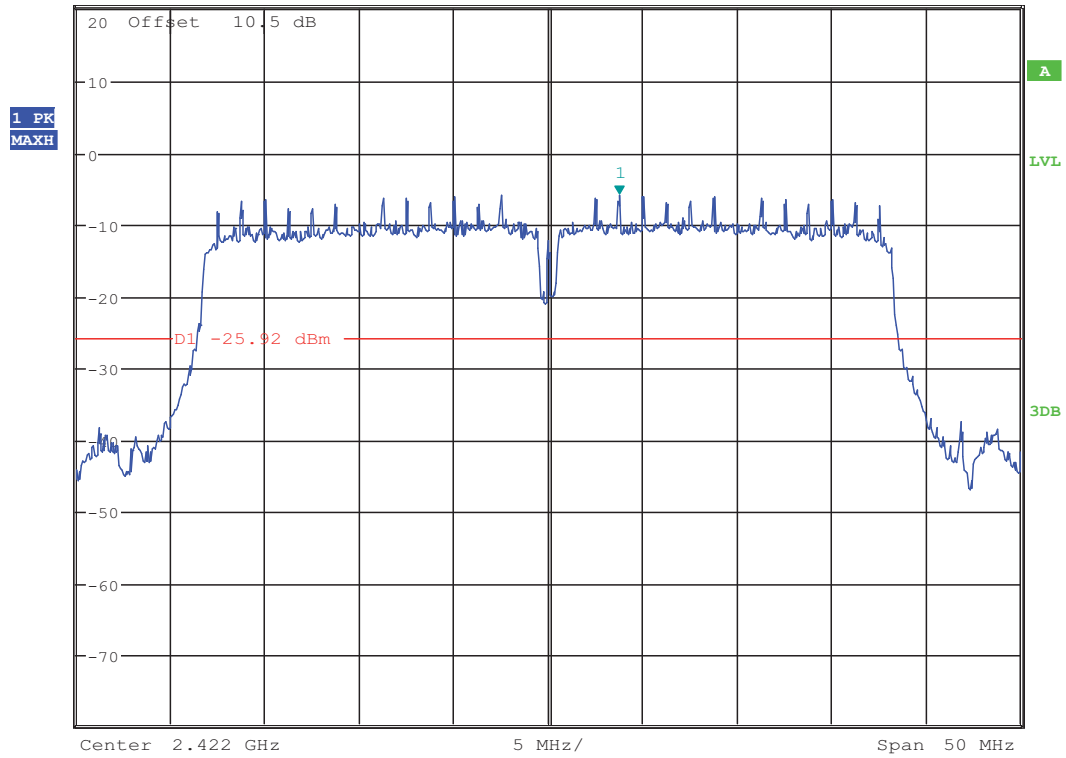

Ref 20.5 dBm *Att 10 dB *RBW 100 kHz Marker 1 [T1]
*VBW 300 kHz -52.47 dBm
SWT 100 ms 107.724358974 MHz

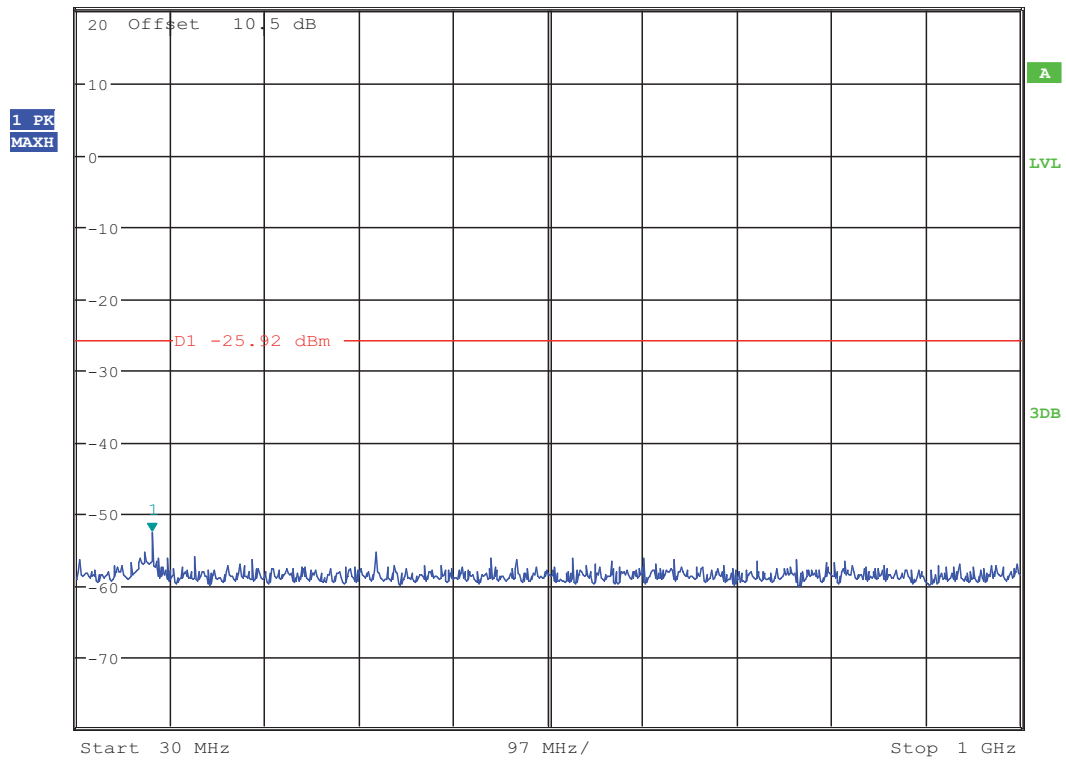

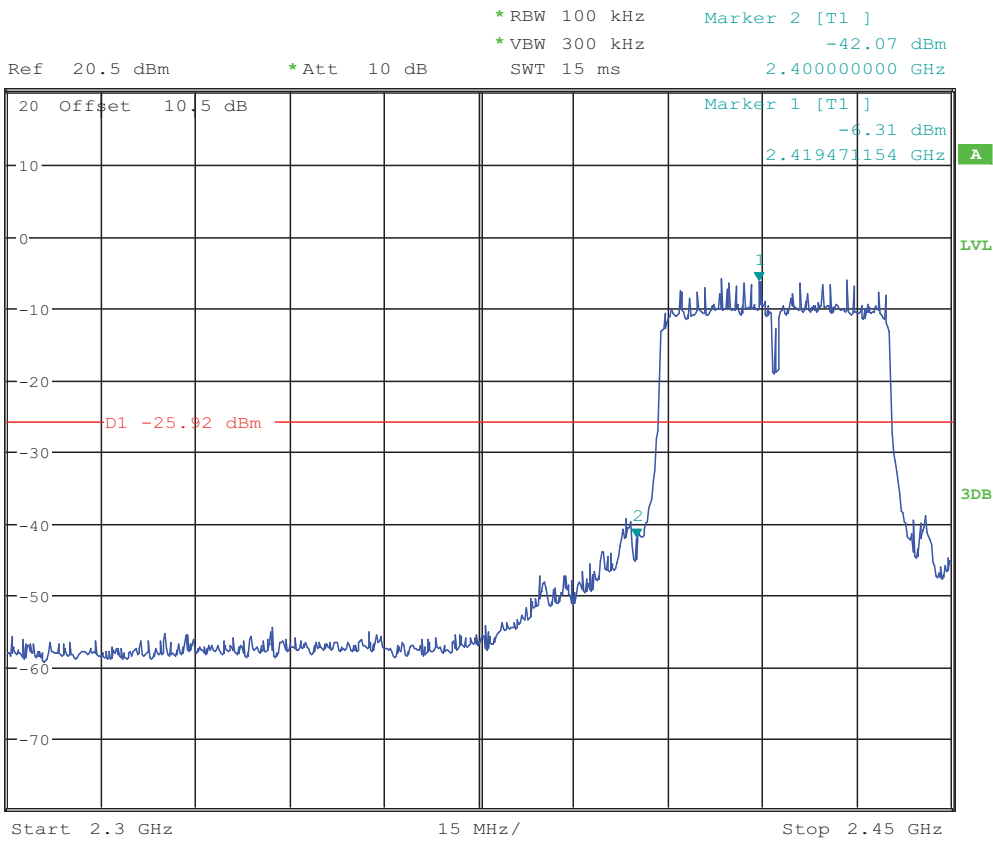
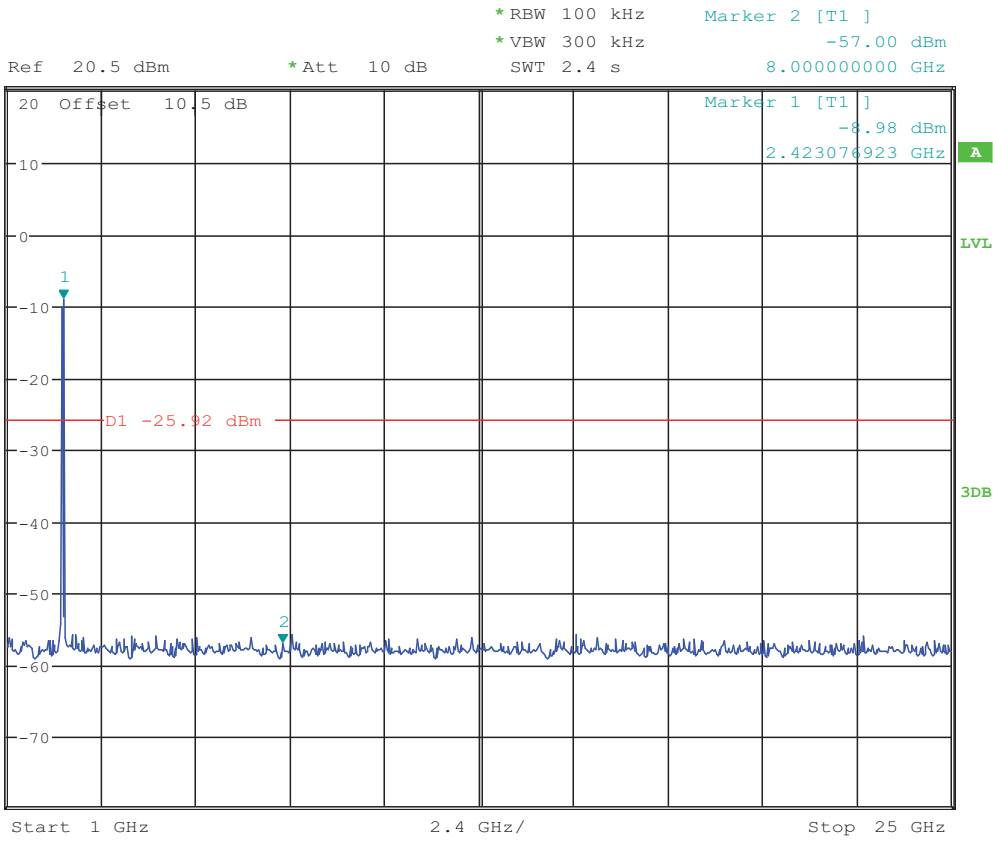

11n HT40 CH6:



*RBW 100 kHz Marker 1 [T1]
*VBW 300 kHz -5.72 dBm
SWT 20 ms 2.429467949 GHz

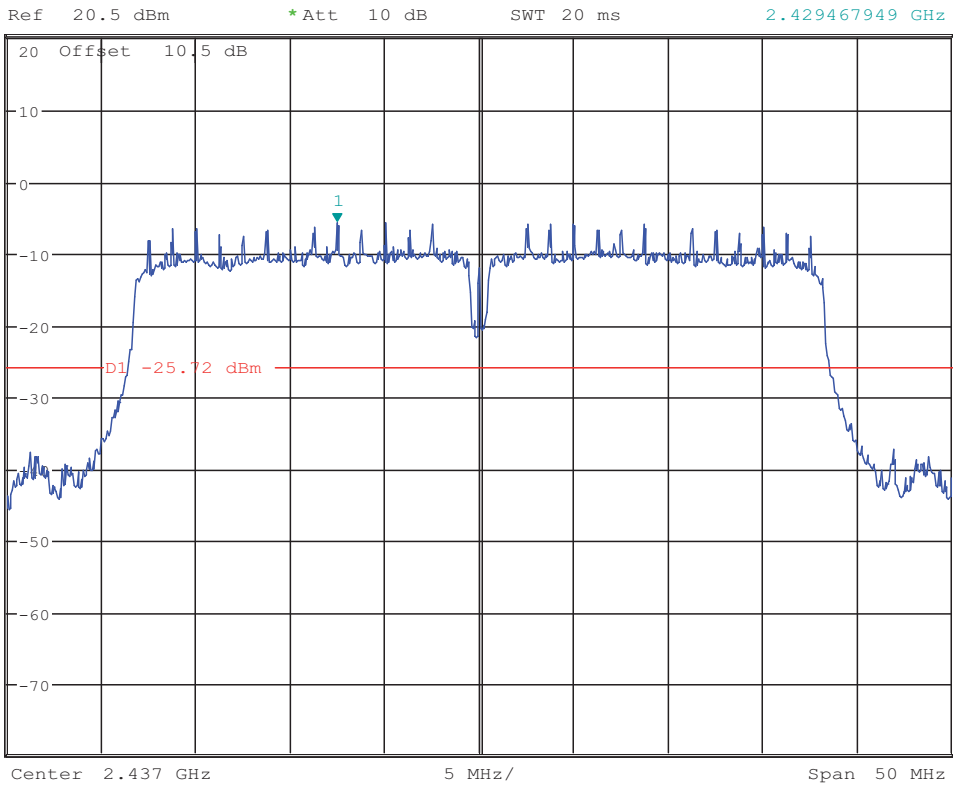

*RBW 100 kHz Marker 1 [T1]
*VBW 300 kHz -53.86 dBm
SWT 100 ms 123.269230769 MHz

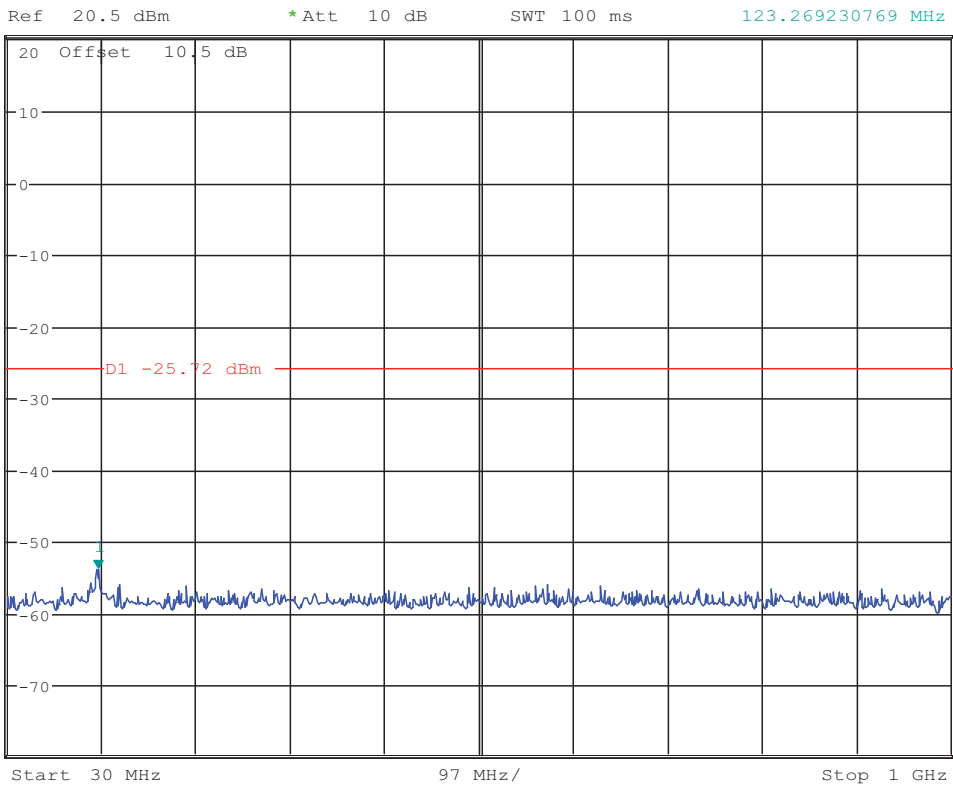



Ref 20.5 dBm *Att 10 dB *RBW 100 kHz Marker 2 [T1]
*VBW 300 kHz -56.30 dBm
SWT 2.4 s 10.076923077 GHz

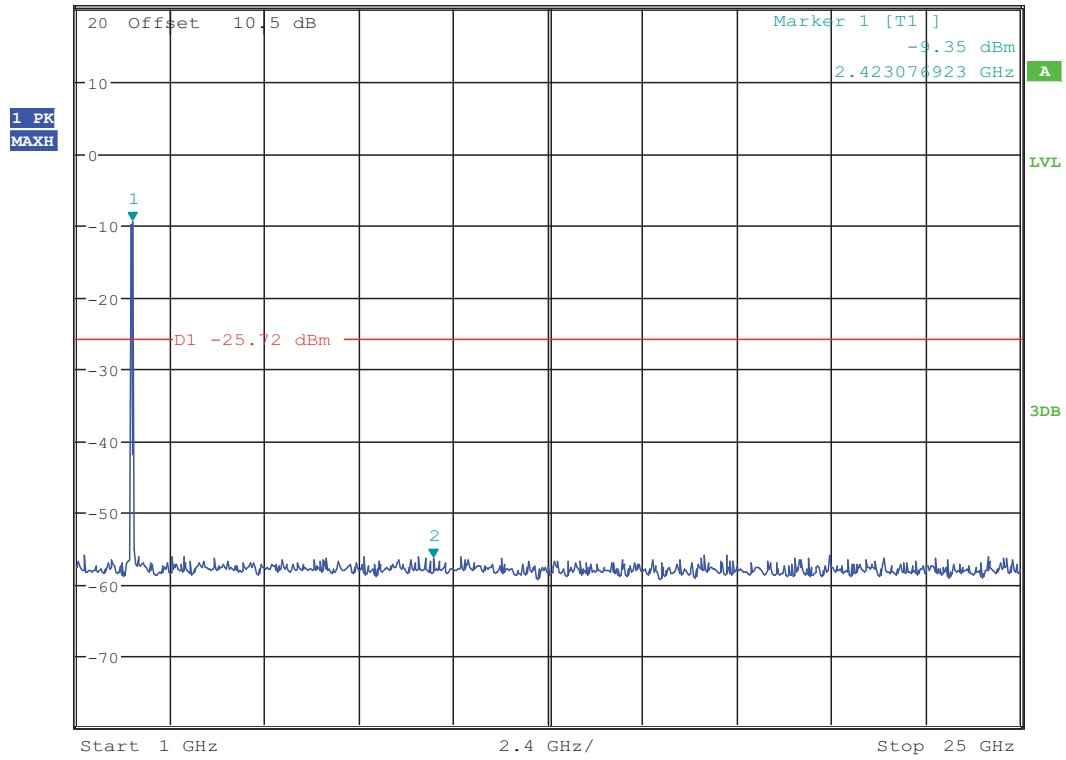

11n HT40 CH9:



Ref 20.5 dBm *Att 10 dB *RBW 100 kHz Marker 1 [T1]
*VBW 300 kHz -5.79 dBm
SWT 20 ms 2.449516026 GHz

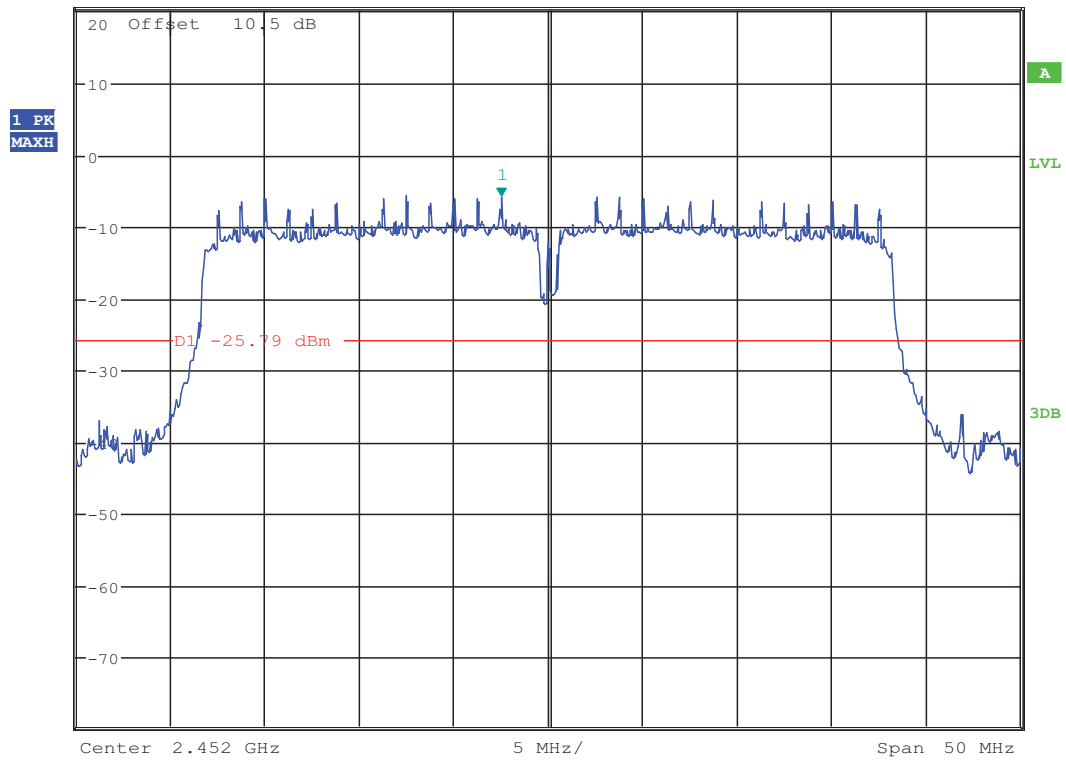

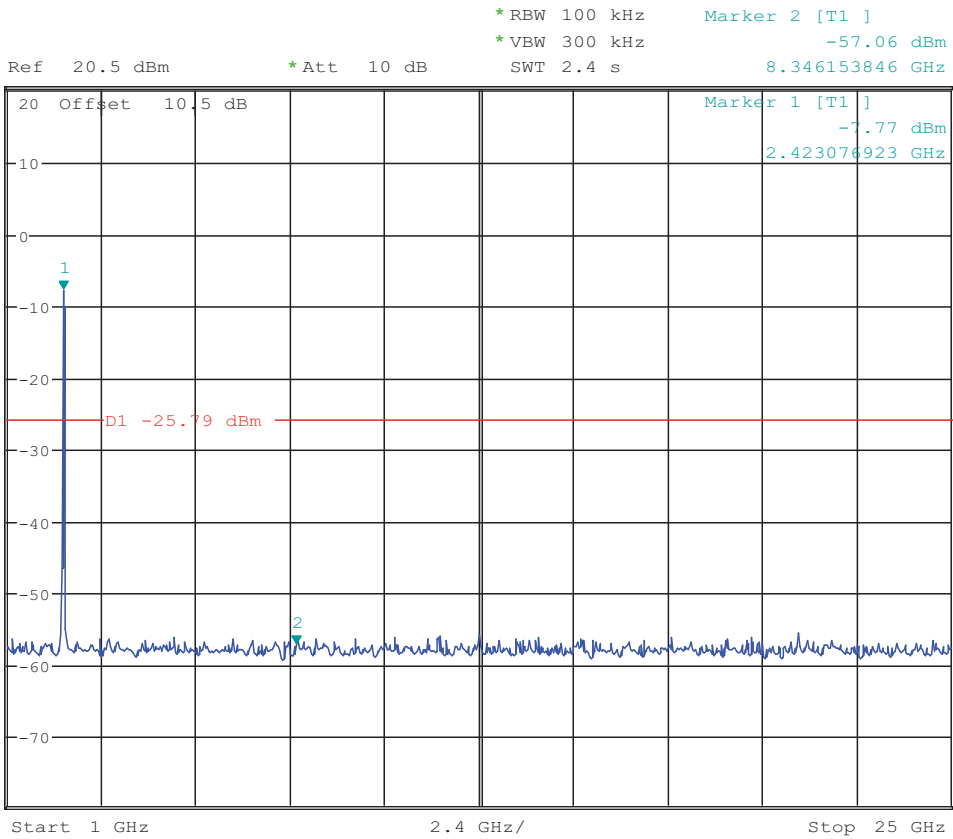
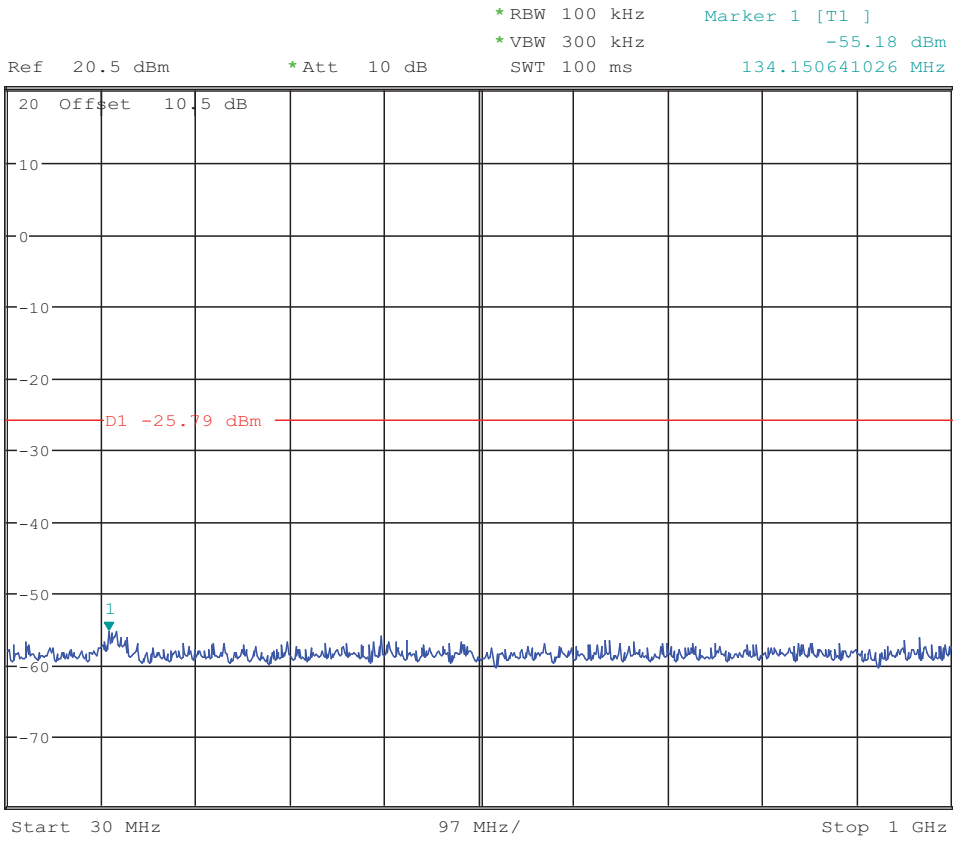

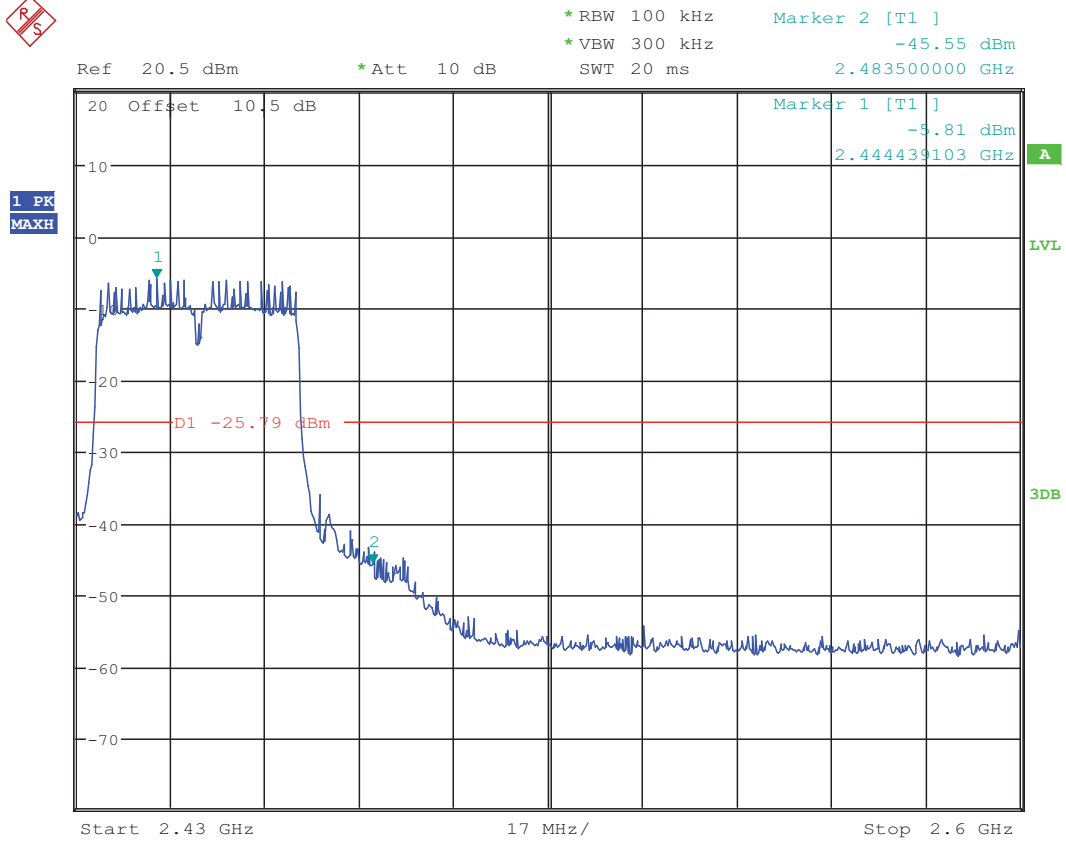

7. Emissions in restricted frequency bands

7.1. Test equipment

Item	Equipment	Manufacturer	Model No.	Serial No.	Last Cal.	Cal. Interval
1	EMI Test Receiver	R&S	ESU8	100316	2012/11/26	1 Year
2	Spectrum analyzer	R&S	FSU	1166.1660.26	2012/11/26	1 Year
3	Active Loop antenna	Schwarzbeck	FMZB1519	1519-038	2012/11/26	1 Year
4	Trilog Broadband Antenna	Schwarzbeck	VULB9163	9163-462	2012/11/26	1 Year
5	Double Ridged Horn Antenna	R&S	HF907	100276	2012/11/26	1 Year
6	Horn Antenna	EMCO	3116	00060095	2012/11/26	1 Year
7	Pre-Amplifier	R&S	SCU-01	10049	2012/11/26	1 Year
8	Pre-amplifier	A.H.	PAM0-0118	360	2012/11/26	1 Year
9	Pre-amplifier	A.H.	PAM-1840VH	562	2012/11/26	1 Year
10	RF Cable	R&S	R01	10403	2012/11/26	1 Year
11	RF Cable	R&S	R02	10512	2012/11/26	1 Year

7.2. Block diagram of test setup

In 3m Anechoic Chamber Test Setup Diagram for 9KHz-30MHz

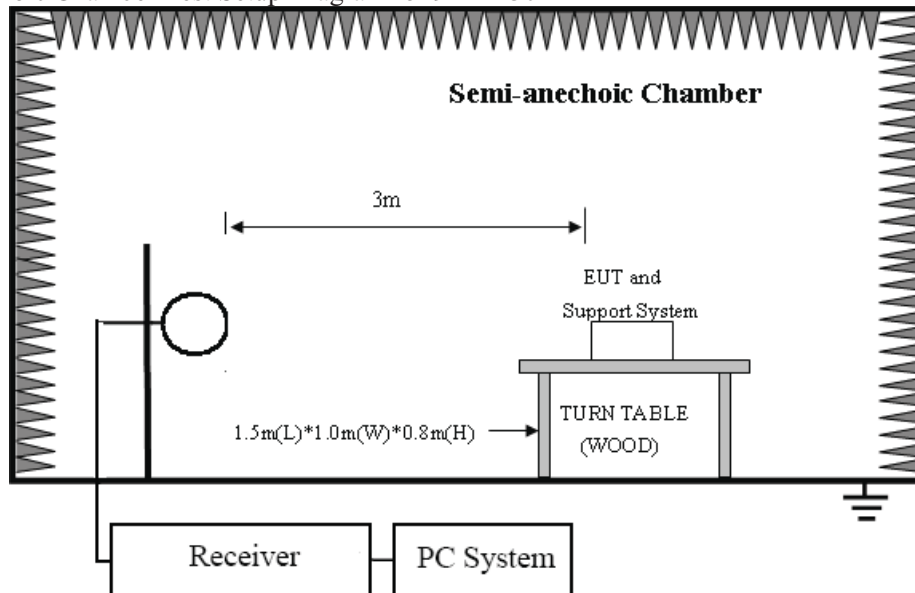

In 3m Anechoic Chamber Test Setup Diagram for 30MHz-1GHz

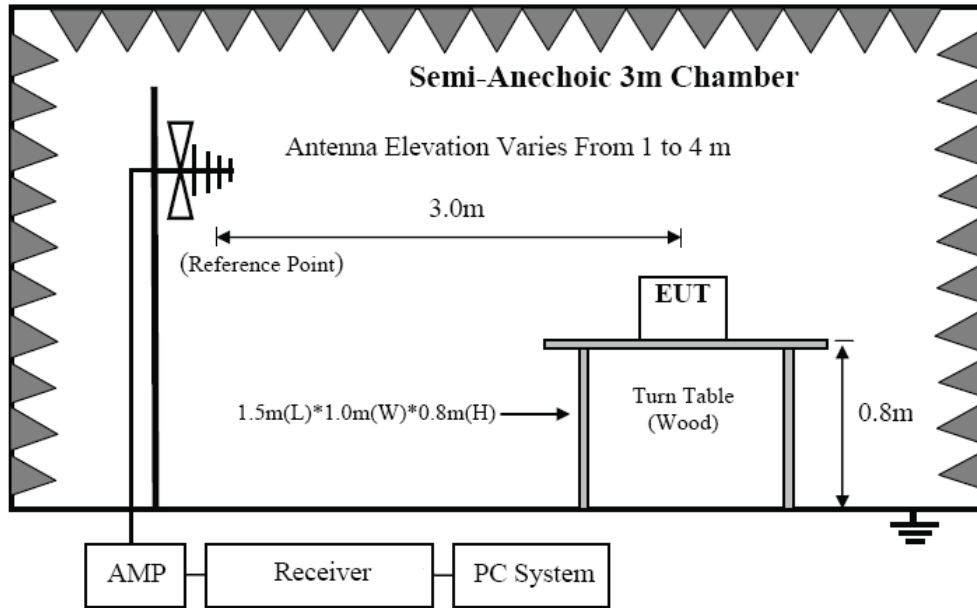

In 3m Anechoic Chamber Test Setup Diagram for frequency above 1GHz

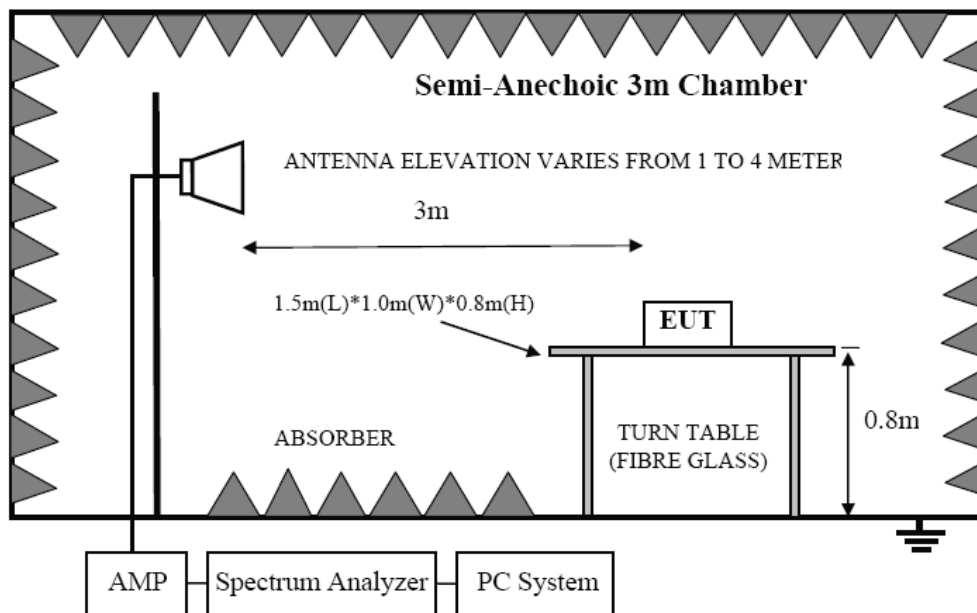

Note: For harmonic emissions test a appropriate high pass filter was inserted in the input port of AMP.

7.3. Limit

8.3.1 FCC 15.205 Restricted frequency band

MHz	MHz	MHz	GHz
0.090 - 0.110	16.42 - 16.423	399.9 - 410	4.5 - 5.15
¹ 0.495 - 0.505	16.69475 - 16.69525	608 - 614	5.35 - 5.46
2.1735 - 2.1905	16.80425 - 16.80475	960 - 1240	7.25 - 7.75
4.125 - 4.128	25.5 - 25.67	1300 - 1427	8.025 - 8.5
4.17725 - 4.17775	37.5 - 38.25	1435 - 1626.5	9.0 - 9.2
4.20725 - 4.20775	73 - 74.6	1645.5 - 1646.5	9.3 - 9.5
6.215 - 6.218	74.8 - 75.2	1660 - 1710	10.6 - 12.7
6.26775 - 6.26825	108 - 121.94	1718.8 - 1722.2	13.25 - 13.4
6.31175 - 6.31225	123 - 138	2200 - 2300	14.47 - 14.5
8.291 - 8.294	149.9 - 150.05	2310 - 2390	15.35 - 16.2
8.362 - 8.366	156.52475 - 156.52525	2483.5 - 2500	17.7 - 21.4
8.37625 - 8.38675	156.7 - 156.9	2690 - 2900	22.01 - 23.12
8.41425 - 8.41475	162.0125 - 167.17	3260 - 3267	23.6 - 24.0
12.29 - 12.293	167.72 - 173.2	3332 - 3339	31.2 - 31.8
12.51975 - 12.52025	240 - 285	3345.8 - 3358	36.43 - 36.5
12.57675 - 12.57725	322 - 335.4	3600 - 4400	(²)

8.3.2 FCC 15.209 Limit.

FREQUENCY MHz	DISTANCE Meters	FIELD STRENGTHS LIMIT	
		μV/m	dB(μV)/m
0.009 ~ 0.490	300	2400/F(KHz)	67.6-20log(F)
0.490 ~ 1.705	30	24000/F(KHz)	87.6-20log(F)
1.705 ~ 30.0	30	30	29.54
30 ~ 88	3	100	40.0
88 ~ 216	3	150	43.5
216 ~ 960	3	200	46.0
960 ~ 1000	3	500	54.0
Above 1000	3	74.0 dB(μV)/m (Peak) 54.0 dB(μV)/m (Average)	

Note: (1)The emission limits shown in the above table are based on measurements employing a CISPR QP detector except for the frequency bands 9-90KHz, 110-490KHz and above 1000MHz. Radiated emissions limits in these three bands are based on measurements employing an average detector.

(2) At frequencies below 30MHz, measurement may be performed at a distance closer than that specified, and the limit at closer measurement distance can be extrapolated by below formula:

$$\text{Limit}_{3m}(\text{dB}\mu\text{V}/\text{m}) = \text{Limit}_{30m}(\text{dB}\mu\text{V}/\text{m}) + 40\text{Log}(30\text{m}/3\text{m})$$

8.3.3 Limit for this EUT

All the emissions appearing within 15.205 restricted frequency bands shall not exceed the limits shown in 15.209, all the other emissions shall be at least 20dB below the fundamental emissions, or comply with 15.209 limits.

7.4. Test Procedure

- (1) EUT was placed on a non-metallic table, 80 cm above the ground plane inside a semi-anechoic chamber.
- (2) Setup EUT and assistant system according clause 2.4 and 7.2
- (3) Test antenna was located 3m from the EUT on an adjustable mast, and the antenna used as below table.

Test frequency range	Test antenna used
9KHz-30MHz	Active Loop antenna
30MHz-1GHz	Trilog Broadband Antenna
1GHz-18GHz	Double Ridged Horn Antenna(1GHz-18GHz)
18GHz-40GHz	Horn Antenna(18GHz-40GHz)

ANSI C63.4:2003; ANSI C63.10:2009 clause 6.4.4.2 and 6,5.3, for measurements below 30 MHz, the loop antenna was positioned with its plane vertical from the EUT and rotated about its vertical axis for maximum response at each azimuth position around the EUT. And the loop antenna also be positioned with its plane horizontal at the specified distance from the EUT. The center of the loop is 1 m above the ground. for measurement above 30MHz, the Trilog Broadband Antenna or Horn Antenna was located 3m from EUT, Measurements were made with the antenna positioned in both the horizontal and vertical planes of Polarization, and the measurement antenna was varied from 1 m to 4 m. in height above the reference ground plane to obtain the maximum signal strength.

- (4) Below pre-scan procedure was first performed in order to find prominent frequency spectrum radiated emissions from 9KHz to 25GHz:

(a) Scanning the peak frequency spectrum with the antenna specified in step (3), and the EUT was rotated 360 degree, the antenna height was varied from 1m to 4m(Except loop antenna, it's fixed 1m above ground.)

(b) Change work frequency or channel of device if practicable.

(c) Change modulation type of device if practicable.

(d) Change power supply range from 85% to 115% of the rated supply voltage

(e) Rotated EUT though three orthogonal axes to determine the attitude of EUT arrangement produces highest emissions.

Spectrum frequency from 9KHz to 25GHz (tenth harmonic of fundamental frequency) was investigated, and no any obvious emission were detected from 18GHz to 25GHz, so below final test was performed with frequency range from 9KHz to 18GHz.

- (5) For final emissions measurements at each frequency of interest, the EUT was rotated and the antenna height was varied between 1m and 4m in order to maximize the emission. Measurements in both horizontal and vertical polarities were made and the data was recorded. In order to find the maximum emission, the relative positions of equipments and all of the interface cables were changed according to

ANSI C63.4:2003; ANSI C63.10:2009 on Radiated Emission test.

- (6) The emissions from 9KHz to 1GHz were measured based on CISPR QP detector except for the

frequency bands 9-90KHz, 110-490KHz, for emissions from 9KHz-90KHz,110KHz-490KHz and above 1GHz were measured based on average detector, for emissions above 1GHz, peak emissions also be measured and need comply with Peak limit.

- (7) The emissions from 9KHz to 1GHz, QP or average values were measured with EMI receiver with below RBW

Frequency band	RBW
9KHz-150KHz	200Hz
150KHz-30MHz	9KHz
30MHz-1GHz	120KHz

- (8) For emissions above 1GHz, both Peak and Average level were measured with Spectrum Analyzer, and the RBW is set at 1MHz, VBW is set at 3MHz for Peak measure; RBW is set at 1MHz, VBW is set at 10Hz for Average measure(according ANSI C63.10:2009 clause 4.2.3.2.3 procedure for average measure). (Also according to ANSI C63.4:2003)

7.5. Test result

PASS. (See below detailed test result)

All the emissions except fundamental emission from 9KHz to 25GHz were comply with 15.209 limit.

Note1: According exploratory test no any obvious emission were detected from 18GHz to 25GHz, so the final test was performed with frequency range from 9KHz to 18GHz and recorded in below.

Note2: For emissions below 1GHz, according exploratory explorer test, when change Tx mode and channel, have no distinct influence on emissions level, so for emissions below 1GHz, the final test was only performed with EUT working in 11b, Tx CH6 mode.

Note3: For emissions above 1GHz. If peak results comply with AV limit, AV Result is deemed to comply with AV limit.

Note4: For below test data, when the limit tabular marked “/” means this frequency point is the fundamental emission and no need comply with this limit.

Radiated Emission Test Result

Test Site	: DDT 3m Chamber	E:\2013 Report data\13QE0070\RE.EM6
Test Date	: 2013-08-08	Tested By : Leo
EUT	: GuruPlug	Model Number : 003-GP0XXXXXX
Power Supply	: AC 120V/60Hz	Test Mode : Tx Mode
Condition	: Temp:24.5'C,Humi:55%, Press:100.1kPa	Antenna/Distance : 2013 VULB9163/3m/HORIZONTAL
Memo	:	

Data: 1

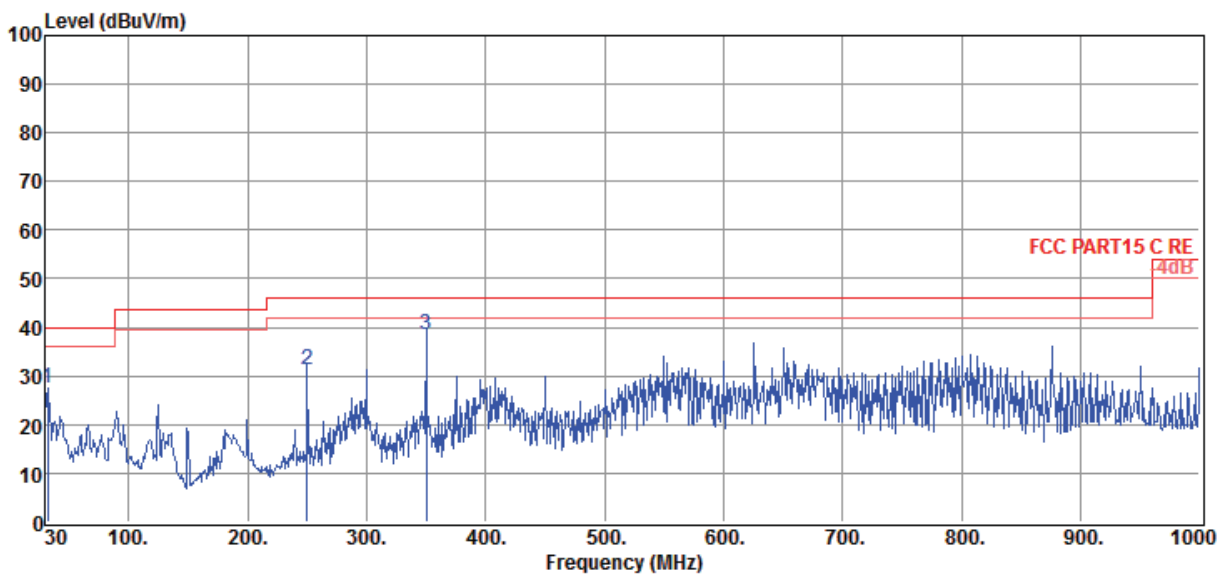

Item (Mark)	Freq (MHz)	Read Level (dBμV)	Antenna Factor (dB/m)	PRM Factor dB	Cable Loss dB	Result Level (dBμV/m)	Limit Line (dBμV/m)	Over Limit (dB)	Detector	Polarization
1	31.94	51.12	13.15	37.45	0.81	27.63	40.00	-12.37	QP	HORIZONTAL
2	250.19	59.84	11.80	42.66	2.40	31.38	46.00	-14.62	QP	HORIZONTAL
3	350.10	65.89	12.50	42.92	2.89	38.36	46.00	-7.64	QP	HORIZONTAL

Note: 1. Result Level = Read Level + Antenna Factor + Cable loss - PRM Factor
 2. If Peak Result comply with QP limit, QP Result is deemed to comply with QP limit
 3. Test setup: RBW: 120kHz, VBW: 300kHz, Sweep time: auto

Radiated Emission Test Result

Test Site	: DDT 3m Chamber	E:\2013 Report data\13QE0070\RE.EM6	
Test Date	: 2013-08-08	Tested By	: Leo
EUT	: GuruPlug	Model Number	: 003-GP0XXXXXX
Power Supply	: AC 120V/60Hz	Test Mode	: Tx Mode
Condition	: Temp:24.5'C,Humi:55%, Press:100.1kPa	Antenna/Distance	: 2013 VULB9163/3m/VERTICAL
Memo	:		

Data: 4

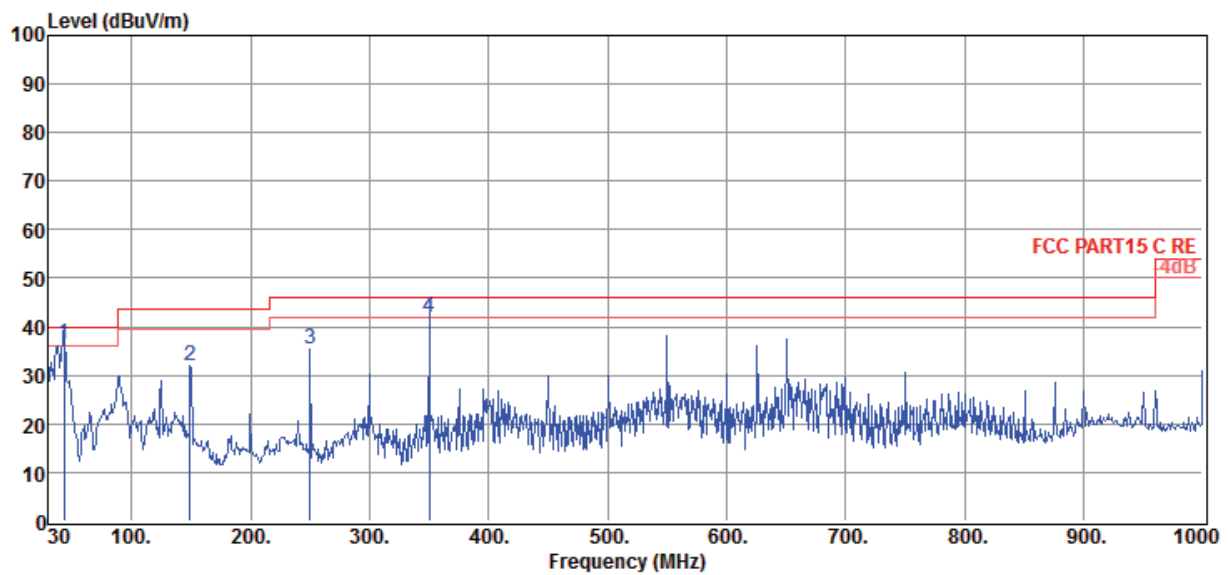

Item (Mark)	Freq (MHz)	Read Level (dBμV)	Antenna Factor (dB/m)	PRM Factor dB	Cable Loss dB	Result Level (dBμV/m)	Limit Line (dBμV/m)	Over Limit (dB)	Detector	Polarization
1	42.85	59.50	13.40	37.45	0.95	36.40	40.00	-3.60	QP	VERTICAL
2	149.31	64.22	7.50	41.70	1.81	31.83	43.50	-11.67	QP	VERTICAL
3	250.19	63.83	11.80	42.66	2.40	35.37	46.00	-10.63	QP	VERTICAL
4	350.10	69.44	12.50	42.92	2.89	41.91	46.00	-4.09	QP	VERTICAL

Note: 1. Result Level = Read Level + Antenna Factor + Cable loss - PRM Factor
 2. If Peak Result comply with QP limit, QP Result is deemed to comply with QP limit
 3. Test setup: RBW: 120kHz, VBW: 300kHz, Sweep time: auto

Radiated Emission Test Result

Test Site	: DDT 3m Chamber	E:\2013 Report data\13QE0070\RE 1G-18G.EM6
Test Date	: 2013-08-08	Tested By : Leo Liu
EUT	: GuruPlug	Model Number : 003-GP0XXXXXX
Power Supply	: AC 120V/60Hz	Test Mode : 11b CH1
Condition	: Temp:24.5'C,Humi:55%, Press:100.1kPa	Antenna/Distance : 2013 HF907/3m/HORIZONTAL
Memo	:	

Data: 1

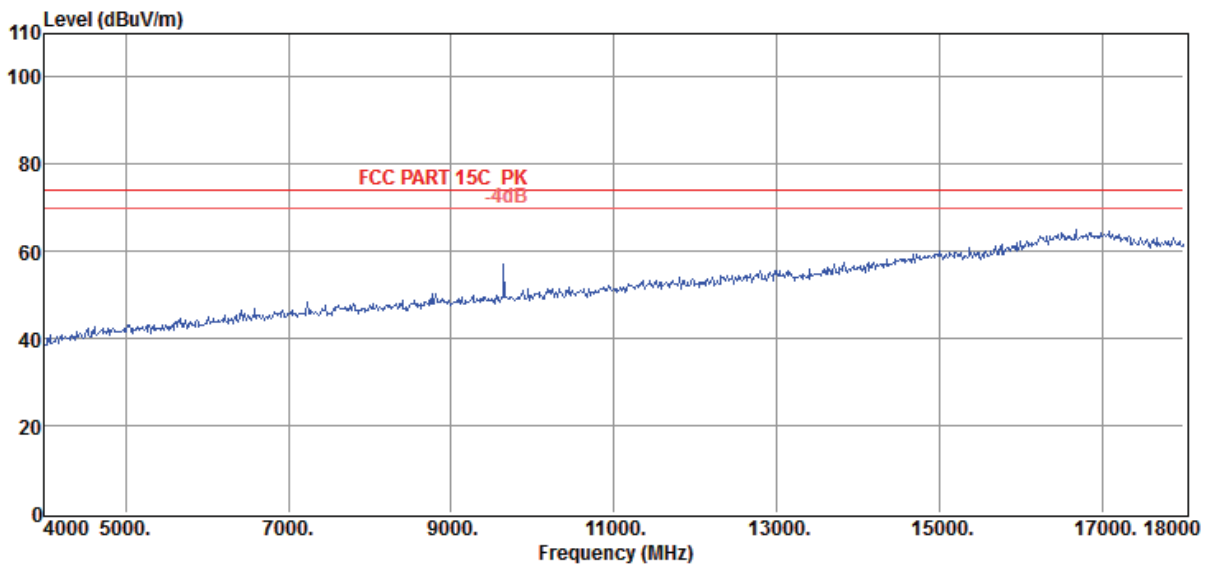

Item	Freq	Read Level	Antenna Factor	PRM Factor	Cable Loss	Result Level	Limit Line	Over Limit	Detector	Polarization
(Mark)	(MHz)	(dBμV)	(dB/m)	dB	dB	(dBμV/m)	(dBμV/m)	(dB)		

- Note: 1. Result Level = Read Level + Antenna Factor + Cable loss - PRM Factor
 2. If Peak Result comply with AV limit, AV Result is deemed to comply with AV limit
 3. Test setup: RBW: 1MHz, VBW: 3MHz, Sweep time:auto

Radiated Emission Test Result

Test Site : DDT 3m Chamber **E:\2013 Report data\13QE0070\RE 1G-18G.EM6**
Test Date : 2013-08-08 **Tested By** : Leo Liu
EUT : GuruPlug **Model Number** : 003-GP0XXXXXX
Power Supply : AC 120V/60Hz **Test Mode** : 11b CH1
Condition : Temp:24.5'C,Humi:55%,
 Press:100.1kPa **Antenna/Distance** : 2013 HF907/3m/HORIZONTAL
Memo :

Data: 2

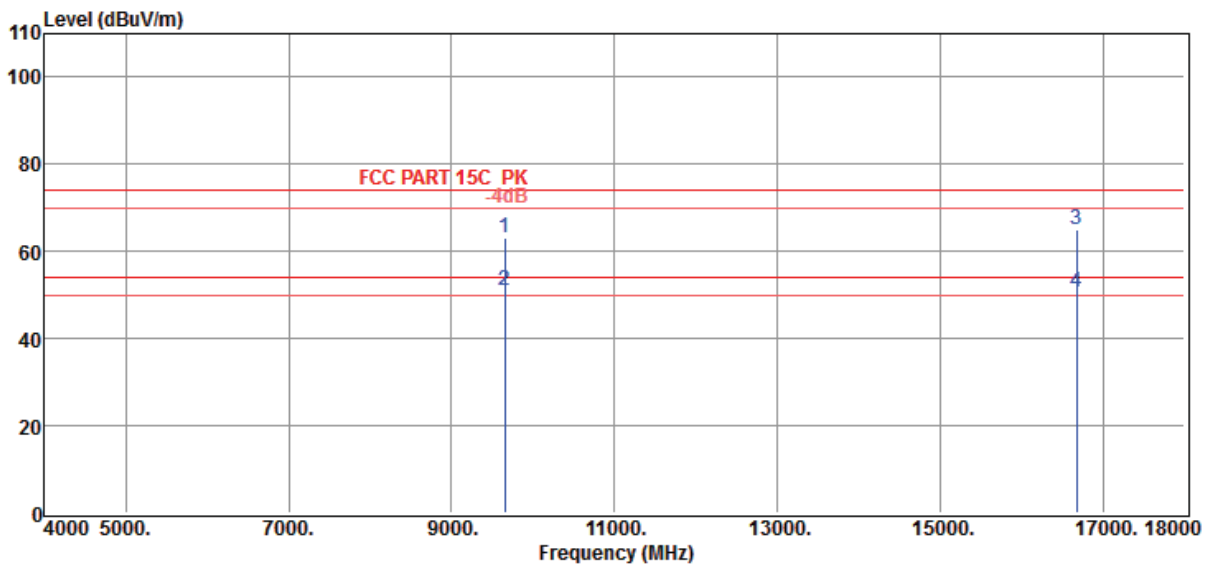

Item (Mark)	Freq (MHz)	Read Level (dBμV)	Antenna Factor (dB/m)	PRM Factor (dB)	Cable Loss (dB)	Result Level (dBμV/m)	Limit Line (dBμV/m)	Over Limit (dB)	Detector	Polarization
1	9648.00	50.83	38.12	43.87	18.02	63.10	74.00	-10.90	Peak	HORIZONTAL
2	9648.00	38.71	38.12	43.87	18.02	50.98	54.00	-3.02	Average	HORIZONTAL
3	16670.00	36.44	43.67	40.27	25.00	64.84	74.00	-9.16	Peak	HORIZONTAL
4	16670.00	22.35	43.67	40.27	25.00	50.75	54.00	-3.25	Average	HORIZONTAL

Note: 1. Result Level = Read Level + Antenna Factor + Cable loss - PRM Factor
 2. If Peak Result comply with AV limit, AV Result is deemed to comply with AV limit
 3. Test setup: RBW: 1MHz, VBW: 3MHz, Sweep time:auto

Radiated Emission Test Result

Test Site	: DDT 3m Chamber	E:\2013 Report data\13QE0070\RE 1G-18G.EM6
Test Date	: 2013-08-08	Tested By : Leo Liu
EUT	: GuruPlug	Model Number : 003-GP0XXXXXX
Power Supply	: AC 120V/60Hz	Test Mode : 11b CH1
Condition	: Temp:24.5'C,Humi:55%, Press:100.1kPa	Antenna/Distance : 2013 HF907/3m/VERTICAL
Memo	:	

Data: 3

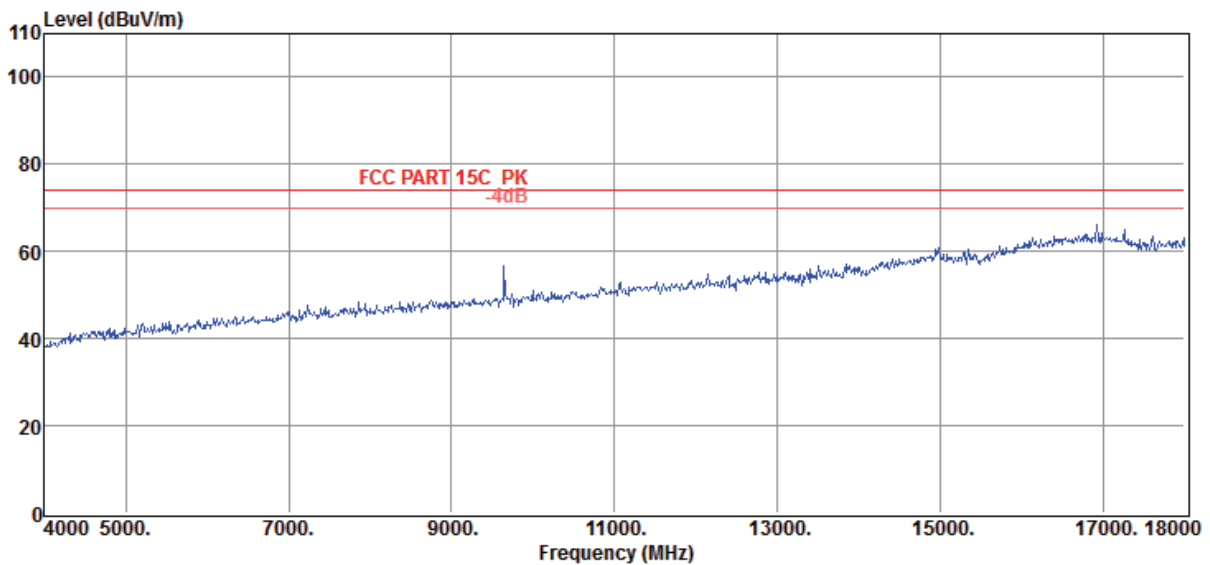

Item	Freq	Read Level	Antenna Factor	PRM Factor	Cable Loss	Result Level	Limit Line	Over Limit	Detector	Polarization
(Mark)	(MHz)	(dBμV)	(dB/m)	dB	dB	(dBμV/m)	(dBμV/m)	(dB)		

- Note: 1. Result Level = Read Level + Antenna Factor + Cable loss - PRM Factor
 2. If Peak Result comply with AV limit, AV Result is deemed to comply with AV limit
 3. Test setup: RBW: 1MHz, VBW: 3MHz, Sweep time:auto

Radiated Emission Test Result

Test Site	: DDT 3m Chamber	E:\2013 Report data\13QE0070\RE 1G-18G.EM6
Test Date	: 2013-08-08	Tested By : Leo Liu
EUT	: GuruPlug	Model Number : 003-GP0XXXXXX
Power Supply	: AC 120V/60Hz	Test Mode : 11b CH1
Condition	: Temp:24.5'C,Humi:55%, Press:100.1kPa	Antenna/Distance : 2013 HF907/3m/VERTICAL
Memo	:	

Data: 4

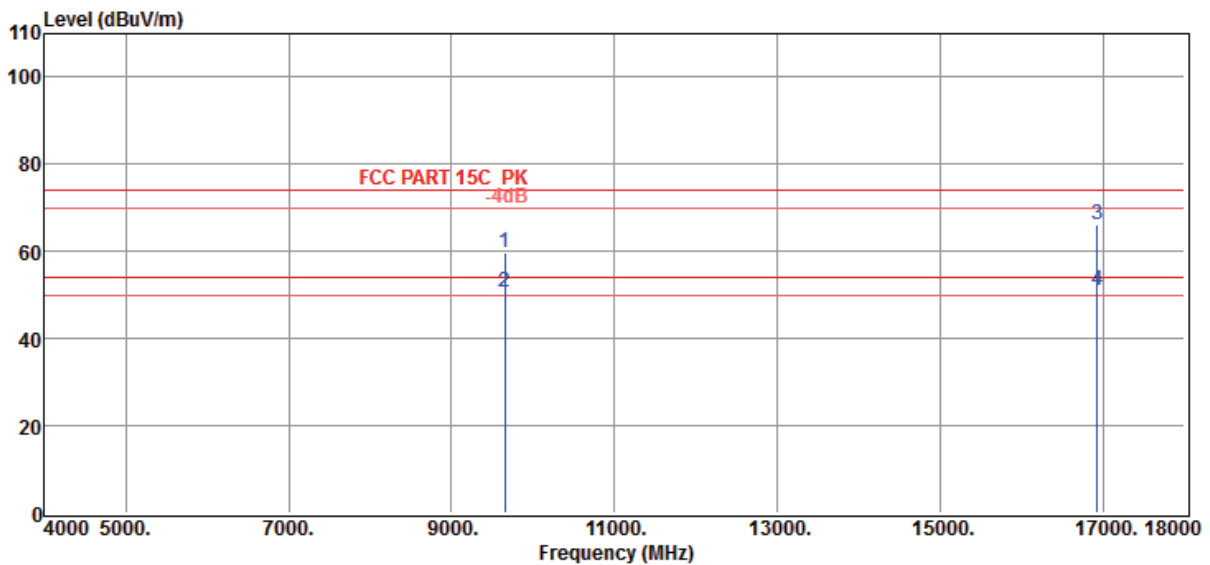

Item (Mark)	Freq (MHz)	Read Level (dBμV)	Antenna Factor (dB/m)	PRM Factor dB	Cable Loss dB	Result Level (dBμV/m)	Limit Line (dBμV/m)	Over Limit (dB)	Detector	Polarization
1	9648.00	47.48	38.12	43.87	18.02	59.75	74.00	-14.25	Peak	VERTICAL
2	9648.00	38.37	38.12	43.87	18.02	50.64	54.00	-3.36	Average	VERTICAL
3	16922.00	37.23	43.61	40.37	25.60	66.07	74.00	-7.93	Peak	VERTICAL
4	16922.00	22.36	43.61	40.37	25.60	51.20	54.00	-2.80	Average	VERTICAL

Note: 1. Result Level = Read Level + Antenna Factor + Cable loss - PRM Factor
 2. If Peak Result comply with AV limit, AV Result is deemed to comply with AV limit
 3. Test setup: RBW: 1MHz, VBW: 3MHz, Sweep time:auto

Radiated Emission Test Result

Test Site	: DDT 3m Chamber	E:\2013 Report data\13QE0070\RE 1G-18G.EM6
Test Date	: 2013-08-08	Tested By : Leo Liu
EUT	: GuruPlug	Model Number : 003-GP0XXXXXX
Power Supply	: AC 120V/60Hz	Test Mode : 11b CH6
Condition	: Temp:24.5'C,Humi:55%, Press:100.1kPa	Antenna/Distance : 2013 HF907/3m/VERTICAL
Memo	:	

Data: 5

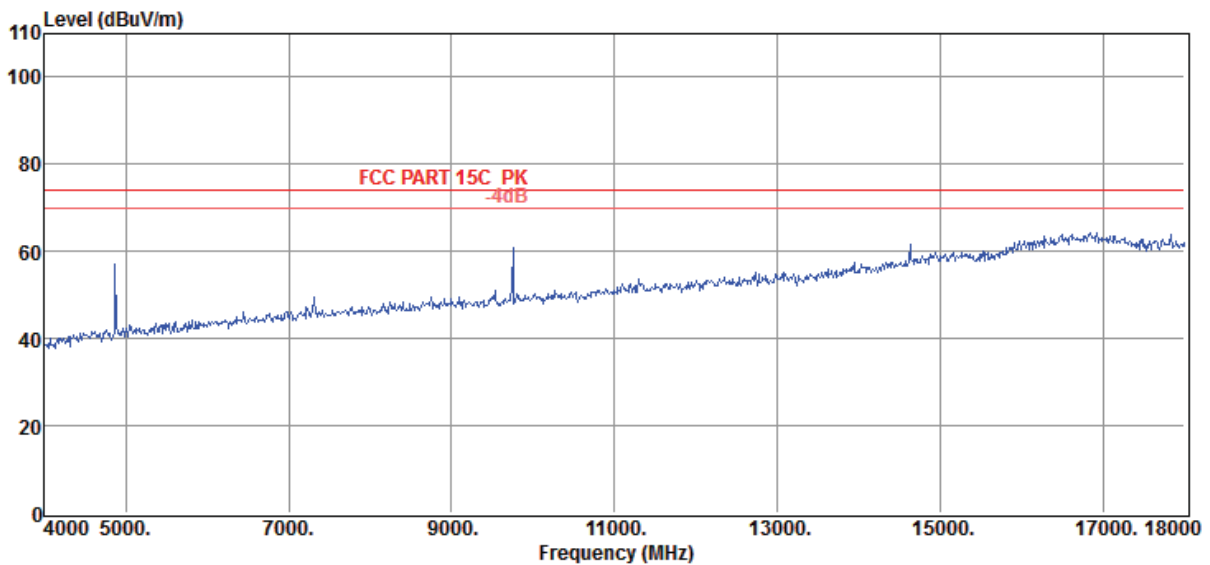

Item (Mark)	Freq (MHz)	Read Level (dBμV)	Antenna Factor (dB/m)	PRM Factor dB	Cable Loss dB	Result Level (dBμV/m)	Limit Line (dBμV/m)	Over Limit (dB)	Detector	Polarization

- Note: 1. Result Level = Read Level + Antenna Factor + Cable loss - PRM Factor
 2. If Peak Result comply with AV limit, AV Result is deemed to comply with AV limit
 3. Test setup: RBW: 1MHz, VBW: 3MHz, Sweep time:auto

Radiated Emission Test Result

Test Site : DDT 3m Chamber **E:\2013 Report data\13QE0070\RE 1G-18G.EM6**
Test Date : 2013-08-08 **Tested By** : Leo Liu
EUT : GuruPlug **Model Number** : 003-GP0XXXXXX
Power Supply : AC 120V/60Hz **Test Mode** : 11b CH6
Condition : Temp:24.5'C,Humi:55%,
Antenna/Distance : 2013 HF907/3m/VERTICAL
 Press:100.1kPa
Memo :

Data: 6

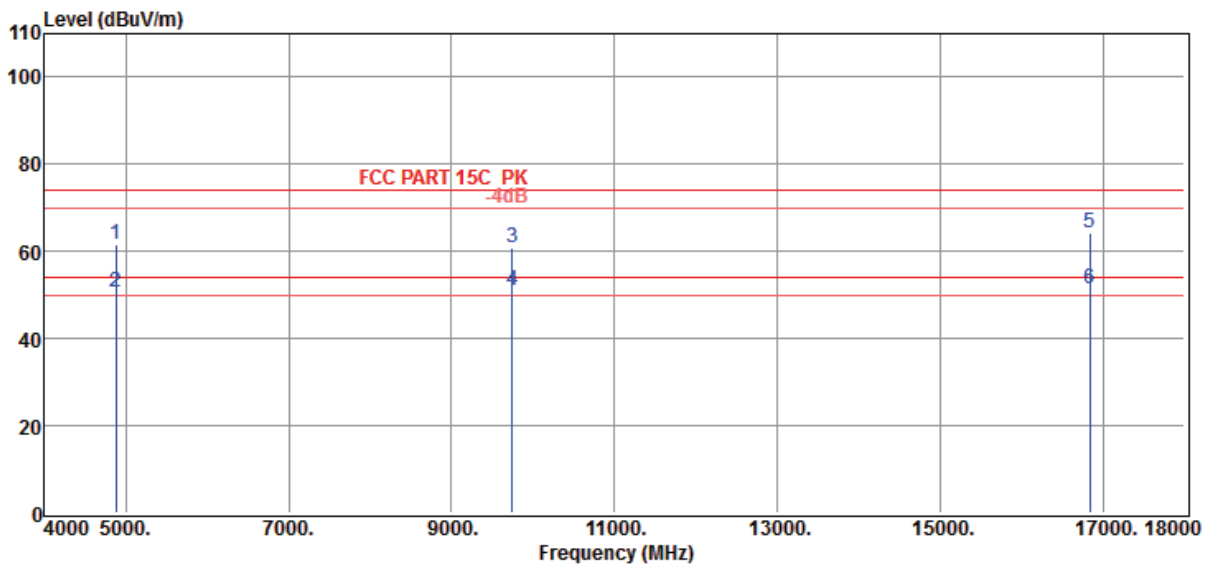

Item (Mark)	Freq (MHz)	Read Level (dBμV)	Antenna Factor (dB/m)	PRM Factor dB	Cable Loss dB	Result Level (dBμV/m)	Limit Line (dBμV/m)	Over Limit (dB)	Detector	Polarization
1	4874.00	58.47	35.51	44.35	12.04	61.67	74.00	-12.33	Peak	VERTICAL
2	4874.00	47.55	35.51	44.35	12.04	50.75	54.00	-3.25	Average	VERTICAL
3	9748.00	48.45	38.21	43.85	18.15	60.96	74.00	-13.04	Peak	VERTICAL
4	9748.00	38.36	38.21	43.85	18.15	50.87	54.00	-3.13	Average	VERTICAL
5	16838.00	35.51	43.63	40.33	25.60	64.41	74.00	-9.59	Peak	VERTICAL
6	16838.00	22.36	43.63	40.33	25.60	51.26	54.00	-2.74	Average	VERTICAL

- Note: 1. Result Level = Read Level + Antenna Factor + Cable loss - PRM Factor
 2. If Peak Result comply with AV limit, AV Result is deemed to comply with AV limit
 3. Test setup: RBW: 1MHz, VBW: 3MHz, Sweep time:auto

Radiated Emission Test Result

Test Site	: DDT 3m Chamber	E:\2013 Report data\13QE0070\RE 1G-18G.EM6
Test Date	: 2013-08-08	Tested By : Leo Liu
EUT	: GuruPlug	Model Number : 003-GP0XXXXXX
Power Supply	: AC 120V/60Hz	Test Mode : 11b CH6
Condition	: Temp:24.5'C,Humi:55%, Press:100.1kPa	Antenna/Distance : 2013 HF907/3m/HORIZONTAL
Memo	:	

Data: 7

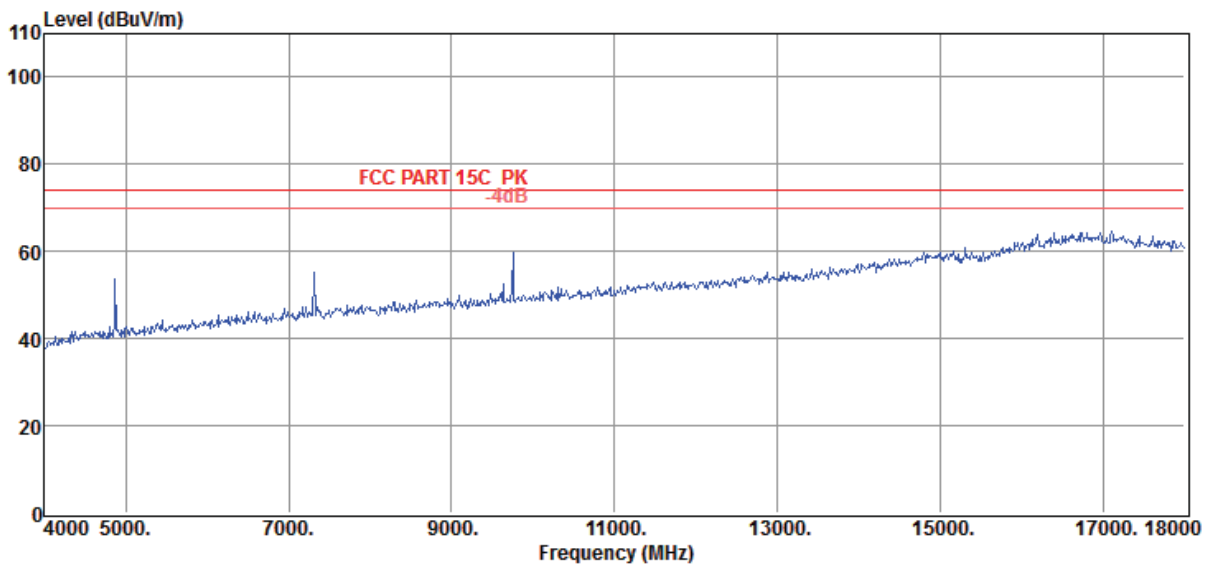

Item (Mark)	Freq (MHz)	Read Level (dBμV)	Antenna Factor (dB/m)	PRM Factor dB	Cable Loss dB	Result Level (dBμV/m)	Limit Line (dBμV/m)	Over Limit (dB)	Detector	Polarization

- Note: 1. Result Level = Read Level + Antenna Factor + Cable loss - PRM Factor
 2. If Peak Result comply with AV limit, AV Result is deemed to comply with AV limit
 3. Test setup: RBW: 1MHz, VBW: 3MHz, Sweep time:auto

Radiated Emission Test Result

Test Site : DDT 3m Chamber **E:\2013 Report data\13QE0070\RE 1G-18G.EM6**
Test Date : 2013-08-08 **Tested By** : Leo Liu
EUT : GuruPlug **Model Number** : 003-GP0XXXXXX
Power Supply : AC 120V/60Hz **Test Mode** : 11b CH6
Condition : Temp:24.5'C,Humi:55%,
 Press:100.1kPa **Antenna/Distance** : 2013 HF907/3m/HORIZONTAL
Memo :

Data: 8

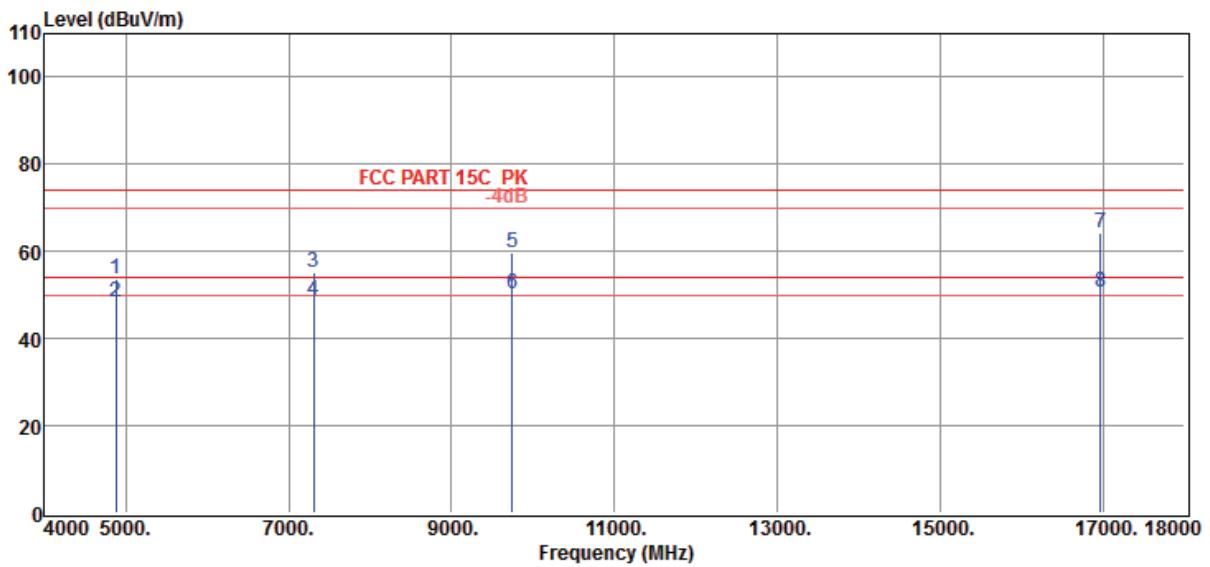

Item (Mark)	Freq (MHz)	Read Level (dBuV)	Antenna Factor (dB/m)	PRM Factor (dB)	Cable Loss (dB)	Result Level (dBuV/m)	Limit Line (dBuV/m)	Over Limit (dB)	Detector	Polarization
1	4874.00	50.40	35.51	44.35	12.04	53.60	74.00	-20.40	Peak	HORIZONTAL
2	4874.00	45.32	35.51	44.35	12.04	48.52	54.00	-5.48	Average	HORIZONTAL
3	7311.00	46.51	37.29	44.07	15.32	55.05	74.00	-18.95	Peak	HORIZONTAL
4	7311.00	40.24	37.29	44.07	15.32	48.78	54.00	-5.22	Average	HORIZONTAL
5	9748.00	47.09	38.21	43.85	18.15	59.60	74.00	-14.40	Peak	HORIZONTAL
6	9748.00	37.58	38.21	43.85	18.15	50.09	54.00	-3.91	Average	HORIZONTAL
7	16964.00	35.57	43.61	40.39	25.60	64.39	74.00	-9.61	Peak	HORIZONTAL
8	16964.00	21.68	43.61	40.39	25.60	50.50	54.00	-3.50	Average	HORIZONTAL

Note: 1. Result Level = Read Level + Antenna Factor + Cable loss - PRM Factor
 2. If Peak Result comply with AV limit, AV Result is deemed to comply with AV limit
 3. Test setup: RBW: 1MHz, VBW: 3MHz, Sweep time:auto

Radiated Emission Test Result

Test Site	: DDT 3m Chamber	E:\2013 Report data\13QE0070\RE 1G-18G.EM6
Test Date	: 2013-08-08	Tested By : Leo Liu
EUT	: GuruPlug	Model Number : 003-GP0XXXXXX
Power Supply	: AC 120V/60Hz	Test Mode : 11b CH11
Condition	: Temp:24.5'C,Humi:55%, Press:100.1kPa	Antenna/Distance : 2013 HF907/3m/HORIZONTAL
Memo	:	

Data: 9

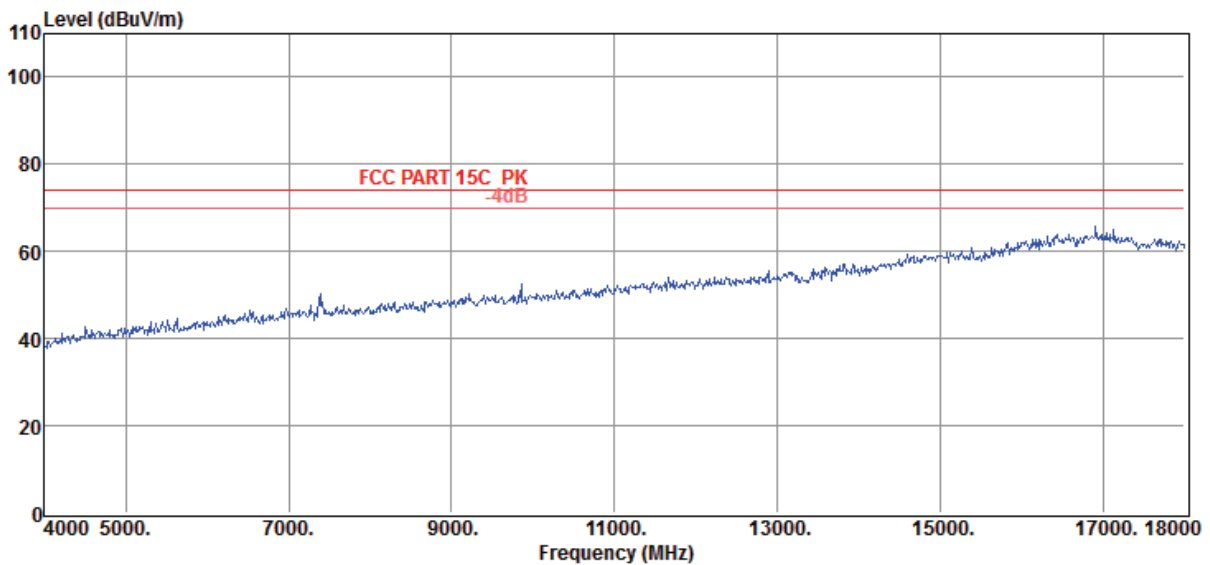

Item (Mark)	Freq (MHz)	Read Level (dBμV)	Antenna Factor (dB/m)	PRM Factor dB	Cable Loss dB	Result Level (dBμV/m)	Limit Line (dBμV/m)	Over Limit (dB)	Detector	Polarization

- Note: 1. Result Level = Read Level + Antenna Factor + Cable loss - PRM Factor
 2. If Peak Result comply with AV limit, AV Result is deemed to comply with AV limit
 3. Test setup: RBW: 1MHz, VBW: 3MHz, Sweep time:auto

Radiated Emission Test Result

Test Site	: DDT 3m Chamber	E:\2013 Report data\13QE0070\RE 1G-18G.EM6
Test Date	: 2013-08-08	Tested By : Leo Liu
EUT	: GuruPlug	Model Number : 003-GP0XXXXXX
Power Supply	: AC 120V/60Hz	Test Mode : 11b CH11
Condition	: Temp:24.5'C,Humi:55%, Press:100.1kPa	Antenna/Distance : 2013 HF907/3m/HORIZONTAL
Memo	:	

Data: 10

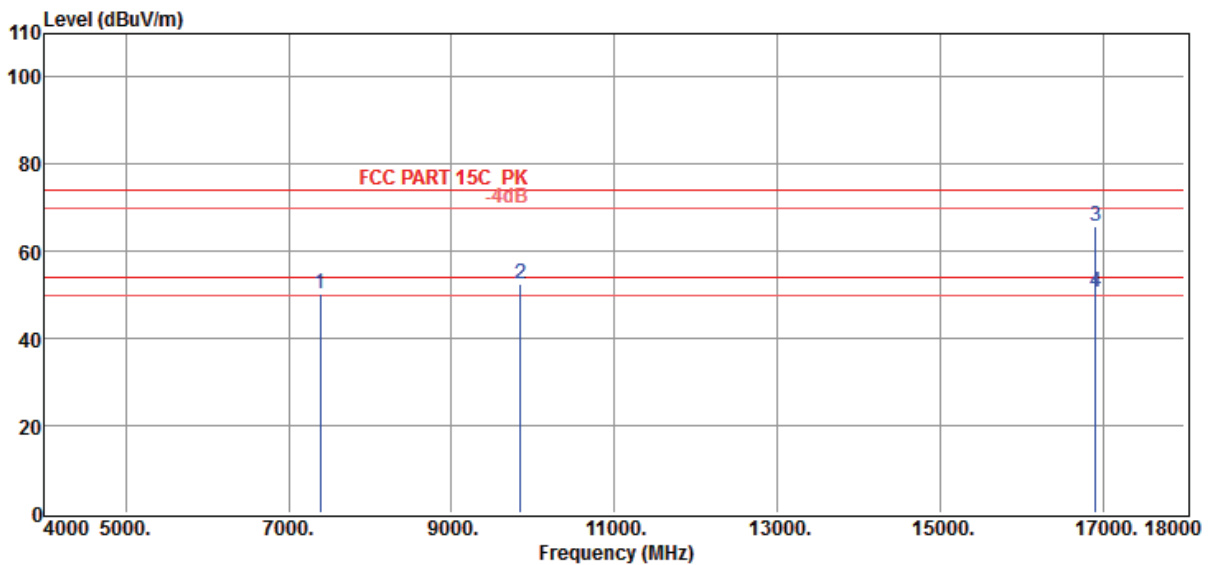

Item (Mark)	Freq (MHz)	Read Level (dBμV)	Antenna Factor (dB/m)	PRM Factor dB	Cable Loss dB	Result Level (dBμV/m)	Limit Line (dBμV/m)	Over Limit (dB)	Detector	Polarization
1	7386.00	41.48	37.34	44.04	15.46	50.24	74.00	-23.76	Peak	HORIZONTAL
2	9848.00	39.98	38.28	43.83	18.27	52.70	74.00	-21.30	Peak	HORIZONTAL
3	16908.00	36.77	43.62	40.36	25.60	65.63	74.00	-8.37	Peak	HORIZONTAL
4	16908.00	21.74	43.62	40.36	25.60	50.60	54.00	-3.40	Average	HORIZONTAL

Note: 1. Result Level = Read Level + Antenna Factor + Cable loss - PRM Factor
 2. If Peak Result comply with AV limit, AV Result is deemed to comply with AV limit
 3. Test setup: RBW: 1MHz, VBW: 3MHz, Sweep time:auto

Radiated Emission Test Result

Test Site	: DDT 3m Chamber	E:\2013 Report data\13QE0070\RE 1G-18G.EM6
Test Date	: 2013-08-08	Tested By : Leo Liu
EUT	: GuruPlug	Model Number : 003-GP0XXXXXX
Power Supply	: AC 120V/60Hz	Test Mode : 11b CH11
Condition	: Temp:24.5'C,Humi:55%, Press:100.1kPa	Antenna/Distance : 2013 HF907/3m/VERTICAL
Memo	:	

Data: 11

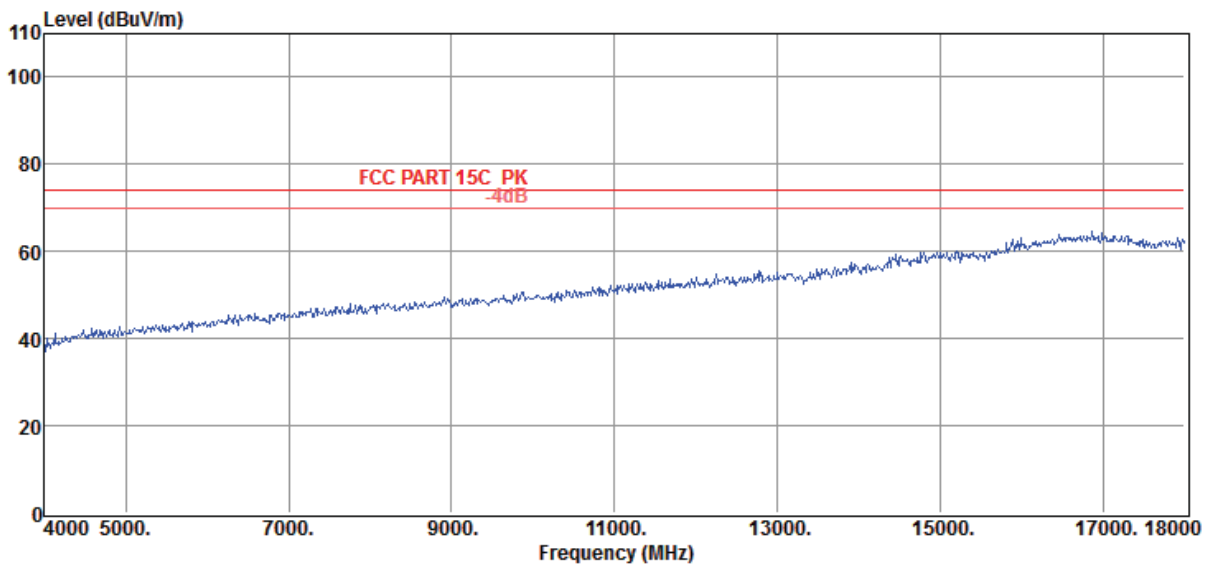

Item (Mark)	Freq (MHz)	Read Level (dBμV)	Antenna Factor (dB/m)	PRM Factor dB	Cable Loss dB	Result Level (dBμV/m)	Limit Line (dBμV/m)	Over Limit (dB)	Detector	Polarization

- Note: 1. Result Level = Read Level + Antenna Factor + Cable loss - PRM Factor
 2. If Peak Result comply with AV limit, AV Result is deemed to comply with AV limit
 3. Test setup: RBW: 1MHz, VBW: 3MHz, Sweep time:auto

Radiated Emission Test Result

Test Site : DDT 3m Chamber	E:\2013 Report data\13QE0070\RE 1G-18G.EM6
Test Date : 2013-08-08	Tested By : Leo Liu
EUT : GuruPlug	Model Number : 003-GP0XXXXXX
Power Supply : AC 120V/60Hz	Test Mode : 11b CH11
Condition : Temp:24.5'C,Humi:55%, Press:100.1kPa	Antenna/Distance : 2013 HF907/3m/VERTICAL
Memo :	

Data: 12

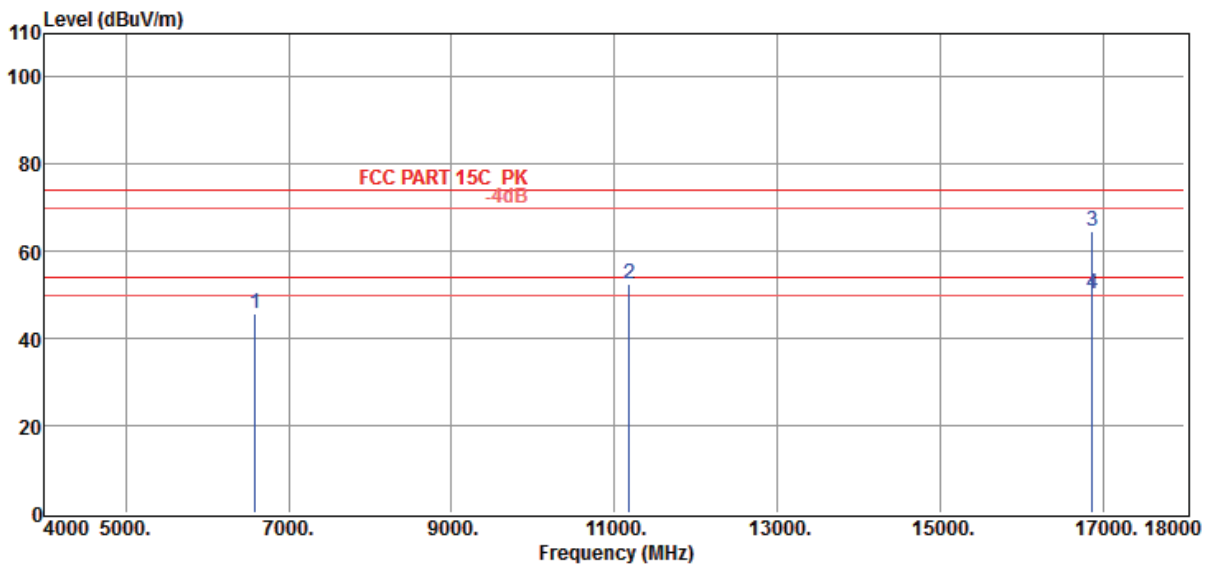

Item (Mark)	Freq (MHz)	Read Level (dBμV)	Antenna Factor (dB/m)	PRM Factor dB	Cable Loss dB	Result Level (dBμV/m)	Limit Line (dBμV/m)	Over Limit (dB)	Detector	Polarization
1	6590.00	38.35	36.36	43.87	14.73	45.57	74.00	-28.43	Peak	VERTICAL
2	11182.00	37.15	38.90	43.35	19.80	52.50	74.00	-21.50	Peak	VERTICAL
3	16866.00	35.64	43.63	40.35	25.60	64.52	74.00	-9.48	Peak	VERTICAL
4	16866.00	21.52	43.63	40.35	25.60	50.40	54.00	-3.60	Average	VERTICAL

Note: 1. Result Level = Read Level + Antenna Factor + Cable loss - PRM Factor
 2. If Peak Result comply with AV limit, AV Result is deemed to comply with AV limit
 3. Test setup: RBW: 1MHz, VBW: 3MHz, Sweep time:auto

Radiated Emission Test Result

Test Site	: DDT 3m Chamber	E:\2013 Report data\13QE0070\RE 1G-18G.EM6
Test Date	: 2013-08-08	Tested By : Leo Liu
EUT	: GuruPlug	Model Number : 003-GP0XXXXXX
Power Supply	: AC 120V/60Hz	Test Mode : 11G CH1
Condition	: Temp:24.5'C,Humi:55%, Press:100.1kPa	Antenna/Distance : 2013 HF907/3m/VERTICAL
Memo	:	

Data: 13

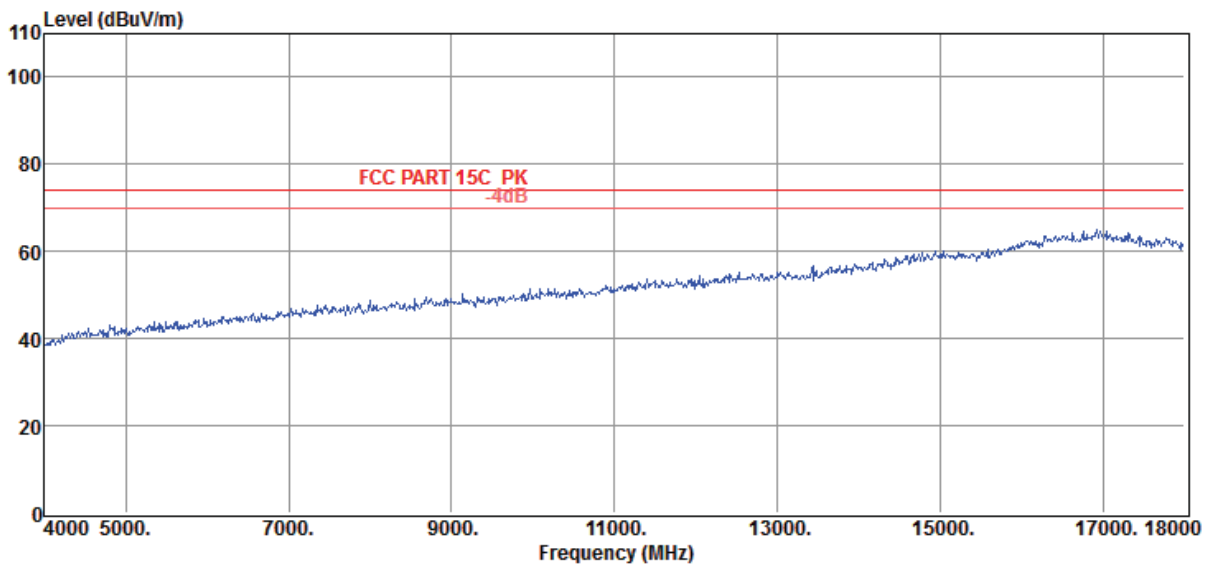

Item	Freq	Read Level	Antenna Factor	PRM Factor	Cable Loss	Result Level	Limit Line	Over Limit	Detector	Polarization
(Mark)	(MHz)	(dBμV)	(dB/m)	dB	dB	(dBμV/m)	(dBμV/m)	(dB)		

- Note: 1. Result Level = Read Level + Antenna Factor + Cable loss - PRM Factor
 2. If Peak Result comply with AV limit, AV Result is deemed to comply with AV limit
 3. Test setup: RBW: 1MHz, VBW: 3MHz, Sweep time:auto

Radiated Emission Test Result

Test Site : DDT 3m Chamber E:\2013 Report data\13QE0070\RE 1G-18G.EM6
Test Date : 2013-08-08 **Tested By** : Leo Liu
EUT : GuruPlug **Model Number** : 003-GP0XXXXXX
Power Supply : AC 120V/60Hz **Test Mode** : 11G CH1
Condition : Temp:24.5'C,Humi:55%,
 Press:100.1kPa **Antenna/Distance** : 2013 HF907/3m/VERTICAL
Memo :

Data: 14

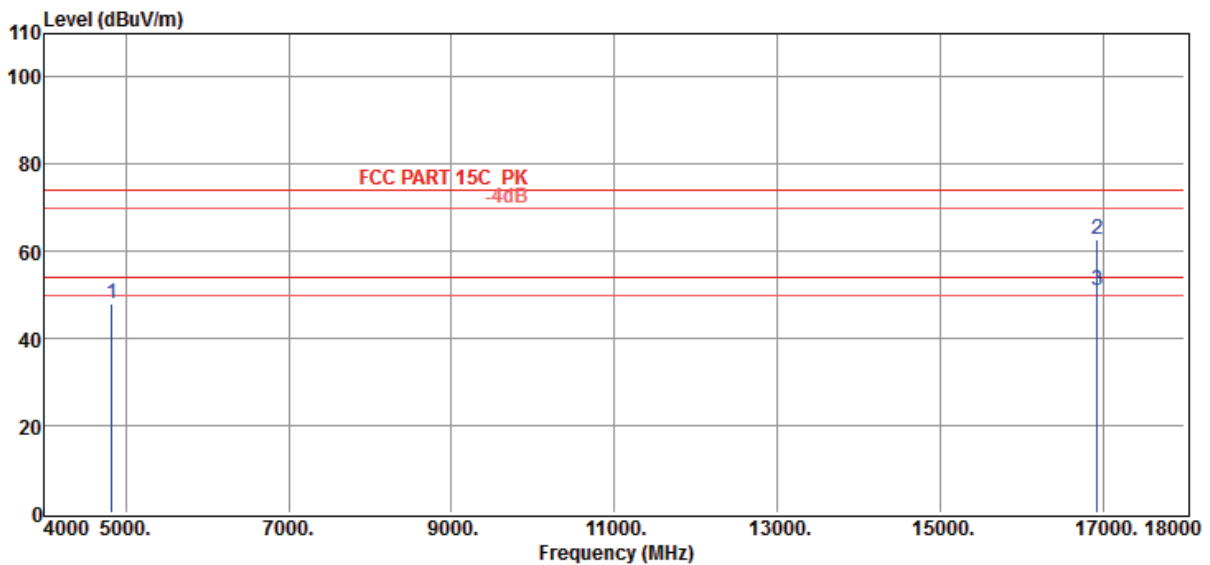

Item (Mark)	Freq (MHz)	Read Level (dBμV)	Antenna Factor (dB/m)	PRM Factor dB	Cable Loss dB	Result Level (dBμV/m)	Limit Line (dBμV/m)	Over Limit (dB)	Detector	Polarization
1	4824.00	45.02	35.42	44.37	12.07	48.14	74.00	-25.86	Peak	VERTICAL
2	16922.00	34.03	43.61	40.37	25.60	62.87	74.00	-11.13	Peak	VERTICAL
3	16922.00	22.32	43.61	40.37	25.60	51.16	54.00	-2.84	Average	VERTICAL

- Note: 1. Result Level = Read Level + Antenna Factor + Cable loss - PRM Factor
 2. If Peak Result comply with AV limit, AV Result is deemed to comply with AV limit
 3. Test setup: RBW: 1MHz, VBW: 3MHz, Sweep time:auto

Radiated Emission Test Result

Test Site	: DDT 3m Chamber	E:\2013 Report data\13QE0070\RE 1G-18G.EM6
Test Date	: 2013-08-08	Tested By : Leo Liu
EUT	: GuruPlug	Model Number : 003-GP0XXXXXX
Power Supply	: AC 120V/60Hz	Test Mode : 11G CH1
Condition	: Temp:24.5'C,Humi:55%, Press:100.1kPa	Antenna/Distance : 2013 HF907/3m/HORIZONTAL
Memo	:	

Data: 15

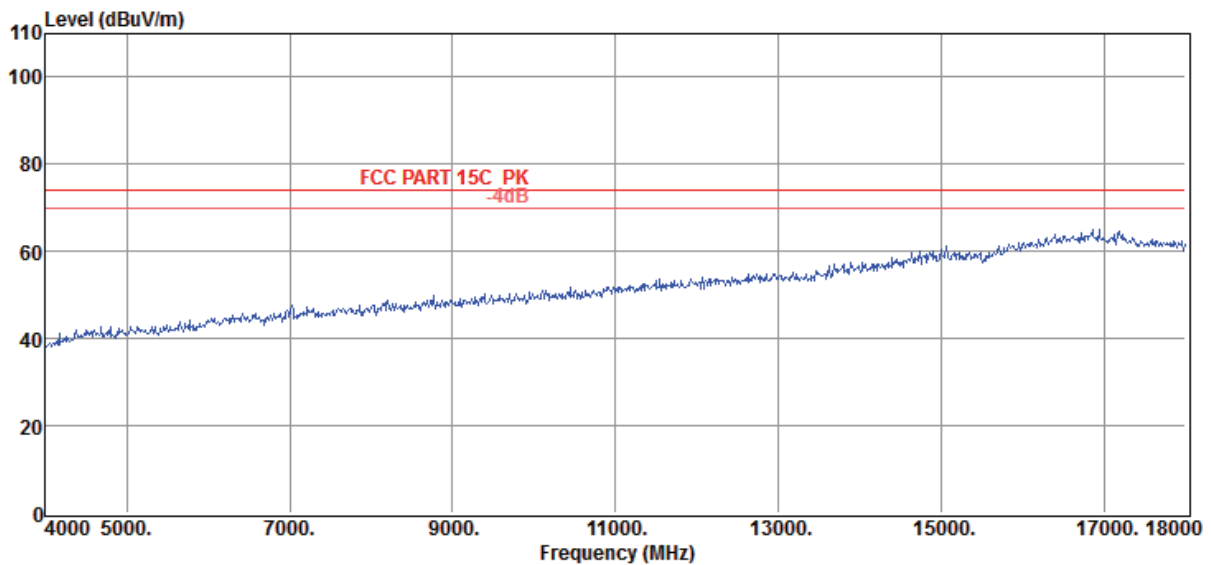

Item	Freq	Read Level	Antenna Factor	PRM Factor	Cable Loss	Result Level	Limit Line	Over Limit	Detector	Polarization
(Mark)	(MHz)	(dBμV)	(dB/m)	dB	dB	(dBμV/m)	(dBμV/m)	(dB)		

- Note: 1. Result Level = Read Level + Antenna Factor + Cable loss - PRM Factor
 2. If Peak Result comply with AV limit, AV Result is deemed to comply with AV limit
 3. Test setup: RBW: 1MHz, VBW: 3MHz, Sweep time:auto

Radiated Emission Test Result

Test Site : DDT 3m Chamber E:\2013 Report data\13QE0070\RE 1G-18G.EM6
Test Date : 2013-08-08 **Tested By** : Leo Liu
EUT : GuruPlug **Model Number** : 003-GP0XXXXXX
Power Supply : AC 120V/60Hz **Test Mode** : 11G CH1
Condition : Temp:24.5'C,Humi:55%,
Antenna/Distance : 2013 HF907/3m/HORIZONTAL
Press:100.1kPa
Memo :

Data: 16

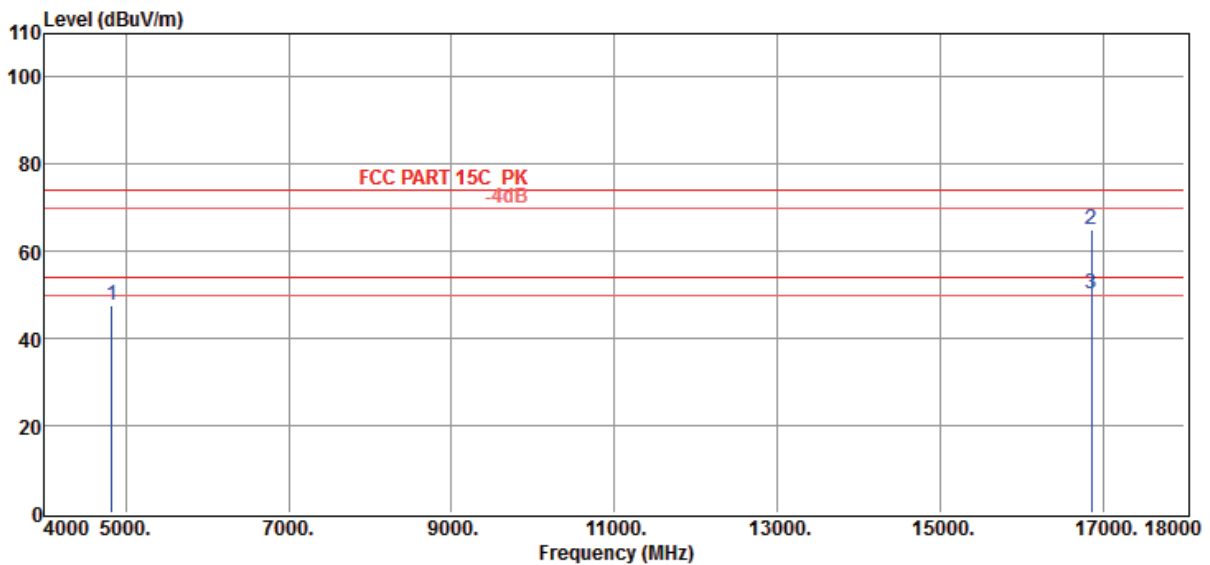

Item (Mark)	Freq (MHz)	Read Level (dBμV)	Antenna Factor (dB/m)	PRM Factor dB	Cable Loss dB	Result Level (dBμV/m)	Limit Line (dBμV/m)	Over Limit (dB)	Detector	Polarization
1	4824.00	44.34	35.42	44.37	12.07	47.46	74.00	-26.54	Peak	HORIZONTAL
2	16852.00	36.02	43.63	40.34	25.60	64.91	74.00	-9.09	Peak	HORIZONTAL
3	16852.00	21.35	43.63	40.34	25.60	50.24	54.00	-3.76	Average	HORIZONTAL

- Note: 1. Result Level = Read Level + Antenna Factor + Cable loss - PRM Factor
 2. If Peak Result comply with AV limit, AV Result is deemed to comply with AV limit
 3. Test setup: RBW: 1MHz, VBW: 3MHz, Sweep time:auto

Radiated Emission Test Result

Test Site	: DDT 3m Chamber	E:\2013 Report data\13QE0070\RE 1G-18G.EM6
Test Date	: 2013-08-08	Tested By : Leo Liu
EUT	: GuruPlug	Model Number : 003-GP0XXXXXX
Power Supply	: AC 120V/60Hz	Test Mode : 11G CH6
Condition	: Temp:24.5'C,Humi:55%, Press:100.1kPa	Antenna/Distance : 2013 HF907/3m/HORIZONTAL
Memo	:	

Data: 17

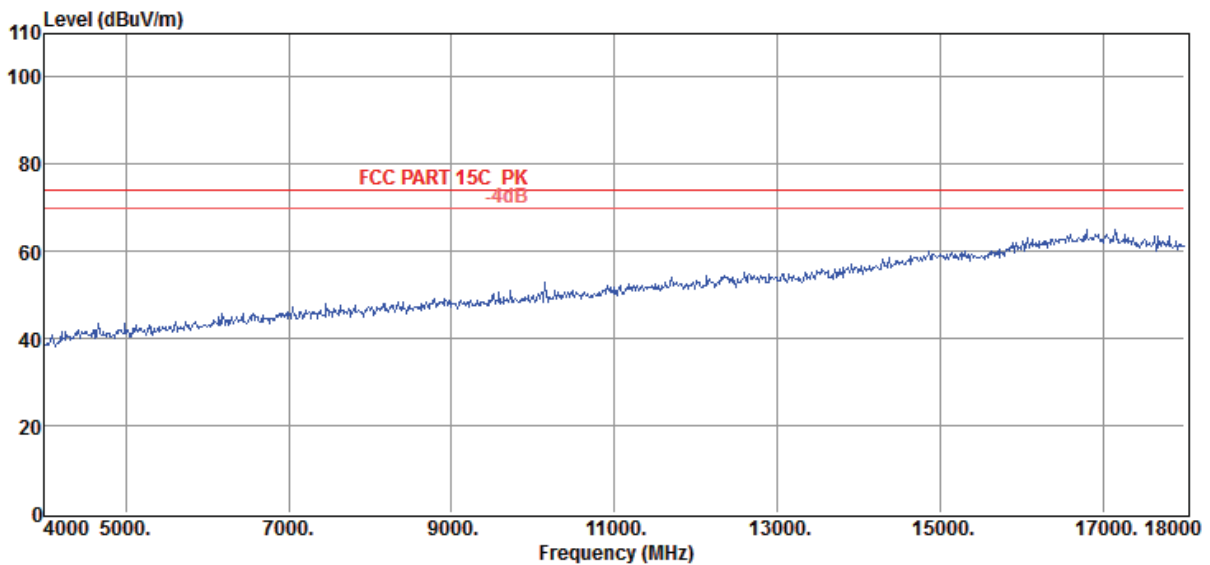

Item	Freq	Read Level	Antenna Factor	PRM Factor	Cable Loss	Result Level	Limit Line	Over Limit	Detector	Polarization
(Mark)	(MHz)	(dBμV)	(dB/m)	dB	dB	(dBμV/m)	(dBμV/m)	(dB)		

- Note: 1. Result Level = Read Level + Antenna Factor + Cable loss - PRM Factor
 2. If Peak Result comply with AV limit, AV Result is deemed to comply with AV limit
 3. Test setup: RBW: 1MHz, VBW: 3MHz, Sweep time:auto

Radiated Emission Test Result

Test Site	: DDT 3m Chamber	E:\2013 Report data\13QE0070\RE 1G-18G.EM6
Test Date	: 2013-08-08	Tested By : Leo Liu
EUT	: GuruPlug	Model Number : 003-GP0XXXXXX
Power Supply	: AC 120V/60Hz	Test Mode : 11G CH6
Condition	: Temp:24.5'C,Humi:55%, Press:100.1kPa	Antenna/Distance : 2013 HF907/3m/HORIZONTAL
Memo	:	

Data: 18

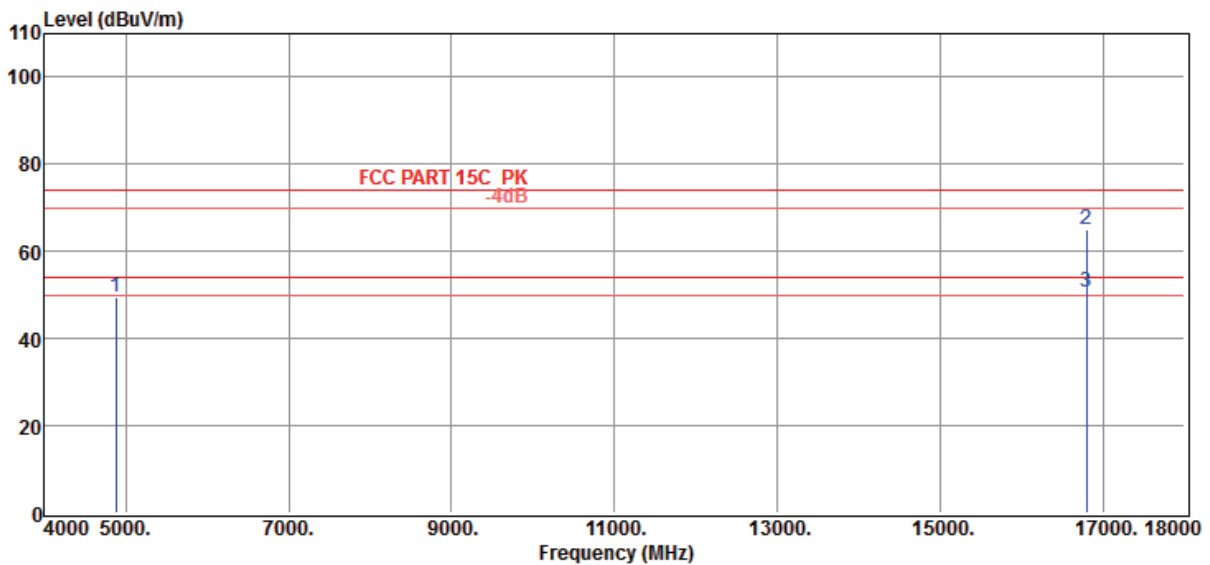

Item (Mark)	Freq (MHz)	Read Level (dBμV)	Antenna Factor (dB/m)	PRM Factor dB	Cable Loss dB	Result Level (dBμV/m)	Limit Line (dBμV/m)	Over Limit (dB)	Detector	Polarization
1	4874.00	46.48	35.51	44.35	12.04	49.68	74.00	-24.32	Peak	HORIZONTAL
2	16796.00	36.56	43.64	40.32	25.00	64.88	74.00	-9.12	Peak	HORIZONTAL
3	16796.00	22.36	43.64	40.32	25.00	50.68	54.00	-3.32	Average	HORIZONTAL

- Note: 1. Result Level = Read Level + Antenna Factor + Cable loss - PRM Factor
 2. If Peak Result comply with AV limit, AV Result is deemed to comply with AV limit
 3. Test setup: RBW: 1MHz, VBW: 3MHz, Sweep time:auto

Radiated Emission Test Result

Test Site	: DDT 3m Chamber	E:\2013 Report data\13QE0070\RE 1G-18G.EM6
Test Date	: 2013-08-08	Tested By : Leo Liu
EUT	: GuruPlug	Model Number : 003-GP0XXXXXX
Power Supply	: AC 120V/60Hz	Test Mode : 11G CH6
Condition	: Temp:24.5'C,Humi:55%, Press:100.1kPa	Antenna/Distance : 2013 HF907/3m/VERTICAL
Memo	:	

Data: 19

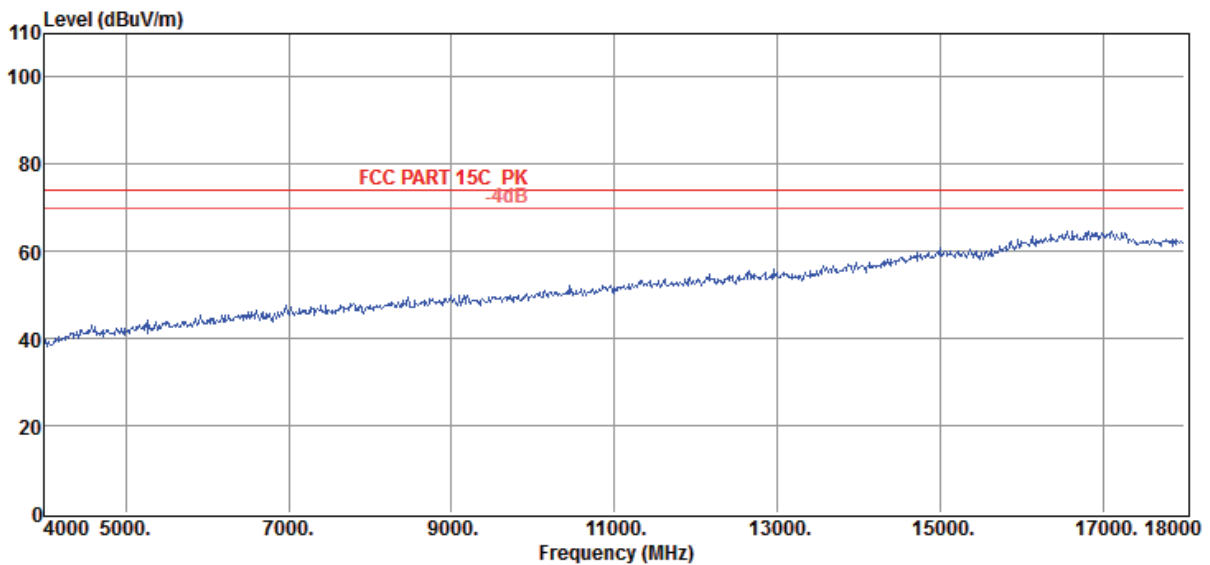

Item (Mark)	Freq (MHz)	Read Level (dBμV)	Antenna Factor (dB/m)	PRM Factor dB	Cable Loss dB	Result Level (dBμV/m)	Limit Line (dBμV/m)	Over Limit (dB)	Detector	Polarization

- Note: 1. Result Level = Read Level + Antenna Factor + Cable loss - PRM Factor
 2. If Peak Result comply with AV limit, AV Result is deemed to comply with AV limit
 3. Test setup: RBW: 1MHz, VBW: 3MHz, Sweep time:auto

Radiated Emission Test Result

Test Site : DDT 3m Chamber **E:\2013 Report data\13QE0070\RE 1G-18G.EM6**
Test Date : 2013-08-08 **Tested By** : Leo Liu
EUT : GuruPlug **Model Number** : 003-GP0XXXXXX
Power Supply : AC 120V/60Hz **Test Mode** : 11G CH6
Condition : Temp:24.5'C,Humi:55%,
Antenna/Distance : 2013 HF907/3m/VERTICAL
 Press:100.1kPa
Memo :

Data: 20

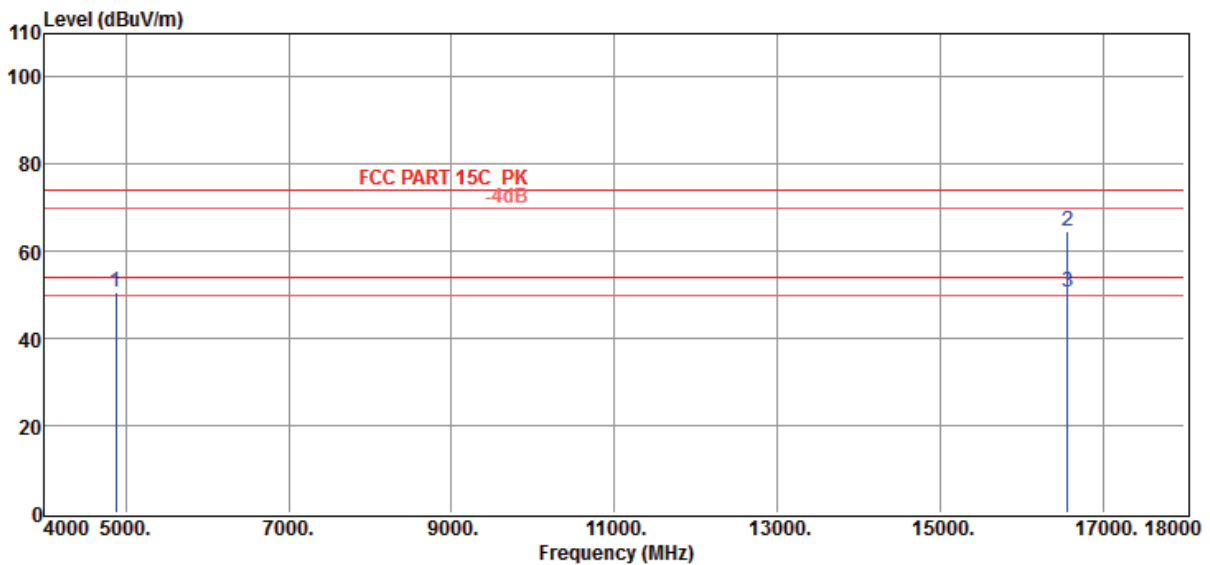

Item (Mark)	Freq (MHz)	Read Level (dBμV)	Antenna Factor (dB/m)	PRM Factor dB	Cable Loss dB	Result Level (dBμV/m)	Limit Line (dBμV/m)	Over Limit (dB)	Detector	Polarization
1	4874.00	47.33	35.51	44.35	12.04	50.53	74.00	-23.47	Peak	HORIZONTAL
2	16558.00	36.95	43.69	40.22	24.40	64.82	74.00	-9.18	Peak	HORIZONTAL
3	16558.00	22.62	43.69	40.22	24.40	50.49	54.00	-3.51	Average	HORIZONTAL

- Note: 1. Result Level = Read Level + Antenna Factor + Cable loss - PRM Factor
 2. If Peak Result comply with AV limit, AV Result is deemed to comply with AV limit
 3. Test setup: RBW: 1MHz, VBW: 3MHz, Sweep time:auto

Radiated Emission Test Result

Test Site	: DDT 3m Chamber	E:\2013 Report data\13QE0070\RE 1G-18G.EM6
Test Date	: 2013-08-08	Tested By : Leo Liu
EUT	: GuruPlug	Model Number : 003-GP0XXXXXX
Power Supply	: AC 120V/60Hz	Test Mode : 11G CH11
Condition	: Temp:24.5'C,Humi:55%, Press:100.1kPa	Antenna/Distance : 2013 HF907/3m/VERTICAL
Memo	:	

Data: 21

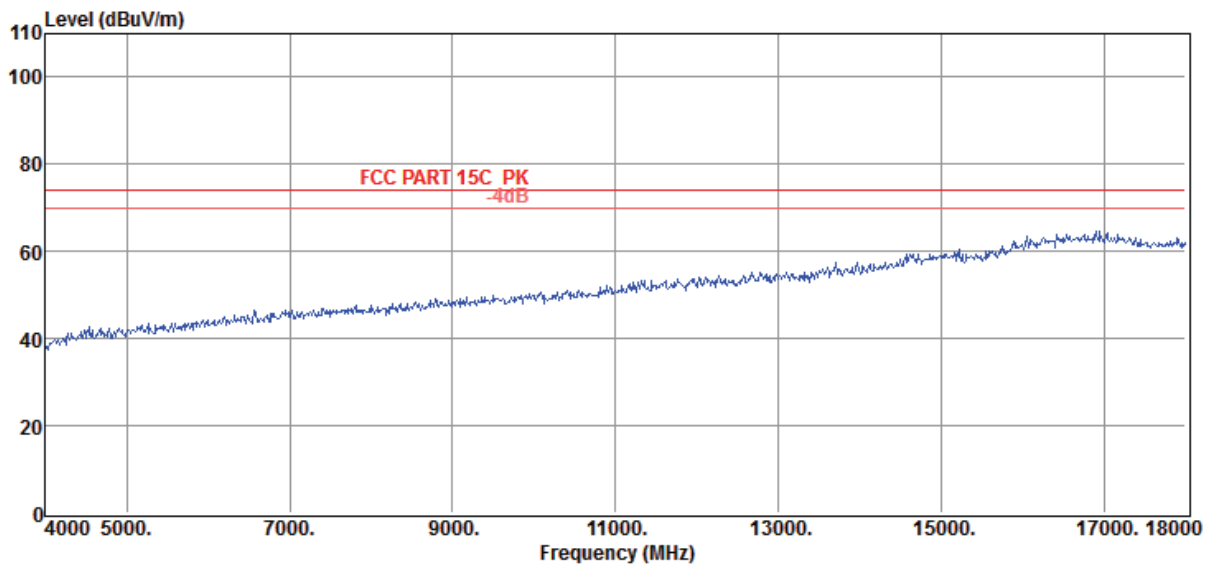

Item (Mark)	Freq (MHz)	Read Level (dBμV)	Antenna Factor (dB/m)	PRM Factor dB	Cable Loss dB	Result Level (dBμV/m)	Limit Line (dBμV/m)	Over Limit (dB)	Detector	Polarization

- Note: 1. Result Level = Read Level + Antenna Factor + Cable loss - PRM Factor
 2. If Peak Result comply with AV limit, AV Result is deemed to comply with AV limit
 3. Test setup: RBW: 1MHz, VBW: 3MHz, Sweep time:auto

Radiated Emission Test Result

Test Site	: DDT 3m Chamber	E:\2013 Report data\13QE0070\RE 1G-18G.EM6
Test Date	: 2013-08-08	Tested By : Leo Liu
EUT	: GuruPlug	Model Number : 003-GP0XXXXXX
Power Supply	: AC 120V/60Hz	Test Mode : 11G CH11
Condition	: Temp:24.5'C,Humi:55%, Press:100.1kPa	Antenna/Distance : 2013 HF907/3m/VERTICAL
Memo	:	

Data: 22

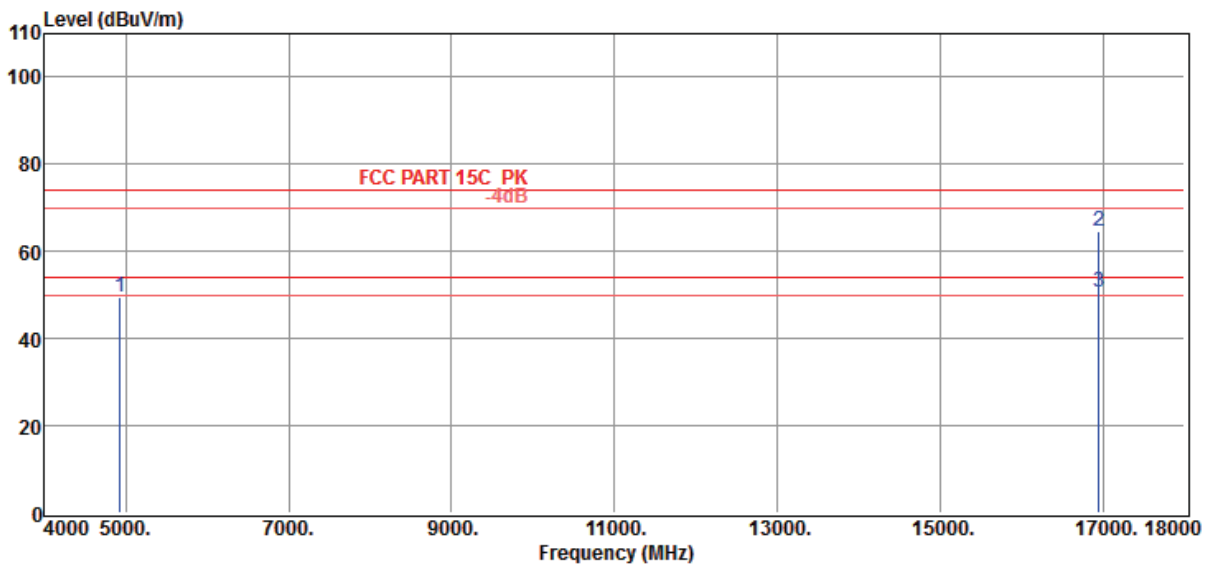

Item (Mark)	Freq (MHz)	Read Level (dBμV)	Antenna Factor (dB/m)	PRM Factor dB	Cable Loss dB	Result Level (dBμV/m)	Limit Line (dBμV/m)	Over Limit (dB)	Detector	Polarization
1	4924.00	46.30	35.59	44.33	12.02	49.58	74.00	-24.42	Peak	VERTICAL
2	16950.00	35.98	43.61	40.39	25.60	64.80	74.00	-9.20	Peak	VERTICAL
3	16950.00	21.66	43.61	40.39	25.60	50.48	54.00	-3.52	Average	VERTICAL

- Note: 1. Result Level = Read Level + Antenna Factor + Cable loss - PRM Factor
 2. If Peak Result comply with AV limit, AV Result is deemed to comply with AV limit
 3. Test setup: RBW: 1MHz, VBW: 3MHz, Sweep time:auto

Radiated Emission Test Result

Test Site	: DDT 3m Chamber	E:\2013 Report data\13QE0070\RE 1G-18G.EM6
Test Date	: 2013-08-08	Tested By : Leo Liu
EUT	: GuruPlug	Model Number : 003-GP0XXXXXX
Power Supply	: AC 120V/60Hz	Test Mode : 11G CH11
Condition	: Temp:24.5'C,Humi:55%, Press:100.1kPa	Antenna/Distance : 2013 HF907/3m/HORIZONTAL
Memo	:	

Data: 23

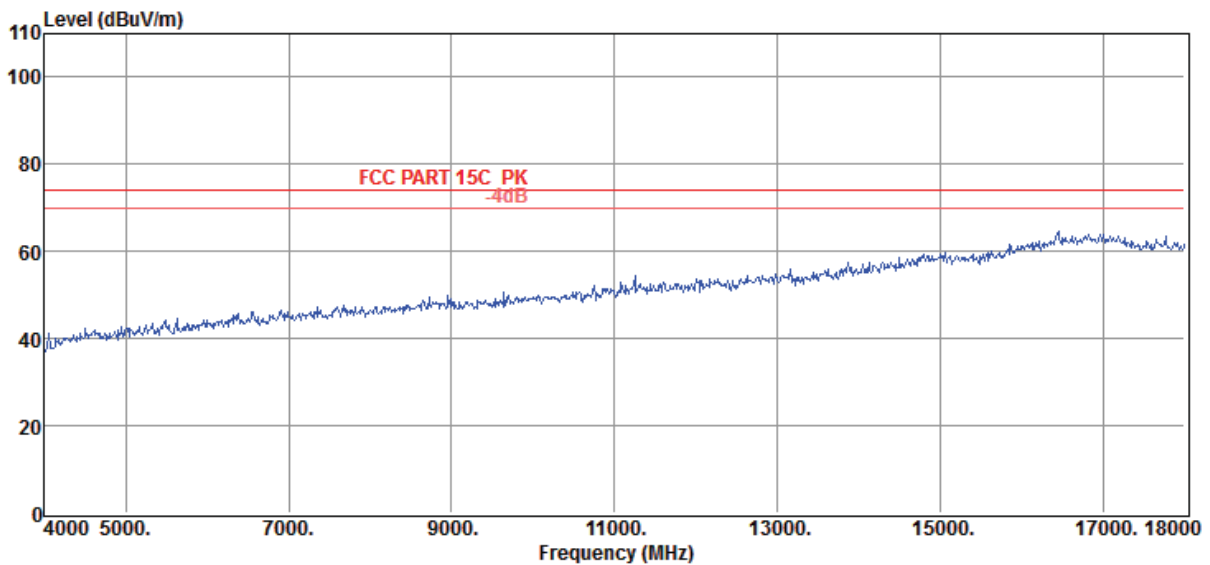

Item (Mark)	Freq (MHz)	Read Level (dBμV)	Antenna Factor (dB/m)	PRM Factor dB	Cable Loss dB	Result Level (dBμV/m)	Limit Line (dBμV/m)	Over Limit (dB)	Detector	Polarization

- Note: 1. Result Level = Read Level + Antenna Factor + Cable loss - PRM Factor
 2. If Peak Result comply with AV limit, AV Result is deemed to comply with AV limit
 3. Test setup: RBW: 1MHz, VBW: 3MHz, Sweep time:auto

Radiated Emission Test Result

Test Site : DDT 3m Chamber E:\2013 Report data\13QE0070\RE 1G-18G.EM6
Test Date : 2013-08-08 **Tested By** : Leo Liu
EUT : GuruPlug **Model Number** : 003-GP0XXXXXX
Power Supply : AC 120V/60Hz **Test Mode** : 11G CH11
Condition : Temp:24.5'C,Humi:55%,
Antenna/Distance : 2013 HF907/3m/HORIZONTAL
Press:100.1kPa
Memo :

Data: 24

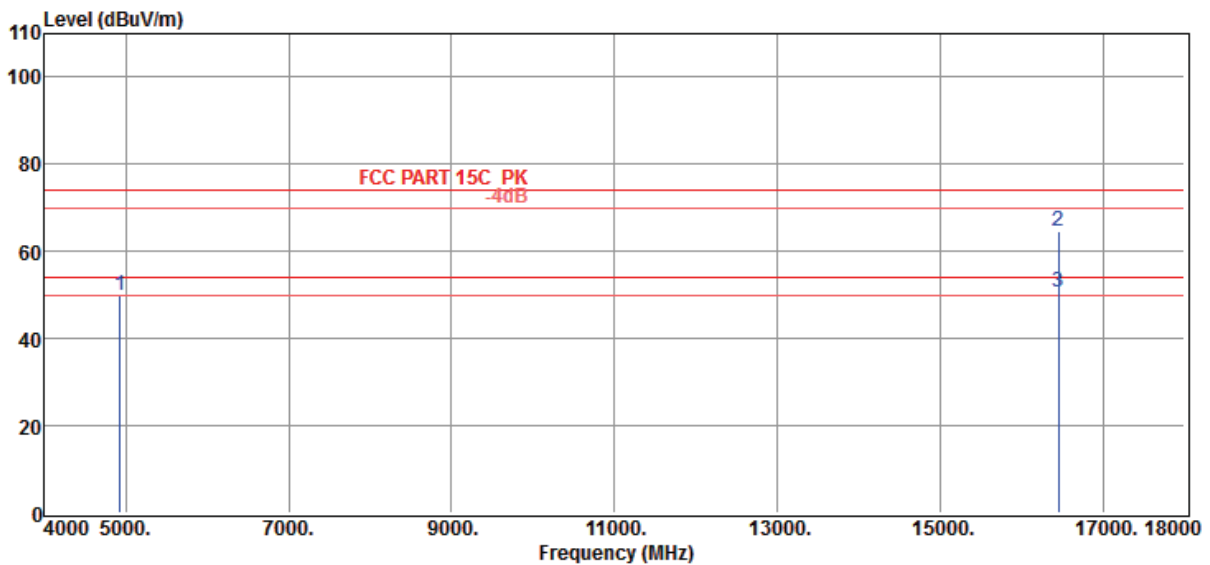

Item (Mark)	Freq (MHz)	Read Level (dBμV)	Antenna Factor (dB/m)	PRM Factor (dB)	Cable Loss (dB)	Result Level (dBμV/m)	Limit Line (dBμV/m)	Over Limit (dB)	Detector	Polarization
1	4924.00	46.75	35.59	44.33	12.02	50.03	74.00	-23.97	Peak	HORIZONTAL
2	16446.00	36.82	43.64	40.23	24.40	64.63	74.00	-9.37	Peak	HORIZONTAL
3	16446.00	22.84	43.64	40.23	24.40	50.65	54.00	-3.35	Average	HORIZONTAL

- Note: 1. Result Level = Read Level + Antenna Factor + Cable loss - PRM Factor
 2. If Peak Result comply with AV limit, AV Result is deemed to comply with AV limit
 3. Test setup: RBW: 1MHz, VBW: 3MHz, Sweep time:auto

Radiated Emission Test Result

Test Site	: DDT 3m Chamber	E:\2013 Report data\13QE0070\RE 1G-18G.EM6
Test Date	: 2013-08-08	Tested By : Leo Liu
EUT	: GuruPlug	Model Number : 003-GP0XXXXXX
Power Supply	: AC 120V/60Hz	Test Mode : 11N HT20 CH1
Condition	: Temp:24.5'C,Humi:55%, Press:100.1kPa	Antenna/Distance : 2013 HF907/3m/HORIZONTAL
Memo	:	

Data: 25

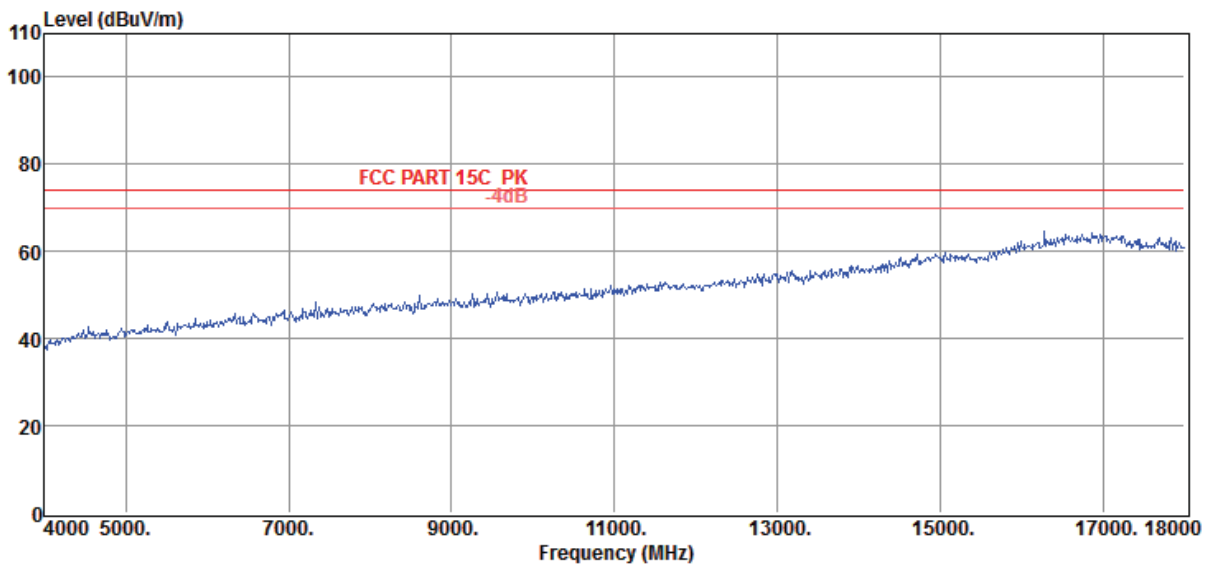

Item (Mark)	Freq (MHz)	Read Level (dBμV)	Antenna Factor (dB/m)	PRM Factor dB	Cable Loss dB	Result Level (dBμV/m)	Limit Line (dBμV/m)	Over Limit (dB)	Detector	Polarization

- Note: 1. Result Level = Read Level + Antenna Factor + Cable loss - PRM Factor
 2. If Peak Result comply with AV limit, AV Result is deemed to comply with AV limit
 3. Test setup: RBW: 1MHz, VBW: 3MHz, Sweep time:auto

Radiated Emission Test Result

Test Site	: DDT 3m Chamber	E:\2013 Report data\13QE0070\RE 1G-18G.EM6
Test Date	: 2013-08-08	Tested By : Leo Liu
EUT	: GuruPlug	Model Number : 003-GP0XXXXXX
Power Supply	: AC 120V/60Hz	Test Mode : 11N HT20 CH1
Condition	: Temp:24.5'C,Humi:55%, Press:100.1kPa	Antenna/Distance : 2013 HF907/3m/HORIZONTAL
Memo	:	

Data: 26

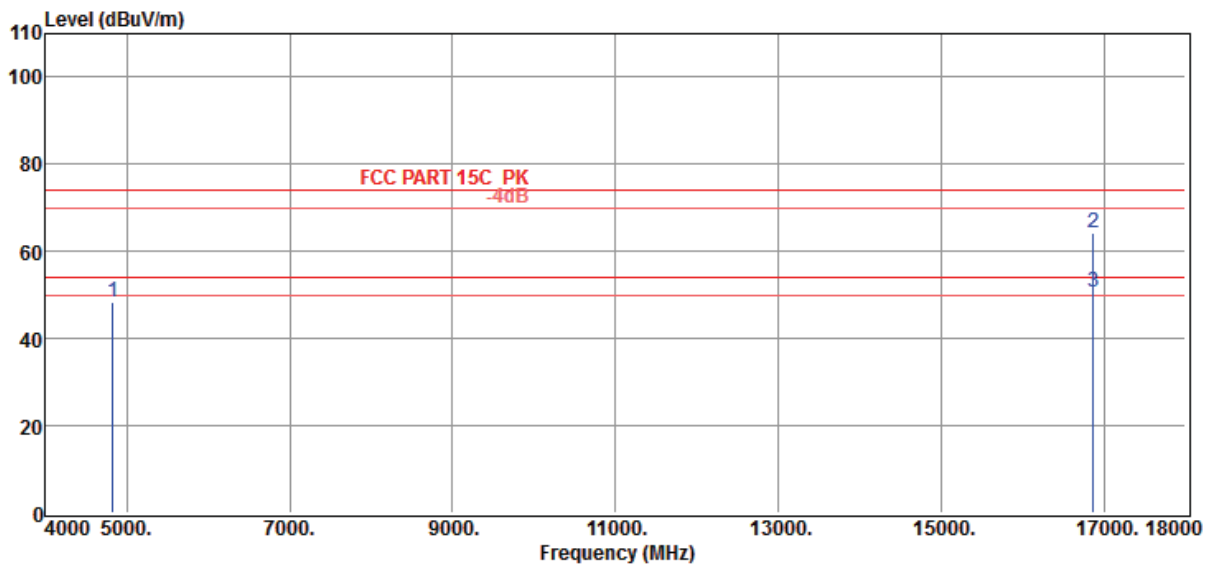

Item (Mark)	Freq (MHz)	Read Level (dBμV)	Antenna Factor (dB/m)	PRM Factor dB	Cable Loss dB	Result Level (dBμV/m)	Limit Line (dBμV/m)	Over Limit (dB)	Detector	Polarization
1	4824.00	45.16	35.42	44.37	12.07	48.28	74.00	-25.72	Peak	HORIZONTAL
2	16866.00	35.38	43.63	40.35	25.60	64.26	74.00	-9.74	Peak	HORIZONTAL
3	16866.00	21.89	43.63	40.35	25.60	50.77	54.00	-3.23	Average	HORIZONTAL

- Note: 1. Result Level = Read Level + Antenna Factor + Cable loss - PRM Factor
 2. If Peak Result comply with AV limit, AV Result is deemed to comply with AV limit
 3. Test setup: RBW: 1MHz, VBW: 3MHz, Sweep time:auto

Radiated Emission Test Result

Test Site	: DDT 3m Chamber	E:\2013 Report data\13QE0070\RE 1G-18G.EM6
Test Date	: 2013-08-08	Tested By : Leo Liu
EUT	: GuruPlug	Model Number : 003-GP0XXXXXX
Power Supply	: AC 120V/60Hz	Test Mode : 11N HT20 CH1
Condition	: Temp:24.5'C,Humi:55%, Press:100.1kPa	Antenna/Distance : 2013 HF907/3m/VERTICAL
Memo	:	

Data: 27

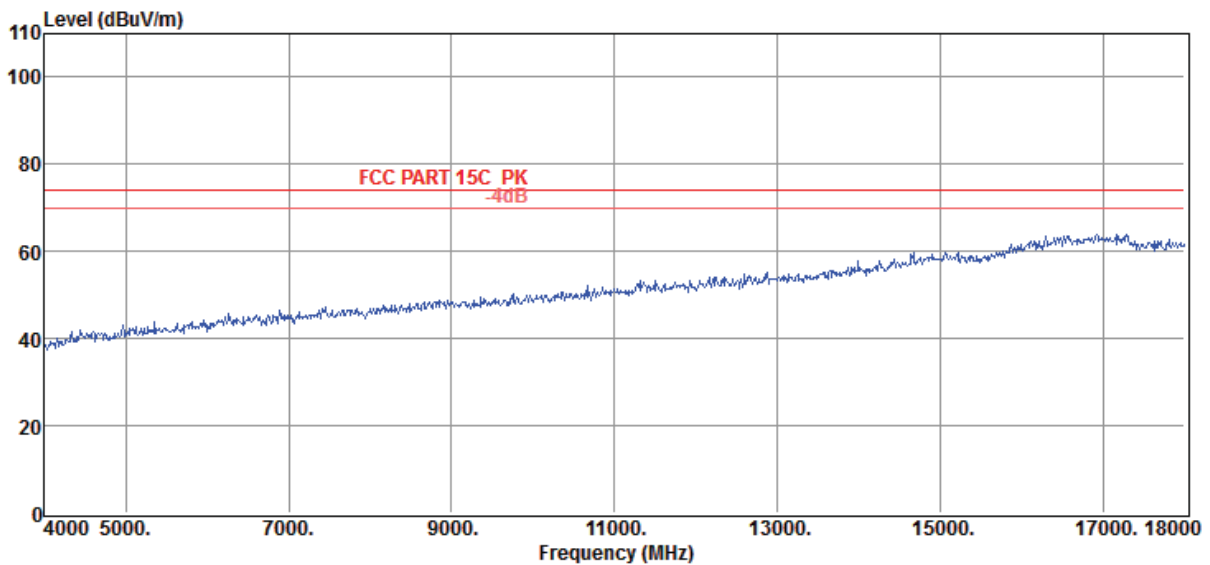

Item (Mark)	Freq (MHz)	Read Level (dBμV)	Antenna Factor (dB/m)	PRM Factor dB	Cable Loss dB	Result Level (dBμV/m)	Limit Line (dBμV/m)	Over Limit (dB)	Detector	Polarization

- Note: 1. Result Level = Read Level + Antenna Factor + Cable loss - PRM Factor
 2. If Peak Result comply with AV limit, AV Result is deemed to comply with AV limit
 3. Test setup: RBW: 1MHz, VBW: 3MHz, Sweep time:auto

Radiated Emission Test Result

Test Site : DDT 3m Chamber E:\2013 Report data\13QE0070\RE 1G-18G.EM6
Test Date : 2013-08-08 **Tested By** : Leo Liu
EUT : GuruPlug **Model Number** : 003-GP0XXXXXX
Power Supply : AC 120V/60Hz **Test Mode** : 11N HT20 CH1
Condition : Temp:24.5'C,Humi:55%,
Antenna/Distance : 2013 HF907/3m/VERTICAL
 Press:100.1kPa
Memo :

Data: 28

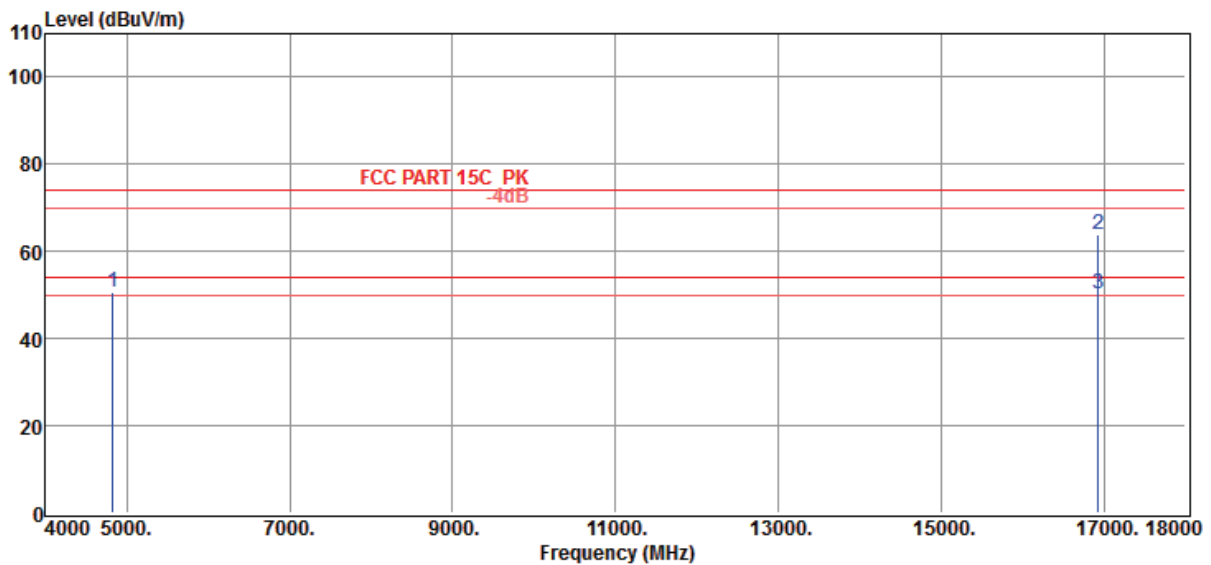

Item (Mark)	Freq (MHz)	Read Level (dBμV)	Antenna Factor (dB/m)	PRM Factor dB	Cable Loss dB	Result Level (dBμV/m)	Limit Line (dBμV/m)	Over Limit (dB)	Detector	Polarization
1	4824.00	47.60	35.42	44.37	12.07	50.72	74.00	-23.28	Peak	VERTICAL
2	16922.00	35.06	43.61	40.37	25.60	63.90	74.00	-10.10	Peak	VERTICAL
3	16922.00	21.45	43.61	40.37	25.60	50.29	54.00	-3.71	Average	VERTICAL

- Note: 1. Result Level = Read Level + Antenna Factor + Cable loss - PRM Factor
 2. If Peak Result comply with AV limit, AV Result is deemed to comply with AV limit
 3. Test setup: RBW: 1MHz, VBW: 3MHz, Sweep time:auto

Radiated Emission Test Result

Test Site	: DDT 3m Chamber	E:\2013 Report data\13QE0070\RE 1G-18G.EM6
Test Date	: 2013-08-08	Tested By : Leo Liu
EUT	: GuruPlug	Model Number : 003-GP0XXXXXX
Power Supply	: AC 120V/60Hz	Test Mode : 11N HT20 CH6
Condition	: Temp:24.5'C,Humi:55%, Press:100.1kPa	Antenna/Distance : 2013 HF907/3m/VERTICAL
Memo	:	

Data: 29

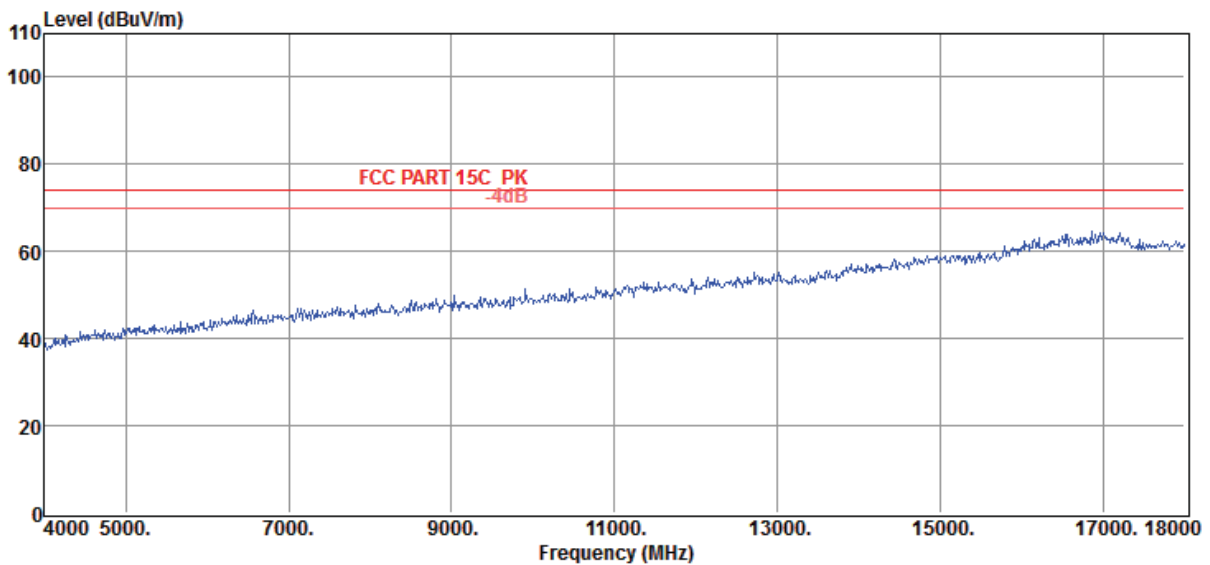

Item	Freq	Read Level	Antenna Factor	PRM Factor	Cable Loss	Result Level	Limit Line	Over Limit	Detector	Polarization
(Mark)	(MHz)	(dBμV)	(dB/m)	dB	dB	(dBμV/m)	(dBμV/m)	(dB)		

- Note: 1. Result Level = Read Level + Antenna Factor + Cable loss - PRM Factor
 2. If Peak Result comply with AV limit, AV Result is deemed to comply with AV limit
 3. Test setup: RBW: 1MHz, VBW: 3MHz, Sweep time:auto

Radiated Emission Test Result

Test Site : DDT 3m Chamber **E:\2013 Report data\13QE0070\RE 1G-18G.EM6**
Test Date : 2013-08-08 **Tested By** : Leo Liu
EUT : GuruPlug **Model Number** : 003-GP0XXXXXX
Power Supply : AC 120V/60Hz **Test Mode** : 11N HT20 CH6
Condition : Temp:24.5'C,Humi:55%,
Antenna/Distance : 2013 HF907/3m/VERTICAL
 Press:100.1kPa
Memo :

Data: 30

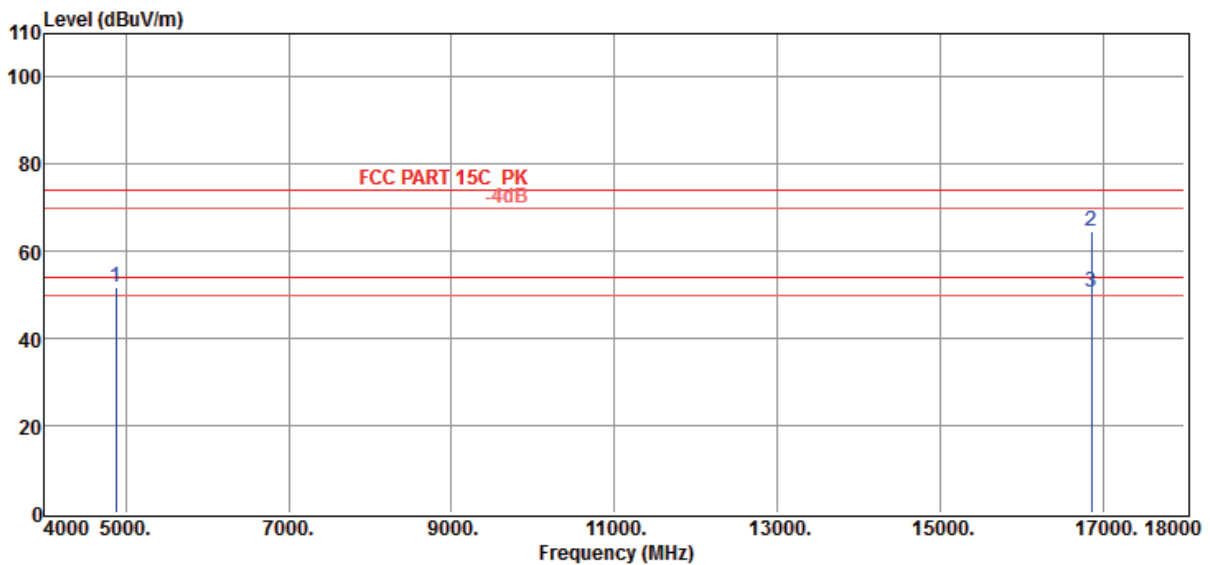

Item (Mark)	Freq (MHz)	Read Level (dBμV)	Antenna Factor (dB/m)	PRM Factor (dB)	Cable Loss (dB)	Result Level (dBμV/m)	Limit Line (dBμV/m)	Over Limit (dB)	Detector	Polarization
1	4874.00	48.47	35.51	44.35	12.04	51.67	74.00	-22.33	Peak	VERTICAL
2	16852.00	35.75	43.63	40.34	25.60	64.64	74.00	-9.36	Peak	VERTICAL
3	16852.00	21.69	43.63	40.34	25.60	50.58	54.00	-3.42	Average	VERTICAL

- Note: 1. Result Level = Read Level + Antenna Factor + Cable loss - PRM Factor
 2. If Peak Result comply with AV limit, AV Result is deemed to comply with AV limit
 3. Test setup: RBW: 1MHz, VBW: 3MHz, Sweep time:auto

Radiated Emission Test Result

Test Site	: DDT 3m Chamber	E:\2013 Report data\13QE0070\RE 1G-18G.EM6
Test Date	: 2013-08-08	Tested By : Leo Liu
EUT	: GuruPlug	Model Number : 003-GP0XXXXXX
Power Supply	: AC 120V/60Hz	Test Mode : 11N HT20 CH6
Condition	: Temp:24.5'C,Humi:55%, Press:100.1kPa	Antenna/Distance : 2013 HF907/3m/HORIZONTAL
Memo	:	

Data: 31

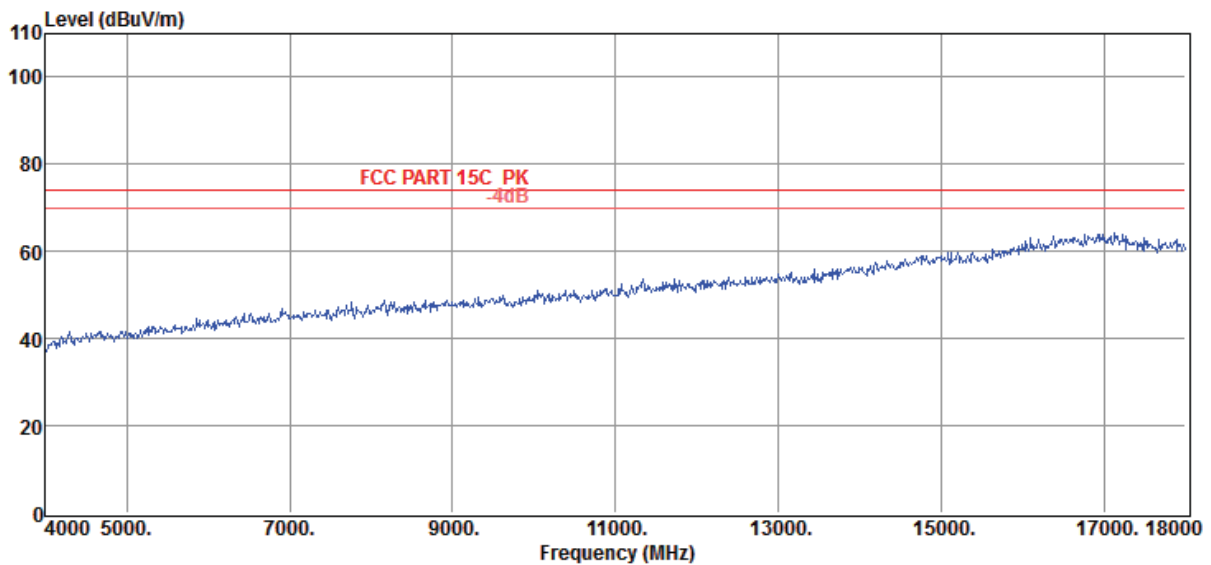

Item (Mark)	Freq (MHz)	Read Level (dBμV)	Antenna Factor (dB/m)	PRM Factor dB	Cable Loss dB	Result Level (dBμV/m)	Limit Line (dBμV/m)	Over Limit (dB)	Detector	Polarization

- Note: 1. Result Level = Read Level + Antenna Factor + Cable loss - PRM Factor
 2. If Peak Result comply with AV limit, AV Result is deemed to comply with AV limit
 3. Test setup: RBW: 1MHz, VBW: 3MHz, Sweep time:auto

Radiated Emission Test Result

Test Site	: DDT 3m Chamber	E:\2013 Report data\13QE0070\RE 1G-18G.EM6
Test Date	: 2013-08-08	Tested By : Leo Liu
EUT	: GuruPlug	Model Number : 003-GP0XXXXXX
Power Supply	: AC 120V/60Hz	Test Mode : 11N HT20 CH6
Condition	: Temp:24.5'C,Humi:55%, Press:100.1kPa	Antenna/Distance : 2013 HF907/3m/HORIZONTAL
Memo	:	

Data: 32

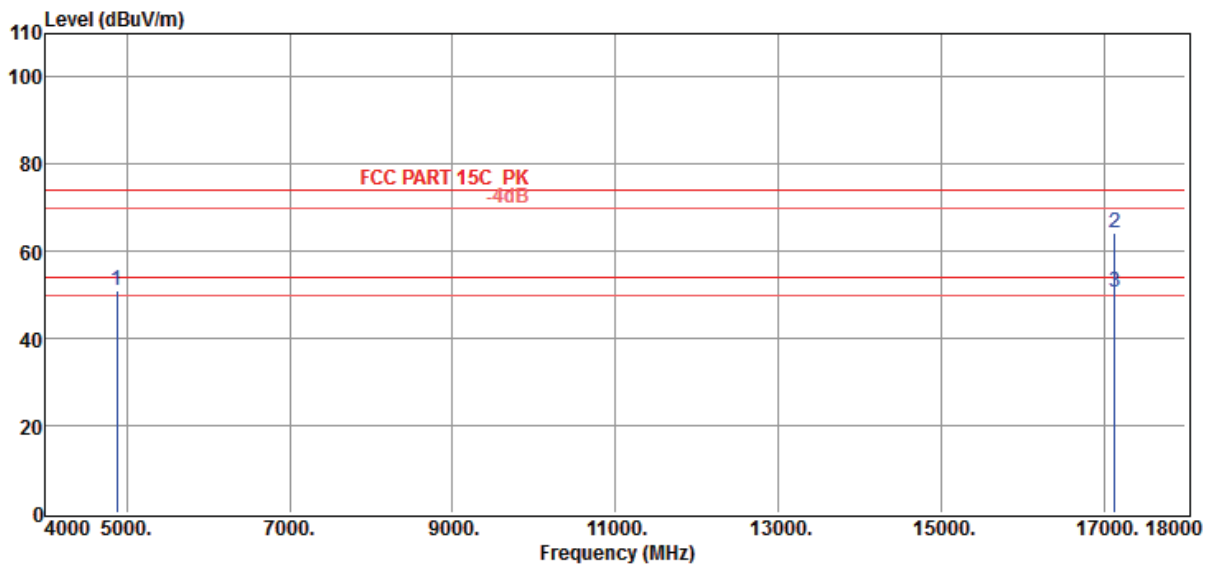

Item (Mark)	Freq (MHz)	Read Level (dBμV)	Antenna Factor (dB/m)	PRM Factor dB	Cable Loss dB	Result Level (dBμV/m)	Limit Line (dBμV/m)	Over Limit (dB)	Detector	Polarization
1	4874.00	47.70	35.51	44.35	12.04	50.90	74.00	-23.10	Peak	HORIZONTAL
2	17132.00	35.96	43.39	40.46	25.47	64.36	74.00	-9.64	Peak	HORIZONTAL
3	17132.00	22.36	43.39	40.46	25.47	50.76	54.00	-3.24	Average	HORIZONTAL

- Note: 1. Result Level = Read Level + Antenna Factor + Cable loss - PRM Factor
 2. If Peak Result comply with AV limit, AV Result is deemed to comply with AV limit
 3. Test setup: RBW: 1MHz, VBW: 3MHz, Sweep time:auto

Radiated Emission Test Result

Test Site	: DDT 3m Chamber	E:\2013 Report data\13QE0070\RE 1G-18G.EM6
Test Date	: 2013-08-08	Tested By : Leo Liu
EUT	: GuruPlug	Model Number : 003-GP0XXXXXX
Power Supply	: AC 120V/60Hz	Test Mode : 11N HT20 CH11
Condition	: Temp:24.5'C,Humi:55%, Press:100.1kPa	Antenna/Distance : 2013 HF907/3m/HORIZONTAL
Memo	:	

Data: 33

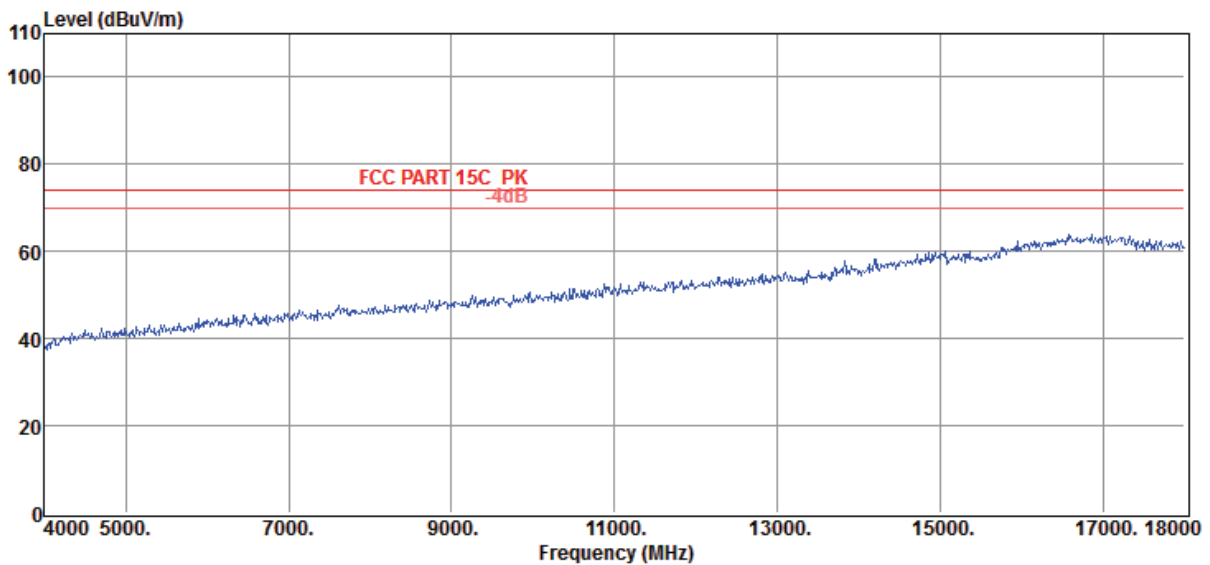

Item (Mark)	Freq (MHz)	Read Level (dBμV)	Antenna Factor (dB/m)	PRM Factor dB	Cable Loss dB	Result Level (dBμV/m)	Limit Line (dBμV/m)	Over Limit (dB)	Detector	Polarization

- Note: 1. Result Level = Read Level + Antenna Factor + Cable loss - PRM Factor
 2. If Peak Result comply with AV limit, AV Result is deemed to comply with AV limit
 3. Test setup: RBW: 1MHz, VBW: 3MHz, Sweep time:auto

Radiated Emission Test Result

Test Site	: DDT 3m Chamber	E:\2013 Report data\13QE0070\RE 1G-18G.EM6
Test Date	: 2013-08-08	Tested By : Leo Liu
EUT	: GuruPlug	Model Number : 003-GP0XXXXXX
Power Supply	: AC 120V/60Hz	Test Mode : 11N HT20 CH11
Condition	: Temp:24.5'C,Humi:55%, Press:100.1kPa	Antenna/Distance : 2013 HF907/3m/HORIZONTAL
Memo	:	

Data: 34

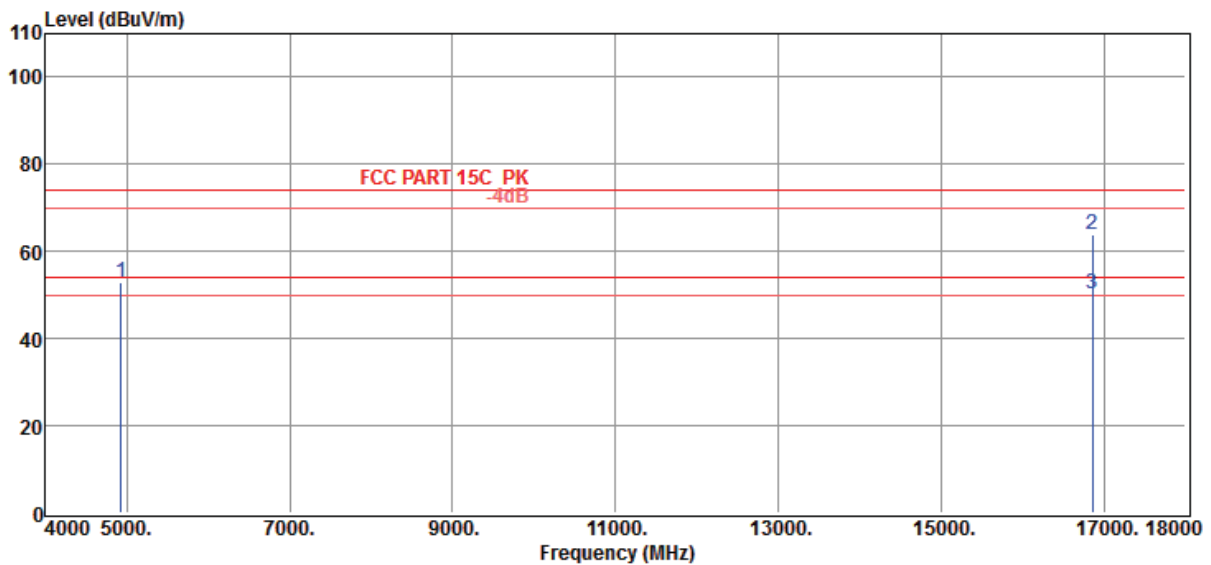

Item (Mark)	Freq (MHz)	Read Level (dBμV)	Antenna Factor (dB/m)	PRM Factor dB	Cable Loss dB	Result Level (dBμV/m)	Limit Line (dBμV/m)	Over Limit (dB)	Detector	Polarization
1	4924.00	49.47	35.59	44.33	12.02	52.75	74.00	-21.25	Peak	HORIZONTAL
2	16852.00	34.91	43.63	40.34	25.60	63.80	74.00	-10.20	Peak	HORIZONTAL
3	16852.00	21.32	43.63	40.34	25.60	50.21	54.00	-3.79	Average	HORIZONTAL

- Note: 1. Result Level = Read Level + Antenna Factor + Cable loss - PRM Factor
 2. If Peak Result comply with AV limit, AV Result is deemed to comply with AV limit
 3. Test setup: RBW: 1MHz, VBW: 3MHz, Sweep time:auto

Radiated Emission Test Result

Test Site	: DDT 3m Chamber	E:\2013 Report data\13QE0070\RE 1G-18G.EM6
Test Date	: 2013-08-08	Tested By : Leo Liu
EUT	: GuruPlug	Model Number : 003-GP0XXXXXX
Power Supply	: AC 120V/60Hz	Test Mode : 11N HT20 CH11
Condition	: Temp:24.5'C,Humi:55%, Press:100.1kPa	Antenna/Distance : 2013 HF907/3m/VERTICAL
Memo	:	

Data: 35

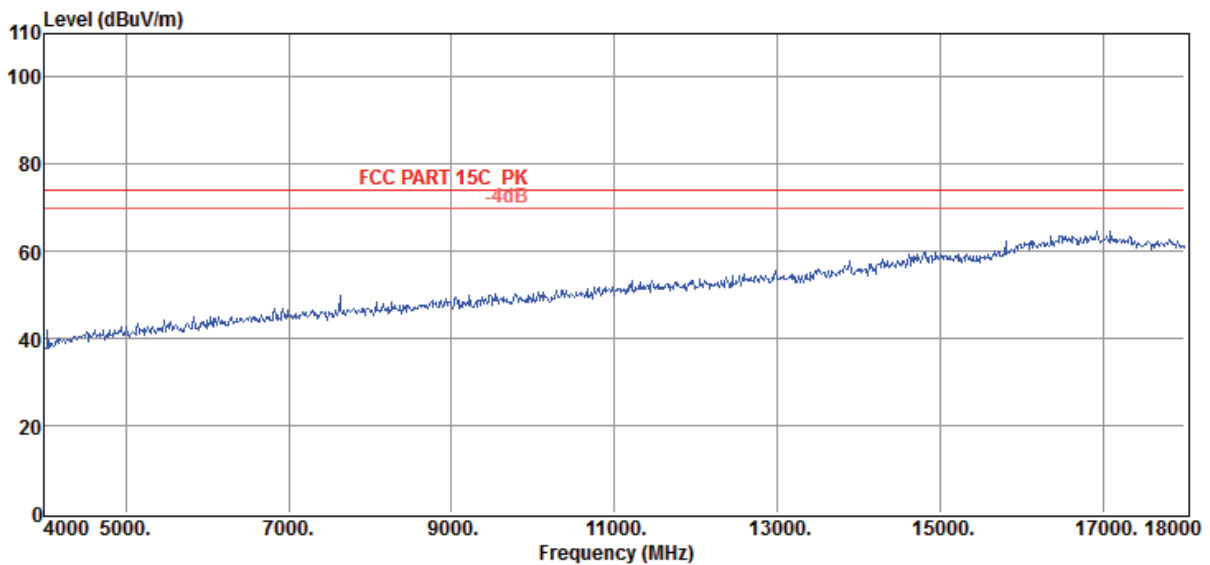

Item	Freq	Read Level	Antenna Factor	PRM Factor	Cable Loss	Result Level	Limit Line	Over Limit	Detector	Polarization
(Mark)	(MHz)	(dBμV)	(dB/m)	dB	dB	(dBμV/m)	(dBμV/m)	(dB)		

- Note: 1. Result Level = Read Level + Antenna Factor + Cable loss - PRM Factor
 2. If Peak Result comply with AV limit, AV Result is deemed to comply with AV limit
 3. Test setup: RBW: 1MHz, VBW: 3MHz, Sweep time:auto

Radiated Emission Test Result

Test Site	: DDT 3m Chamber	E:\2013 Report data\13QE0070\RE 1G-18G.EM6
Test Date	: 2013-08-08	Tested By : Leo Liu
EUT	: GuruPlug	Model Number : 003-GP0XXXXXX
Power Supply	: AC 120V/60Hz	Test Mode : 11N HT20 CH11
Condition	: Temp:24.5'C,Humi:55%, Press:100.1kPa	Antenna/Distance : 2013 HF907/3m/VERTICAL
Memo	:	

Data: 36

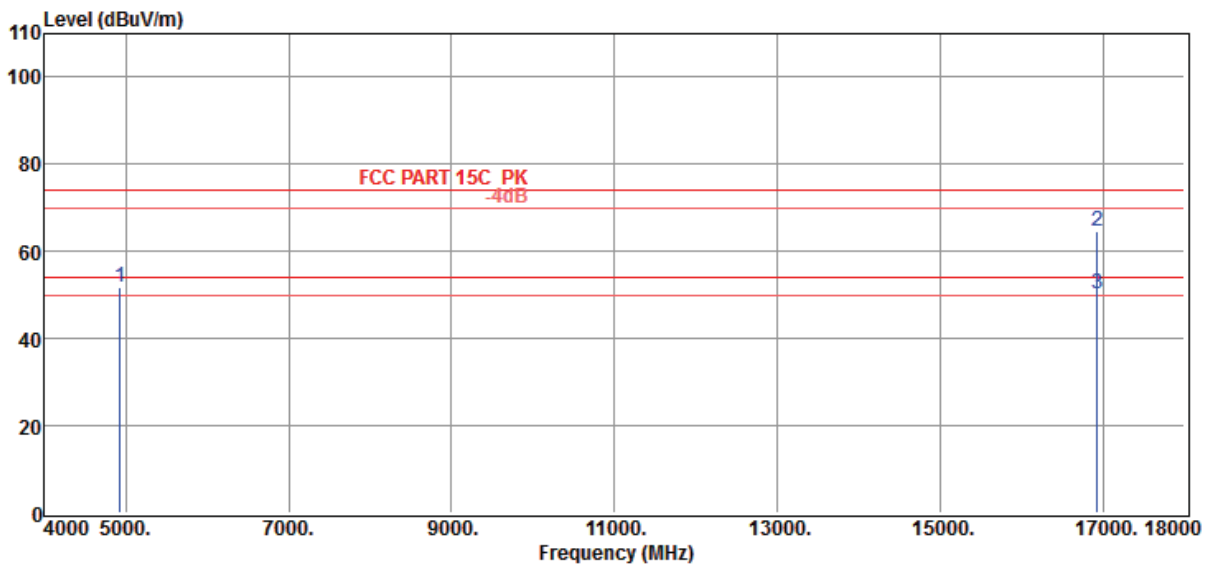

Item (Mark)	Freq (MHz)	Read Level (dBμV)	Antenna Factor (dB/m)	PRM Factor dB	Cable Loss dB	Result Level (dBμV/m)	Limit Line (dBμV/m)	Over Limit (dB)	Detector	Polarization
1	4924.00	48.58	35.59	44.33	12.02	51.86	74.00	-22.14	Peak	VERTICAL
2	16922.00	35.79	43.61	40.37	25.60	64.63	74.00	-9.37	Peak	VERTICAL
3	16922.00	21.59	43.61	40.37	25.60	50.43	54.00	-3.57	Average	VERTICAL

- Note: 1. Result Level = Read Level + Antenna Factor + Cable loss - PRM Factor
 2. If Peak Result comply with AV limit, AV Result is deemed to comply with AV limit
 3. Test setup: RBW: 1MHz, VBW: 3MHz, Sweep time:auto

Radiated Emission Test Result

Test Site	: DDT 3m Chamber	E:\2013 Report data\13QE0070\RE 1G-18G.EM6
Test Date	: 2013-08-08	Tested By : Leo Liu
EUT	: GuruPlug	Model Number : 003-GP0XXXXXX
Power Supply	: AC 120V/60Hz	Test Mode : 11N HT40 CH3
Condition	: Temp:24.5'C,Humi:55%, Press:100.1kPa	Antenna/Distance : 2013 HF907/3m/VERTICAL
Memo	:	

Data: 37

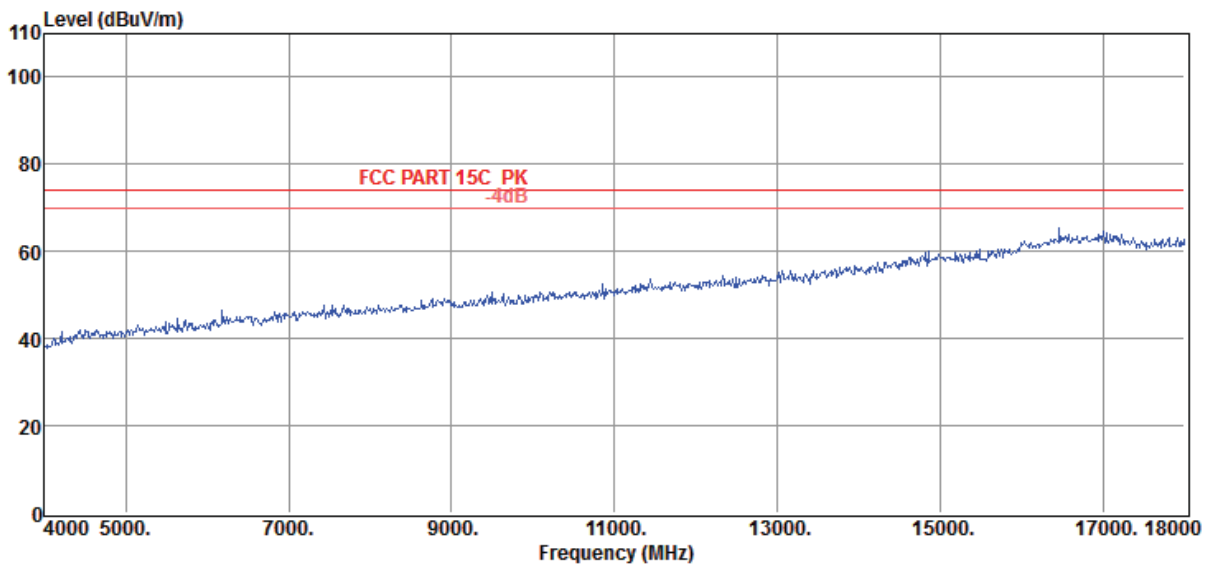

Item (Mark)	Freq (MHz)	Read Level (dBμV)	Antenna Factor (dB/m)	PRM Factor dB	Cable Loss dB	Result Level (dBμV/m)	Limit Line (dBμV/m)	Over Limit (dB)	Detector	Polarization

- Note: 1. Result Level = Read Level + Antenna Factor + Cable loss - PRM Factor
 2. If Peak Result comply with AV limit, AV Result is deemed to comply with AV limit
 3. Test setup: RBW: 1MHz, VBW: 3MHz, Sweep time:auto

Radiated Emission Test Result

Test Site	: DDT 3m Chamber	E:\2013 Report data\13QE0070\RE 1G-18G.EM6
Test Date	: 2013-08-08	Tested By : Leo Liu
EUT	: GuruPlug	Model Number : 003-GP0XXXXXX
Power Supply	: AC 120V/60Hz	Test Mode : 11N HT40 CH3
Condition	: Temp:24.5'C,Humi:55%, Press:100.1kPa	Antenna/Distance : 2013 HF907/3m/VERTICAL
Memo	:	

Data: 38

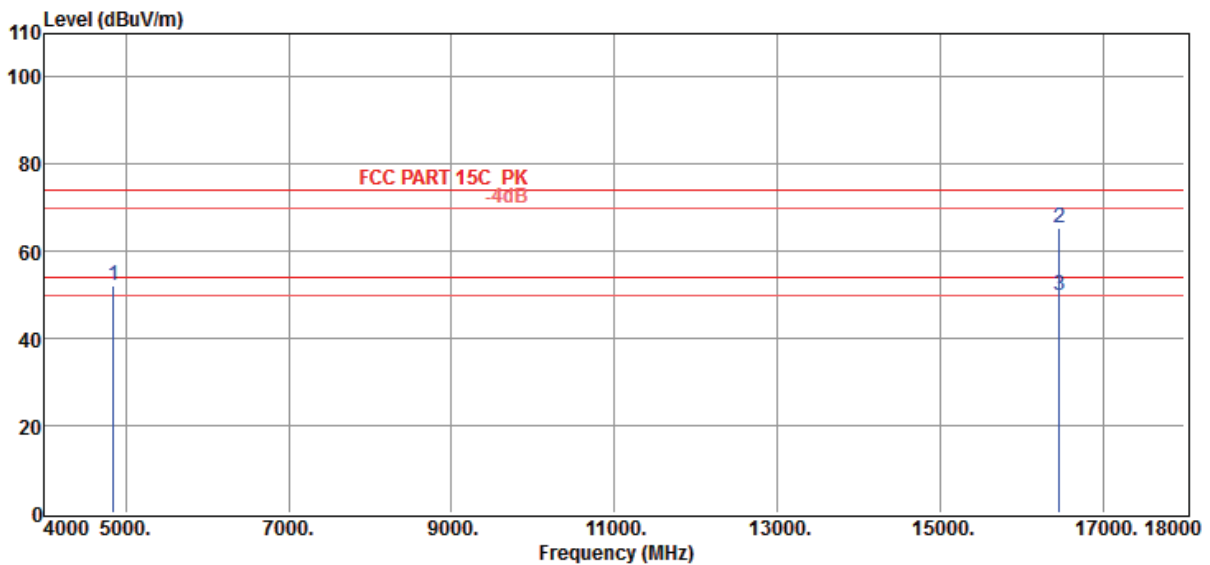

Item (Mark)	Freq (MHz)	Read Level (dBμV)	Antenna Factor (dB/m)	PRM Factor dB	Cable Loss dB	Result Level (dBμV/m)	Limit Line (dBμV/m)	Over Limit (dB)	Detector	Polarization
1	4844.00	49.18	35.45	44.36	12.07	52.34	74.00	-21.66	Peak	VERTICAL
2	16460.00	37.64	43.64	40.23	24.40	65.45	74.00	-8.55	Peak	VERTICAL
3	16460.00	22.26	43.64	40.23	24.40	50.07	54.00	-3.93	Average	VERTICAL

- Note: 1. Result Level = Read Level + Antenna Factor + Cable loss - PRM Factor
 2. If Peak Result comply with AV limit, AV Result is deemed to comply with AV limit
 3. Test setup: RBW: 1MHz, VBW: 3MHz, Sweep time:auto

Radiated Emission Test Result

Test Site	: DDT 3m Chamber	E:\2013 Report data\13QE0070\RE 1G-18G.EM6
Test Date	: 2013-08-08	Tested By : Leo Liu
EUT	: GuruPlug	Model Number : 003-GP0XXXXXX
Power Supply	: AC 120V/60Hz	Test Mode : 11N HT40 CH3
Condition	: Temp:24.5'C,Humi:55%, Press:100.1kPa	Antenna/Distance : 2013 HF907/3m/HORIZONTAL
Memo	:	

Data: 39

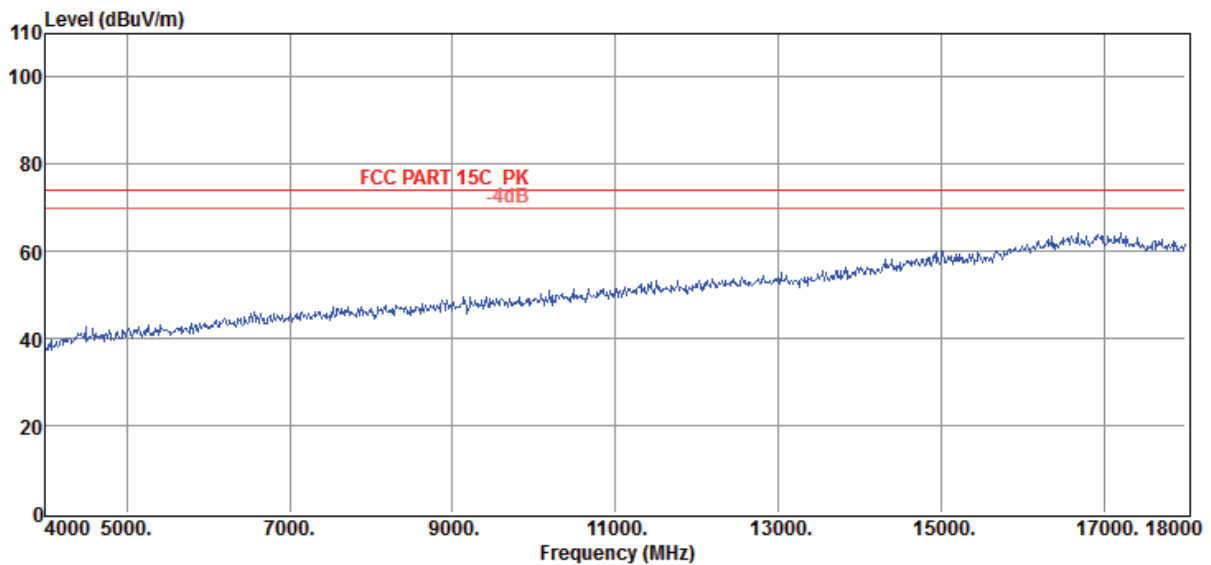

Item (Mark)	Freq (MHz)	Read Level (dBμV)	Antenna Factor (dB/m)	PRM Factor dB	Cable Loss dB	Result Level (dBμV/m)	Limit Line (dBμV/m)	Over Limit (dB)	Detector	Polarization

- Note: 1. Result Level = Read Level + Antenna Factor + Cable loss - PRM Factor
 2. If Peak Result comply with AV limit, AV Result is deemed to comply with AV limit
 3. Test setup: RBW: 1MHz, VBW: 3MHz, Sweep time:auto

Radiated Emission Test Result

Test Site : DDT 3m Chamber E:\2013 Report data\13QE0070\RE 1G-18G.EM6
Test Date : 2013-08-08 **Tested By** : Leo Liu
EUT : GuruPlug **Model Number** : 003-GP0XXXXXX
Power Supply : AC 120V/60Hz **Test Mode** : 11N HT40 CH3
Condition : Temp:24.5'C,Humi:55%,
Antenna/Distance : 2013 HF907/3m/HORIZONTAL
Press:100.1kPa
Memo :

Data: 40

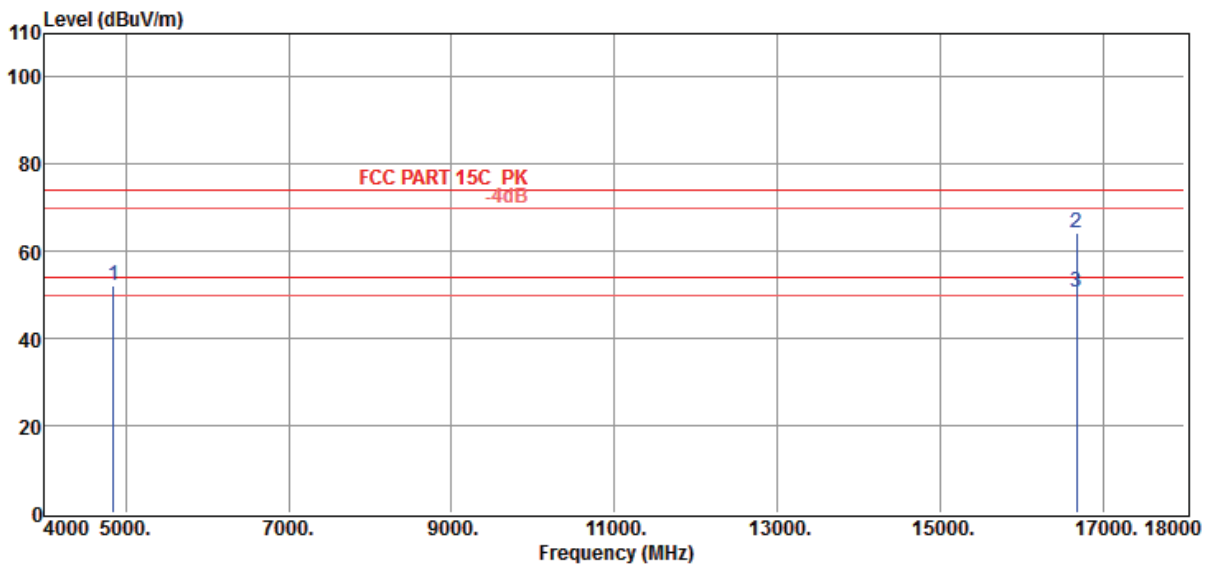

Item (Mark)	Freq (MHz)	Read Level (dBμV)	Antenna Factor (dB/m)	PRM Factor (dB)	Cable Loss (dB)	Result Level (dBμV/m)	Limit Line (dBμV/m)	Over Limit (dB)	Detector	Polarization
1	4844.00	49.14	35.45	44.36	12.07	52.30	74.00	-21.70	Peak	HORIZONTAL
2	16670.00	35.76	43.67	40.27	25.00	64.16	74.00	-9.84	Peak	HORIZONTAL
3	16670.00	22.36	43.67	40.27	25.00	50.76	54.00	-3.24	Average	HORIZONTAL

- Note: 1. Result Level = Read Level + Antenna Factor + Cable loss - PRM Factor
 2. If Peak Result comply with AV limit, AV Result is deemed to comply with AV limit
 3. Test setup: RBW: 1MHz, VBW: 3MHz, Sweep time:auto

Radiated Emission Test Result

Test Site	: DDT 3m Chamber	E:\2013 Report data\13QE0070\RE 1G-18G.EM6
Test Date	: 2013-08-08	Tested By : Leo Liu
EUT	: GuruPlug	Model Number : 003-GP0XXXXXX
Power Supply	: AC 120V/60Hz	Test Mode : 11N HT40 CH6
Condition	: Temp:24.5'C,Humi:55%, Press:100.1kPa	Antenna/Distance : 2013 HF907/3m/HORIZONTAL
Memo	:	

Data: 41

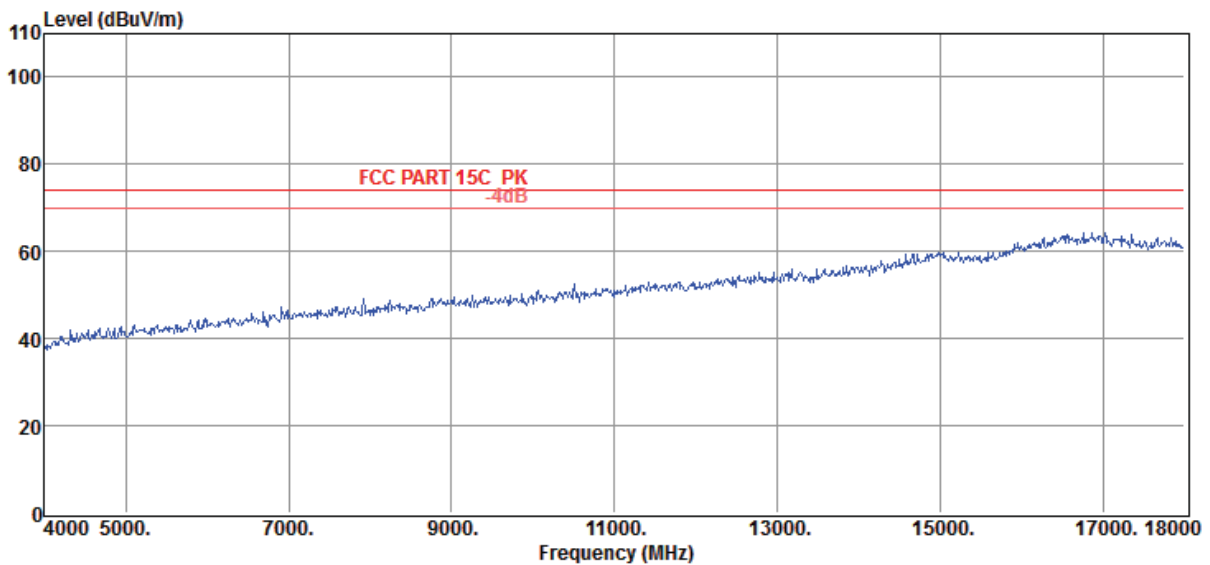

Item	Freq	Read Level	Antenna Factor	PRM Factor	Cable Loss	Result Level	Limit Line	Over Limit	Detector	Polarization
(Mark)	(MHz)	(dBμV)	(dB/m)	dB	dB	(dBμV/m)	(dBμV/m)	(dB)		

- Note: 1. Result Level = Read Level + Antenna Factor + Cable loss - PRM Factor
 2. If Peak Result comply with AV limit, AV Result is deemed to comply with AV limit
 3. Test setup: RBW: 1MHz, VBW: 3MHz, Sweep time:auto

Radiated Emission Test Result

Test Site : DDT 3m Chamber E:\2013 Report data\13QE0070\RE 1G-18G.EM6
Test Date : 2013-08-08 **Tested By** : Leo Liu
EUT : GuruPlug **Model Number** : 003-GP0XXXXXX
Power Supply : AC 120V/60Hz **Test Mode** : 11N HT40 CH6
Condition : Temp:24.5'C,Humi:55%,
Antenna/Distance : 2013 HF907/3m/HORIZONTAL
Press:100.1kPa
Memo :

Data: 42

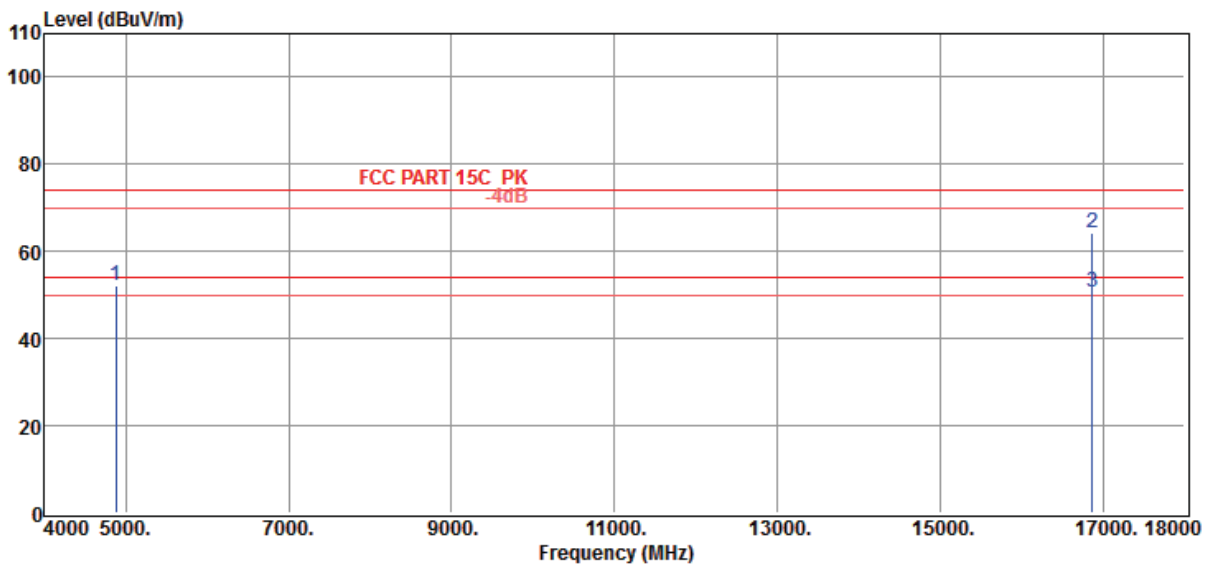

Item (Mark)	Freq (MHz)	Read Level (dBμV)	Antenna Factor (dB/m)	PRM Factor (dB)	Cable Loss (dB)	Result Level (dBμV/m)	Limit Line (dBμV/m)	Over Limit (dB)	Detector	Polarization
1	4874.00	49.07	35.51	44.35	12.04	52.27	74.00	-21.73	Peak	HORIZONTAL
2	16866.00	35.39	43.63	40.35	25.60	64.27	74.00	-9.73	Peak	HORIZONTAL
3	16866.00	21.69	43.63	40.35	25.60	50.57	54.00	-3.43	Average	HORIZONTAL

- Note: 1. Result Level = Read Level + Antenna Factor + Cable loss - PRM Factor
 2. If Peak Result comply with AV limit, AV Result is deemed to comply with AV limit
 3. Test setup: RBW: 1MHz, VBW: 3MHz, Sweep time:auto

Radiated Emission Test Result

Test Site	: DDT 3m Chamber	E:\2013 Report data\13QE0070\RE 1G-18G.EM6
Test Date	: 2013-08-08	Tested By : Leo Liu
EUT	: GuruPlug	Model Number : 003-GP0XXXXXX
Power Supply	: AC 120V/60Hz	Test Mode : 11N HT40 CH6
Condition	: Temp:24.5'C,Humi:55%, Press:100.1kPa	Antenna/Distance : 2013 HF907/3m/VERTICAL
Memo	:	

Data: 43

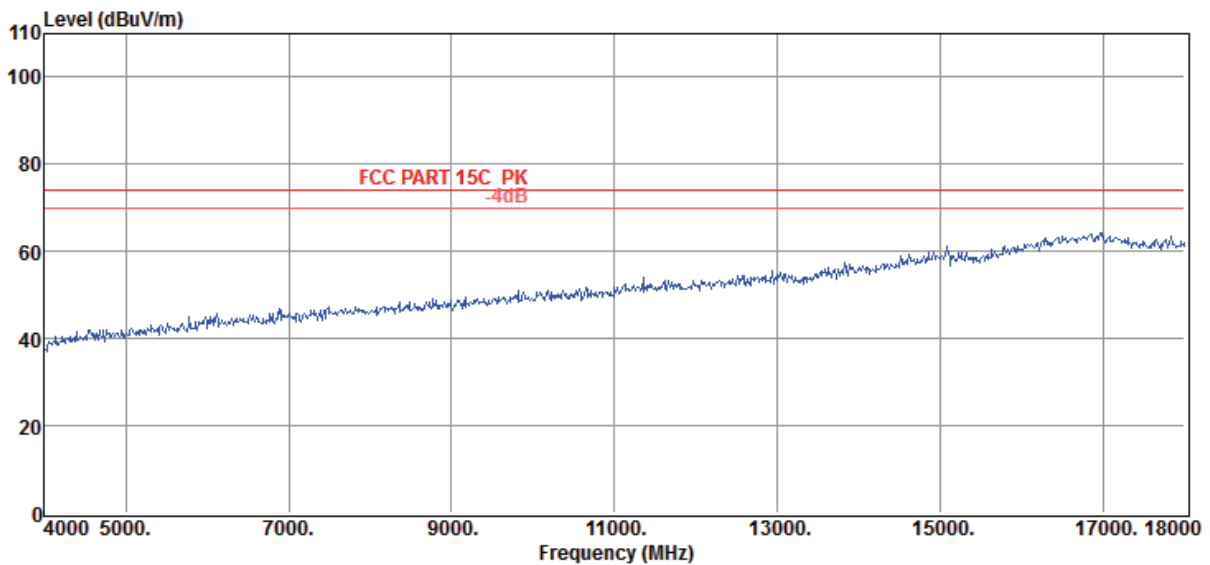

Item (Mark)	Freq (MHz)	Read Level (dBμV)	Antenna Factor (dB/m)	PRM Factor dB	Cable Loss dB	Result Level (dBμV/m)	Limit Line (dBμV/m)	Over Limit (dB)	Detector	Polarization

- Note: 1. Result Level = Read Level + Antenna Factor + Cable loss - PRM Factor
 2. If Peak Result comply with AV limit, AV Result is deemed to comply with AV limit
 3. Test setup: RBW: 1MHz, VBW: 3MHz, Sweep time:auto

Radiated Emission Test Result

Test Site	: DDT 3m Chamber	E:\2013 Report data\13QE0070\RE 1G-18G.EM6
Test Date	: 2013-08-08	Tested By : Leo Liu
EUT	: GuruPlug	Model Number : 003-GP0XXXXXX
Power Supply	: AC 120V/60Hz	Test Mode : 11N HT40 CH6
Condition	: Temp:24.5'C,Humi:55%, Press:100.1kPa	Antenna/Distance : 2013 HF907/3m/VERTICAL
Memo	:	

Data: 44

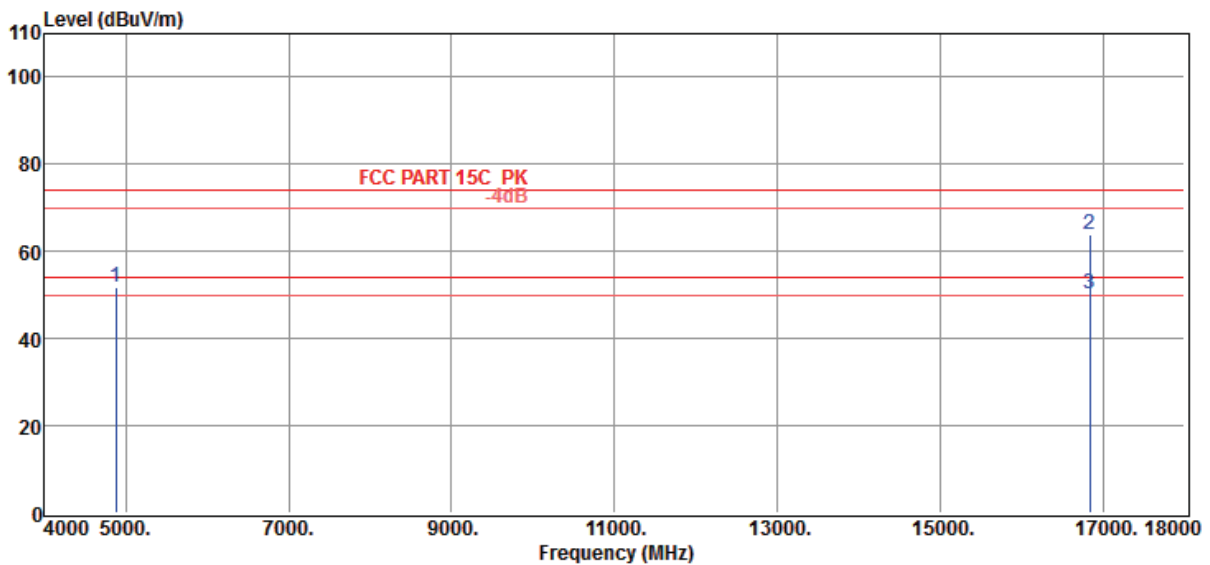

Item (Mark)	Freq (MHz)	Read Level (dBμV)	Antenna Factor (dB/m)	PRM Factor dB	Cable Loss dB	Result Level (dBμV/m)	Limit Line (dBμV/m)	Over Limit (dB)	Detector	Polarization
1	4874.00	48.76	35.51	44.35	12.04	51.96	74.00	-22.04	Peak	VERTICAL
2	16838.00	35.16	43.63	40.33	25.60	64.06	74.00	-9.94	Peak	VERTICAL
3	16838.00	21.23	43.63	40.33	25.60	50.13	54.00	-3.87	Average	VERTICAL

- Note: 1. Result Level = Read Level + Antenna Factor + Cable loss - PRM Factor
 2. If Peak Result comply with AV limit, AV Result is deemed to comply with AV limit
 3. Test setup: RBW: 1MHz, VBW: 3MHz, Sweep time:auto

Radiated Emission Test Result

Test Site	: DDT 3m Chamber	E:\2013 Report data\13QE0070\RE 1G-18G.EM6
Test Date	: 2013-08-08	Tested By : Leo Liu
EUT	: GuruPlug	Model Number : 003-GP0XXXXXX
Power Supply	: AC 120V/60Hz	Test Mode : 11N HT40 CH9
Condition	: Temp:24.5'C,Humi:55%, Press:100.1kPa	Antenna/Distance : 2013 HF907/3m/VERTICAL
Memo	:	

Data: 45

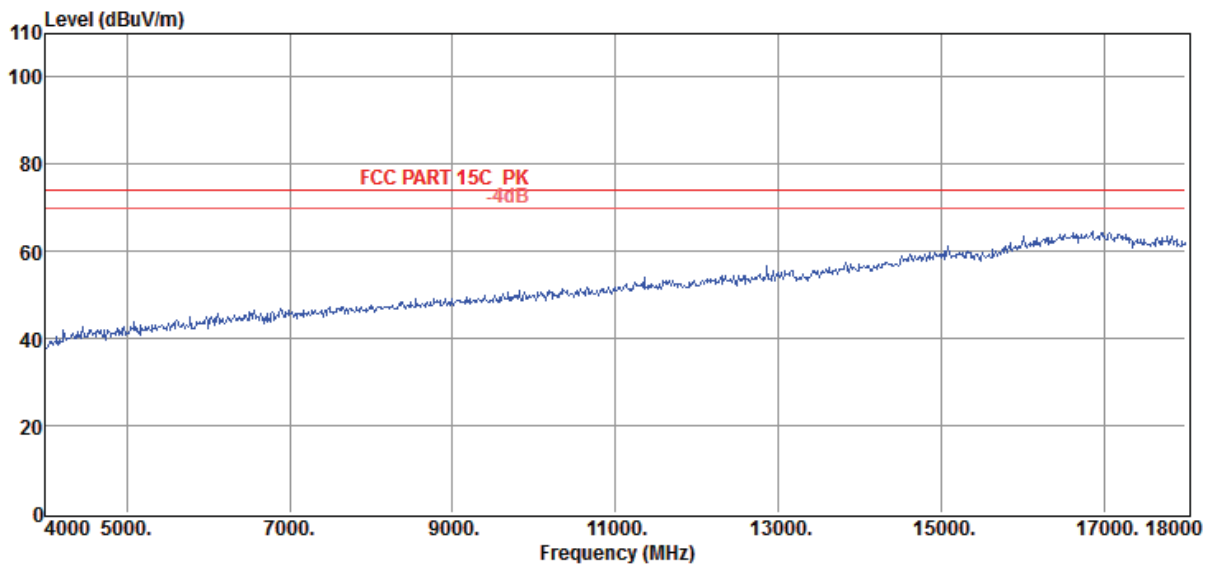

Item	Freq	Read Level	Antenna Factor	PRM Factor	Cable Loss	Result Level	Limit Line	Over Limit	Detector	Polarization
(Mark)	(MHz)	(dBμV)	(dB/m)	dB	dB	(dBμV/m)	(dBμV/m)	(dB)		

- Note: 1. Result Level = Read Level + Antenna Factor + Cable loss - PRM Factor
 2. If Peak Result comply with AV limit, AV Result is deemed to comply with AV limit
 3. Test setup: RBW: 1MHz, VBW: 3MHz, Sweep time:auto

Radiated Emission Test Result

Test Site	: DDT 3m Chamber	E:\2013 Report data\13QE0070\RE 1G-18G.EM6
Test Date	: 2013-08-08	Tested By : Leo Liu
EUT	: GuruPlug	Model Number : 003-GP0XXXXXX
Power Supply	: AC 120V/60Hz	Test Mode : 11N HT40 CH9
Condition	: Temp:24.5'C,Humi:55%, Press:100.1kPa	Antenna/Distance : 2013 HF907/3m/VERTICAL
Memo	:	

Data: 46

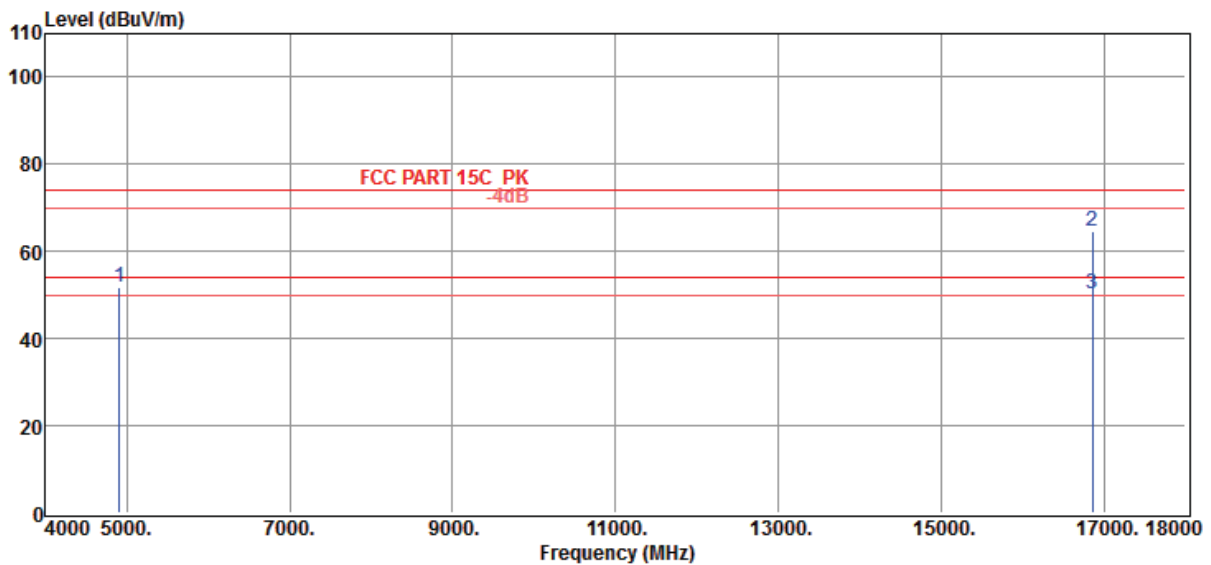

Item (Mark)	Freq (MHz)	Read Level (dBμV)	Antenna Factor (dB/m)	PRM Factor dB	Cable Loss dB	Result Level (dBμV/m)	Limit Line (dBμV/m)	Over Limit (dB)	Detector	Polarization
1	4904.00	48.70	35.56	44.34	12.04	51.96	74.00	-22.04	Peak	VERTICAL
2	16852.00	35.75	43.63	40.34	25.60	64.64	74.00	-9.36	Peak	VERTICAL
3	16852.00	21.36	43.63	40.34	25.60	50.25	54.00	-3.75	Average	VERTICAL

- Note: 1. Result Level = Read Level + Antenna Factor + Cable loss - PRM Factor
 2. If Peak Result comply with AV limit, AV Result is deemed to comply with AV limit
 3. Test setup: RBW: 1MHz, VBW: 3MHz, Sweep time:auto

Radiated Emission Test Result

Test Site	: DDT 3m Chamber	E:\2013 Report data\13QE0070\RE 1G-18G.EM6
Test Date	: 2013-08-08	Tested By : Leo Liu
EUT	: GuruPlug	Model Number : 003-GP0XXXXXX
Power Supply	: AC 120V/60Hz	Test Mode : 11N HT40 CH9
Condition	: Temp:24.5'C,Humi:55%, Press:100.1kPa	Antenna/Distance : 2013 HF907/3m/HORIZONTAL
Memo	:	

Data: 47

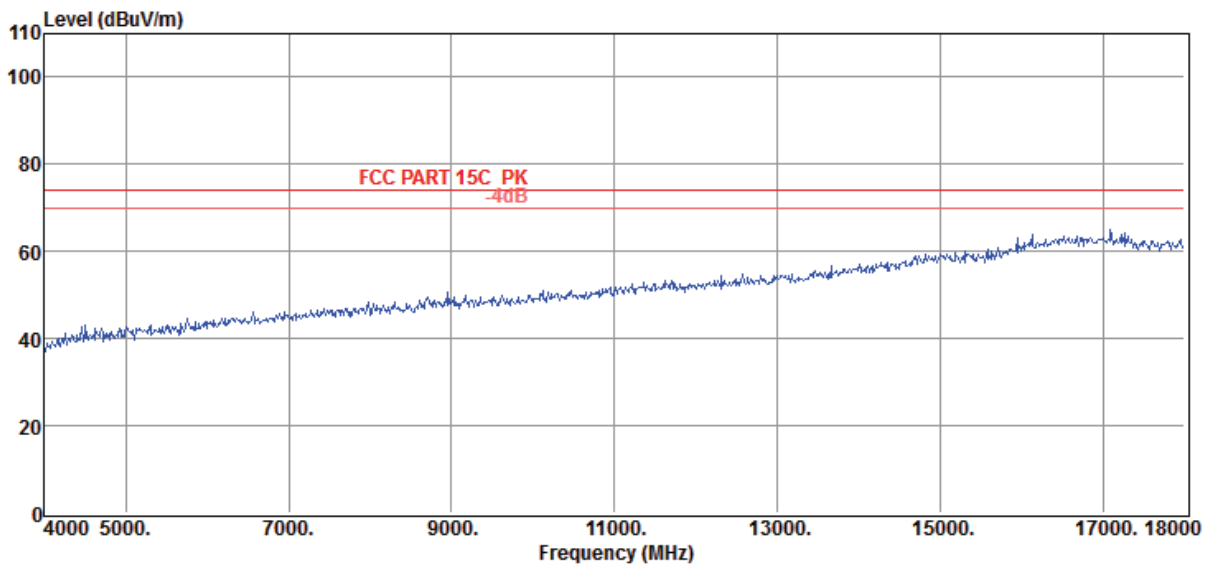

Item	Freq	Read Level	Antenna Factor	PRM Factor	Cable Loss	Result Level	Limit Line	Over Limit	Detector	Polarization
(Mark)	(MHz)	(dBμV)	(dB/m)	dB	dB	(dBμV/m)	(dBμV/m)	(dB)		

- Note: 1. Result Level = Read Level + Antenna Factor + Cable loss - PRM Factor
 2. If Peak Result comply with AV limit, AV Result is deemed to comply with AV limit
 3. Test setup: RBW: 1MHz, VBW: 3MHz, Sweep time:auto

Radiated Emission Test Result

Test Site : DDT 3m Chamber **E:\2013 Report data\13QE0070\RE 1G-18G.EM6**
Test Date : 2013-08-08 **Tested By** : Leo Liu
EUT : GuruPlug **Model Number** : 003-GP0XXXXXX
Power Supply : AC 120V/60Hz **Test Mode** : 11N HT40 CH9
Condition : Temp:24.5'C,Humi:55%,
Antenna/Distance : 2013 HF907/3m/HORIZONTAL
Press:100.1kPa
Memo :

Data: 48

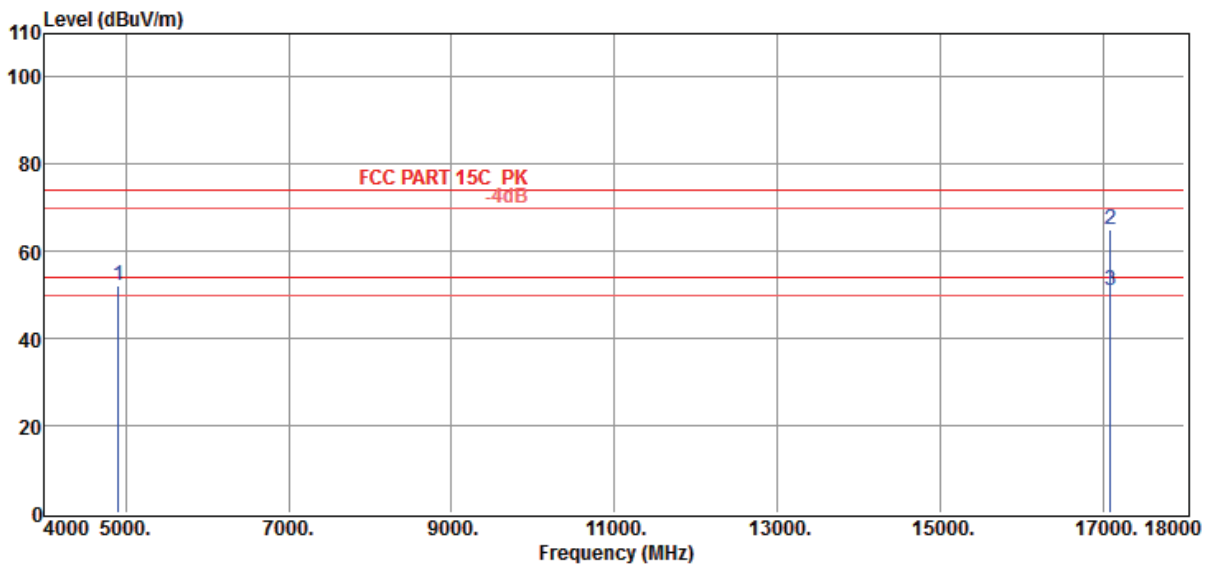

Item (Mark)	Freq (MHz)	Read Level (dBμV)	Antenna Factor (dB/m)	PRM Factor dB	Cable Loss dB	Result Level (dBμV/m)	Limit Line (dBμV/m)	Over Limit (dB)	Detector	Polarization
1	4904.00	48.92	35.56	44.34	12.04	52.18	74.00	-21.82	Peak	HORIZONTAL
2	17090.00	36.59	43.47	40.44	25.47	65.09	74.00	-8.91	Peak	HORIZONTAL
3	17090.00	22.36	43.47	40.44	25.47	50.86	54.00	-3.14	Average	HORIZONTAL

- Note: 1. Result Level = Read Level + Antenna Factor + Cable loss - PRM Factor
 2. If Peak Result comply with AV limit, AV Result is deemed to comply with AV limit
 3. Test setup: RBW: 1MHz, VBW: 3MHz, Sweep time:auto

Radiated Emission Test Result

Test Site	: DDT 3m Chamber	E:\2013 Report data\13QE0070\RE 1G-18G.EM6
Test Date	: 2013-08-08	Tested By : Leo Liu
EUT	: GuruPlug	Model Number : 003-GP0XXXXXX
Power Supply	: AC 120V/60Hz	Test Mode : 11B CH1
Condition	: Temp:24.5'C,Humi:55%, Press:100.1kPa	Antenna/Distance : 2013 HF907/3m/HORIZONTAL
Memo	:	

Data: 49

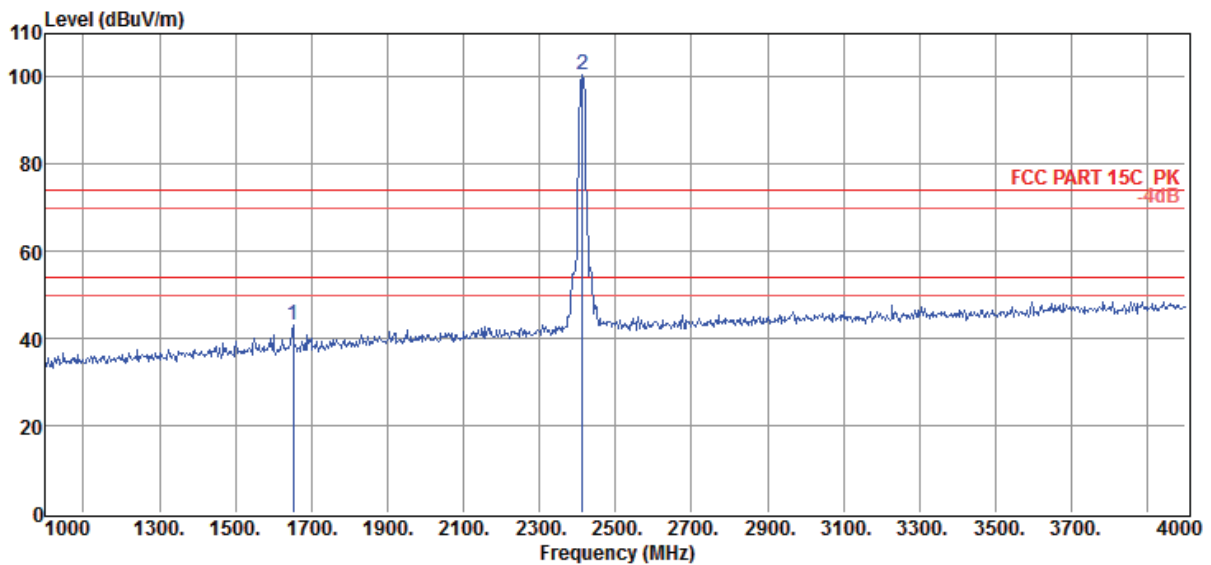

Item (Mark)	Freq (MHz)	Read Level (dBμV)	Antenna Factor (dB/m)	PRM Factor dB	Cable Loss dB	Result Level (dBμV/m)	Limit Line (dBμV/m)	Over Limit (dB)	Detector	Polarization
1	1651.00	52.89	27.05	43.60	6.93	43.27	74.00	-30.73	Peak	HORIZONTAL
2	2413.00	105.89	30.04	43.85	8.35	100.43	/	/	Peak	HORIZONTAL

- Note: 1. Result Level = Read Level + Antenna Factor + Cable loss - PRM Factor
 2. If Peak Result comply with AV limit, AV Result is deemed to comply with AV limit
 3. Test setup: RBW: 1MHz, VBW: 3MHz, Sweep time:auto

Radiated Emission Test Result

Test Site : DDT 3m Chamber E:\2013 Report data\13QE0070\RE 1G-18G.EM6
Test Date : 2013-08-08 **Tested By** : Leo Liu
EUT : GuruPlug **Model Number** : 003-GP0XXXXXX
Power Supply : AC 120V/60Hz **Test Mode** : 11B CH1
Condition : Temp:24.5'C,Humi:55%,
Antenna/Distance : 2013 HF907/3m/VERTICAL
 Press:100.1kPa
Memo :

Data: 50

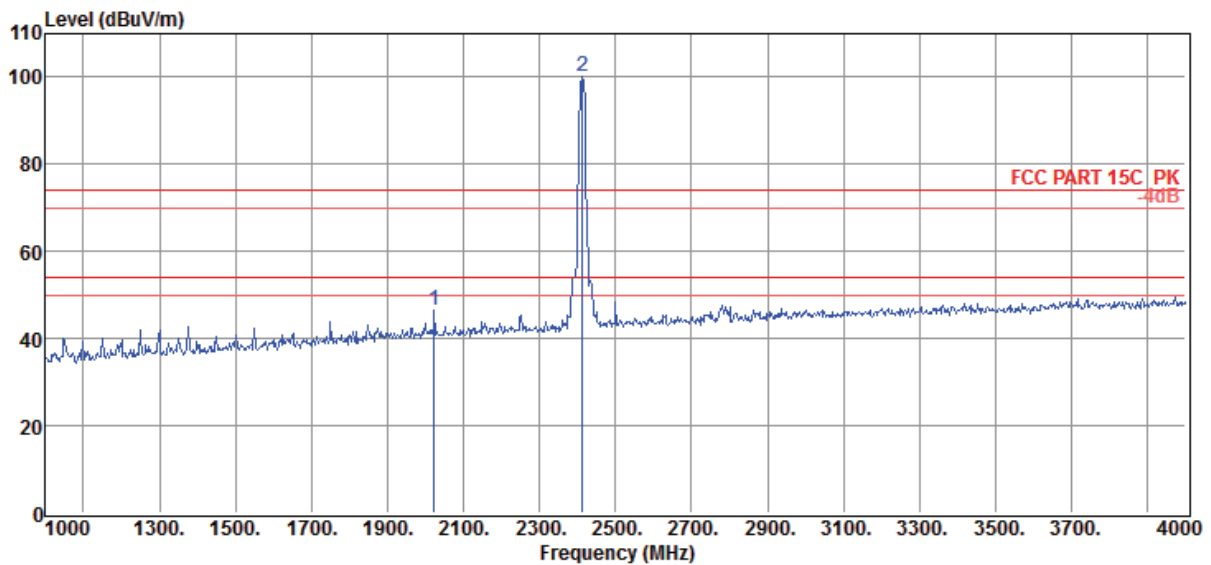

Item (Mark)	Freq (MHz)	Read Level (dBμV)	Antenna Factor (dB/m)	PRM Factor (dB)	Cable Loss (dB)	Result Level (dBμV/m)	Limit Line (dBμV/m)	Over Limit (dB)	Detector	Polarization
1	2023.00	53.74	28.85	43.61	7.65	46.63	74.00	-27.37	Peak	VERTICAL
2	2413.00	105.72	30.04	43.85	8.35	100.26	/	/	Peak	VERTICAL

- Note: 1. Result Level = Read Level + Antenna Factor + Cable loss - PRM Factor
 2. If Peak Result comply with AV limit, AV Result is deemed to comply with AV limit
 3. Test setup: RBW: 1MHz, VBW: 3MHz, Sweep time:auto

Radiated Emission Test Result

Test Site	: DDT 3m Chamber	E:\2013 Report data\13QE0070\RE 1G-18G.EM6
Test Date	: 2013-08-08	Tested By : Leo Liu
EUT	: GuruPlug	Model Number : 003-GP0XXXXXX
Power Supply	: AC 120V/60Hz	Test Mode : 11B CH6
Condition	: Temp:24.5'C,Humi:55%, Press:100.1kPa	Antenna/Distance : 2013 HF907/3m/HORIZONTAL
Memo	:	

Data: 53

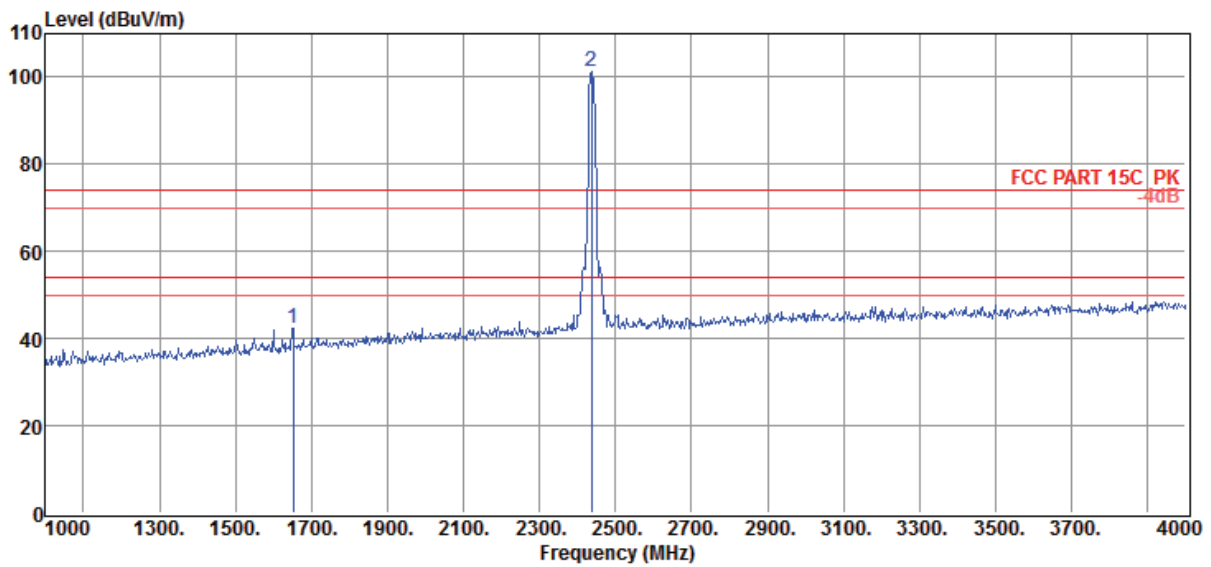

Item (Mark)	Freq (MHz)	Read Level (dBμV)	Antenna Factor (dB/m)	PRM Factor dB	Cable Loss dB	Result Level (dBμV/m)	Limit Line (dBμV/m)	Over Limit (dB)	Detector	Polarization
1	1651.00	52.13	27.05	43.60	6.93	42.51	74.00	-31.49	Peak	HORIZONTAL
2	2437.00	106.72	30.14	43.86	8.40	101.40	/	/	Peak	HORIZONTAL

- Note: 1. Result Level = Read Level + Antenna Factor + Cable loss - PRM Factor
 2. If Peak Result comply with AV limit, AV Result is deemed to comply with AV limit
 3. Test setup: RBW: 1MHz, VBW: 3MHz, Sweep time:auto

Radiated Emission Test Result

Test Site	: DDT 3m Chamber	E:\2013 Report data\13QE0070\RE 1G-18G.EM6
Test Date	: 2013-08-08	Tested By : Leo Liu
EUT	: GuruPlug	Model Number : 003-GP0XXXXXX
Power Supply	: AC 120V/60Hz	Test Mode : 11B CH6
Condition	: Temp:24.5'C,Humi:55%, Press:100.1kPa	Antenna/Distance : 2013 HF907/3m/VERTICAL
Memo	:	

Data: 54

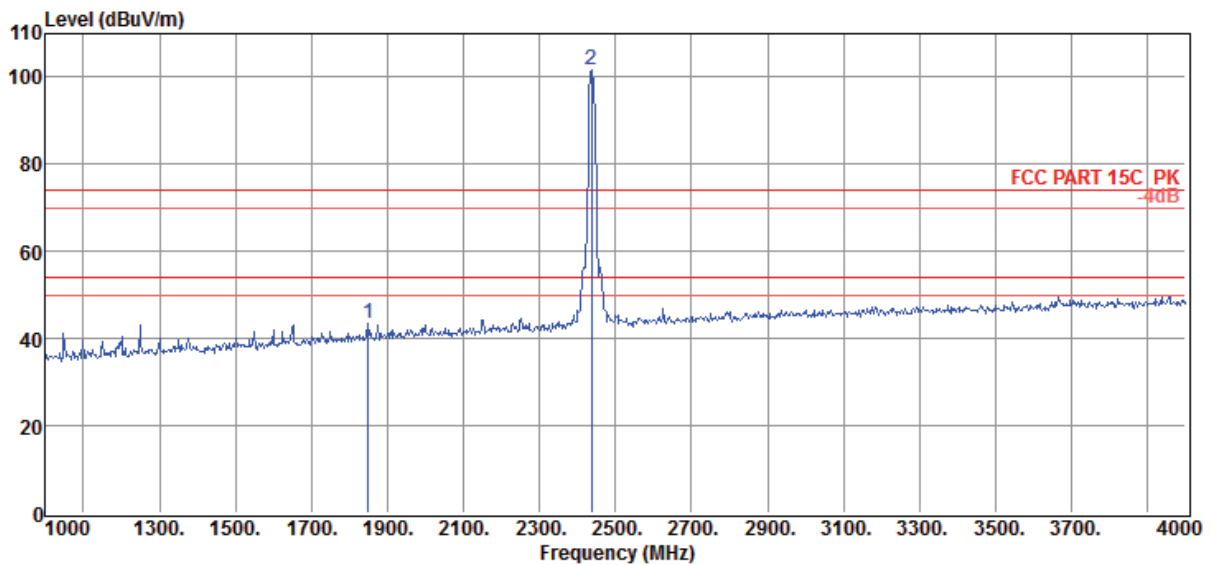

Item (Mark)	Freq (MHz)	Read Level (dBμV)	Antenna Factor (dB/m)	PRM Factor dB	Cable Loss dB	Result Level (dBμV/m)	Limit Line (dBμV/m)	Over Limit (dB)	Detector	Polarization
1	1849.00	51.70	28.05	43.60	7.35	43.50	74.00	-30.50	Peak	VERTICAL
2	2437.00	106.90	30.14	43.86	8.40	101.58	/	/	Peak	VERTICAL

- Note: 1. Result Level = Read Level + Antenna Factor + Cable loss - PRM Factor
 2. If Peak Result comply with AV limit, AV Result is deemed to comply with AV limit
 3. Test setup: RBW: 1MHz, VBW: 3MHz, Sweep time:auto

Radiated Emission Test Result

Test Site	: DDT 3m Chamber	E:\2013 Report data\13QE0070\RE 1G-18G.EM6
Test Date	: 2013-08-08	Tested By : Leo Liu
EUT	: GuruPlug	Model Number : 003-GP0XXXXXX
Power Supply	: AC 120V/60Hz	Test Mode : 11B CH11
Condition	: Temp:24.5'C,Humi:55%, Press:100.1kPa	Antenna/Distance : 2013 HF907/3m/VERTICAL
Memo	:	

Data: 55

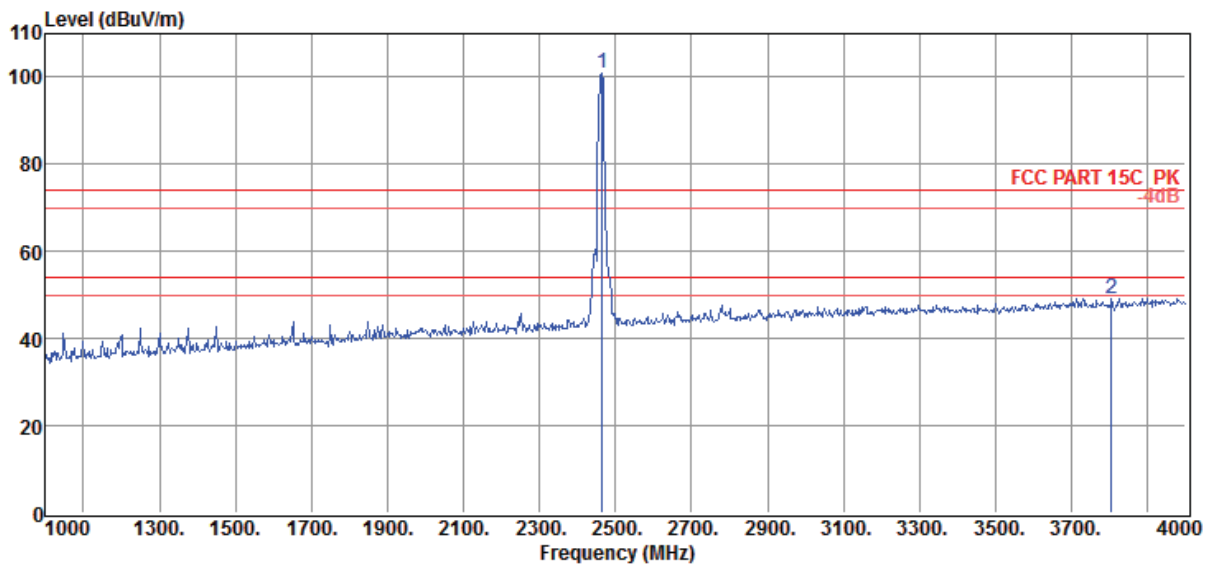

Item (Mark)	Freq (MHz)	Read Level (dBμV)	Antenna Factor (dB/m)	PRM Factor dB	Cable Loss dB	Result Level (dBμV/m)	Limit Line (dBμV/m)	Over Limit (dB)	Detector	Polarization
1	2464.00	106.16	30.20	43.88	8.45	100.93	/	/	Peak	VERTICAL
2	3805.00	49.68	33.03	44.24	10.81	49.28	74.00	-24.72	Peak	VERTICAL

- Note: 1. Result Level = Read Level + Antenna Factor + Cable loss - PRM Factor
 2. If Peak Result comply with AV limit, AV Result is deemed to comply with AV limit
 3. Test setup: RBW: 1MHz, VBW: 3MHz, Sweep time:auto

Radiated Emission Test Result

Test Site : DDT 3m Chamber	E:\2013 Report data\13QE0070\RE 1G-18G.EM6
Test Date : 2013-08-08	Tested By : Leo Liu
EUT : GuruPlug	Model Number : 003-GP0XXXXXX
Power Supply : AC 120V/60Hz	Test Mode : 11B CH11
Condition : Temp:24.5'C,Humi:55%, Press:100.1kPa	Antenna/Distance : 2013 HF907/3m/HORIZONTAL
Memo :	

Data: 56

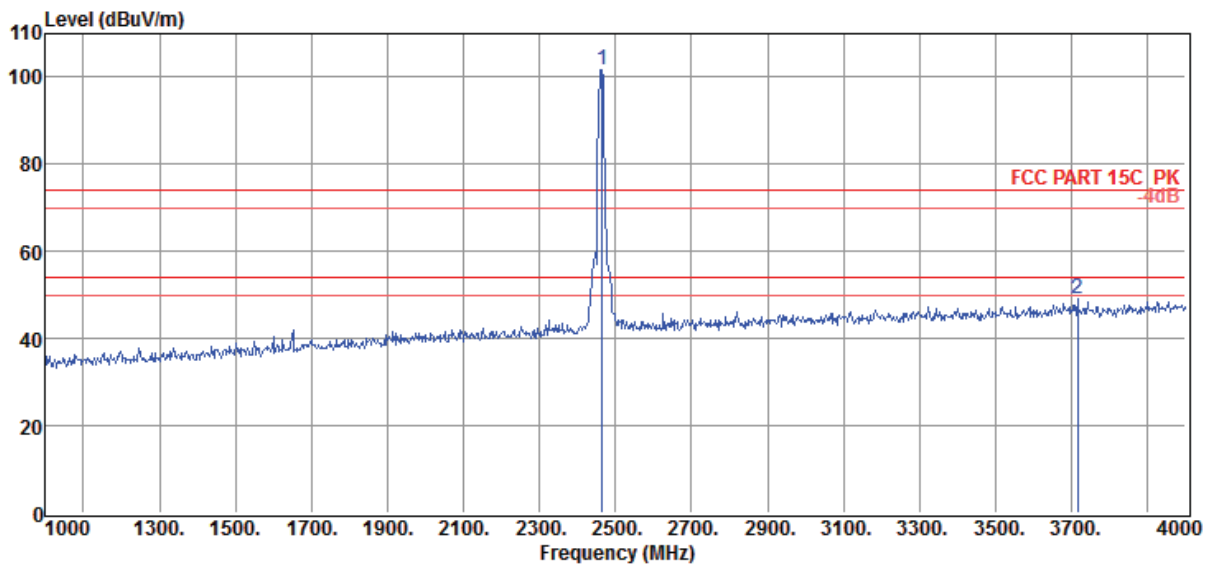

Item (Mark)	Freq (MHz)	Read Level (dBμV)	Antenna Factor (dB/m)	PRM Factor dB	Cable Loss dB	Result Level (dBμV/m)	Limit Line (dBμV/m)	Over Limit (dB)	Detector	Polarization
1	2464.00	106.99	30.20	43.88	8.45	101.76	/	/	Peak	HORIZONTAL
2	3715.00	49.77	32.91	44.26	10.66	49.08	74.00	-24.92	Peak	HORIZONTAL

- Note: 1. Result Level = Read Level + Antenna Factor + Cable loss - PRM Factor
 2. If Peak Result comply with AV limit, AV Result is deemed to comply with AV limit
 3. Test setup: RBW: 1MHz, VBW: 3MHz, Sweep time:auto

Radiated Emission Test Result

Test Site	: DDT 3m Chamber	E:\2013 Report data\13QE0070\RE 1G-18G.EM6
Test Date	: 2013-08-08	Tested By : Leo Liu
EUT	: GuruPlug	Model Number : 003-GP0XXXXXX
Power Supply	: AC 120V/60Hz	Test Mode : 11G CH1
Condition	: Temp:24.5'C,Humi:55%, Press:100.1kPa	Antenna/Distance : 2013 HF907/3m/VERTICAL
Memo	:	

Data: 59

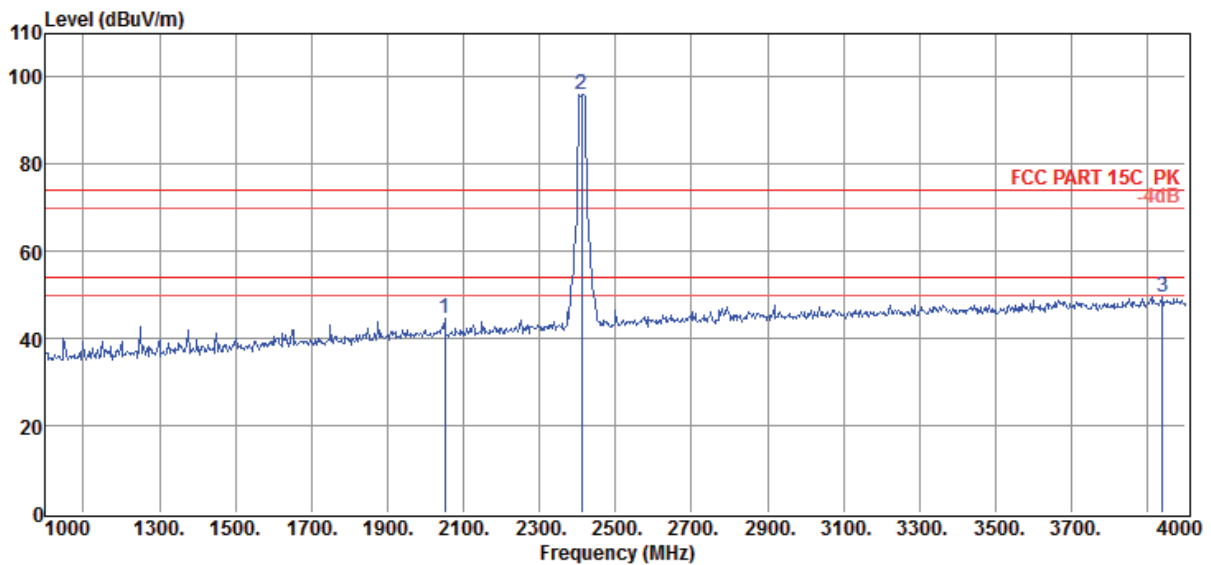

Item (Mark)	Freq (MHz)	Read Level (dBμV)	Antenna Factor (dB/m)	PRM Factor dB	Cable Loss dB	Result Level (dBμV/m)	Limit Line (dBμV/m)	Over Limit (dB)	Detector	Polarization
1	2050.00	51.43	28.96	43.63	7.70	44.46	74.00	-29.54	Peak	VERTICAL
2	2410.00	101.56	30.04	43.85	8.35	96.10	/	/	Peak	VERTICAL
3	3940.00	49.62	33.23	44.21	11.03	49.67	74.00	-24.33	Peak	VERTICAL

- Note: 1. Result Level = Read Level + Antenna Factor + Cable loss - PRM Factor
 2. If Peak Result comply with AV limit, AV Result is deemed to comply with AV limit
 3. Test setup: RBW: 1MHz, VBW: 3MHz, Sweep time:auto

Radiated Emission Test Result

Test Site : DDT 3m Chamber E:\2013 Report data\13QE0070\RE 1G-18G.EM6
Test Date : 2013-08-08 **Tested By** : Leo Liu
EUT : GuruPlug **Model Number** : 003-GP0XXXXXX
Power Supply : AC 120V/60Hz **Test Mode** : 11G CH1
Condition : Temp:24.5'C,Humi:55%,
Antenna/Distance : 2013 HF907/3m/HORIZONTAL
 Press:100.1kPa
Memo :

Data: 60

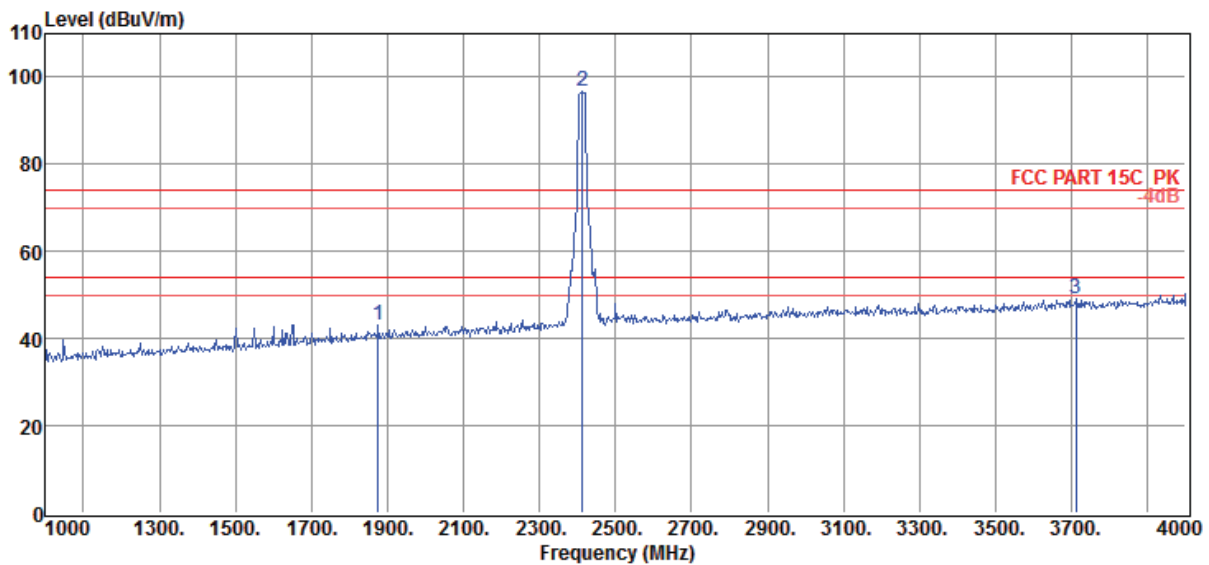

Item (Mark)	Freq (MHz)	Read Level (dBμV)	Antenna Factor (dB/m)	PRM Factor (dB)	Cable Loss (dB)	Result Level (dBμV/m)	Limit Line (dBμV/m)	Over Limit (dB)	Detector	Polarization
1	1876.00	51.11	28.22	43.60	7.39	43.12	74.00	-30.88	Peak	HORIZONTAL
2	2413.00	102.35	30.04	43.85	8.35	96.89	/	/	Peak	HORIZONTAL
3	3712.00	49.84	32.91	44.26	10.66	49.15	74.00	-24.85	Peak	HORIZONTAL

- Note: 1. Result Level = Read Level + Antenna Factor + Cable loss - PRM Factor
 2. If Peak Result comply with AV limit, AV Result is deemed to comply with AV limit
 3. Test setup: RBW: 1MHz, VBW: 3MHz, Sweep time:auto

Radiated Emission Test Result

Test Site : DDT 3m Chamber E:\2013 Report data\13QE0070\RE 1G-18G.EM6
Test Date : 2013-08-08 **Tested By** : Leo Liu
EUT : GuruPlug **Model Number** : 003-GP0XXXXXX
Power Supply : AC 120V/60Hz **Test Mode** : 11G CH6
Condition : Temp:24.5'C,Humi:55%,
Antenna/Distance : 2013 HF907/3m/VERTICAL
Press:100.1kPa
Memo :

Data: 63

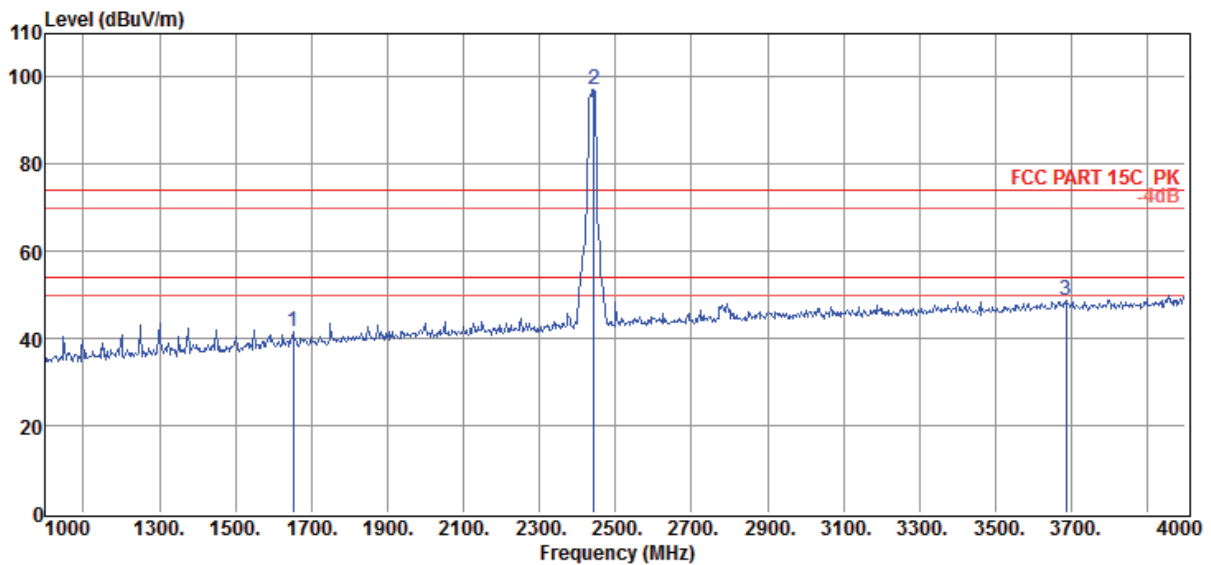

Item (Mark)	Freq (MHz)	Read Level (dBμV)	Antenna Factor (dB/m)	PRM Factor (dB)	Cable Loss (dB)	Result Level (dBμV/m)	Limit Line (dBμV/m)	Over Limit (dB)	Detector	Polarization
1	1651.00	51.16	27.05	43.60	6.93	41.54	74.00	-32.46	Peak	VERTICAL
2	2443.00	102.44	30.14	43.87	8.40	97.11	/	/	Peak	VERTICAL
3	3685.00	49.74	32.87	44.26	10.59	48.94	74.00	-25.06	Peak	VERTICAL

- Note: 1. Result Level = Read Level + Antenna Factor + Cable loss - PRM Factor
 2. If Peak Result comply with AV limit, AV Result is deemed to comply with AV limit
 3. Test setup: RBW: 1MHz, VBW: 3MHz, Sweep time:auto

Radiated Emission Test Result

Test Site : DDT 3m Chamber E:\2013 Report data\13QE0070\RE 1G-18G.EM6
Test Date : 2013-08-08 **Tested By** : Leo Liu
EUT : GuruPlug **Model Number** : 003-GP0XXXXXX
Power Supply : AC 120V/60Hz **Test Mode** : 11G CH6
Condition : Temp:24.5'C,Humi:55%,
Antenna/Distance : 2013 HF907/3m/HORIZONTAL
 Press:100.1kPa
Memo :

Data: 64

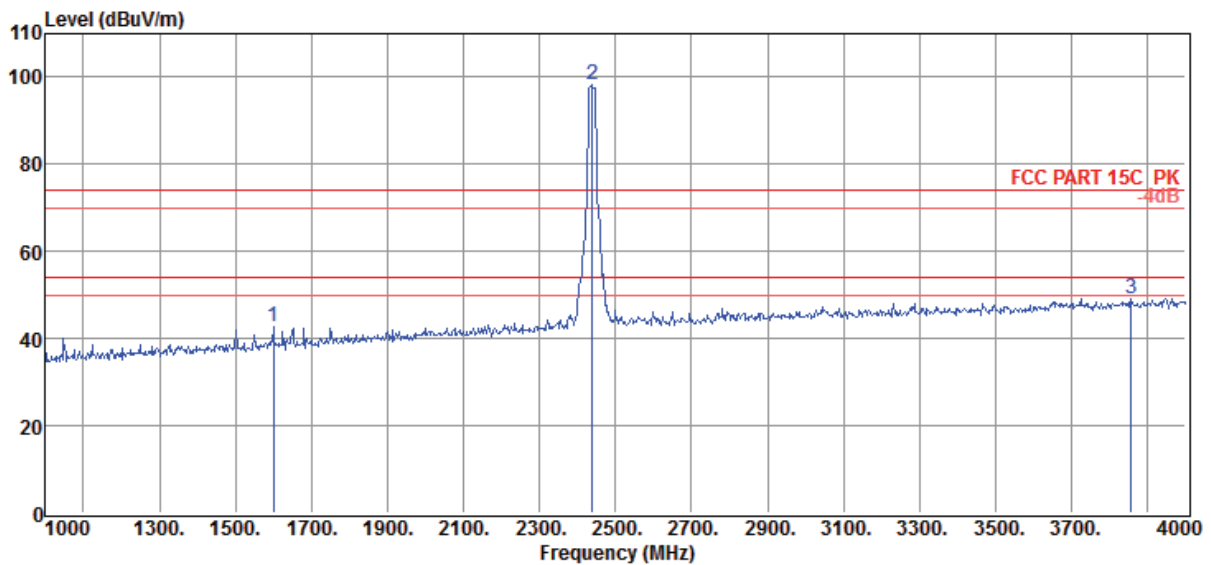

Item (Mark)	Freq (MHz)	Read Level (dBμV)	Antenna Factor (dB/m)	PRM Factor (dB)	Cable Loss (dB)	Result Level (dBμV/m)	Limit Line (dBμV/m)	Over Limit (dB)	Detector	Polarization
1	1600.00	52.84	26.80	43.60	6.85	42.89	74.00	-31.11	Peak	HORIZONTAL
2	2440.00	103.74	30.14	43.87	8.40	98.41	/	/	Peak	HORIZONTAL
3	3856.00	49.48	33.11	44.23	10.88	49.24	74.00	-24.76	Peak	HORIZONTAL

- Note: 1. Result Level = Read Level + Antenna Factor + Cable loss - PRM Factor
 2. If Peak Result comply with AV limit, AV Result is deemed to comply with AV limit
 3. Test setup: RBW: 1MHz, VBW: 3MHz, Sweep time:auto

Radiated Emission Test Result

Test Site : DDT 3m Chamber E:\2013 Report data\13QE0070\RE 1G-18G.EM6
Test Date : 2013-08-08 **Tested By** : Leo Liu
EUT : GuruPlug **Model Number** : 003-GP0XXXXXX
Power Supply : AC 120V/60Hz **Test Mode** : 11G CH11
Condition : Temp:24.5'C,Humi:55%,
Antenna/Distance : 2013 HF907/3m/HORIZONTAL
 Press:100.1kPa
Memo :

Data: 65

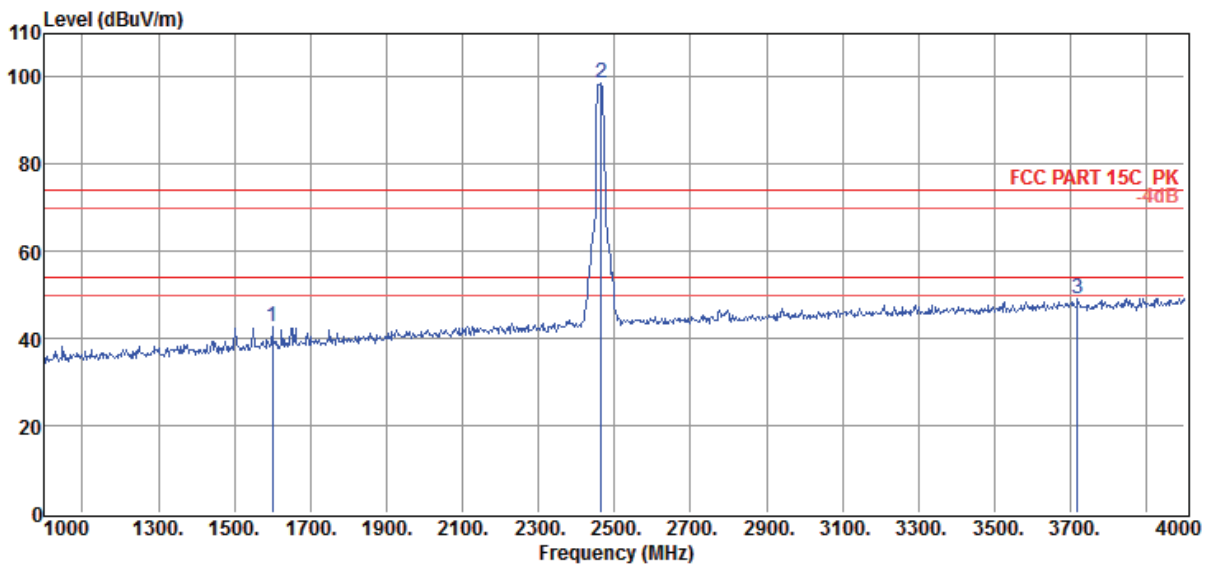

Item (Mark)	Freq (MHz)	Read Level (dBμV)	Antenna Factor (dB/m)	PRM Factor (dB)	Cable Loss (dB)	Result Level (dBμV/m)	Limit Line (dBμV/m)	Over Limit (dB)	Detector	Polarization
1	1600.00	52.65	26.80	43.60	6.85	42.70	74.00	-31.30	Peak	HORIZONTAL
2	2464.00	103.77	30.20	43.88	8.45	98.54	/	/	Peak	HORIZONTAL
3	3718.00	49.66	32.91	44.26	10.66	48.97	74.00	-25.03	Peak	HORIZONTAL

- Note: 1. Result Level = Read Level + Antenna Factor + Cable loss - PRM Factor
 2. If Peak Result comply with AV limit, AV Result is deemed to comply with AV limit
 3. Test setup: RBW: 1MHz, VBW: 3MHz, Sweep time:auto

Radiated Emission Test Result

Test Site	: DDT 3m Chamber	E:\2013 Report data\13QE0070\RE 1G-18G.EM6
Test Date	: 2013-08-08	Tested By : Leo Liu
EUT	: GuruPlug	Model Number : 003-GP0XXXXXX
Power Supply	: AC 120V/60Hz	Test Mode : 11G CH11
Condition	: Temp:24.5'C,Humi:55%, Press:100.1kPa	Antenna/Distance : 2013 HF907/3m/VERTICAL
Memo	:	

Data: 66

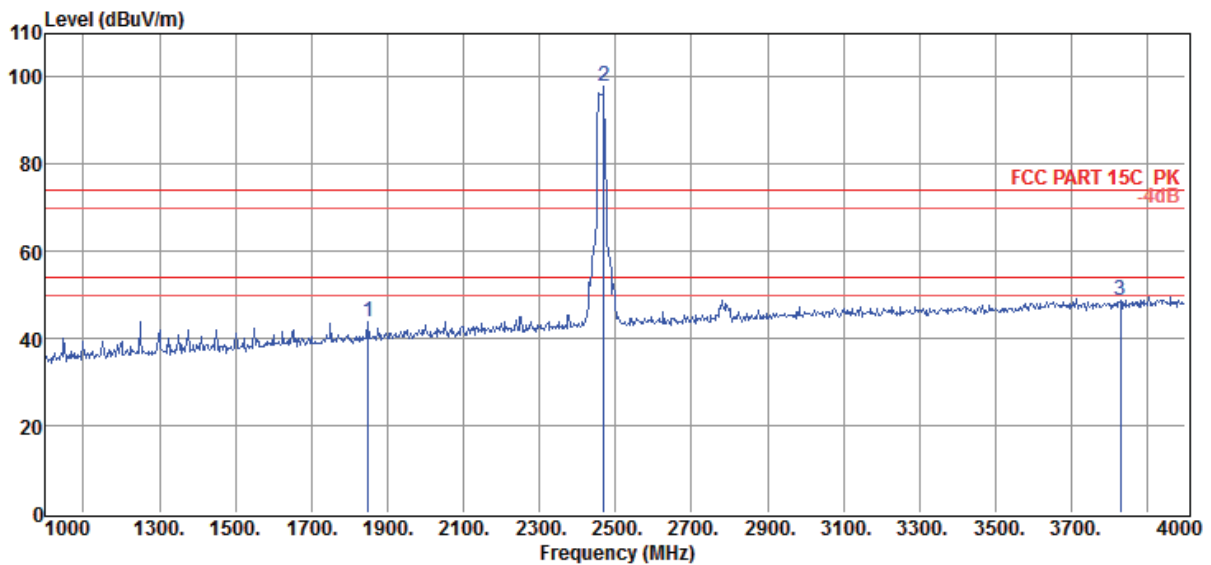

Item (Mark)	Freq (MHz)	Read Level (dBμV)	Antenna Factor (dB/m)	PRM Factor dB	Cable Loss dB	Result Level (dBμV/m)	Limit Line (dBμV/m)	Over Limit (dB)	Detector	Polarization
1	1849.00	52.10	28.05	43.60	7.35	43.90	74.00	-30.10	Peak	VERTICAL
2	2470.00	103.03	30.20	43.88	8.45	97.80	/	/	Peak	VERTICAL
3	3829.00	49.28	33.06	44.23	10.81	48.92	74.00	-25.08	Peak	VERTICAL

- Note: 1. Result Level = Read Level + Antenna Factor + Cable loss - PRM Factor
 2. If Peak Result comply with AV limit, AV Result is deemed to comply with AV limit
 3. Test setup: RBW: 1MHz, VBW: 3MHz, Sweep time:auto

Radiated Emission Test Result

Test Site : DDT 3m Chamber E:\2013 Report data\13QE0070\RE 1G-18G.EM6
Test Date : 2013-08-08 **Tested By** : Leo Liu
EUT : GuruPlug **Model Number** : 003-GP0XXXXXX
Power Supply : AC 120V/60Hz **Test Mode** : 11N HT20 CH1
Condition : Temp:24.5'C,Humi:55%,
Antenna/Distance : 2013 HF907/3m/HORIZONTAL
 Press:100.1kPa
Memo :

Data: 69

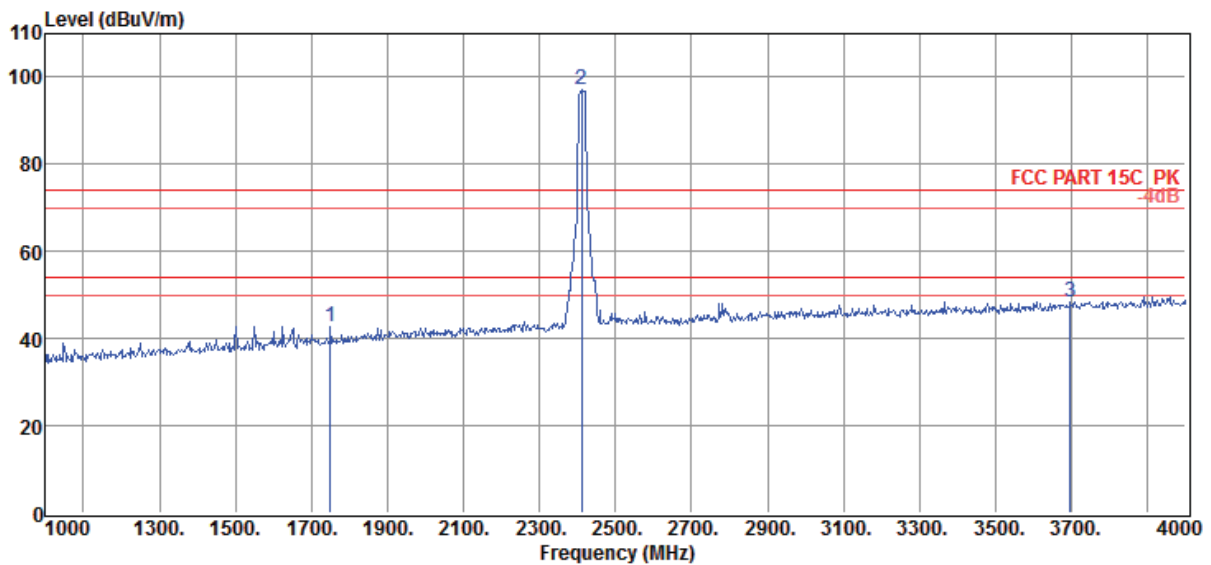

Item (Mark)	Freq (MHz)	Read Level (dBμV)	Antenna Factor (dB/m)	PRM Factor dB	Cable Loss dB	Result Level (dBμV/m)	Limit Line (dBμV/m)	Over Limit (dB)	Detector	Polarization
1	1750.00	51.49	27.55	43.60	7.14	42.58	74.00	-31.42	Peak	HORIZONTAL
2	2410.00	102.65	30.04	43.85	8.35	97.19	/	/	Peak	HORIZONTAL
3	3697.00	49.29	32.89	44.26	10.59	48.51	74.00	-25.49	Peak	HORIZONTAL

- Note: 1. Result Level = Read Level + Antenna Factor + Cable loss - PRM Factor
 2. If Peak Result comply with AV limit, AV Result is deemed to comply with AV limit
 3. Test setup: RBW: 1MHz, VBW: 3MHz, Sweep time:auto

Radiated Emission Test Result

Test Site	: DDT 3m Chamber	E:\2013 Report data\13QE0070\RE 1G-18G.EM6
Test Date	: 2013-08-08	Tested By : Leo Liu
EUT	: GuruPlug	Model Number : 003-GP0XXXXXX
Power Supply	: AC 120V/60Hz	Test Mode : 11N HT20 CH1
Condition	: Temp:24.5'C,Humi:55%, Press:100.1kPa	Antenna/Distance : 2013 HF907/3m/VERTICAL
Memo	:	

Data: 70

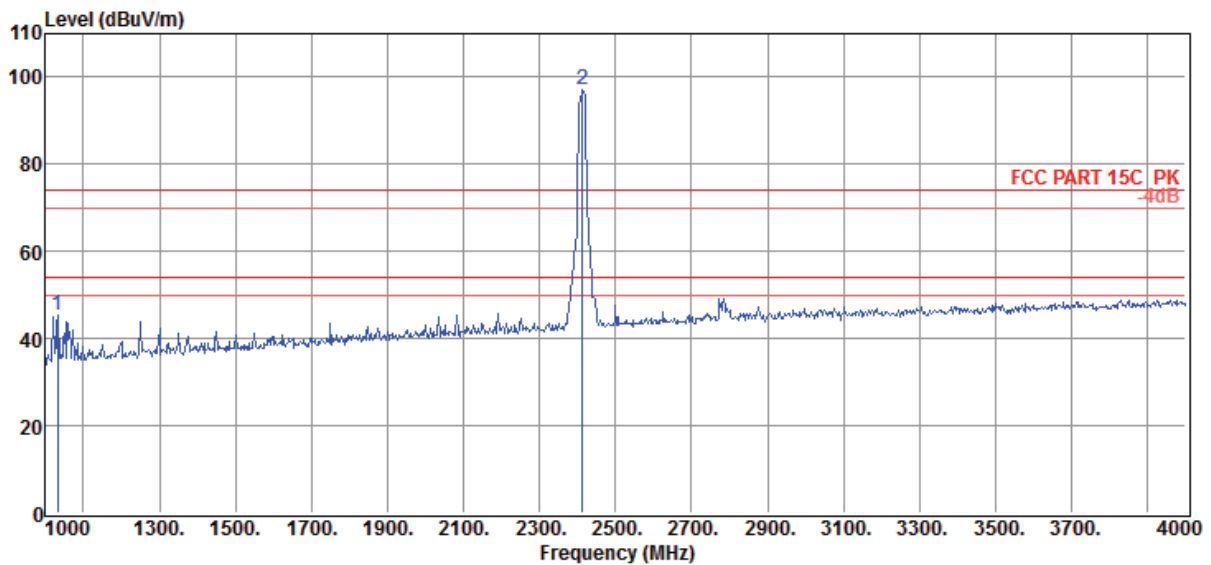

Item (Mark)	Freq (MHz)	Read Level (dBμV)	Antenna Factor (dB/m)	PRM Factor dB	Cable Loss dB	Result Level (dBμV/m)	Limit Line (dBμV/m)	Over Limit (dB)	Detector	Polarization
1	1033.00	58.47	24.72	43.41	5.51	45.29	74.00	-28.71	Peak	VERTICAL
2	2413.00	102.54	30.04	43.85	8.35	97.08	/	/	Peak	VERTICAL

- Note: 1. Result Level = Read Level + Antenna Factor + Cable loss - PRM Factor
 2. If Peak Result comply with AV limit, AV Result is deemed to comply with AV limit
 3. Test setup: RBW: 1MHz, VBW: 3MHz, Sweep time:auto

Radiated Emission Test Result

Test Site : DDT 3m Chamber E:\2013 Report data\13QE0070\RE 1G-18G.EM6
Test Date : 2013-08-08 **Tested By** : Leo Liu
EUT : GuruPlug **Model Number** : 003-GP0XXXXXX
Power Supply : AC 120V/60Hz **Test Mode** : 11N HT20 CH6
Condition : Temp:24.5'C,Humi:55%,
 Press:100.1kPa **Antenna/Distance** : 2013 HF907/3m/HORIZONTAL
Memo :

Data: 73

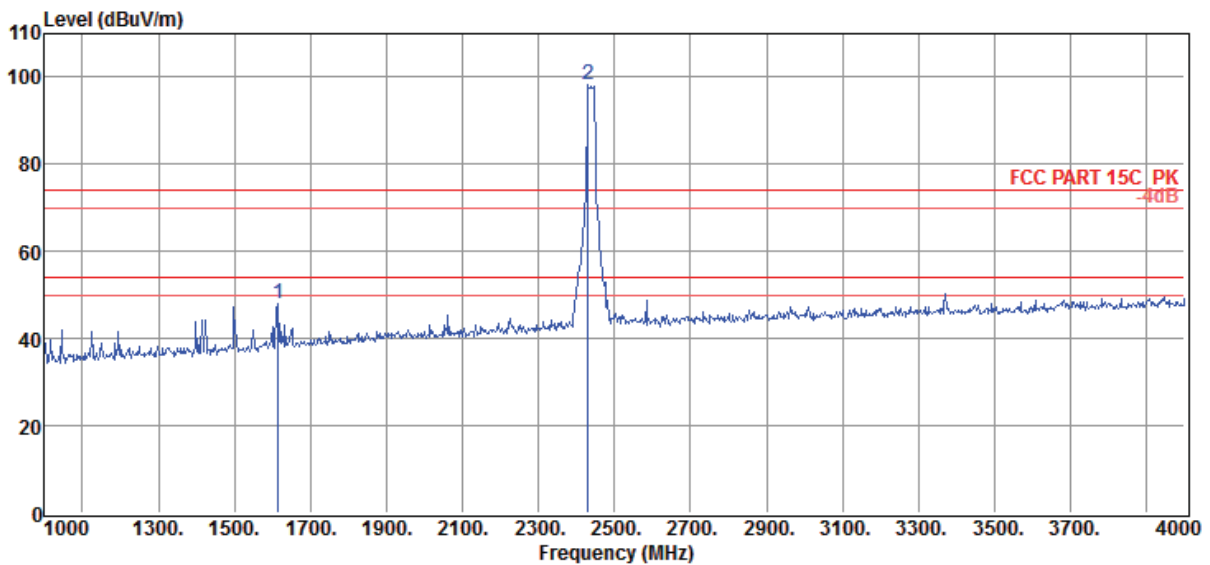

Item (Mark)	Freq (MHz)	Read Level (dBμV)	Antenna Factor (dB/m)	PRM Factor (dB)	Cable Loss (dB)	Result Level (dBμV/m)	Limit Line (dBμV/m)	Over Limit (dB)	Detector	Polarization
1	1615.00	57.92	26.88	43.60	6.85	48.05	74.00	-25.95	Peak	HORIZONTAL
2	2431.00	103.62	30.09	43.86	8.40	98.25	/	/	Peak	HORIZONTAL

- Note: 1. Result Level = Read Level + Antenna Factor + Cable loss - PRM Factor
 2. If Peak Result comply with AV limit, AV Result is deemed to comply with AV limit
 3. Test setup: RBW: 1MHz, VBW: 3MHz, Sweep time:auto

Radiated Emission Test Result

Test Site : DDT 3m Chamber E:\2013 Report data\13QE0070\RE 1G-18G.EM6
Test Date : 2013-08-08 **Tested By** : Leo Liu
EUT : GuruPlug **Model Number** : 003-GP0XXXXXX
Power Supply : AC 120V/60Hz **Test Mode** : 11N HT20 CH6
Condition : Temp:24.5'C,Humi:55%,
Antenna/Distance : 2013 HF907/3m/VERTICAL
Press:100.1kPa
Memo :

Data: 74

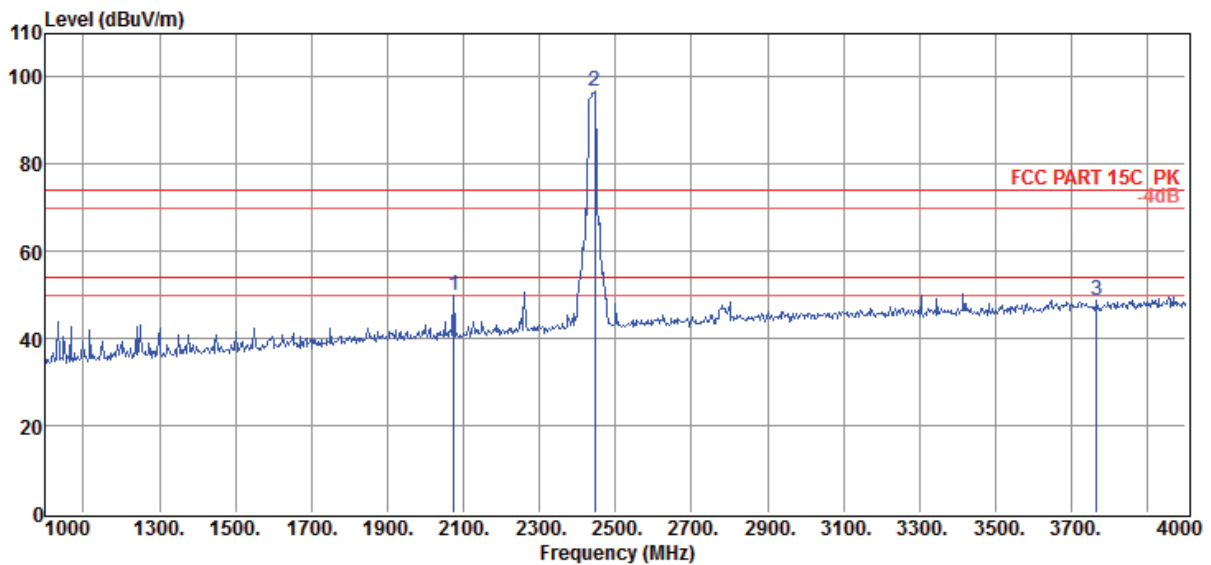

Item (Mark)	Freq (MHz)	Read Level (dBμV)	Antenna Factor (dB/m)	PRM Factor (dB)	Cable Loss (dB)	Result Level (dBμV/m)	Limit Line (dBμV/m)	Over Limit (dB)	Detector	Polarization
1	2074.00	56.85	29.01	43.64	7.75	49.97	74.00	-24.03	Peak	VERTICAL
2	2446.00	102.13	30.14	43.87	8.40	96.80	/	/	Peak	VERTICAL
3	3766.00	49.25	32.99	44.25	10.74	48.73	74.00	-25.27	Peak	VERTICAL

- Note: 1. Result Level = Read Level + Antenna Factor + Cable loss - PRM Factor
 2. If Peak Result comply with AV limit, AV Result is deemed to comply with AV limit
 3. Test setup: RBW: 1MHz, VBW: 3MHz, Sweep time:auto

Radiated Emission Test Result

Test Site	: DDT 3m Chamber	E:\2013 Report data\13QE0070\RE 1G-18G.EM6
Test Date	: 2013-08-08	Tested By : Leo Liu
EUT	: GuruPlug	Model Number : 003-GP0XXXXXX
Power Supply	: AC 120V/60Hz	Test Mode : 11N HT20 CH11
Condition	: Temp:24.5'C,Humi:55%, Press:100.1kPa	Antenna/Distance : 2013 HF907/3m/VERTICAL
Memo	:	

Data: 75

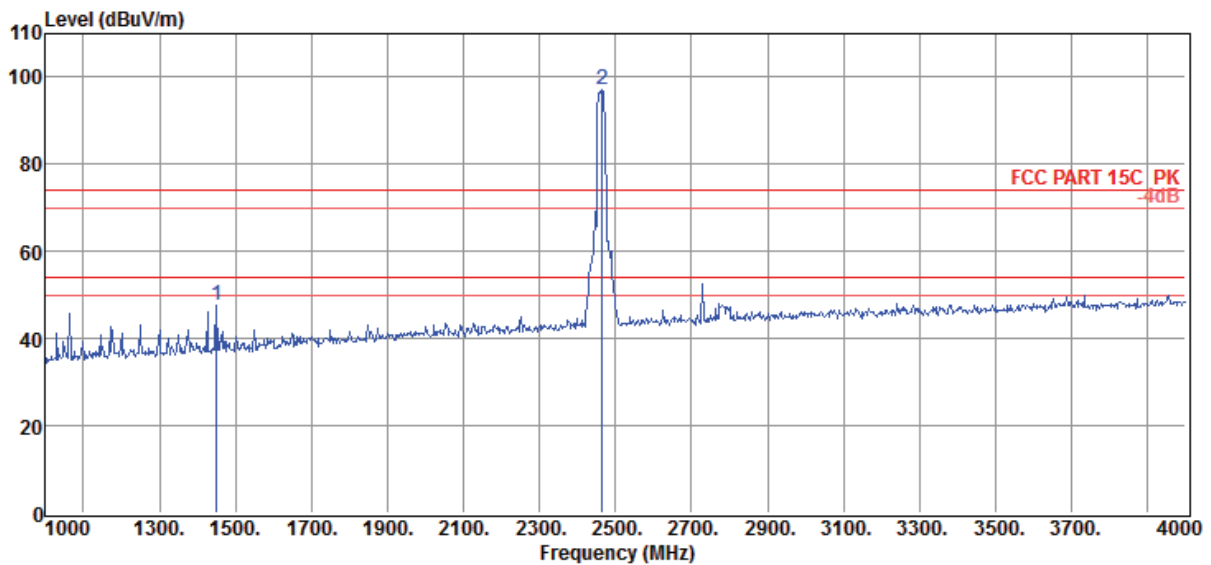

Item (Mark)	Freq (MHz)	Read Level (dBμV)	Antenna Factor (dB/m)	PRM Factor dB	Cable Loss dB	Result Level (dBμV/m)	Limit Line (dBμV/m)	Over Limit (dB)	Detector	Polarization
1	1450.00	58.66	26.12	43.59	6.53	47.72	74.00	-26.28	Peak	VERTICAL
2	2464.00	102.38	30.20	43.88	8.45	97.15	/	/	Peak	VERTICAL

- Note: 1. Result Level = Read Level + Antenna Factor + Cable loss - PRM Factor
 2. If Peak Result comply with AV limit, AV Result is deemed to comply with AV limit
 3. Test setup: RBW: 1MHz, VBW: 3MHz, Sweep time:auto

Radiated Emission Test Result

Test Site : DDT 3m Chamber E:\2013 Report data\13QE0070\RE 1G-18G.EM6
Test Date : 2013-08-08 **Tested By** : Leo Liu
EUT : GuruPlug **Model Number** : 003-GP0XXXXXX
Power Supply : AC 120V/60Hz **Test Mode** : 11N HT20 CH11
Condition : Temp:24.5'C,Humi:55%,
 Press:100.1kPa **Antenna/Distance** : 2013 HF907/3m/HORIZONTAL
Memo :

Data: 76

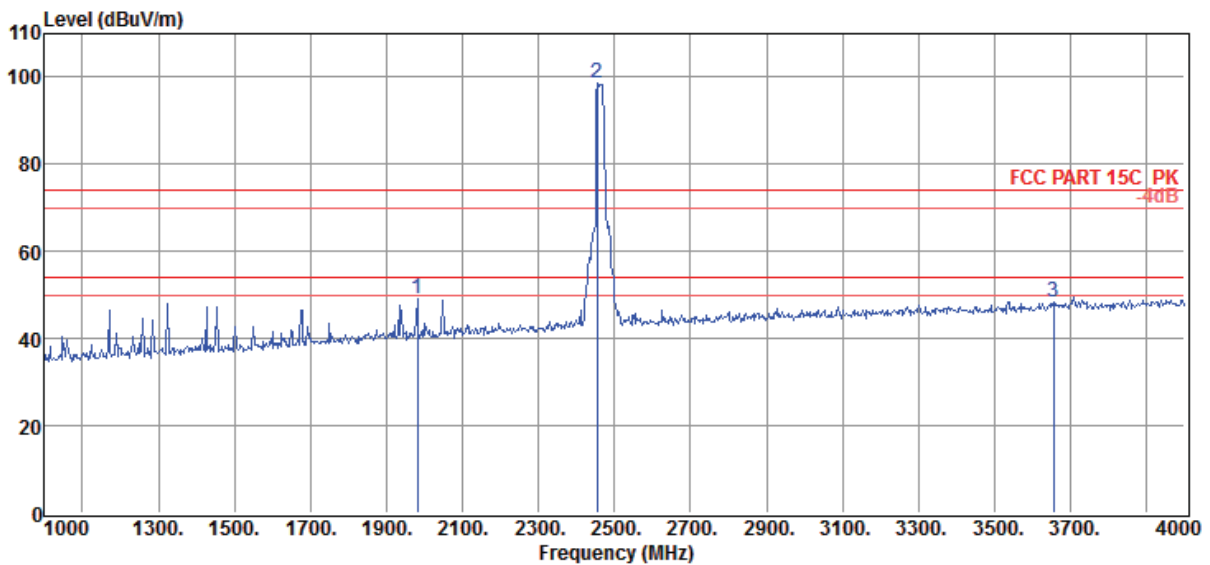

Item (Mark)	Freq (MHz)	Read Level (dBμV)	Antenna Factor (dB/m)	PRM Factor (dB)	Cable Loss (dB)	Result Level (dBμV/m)	Limit Line (dBμV/m)	Over Limit (dB)	Detector	Polarization
1	1981.00	56.43	28.72	43.60	7.56	49.11	74.00	-24.89	Peak	HORIZONTAL
2	2455.00	103.98	30.20	43.87	8.45	98.76	/	/	Peak	HORIZONTAL
3	3655.00	49.30	32.82	44.27	10.52	48.37	74.00	-25.63	Peak	HORIZONTAL

- Note: 1. Result Level = Read Level + Antenna Factor + Cable loss - PRM Factor
 2. If Peak Result comply with AV limit, AV Result is deemed to comply with AV limit
 3. Test setup: RBW: 1MHz, VBW: 3MHz, Sweep time:auto

Radiated Emission Test Result

Test Site : DDT 3m Chamber E:\2013 Report data\13QE0070\RE 1G-18G.EM6
Test Date : 2013-08-08 **Tested By** : Leo Liu
EUT : GuruPlug **Model Number** : 003-GP0XXXXXX
Power Supply : AC 120V/60Hz **Test Mode** : 11N HT40 CH3
Condition : Temp:24.5'C,Humi:55%,
 Press:100.1kPa **Antenna/Distance** : 2013 HF907/3m/VERTICAL
Memo :

Data: 79

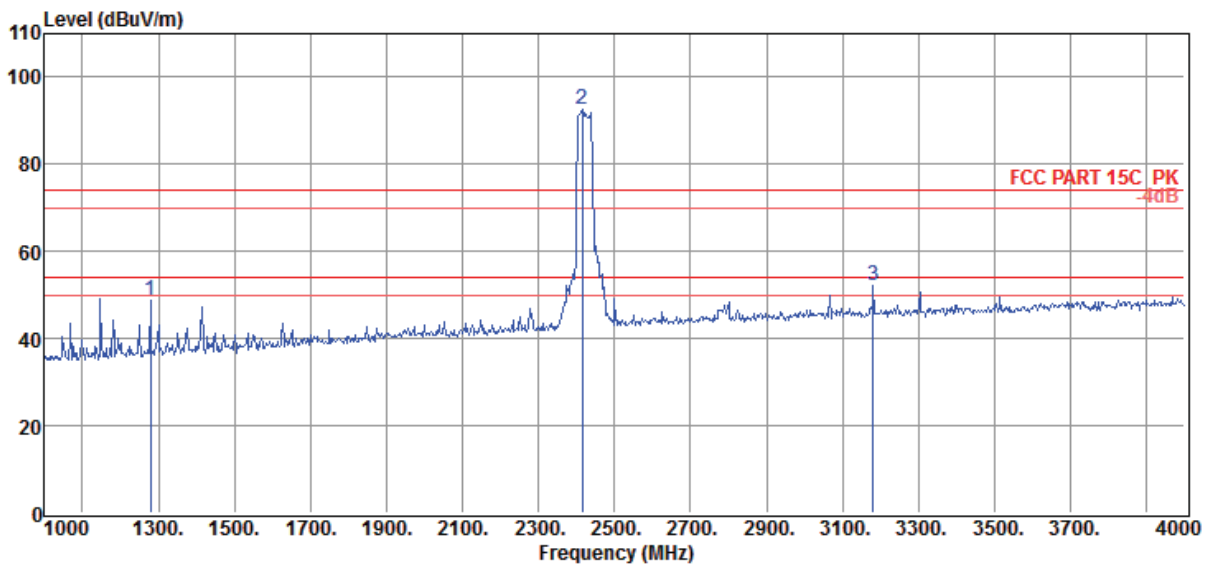

Item (Mark)	Freq (MHz)	Read Level (dBμV)	Antenna Factor (dB/m)	PRM Factor (dB)	Cable Loss (dB)	Result Level (dBμV/m)	Limit Line (dBμV/m)	Over Limit (dB)	Detector	Polarization
1	1279.00	60.53	25.54	43.51	6.13	48.69	74.00	-25.31	Peak	VERTICAL
2	2416.00	98.07	30.04	43.85	8.35	92.61	/	/	Peak	VERTICAL
3	3181.00	54.20	32.21	44.17	9.75	51.99	74.00	-22.01	Peak	VERTICAL

- Note: 1. Result Level = Read Level + Antenna Factor + Cable loss - PRM Factor
 2. If Peak Result comply with AV limit, AV Result is deemed to comply with AV limit
 3. Test setup: RBW: 1MHz, VBW: 3MHz, Sweep time:auto

Radiated Emission Test Result

Test Site : DDT 3m Chamber E:\2013 Report data\13QE0070\RE 1G-18G.EM6
Test Date : 2013-08-08 **Tested By** : Leo Liu
EUT : GuruPlug **Model Number** : 003-GP0XXXXXX
Power Supply : AC 120V/60Hz **Test Mode** : 11N HT40 CH3
Condition : Temp:24.5'C,Humi:55%,
 Press:100.1kPa **Antenna/Distance** : 2013 HF907/3m/HORIZONTAL
Memo :

Data: 80

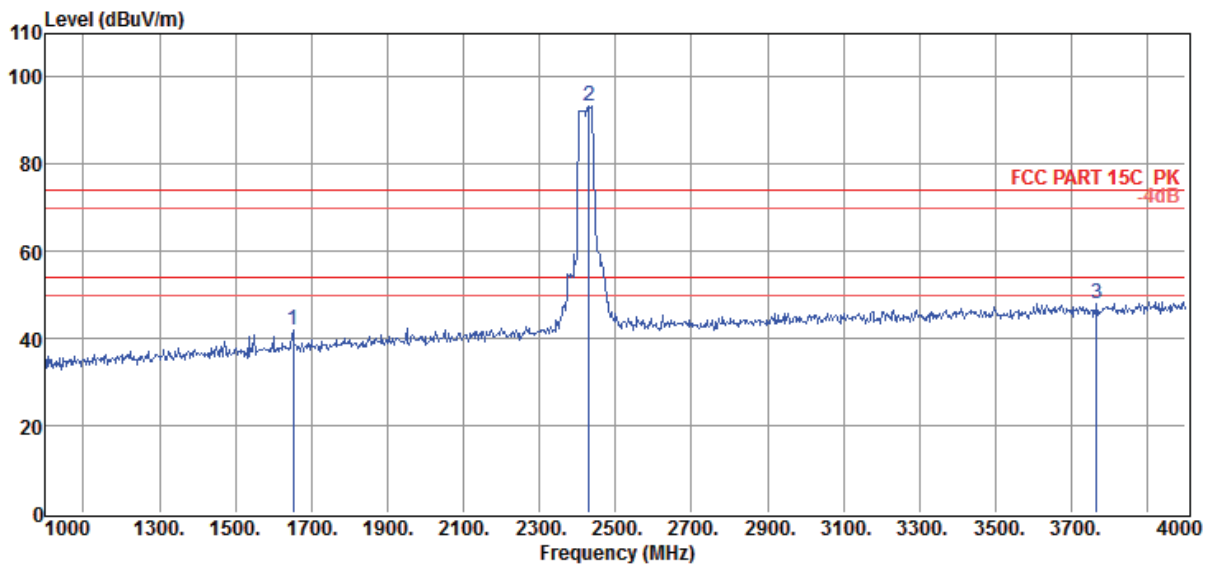

Item (Mark)	Freq (MHz)	Read Level (dBμV)	Antenna Factor (dB/m)	PRM Factor (dB)	Cable Loss (dB)	Result Level (dBμV/m)	Limit Line (dBμV/m)	Over Limit (dB)	Detector	Polarization
1	1651.00	51.43	27.05	43.60	6.93	41.81	74.00	-32.19	Peak	HORIZONTAL
2	2431.00	98.82	30.09	43.86	8.40	93.45	/	/	Peak	HORIZONTAL
3	3766.00	48.56	32.99	44.25	10.74	48.04	74.00	-25.96	Peak	HORIZONTAL

- Note: 1. Result Level = Read Level + Antenna Factor + Cable loss - PRM Factor
 2. If Peak Result comply with AV limit, AV Result is deemed to comply with AV limit
 3. Test setup: RBW: 1MHz, VBW: 3MHz, Sweep time:auto

Radiated Emission Test Result

Test Site : DDT 3m Chamber E:\2013 Report data\13QE0070\RE 1G-18G.EM6
Test Date : 2013-08-08 **Tested By** : Leo Liu
EUT : GuruPlug **Model Number** : 003-GP0XXXXXX
Power Supply : AC 120V/60Hz **Test Mode** : 11N HT40 CH6
Condition : Temp:24.5'C,Humi:55%,
 Press:100.1kPa **Antenna/Distance** : 2013 HF907/3m/VERTICAL
Memo :

Data: 83

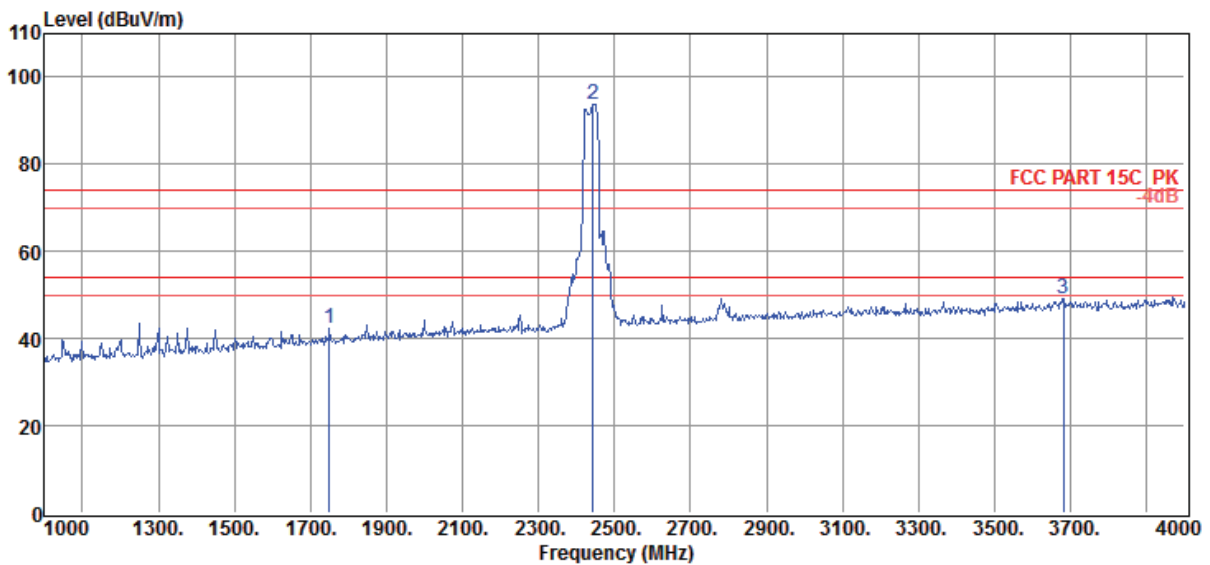

Item (Mark)	Freq (MHz)	Read Level (dBμV)	Antenna Factor (dB/m)	PRM Factor dB	Cable Loss dB	Result Level (dBμV/m)	Limit Line (dBμV/m)	Over Limit (dB)	Detector	Polarization
1	1750.00	51.23	27.55	43.60	7.14	42.32	74.00	-31.68	Peak	VERTICAL
2	2443.00	99.04	30.14	43.87	8.40	93.71	/	/	Peak	VERTICAL
3	3682.00	49.88	32.87	44.26	10.59	49.08	74.00	-24.92	Peak	VERTICAL

- Note: 1. Result Level = Read Level + Antenna Factor + Cable loss - PRM Factor
 2. If Peak Result comply with AV limit, AV Result is deemed to comply with AV limit
 3. Test setup: RBW: 1MHz, VBW: 3MHz, Sweep time:auto

Radiated Emission Test Result

Test Site : DDT 3m Chamber E:\2013 Report data\13QE0070\RE 1G-18G.EM6
Test Date : 2013-08-08 **Tested By** : Leo Liu
EUT : GuruPlug **Model Number** : 003-GP0XXXXXX
Power Supply : AC 120V/60Hz **Test Mode** : 11N HT40 CH6
Condition : Temp:24.5'C,Humi:55%,
Antenna/Distance : 2013 HF907/3m/HORIZONTAL
Press:100.1kPa
Memo :

Data: 84

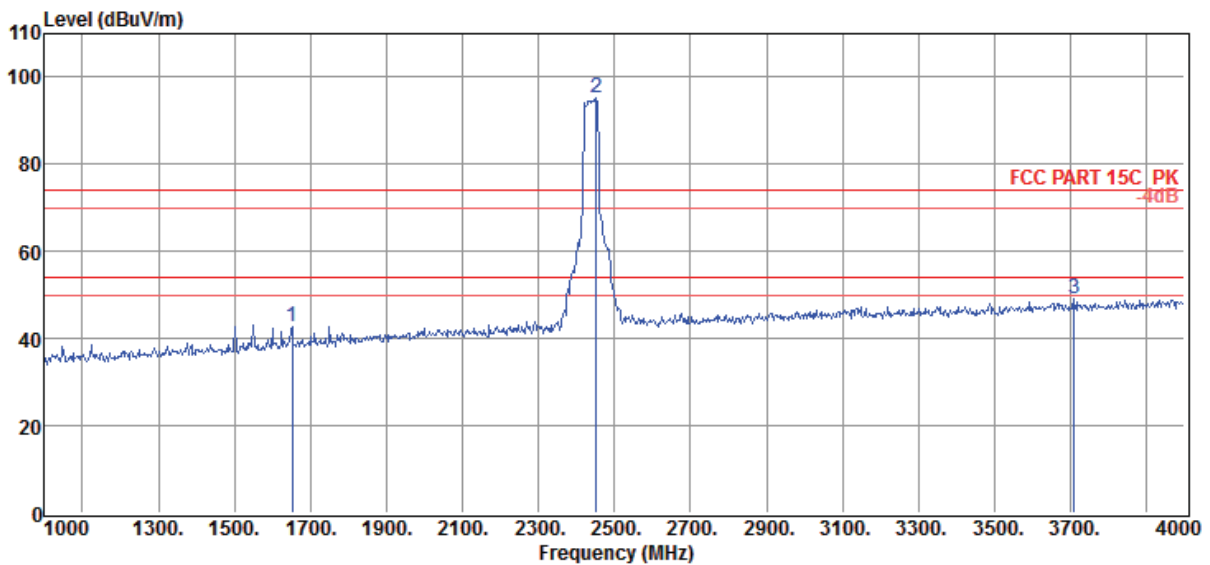

Item (Mark)	Freq (MHz)	Read Level (dBμV)	Antenna Factor (dB/m)	PRM Factor (dB)	Cable Loss (dB)	Result Level (dBμV/m)	Limit Line (dBμV/m)	Over Limit (dB)	Detector	Polarization
1	1651.00	52.49	27.05	43.60	6.93	42.87	74.00	-31.13	Peak	HORIZONTAL
2	2452.00	100.36	30.14	43.87	8.45	95.08	/	/	Peak	HORIZONTAL
3	3709.00	49.67	32.89	44.26	10.66	48.96	74.00	-25.04	Peak	HORIZONTAL

- Note: 1. Result Level = Read Level + Antenna Factor + Cable loss - PRM Factor
 2. If Peak Result comply with AV limit, AV Result is deemed to comply with AV limit
 3. Test setup: RBW: 1MHz, VBW: 3MHz, Sweep time:auto

Radiated Emission Test Result

Test Site	: DDT 3m Chamber	E:\2013 Report data\13QE0070\RE 1G-18G.EM6
Test Date	: 2013-08-08	Tested By : Leo Liu
EUT	: GuruPlug	Model Number : 003-GP0XXXXXX
Power Supply	: AC 120V/60Hz	Test Mode : 11N HT40 CH9
Condition	: Temp:24.5'C,Humi:55%, Press:100.1kPa	Antenna/Distance : 2013 HF907/3m/HORIZONTAL
Memo	:	

Data: 85

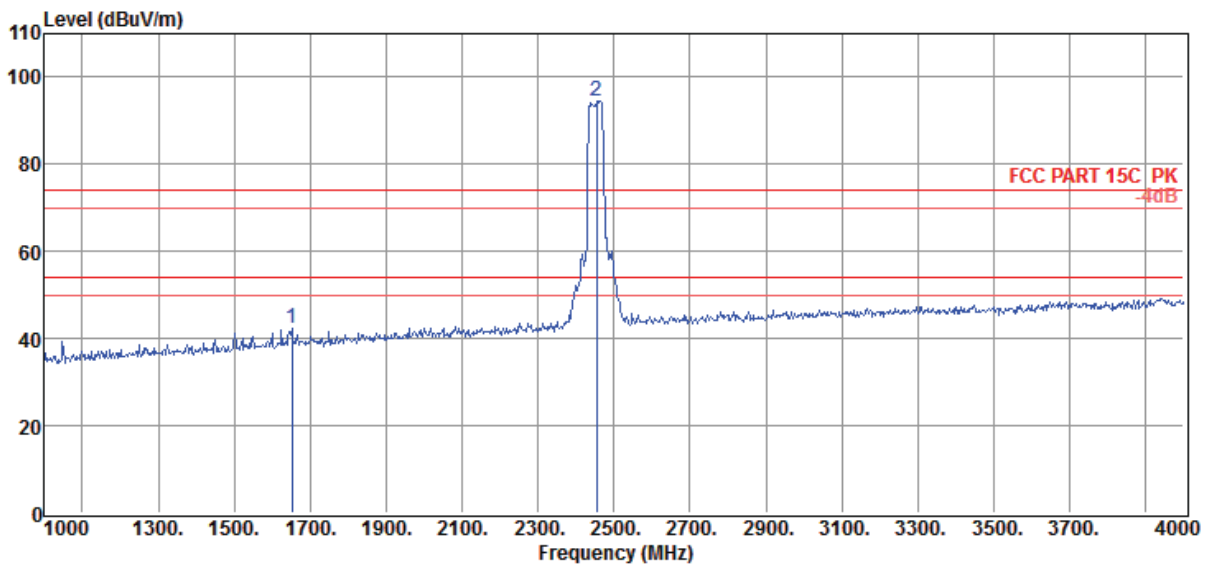

Item (Mark)	Freq (MHz)	Read Level (dBμV)	Antenna Factor (dB/m)	PRM Factor dB	Cable Loss dB	Result Level (dBμV/m)	Limit Line (dBμV/m)	Over Limit (dB)	Detector	Polarization
1	1651.00	51.80	27.05	43.60	6.93	42.18	74.00	-31.82	Peak	HORIZONTAL
2	2455.00	99.85	30.20	43.87	8.45	94.63	/	/	Peak	HORIZONTAL

- Note: 1. Result Level = Read Level + Antenna Factor + Cable loss - PRM Factor
 2. If Peak Result comply with AV limit, AV Result is deemed to comply with AV limit
 3. Test setup: RBW: 1MHz, VBW: 3MHz, Sweep time:auto

Radiated Emission Test Result

Test Site	: DDT 3m Chamber	E:\2013 Report data\13QE0070\RE 1G-18G.EM6
Test Date	: 2013-08-08	Tested By : Leo Liu
EUT	: GuruPlug	Model Number : 003-GP0XXXXXX
Power Supply	: AC 120V/60Hz	Test Mode : 11N HT40 CH9
Condition	: Temp:24.5'C,Humi:55%, Press:100.1kPa	Antenna/Distance : 2013 HF907/3m/VERTICAL
Memo	:	

Data: 86

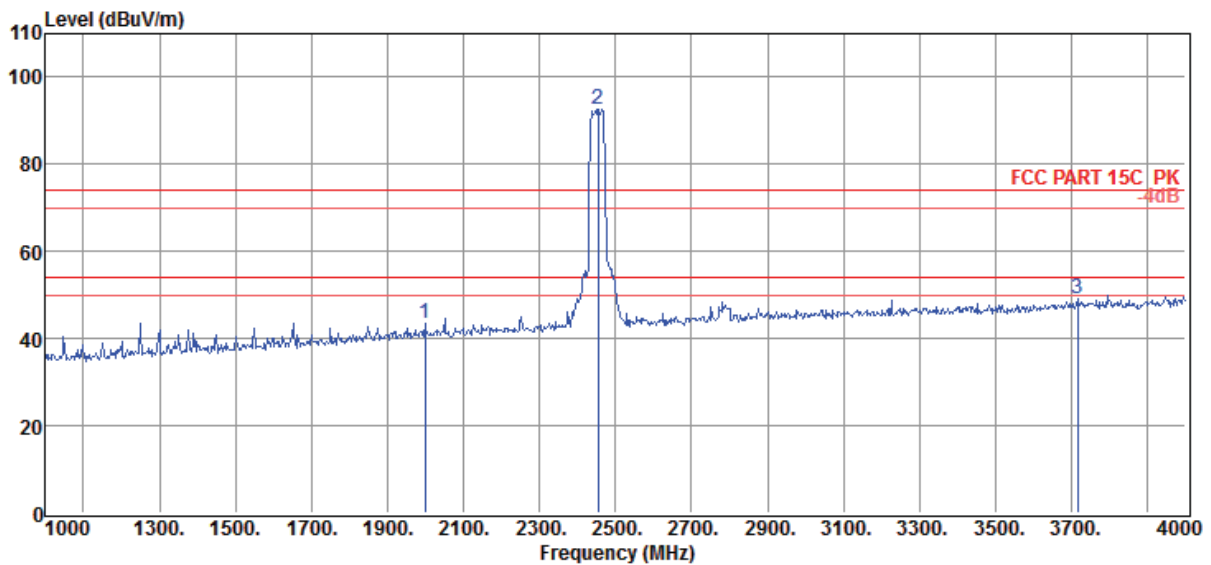

Item (Mark)	Freq (MHz)	Read Level (dBμV)	Antenna Factor (dB/m)	PRM Factor dB	Cable Loss dB	Result Level (dBμV/m)	Limit Line (dBμV/m)	Over Limit (dB)	Detector	Polarization
1	1999.00	50.80	28.80	43.60	7.60	43.60	74.00	-30.40	Peak	VERTICAL
2	2455.00	98.01	30.20	43.87	8.45	92.79	/	/	Peak	VERTICAL
3	3715.00	49.90	32.91	44.26	10.66	49.21	74.00	-24.79	Peak	VERTICAL

- Note: 1. Result Level = Read Level + Antenna Factor + Cable loss - PRM Factor
 2. If Peak Result comply with AV limit, AV Result is deemed to comply with AV limit
 3. Test setup: RBW: 1MHz, VBW: 3MHz, Sweep time:auto

8. Band Edge Compliance

8.1. Test equipment

Item	Equipment	Manufacturer	Model No.	Serial No.	Last Cal.	Cal. Interval
1	EMI Test Receiver	R&S	ESU8	100316	2012/11/26	1 Year
2	Spectrum analyzer	R&S	FSU	1166.1660.26	2012/11/26	1 Year
3	Trilog Broadband Antenna	Schwarzbeck	VULB9163	9163-462	2012/11/26	1 Year
4	Double Ridged Horn Antenna	R&S	HF907	100276	2012/11/26	1 Year
5	Pre-Amplifier	R&S	SCU-01	10049	2012/11/26	1 Year
6	Pre-amplifier	A.H.	PAM0-0118	360	2012/11/26	1 Year
7	RF Cable	R&S	R01	10403	2012/11/26	1 Year
8	RF Cable	R&S	R02	10512	2012/11/26	1 Year

8.2. Block diagram of test setup

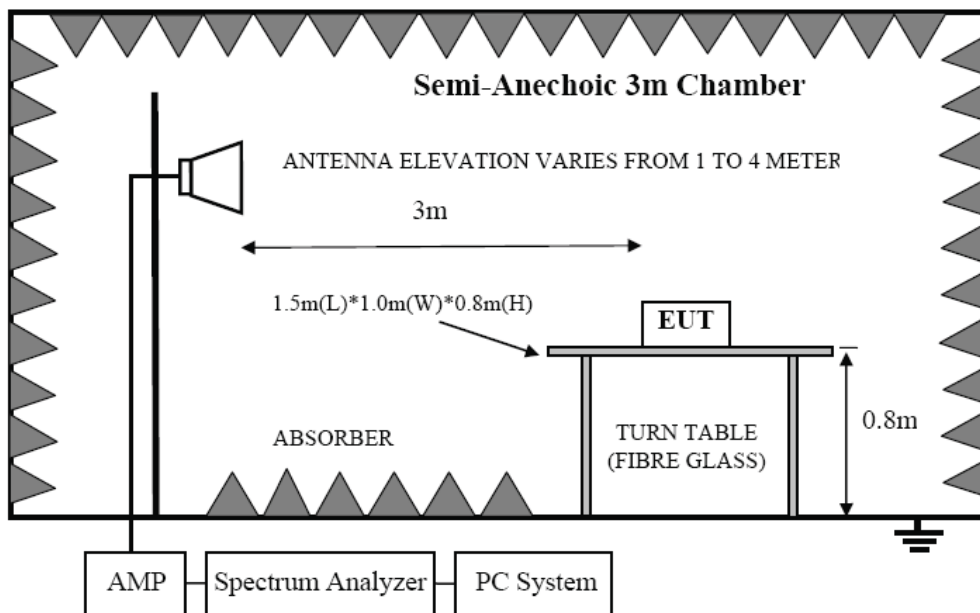

8.3. Limit

All the lower and upper band-edges emissions appearing within 2310MHz to 2390MHz and 2483.5MHz to 2500MHz restricted frequency bands shall not exceed the limits shown in 15.209, all the other emissions outside operation frequency band 2400MHz to 2483.5MHz and 5725MHz to 5850MHz shall be at least 20dB below the fundamental emissions, or comply with 15.209 limits.

8.4. Test Procedure

Same with clause 8.4 except change investigated frequency range from 2310MHz to 2415MHz and 2450MHz to 2500MHz.

8.5. Test result

PASS. (See below detailed test result)

Radiated Emission Test Result

Test Site	: DDT 3m Chamber	E:\2013 Report data\13QE0070\RE 1G-18G.EM6
Test Date	: 2013-08-08	Tested By : Leo Liu
EUT	: GuruPlug	Model Number : 003-GP0XXXXXX
Power Supply	: AC 120V/60Hz	Test Mode : 11B CH1
Condition	: Temp:24.5'C,Humi:55%, Press:100.1kPa	Antenna/Distance : 2013 HF907/3m/VERTICAL
Memo	:	

Data: 51

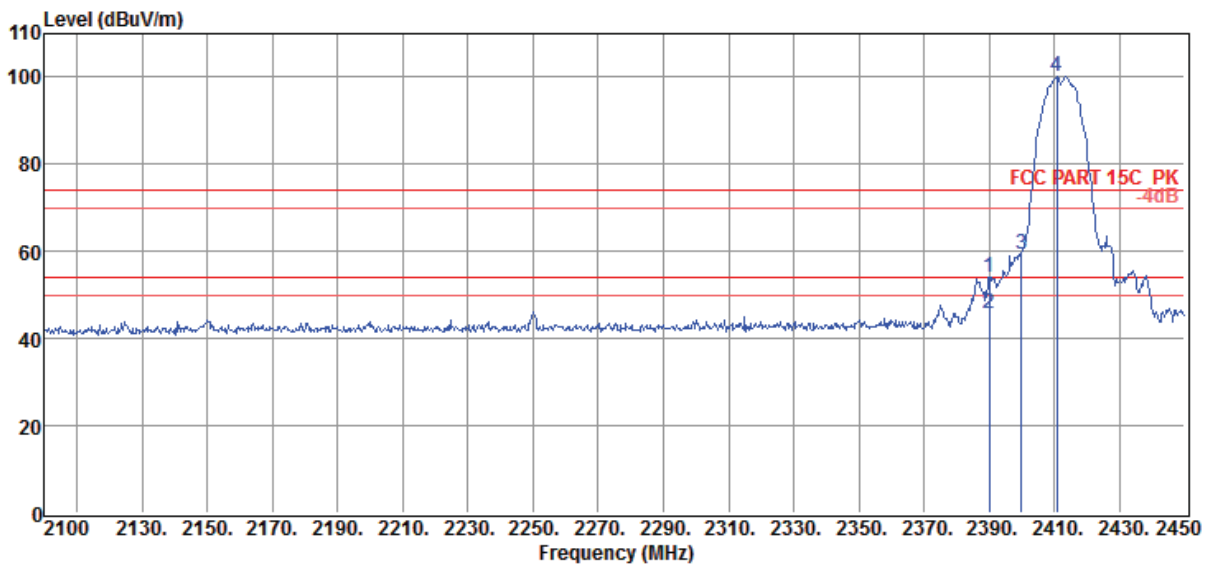

Item (Mark)	Freq (MHz)	Read Level (dBμV)	Antenna Factor (dB/m)	PRM Factor dB	Cable Loss dB	Result Level (dBμV/m)	Limit Line (dBμV/m)	Over Limit (dB)	Detector	Polarization
1	2390.00	59.69	29.99	43.84	8.35	54.19	74.00	-19.81	Peak	VERTICAL
2	2390.00	51.23	29.99	43.84	8.35	45.73	54.00	-8.27	Average	VERTICAL
3	2400.00	64.88	29.99	43.84	8.35	59.38	74.00	-14.62	Peak	VERTICAL
4	2410.80	105.53	30.04	43.85	8.35	100.07	/	/	Peak	VERTICAL

- Note: 1. Result Level = Read Level + Antenna Factor + Cable loss - PRM Factor
 2. If Peak Result comply with AV limit, AV Result is deemed to comply with AV limit
 3. Test setup: RBW: 1MHz, VBW: 3MHz, Sweep time:auto

Radiated Emission Test Result

Test Site : DDT 3m Chamber E:\2013 Report data\13QE0070\RE 1G-18G.EM6
Test Date : 2013-08-08 **Tested By** : Leo Liu
EUT : GuruPlug **Model Number** : 003-GP0XXXXXX
Power Supply : AC 120V/60Hz **Test Mode** : 11B CH1
Condition : Temp:24.5'C,Humi:55%,
 Press:100.1kPa **Antenna/Distance** : 2013 HF907/3m/HORIZONTAL
Memo :

Data: 52

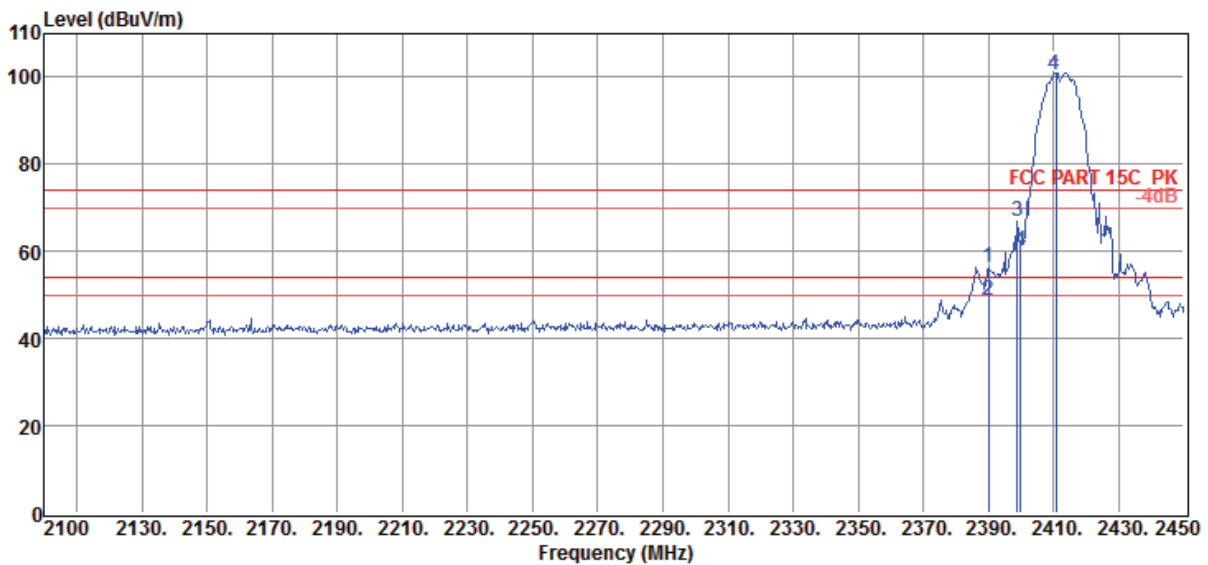

Item (Mark)	Freq (MHz)	Read Level (dBμV)	Antenna Factor (dB/m)	PRM Factor (dB)	Cable Loss (dB)	Result Level (dBμV/m)	Limit Line (dBμV/m)	Over Limit (dB)	Detector	Polarization
1	2390.00	61.65	29.99	43.84	8.35	56.15	74.00	-17.85	Peak	HORIZONTAL
2	2390.00	54.32	29.99	43.84	8.35	48.82	54.00	-5.18	Average	HORIZONTAL
3	2400.00	65.64	29.99	43.84	8.35	60.14	74.00	-13.86	Peak	HORIZONTAL
4	2410.80	106.43	30.04	43.85	8.35	100.97	/	/	Peak	HORIZONTAL

- Note: 1. Result Level = Read Level + Antenna Factor + Cable loss - PRM Factor
 2. If Peak Result comply with AV limit, AV Result is deemed to comply with AV limit
 3. Test setup: RBW: 1MHz, VBW: 3MHz, Sweep time:auto

Radiated Emission Test Result

Test Site	: DDT 3m Chamber	E:\2013 Report data\13QE0070\RE 1G-18G.EM6
Test Date	: 2013-08-08	Tested By : Leo Liu
EUT	: GuruPlug	Model Number : 003-GP0XXXXXX
Power Supply	: AC 120V/60Hz	Test Mode : 11B CH11
Condition	: Temp:24.5'C,Humi:55%, Press:100.1kPa	Antenna/Distance : 2013 HF907/3m/HORIZONTAL
Memo	:	

Data: 57

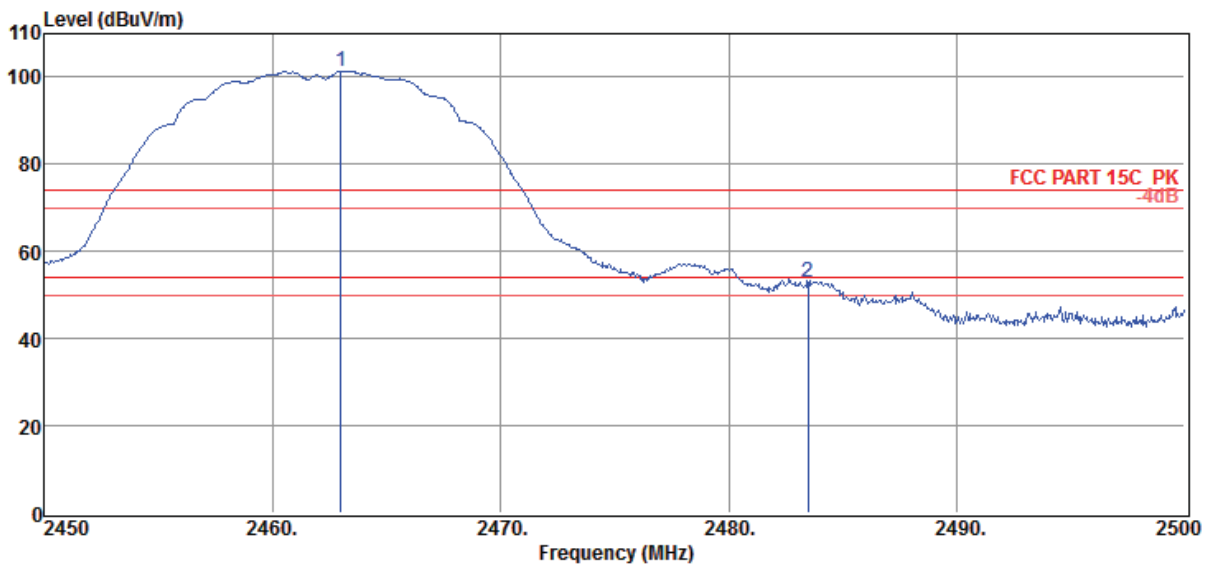

Item (Mark)	Freq (MHz)	Read Level (dBμV)	Antenna Factor (dB/m)	PRM Factor dB	Cable Loss dB	Result Level (dBμV/m)	Limit Line (dBμV/m)	Over Limit (dB)	Detector	Polarization
1	2463.00	106.59	30.20	43.88	8.45	101.36	/	/	Peak	HORIZONTAL
2	2483.50	57.95	30.25	43.89	8.50	52.81	74.00	-21.19	Peak	HORIZONTAL

Note: 1. Result Level = Read Level + Antenna Factor + Cable loss - PRM Factor
 2. If Peak Result comply with AV limit, AV Result is deemed to comply with AV limit
 3. Test setup: RBW: 1MHz, VBW: 3MHz, Sweep time:auto

Radiated Emission Test Result

Test Site	: DDT 3m Chamber	E:\2013 Report data\13QE0070\RE 1G-18G.EM6
Test Date	: 2013-08-08	Tested By : Leo Liu
EUT	: GuruPlug	Model Number : 003-GP0XXXXXX
Power Supply	: AC 120V/60Hz	Test Mode : 11B CH11
Condition	: Temp:24.5'C,Humi:55%, Press:100.1kPa	Antenna/Distance : 2013 HF907/3m/VERTICAL
Memo	:	

Data: 58

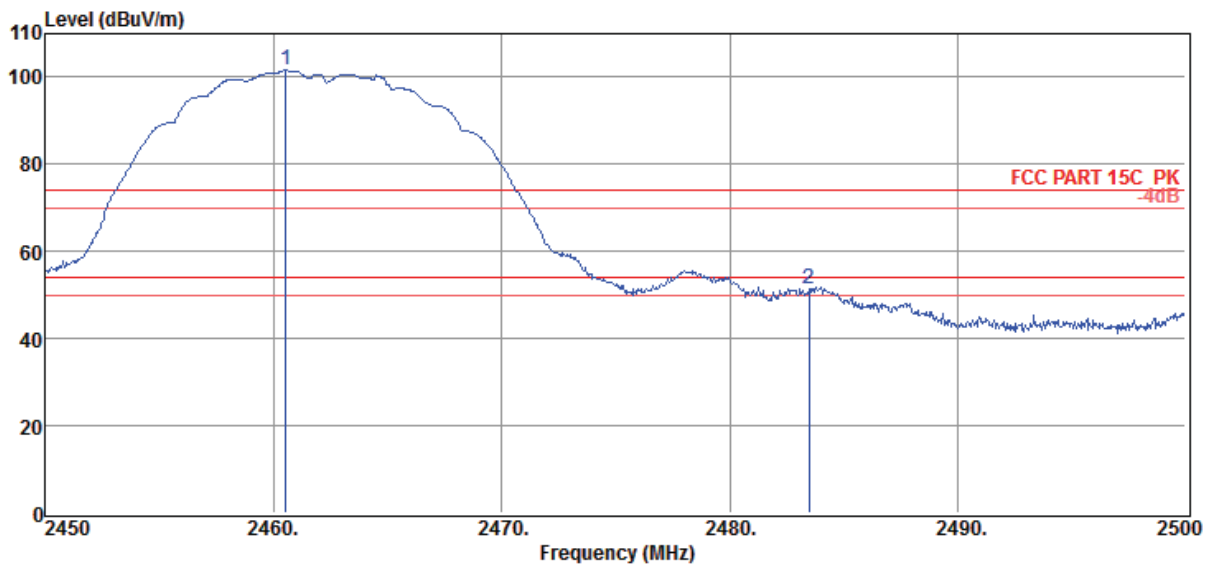

Item (Mark)	Freq (MHz)	Read Level (dBμV)	Antenna Factor (dB/m)	PRM Factor dB	Cable Loss dB	Result Level (dBμV/m)	Limit Line (dBμV/m)	Over Limit (dB)	Detector	Polarization
1	2460.55	106.80	30.20	43.88	8.45	101.57	/	/	Peak	VERTICAL
2	2483.50	56.51	30.25	43.89	8.50	51.37	74.00	-22.63	Peak	VERTICAL

- Note: 1. Result Level = Read Level + Antenna Factor + Cable loss - PRM Factor
 2. If Peak Result comply with AV limit, AV Result is deemed to comply with AV limit
 3. Test setup: RBW: 1MHz, VBW: 3MHz, Sweep time:auto

Radiated Emission Test Result

Test Site : DDT 3m Chamber E:\2013 Report data\13QE0070\RE 1G-18G.EM6
Test Date : 2013-08-08 **Tested By** : Leo Liu
EUT : GuruPlug **Model Number** : 003-GP0XXXXXX
Power Supply : AC 120V/60Hz **Test Mode** : 11G CH1
Condition : Temp:24.5'C,Humi:55%,
Antenna/Distance : 2013 HF907/3m/HORIZONTAL
Press:100.1kPa
Memo :

Data: 61

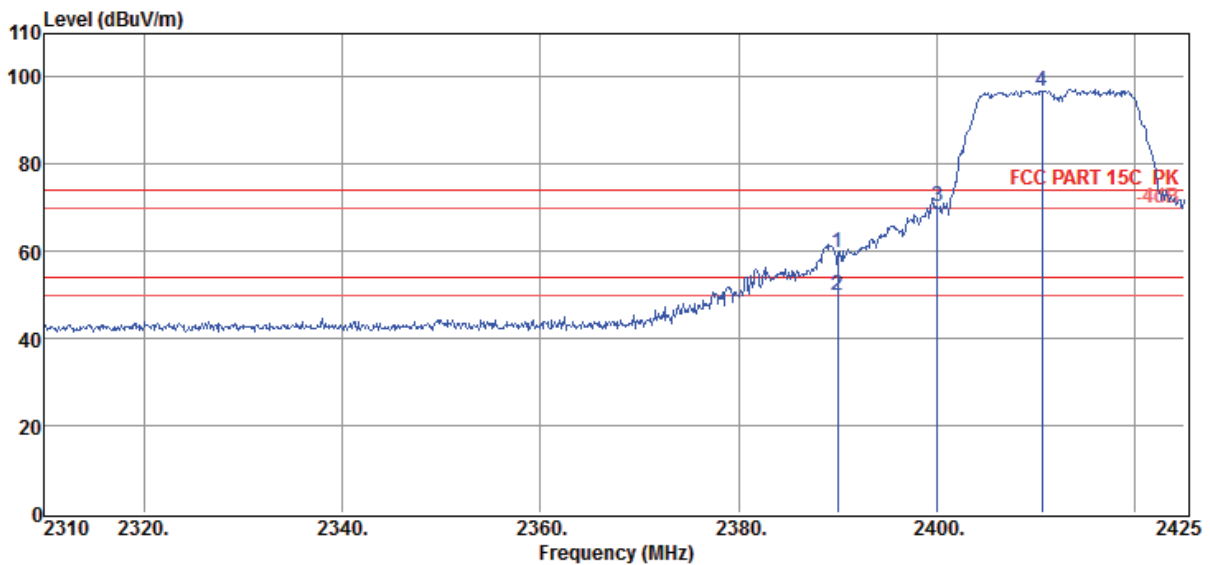

Item (Mark)	Freq (MHz)	Read Level (dBμV)	Antenna Factor (dB/m)	PRM Factor dB	Cable Loss dB	Result Level (dBμV/m)	Limit Line (dBμV/m)	Over Limit (dB)	Detector	Polarization
1	2390.00	65.30	29.99	43.84	8.35	59.80	74.00	-14.20	Peak	HORIZONTAL
2	2390.00	55.30	29.99	43.84	8.35	49.80	54.00	-4.20	Average	HORIZONTAL
3	2400.00	75.80	29.99	43.84	8.35	70.30	74.00	-3.70	Peak	HORIZONTAL
4	2410.63	102.33	30.04	43.85	8.35	96.87	/	/	Peak	HORIZONTAL

- Note: 1. Result Level = Read Level + Antenna Factor + Cable loss - PRM Factor
 2. If Peak Result comply with AV limit, AV Result is deemed to comply with AV limit
 3. Test setup: RBW: 1MHz, VBW: 3MHz, Sweep time:auto

Radiated Emission Test Result

Test Site	: DDT 3m Chamber	E:\2013 Report data\13QE0070\RE 1G-18G.EM6
Test Date	: 2013-08-08	Tested By : Leo Liu
EUT	: GuruPlug	Model Number : 003-GP0XXXXXX
Power Supply	: AC 120V/60Hz	Test Mode : 11G CH1
Condition	: Temp:24.5'C,Humi:55%, Press:100.1kPa	Antenna/Distance : 2013 HF907/3m/VERTICAL
Memo	:	

Data: 62

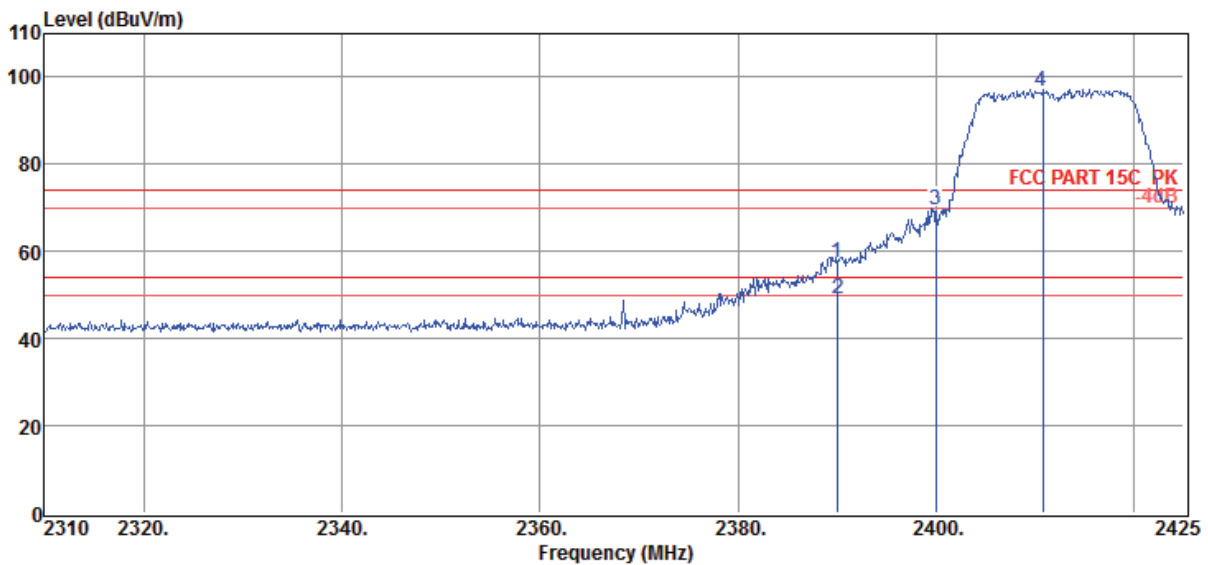

Item (Mark)	Freq (MHz)	Read Level (dBμV)	Antenna Factor (dB/m)	PRM Factor dB	Cable Loss dB	Result Level (dBμV/m)	Limit Line (dBμV/m)	Over Limit (dB)	Detector	Polarization
1	2390.00	62.92	29.99	43.84	8.35	57.42	74.00	-16.58	Peak	VERTICAL
2	2390.00	52.32	29.99	43.84	8.35	46.82	54.00	-7.18	Average	VERTICAL
3	2400.00	74.72	29.99	43.84	8.35	69.22	74.00	-4.78	Peak	VERTICAL
4	2410.86	102.58	30.04	43.85	8.35	97.12	/	/	Peak	VERTICAL

- Note: 1. Result Level = Read Level + Antenna Factor + Cable loss - PRM Factor
 2. If Peak Result comply with AV limit, AV Result is deemed to comply with AV limit
 3. Test setup: RBW: 1MHz, VBW: 3MHz, Sweep time:auto

Radiated Emission Test Result

Test Site	: DDT 3m Chamber	E:\2013 Report data\13QE0070\RE 1G-18G.EM6
Test Date	: 2013-08-08	Tested By : Leo Liu
EUT	: GuruPlug	Model Number : 003-GP0XXXXXX
Power Supply	: AC 120V/60Hz	Test Mode : 11G CH11
Condition	: Temp:24.5'C,Humi:55%, Press:100.1kPa	Antenna/Distance : 2013 HF907/3m/VERTICAL
Memo	:	

Data: 67

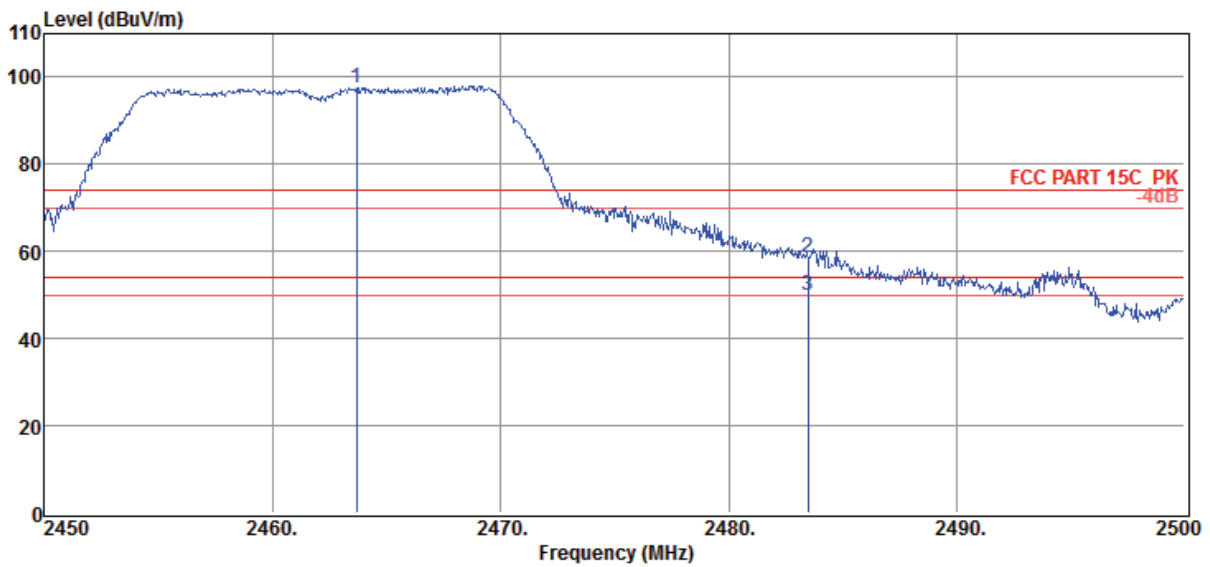

Item (Mark)	Freq (MHz)	Read Level (dBμV)	Antenna Factor (dB/m)	PRM Factor dB	Cable Loss dB	Result Level (dBμV/m)	Limit Line (dBμV/m)	Over Limit (dB)	Detector	Polarization
1	2463.70	102.82	30.20	43.88	8.45	97.59	/	/	Peak	VERTICAL
2	2483.50	63.67	30.25	43.89	8.50	58.53	74.00	-15.47	Peak	VERTICAL
3	2483.50	55.13	30.25	43.89	8.50	49.99	54.00	-4.01	Average	VERTICAL

- Note: 1. Result Level = Read Level + Antenna Factor + Cable loss - PRM Factor
 2. If Peak Result comply with AV limit, AV Result is deemed to comply with AV limit
 3. Test setup: RBW: 1MHz, VBW: 3MHz, Sweep time:auto

Radiated Emission Test Result

Test Site : DDT 3m Chamber E:\2013 Report data\13QE0070\RE 1G-18G.EM6
Test Date : 2013-08-08 **Tested By** : Leo Liu
EUT : GuruPlug **Model Number** : 003-GP0XXXXXX
Power Supply : AC 120V/60Hz **Test Mode** : 11G CH11
Condition : Temp:24.5'C,Humi:55%,
 Press:100.1kPa **Antenna/Distance** : 2013 HF907/3m/HORIZONTAL
Memo :

Data: 68

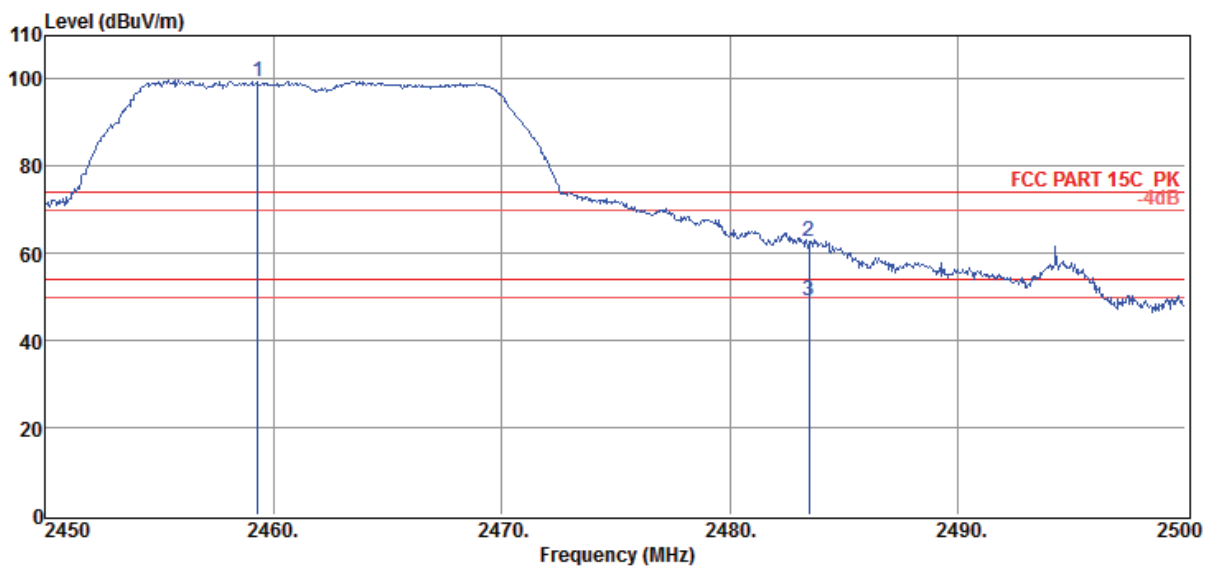

Item (Mark)	Freq (MHz)	Read Level (dBμV)	Antenna Factor (dB/m)	PRM Factor dB	Cable Loss dB	Result Level (dBμV/m)	Limit Line (dBμV/m)	Over Limit (dB)	Detector	Polarization
1	2459.30	104.65	30.20	43.88	8.45	99.42	/	/	Peak	HORIZONTAL
2	2483.50	67.74	30.25	43.89	8.50	62.60	74.00	-11.40	Peak	HORIZONTAL
3	2483.50	54.36	30.25	43.89	8.50	49.22	54.00	-4.78	Average	HORIZONTAL

- Note: 1. Result Level = Read Level + Antenna Factor + Cable loss - PRM Factor
 2. If Peak Result comply with AV limit, AV Result is deemed to comply with AV limit
 3. Test setup: RBW: 1MHz, VBW: 3MHz, Sweep time:auto

Radiated Emission Test Result

Test Site : DDT 3m Chamber E:\2013 Report data\13QE0070\RE 1G-18G.EM6
Test Date : 2013-08-08 **Tested By** : Leo Liu
EUT : GuruPlug **Model Number** : 003-GP0XXXXXX
Power Supply : AC 120V/60Hz **Test Mode** : 11N HT20 CH1
Condition : Temp:24.5'C,Humi:55%,
 Press:100.1kPa **Antenna/Distance** : 2013 HF907/3m/VERTICAL
Memo :

Data: 71

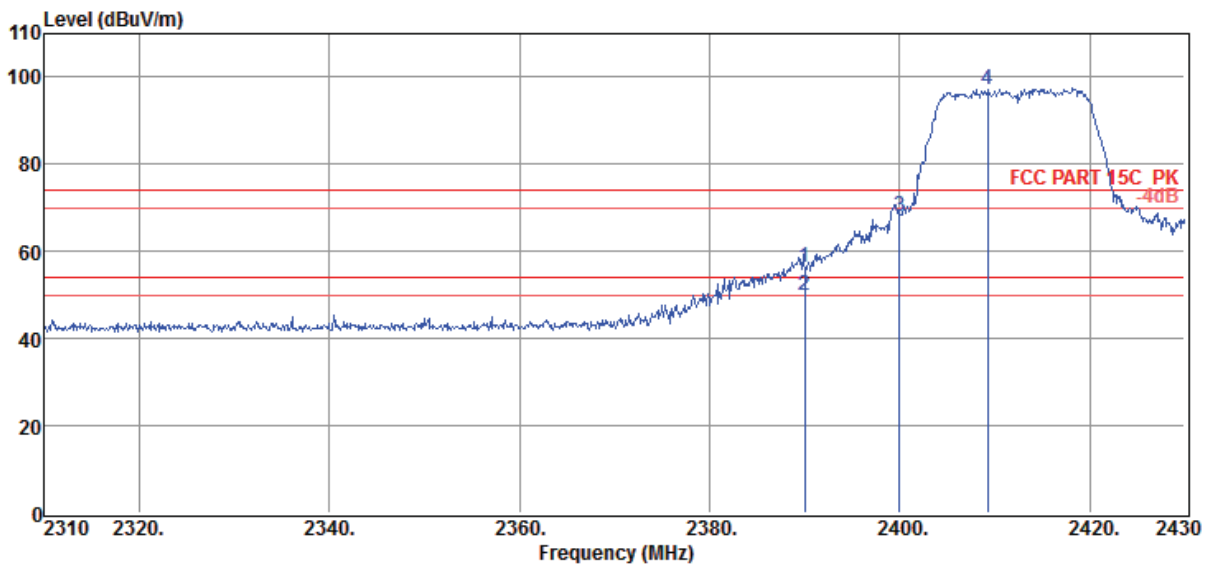

Item (Mark)	Freq (MHz)	Read Level (dBμV)	Antenna Factor (dB/m)	PRM Factor dB	Cable Loss dB	Result Level (dBμV/m)	Limit Line (dBμV/m)	Over Limit (dB)	Detector	Polarization
1	2390.00	61.75	29.99	43.84	8.35	56.25	74.00	-17.75	Peak	VERTICAL
2	2390.00	55.36	29.99	43.84	8.35	49.86	54.00	-4.14	Average	VERTICAL
3	2400.00	73.69	29.99	43.84	8.35	68.19	74.00	-5.81	Peak	VERTICAL
4	2409.24	102.76	30.04	43.85	8.35	97.30	/	/	Peak	VERTICAL

- Note: 1. Result Level = Read Level + Antenna Factor + Cable loss - PRM Factor
 2. If Peak Result comply with AV limit, AV Result is deemed to comply with AV limit
 3. Test setup: RBW: 1MHz, VBW: 3MHz, Sweep time:auto

Radiated Emission Test Result

Test Site : DDT 3m Chamber E:\2013 Report data\13QE0070\RE 1G-18G.EM6
Test Date : 2013-08-08 **Tested By** : Leo Liu
EUT : GuruPlug **Model Number** : 003-GP0XXXXXX
Power Supply : AC 120V/60Hz **Test Mode** : 11N HT20 CH1
Condition : Temp:24.5'C,Humi:55%,
 Press:100.1kPa **Antenna/Distance** : 2013 HF907/3m/HORIZONTAL
Memo :

Data: 72

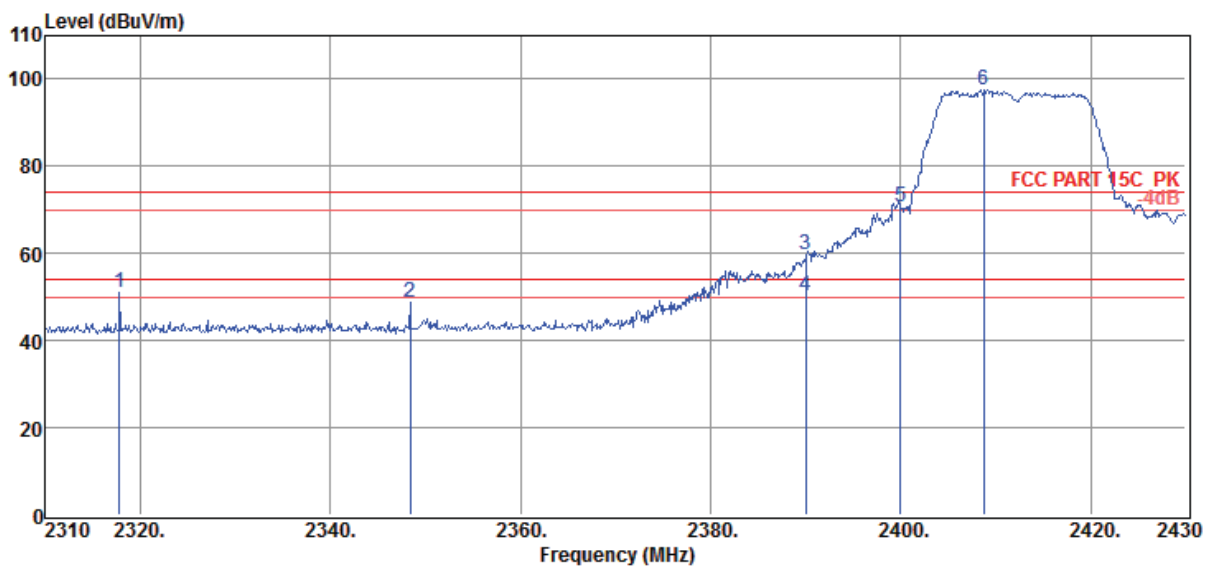

Item (Mark)	Freq (MHz)	Read Level (dBμV)	Antenna Factor (dB/m)	PRM Factor (dB)	Cable Loss (dB)	Result Level (dBμV/m)	Limit Line (dBμV/m)	Over Limit (dB)	Detector	Polarization
1	2317.80	56.76	29.78	43.79	8.20	50.95	74.00	-23.05	Peak	HORIZONTAL
2	2348.40	54.54	29.83	43.80	8.25	48.82	74.00	-25.18	Peak	HORIZONTAL
3	2390.00	65.28	29.99	43.84	8.35	59.78	74.00	-14.22	Peak	HORIZONTAL
4	2390.00	55.62	29.99	43.84	8.35	50.12	54.00	-3.88	Average	HORIZONTAL
5	2400.00	76.36	29.99	43.84	8.35	70.86	74.00	-3.14	Peak	HORIZONTAL
6	2408.76	102.99	30.04	43.85	8.35	97.53	/	/	Peak	HORIZONTAL

Note: 1. Result Level = Read Level + Antenna Factor + Cable loss - PRM Factor

2. If Peak Result comply with AV limit, AV Result is deemed to comply with AV limit

3. Test setup: RBW: 1MHz, VBW: 3MHz, Sweep time:auto

Radiated Emission Test Result

Test Site : DDT 3m Chamber E:\2013 Report data\13QE0070\RE 1G-18G.EM6
Test Date : 2013-08-08 **Tested By** : Leo Liu
EUT : GuruPlug **Model Number** : 003-GP0XXXXXX
Power Supply : AC 120V/60Hz **Test Mode** : 11N HT20 CH11
Condition : Temp:24.5'C,Humi:55%,
 Press:100.1kPa **Antenna/Distance** : 2013 HF907/3m/HORIZONTAL
Memo :

Data: 77

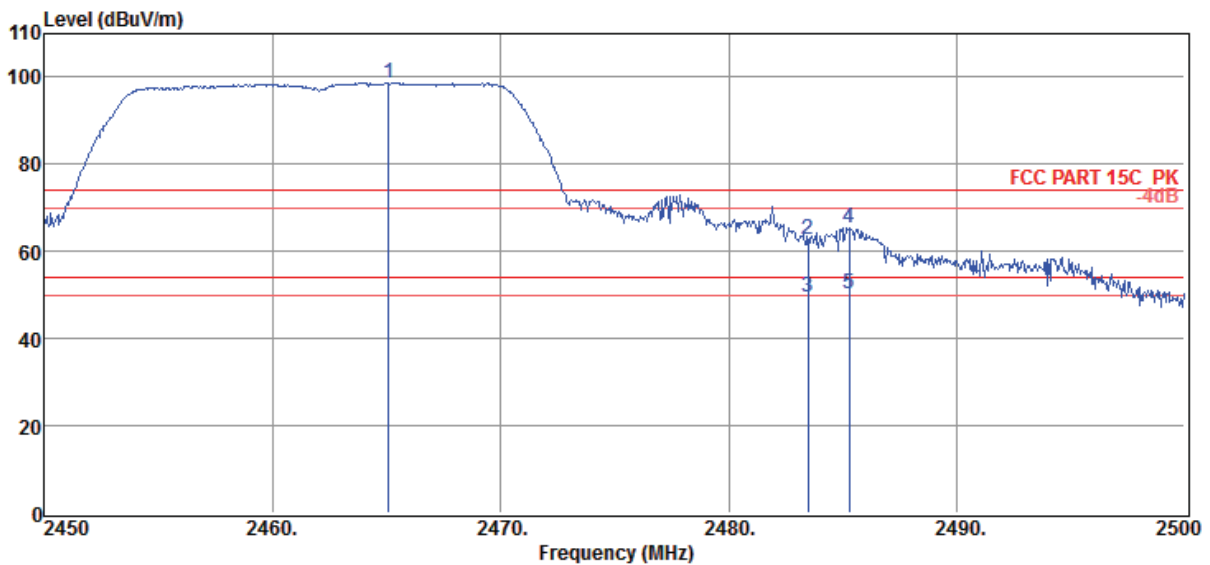

Item (Mark)	Freq (MHz)	Read Level (dBμV)	Antenna Factor (dB/m)	PRM Factor (dB)	Cable Loss (dB)	Result Level (dBμV/m)	Limit Line (dBμV/m)	Over Limit (dB)	Detector	Polarization
1	2465.10	103.98	30.20	43.88	8.45	98.75	/	/	Peak	HORIZONTAL
2	2483.50	67.92	30.25	43.89	8.50	62.78	74.00	-11.22	Peak	HORIZONTAL
3	2483.50	54.62	30.25	43.89	8.50	49.48	54.00	-4.52	Average	HORIZONTAL
4	2485.30	70.59	30.25	43.89	8.50	65.45	74.00	-8.55	Peak	HORIZONTAL
5	2485.30	55.36	30.25	43.89	8.50	50.22	54.00	-3.78	Average	HORIZONTAL

- Note: 1. Result Level = Read Level + Antenna Factor + Cable loss - PRM Factor
 2. If Peak Result comply with AV limit, AV Result is deemed to comply with AV limit
 3. Test setup: RBW: 1MHz, VBW: 3MHz, Sweep time:auto

Radiated Emission Test Result

Test Site : DDT 3m Chamber	E:\2013 Report data\13QE0070\RE 1G-18G.EM6
Test Date : 2013-08-08	Tested By : Leo Liu
EUT : GuruPlug	Model Number : 003-GP0XXXXXX
Power Supply : AC 120V/60Hz	Test Mode : 11N HT20 CH11
Condition : Temp:24.5'C,Humi:55%, Press:100.1kPa	Antenna/Distance : 2013 HF907/3m/VERTICAL
Memo :	

Data: 78

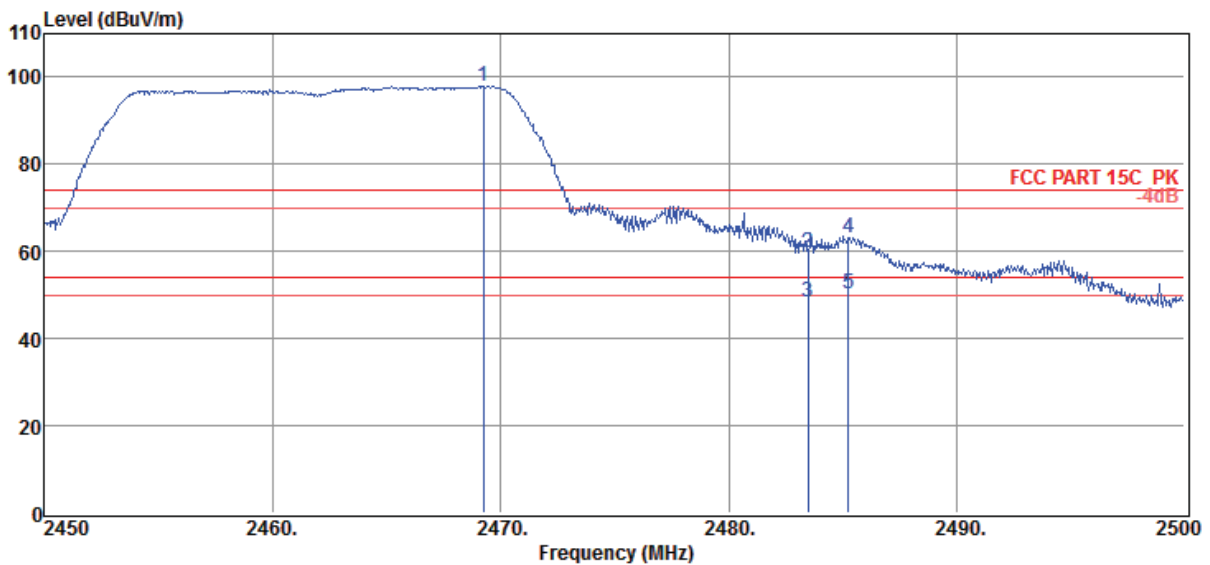

Item (Mark)	Freq (MHz)	Read Level (dBμV)	Antenna Factor (dB/m)	PRM Factor dB	Cable Loss dB	Result Level (dBμV/m)	Limit Line (dBμV/m)	Over Limit (dB)	Detector	Polarization
1	2469.25	103.15	30.20	43.88	8.45	97.92	/	/	Peak	VERTICAL
2	2483.50	64.86	30.25	43.89	8.50	59.72	74.00	-14.28	Peak	VERTICAL
3	2483.50	53.36	30.25	43.89	8.50	48.22	54.00	-5.78	Average	VERTICAL
4	2485.25	68.34	30.25	43.89	8.50	63.20	74.00	-10.80	Peak	VERTICAL
5	2485.25	55.37	30.25	43.89	8.50	50.23	54.00	-3.77	Average	VERTICAL

Note: 1. Result Level = Read Level + Antenna Factor + Cable loss - PRM Factor
 2. If Peak Result comply with AV limit, AV Result is deemed to comply with AV limit
 3. Test setup: RBW: 1MHz, VBW: 3MHz, Sweep time:auto

Radiated Emission Test Result

Test Site : DDT 3m Chamber E:\2013 Report data\13QE0070\RE 1G-18G.EM6
Test Date : 2013-08-08 **Tested By** : Leo Liu
EUT : GuruPlug **Model Number** : 003-GP0XXXXXX
Power Supply : AC 120V/60Hz **Test Mode** : 11N HT40 CH3
Condition : Temp:24.5'C,Humi:55%,
 Press:100.1kPa **Antenna/Distance** : 2013 HF907/3m/HORIZONTAL
Memo :

Data: 81

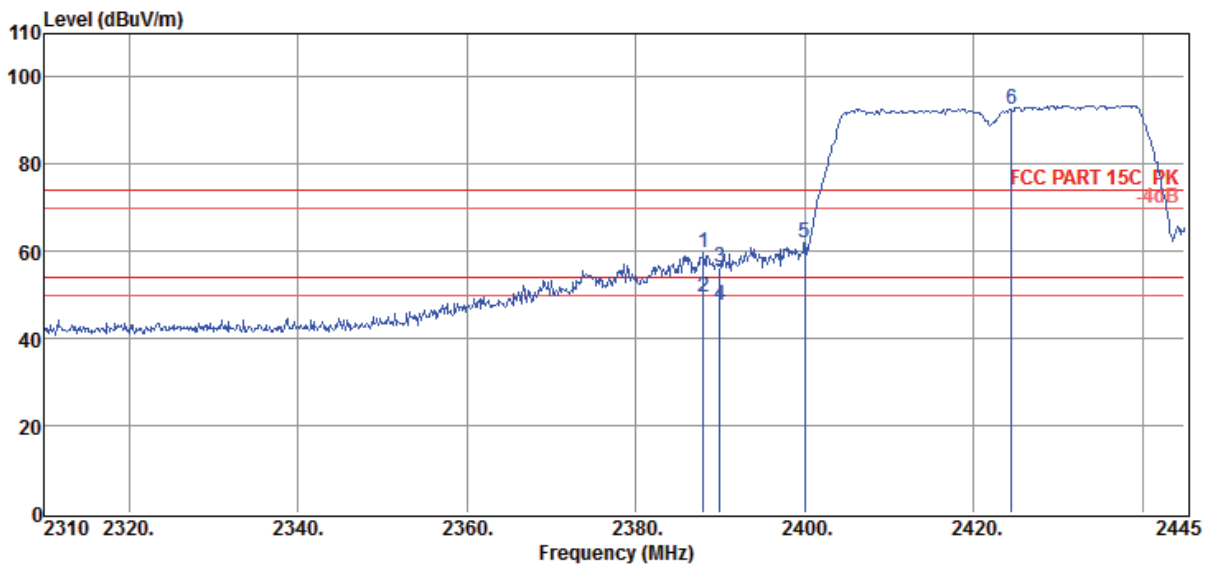

Item (Mark)	Freq (MHz)	Read Level (dBμV)	Antenna Factor (dB/m)	PRM Factor dB	Cable Loss dB	Result Level (dBμV/m)	Limit Line (dBμV/m)	Over Limit (dB)	Detector	Polarization
1	2388.03	65.17	29.99	43.84	8.35	59.67	74.00	-14.33	Peak	HORIZONTAL
2	2388.03	54.95	29.99	43.84	8.35	49.45	54.00	-4.55	Average	HORIZONTAL
3	2390.00	61.75	29.99	43.84	8.35	56.25	74.00	-17.75	Peak	HORIZONTAL
4	2390.00	52.94	29.99	43.84	8.35	47.44	54.00	-6.56	Average	HORIZONTAL
5	2400.00	67.39	29.99	43.84	8.35	61.89	74.00	-12.11	Peak	HORIZONTAL
6	2424.48	98.12	30.09	43.86	8.40	92.75	/	/	Peak	HORIZONTAL

Note: 1. Result Level = Read Level + Antenna Factor + Cable loss - PRM Factor
 2. If Peak Result comply with AV limit, AV Result is deemed to comply with AV limit
 3. Test setup: RBW: 1MHz, VBW: 3MHz, Sweep time:auto

Radiated Emission Test Result

Test Site : DDT 3m Chamber E:\2013 Report data\13QE0070\RE 1G-18G.EM6
Test Date : 2013-08-08 **Tested By** : Leo Liu
EUT : GuruPlug **Model Number** : 003-GP0XXXXXX
Power Supply : AC 120V/60Hz **Test Mode** : 11N HT40 CH3
Condition : Temp:24.5'C,Humi:55%,
 Press:100.1kPa **Antenna/Distance** : 2013 HF907/3m/VERTICAL
Memo :

Data: 82

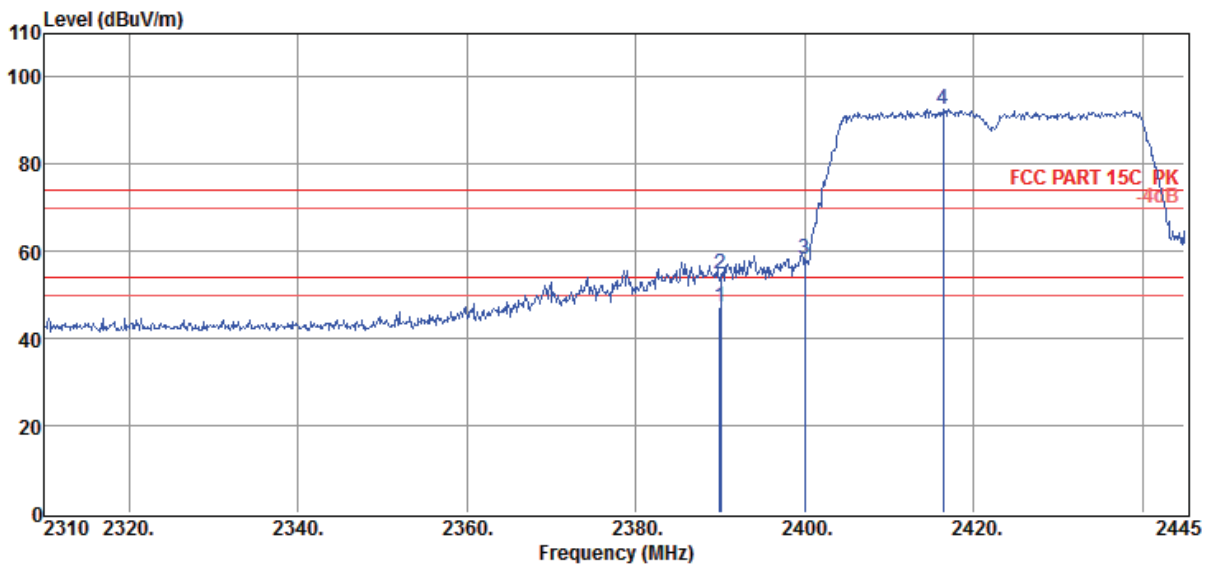

Item (Mark)	Freq (MHz)	Read Level (dBμV)	Antenna Factor (dB/m)	PRM Factor dB	Cable Loss dB	Result Level (dBμV/m)	Limit Line (dBμV/m)	Over Limit (dB)	Detector	Polarization
1	2390.00	52.76	29.99	43.84	8.35	47.26	54.00	-6.74	Average	VERTICAL
2	2390.00	60.42	29.99	43.84	8.35	54.92	74.00	-19.08	Peak	VERTICAL
3	2400.00	63.57	29.99	43.84	8.35	58.07	74.00	-15.93	Peak	VERTICAL
4	2416.38	98.21	30.04	43.85	8.35	92.75	/	/	Peak	VERTICAL

Note: 1. Result Level = Read Level + Antenna Factor + Cable loss - PRM Factor
 2. If Peak Result comply with AV limit, AV Result is deemed to comply with AV limit
 3. Test setup: RBW: 1MHz, VBW: 3MHz, Sweep time:auto

Radiated Emission Test Result

Test Site	: DDT 3m Chamber	E:\2013 Report data\13QE0070\RE 1G-18G.EM6
Test Date	: 2013-08-08	Tested By : Leo Liu
EUT	: GuruPlug	Model Number : 003-GP0XXXXXX
Power Supply	: AC 120V/60Hz	Test Mode : 11N HT40 CH9
Condition	: Temp:24.5'C,Humi:55%, Press:100.1kPa	Antenna/Distance : 2013 HF907/3m/VERTICAL
Memo	:	

Data: 87

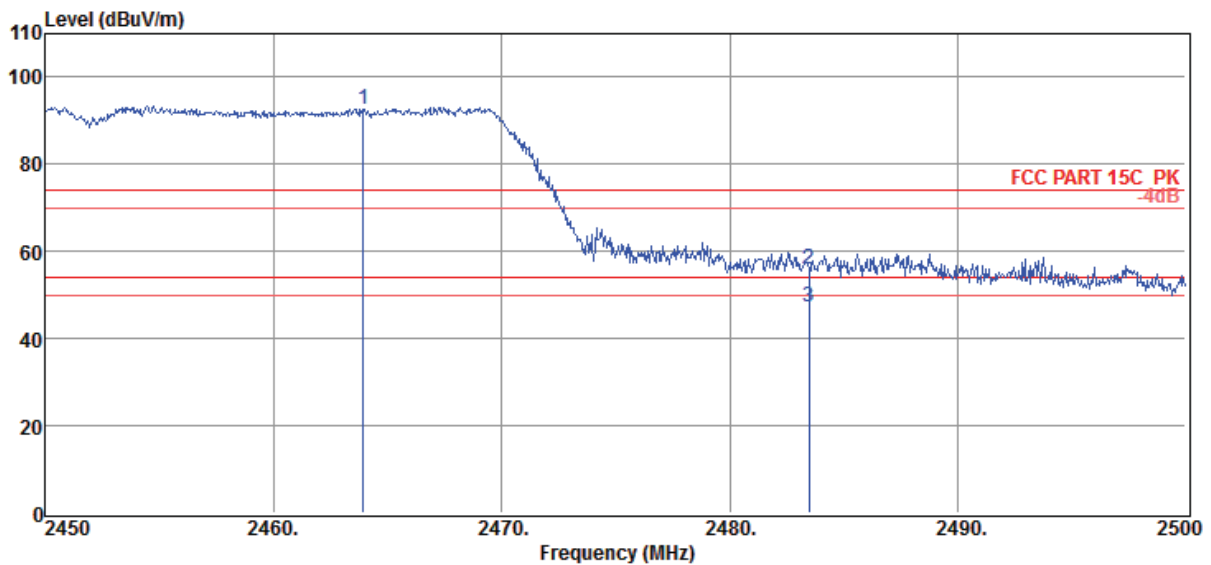

Item (Mark)	Freq (MHz)	Read Level (dBμV)	Antenna Factor (dB/m)	PRM Factor dB	Cable Loss dB	Result Level (dBμV/m)	Limit Line (dBμV/m)	Over Limit (dB)	Detector	Polarization
1	2463.95	97.86	30.20	43.88	8.45	92.63	/	/	Peak	VERTICAL
2	2483.50	61.09	30.25	43.89	8.50	55.95	74.00	-18.05	Peak	VERTICAL
3	2483.50	52.39	30.25	43.89	8.50	47.25	54.00	-6.75	Average	VERTICAL

- Note: 1. Result Level = Read Level + Antenna Factor + Cable loss - PRM Factor
 2. If Peak Result comply with AV limit, AV Result is deemed to comply with AV limit
 3. Test setup: RBW: 1MHz, VBW: 3MHz, Sweep time:auto

Radiated Emission Test Result

Test Site : DDT 3m Chamber E:\2013 Report data\13QE0070\RE 1G-18G.EM6
Test Date : 2013-08-08 **Tested By** : Leo Liu
EUT : GuruPlug **Model Number** : 003-GP0XXXXXX
Power Supply : AC 120V/60Hz **Test Mode** : 11N HT40 CH9
Condition : Temp:24.5'C,Humi:55%,
 Press:100.1kPa **Antenna/Distance** : 2013 HF907/3m/HORIZONTAL
Memo :

Data: 88

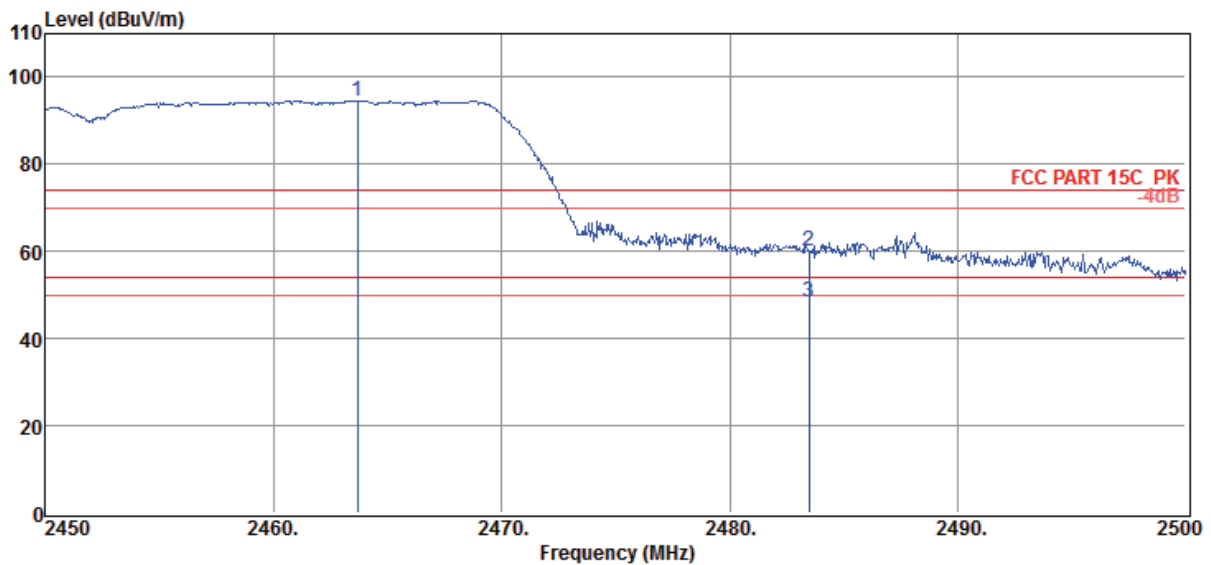

Item (Mark)	Freq (MHz)	Read Level (dBμV)	Antenna Factor (dB/m)	PRM Factor dB	Cable Loss dB	Result Level (dBμV/m)	Limit Line (dBμV/m)	Over Limit (dB)	Detector	Polarization
1	2463.70	99.91	30.20	43.88	8.45	94.68	/	/	Peak	HORIZONTAL
2	2483.50	65.07	30.25	43.89	8.50	59.93	74.00	-14.07	Peak	HORIZONTAL
3	2483.50	53.49	30.25	43.89	8.50	48.35	54.00	-5.65	Average	HORIZONTAL

Note: 1. Result Level = Read Level + Antenna Factor + Cable loss - PRM Factor
 2. If Peak Result comply with AV limit, AV Result is deemed to comply with AV limit
 3. Test setup: RBW: 1MHz, VBW: 3MHz, Sweep time:auto

9. Power Line Conducted Emission

9.1. Test equipment

Item	Equipment	Manufacturer	Model No.	Serial No.	Last Cal.	Cal. Interval
1	Test Receiver	R&S	ESU8	100316	2012/11/26	1 Year
2	LISN 1	R&S	ENV216	101109	2012/11/26	1 Year
3	LISN 2	R&S	ESH2-Z5	100309	2012/11/26	1 Year
4	Pulse Limiter	R&S	ESH3-Z2	101242	2012/11/26	1 Year

9.2. Block diagram of test setup

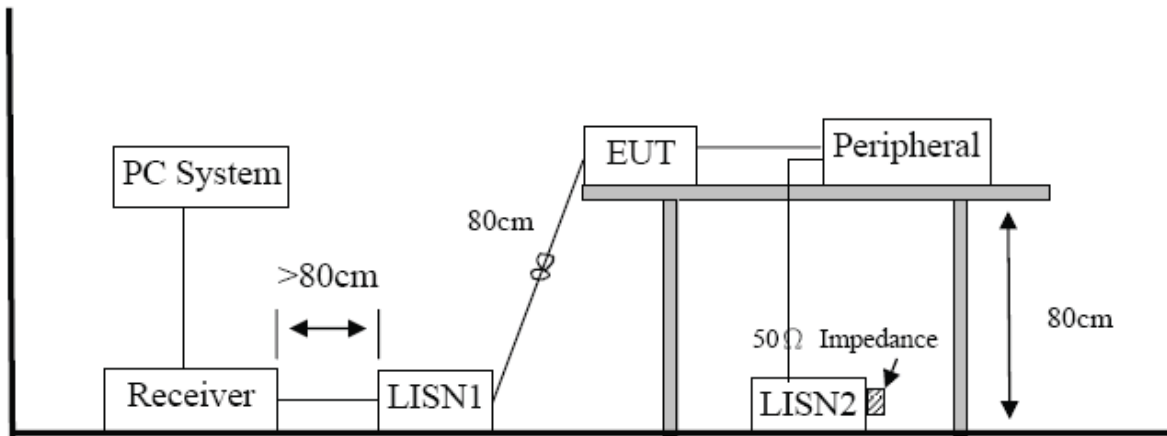

9.3. Power Line Conducted Emission Limits(Class B)

Frequency	Quasi-Peak Level dB(μ V)	Average Level dB(μ V)
150kHz ~ 500kHz	66 ~ 56*	56 ~ 46*
500kHz ~ 5MHz	56	46
5MHz ~ 30MHz	60	50

Note 1: * Decreasing linearly with logarithm of frequency.

Note 2: The lower limit shall apply at the transition frequencies.

9.4. Test Procedure

The EUT and Support equipment, if needed, were put placed on a non-metallic table, 80cm above the ground plane.

Configuration EUT to simulate typical usage as described in clause 2.4 and test equipment as described in clause 10.2 of this report.

All I/O cables were positioned to simulate typical actual usage as per ANSI C63.4:2003

All support equipment power received from a second LISN.

Emissions were measured on each current carrying line of the EUT using an EMI Test Receiver connected to the LISN powering the EUT.

The Receiver scanned from 150 kHz to 30MHz for emissions in each of the test modes.

During the above scans, the emissions were maximized by cable manipulation.

The test mode(s) described in clause 2.4 were scanned during the preliminary test.

After the preliminary scan, we found the test mode producing the highest emission level.

The EUT configuration and worse cable configuration of the above highest emission levels were recorded for reference of the final test.

EUT and support equipment were set up on the test bench as per the configuration with highest emission level in the preliminary test.

A scan was taken on both power lines, Neutral and Line, recording at least the six highest emissions.

Emission frequency and amplitude were recorded into a computer in which correction factors were used to calculate the emission level and compare reading to the applicable limit.

The test data of the worst-case condition(s) was recorded.

The bandwidth of test receiver is set at 9 KHz.

9.5. Test Result

PASS. (See below detailed test result)

Note1: All emissions not reported below are too low against the prescribed limits.

Note2: “----” means peak detection; “-----” mans average detection

Conducted Emission Test Result

Test Site	: DDT 1# Shield Room	E:\2013 report data\13QE0070\13QE0070.EM6
Test Date	: 2013-08-12	Tested By : Leo Liu
EUT	: GuruPlug	Model Number : 003-GP0XXXXXX
Power Supply	: AC 120V/60Hz	Test Mode : Tx Mode
Condition	: Temp:24.5°C,Humi:55%, Press:100.1kPa	LISN : 2013 ENV216/NEUTRAL

Data : 25

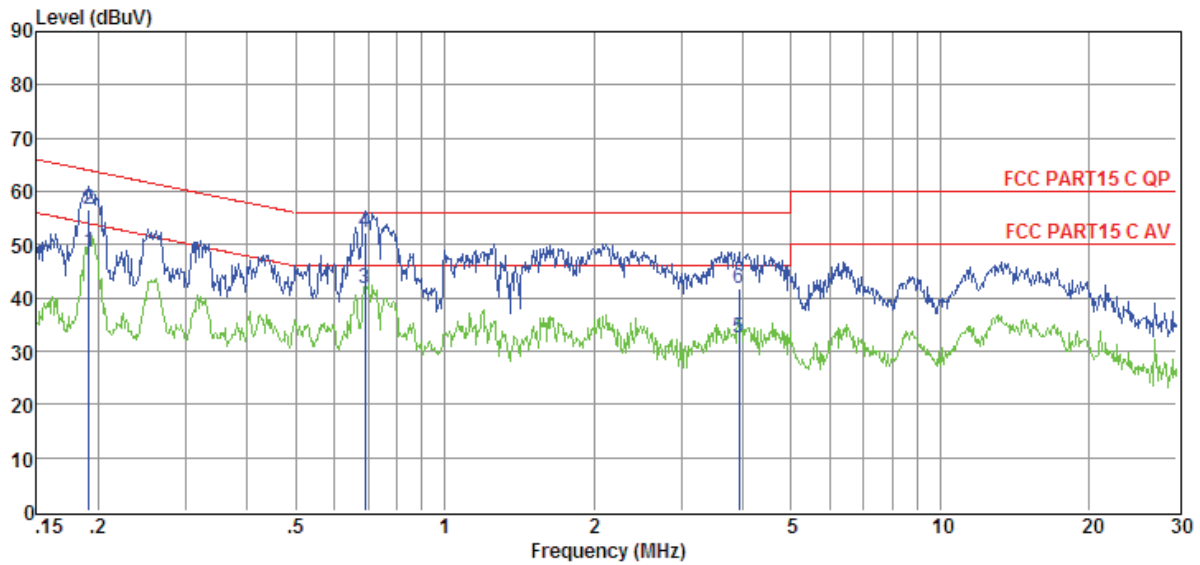

Item	Freq	Read Level	LISN Factor	Cable Loss	Pulse Limiter Factor	Result Level	Limit Line	Over Limit	Detector	Phase
(Mark)	(MHz)	(dBμV)	(dB)	(dB)	(dB)	(dBμV)	(dBμV)	(dB)		
1	0.19	28.94	9.59	0.02	9.85	48.40	53.98	-5.58	Average	NEUTRAL
2	0.19	37.20	9.59	0.02	9.85	56.66	63.98	-7.32	QP	NEUTRAL
3	0.69	22.33	9.62	0.06	9.85	41.86	46.00	-4.14	Average	NEUTRAL
4	0.69	32.84	9.62	0.06	9.85	52.37	56.00	-3.63	QP	NEUTRAL
5	3.92	12.76	9.62	0.10	9.87	32.35	46.00	-13.65	Average	NEUTRAL
6	3.92	22.14	9.62	0.10	9.87	41.73	56.00	-14.27	QP	NEUTRAL

Note: 1. Result Level = Read Level + LISN Factor + Pulse Limiter Factor + Cable loss
 2. If QP Result comply with AV limit, AV Result is deemed to comply with AV limit
 3. Test setup: RBW: 200Hz(9kHz—150kHz) , 9kHz(150kHz—30MHz), Step size:4kHz, Scan time: auto

Conducted Emission Test Result

Test Site	: DDT 1# Shield Room	E:\2013 report data\13QE0070\13QE0070.EM6
Test Date	: 2013-08-12	Tested By : Leo Liu
EUT	: GuruPlug	Model Number : 003-GP0XXXXXX
Power Supply	: AC 120V/60Hz	Test Mode : Tx Mode
Condition	: Temp:24.5'C,Humi:55%, Press:100.1kPa	LISN : 2013 ENV216/LINE

Data : 27

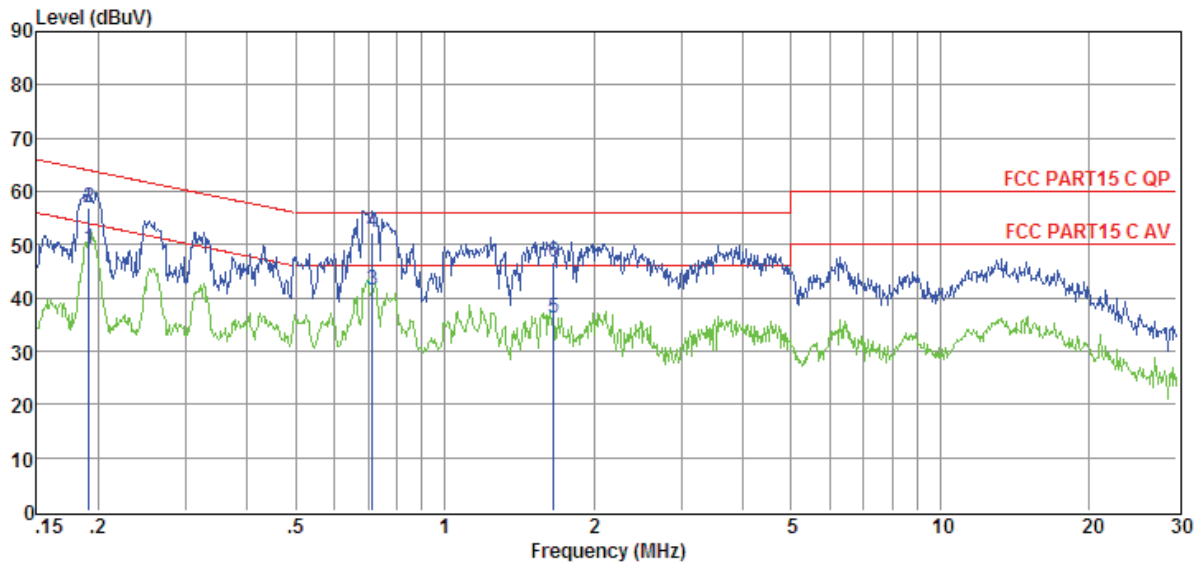

Item	Freq	Read Level	LISN Factor	Cable Loss	Pulse Limiter Factor	Result Level	Limit Line	Over Limit	Detector	Phase
(Mark)	(MHz)	(dBμV)	(dB)	(dB)	(dB)	(dBμV)	(dBμV)	(dB)		
1	0.19	29.65	9.59	0.02	9.85	49.11	53.98	-4.87	Average	LINE
2	0.19	37.35	9.59	0.02	9.85	56.81	63.98	-7.17	QP	LINE
3	0.72	21.99	9.62	0.07	9.85	41.53	46.00	-4.47	Average	LINE
4	0.72	32.70	9.62	0.07	9.85	52.24	56.00	-3.76	QP	LINE
5	1.66	16.58	9.61	0.06	9.87	36.12	46.00	-9.88	Average	LINE
6	1.66	27.22	9.61	0.06	9.87	46.76	56.00	-9.24	QP	LINE

Note: 1. Result Level = Read Level + LISN Factor + Pulse Limiter Factor + Cable loss
 2. If QP Result comply with AV limit, AV Result is deemed to comply with AV limit
 3. Test setup: RBW: 200Hz(9kHz—150kHz) , 9kHz(150kHz—30MHz), Step size:4kHz, Scan time: auto

10. Antenna Requirements

10.1. Limit

For intentional device, according to FCC 47 CFR Section 15.203, an intentional radiator shall be designed to ensure that no antenna other than that furnished by the responsible party shall be used with the device. And according to FCC 47 CFR Section 15.247 (b), if transmitting antennas of directional gain greater than 6dBi are used, the power shall be reduced by the amount in dB that the directional gain of the antenna exceeds 6dBi.

10.2. Result

The antennas used for this product are built-in undetachable Patch antenna and that no antenna other than that furnished by the responsible party shall be used with the device, the maximum peak gain of the transmit antenna is only 0dBi.