



SWG-125 Rev. G

June 2013

SWG-125 -- Globe Wireless

Globe *i*Fusion[®] User Guide for *i*500, *i*250, and *i*S



Issued by Globe Wireless, LLC

1571 Robert J. Conlan Blvd. NE Palm Bay, FL 32905



SWG-125 Rev. G

June 2013

© Copyright 2011 - 2013, Globe Wireless, LLC All rights reserved

This document contains information Confidential and Proprietary to Globe Wireless®. No part of this publication may be reproduced or transmitted by any means; and disclosure or distribution of its contents for any purpose without written consent from Globe Wireless® is strictly prohibited.

Every effort has been made to ensure that the information contained herein is complete and accurate. However the information contained in this manual is subject to change without notice and Globe Wireless® reserves the right to change specifications of hardware and software without prior notice. Globe Wireless® assumes no responsibility or liability for any errors or inaccuracies that may appear in this document. Companies, names and data used in examples herein are fictitious, unless otherwise noted.

Microsoft Windows, Word, and Excel are registered trademarks of Microsoft Corporation. Lotus and cc:Mail are registered trademarks of IBM Corporation. Other software programs mentioned herein are the registered trademarks of their respective owners.

The words Globe Wireless and Globe Wireless logo depicted herein are registered with the United States Patent and Trademark Office. Globe Wireless, LLC reserves all trademark and service mark rights worldwide to the terms Globe Wireless, Globe Communications Center, GlobeEmail, Global Maritime Data Network, GlobeData, Globe Satellite, Globe Transfer, GlobeRelay and GPS Server mentioned or depicted herein.

This document, as well as software described in it, are protected under the copyright laws of the United States of American and similar laws in other countries of the world This document contains information Confidential and Proprietary to Globe Wireless®. No part of this publication may be reproduced or transmitted by any means and disclosure or distribution of its contents for any purpose without written consent from Globe Wireless® is strictly prohibited.

Issued by Globe Wireless, LLC

1571 Robert J. Conlan Blvd. NE Palm Bay, FL 32905

Table of Contents

Important Regulatory and Safety Information for i250-S3	xii
Important Regulatory and Safety Information for i500-S3	xv
CE Certification Globe iS	xix
FCC-Certification Globe iS	xx
Manual Organization	xxi
Special Notations.....	xxi
Customer Comments	xxi
1.0 Introduction	1-1
1.1 Key Features.....	1-1
1.1.1 IP Router	1-1
1.1.2 GlobeVoice	1-2
1.1.3 Email.....	1-2
1.1.4 Web Browsing.....	1-2
1.2 Shore Control	1-3
1.3 Globe <i>iFusion</i> ® Overview Diagram	1-4
1.4 Package Contents	1-4
1.5 Installation of the Globe <i>iFusion</i> ®.....	1-5
1.5.1 Installing the Globe <i>iFusion</i> ® into 19” High Profile Rack Cabinet	1-5
1.5.2 Installing the Globe <i>iFusion</i> ® onto Wall, Shelf or Table.....	1-6
2.0 Getting to Know the Globe <i>iFusion</i>®.....	2-1
2.1 The Globe <i>iFusion</i> ® Front Panel – i250, i500, and iS	2-1
2.2 LED Operation	2-2

2.2.1	POWER LED	2-2
2.2.2	READY LED	2-3
2.2.3	BUSY LED	2-4
2.2.4	AC LED	2-4
2.2.5	TERMINAL LED	2-4
2.2.6	ANTENNA LED	2-4
2.2.7	NETWORK LED	2-5
2.2.8	GPS LED	2-5
2.3	The Globe <i>iFusion</i> ® Rear panel for <i>i250</i> , and <i>i500</i>	2-6
2.4	The Globe <i>iFusion</i> ® Rear panel for <i>iS</i>	2-7
3.0	Fixed Multiple Lines	3-1
3.1	Introduction	3-1
3.2	Features	3-1
3.3	Features of the PolyCom Phone.....	3-2
3.4	Navigate through Menus	3-4
3.5	Configure Basic Settings	3-4
3.5.1	Time and Date	3-4
3.5.2	Display Contrast	3-5
3.5.3	Ring Type.....	3-6
3.5.4	Language Support	3-6
3.5.5	Directory Search	3-7
3.6	Manage Contacts	3-8
3.6.1	Adding Contacts	3-8
3.6.2	Deleting Contacts	3-9

3.6.3	Placing a Call to a contact	3-10
3.7	Using Basic Features of your phone	3-10
3.7.1	Placing a Call.....	3-11
3.7.2	Answering a Call	3-11
3.7.2.1	Answer when NOT on another call	3-12
	Using the Handset.....	3-12
	Hands-free Speakerphone	3-12
3.7.2.2	Answer when on another call.....	3-12
	Phone configured for a Single Line Key.....	3-12
	Phone configured for Shared Lines	3-12
3.7.3	Ending a Call	3-13
3.7.4	Placing a Call on Hold	3-13
3.7.5	Setting up Conference Calls	3-13
	To Split a conference call:.....	3-14
	Set up a Conference Call	3-14
	To End a Conference Call	3-15
3.7.6	Transferring Calls	3-15
	Consultative Transfer	3-15
	Blind Transfer	3-16
	Attended Transfer	3-16
3.7.7	Do Not Disturb.....	3-16
3.8	Troubleshooting Your Phone.....	3-17
3.8.1	Securing the Handset on-hook.....	3-17
3.8.2	Controls	3-19



SWG-125 Rev. G	June 2013
3.8.3	Access to Screens and Systems..... 3-20
3.8.4	Calling 3-21
3.8.5	Displays 3-22
4.0	Using a Standard Phone 4-1
4.1	Your Phone Number 4-1
4.1.1	Placing a Call from the Phone 4-1
4.1.2	Receiving a Call to the Phone 4-1
4.1.3	Making a Call to the Phone from Shore 4-2
4.2	Captain Override 4-2
5.0	Using the FBB Handset..... 5-1
5.1	FleetBroadband Handset Use 5-1
5.1.1	Connect the handset to the Globe <i>iFusion</i> ®..... 5-2
5.1.2	Making a Call 5-2
5.1.3	Receiving a Call 5-2
6.0	Using a Fax Machine 6-1
6.1	Your Fax Number 6-1
6.1.1	Sending a Fax from the Ship 6-1
6.1.2	Sending a Fax to the Ship 6-2
6.1.3	Receiving a Fax on the Ship 6-2
7.0	Using a Mobile Phone 7-1
7.1	GlobeMobile Services 7-1
7.2	Getting Started 7-2
7.2.1	First Time User..... 7-2
7.2.1.1	Unlocked GSM Mobile Phone 7-3

7.2.1.2	No Mobile Phone	7-6
7.2.2	Downloads	7-9
7.2.3	Login	7-10
7.2.3.1	Forgot Password	7-11
	Receive password by an SMS message sent to your phone	7-11
	I can't or don't want to use a mobile phone	7-12
7.2.3.2	Forgot User ID	7-14
7.2.4	Placing and Receiving Calls	7-16
7.2.5	SMS Text messaging	7-16
7.2.6	Operation Entering and Exiting Shipping Ports	7-16
8.0	Web-Based Software	8-1
8.1	Getting Connected	8-1
8.1.1	Configuring your IP Connection	8-1
8.1.2	Supported Web Browsers	8-2
8.1.3	The URL	8-2
8.2	Navigation	8-3
8.2.1	The Menu and Sub-Menu	8-3
8.2.2	Help	8-3
8.2.3	Communication Status (Home Page)	8-4
8.2.4	Login	8-4
8.2.5	Logout	8-6
8.3	Users	8-6
9.0	Admin User	9-1
9.1	Satellite Tab	9-2

9.1.1	Status Sub-tab.....	9-3
9.1.2	Call History Sub-tab.....	9-4
9.1.3	Data History Sub-tab	9-5
9.1.4	Logs Sub-tab	9-6
9.1.5	Information Sub-tab.....	9-7
9.1.6	Safe Mode Sub-tab.....	9-8
9.2	GlobeMobile Tab	9-9
9.2.1	Status Sub-tab.....	9-9
9.2.2	Admin Sub-tab	9-10
9.2.3	GlobeVoice Lines Sub-tab	9-11
9.3	Network Tab.....	9-12
9.3.1	Users Sub-tab.....	9-13
9.3.2	Gateways	9-14
9.3.3	Proxy Server.....	9-15
9.3.4	Firewall.....	9-15
9.3.5	IP Configuration	9-16
9.3.6	Diagnostics.....	9-17
9.3.7	Routes	9-18
9.3.8	SNAP	9-19
9.3.9	UPS.....	9-20
9.3.10	Reboot.....	9-20
9.4	VSAT Tab	9-21
9.4.1	VSAT Status (<i>default screen</i>)	9-21
9.4.2	VSAT ACU.....	9-22

9.4.3	VSAT Log	9-22
9.5	Usage Tab	9-22
9.5.1	Usage Details Sub-Tab	9-23
9.6	Downloads Tab.....	9-23
10.0	Prepaid Users	10-1
10.1	Home Tab	10-2
10.2	Email Tab (<i>default</i>)	10-2
10.2.1	Compose a Message	10-3
10.2.2	Address Book.....	10-4
10.2.2.1	Add a new Contact	10-4
10.2.2.2	Search for a contact	10-5
10.2.2.3	Edit or Delete a Contact	10-6
10.2.3	Options	10-8
10.2.3.1	Personal Information.....	10-8
10.2.3.2	Display Preferences	10-10
10.2.3.3	Message Highlighting	10-11
10.2.3.4	Folder Preferences	10-13
10.2.4	Search	10-15
10.2.5	Folders Pane	10-17
10.2.5.1	Create a new folder	10-18
10.2.5.2	Rename a Folder.....	10-18
10.2.5.3	Delete a Folder	10-19
10.2.5.4	Unsubscribe / Subscribe	10-20
10.2.5.5	Inbox	10-21

10.2.5.6	Deleted Items Folder	10-23
10.2.5.7	Drafts Folder	10-23
10.2.5.8	Sent Items Folder.....	10-25
10.3	Preferences Tab.....	10-26
10.4	Account Tab.....	10-27
10.4.1	Account Details (<i>default</i>) Sub-Tab.....	10-28
10.4.2	Change Password Sub-Tab	10-28
10.4.3	Add Alias Sub-Tab.....	10-29
10.4.4	Enter Credit Reload Sub-Tab.....	10-29
10.5	Downloads Tab	10-30
11.0	Web Browsing Users	11-1
11.1	Start a Web Browsing Session	11-1
11.2	Stop or Extend a Web Browsing Session	11-2
12.0	Troubleshooting.....	12-1
12.1	Basic User Issues and Solutions	12-1
12.2	Frequently Asked Questions.....	12-2
APPENDIX A:	Updating the Globe <i>iFusion</i> ® Software.....	A-1
APPENDIX B:	Updating the Globe <i>iFusion</i> ® Firmware.....	B-1
APPENDIX C:	Restoring Factory Defaults for the Globe <i>iFusion</i> ® Software	C-1
APPENDIX D:	Technical Specifications.....	D-1
	Globe <i>iFusion</i> ® Front Panel Dimensions and Description.....	D-2
	Globe <i>iFusion</i> ® Rear Panel.....	D-3
APPENDIX E:	Contact Information	E-1



Important Regulatory and Safety Information for i250-S3

Regulatory Information

Federal Communication Commission Notice

FCC Identifier: YC6GLOBEI250S3BDE

USE CONDITIONS:

This device complies with part 15 of the FCC Rules. Operation is subject to the following two Conditions:

1. This device may not cause harmful interference, and
2. This device must accept any interference received, including interference that may cause undesired operation.

NOTE:

This equipment has been tested and found to comply with the limits for a Class B digital device, pursuant to Part 15 of the FCC Rules. These limits are designed to provide reasonable protection against harmful interference in a residential installation. This equipment generates uses and can radiate radio frequency energy and, if not installed and used in accordance with the instructions, may cause harmful interference to radio communications. However, there is no guarantee that interference will not occur in a particular installation.

If this equipment does cause harmful interference to radio or television reception, which can be determined by turning the equipment off and on, the user is encouraged to try to correct the interference by one of the following measures:

- Reorient or relocate the receiving antenna.
- Increase the separation between the equipment and receiver.
- Connect the equipment into an outlet on a circuit different from that to which the receiver is connected.
- Consult the dealer or an experienced radio/TV technician for help.

IMPORTANT NOTE: EXPOSURE TO RADIO FREQUENCY RADIATION



SWG-125 Rev. G

June 2013

This Device complies with FCC & IC radiation exposure limits set forth for an uncontrolled environment. The Antenna used for this transmitter must be installed to provide a separation distance of at least 100cm from all persons and must not be co-located or operating in conjunction with any other antenna or transmitter

FCC CAUTION:

Any Changes or modifications not expressly approved by the manufacturer could void the user's authority, which is granted by FCC, to operate this Maritime Satellite Voice and Data Router

Eu Declaration of Conformity:

Globe wireless LLC, 1571 Robert J. Conlan Blvd. Palm Bay, FL 32905 declares under our sole responsibility that the Product, brand name as Globe wireless and model: Globe i250-S3 Maritime Satellite Voice and Data Router, to which this declaration relates, is in conformity with the following standards and/or other normative documents:

ETSI EN 301 444 V1.2.1:2012

ETSI EN 301 489-1 V1.9.2:2011

ETSI EN 301 489 -19 V1.2.1:2002

ETSI EN 301 489 -20 V1.2.1:2002

EN 60945:2002

EN 60950-1:2006+A11:2009+A1:2010+A12:2011

We hereby declare that all essential radio test suite have been carried out and that the above named product is in conformity to all the essential requirements of Directive 1999/5/EC.

The Conformity Assessment procedure referred to Article 10 and detailed in Annex [III] or [IV] of Directive 1999/5/EC has been followed with involvement of the following notified body(ies):

TIMCO ENGINEERING, INC., P.O BOX 370, NEW BERRY, FLORIDA 32669.



SWG-125 Rev. G

June 2013

Identification mark: 1177 (Notified Body number)

CE1177 

The technical documentation relevant to the above equipment is held at:

- Addvalue Communications Pte Ltd, 28 Tai Seng Street , #06-02, Singapore 534106
- Signed by Mr. Mark Witsaman, Chief Technical Officer on 03 June 2013



SWG-125 Rev. G

June 2013

This page intentionally left blank.

Important Regulatory and Safety Information for i500-S3

Regulatory Information

Federal Communication Commission Notice

FCC Identifier: YC6-GLOBEI500S3BDE

USE CONDITIONS:

This device complies with part 15 of the FCC Rules. Operation is subject to the following two Conditions:

1. This device may not cause harmful interference, and
2. This device must accept any interference received, including interference that may cause undesired operation.

NOTE:

This equipment has been tested and found to comply with the limits for a Class B digital device, pursuant to Part 15 of the FCC Rules. These limits are designed to provide reasonable protection against harmful interference in a residential installation. This equipment generates, uses and can radiate radio frequency energy and, if not installed and used in accordance with the instructions, may cause harmful interference to radio communications. However, there is no guarantee that interference will not occur in a particular installation.

If this equipment does cause harmful interference to radio or television reception, which can be determined by turning the equipment off and on, the user is encouraged to try to correct the interference by one of the following measures:

- Reorient or relocate the receiving antenna.
- Increase the separation between the equipment and receiver.
- Connect the equipment into an outlet on a circuit different from that to which the receiver is connected.
- Consult the dealer or an experienced radio/TV technician for help.

IMPORTANT NOTE: EXPOSURE TO RADIO FREQUENCY RADIATION



SWG-125 Rev. G

June 2013

This Device complies with FCC & IC radiation exposure limits set forth for an uncontrolled environment. The Antenna used for this transmitter must be installed to provide a separation distance of at least 100cm from all persons and must not be co-located or operating in conjunction with any other antenna or transmitter

FCC CAUTION:

Any Changes or modifications not expressly approved by the manufacturer could void the user's authority, which is granted by FCC, to operate this Maritime Satellite Voice and Data Router

Eu Declaration of Conformity:

Globe wireless LLC, 1571 Robert J. Conlan Blvd. Palm Bay, FL 32905 declares under our sole responsibility that the Product, brand name as Globe wireless and model: Globe i250-S3 Maritime Satellite Voice and Data Router, to which this declaration relates, is in conformity with the following standards and/or other normative documents:

ETSI EN 301 444 V1.2.1:2012

ETSI EN 301 489-1 V1.9.2:2011

ETSI EN 301 489 -19 V1.2.1:2002

ETSI EN 301 489 -20 V1.2.1:2002

EN 60945:2002

EN 60950-1:2006+A11:2009+A1:2010+A12:2011

We hereby declare that all essential radio test suite have been carried out and that the above named product is in conformity to all the essential requirements of Directive 1999/5/EC.

The Conformity Assessment procedure referred to Article 10 and detailed in Annex [III] or [IV] of Directive 1999/5/EC has been followed with involvement of the following notified body(ies):

TIMCO ENGINEERING, INC., P.O BOX 370, NEW BERRY, FLORIDA 32669.



SWG-125 Rev. G

June 2013

Identification mark: 1177 (Notified Body number)

CE1177 

The technical documentation relevant to the above equipment is held at:

- Addvalue Communications Pte Ltd, 28 Tai Seng Street , #06-02, Singapore 534106
- Signed by Mr. Mark Witsaman, Chief Technical Officer on 03 June 2013



SWG-125 Rev. G

June 2013

This page intentionally left blank.

CE Certification Globe iS



PEP Certification Corp.

CERTIFICATE OF COMPLIANCE

Applicant : Globe Wireless, LLC.
Address : 1571 Robert J. Conlan Blvd. Palm Bay, Florida 32905
Model NO. : 100967
Type of Equipment : iS (prototype name iFusionS)
Report NO. : E13042502

EMC Standard:

EN55022 CLASS B: 2010	EN55024: 2010
EN61000-3-2: 2006+A1:2009+A2: 2009	IEC 61000-4-2 : 2008
EN61000-3-3: 2008	IEC 61000-4-3 : 2006+A1: 2007+A2:2010
	IEC 61000-4-4 : 2004+A1:2010
	IEC 61000-4-5 : 2005
	IEC 61000-4-6 : 2008
	IEC 61000-4-8 : 2009
	IEC 61000-4-11 : 2004

Deviation from Applicable Standard

According to the applicant's declaration this EUT is a class B product

The above equipment was tested by PEP Certification Corp. for compliance with the requirements set forth in the EUROPEAN COUNCIL Directive 2004/108/EC and the technical standards mentioned above. The results of testing in this report apply only to the product/system, which was tested. Other similar equipment will not necessarily produce the same results due to production tolerance.

Approved By:

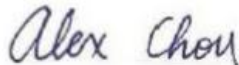

Alex Chou / Manager



Issued Date: MAY 17, 2013

FCC-Certification Globe iS



PEP Certification Corp. **FC**

CERTIFICATE OF COMPLIANCE

For the following equipment :

Equipment Under Test : iS (prototype name iFusionS)

Model Name: 100967

Applicant: Globe Wireless, LLC.
1571 Robert J. Conlan Blvd. Palm Bay, Florida 32905

Report No. : F13042502

Is here with confirmed to comply with the requirements set out in the FCC Rules and Regulations Part 15 Subpart B and CISPR PUB. 22 and the measurement procedures were according to ANSI C63.4-2003. The said equipment in the configuration described in this report shows the maximum emission levels emanating from equipment are within the compliance requirements.

FCC part 15 subpart B

Class B

The test was carried out on APR. 25, 2013 at PEP Certification Corp.

Taipei, Taiwan
(Place)

MAY 17, 2013
(Date)

Alex Chou / Manager
(Signature) Designation Number: TW1075



SWG-125 Rev. G

June 2013

Manual Organization

Instructions and graphics used in this manual may vary slightly depending upon each individual computer and Operating System being used.

Special Notations

This manual uses the following levels of special notation to alert the user to important information or useful tips for easier operation.

WARNING! A **WARNING** provides important information in the prevention of potential problems.

Note: Provides supplementary information to emphasize a point or procedure, or a tip for easier operation.

Customer Comments

Globe Wireless is *ISO Certified*, and is committed to quality and total customer satisfaction. Customer comments are important to us and help us to provide quality products and services. We invite emails from satisfied customers as well as comments and recommendations for improvement.

Email comments and suggestions to: quality@globewireless.com

For further assistance, contact the **Globe Wireless Customer Service Center** at:

Within the United States or Canada: 1-(877)-535-0653

Overseas: 1-(321)-308-0112

customerservice@globewireless.com

www.globewireless.com



SWG-125 Rev. G

June 2013

This page intentionally left blank.

1.0 Introduction

The **Globe iFusion®** Maritime Satellite Voice and Data Router provides a connection for multiple computers, network devices, fax machines, telephones and mobile phones to access both the Internet and voice/text services through a built-in Inmarsat FleetBroadband 250 Satellite Terminal. It also makes use of other broadband network access services your vessel may have by automatically selecting the best route for your data in the changing conditions of your vessel's operation. The broadband access options include but are not limited to other FleetBroadband terminals, VSAT, Iridium OpenPort, GSM, and Wired and Wireless connections available in port.

1.1 Key Features

The **Globe iFusion®** is an integration of several subsystems into a single, rack-mountable product. These sub-systems are normally complete systems, but within the **Globe iFusion®** they are highly integrated and function as a single system. These include an Inmarsat FleetBroadband 250 terminal, a GSM mobile phone call router, an IP network router, firewall, proxy, and email system. Tying these services together is a web application which provides users with email and web browsing.

<p>IP Router</p> <ul style="list-style-type: none"> • IP Satellite Gateway (External) <ul style="list-style-type: none"> • Built-In FleetBroadband 250 • As many as 10 additional external IP satellite systems 	<p>Prepaid Platform</p> <ul style="list-style-type: none"> • GSM and SMS • Direct voice • Email
<ul style="list-style-type: none"> • Shipboard Network (Internal) <ul style="list-style-type: none"> • Up to 4 PCs can connect directly • Additional PCs can connect using a switch 	<p>Web and IP Acceleration</p> <ul style="list-style-type: none"> • Web proxy for browsing control • Web acceleration <ul style="list-style-type: none"> • Image downsizing • Compression • Shipboard cache • Mobile Browser Emulation
<p>GlobeVoice Gateway</p> <ul style="list-style-type: none"> • Prepaid and Postpaid in a single platform • GSM and telephone hard line access <p>Call routing over any satellite system</p>	

1.1.1 IP Router

Aside from the built-in FleetBroadband 250, the **Globe iFusion®** also has 3 WAN ports which allow immediate expansion to accommodate other network gateways available on the vessel. With the use

of a network switch (not included) this can be increased to 10. Each gateway can serve as the primary or an alternate means of connecting to the Internet.

The shipboard users can connect up to four PCs directly to the four LAN ports of the **Globe iFusion®**. If more devices are needed this can be expanded as well with a network switch (not included). Using the full-featured routing and firewall functions of the **Globe iFusion®**, these LAN users can access any Internet service to which they have been given permission.

1.1.2 GlobeVoice

Voice and Fax calls can be made with standard telephones and fax machines by connecting these devices to the designated ports on the back of the **Globe iFusion®**. There is also an optional handset and handset port for those who wish to make calls directly from the **Globe iFusion®**.

Another voice communication service is the prepaid GSM mobile phone user. Included with every **Globe iFusion®** is a **Globe Mobile Antenna** which provides cellular voice and text services to mobile phones on the vessel even while at sea. These calls can be routed either over a standard satellite terminal or via the Voice over IP (VOIP) service. A Globe Wireless SIM card and an unlocked mobile phone are all you need to get started.

1.1.3 Email

Users of prepaid voice services also have access to individual, prepaid email accounts which deduct from the same account. This email account can be used either from the **Globe iFusion®** web email application or from a standard email client such as Microsoft Outlook. The **Globe iFusion®** supports SMTP and IMAP4 client interfaces.

1.1.4 Web Browsing

The **Globe iFusion®** has a very advanced solution for web browsing in the maritime world. It incorporates four different levels of web compression and cost reduction.

Text and large data are compressed using standard compression tools before sending them to the vessel.

Images are down-sampled to reduce their size.

Web sites are cached locally to avoid retrieving them multiple times.

Mobile browser emulation provides an option for viewing the mobile versions of web pages even when using Internet Explorer.

This last feature is unique and cuts through all of the normal advertising and extraneous images and large files that most websites contain. Instead, the user, though he is using a full-fledged web browser, arrives at the much reduced mobile web site if one exists. This saves both time in



SWG-125 Rev. G

June 2013

downloading and cost in bytes transferred. This is an excellent option for vessels with several people browsing at the same time.

1.2 Shore Control

All of the main functions of the **Globe iFusion®** can be configured from shore using the **Globe iPortal** web application. Changes made on the shore or the ship will be automatically shared and synchronized. The system offers user based access control and shipboard users can be permitted or restricted from accessing the email and the web. All user controls are fully configured from shore by customer IT staff.

For further assistance, contact the **Globe Wireless Customer Service Center** at:

Within the United States or Canada: 1-(877)-535-0653

Overseas: 1-(321)-308-0112

1.3 Globe *iFusion*® Overview Diagram

This unit supports the following:

- Simultaneous voice and data over FleetBroadband
- Full duplex, single or multi-user up to 284kbps
- Support for streaming IP at 32, 64, 128 kbps
- Standard Voice (AMBE+2, 4.0 kbps)
- Fax/High Quality Voice (64kbps, A-law PCM)

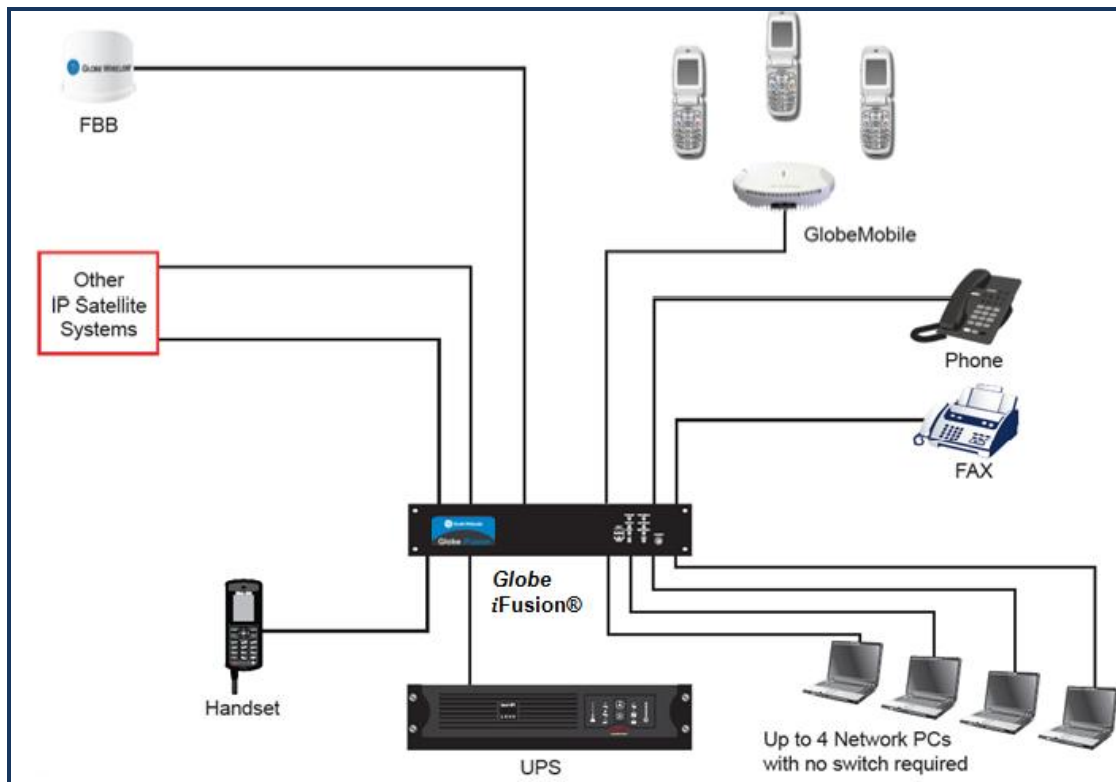

1.4 Package Contents

The following is a list of items in the **Globe *iFusion*®** package:

- **Globe *iFusion*®** BDU
- Antenna ADU
- Base Transceiver Station
- (30 meters) LMR-400 coaxial antenna cable with connectors

- LMR-400 N-type connector
- Cable Gland
- Grounding Strap
- Antenna Mounting Clamps
- (2x5 ft.) copper bus
- Accessory kit
- Goop kit with SS strap
- (250 ft.) Spool of CAT5E Network Cable
- (6) RJ-45 connectors
- FBB250 Mast Mount
- (3 ft.) jumper cable
- Globe Wireless FBB SIM card
- (20) GlobeMobile SIM cards
- USB Thumb Drive
- Rack Rails
- Front and Rear bulkhead mounts
- Bag of hardware

1.5 Installation of the Globe *iFusion*®

The **Globe *iFusion*®** is to be installed onboard ship in a control room into a Rack Cabinet or by mounting on the wall, shelf, or table as described below.

1.5.1 Installing the Globe *iFusion*® into 19" High Profile Rack Cabinet

The **Globe *iFusion*®** is designed to be inserted into a 19" Rack Cabinet. The 2U front panel has four holes used to secure the enclosure case into the cabinet by means of two (2) M5x20mm screws for the front of the cabinet and two (2) M5x12mm screws for the back of the cabinet. In addition, two handles are included on the front panel allowing the case to be carried with ease.

Important! Ensure you use the 12mm screws on the back of the cabinet. Using the 20mm screws on the back of the cabinet will damage the components inside.

Two long mounting brackets are mounted on each side of the enclosure case so that the end of each bracket can be secured to the rear rails of the cabinet. Additional slots along the mounting bracket are for different depth cabinets.

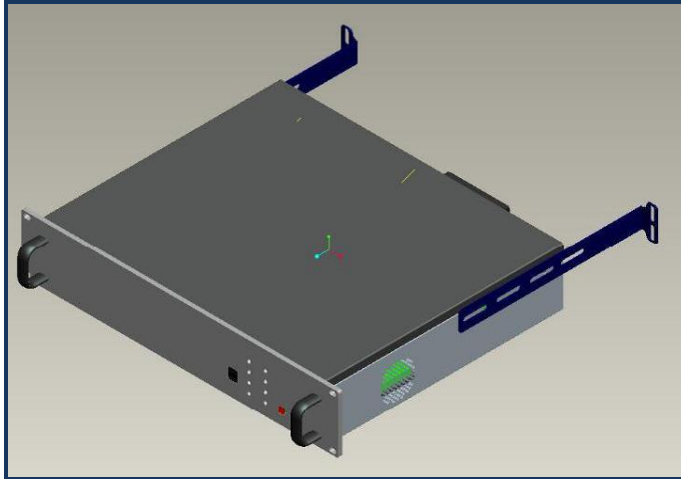

1.5.2 Installing the Globe *iFusion*® onto Wall, Shelf or Table

Four small mounting adaptors are attached at each corner of the enclosure case allowing them to be mounted onto a wall, shelf or table with four M5x12mm self-tapping screws.

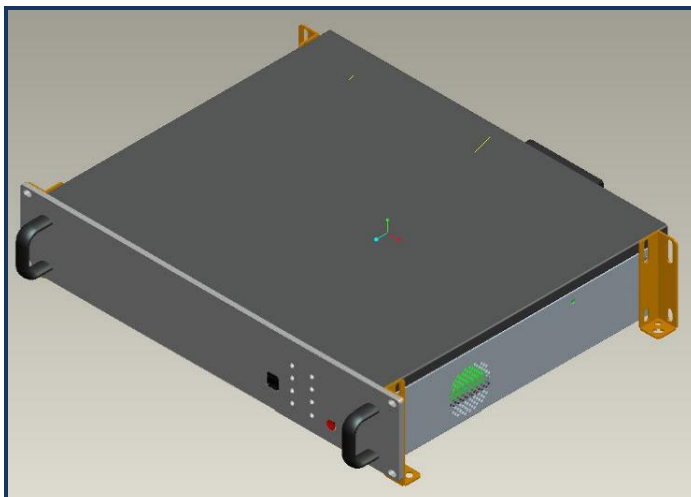

2.0 Getting to Know the Globe *iFusion*®

This section describes all the components on the **Front** and **Rear** panels of the **Globe *iFusion*®**.

Note: Technical specifications of the **Globe *iFusion*®** system are located in [Appendix D](#).

2.1 The Globe *iFusion*® Front Panel – *i250*, *i500*, and *iS*

The following three graphics depict the front panel of the **Globe *iFusion*®** *i250*, *i500*, and *iS*, respectively:

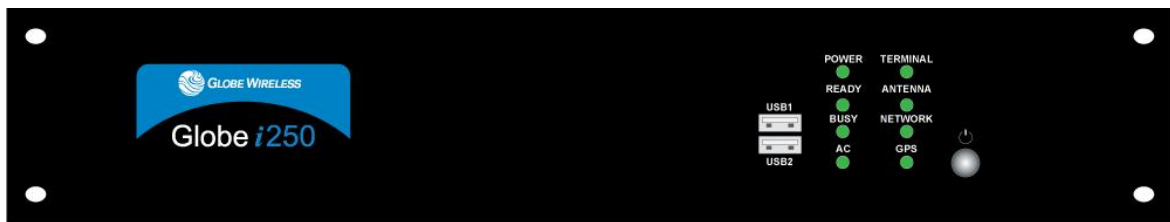

Front Panel for Globe *iFusion*® *i250*

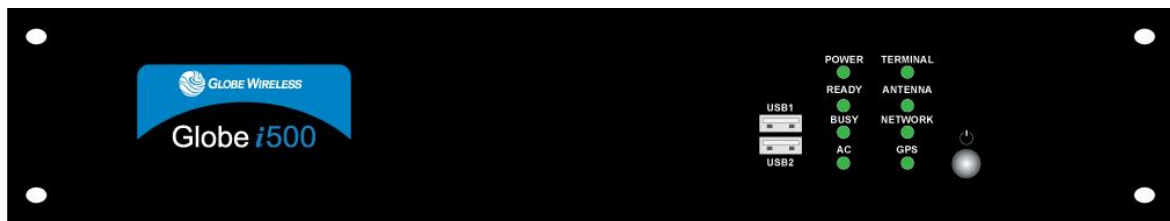

Front Panel for Globe *iFusion*® *i500*



Front Panel for Globe *iFusion*® *iS*

The following is an enlarged view of the components on the *right front panel* of the **Globe iFusion®** i250, i500, and iS:

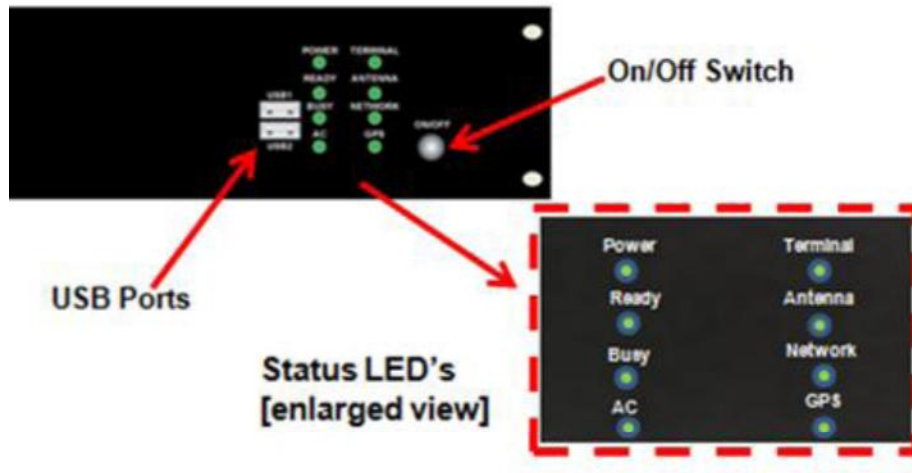

The front panel of the **Globe iFusion®** consists of the following components:

Name	Description	
On/Off Switch	Powers the Globe iFusion® on / off.	
2 USB Ports	For use of USB flash drives which install and update the system software.	
Status LED's	<ul style="list-style-type: none"> • Power • Ready • Busy • AC 	<ul style="list-style-type: none"> • Terminal • Antenna • Network • GPS

2.2 LED Operation

The following subsections describe the **Status LED's** located on the front panel of the **Globe iFusion®**.

2.2.1 POWER LED

The **POWER** lamp indicates that the components of the **Globe iFusion®** have power and are operating.

2.2.2 READY LED

The **READY** lamp is used primarily to indicate the ability of the **Globe iFusion®** to make data connections to the Globe Wireless Network. The color and the blink state have different meanings.

Mode	LED	Description
Initial Boot	Short AMBER Long AMBER	When booting, the Ready LED will display a series of flashes to indicate this state. A short amber colored flash followed by a long amber colored flash indicates that the operating system has just started to load.
Globe <i>iFusion</i> ® Services	Long AMBER	When the flashing changes to only a long amber flash, the Globe iFusion ® has successfully booted its operating system and is now starting up the processes which provide communication.
Normal Operation	Long GREEN <i>followed by (for each gateway):</i> Short GREEN <i>if connected</i> Short AMBER <i>if disconnected</i> Short RED <i>if in Safe Mode</i>	<p>During normal operating, the Ready LED will give one long green flash followed by one or more short flashes for each configured gateway. The color of the short flash indicates where a data connection is currently available on that gateway. Green means the data connection is up and amber means that it is down.</p> <p>At the end of the sequence of short flashes the Ready LED will flash red to indicate that the Globe iFusion® is currently in Safe Mode.</p>
Shutdown	AMBER RED AMBER	The Ready LED will begin alternating between amber and red when the shutdown sequence has begun. The shutdown sequence lasts about three (3) minutes.
Disabled	RED	If for any reason the SIM card in the Globe iFusion ® cannot be used, the Ready LED will flash red. This could indicate that the SIM is not properly activated, or that it is seated incorrectly in the SIM card reader.

2.2.3 BUSY LED

The **BUSY** lamp will flash periodically when the main operating system of the **Globe iFusion®** is reading or writing to its internal hard drive. The nominal state of this lamp is to flash. A non-flashing lamp indicates there may be a problem.

2.2.4 AC LED

The **AC** lamp indicates that the **Globe iFusion®** has been plugged into a working power outlet.

Note: The AC lamp does not indicate that the **Globe iFusion®** is powered on. Refer to the description of the **POWER** LED (Section 5.2.1).

2.2.5 TERMINAL LED

The **TERMINAL** lamp indicates the operational state of the FleetBroadband terminal and has the following indications:

Mode	LED	Description
Power-Up	AMBER	This indicates that the FleetBroadband terminal is powering up.
Error	RED	A failure has occurred in the FleetBroadband terminal.
Shutdown	Blinking AMBER	The FleetBroadband terminal is being powered down.
Normal	GREEN	The FleetBroadband is fully operational.

2.2.6 ANTENNA LED

The **ANTENNA** lamp has the following indications:

Mode	LED	Description
Power Up	AMBER	This indicates that the antenna has recently received power or that it is currently calibrating itself.
Error	RED	The antenna has failed to operate as intended and should be inspected for damage to itself or the cable.
Searching	Blinking AMBER	The antenna is attempting to locate a satellite.

Mode	LED	Description
Weak Signal	Blinking GREEN	A satellite has been found but the signal is weak.
Connected	GREEN	The antenna has found and locked onto the selected satellite.

2.2.7 NETWORK LED

The **NETWORK** lamp has the following indications:

Mode	LED	Description
Registering	AMBER	The FleetBroadband terminal is attempting to register on the Inmarsat network.
Error	RED	There was an error attempting to register on the Inmarsat network.
Voice Ready	Blinking AMBER	The FleetBroadband terminal has registered on the network and can make voice calls using the phone port or corded handset.
Data Ready	Blinking GREEN	The FleetBroadband terminal has been authenticated for voice and data communication through Globe Wireless.
Connected	GREEN	The primary <i>Packet Data Protocol (PDP)</i> context is now active and data connections are possible to Globe Wireless and the Internet.

2.2.8 GPS LED

The **GPS** lamp is **GREEN** when a GPS fix has been achieved by the Antenna GPS unit.

Mode	LED	Description
Acquiring GPS	AMBER	The GPS is using a stored GPS position and is actively seeking a new fix.
Error	RED	There was an error attempting to read data from the GPS.
GPS Fix	GREEN	The GPS has acquired its position and is transmitting periodically updated location information.

2.3 The Globe *iFusion*® Rear panel for *i250*, and *i500*

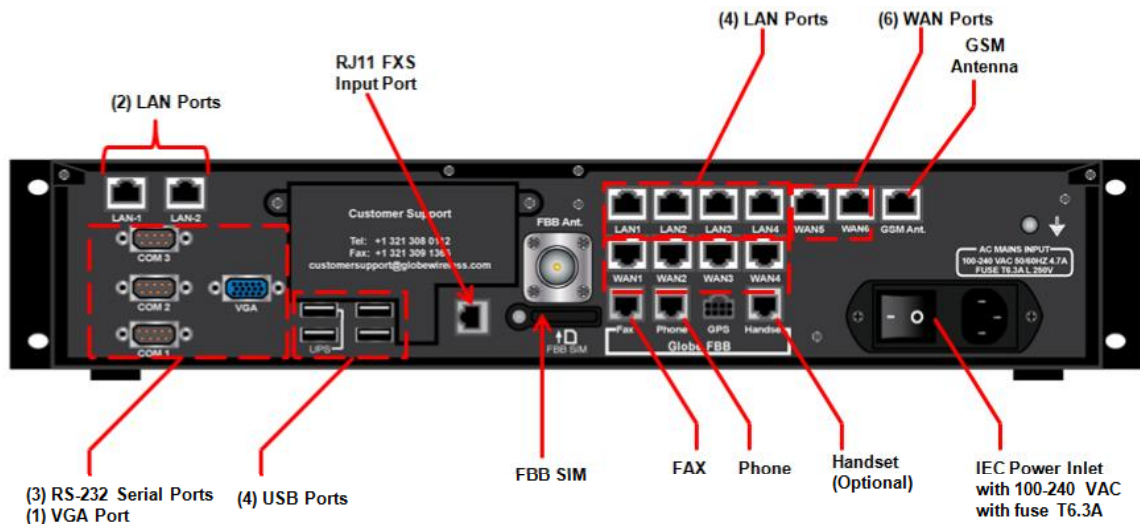

Name	Description
(2) LAN Ports	For Shipboard PCs, switches, routers, and servers.
RJ11 FXS Input Port	Allows prepaid users to make voice calls without using the GSM subsystem.
(4) LAN Ports	For Shipboard PCs, switches, routers, and servers.
(6) WAN Ports	For connecting to other IP gateways and satellite terminals.
GSM Antenna	Connects the GSM Antenna.
(3) RS-232 Serial Ports	For adding additional devices requiring serial port connection.
4 USB Ports	For adding additional devices requiring USB port connection.
FBB SIM	Location where the FBB SIM card is inserted.
FAX Port	Provides fax connection services for shipboard fax machines.
Phone Port	Connects the system for use by a PBX or standard telephone.
Handset Port	For installation of an FBB250 handset.

2.4 The Globe *iFusion*® Rear panel for *iS*

The following graphic depicts the rear panel of the Globe *iFusion* for *iS*.

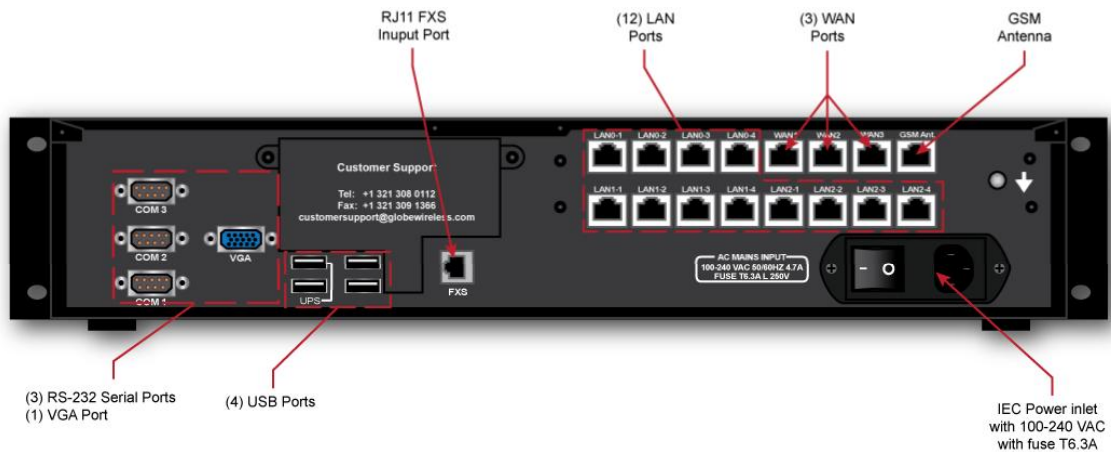

RJ11 FXS Input Port	Allows prepaid users to make voice calls without using the GSM subsystem.
(12) LAN Ports	For Shipboard PCs, switches, routers, and servers.
(3) WAN Ports	For connecting to other IP gateways and satellite terminals.
GSM Antenna	Connects the GSM Antenna.
(3) RS-232 Serial Ports	For adding additional devices requiring serial port connection.
4 USB Ports	For adding additional devices requiring USB port connection.



SWG-125 Rev. G

June 2013

This page intentionally left blank.

3.0 Fixed Multiple Lines

3.1 Introduction

Your Globe *iFusion*® system can act as a PBX for voice calls using Polycom Voice over IP (VoIP) phones. This service is called **Fixed Multiple Lines** and provides PIN entry control over the Globe *iFusion*® shipboard phone system and adds many calling features beyond those of a standard satellite terminal.

3.2 Features

The features of the Fixed Multiple Lines option are as follows:

- Up to nine (9) VoIP phone extensions may be deployed throughout the ship
- Each extension may be reached from shore using a phone number with the country code prefix of choice
- A white list determines the phone numbers your crew can dial without the use of a PIN
- Prepaid users can enter their own PINs to pay for and make calls from VoIP phones
- The VoIP phones support Call Transfer, Hold, and Conferencing features

Note: 4-digit PIN codes are required for calling from ship-to-shore.

All settings for a VoIP phone, such as name, extension, and phone number are controlled by the customer using the Globe *iPortal*® Website. Features of the Fixed Multiple Lines service and Polycom VoIP phones are discussed in the following sub-sections.

3.3 Features of the PolyCom Phone





Refer to the above diagram and corresponding numbered items for an overview of the phone's features.







Note: At this time, one line only is supported; headsets are not supported; therefore, are not supplied with the phone.

1. **Message Waiting Indicator** – Light alerts you to incoming calls and new voicemail.
2. **Line Icons** – Visual displays let you know the status of the lines.

- * Registered line 



*A registered line is a line that has been pre-configured by the System Administrator.

- Registered shared line 
- Unregistered line 
- Voice Mail/Messages  (Voice mail not supported at this time)

- Speed-Dial 
 - Ringing 
 - Call in progress/ Conference 
 - Call Forward  (*not supported*)
 - Do Not Disturb 
 - Presence/BLF (Busy Lamp Field) 
3. **Softkeys** – Perform functions as shown on the LCD Screen. (Described in more detail within this guide.)
 4. **Line Indicators** – Multicolor LEDs display the call state of Line 1 and Line 2:
 - **Solid Green** – Active call
 - **Flashing Green** – Incoming call
 - **Flashing Red** – Call is on hold
 5. **Line 1 and Line 2 Keys** – Use to access the line on which you are receiving or making a call. Only single line (line 1) is supported at this time.
 6. **Hold Button** – Push to put an active call on hold. Push again to take the call off of hold.
 7. **Headset Button** – Not supported.
 8. **Speakerphone Button** – Click to *place*, *receive*, or *switch* the current call to the speaker phone.
 9. **Microphone** – Location of the microphone for the hands-free speakerphone.
 10. **Volume Buttons** – Press to adjust the volume of the handset, speaker, and ringer.
 11. **Mute Button** – Press to mute the audio during a call.
 12. **Dial Pad** – Use to dial a telephone number.
 13. **Feature Keys** –
 - **Dial Button** – Press to dial the entered phone number or to access the *Placed Calls* list

- **Menu Button** – Press to enter the phone's menu
14. **Control arrow keys** – Scroll through display menus. Use the checkmark to *select*.
 15. **Speaker** – For ringer and hands free speakerphone output.
 16. **Graphic Display** – Displays information regarding calls, messages, soft keys, time, date, etc.

3.4 Navigate through Menus

- Press  to enter the basic settings menu or to exit from any menu.
- Press  and  to scroll through the menu lists.

Note: Press * to page up and # to page down. These shortcuts do not work in the Contact Directory. After 20 seconds of inactivity, the menu system will automatically exit to the idle display unless an edit session is in progress.

- Use the keypad to make selections in numbered menu lists

3.5 Configure Basic Settings

Press  and then select **Settings | Basic** to configure the following basic settings:

- Appearance of the time and date
- Display contrast
- Ring type
- Language support
- Directory search

3.5.1 Time and Date

The time and date appears on the graphic display of the phone. You have control over the format of the time and date display and can turn the display of time and date off. The default time and date format appears in the following figure.

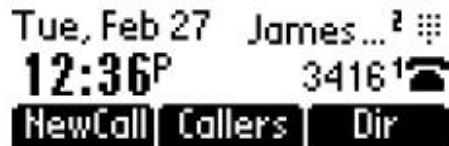

Step 1: Select **Settings | Basic | Preferences | Time & Date**.

Step 2: Select from Clock Date, Clock Time, Clock Order, or Enable/Disable.

Step 3: Press  and  to scroll through the options.



Step 4: Press  to confirm your choice.

Step 5: Press  or  repeatedly to return to the idle display.

3.5.2 Display Contrast



Step 1: Select **Settings | Basic | Contrast**.

Step 2: Press  and  to increase or decrease the display contrast.

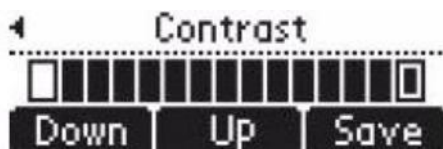

Step 3: Press **Save** to accept changes or  to cancel changes.



Step 4: Press  or  repeatedly to return to the idle display.

3.5.3 Ring Type

You can select from the different ring types to distinguish between lines or to have a different ring from other phones near you. You can also set distinctive incoming ringing tones for contacts in your local directory.

Press 

Select **Settings | Basic | Ring Type**.

Step 1: (Optional) If multiple lines are configured on your phone, first select the line to change from the list using  and .

Step 2: Use  and  to select the desired ring type.



Step 3: Press Play to hear the selected ring type.

Step 4: Press Select to change to the selected ring type.

Step 5: Press  or  repeatedly to return to the idle display.

3.5.4 Language Support

Press 

Step 1: Select **Settings | Basic | Preferences | Language**.



Step 2: Scroll through the list of available languages.

Step 3: Press  to confirm your choice. Text on the graphic display will change to the language selected.

Step 4: Press  or  repeatedly to return to the idle display.



3.5.5 Directory Search

You can configure how the search of the local contact directory is performed. The local contact directory can be searched by first or last name.

Press 

Step 1: Select **Settings | Basic | Preferences | Directory Search**.



Step 2: Use  and  to select the directory search parameter.

Step 3: Press  to confirm your choice.

Step 4: Press the **Yes** or **Cancel** key to accept or cancel changes.

3.6 Manage Contacts

You can enter 99 contacts in your local contact directory.

3.6.1 Adding Contacts

New entries to the local contact directory are added to the top of the list.

Step 1: Press the **Dir** soft key.

Step 2: Select the local contact directory by pressing  if it does not appear automatically.

Step 3: Press . The Directory screen displays **<New Entry>** displays at the top of the list.



Step 4: Press  to add a new entry.

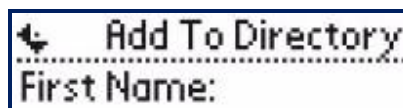

Step 5: Press  to enter a first name.

Step 6: Enter the first name of the contact from the dial pad.



Step 7: Press the **OK** or **Cancel** soft keys to accept or cancel.

Step 8: Press  to display the next field in the contact's entry.

Step 9: Repeat the steps to enter the last name of the contact.

Step 10: Repeat the steps to enter a contact number.

Note: This is a required field and must be unique (not already in the directory). Entry to this field is denoted by **1 2 3**.



Step 11: Press  to end data entry to contact's.





Step 12: Press the **Yes** or **Cancel** soft keys to accept or cancel.

Step 13: Press  repeatedly to return to the idle display.

3.6.2 Deleting Contacts

Step 1: Press the **Dir** soft key.

Step 2: Select the local contact directory by pressing  if it does not appear automatically.

Step 3: Press  and  to scroll through the list to locate the contact you wish to delete.



Step 4: Press the **Delete** soft key to delete the displayed contact from the directory.



Step 5: Press  repeatedly to return to the idle display.

3.6.3 Placing a Call to a contact

To place a call to a contact in the local contact directory, perform the following:

Step 1: Press the **Dir** soft key.

Step 2: Select the local contact directory by pressing  if it does not appear automatically.

Step 3: Press  and  to scroll through the list to locate the contact you wish to call.



Step 4: Press  or lift the handset.

3.7 Using Basic Features of your phone

Your phone is designed to be used like a regular phone on a public switched telephone network (PSTN). This section will address the following features of the phone:

- Placing a Call
- Answering a Call
- Ending a Call
- Placing a Call on Hold
- Setting Up Conference Calls
- Transferring Calls
- Do Not Disturb

3.7.1 Placing a Call





You can place a call using the handset, speakerphone,  button, or the  button. (Line 2 is not supported.) You can also dial the number first, and then choose the method you will use to speak to the other party.

During a call, you can alternate between the **Handset** by using the handset, or Hands-Free **Speakerphone** by pressing .

Place a call using the Handset

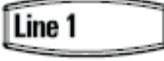



- Pick up the handset.
- Dial the number using the dial pad.

Place a Hands Free call

- With the handset in the cradle, press ,  or  to obtain a dial tone.
- Dial the number using the dial pad and press , , or .

Place a call using the Dial Key

Do one of the following steps:

- Press the **Callers** soft key to view the **Receive Call list**
- Press  to view the **Placed Call list**
- Press  and  to scroll through the list to find the contact
- Press  to complete the call.

3.7.2 Answering a Call

Incoming calls may be ignored by pressing the **Reject** soft key (for private lines) or the **Ignore** soft key (for private and shared lines).



3.7.2.1 Answer when NOT on another call

Using the Handset

Answer the call by simply picking up the handset.

Hands-free Speakerphone

Answer using one of the following steps:



- Press 
- With the handset on-hook, press  where the line status indicator is flashing green
- Press the Answer soft key

3.7.2.2 Answer when on another call

Phone configured for a Single Line Key

The second call *may* cause a call waiting tone to be played and the display of the call waiting prompt identifying the incoming callers for 10-seconds only. You can choose to ignore the call, answer the call, or reject the call (if a private line).

After this (10-seconds) point, the user will need to scroll to the incoming call in order to answer as follows:

- Press  to place the original call on hold.
- Press  to access the new call.

Note: Soft key labels are updated on the display showing **Ignore**, **Answer**, and **Reject**.

Phone configured for Shared Lines

The only difference between a shared line and private line is that there is no **Reject** soft key and that another person on the shared line might answer the call.

3.7.3 Ending a Call

Perform one of the following to end a call:

- Press the **End Call** soft key
- Replace the handset
- Press  if in Hands-free Speakerphone Mode

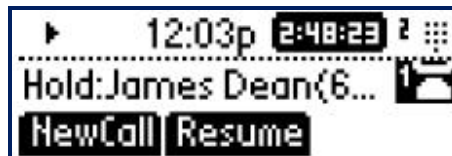

3.7.4 Placing a Call on Hold

- During the call, press  which will be indicated on the graphic display by the hold icon



- To resume the call, press the **Resume** soft key or the **hold** button again

Note: Since using the Hold feature typically generates music or beeps, avoid placing a **conference call** on hold.

- If you have multiple calls on hold, use  and  to switch between the calls, then press the Resume soft key to retrieve the desired call

If two or more calls are on hold, an indication appears on the graphic display, e.g., '3/4', indicates that this is the third call out of four calls.



3.7.5 Setting up Conference Calls

You can create a conference with other parties using the phone's local conference feature as follows:

Step 1: Call the first party.

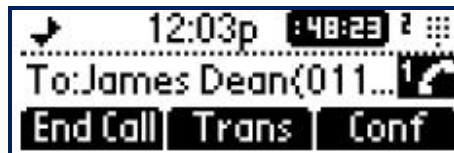

Step 2: Press the **Conf** soft key to create a new call. (The active call is placed on hold.)



Step 3: Call the second party.

Step 4: When the second party answers, press the **Conf** soft key again to join all parties in the conference.

To Split a conference call:

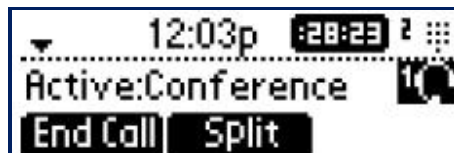

Press the **Split** soft key. This places both parties on hold.



Set up a Conference Call

When you are in an active call, perform the following to add members:

One call on hold:

- If you have **one call on hold**, press  to return to the call on hold, and then press the **Join** soft key.
 - (1) This creates a conference call with the active call, the call on hold, and yourself.

Multiple calls on hold:

- If you have **multiple calls on hold**, use  and  to switch to the desired call on hold and press the **Join** soft key.
 - (2) This creates a conference call with the active call, the call on hold, and yourself.

To End a Conference Call

Press the **End Call** soft key, or simply hang up. The other parties will continue to be connected.

3.7.6 Transferring Calls

There are three ways to transfer a call:

- **Consultative Transfer** – The party to whom you wish to transfer the call answers their phone before you transfer the call or hang up. You can consult with them before completing the transfer.
- **Blind Transfer** – The call is automatically transferred after you dial the number of the party to whom you wish to transfer the call.
- **Attended Transfer** – The parties are automatically connected to each other after you exit the conference.

Consultative Transfer

Step 1: During a call, press the **Trans** soft key. The active call is placed on hold.

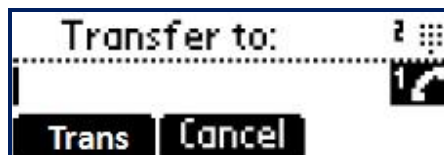

Step 2: Enter the number to which you want to transfer the call.

Step 3: As soon as the ring-back sound is heard, or after the party answers, press the **Trans** soft key to complete the transfer.

- You can talk privately to the party to which you are transferring the call before the transfer is completed, if desired.
- If you are using a handset, the transfer can be completed by putting the handset on the cradle.
- You can cancel the transfer before the call connects by pressing the **Cancel** soft key.

Blind Transfer



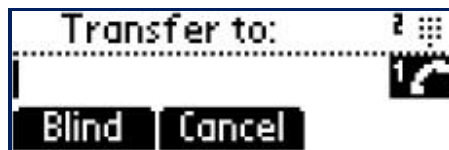

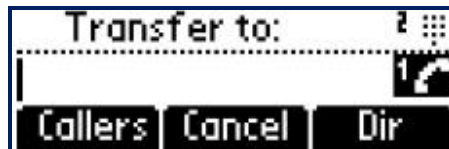

Step 1: During a call, press the **Trans** soft key.



Step 2: Press the **Blind** soft key.



Step 3: Do ONE of the following steps:

- Enter the number to which you want to transfer the call
- Press the **Dir** soft key to access the local contact directory. Use  and  to access the contacts, and then press .
- Press the **Callers** soft key to access the Received Call List and use  and  to access the contact, and then press .

Attended Transfer

The parties are automatically connected to each other once you hang up.

3.7.7 Do Not Disturb

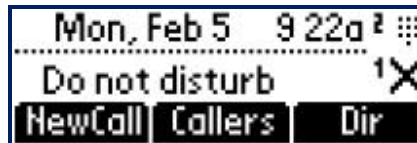

Step 1: To **Enable** Do Not Disturb, press  and select **Features | Do Not Disturb** to prevent the phone from ringing on incoming calls.

A flashing icon and text on the graphic display indicates that **Do Not Disturb** is turned on.



Step 2: To **Disable** Do Not Disturb, press  and select **Features | Do Not Disturb**.

Note: **Do not disturb** is local to the phone itself, and may be overridden by call server settings. Contact your System Administrator for more information.

Step 3: To **configure multiple lines** for Do Not Disturb, use  and  to set Do Not Disturb on a line-by-line basis using the same instructions as above.

3.8 Troubleshooting Your Phone

This section contains general troubleshooting information to help you solve any problems you might encounter with your phone. The tables subsection list possible trouble symptoms, the likely causes of these problems, and the recommended corrective actions to take.

- Securing the Handset
- Controls
- Access to Screens and Systems
- Calling
- Displays

To obtain more detailed troubleshooting information, you can access certain menus on your phone that test your phone hardware.

3.8.1 Securing the Handset on-hook

Due to ship vibration, etc., the handset can become dislodged from the phone.

To prevent this from happening, perform the following steps to change the *phone hook tab* to the secured position.

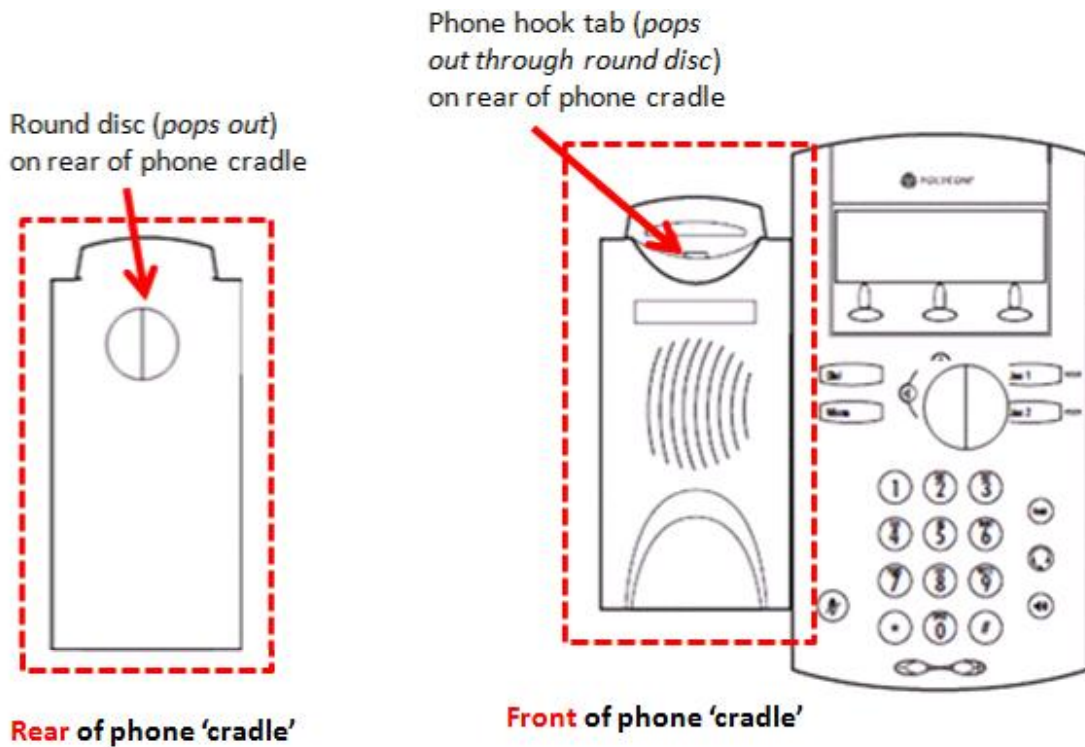

When you remove the handset from the cradle of the phone, notice a tab. If the tab is flush (flat) against the cradle, you must change it; however if it protrudes from the opening, you need do nothing, as it is already set-up to hold the handset securely in place when resting in the cradle of the phone.

Changing the Phone Hook Tab

- From the front of the phone, use a pointed object such as a ball point pen or small screwdriver to **push the tab out** from the front through the rear of the phone.

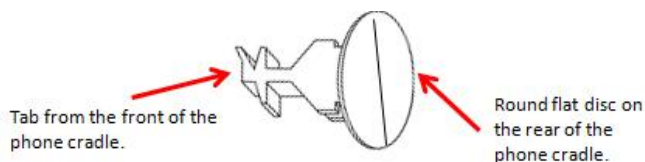
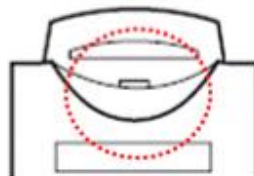

- The unit pops out all as one piece as shown above.
- Manipulating the piece just removed, re-insert it back through the

hole on the rear of the cradle so that when the tab comes through the front, the tab is protruding and not flush or flat against the phone cradle.

- When positioned correctly, push on the round disc from the rear of the phone to snap it into place.

The phone is now secured to the cradle and should not slip off due to ship vibration.

For further assistance, contact the **Globe Wireless Customer Support Center** at:

Within the United States or Canada: 1-(877)-535-0653

Overseas: 1-(321)-308-0112

3.8.2 Controls

Symptom	Problem	Corrective Action
The dial pad does not work.	The dial pad on the phone does not respond.	Do one of the following: <ul style="list-style-type: none"> • Check for a response from other feature keys or from the dial pad. • Place a call to the phone from a known working telephone. Check for display updates. • Check if the LAN port is active or inactive. Press the Menu key, and select Status Network Ethernet. From the Ethernet page, scroll to the LAN port field and verify it is active. • Check the termination at the switch or hub end of the network LAN cable. Ensure the switch/hub port connected to the telephone is operational. (If not, contact your system administrator.) • Before restarting the phone, contact your system administrator who may want to troubleshoot your phone in more detail before restarting the phone and losing current status information.

3.8.3 Access to Screens and Systems

Symptom	Problem	Corrective Action
There is no response when you press a feature key.	The phone is not in an <i>active</i> state.	Do one of the following: <ul style="list-style-type: none"> • Press the keys more slowly. • Check with your system administrator to see if the key has been mapped to a different function or is disabled. • Place a call to the phone to check that inbound call display and ringing is normal. If successful, try to press feature keys within the call to access the Main Menu, for example. • To confirm that the line is active, press the Menu key and then select Status Lines Line Information. From the Line Information page, verify your phone line is registered.
The screen shows " <i>Network Link is Down</i> ".	The LAN cable is not properly connected.	Do one of the following: <ul style="list-style-type: none"> • Check termination at the switch or hub (furthest end of the cable from the phone). • Check that the switch or hub is operational (flashing link/status lights) or contact your system administrator. • Check if the LAN port is active or inactive. Press the Menu key and select Status Network Ethernet. From the Ethernet page, scroll to the LAN port field and verify it is active. • To attempt re-registration to the call server, reboot your phone. Contact your system administrator.

3.8.4 Calling

Symptom	Problem	Corrective Action
There is no dial tone.	Power is not correctly applied to the phone.	Do one of the following: <ul style="list-style-type: none"> • Check that the screen is illuminated. • Ensure the LAN cable is inserted properly at the back of the phone by unplugging and re-inserting. • If using PoE, have your system administrator check that the switch is supplying power to the phone.
	Dial tone is not present on one of the audio modes.	Do one of the following: <ul style="list-style-type: none"> • Switch between Handset and hands free speakerphone to see if the dial tone is present for one of the audio modes. • If the dial tone exists on another audio mode, connect a different handset to isolate the problem.
The phone does not ring.	Ring setting or volume is low.	Do one of the following: <ul style="list-style-type: none"> • Adjust the ringing level from the front panel using the volume up/down keys. • Check status of the handset and hands free speaker phone.
	Outbound or inbound calling is unsuccessful.	Do one of the following: <ul style="list-style-type: none"> • Place a call to the phone under investigation. Check that the screen indicates incoming call information. • Lift the handset. Ensure the dial tone is present and place a call to another extension or number. Check that the screen changes in response.
	You turned off the ringer.	Do one of the following: <ul style="list-style-type: none"> • During an incoming call, lift the handset and press the Speaker phone key to obtain a dial tone. • Press the ringing Line Key or the Answer soft key

Symptom	Problem	Corrective Action
		to answer the call.
“Service Unavailable” appears on the screen.	The user pressed the New Call soft key, dialed a number with the handset on-hook, or attempted to make a call from the contact directory before the phone was registered.	Check with your system administrator to see when your phone will be registered.

3.8.5 Displays

Symptom	Problem	Corrective Action
There is no display. The display is incorrect. The display has bad contrast.	Power is not correctly applied to the phone.	Do one of the following: <ul style="list-style-type: none"> • Check that the screen is illuminated. • Ensure the LAN cable is inserted properly at the back of the phone by unplugging and re-inserting the cable. • If using Power over Ethernet (PoE), have your system administrator check that the switch is supplying power to the phone.
	The contrast needs adjustment.	Do one of the following: <ul style="list-style-type: none"> • Restart the phone to obtain a default level of contrast.
	Outbound or inbound calling is unsuccessful.	Do one of the following: <ul style="list-style-type: none"> • Place a call to the phone under investigation. Check that the screen indicates incoming call information. • Lift the handset. Ensure the dial tone is present and place a call to another extension or number. Check that the screen changes in response.
The display flickers.	A certain type of older fluorescent lighting	Do one of the following:



SWG-125 Rev. G

June 2013

Symptom	Problem	Corrective Action
	causes the display to appear to flicker.	<ul style="list-style-type: none">• Move the phone away from the lights.• Replace the lights.

For further assistance, contact the **Globe Wireless Customer Support Center** at:

Within the United States or Canada: 1-(877)-535-0653

Overseas: 1-(321)-308-0112



SWG-125 Rev. G

June 2013

This page intentionally left blank.

4.0 Using a Standard Phone

Desk phones, PBX systems, and other touch-tone voice devices can be used via the **Globe iFusion®** “phone port”. These devices are connected to the **Globe iFusion®** phone port using a standard RJ-11, 4-conductor phone cord. Calls can be placed and received in the typical fashion.

Note: In some cases, a PIN access code may be required.

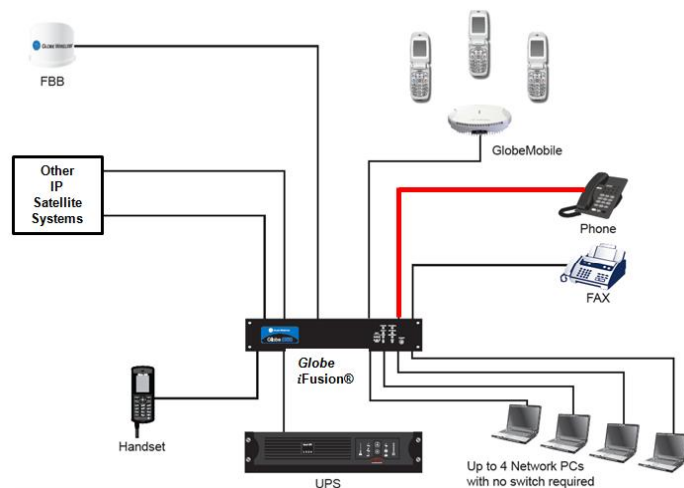

4.1 Your Phone Number

Your phone port phone number, which is also known as the MSISDN (*Mobile Station International Subscriber Directory Number*) is determined by the Globe Wireless SIM card inserted into the SIM port on the back of the **Globe iFusion®**. With each **Globe iFusion®**, Globe Wireless includes a *Product Registration Information Sheet* containing all of the **Globe iFusion®** identifying numbers as well as the phone and fax numbers. Please consult this sheet to determine your phone number.

4.1.1 Placing a Call from the Phone

The first step is to connect your phone to the Phone interface on the rear of the **Globe iFusion®**. To make a call, dial:

00 <country code> <phone number> followed by #.

Example: To call Globe Wireless in the U.S.A. (+1 3213080112) from an analog phone, dial the following: **00 1 3213080112 #**

4.1.2 Receiving a Call to the Phone

To receive a phone call on a desk phone or other device, connect the device to the phone interface located on the rear of the **Globe iFusion®**. The device will ring when the terminal receives a voice call.

4.1.3 Making a Call to the Phone from Shore

To make a call to the phone connected to the **Globe iFusion®**, dial:

+ <voice msisdn>

- + is a prefix used in front of the country code for international calls
- Voice MSISDN. The first part of the voice msisdn is always 870 which is the “country code” for all BGAN systems

4.2 Captain Override

Since the **Globe iFusion®** allows calls to be placed from several locations, there may be times when a ship has a higher priority call to place but the **Globe iFusion®** voice line is currently in use by a low priority call (typically a GSM call). In such a case, the lower priority call can be interrupted and the higher priority call can then be placed.

When the phone is taken off the hook while there is another call in progress, you will hear a busy tone. To terminate the call which is causing this busy signal, perform the following:

- Press the hook button on your phone two times in rapid succession which will terminate the current call
- You will hear a standard dial tone from your phone indicating that you may now proceed with your call

5.0 Using the FBB Handset

The FBB handset can be used via the **Globe iFusion®** RJ-11 phone port using a standard RJ-11 phone cable.

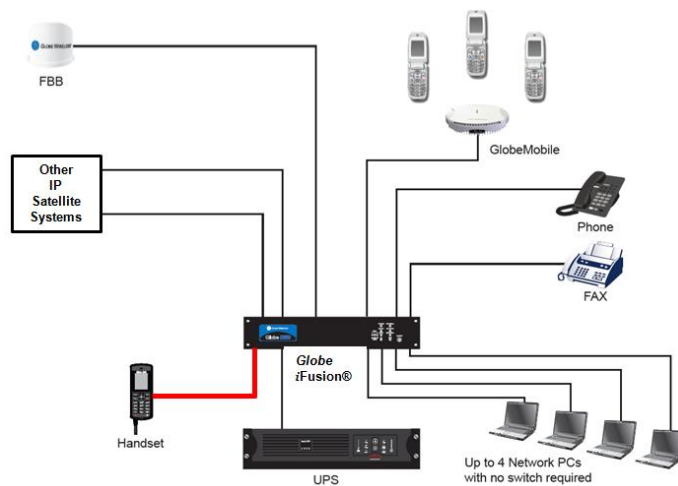

This **Section** provides the basic instructions for the following:

- Connecting the FBB250 corded handset to the **Globe iFusion®**
- Procedures for making a call
- Procedures for receiving a call

5.1 FleetBroadband Handset Use

The handset allows access to the majority of the FleetBroadband functions. It provides a logical and easy to read display. The procedures for connecting the handset to the **Globe iFusion®** as well as making and receiving calls are detailed in the following subsections.

5.1.1 Connect the handset to the Globe *iFusion*®

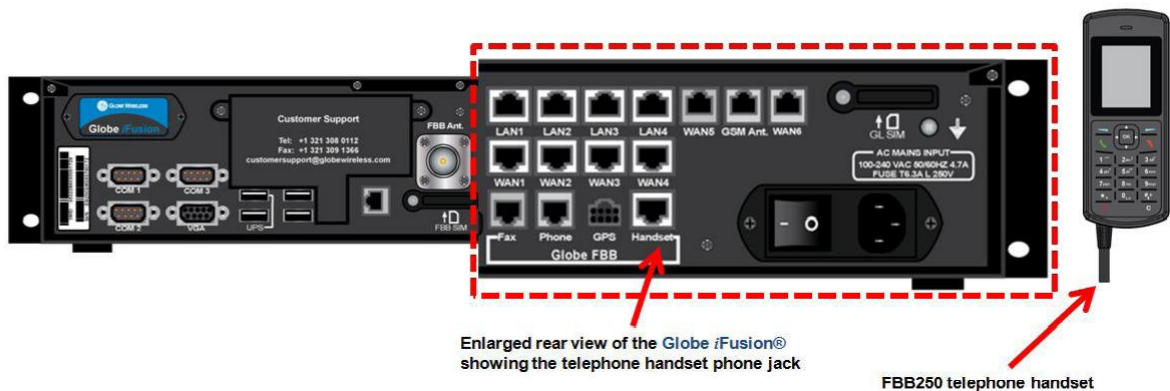



Connect the RJ-11 phone cable from the FBB250 handset to the Handset Port located on the rear of the **Globe *iFusion*®**.

5.1.2 Making a Call

Step 1: Using the alpha-numeric keypad on the handset, dial the number in the following format:

00 + [country code] [area code] [number]

Step 2: Press 

Step 3: To end the call, press 

5.1.3 Receiving a Call

Step 1: The phone will ring when a call is coming in, and the call number will be displayed on the handset screen.

Step 2: Answer the incoming call by pressing 

Step 3: To end the call, press 

6.0 Using a Fax Machine

6.1 Your Fax Number

All FleetBroadband SIM cards are provisioned with two (2) numbers (MSISDNs), one each meant for 3.1Khz/fax calls and standard voice calls (aMBE+2).

Your fax port phone number, which is also known as a MSISDN number is determined by the Globe Wireless SIM card inserted in the SIM port on the back of the **Globe iFusion®**. With each **Globe iFusion®**, Globe Wireless includes a *Product Registration Information Sheet* which contains all of the **Globe iFusion's** identifying numbers as well as the phone and fax numbers. Please consult this sheet to determine your fax number.

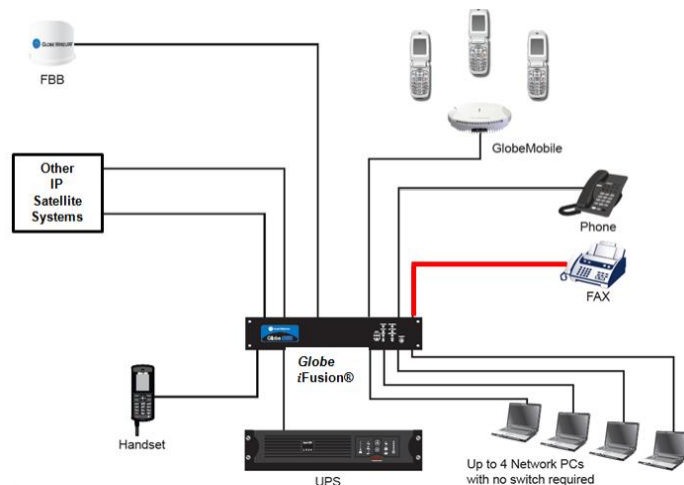

6.1.1 Sending a Fax from the Ship

When audio equipment (analog phone, Fax, or primary handset) connected to their respective ports is off-hooked and an outgoing call is made, the outgoing call will be of the type "3.1Khz audio" or "standard voice" depending upon the outgoing call setting for that particular port.

Note: 3.1 KHz audio call is meant for fax transmission and is not recommended for normal voice conversation as the airtime charge for 3.1 KHz audio is expected to be significantly higher than the standard voice call.

Fax in the **Globe iFusion®** works in the same way as it does through a telephone line. To send a fax to a fax machine connected to the **Globe iFusion®**, perform the following:

1. Connect the Fax Machine to the FAX port with a standard 4-conductor RJ-11 cable.
2. Place the documents to be sent, on the fax machine (as per fax machine instructions).
3. Dial the number on your fax machine, using the following format:



SWG-125 Rev. G

June 2013

<+country code><destination fax number> # (for example, +6512345678#)

Note: Remember to terminate the dial string with “#” as shown in the above example.

4. Wait until the fax is sent.

6.1.2 Sending a Fax to the Ship

To send a fax to a fax machine connected to the **Globe iFusion®**, dial the following:

+ <fax MSISDN>

- + is a prefix used in front of the country code for international calls
- **Fax MSISDN** is the dedicated fax number for the SIM card in your **Globe iFusion®**

Note: The first part of the fax MSISDN is *always* **870** which is the “country code” for all BGAN systems.

6.1.3 Receiving a Fax on the Ship

To receive a fax transmission, connect the fax machine to the Fax interface of the **Globe iFusion®**. The device will ring when the terminal receives a fax call.

7.0 Using a Mobile Phone

7.1 GlobeMobile Services

GlobeMobile is the Globe Wireless shipboard mobile phone service. The **Globe iFusion®** is equipped with a full **GlobeMobile** gateway and antenna which provide two-way cellular calling and text messaging routed over the satellite connection.

The **GlobeMobile** services are all based on the GSM prepaid model. This means that each user must have a Globe Wireless **SIM** card in his phone and the phone must be “topped-up” with a refresh card which gives the user the credit necessary to talk or text.

To provide the shipboard GSM network, the **Globe iFusion®** has a GSM (Globe Mobile antenna) installed in a central location onboard your vessel. It is usually located in a stairway or hallway in order to achieve the best possible coverage.

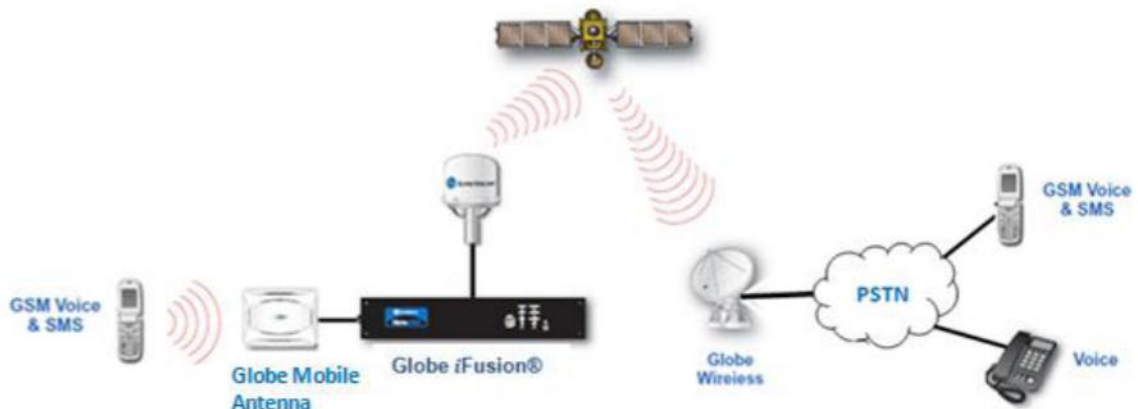

Phone calls placed onboard ship are received by the GlobeMobile antenna, routed through the **Globe iFusion®**, sent over the satellite and then connected to their final destination using terrestrial phone and GSM networks. Charges for the calls are deducted automatically from the prepaid account as the call is in progress.

Contact your captain for SIM or refresh cards, and information about phone and text message rates.

7.2 Getting Started

Once you type in the URL, the Globe *iFusion*® is displayed as shown below. Depending on what you wish to do, perform one of the following:

- **First Time User** – Click if you need to set up an account
- **Downloads** – Click to display the page of available downloads. Follow directions from there
- **Login** – If you have your **Userid** and **Password**, click this link to display the login screen
- **Help** – At any time, from any page, you can click on Help to display the online help application



7.2.1 First Time User

Click the **First Time User?** link located on the login page to display the instructions for signing up for an account to be used with your mobile phone.

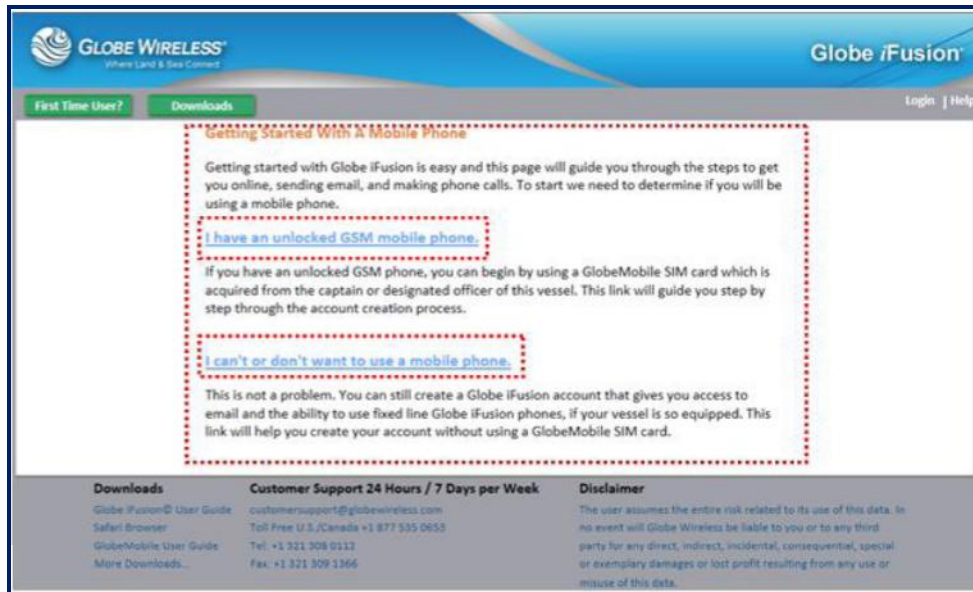

Note: **GlobeMobile SIM cards will only work in *unlocked* mobile phones.** Some mobile devices are *locked* to a particular carrier. If this is the case you will *not* be able to use the Globe Wireless **SIM** card in your current device.

7.2.1.1 Unlocked GSM Mobile Phone

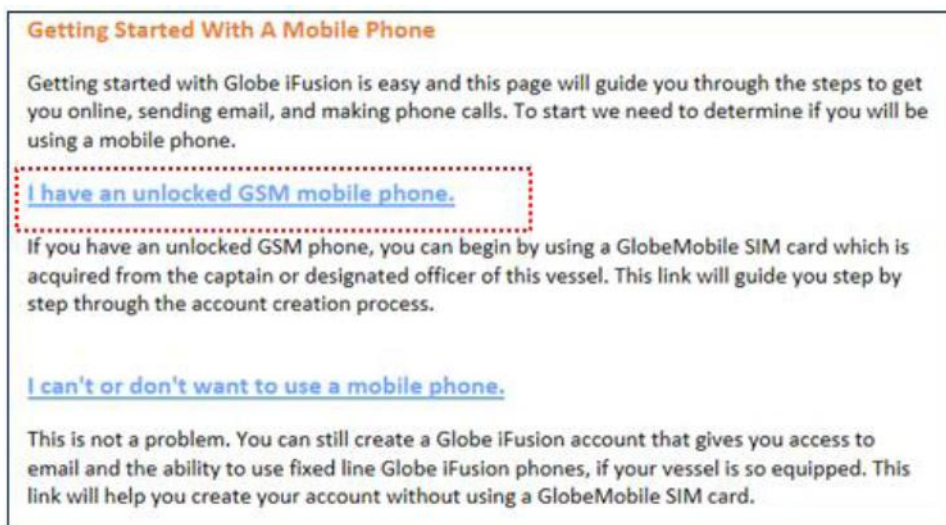

If you have an unlocked GSM Mobile phone, click the corresponding link 'I have an unlocked GSM mobile phone' and walk through the following steps:

STEP 1: Obtain a Globe Wireless SIM Card



Your first step is to obtain a Globe Wireless SIM card. SIM cards are available from your captain or other officer responsible for selling SIMs and refresh cards on your vessel.

Step 1: Referring to the graphic above, obtain a Globe Wireless **SIM** card, available from your Captain or other designated officer responsible for selling **SIM** cards and refresh cards on the vessel.

STEP 2: Insert Your SIM



Once you have a SIM you must insert it into your mobile phone. To do this, first power off the device and then remove your old SIM by following the instructions in the user guide provided with your mobile device. Afterwards, insert the Globe Wireless SIM in its place. Note, some mobile devices are locked to a particular carrier other than Globe Wireless and these devices cannot be used with the Globe

Wireless SIM card.

Step 2: Referring to the graphic above, insert the **SIM** into your mobile phone by performing the following:

- Power off the mobile phone
- Remove the old **SIM** card following the instructions of the mobile device
- Insert the Globe Wireless **SIM** in the slot from which the old **SIM** was removed

Note: Remember, some mobile devices are *locked to a particular carrier*. If this is the case you will *not* be able to use the Globe Wireless **SIM** card in your current device.

STEP 3: Power-up Your Mobile Phone



When you have the Globe Wireless SIM card inserted in your phone and the phone is ready for operation, turn the power on. When the phone registers itself on the Globe Wireless network it will display a carrier name of "GWIRELESS" or it might display the carrier code "310 720".

Step 3: Referring to the graphic above, once the Globe Wireless **SIM** is inserted into your phone and the phone is ready for operation, turn the power to **ON**.

- Once the phone has registered itself on the Globe Wireless Network, one of the following messages will be displayed:

Carrier Name: GWIRELESS

or

Carrier Code: 310 720

STEP 4: Receive A Welcome Message



When your phone has registered on the network, shortly after that you will receive an SMS text message which welcomes you to the GlobeMobile network. This message contains your phone number and your password for the Globe i250 website. Your User ID is your phone number.

Step 4: Referring to the above graphic, wait to receive an SMS text message welcoming you to the GlobeMobile network once your phone has been registered (on the Network).

This message will contain the following information:

- Your **phone number** (Your phone number is also your userid)
- Your **password** for the Globe iFusion® website

STEP 5: Enter Your User ID and Password Below

User ID	<input type="text"/>
Password	<input type="password"/>
	<input type="button" value="Login"/>

Step 5: Once you are set up and have received your phone number (userid) and password, log in by typing your **Userid** and **Password**, and then clicking the **Login** button.

7.2.1.2 No Mobile Phone

Getting Started With A Mobile Phone

Getting started with Globe iFusion is easy and this page will guide you through the steps to get you online, sending email, and making phone calls. To start we need to determine if you will be using a mobile phone.

[I have an unlocked GSM mobile phone.](#)

If you have an unlocked GSM phone, you can begin by using a GlobeMobile SIM card which is acquired from the captain or designated officer of this vessel. This link will guide you step by step through the account creation process.

[I can't or don't want to use a mobile phone.](#)

This is not a problem. You can still create a Globe iFusion account that gives you access to email and the ability to use fixed line Globe iFusion phones, if your vessel is so equipped. This link will help you create your account without using a GlobeMobile SIM card.

If for whatever reason you do not click on first option; whether you do not have an unlocked mobile phone, or do not wish to use a mobile phone, you can still create an account without using a GlobeMobile SIM card. Click the corresponding link 'I can't or don't want to use a mobile phone' to display the **Create a new Globe iFusion® Account** screen.

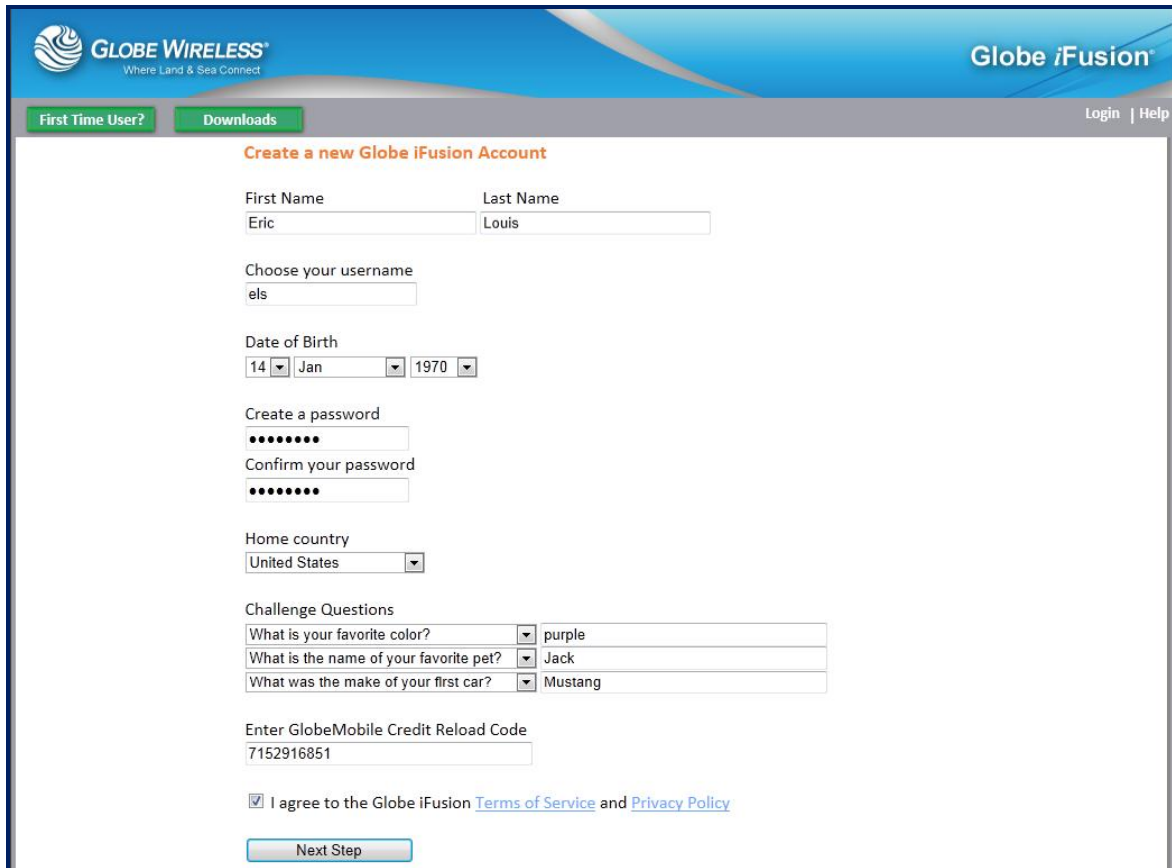

- Step 1: Populate the fields in the screen with your name, username, Date of Birth, password, and home country.
- Step 2: Answer the three **Challenge Questions**. (You can click on the drop-down arrow to select a different challenge question, if desired.) If for some reason you forget your logon or password, these questions will be asked to verify your identification before authorizing log on.
- Step 3: Enter the **GlobeMobile Credit Reload Code** which you should have received from the captain or authorized personnel.
- Step 4: Click the links to read the **Terms of Service** and the **Privacy Policy**. Once read and understood, click to place a checkmark in the **I Agree** checkbox and click the **Next Step** button. A pop-up confirmation will be displayed.

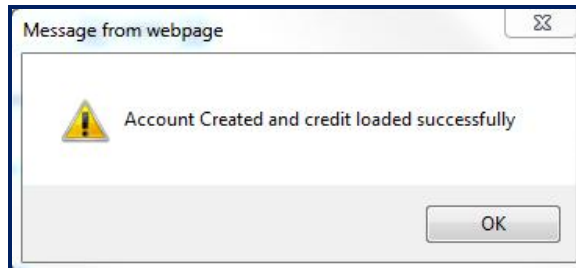

Step 5: Click **OK** to display a **Welcome!** Screen which displays your email address.

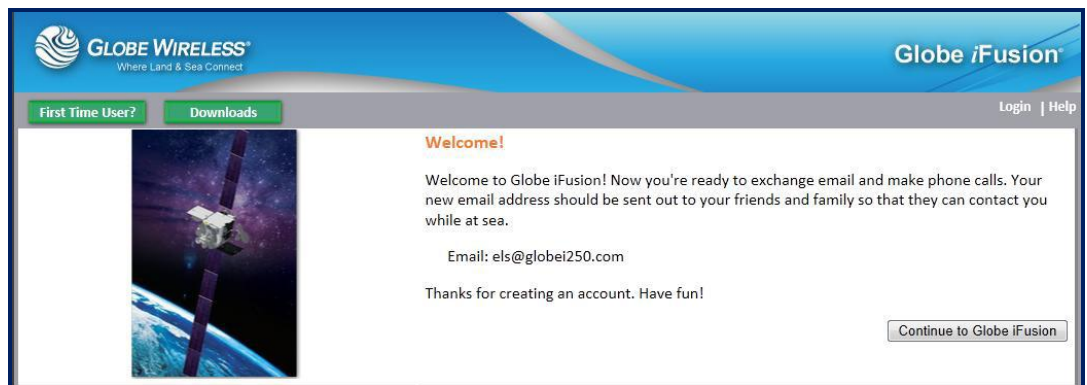

Step 6: Click the **Continue to Globe iFusion** button which will re-display the opening page..



Step 7: Click the Login button to display the Login popup.

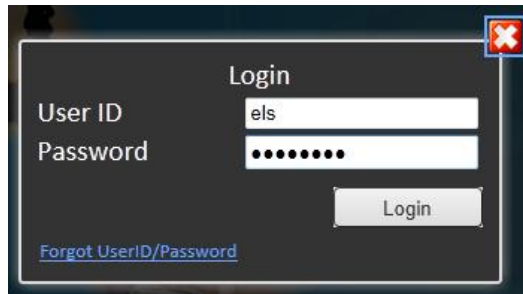

A screenshot of a login window titled "Login". It features two input fields: "User ID" with the text "els" and "Password" with masked characters. A "Login" button is positioned below the password field. A link for "Forgot UserID/Password" is located at the bottom left of the form area.

Step 8: Enter your **User ID** and **Password** and click the **Login** button.

7.2.2 Downloads



Step 1: Click the **Downloads** link located on the login page to display a list of free downloads.

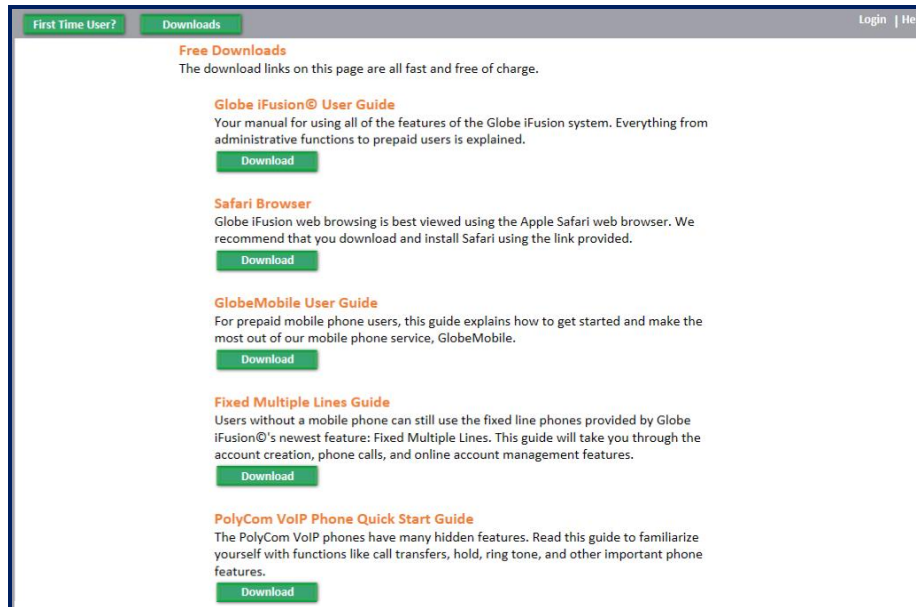

Step 2: Click the **Download** button below the item to be downloaded and follow the download instructions.

7.2.3 Login



Step 1: If you know your login and password, click the **Login** link to display the login pop-up.

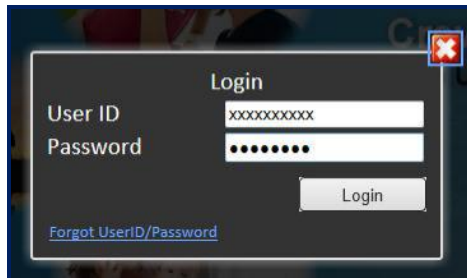

Step 2: Type your **User ID** and **Password** in the fields and click the Login button to display the default screen Communications.....

7.2.3.1 **Forgot Password**

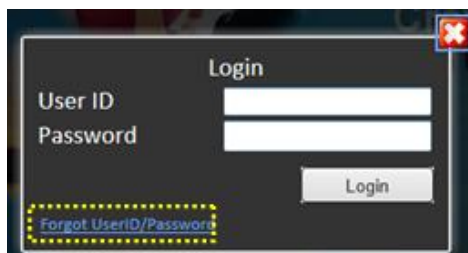

If you have forgotten your Password, click on the [Forgot UserID/Password](#) link on the Login pop-up. The **Forgot Your UserID/Password?** screen is displayed.

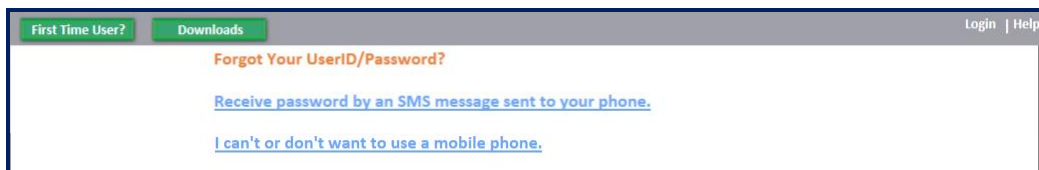

Receive password by an SMS message sent to your phone



Step 1: Click the [Receive password by an SMS message sent to your phone](#) link to display the **Forgot your Password?** screen.

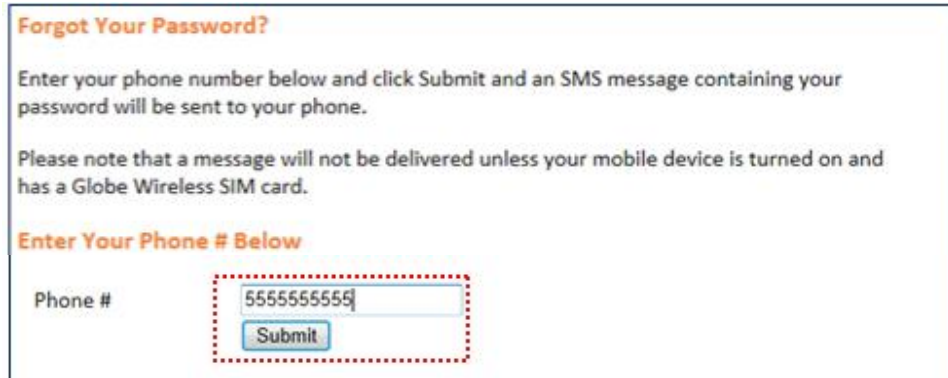

Step 2: Type your phone number in the **Phone #** field and click the **Submit** button.

Your password will be sent to your phone via SMS message.

I can't or don't want to use a mobile phone



Step 1: Click the [I can't or don't want to use a mobile phone](#) link to display the **Forgot your Password?** screen.



Step 2: Type your **User ID** in the field (as shown above) and click the **Proceed** button.

A screen will be displayed requesting you supply a new password, your date of birth, and the answers to the three challenge questions.

Enter a new password and answer the following questions associated with your account when you first registered:

Create a new password
••••••••

Confirm your new password
••••••••

Date of Birth
27 Jun 1913

Challenge Questions

What is your favorite color?
teal

What is the name of your favorite pet?
jack

What was the make of your first car?
mustang

Continue

Step 3: Populate the required fields and click the **Continue** button.

Step 4: The opening screen is once again displayed.

Step 5: Click on Login at the top right corner of the screen to display the Login pop-up.

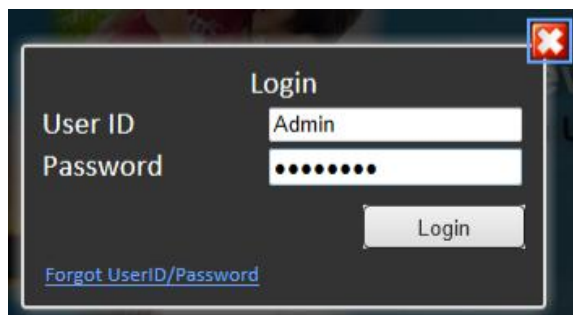

Login

User ID Admin

Password ••••••••

Login

[Forgot UserID/Password](#)

Step 6: Enter your User ID and the password you just created and click the **Login** button. The default **Communication Status** screen will be displayed.

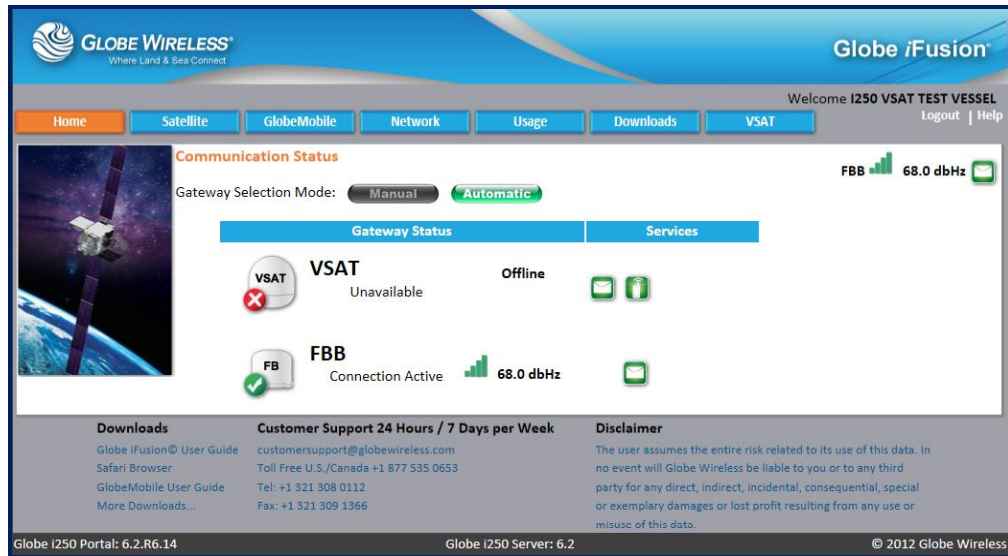

7.2.3.2 Forgot User ID

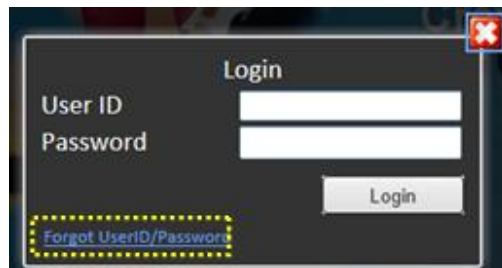

If you have forgotten your **User ID**, click on the [Forgot UserID/Password](#) link on the Login pop-up to display the **Forgot Your UserID/Password?** screen.



Step 1: Click the [I can't or don't want to use a mobile phone](#) link to display the **Forgot your UserID or Password?** screen.

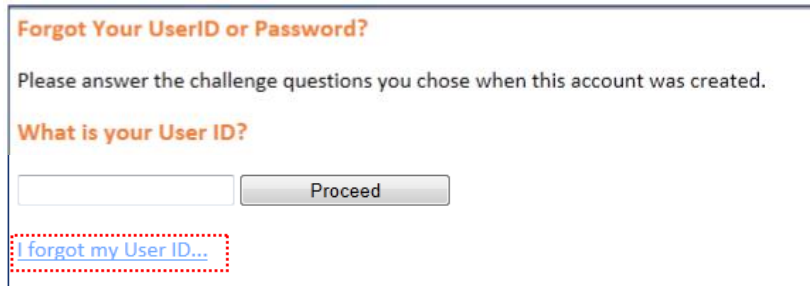

Step 2: Click [the I forgot my User ID...](#) link to display the **Forgot UserID** screen.

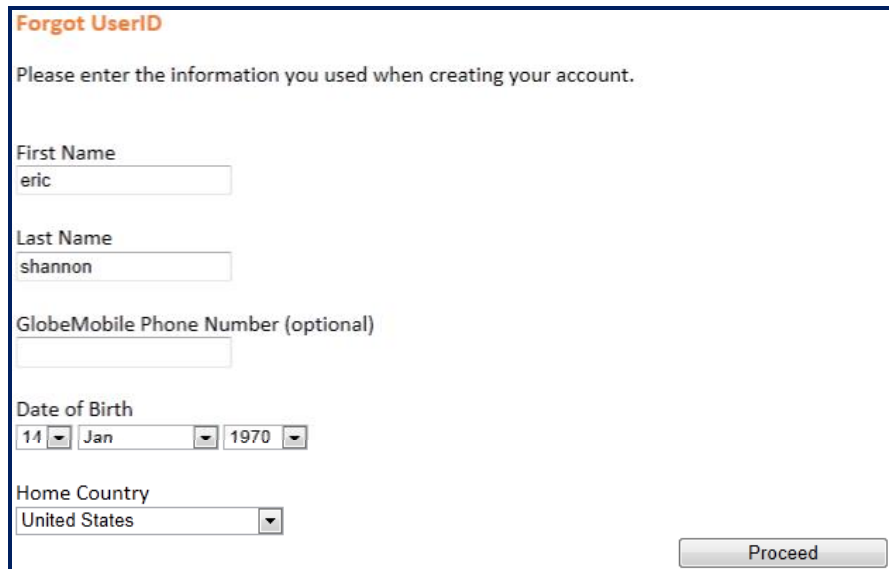

Step 3: Populate the *First name*, *Last name*, *Date of Birth*, and *Home Country* fields; then click the **Proceed** button. Your **User ID** will be displayed.

If you entered erroneous information on the **Forgot User ID** page, you will receive the following error message. Click **OK** and follow the steps.

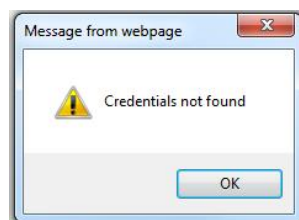

7.2.4 Placing and Receiving Calls

Step 1: Dial + [country code] [area code] [number]. You may hear a dial tone or ringing tone depending on destination and time delay.

Step 2: Once you have finished the call, hang-up.

Note: Once disconnected, you will receive a free text message with the cost of the call and your remaining balance.

7.2.5 SMS Text messaging

Step 1: Enter your SMS message (refer to your phone user manual for instructions). An SMS message can be up to 160 characters in length.

Step 2: Enter the message recipient's telephone number or email address (refer to your phone user manual for instructions).

Step 3: Send the message.

Note: Multimedia (MMS) messages are not currently supported.

7.2.6 Operation Entering and Exiting Shipping Ports

Although you can use the GlobeMobile SIM to roam on standard GSM shore networks, these calls are at much higher rates. Globe Wireless recommends that you use a local SIM while on shore whenever possible. Also note that as the vessel enters and leaves a distance of two miles from the shoreline, the **Globe iFusion®** may disable and enable the GSM Antenna unit(s).

Important! It is especially important for mobile phone users to take note of **which carrier is displayed** on their device once the vessel nears the shoreline. The Globe Wireless carrier symbol is **GWIRELESS**.

8.0 Web-Based Software

8.1 Getting Connected

8.1.1 Configuring your IP Connection

The **Globe iFusion®** supports the network protocol DHCP to automatically configure your PC with the correct network settings. To ensure your PC is configured to this setting, go to **Control Panel | Network Settings | Local Area Connection (Click *View Status*)**. Click the **Properties** button to display the **Local Area Connection Properties** screen.

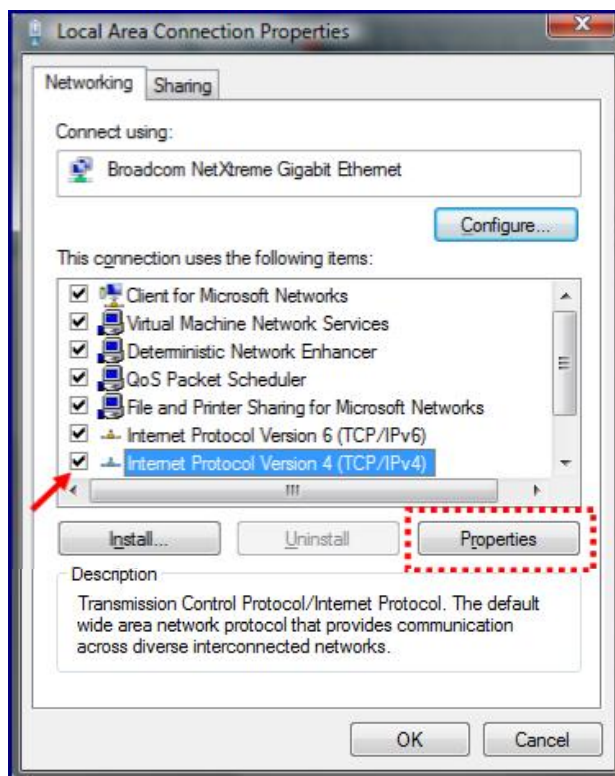

Step 1: Click to highlight and place a checkmark in the entry listed as “**Internet Protocol Version 4 (TCP/IPv4)**”.

Step 2: Click the properties button to display the **Internet Protocol Version 4 Properties** screen.

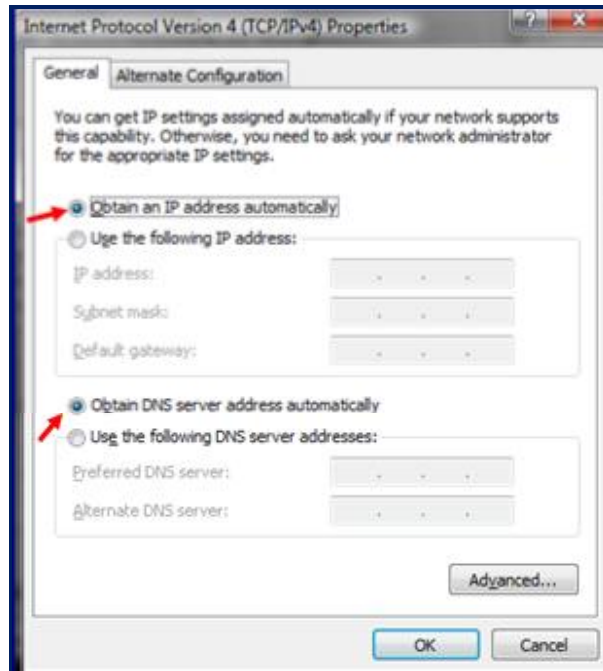

Step 3: Click the radio button to select “*Obtain IP and DNS server address automatically*” (as shown in the above example) to ensure that web browsing works properly.

8.1.2 Supported Web Browsers

Globe iFusion® web application supports the most recent versions of all major web browsers to include:

- Microsoft Internet Explorer version 8
- Apple Safari version 5 (recommended)
- Google Chrome version 3
- Mozilla Firefox version 3

8.1.3 The URL

The **Globe iFusion®** web application can be accessed by its name. To access this web application, open your web browser and type (for example):

<http://globe.ifusion>

Alternatively, the **Globe iFusion®** web application can be accessed by its IP address.

<http://192.168.1.210>

(Substitute the example of **192.168.1.210** with the IP Address of your **Globe iFusion®**.)

8.2 Navigation

8.2.1 The Menu and Sub-Menu

Once you have entered the **URL** and logged into the **Globe iFusion®**, depending on where you navigate to, determines the menu / sub-menu items displayed. The following is an example of the **(Satellite)** menu as well as the associated sub-menu:

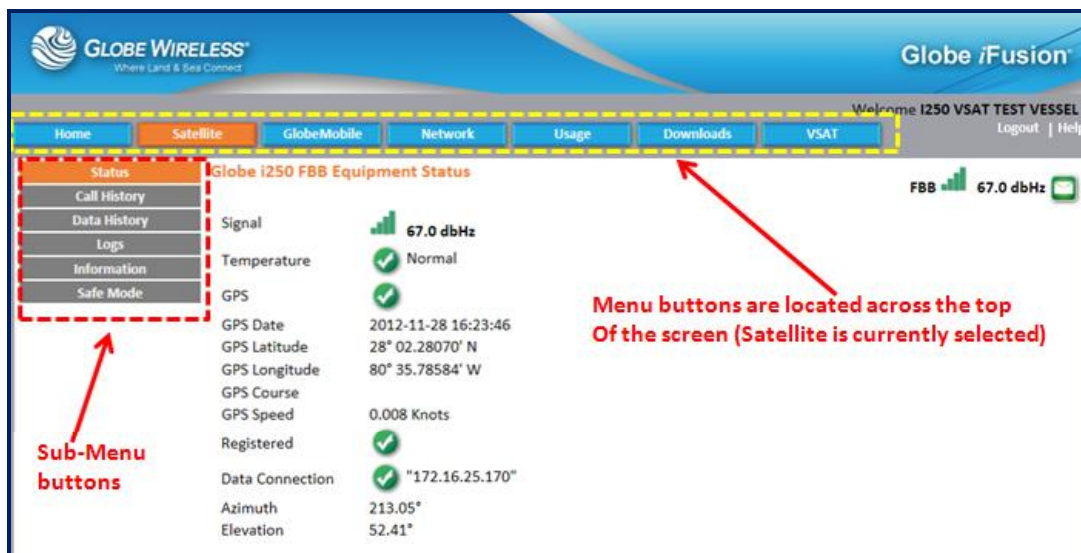

In the above example, the **Menu** button selected is **Satellite**. The **sub-menu** buttons associated with Satellite are displayed on the left side of the screen. If the user presses the **Network Menu** button, a different set of **sub-menu** buttons will be displayed on the left side of the screen.

The **menus** and **sub-menus** are described within this document.

8.2.2 Help

Click on **Help** at anytime from any screen to access the **Online Help** application.

8.2.3 Communication Status (Home Page)

Click on the **Home** menu button at any time to navigate to the **Home Page** which contains the **Communication Status** information on services currently in use.

This page gives a quick view of which satellite terminal the **Globe iFusion®** currently prefers, that terminal's signal strength (if applicable), and the prepaid services supported by that terminal (mail and phone).

It also displays the **Gateway Selection Mode**: Manual or Automatic.

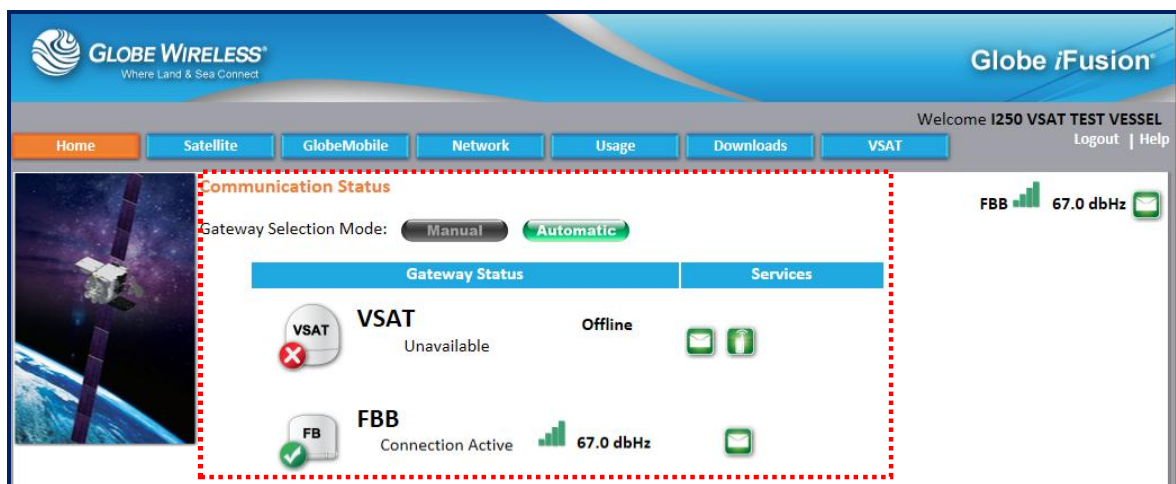

8.2.4 Login

To access the web application, open your web browser and type the following URL:

<http://globe.ifusion>

Alternatively you can type the IP address of the **Globe iFusion®**. For example:

<http://192.168.1.210>

The opening screen is displayed. If you already have an account, you can log in. If you are a first time user, you can set up a new account from this screen.



Refer to the following table for a description of the fields located on the main **Globe iFusion@** screen:

Component	Description
First Time User? Button	Click to set up a new account <ul style="list-style-type: none"> Using your own mobile phone Sign up for prepaid email service only
Downloads	Click to display a list of available downloads.
Login	Click to display the pop-up Login screen where you will enter your User ID and Password .
Help	Click at any time from any screen to access the Online Help application.

8.2.5 Logout



Click the **Logout** button at any time to log off the system.

When you logout, you will be returned to the **Globe iFusion®** beginning screen.



8.3 Users

There are three types of users for the **Globe iFusion®**:

- [Admin](#)
- [Prepaid user](#)
- [Web Browser](#)

Each user type is discussed in the following sections. You may also click on a user type from the (above) list to link to the specific section.

9.0 Admin User

The Admin user is used to view the current settings of the **Globe iFusion®**. The user has no email or web browsing ability. The account is accessed either by typing the name “Admin” or by typing the **Globe iFusion®** ID number and then the password.

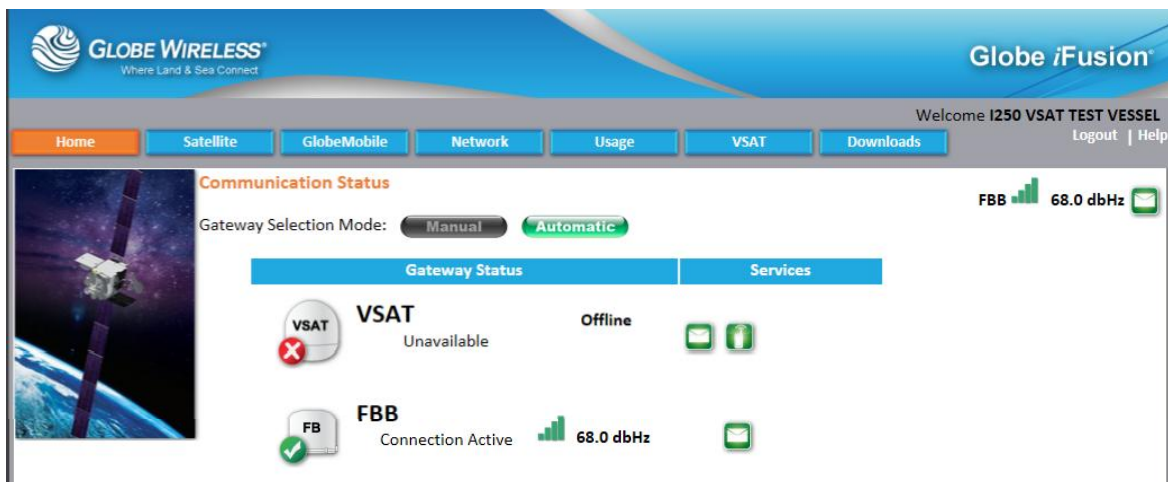

The screenshot shows the Admin User interface for Globe iFusion. The top navigation bar includes tabs for Home, Satellite, GlobeMobile, Network, Usage, VSAT, and Downloads. The main content area is titled "Communication Status" and displays the Gateway Selection Mode set to "Automatic". A table shows the status of two gateways: VSAT (Offline, Unavailable) and FBB (Connection Active, 68.0 dBHz). A satellite image is visible on the left side of the communication status section.

The **Admin User Globe iFusion®** screen contains the following tabs:

- Home (*default*)
- Satellite
- GlobeMobile
- Network
- Usage
- VSAT
- Downloads

9.1 Satellite Tab

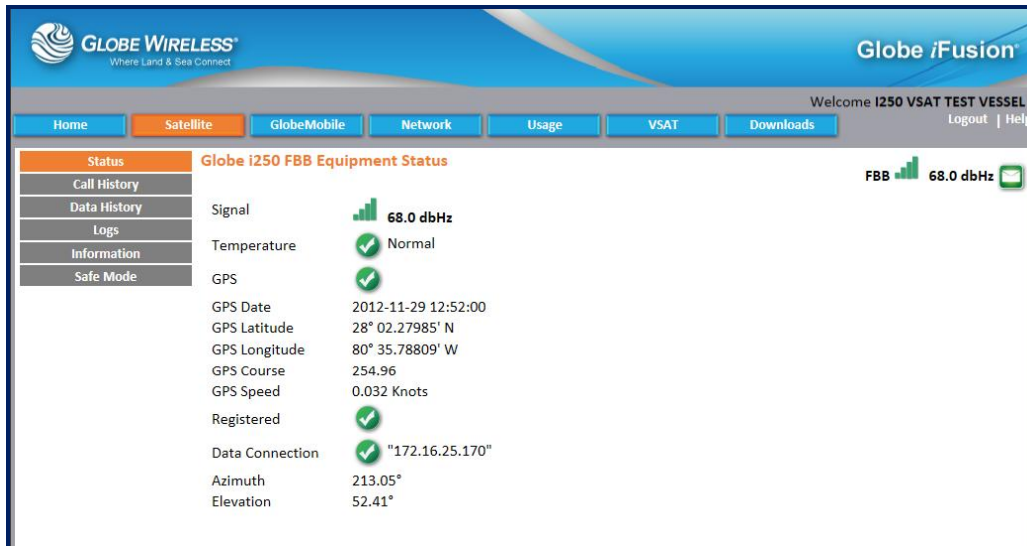

The screenshot displays the 'Satellite' tab in the Globe iFusion interface. The page title is 'Globe i250 FBB Equipment Status'. A navigation menu at the top includes Home, Satellite (selected), GlobeMobile, Network, Usage, VSAT, and Downloads. A sidebar on the left lists sub-tabs: Status (selected), Call History, Data History, Logs, Information, and Safe Mode. The main content area shows various status indicators and data points:

- Signal: 68.0 dBHz (indicated by a green signal strength icon)
- Temperature: Normal (indicated by a green checkmark)
- GPS: (indicated by a green checkmark)
- GPS Date: 2012-11-29 12:52:00
- GPS Latitude: 28° 02.27985' N
- GPS Longitude: 80° 35.78809' W
- GPS Course: 254.96
- GPS Speed: 0.032 Knots
- Registered: (indicated by a green checkmark)
- Data Connection: "172.16.25.170" (indicated by a green checkmark)
- Azimuth: 213.05°
- Elevation: 52.41°

In the top right corner, there is a 'Welcome I250 VSAT TEST VESSEL' message, a 'Logout | Help' link, and a small status indicator showing 'FBB' with a signal strength icon and '68.0 dBHz'.

Click on the **Satellite Tab** to display the following *sub-tabs*:

- Status
- Call History
- Data History
- Logs
- Information
- Safe Mode

9.1.1 Status Sub-tab

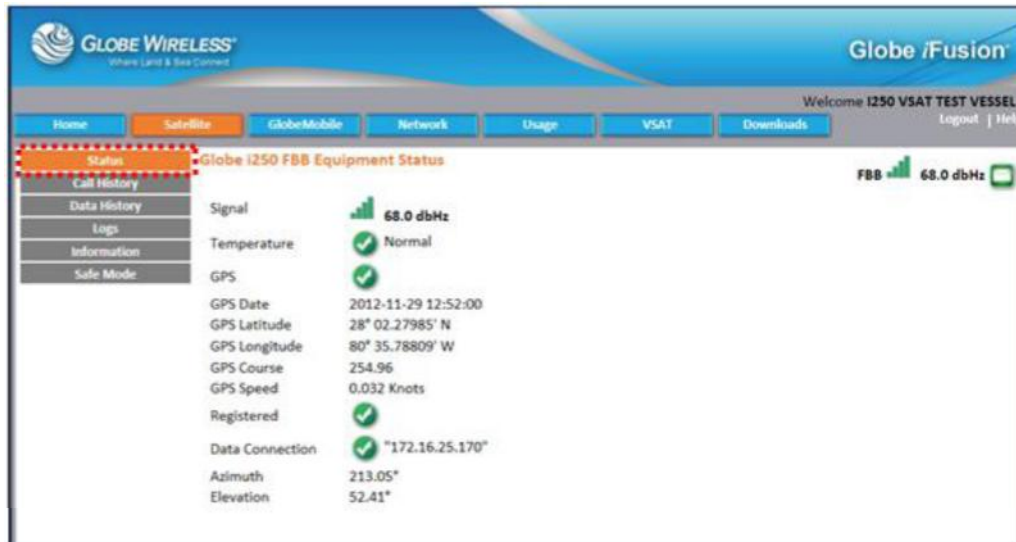

Status is the *default* sub-tab within the **Satellite** tab. The **Status** sub-tab displays the **Globe iFusion® FBB Equipment Status**.

Signal	Green bars indicate signal strength of the equipment
Temperature	Indicates if the equipment temperature is within the normal range
GPS	Displays the GPS coordinates : GPS Date, GPS Latitude, GPS Longitude, GPS Course, and GPS Speed
Registered	A green checkmark indicates that the Globe iFusion® has connected to the satellite and has registered with the Inmarsat shore system.
Data Connection	Displays the connection address
Azimuth	Displays current Azimuth .
Elevation	Displays current Elevation .

9.1.2 Call History Sub-tab

The **Call History** sub-tab shows only calls made using the **Globe iFusion®** internal FleetBroadband 250 voice line. Depending on your configuration, the **GlobeMobile** service may be using this line. If so, all calls made from mobile phones will be logged in this list as well.

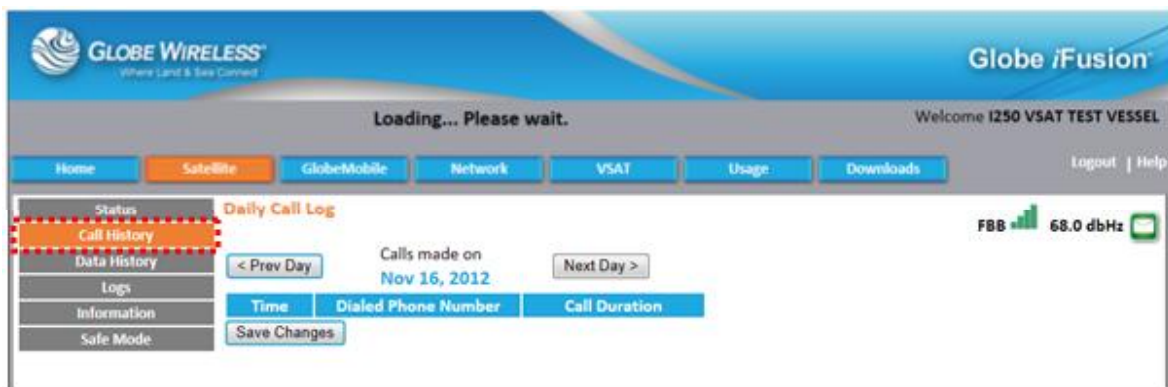

Click on the **Call History** sub-tab to display the **Globe iFusion® Daily Call Log** which displays the time of the call, the dialed phone number, and the duration of the call.

The user has the following options:

- Display the log for a specific day by clicking the **Prev Day** or **Next Day** button
- Viewing account code information
- Editing account code information less than 24 hours old
- Saving the changes to the account codes for the calls

Account codes can be used by your company for billing calls to a third party. The codes will be reflected on the company invoice for the calls made. The admin user has a 24 hour window in which to edit these account codes. After that time the codes will have been transmitted to shore and are no longer editable. If your configuration uses the voice line of the internal FleetBroadband, those calls will be shown with an account code of 299. This code is never editable.

9.1.3 Data History Sub-tab



The screenshot shows the 'Data Connection Log' interface. The navigation menu includes: Home, Satellite, **Data History**, GlobeMobile, Network, VSAT, Downloads, Usage. The main content area displays a table with the following data:

Date	Time	Duration	Volume(MB)
Nov 27, 2012	05:41:44	002:07:45:07	0.7
Nov 17, 2012	12:04:25	009:17:25:00	6.6
Nov 07, 2012	16:43:25	009:19:05:02	3.5
Nov 07, 2012	16:37:01	000:00:00:00	0.2
Nov 07, 2012	16:11:39	000:00:15:00	0.2
Nov 07, 2012	15:52:48	000:00:00:00	0.2
Nov 07, 2012	15:49:03	000:00:00:00	0.2
Nov 07, 2012	15:19:00	000:00:15:00	0.2
Nov 02, 2012	13:07:18	005:02:00:02	2.0
Nov 02, 2012	13:03:18	000:00:00:00	0.2

Click on the **Data History** sub-tab to display the **Globe iFusion® Data Connection Log** which displays the *Date*, *Time*, *Duration* (of time in minutes/seconds), and *Volume* transferred in megabytes.

You can display the log for a specific day by clicking the **Prev Day** or **Next Day** button.

As with **Call History**; the **Data History** sub-tab screen shows only data connections made by the internal FleetBroadband. The list includes both streaming and background data connections. **GlobeMobile Digital Quality Voice (DQV)** connections are also listed here.

The connection history is updated approximately once per minute and shows approximate values for the connection duration and volume.

9.1.4 Logs Sub-tab

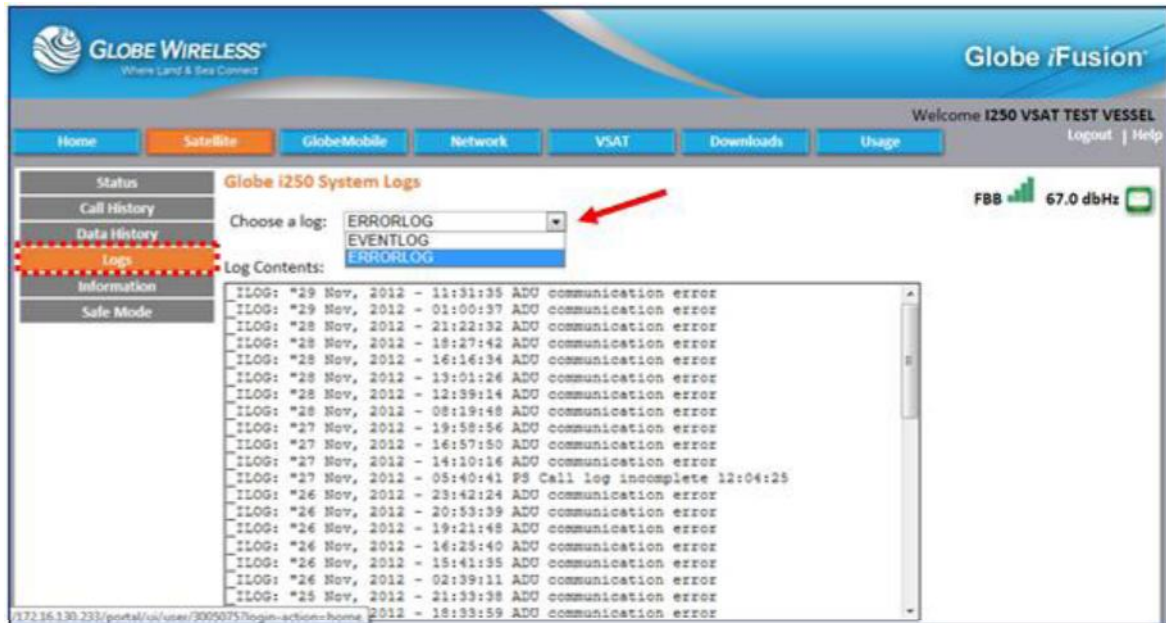

Click on the **Logs** sub-tab to display the **Globe iFusion® System Logs**.

Click the dropdown arrow in the **Choose a log:** field and select the **Error Log** or the **Event Log** which displays the *Date, Time, Duration* (of time in minutes/seconds), and the event or error that occurred.

9.1.5 Information Sub-tab



Click on the **Information** sub-tab to display specific equipment information about the **Globe iFusion®** (*Manufacturer ID, Model, SW Version, Subscriber #, etc.*).

Manufacturer ID	Lists the Manufacturer name; i.e., Globe Wireless, Addvalue, etc.
Model	Lists the Model; i.e., Globe iFusion®
Software Version	Displays the current version of the software being used
IMEI #	Displays the <i>International Mobile Equipment Identity</i> number
IMSI #	Displays the <i>International Mobile Subscriber Identity</i> number
ADU Serial #	Displays the serial number of the Above Deck Unit (ADU)
BDU Serial #	Displays the serial number of the Below Deck Unit (BDU)
MAC	Displays the Media Access Control (MAC) Address

9.1.6 Safe Mode Sub-tab

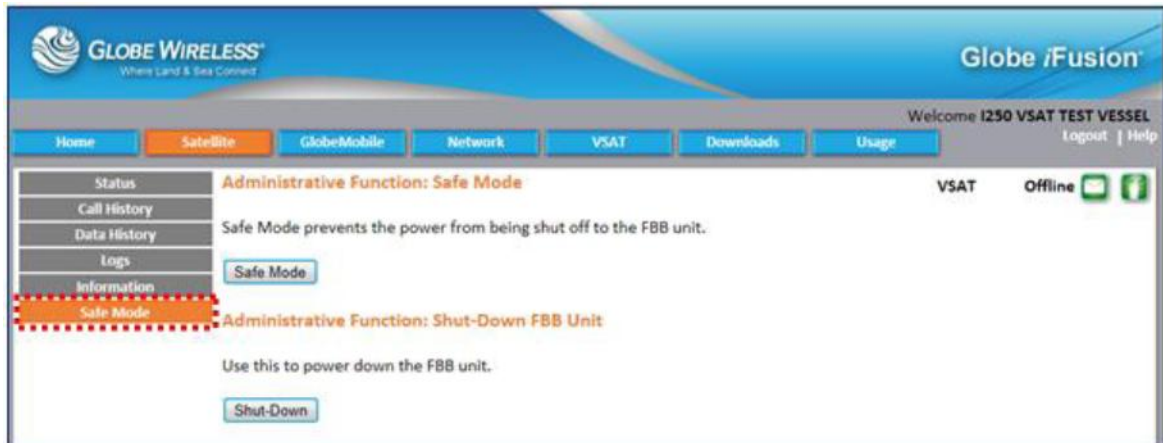

The **Globe iFusion®** automatically controls the data connections made by the internal FleetBroadband. In the unlikely event that the FleetBroadband stops responding to commands, the **Globe iFusion®** will reboot it automatically. This is designed to give greater uptime and recovery in the case of hardware malfunction. However, this also poses some risks when upgrading the firmware of the FleetBroadband.

Safe Mode is an administrative function used to prevent the automatic reboot of the internal **FleetBroadband** by the **Globe iFusion®**. The main purpose of **Safe Mode** is to upgrade the firmware of the **FleetBroadband**. (Refer to **Appendix C** for steps to update the **Globe iFusion®** Firmware.)

- Clicking the **Safe Mode** button prevents the power from being shut off to the FBB unit
- Click the **Shut Down** button to power down the FBB unit

9.2 GlobeMobile Tab

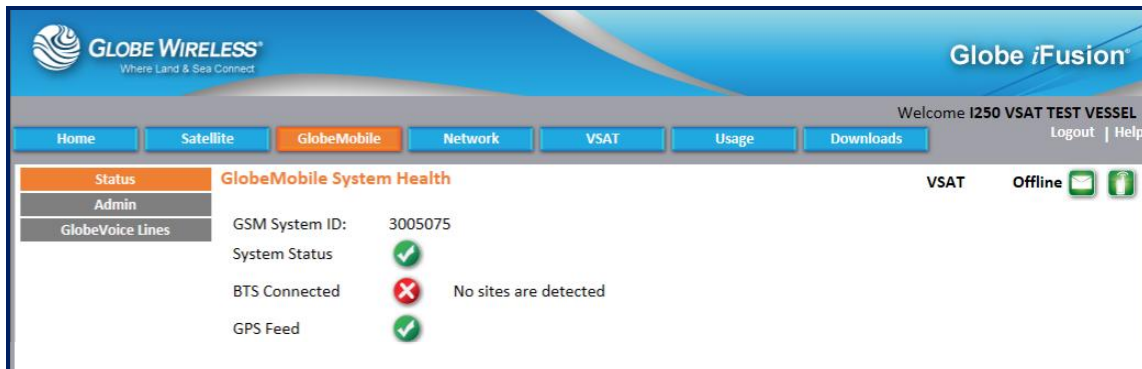

Click on the **GlobeMobile Tab** to display the following *sub-tabs*:

- Status (*default*)
- Admin
- GlobeVoice Lines

9.2.1 Status Sub-tab

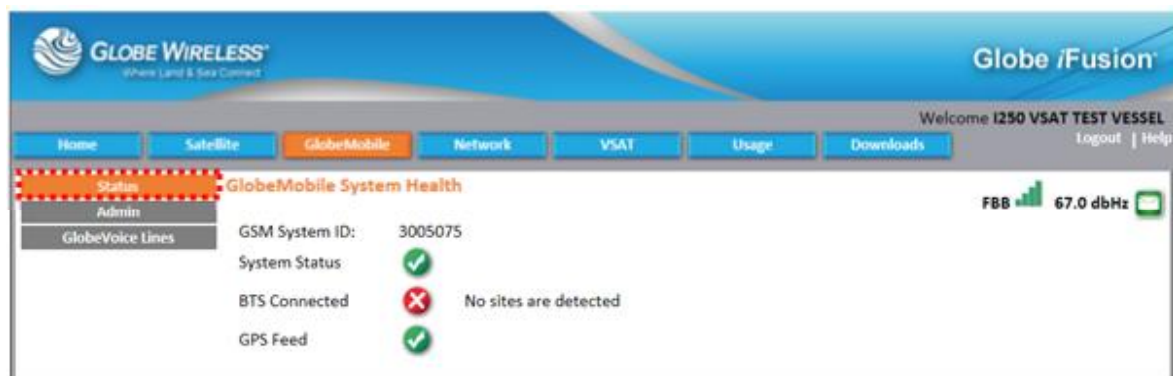

The *default* sub-tab (**Status**) displays the **GlobeMobile System Health** screen with the following information:

- The **GSM System ID** – This is used to uniquely identify your GSM network on the vessel.
- **System Status** – This reflects the current operational status of the vessel's GSM network. When it displays a green checkmark, the mobile devices on the vessel can place GSM phone calls. When it displays a red X, no GSM phone calls can be made.

- **BTS Connected** – In order to make GSM phone calls and send SMS text messages, the BTS (GlobeMobile antenna) must be connected to the **Globe iFusion®** and it must be fully operational. When this is the case, a green checkmark will be displayed and when it is not the case a red X will be displayed.
- **GPS Feed** – In order to determine the proximity to the coastline so that the GSM network can be disabled, GlobeMobile relies on a GPS feed from the internal FleetBroadband 250 unit. If this is present, a green checkmark will be displayed and if it is not present a red X will be displayed.

9.2.2 Admin Sub-tab



The **Admin** sub-tab allows the Administrator to view and/or perform certain GlobeMobile FBB Management Functions:

- **Current FBB Calls in Progress** – Displays the number of FBB calls currently in progress.
- **Clear Phone Line** – The Administrator can end all of the current calls with the **Clear Phone Line** button. This is an important feature when using the **FleetBroadband** Voice line rather than **Digital Quality Voice (DQV)**. In that configuration users will tie up the voice line of the terminal and this could be at an inopportune time for the captain or officers of the vessel.
- **Control BTS (antenna) Behavior** – The Administrator can choose the mode which determines the power to the **BTS (GlobeMobile Antenna)**.
 - **Always Off** will disable the **BTS (GlobeMobile Antenna)** entirely and no calls will be possible until the state is changed.
 - **BTS Tracking GPS** will use the **GPS** to determine the proximity of the vessel to the shoreline and disable the **BTS (GlobeMobile Antenna)** when the vessel approaches it.
 - **Always On** will permanently enable the **BTS (GlobeMobile Antenna)** without regard for geographical location.

9.2.3 GlobeVoice Lines Sub-tab



The **GlobeVoice Lines** sub-tab displays the configuration of the system **GlobeMobile** uses to make GSM phone calls. The options are as follows:

- **FBB VOIP** – This is a **Digital Quality Voice (DQV)** setting. GSM calls will be routed over FleetBroadband using an 8Kbps *Streaming* connection. This setting includes the number of lines available for **GlobeMobile** using this technique.
- **FBB Voice** – In this setting the Internal FleetBroadband voice line and/or any other external FleetBroadband devices' voice lines are used to route the GSM phone calls. For external devices, the **OUT 1**, **OUT 2**, and **OUT 3** ports on the rear of the **Globe iFusion®** are used to connect the **Globe iFusion®** to them.
- **VSAT** – This is a **Digital Quality Voice (DQV)** setting. GSM calls will be routed over the VSAT device using the Committed Information rate (CIR). This setting includes the number of lines available for GlobeMobile.

9.3 Network Tab

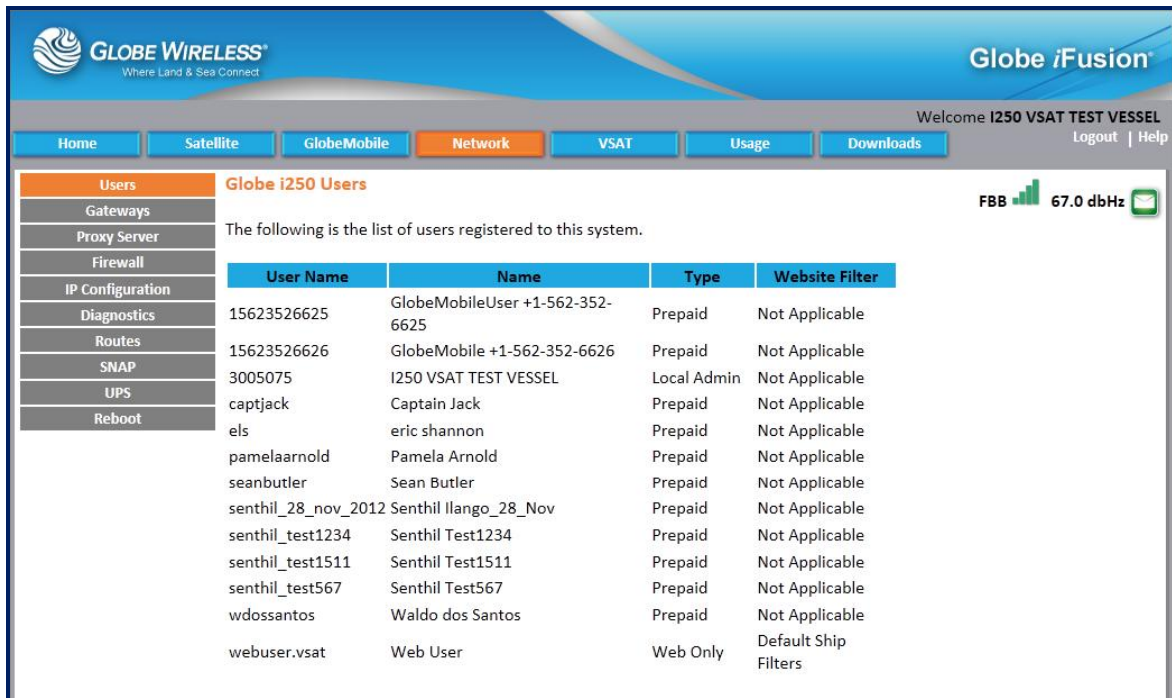

The screenshot shows the 'Network' tab selected in the 'Globe iFusion' interface. The 'Users' sub-tab is active, displaying a list of registered users for the 'I250 VSAT TEST VESSEL'. The interface includes a navigation menu with options like Home, Satellite, GlobeMobile, Network, VSAT, Usage, and Downloads. A sidebar on the left lists various system configuration options such as Gateways, Proxy Server, Firewall, IP Configuration, Diagnostics, Routes, SNAP, UPS, and Reboot. The main content area shows a table of users with columns for User Name, Name, Type, and Website Filter. A status indicator in the top right shows 'FBB 67.0 dbHz'.

User Name	Name	Type	Website Filter
15623526625	GlobeMobileUser +1-562-352-6625	Prepaid	Not Applicable
15623526626	GlobeMobile +1-562-352-6626	Prepaid	Not Applicable
3005075	I250 VSAT TEST VESSEL	Local Admin	Not Applicable
captjack	Captain Jack	Prepaid	Not Applicable
els	eric shannon	Prepaid	Not Applicable
pamelaarnold	Pamela Arnold	Prepaid	Not Applicable
seanbutler	Sean Butler	Prepaid	Not Applicable
senhil_28_nov_2012	Senhil Ilango_28_Nov	Prepaid	Not Applicable
senhil_test1234	Senhil Test1234	Prepaid	Not Applicable
senhil_test1511	Senhil Test1511	Prepaid	Not Applicable
senhil_test567	Senhil Test567	Prepaid	Not Applicable
wdossantos	Waldo dos Santos	Prepaid	Not Applicable
webuser.vsat	Web User	Web Only	Default Ship Filters

Click on the **Network** Tab to display the following sub-tabs: (The **Users** sub-tab is the *default*.)

- Users (*default*)
- Gateways
- Proxy Server
- Firewall
- IP Configuration
- Diagnostics
- Routes
- SNAP
- UPS
- Reboot

The **Network** tab is used to display the configuration of the **Globe iFusion®** network communication settings. This includes interconnections with other satellite terminals, LAN settings, and others.

9.3.1 Users Sub-tab

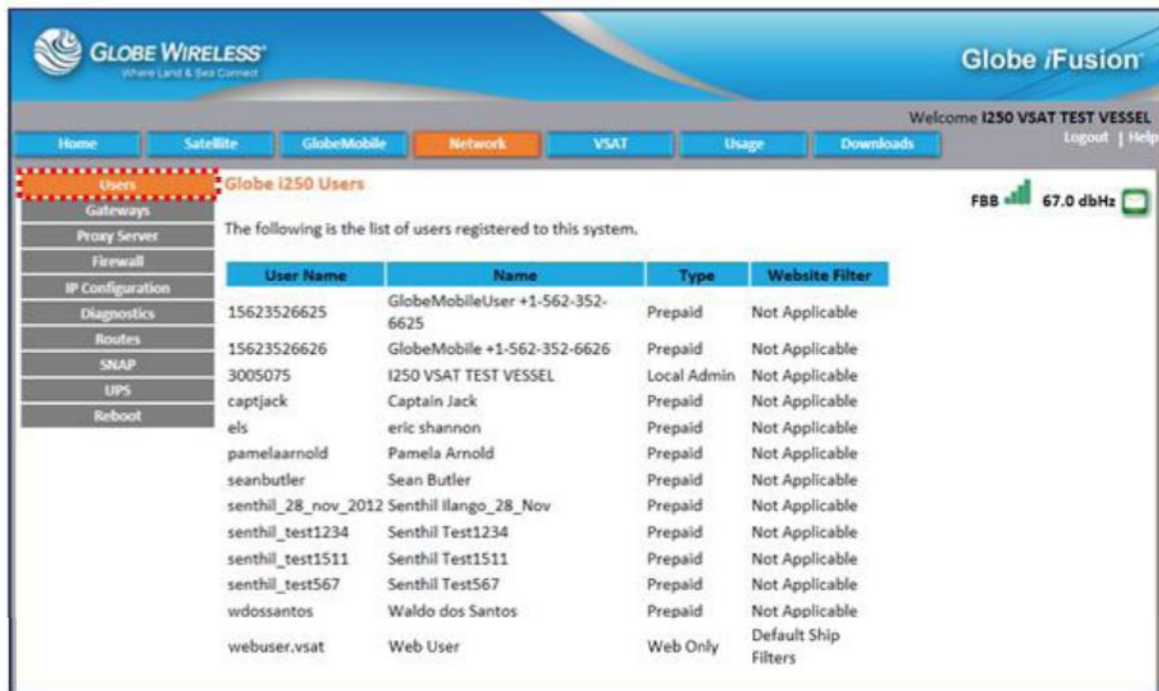

The following is the list of users registered to this system.

User Name	Name	Type	Website Filter
15623526625	GlobeMobileUser +1-562-352-6625	Prepaid	Not Applicable
15623526626	GlobeMobile +1-562-352-6626	Prepaid	Not Applicable
3005075	I250 VSAT TEST VESSEL	Local Admin	Not Applicable
captjack	Captain Jack	Prepaid	Not Applicable
els	eric shannon	Prepaid	Not Applicable
pamelaarnold	Pamela Arnold	Prepaid	Not Applicable
seanbutler	Sean Butler	Prepaid	Not Applicable
senthil_28_nov_2012	Senthil ilango_28_Nov	Prepaid	Not Applicable
senthil_test1234	Senthil Test1234	Prepaid	Not Applicable
senthil_test1511	Senthil Test1511	Prepaid	Not Applicable
senthil_test567	Senthil Test567	Prepaid	Not Applicable
wdossantos	Waldo dos Santos	Prepaid	Not Applicable
webuser.vsat	Web User	Web Only	Default Ship Filters

The **Users** sub-tab displays the **User Name** (logon ID), **GlobeMobile phone number**, and the **Type** of user; i.e., **Prepaid** (email), **Administrator**, or **Web only**.

The list reflects the users currently registered on the vessel and what type of user they are.

- **Prepaid** users who use their phone number as their username, are listed only when they have activated a GSM phone with a Globe Wireless SIM card inside it while on the vessel
- The **Admin** account will always be listed
- **Web Only** accounts are permanent to the vessel but are created using the **Globe iPortal**[®]



It can take up to 20 minutes for a **Prepaid** account to appear on the user list after mobile phone activation.

9.3.2 Gateways

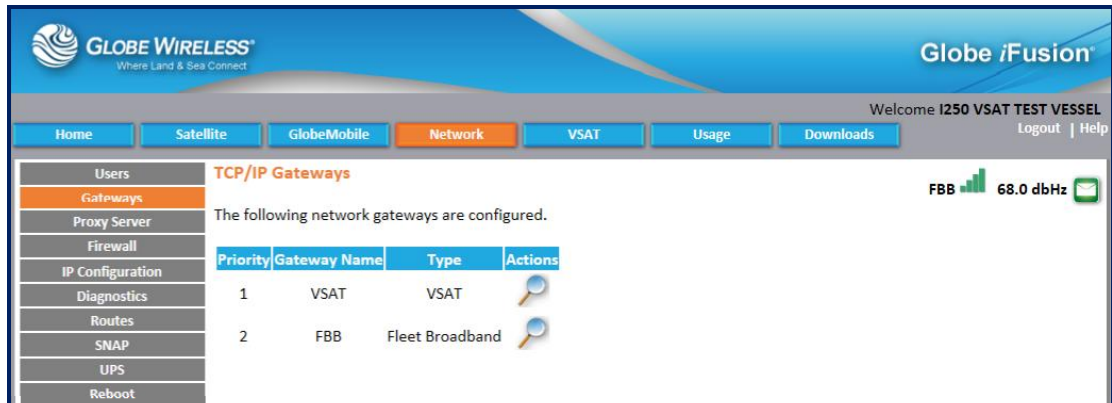

Click on the **Gateways** tab to display the **TCP/IP Gateways** screen. This screen displays the network gateways that are configured to include their **Priority**, **Gateway Name**, **Type**, and **Actions**.

Gateways are the connections to the Globe Wireless Network via communications devices such as satellite terminals, UMTS devices, 803.11 wireless connections, and any other TCP/IP device. These devices are managed via the Globe iPortal® and are read-only in the **Globe iFusion®** web interface.

Step 1: In the **Actions** column, click on  to display the **View Gateway** screen.



The **View Gateway** screen displays the *Gateway Type*, *Name*, *IP Address*, *Alias IP Address*, *Subnet Mask*, *Park Time*, *Hold Off*, and *Check Time* fields.

Step 2: Click the **Back** button to return to the main **TCP/IP Gateways** screen.

9.3.3 Proxy Server

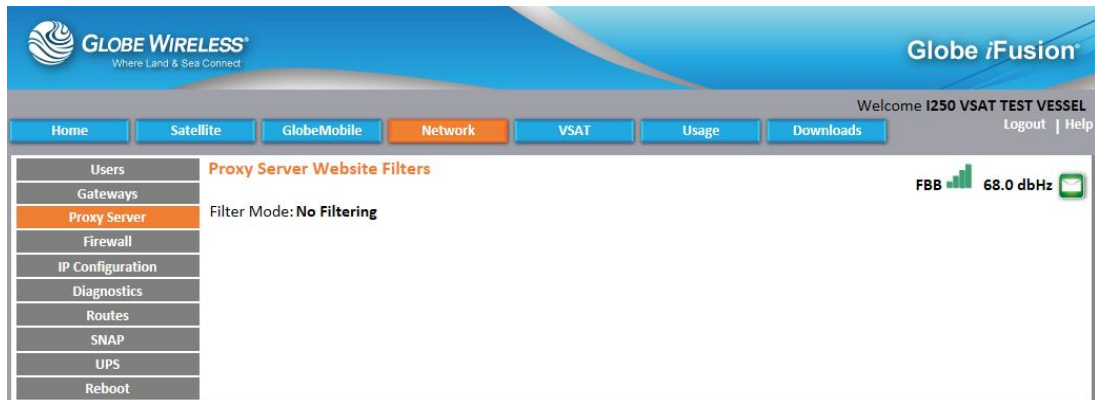

Click on the **Proxy Server** tab to display the **Proxy Server Website Filters** screen. There are three different modes used by the proxy server; the selected mode is displayed in the **Filter Mode:** field. These modes are:

- **No Filtering** – all websites are accessible
- **Block Selected Sites** – Domains listed are blocked and cannot be accessed
- **Allow Only Selected Sites** – Only the Domains listed can be accessed

Domains are listed as simple match strings. The text `bbc` matches “`bbc.com`”, “`bbc.net`”, etc., and it also matches “`www.bbc.co.uk`” as well as “`bbcooks.com`”.

9.3.4 Firewall

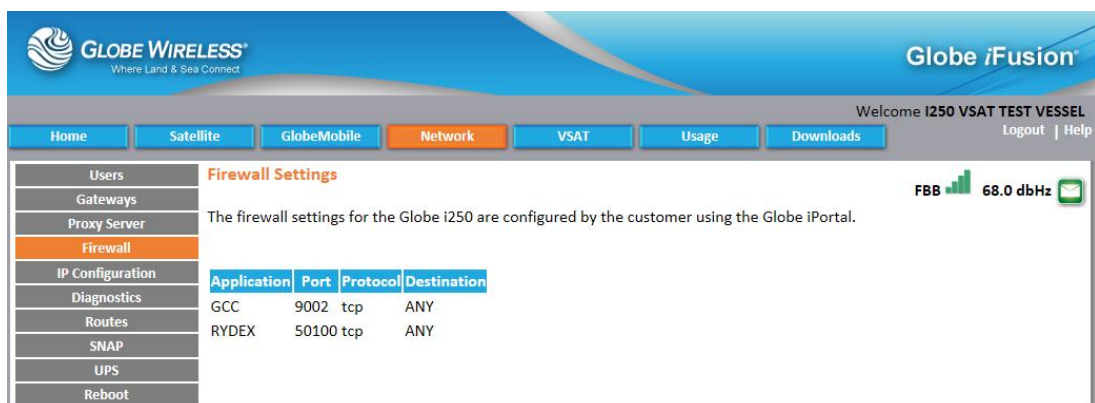

Click on the **Firewall** tab to display the **Firewall Settings** screen.



The **Firewall Settings** for the **Globe iFusion®** are configured by the customer using the **Globe iPortal**.

This screen displays a *read-only* listing of the following:

- **Application** – The program or type of service which uses the port
- **Port** – The Internet Protocol port opened
- **Protocol** – This is either TCP or UDP
- **Destination** – If any destination hosts were specified, they will be listed here

9.3.5 IP Configuration

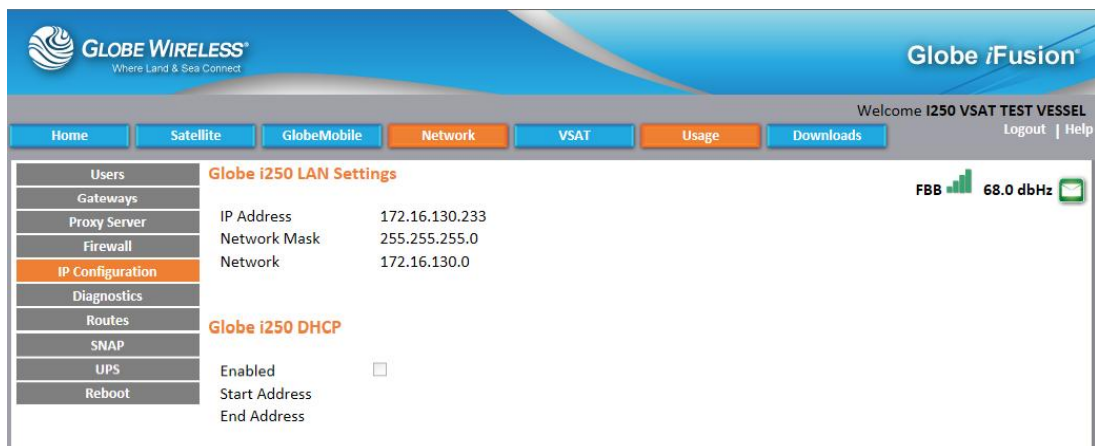

Users	Globe i250 LAN Settings	
Gateways	IP Address	172.16.130.233
Proxy Server	Network Mask	255.255.255.0
Firewall	Network	172.16.130.0
IP Configuration		
Diagnostics		
Routes	Globe i250 DHCP	
SNAP	Enabled	<input type="checkbox"/>
UPS	Start Address	
Reboot	End Address	

Click on the **IP Configuration** tab to display the **Globe iFusion® LAN Settings** and **Globe iFusion® DHCP Settings** screen which displays the current settings. These settings are *read only* and reflect the settings used by the **Globe iFusion®** on the rear physical ports labeled LAN 1 through LAN 4.

Dynamic Host Configuration Protocol (DHCP) is used to automatically configure the IP address, subnet mask, and default gateway of computers and other networking devices that request configuration. The **Start** and **End** addresses show the range of IP addresses which will be given to these devices.



You cannot manually assign IP addresses to computers or devices in this range when **DHCP** is enabled.

9.3.6 Diagnostics

Click on the **Diagnostics** tab to display the **Network Diagnostics** screen.

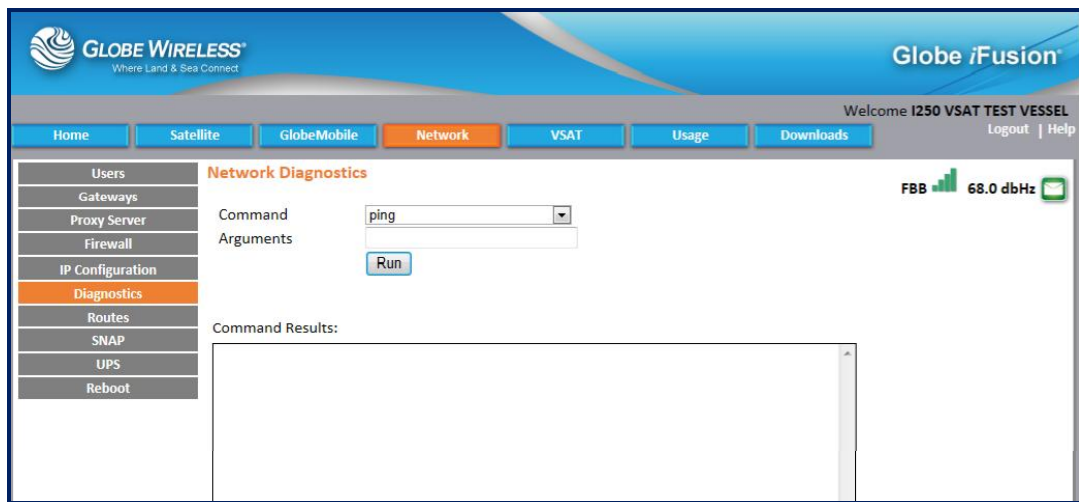

The Administrator can perform the following actions on this screen:

- Step 1: Click the **Command** drop-down arrow and make a selection from the drop-down list.

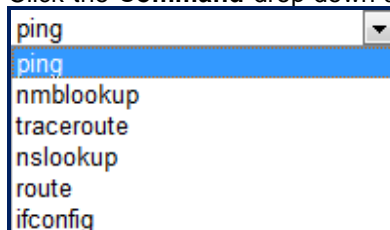

- Step 2: Type an **Argument** in the field if applicable, and click the **Run** button. The results will be displayed in the **Command Results** area of the screen.

Network Diagnostics

Command:

Arguments:

Command Results:

```

2 Usage: ping [-LRUbdnqrVvAaD] [-c count] [-i interval] [-w deadline]
[-p pattern] [-s packetsize] [-t ttl] [-I interface]
[-M pmtudisc-hint] [-m mark] [-S sndbuf]
[-T tstamp-options] [-Q tos] [hop1 ...] destination
          
```

9.3.7 Routes

Click on the **Routes** tab to display the **Static Routes** screen which displays the currently configured **Static Routes** and **Current Routing Table**.



Static Routes

No static routes have been configured.

Current Routing Table

Kernel IP routing table

Destination	Gateway	Genmask	Flags	Metric	Ref	Use	Iface
38.105.9.137	10.95.95.200	255.255.255.255	UGH	0	0	0	eth1
38.105.9.126	10.95.95.200	255.255.255.255	UGH	0	0	0	eth1
38.105.9.127	10.95.95.200	255.255.255.255	UGH	0	0	0	eth1
38.105.9.93	10.95.95.200	255.255.255.255	UGH	0	0	0	eth1
38.105.9.125	10.95.95.200	255.255.255.255	UGH	0	0	0	eth1
38.105.9.91	10.95.95.200	255.255.255.255	UGH	0	0	0	eth1
38.105.9.129	10.95.95.200	255.255.255.255	UGH	0	0	0	eth1
173.226.17.10	10.95.95.200	255.255.255.255	UGH	0	0	0	eth1
38.105.9.128	10.95.95.200	255.255.255.255	UGH	0	0	0	eth1
38.105.9.130	10.95.95.200	255.255.255.255	UGH	0	0	0	eth1
203.88.69.230	10.95.95.200	255.255.255.255	UGH	0	0	0	eth1
173.226.17.9	10.97.97.35	255.255.255.255	UGH	0	0	0	eth1
203.88.69.225	10.95.95.200	255.255.255.255	UGH	0	0	0	eth1
38.105.9.97	10.95.95.200	255.255.255.255	UGH	0	0	0	eth1
172.16.130.0	0.0.0.0	255.255.255.0	U	0	0	0	eth0
10.97.98.0	0.0.0.0	255.255.255.0	U	0	0	0	br0
10.95.95.0	0.0.0.0	255.255.255.0	U	0	0	0	eth1
10.97.97.0	0.0.0.0	255.255.255.0	U	0	0	0	eth1
10.10.99.0	0.0.0.0	255.255.255.0	U	0	0	0	eth1
10.107.1.0	0.0.0.0	255.255.255.0	U	0	0	0	br1
10.98.98.0	0.0.0.0	255.255.255.0	U	0	0	0	eth0
169.254.0.0	0.0.0.0	255.255.0.0	U	0	0	0	eth0
127.0.0.0	0.0.0.0	255.0.0.0	U	0	0	0	lo
0.0.0.0	10.97.97.35	0.0.0.0	UG	0	0	0	eth1

Static routes configured in the **Globe iFusion®** are for the local area network only; they cannot be added for one of the WAN interfaces. Routes are configured from shore using the **Globe iPortal** and are most common in any configuration where the **Globe iFusion®** is connected to the shipboard LAN via a router or smart switch.

The current routing table of the **Globe iFusion®** is displayed below the statically configured routes so that if there are any irregularities in routing, a network administrator can deduce the cause.

Refresh the current routing table by clicking 

9.3.8 SNAP

Click on the **SNAP** tab to display the **Port Forwarding** screen which displays the *read only* **Ports** table. The **Local Port**, **Target Host**, **Target Port**, and **Description** of each are displayed.

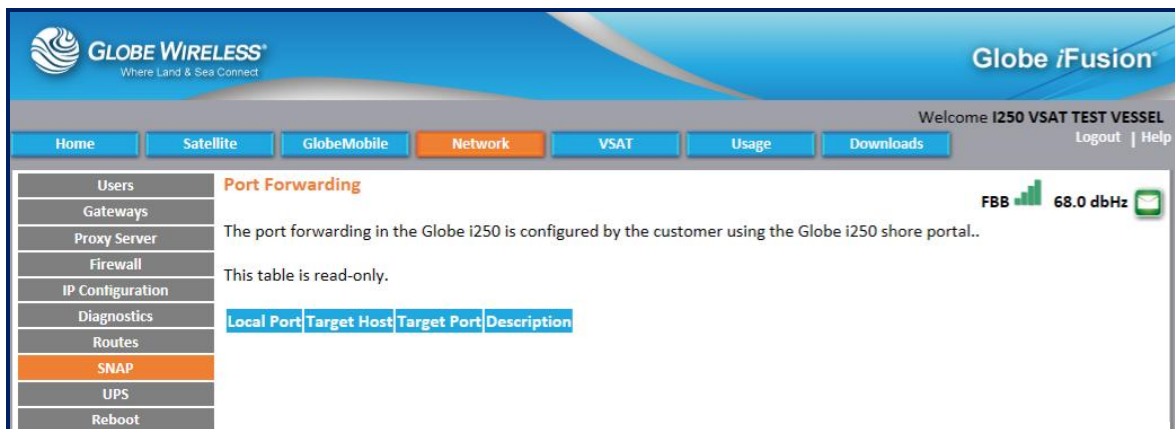

The screenshot shows the Globe iFusion web interface. The top navigation bar includes Home, Satellite, GlobeMobile, Network (selected), VSAT, Usage, and Downloads. The main content area is titled "Port Forwarding" and contains the following text:

The port forwarding in the Globe i250 is configured by the customer using the Globe i250 shore portal..

This table is read-only.

Local Port	Target Host	Target Port	Description

On the left side of the interface, a sidebar menu lists various configuration options: Users, Gateways, Proxy Server, Firewall, IP Configuration, Diagnostics, Routes, SNAP (highlighted), UPS, and Reboot. The top right corner of the interface displays "Welcome I250 VSAT TEST VESSEL" and "Logout | Help". A signal strength indicator shows "FBB 68.0 dbHz".

GlobeSNAP (Secure Network Access Protocol) is a secure method for gaining access over shipboard computers from the shore. Each computer which must be controlled by a shore **GlobeSNAP** user must have a port forwarding rule configured.

The Port Forwarding rules begin with the port 6500 and go up to 6599. It is important ensure that the IP Addresses and port numbers of the **Target Host** and **Target Port** are correct for the remote control connection being used. The **Description** should help the shipboard user identify the computer by its use or name.

9.3.9 UPS

Click on the **UPS** tab to display the screen showing the status of any detected UPS. If *Enabled*, a checkmark will be visible in the checkbox.

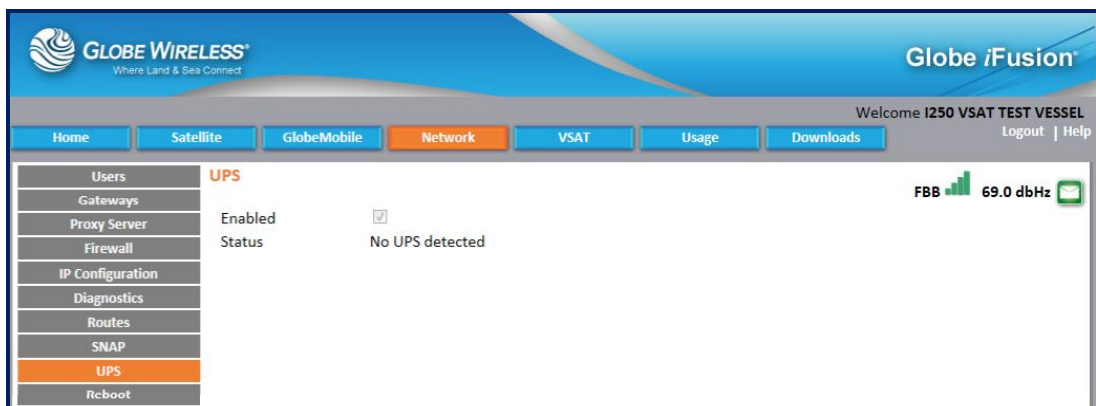

9.3.10 Reboot

Click on the **Reboot** tab to display the **Administrative Function: Restart / Shut-Down** screen. From here, the Administrator can click on the **Restart** button to Reboot or the **Shut Down** button to turn off power to the **Globe iFusion®** remotely.

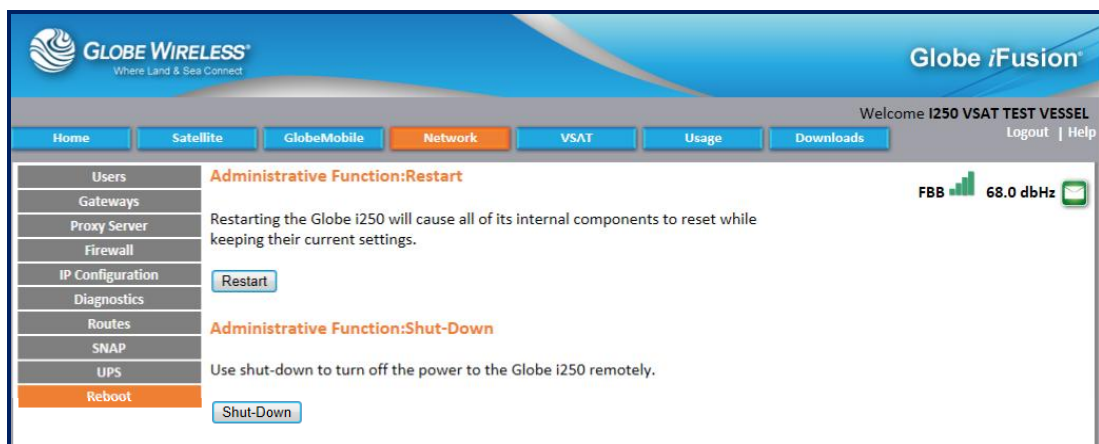

Rebooting the **Globe iFusion®** using this web interface can become necessary if the **Globe iFusion®** is locked in a closet or other storage area where accessing it is difficult or impossible.



Normally, the **Globe iFusion®** should not need to be rebooted, and should only be done so on the advice of **Globe Wireless Customer Support**.

9.4 VSAT Tab

Click on the **VSAT** tab to display the **VSAT** screen.

In process

The VSAT screen contains the following sub-tabs:

- Status (*default*)
- VSAT ACU
- VSAT Log

9.4.1 VSAT Status (*default screen*)

The **Status** tab is the *default* tab when **VSAT** is selected.

In process

Click on the **Status** link to display the **Globe iFusion® VSAT Status and Control**.

Signal	Green bars indicate signal strength of the equipment
Temperature	Indicates if the equipment temperature is within the normal range
GPS	Displays the GPS coordinates : GPS Date GPS Latitude GPS Longitude GPS Course GPS Speed

Registered	A green checkmark indicates that the Globe iFusion® has connected to the satellite and has registered with the Inmarsat shore system.
Data Connection	Displays the connection address
Azimuth	Displays current Azimuth .
Elevation	Displays current Elevation .

9.4.2 VSAT ACU

In process

9.4.3 VSAT Log

In process

9.5 Usage Tab



The screenshot shows the Globe iFusion web interface. At the top left is the Globe Wireless logo. The main navigation bar includes buttons for Home, Satellite, GlobeMobile, Network, VSAT, Usage (highlighted in orange), and Downloads. On the right, it says "Welcome I250 VSAT TEST VESSEL" and "Logout | Help". Below the navigation bar, the "Usage Details" section is active, showing "Usage (not reconciled)". On the right side of this section, there is a signal strength indicator (FBB) and a battery icon with "67.0 dbHz". At the bottom, a table header is visible with columns: Date, From, To, and Units.

9.5.1 Usage Details Sub-Tab

In process

9.6 Downloads Tab

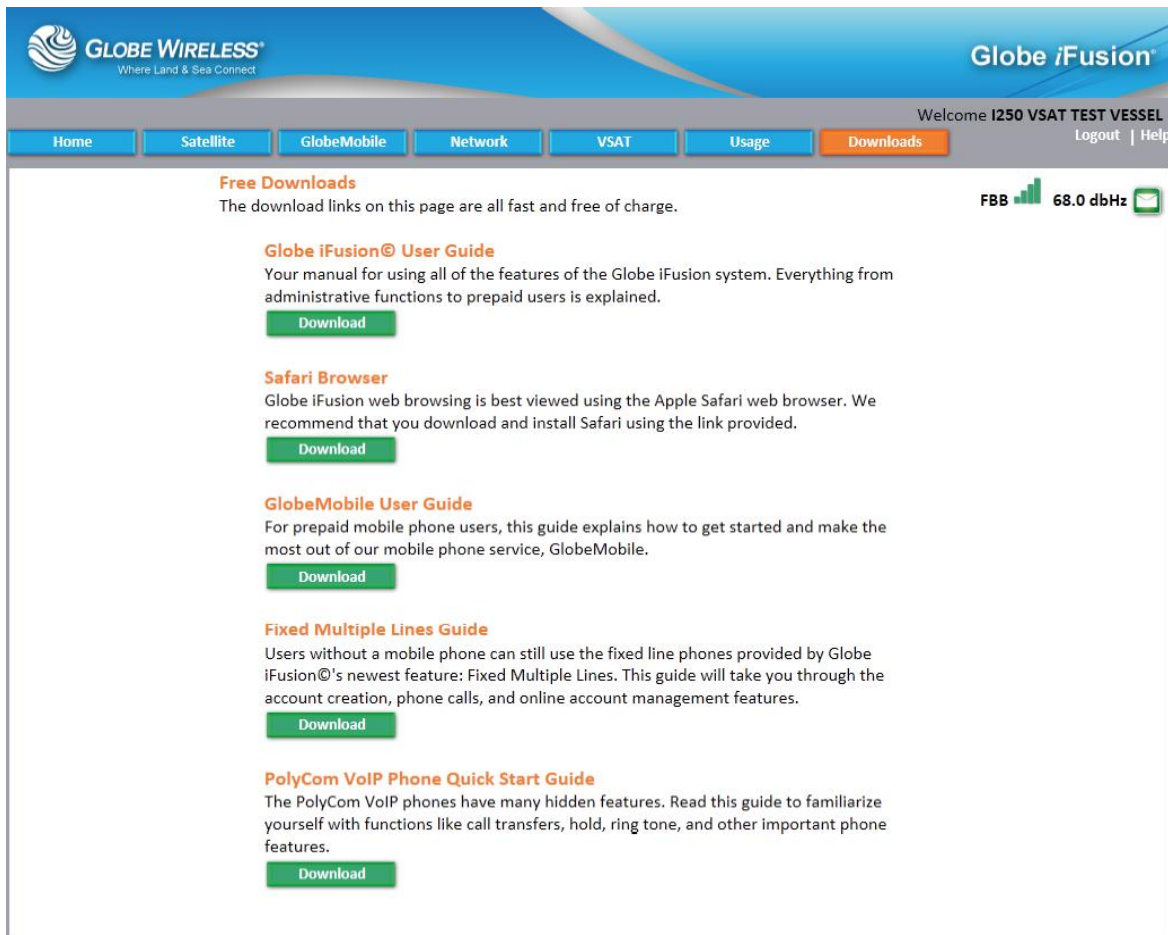

The screenshot shows the 'Downloads' tab in the Globe iFusion system. The page header includes the Globe Wireless logo and the text 'Globe iFusion'. A navigation menu contains 'Home', 'Satellite', 'GlobeMobile', 'Network', 'VSAT', 'Usage', and 'Downloads'. The main content area is titled 'Free Downloads' and contains five download links, each with a description and a 'Download' button. The links are: 'Globe iFusion® User Guide', 'Safari Browser', 'GlobeMobile User Guide', 'Fixed Multiple Lines Guide', and 'PolyCom VoIP Phone Quick Start Guide'. A status bar at the top right shows 'Welcome I250 VSAT TEST VESSEL', 'Logout | Help', and a signal strength indicator 'FBB 68.0 dbHz'.

- Step 1: Click on the **Downloads** tab to display all downloadable data.
- Step 2: Select a download you wish to perform and press the download button.
- Step 3: Follow the steps displayed to complete the download.



SWG-125 Rev. G

June 2013

Step 4: If there are additional downloads you wish to perform, repeat the above steps.

10.0 Prepaid Users

When the **Prepaid User** logs in to the **Globe iFusion®**, the *default* **Email Inbox** screen is displayed.

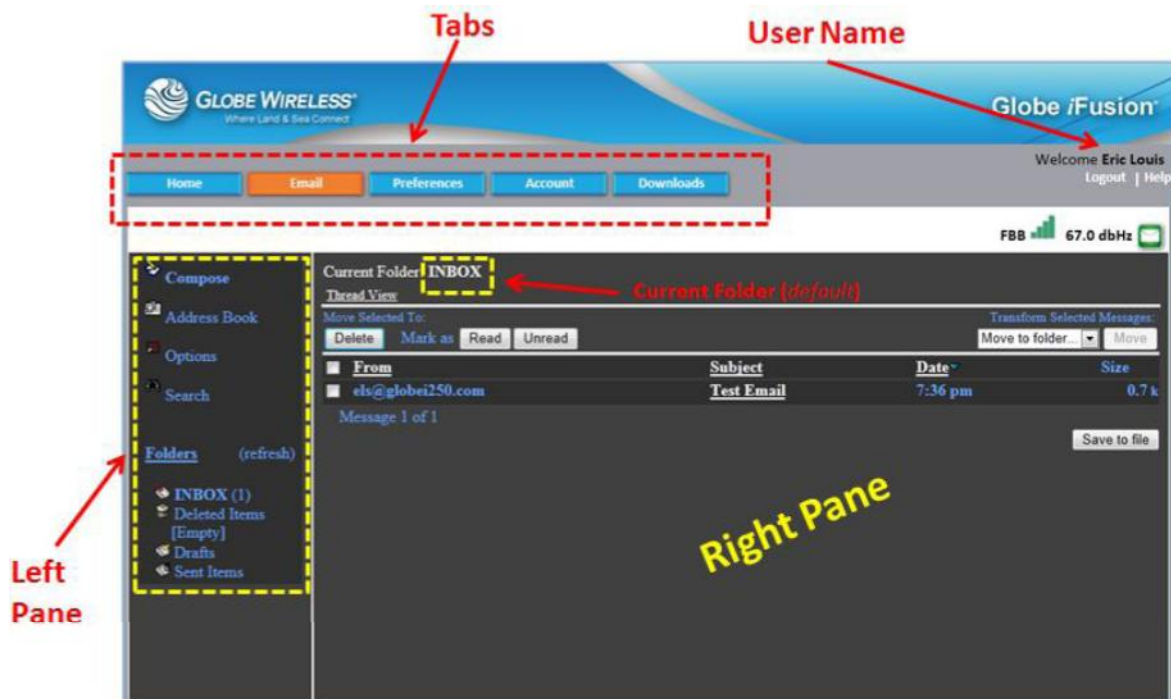

The **Prepaid User** screen contains the following tabs:

- [Home Tab](#)
- [Email \(default\) Tab](#)
- [Preferences Tab](#)
- [Account Tab](#)
- [Downloads Tab](#)

10.1 Home Tab

Click the **Home Tab** to display the **Communication Status** screen showing the **Gateway Status** and **Services** (e.g., prepaid email and prepaid GSM).

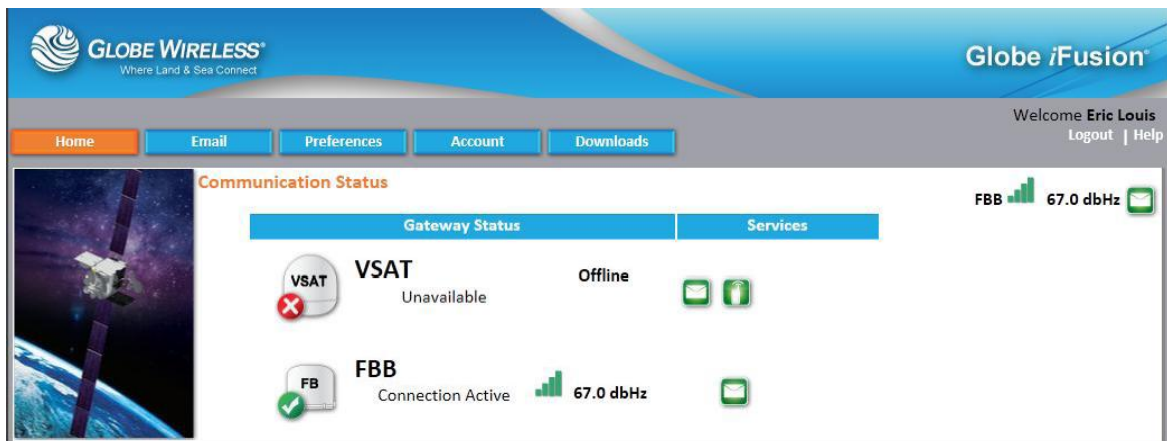

The screenshot shows the 'Communication Status' page in the Globe iFusion interface. The page has a blue header with the Globe Wireless logo and 'Globe iFusion' text. Below the header is a navigation bar with buttons for Home, Email, Preferences, Account, and Downloads. The main content area is titled 'Communication Status' and features a satellite image on the left. The main content is divided into two columns: 'Gateway Status' and 'Services'. Under 'Gateway Status', there are two entries: 'VSAT' which is 'Unavailable' and 'Offline', and 'FBB' which is 'Connection Active' with a signal strength indicator of '67.0 dbHz'. The 'Services' column shows two active service icons. In the top right corner, there is a status bar showing 'FBB' with a signal strength indicator and '67.0 dbHz'.

10.2 Email Tab (default)

Click the **Email** tab to display the prepaid user email (**inbox** is the *default*).

The left pane of the **Inbox** is where the user will perform such tasks as:

- Compose new email messages
- Manage the address book
- Set options
- Perform searches
- Monitor the folders such as *inbox*, *deleted items*, *drafts*, and *sent mail*

The following sub-sections describe each function in the *left frame* of the **Email** tab:

10.2.1 Compose a Message

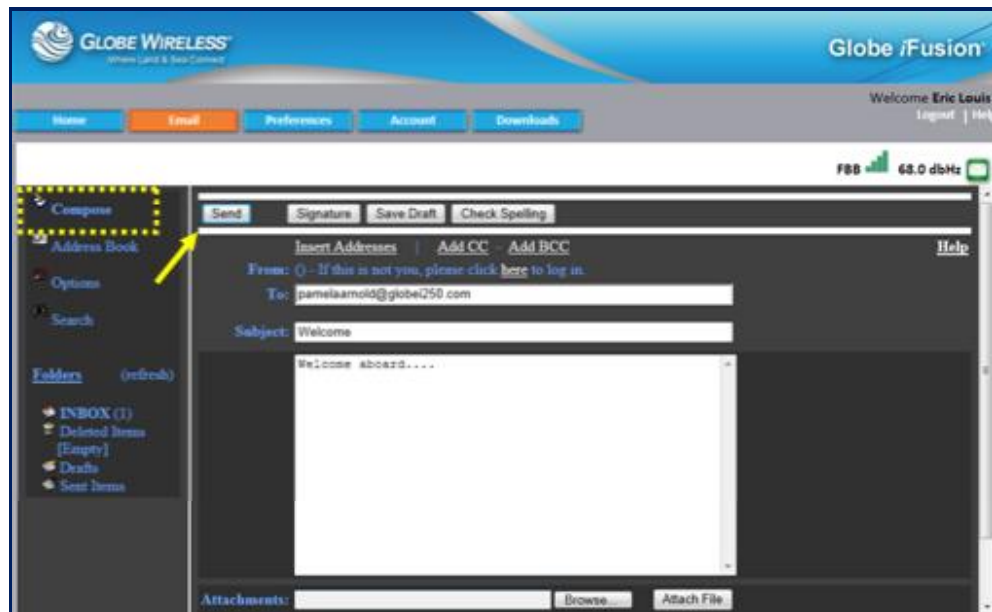

- Step 1: Click **Compose** to open the *compose* email screen.
- Step 2: Populate the **To:** and **Subject:** fields; then type your message in the message body area.
- Step 3: Click **Send**.
- Step 4: If you wish to attach a file to the message, click on the **Browse** button and locate the file you wish to attach.

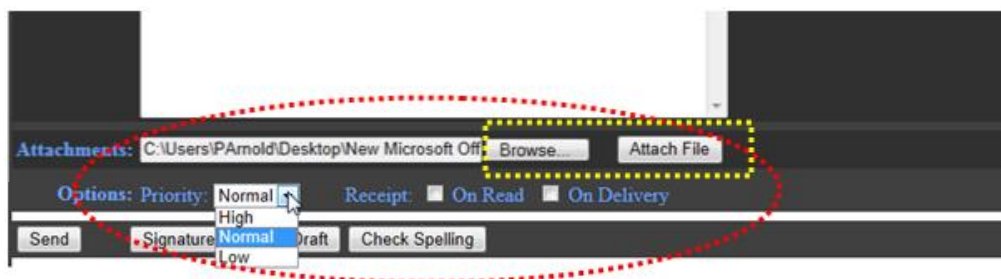

- Step 5: Once the file has been located, it is displayed in the **Attachments:** area at the bottom of the screen.

Step 6: Click the **Priority**: drop-down arrow and select *High*, *Normal*, or *Low* priority.

Refer to the following table for options that can be selected by the sender:

Option	Purpose
Signature	Click to add a signature to your email message. A signature is a way to sign a message and usually includes at the very least, the user's name. A professional signature might also include title, company, and contact information.
Save Draft	Click to place a copy of the message into your Draft folder.
Check Spelling	Click to run the spell check application in the message prior to sending.
Priority	High, Normal, Low (<i>self explanatory</i>)
Receipt options:	If you (the sender) would like confirmation the email has been received, click to place a checkmark in a checkbox depending if you wish to know when it has <i>been read</i> , or when it has <i>been delivered</i> to the recipient's inbox.

10.2.2 Address Book

The **Address Book** contains all the email contacts in alphabetical order. Click on a letter to view the email contacts starting with that particular letter or click **All** to view all contacts in the address book.

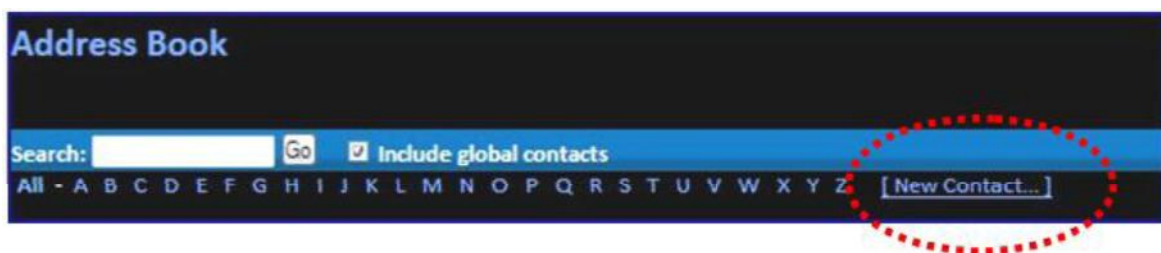

10.2.2.1 Add a new Contact

Step 1: Click the **New Contact** link to display the **Add Contact** screen.

Step 2: Populate the applicable fields (i.e., Name, email, etc.)

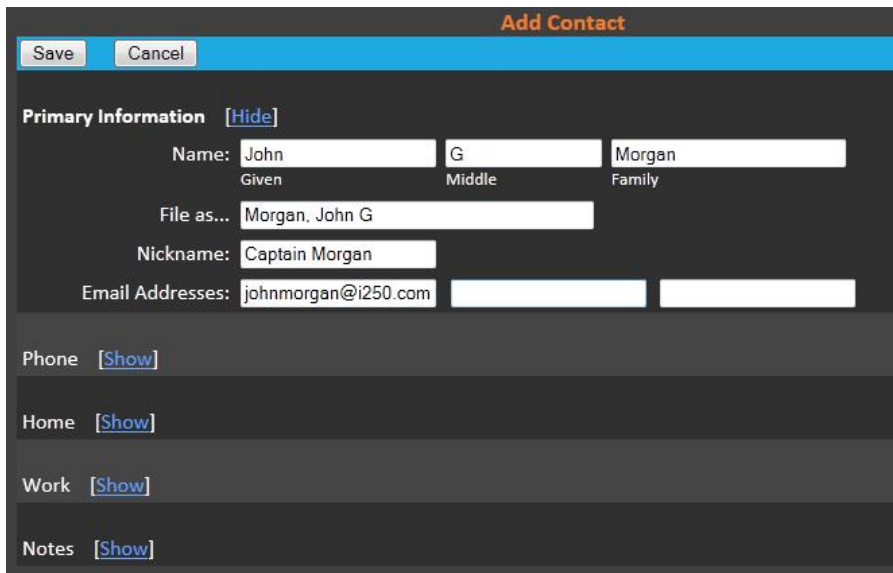

Note: You also have the option of adding additional information such as phone numbers, home/work information, and notes. Click on **Show** to display the populated field(s) and **Hide** to hide the fields, thus not displaying any information.

Step 3: Click the **Save** button. The address was added successfully is displayed at the bottom of the screen.

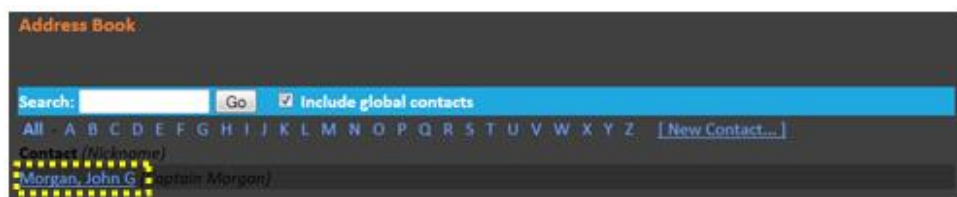

10.2.2.2 Search for a contact

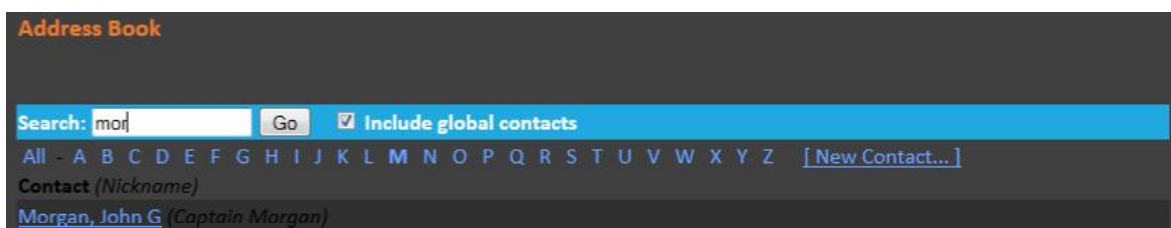

Step 1: Type part of the contact name in the **Search:** field.

Step 2: Click the **Go** button to display all contacts beginning with the search criteria entered.

Note: You may also search for a contact by clicking on a letter (i.e., '**A**') to display all contacts beginning with the letter pressed. Press '**All**' to display a list of all contacts in the address book.

10.2.2.3 Edit or Delete a Contact

Step 1: Locate the contact you wish to edit or delete.



Step 2: Click the **Delete** button to delete the record.

Step 3: Click the **Edit** button to display the contact information screen.

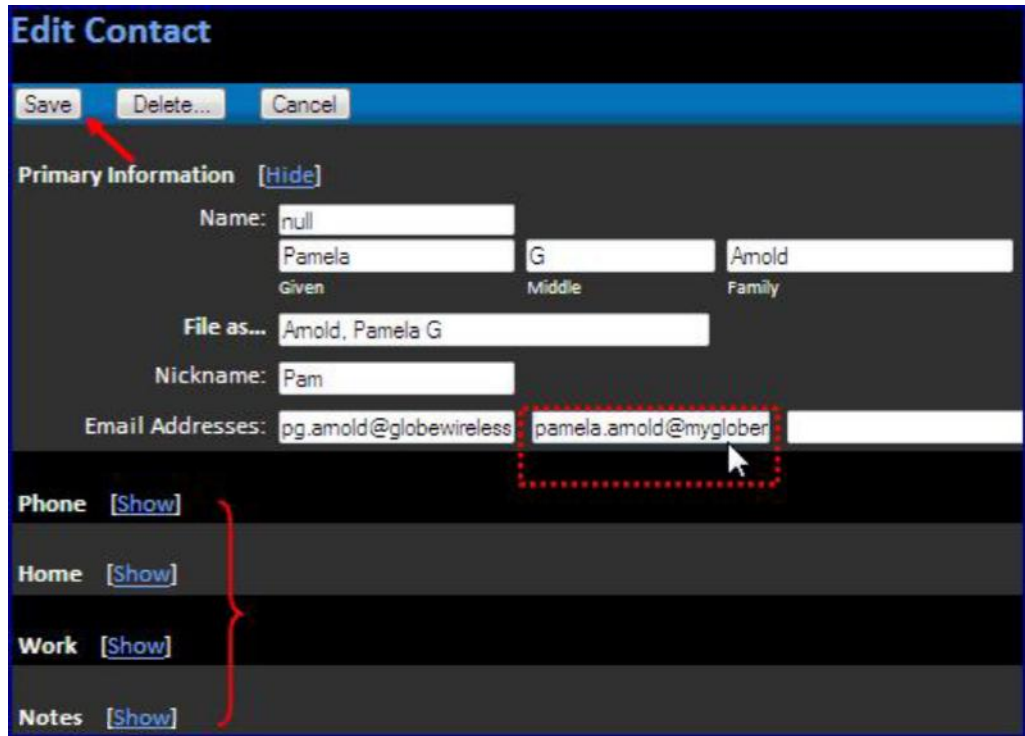

Step 4: Make desired changes and click the **Save** button.

Note: You can also edit additional information such as phone numbers, home/work address, and notes as well. Click on **Show** to display the fields and **Hide** to hide the fields.

10.2.3 Options



Click the **Options** link from the left pane of the screen. The user has the option of setting the following:

- Personal Information
- Display Preferences
- Message Highlighting
- Folder Preferences

10.2.3.1 Personal Information

Personal Information contains information about the user such as name, email address, signature if desired, etc.

The following fields are addressed on the **Personal Information** screen:

Field	Description
Full Name:	The entire name of the user, for example, "John Doe". This is displayed to the recipients of a message. When this is not populated, the recipient will only see the email address, jdoe@mydomain.org .
Signature:	A signature is a way to sign a message and usually includes at the very least, the user's name. A professional signature might also include title, company, and contact information.
Time zone Options:	Same as Server is the <i>default</i> . Click the drop-down arrow and select the time zone of the user.
Reply Citation	No Citation is the <i>default</i> . To change, click the drop-down arrow and

Field	Description
Options	select the desired option: AUTHOR Wrote On DATE AUTHOR Wrote Quote Who XML User-Defined <hr/> Note: For User-Defined Citation, enter the Citation Start: and Citation End: in the applicable fields.
Signature Options:	Click to place a checkmark in the checkbox for one or both options if desired. (A blank checkbox provides no signature or prefix.) Use Signature Prefix Signature with ‘—’ Line

Step 1: Referring to the table, populate the fields on the personal Information screen.



Step 2: Click the **Submit** button when complete.

10.2.3.2 Display Preferences

Use **Display Preferences** to change the way the Webmail looks and displays information to the user.

The following fields are addressed on the **Display Preferences** screen:

Field	Description
Number of Messages per Page	Click the drop-down arrow and select the number of messages to display on a page within a folder. If there are more messages than the desired number to be shown in a folder, Previous and Next will appear above and below the listing, linking to the previous group or subsequent group of messages.
Always Show Full Date:	By <i>default</i> , messages less than a week old show the day and time a message was delivered. After a week, the message will show the full date. To always view the full date, change the default setting from No to Yes .
Wrap Incoming Text At:	Number of characters to allow before wrapping the text. This prevents messages from scrolling way off the screen. 86 is a common value, but it can be changed as desired by the user.
Show HTML Version by Default:	If a message received is in both text and HTML format, the user can choose to view the HTML version. Click to place a checkmark in the checkbox for Yes or leave the field unpopulated for No .
Enable Forward as Attachment:	Click to place a checkmark in the checkbox for Yes or leave the field unpopulated for No .
Include me in CC when I Reply All:	<p>Reply All sends a reply to all recipients of the original message, including the sender. Leave the senders e-mail address out by setting this value to No.</p> <hr/> <p>Note: Since it is a local delivery, the users are not charged by Globe Wireless when they cc: themselves (or other recipients on the same vessel).</p> <hr/>
Cursor Position when Replying	<p>This setting allows placement of the cursor automatically in the TO field or message BODY area when replying to a message. By <i>default</i>, the user is taken to the TO field. Click the drop-down arrow and select the area you wish the cursor to reside:</p> <p>To: field</p>

Field	Description
	Focus in body Select body No focus

Step 1: Referring to the table, populate the fields on the Display Preferences screen.

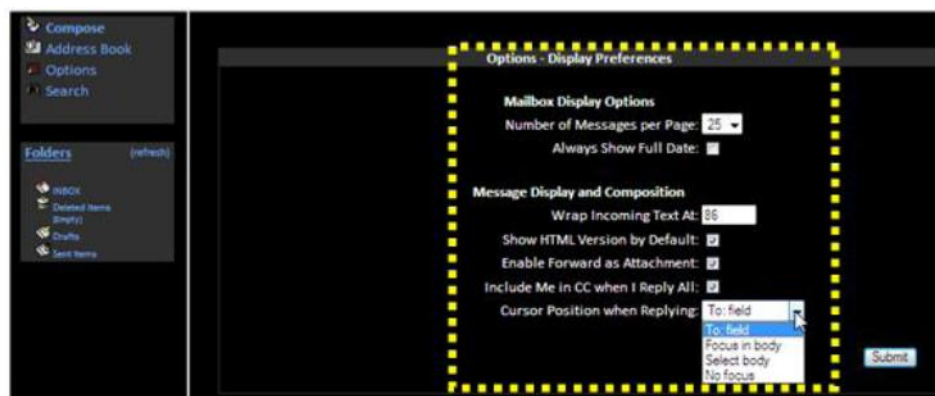

Step 2: Click the **Submit** button when complete.

10.2.3.3 Message Highlighting

If the user is subscribed to many mailing lists, it can be difficult to distinguish which messages came from where while reading through the list of messages. With **Message Highlighting**, the user can set up criteria such as a different background color depending on the sender of the message, priority, or mailing list, etc.

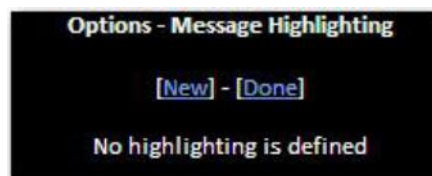

Step 1: Click the New link to display the **Options – Message Highlighting** screen.



The following fields are addressed on the **Display Preferences** screen:

Field	Description
Identifying name:	The name you see which describes what it is. For example, if you are highlighting messages from the customer support department, you might set this to "Customer Support".
Color	The actual color of the background. You can choose between pre-defined colors or you can enter the HEX code for the color that you desire (i.e. a6b492). If you choose to enter your own color, you must also click to select the radio button in front of the selection.
Select from Drop-down:	From To Cc To or Cc Subject
Matches:	The user can choose the matching phrase. From the drop-down box, select which header field to match against (to, from, subject...) and in the text box, you can enter the phrase to match (mom@yahoo.com).



Step 2: Click on **edit** if you wish to change the background color and select the new color.

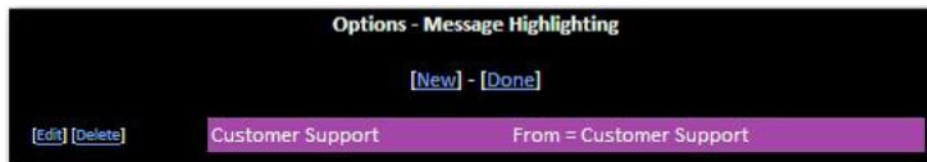

Step 3: When complete, click the **Submit** button.

10.2.3.4 Folder Preferences

In **Folder Preferences**, the user can change the settings as to how folders are displayed and manipulated.

Step 1: Click on the **Folder Preferences** link to display the **Options – Folder Preferences** screen.

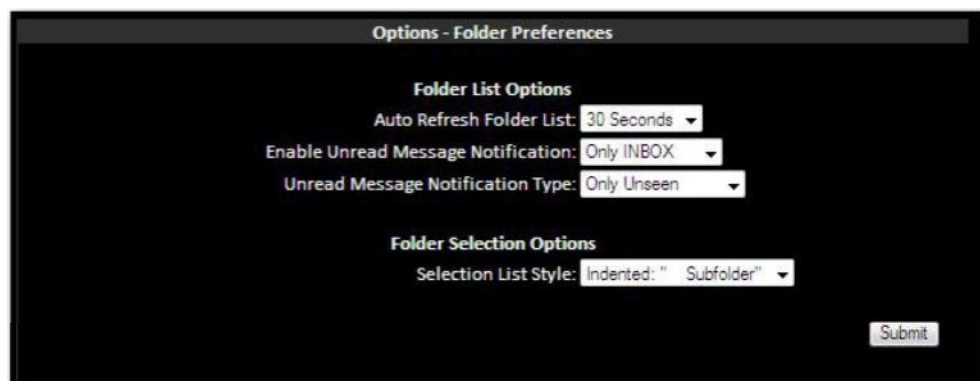

The following fields are addressed in **Folder Preferences**:

Field	Description
Folder LIST Options	
Auto Refresh Folder List:	<p>WebMail has the functionality to automatically refresh the folder listing on the left side of the browser window. This will also update the number of unseen messages that are in each folder. This is a good way to check for unseen messages in the INBOX without having to click on it every time. Click the drop-down arrow and select frequency of desired folder refreshing:</p> <p>Never</p> <p>Every 30 seconds</p> <p>Every 1, 2, 3, or 5 Minutes</p> <p>Every 10 Minutes</p> <p>Every 20 Minutes</p>
Enable Unread Message Notification	<p>Specifies how to display unseen messages in the folder listing. When set to No Notification, the user will not be notified of unseen messages. Set it to INBOX, and whenever a user has new messages, the INBOX will become bold, and the number of messages will display to the right of the inbox. When set to All Folders, the number of messages will be displayed to the right of all folders. Click the drop-down arrow and select:</p> <p>No Notification</p> <p>Only INBOX</p> <p>All Folders</p>
Unread Message Notification Type:	<p>When new messages are in a folder, this option tells either to only display the number of new messages or also display the total number of messages in that folder. Click the drop-down arrow and select:</p> <p>Only Unseen</p> <p>Unseen and Total</p>
Folder SELECTION Options	
Selection List Style:	<p>Click the drop-down arrow and select:</p> <p>Long: "Folder. Subfolder"</p>

Field	Description
	<p>Indented: “ Subfolder”</p> <p>Delimited: “.Subfolder”</p>

Step 2: Once you have defined the fields, click the **Submit** button.

10.2.4 Search

Click **Search** to set parameters to perform a search.



Step 1: Click the drop-down arrow in the **Current Search** field and select the folder from which to perform the search.

Step 2: Type search criteria in the **Search** field.

Step 3: Click the drop-down arrow and select the area to be searched (i.e., only the body of the email or everywhere, etc.)



Step 4: Click the **Search** button to begin the search.

The following is an example; an email message with the word *test* in it needs to be located. The following search criteria are set up to perform the search:

- **All Folders** are to be searched
- The word searched for is **test**
- **Everywhere** is selected so that the word **test** is searched for in all areas of the email messages

Once the **Search** button is pressed, the search begins and results of the search are displayed at the bottom of the screen. The results display exactly where the word “**test**” was located. (Inbox folder; Sent items folder, etc.). In the example, the email message entitled, **Test message** was located in the search.

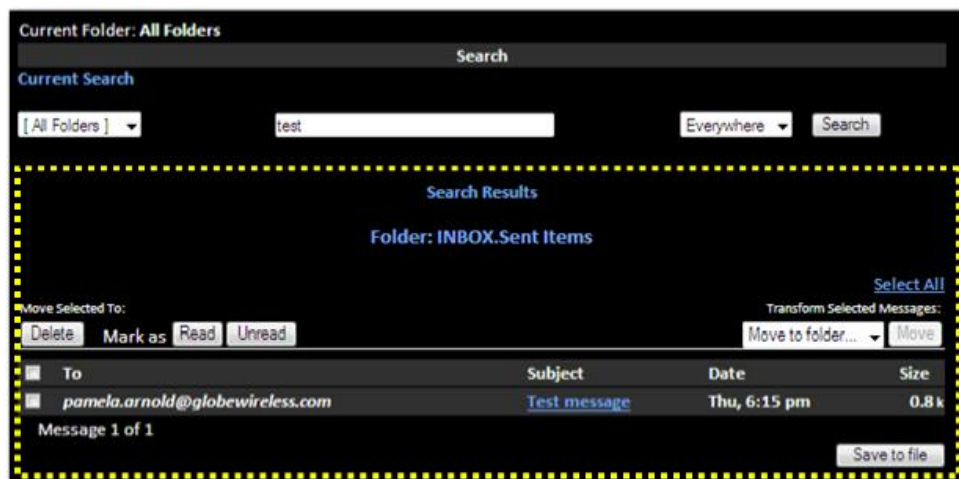

- Step 5: To save the message, click to place a checkmark in the checkbox next to the message you wish to save and click the **Save to File** button to display the **File Download** pop-up screen.

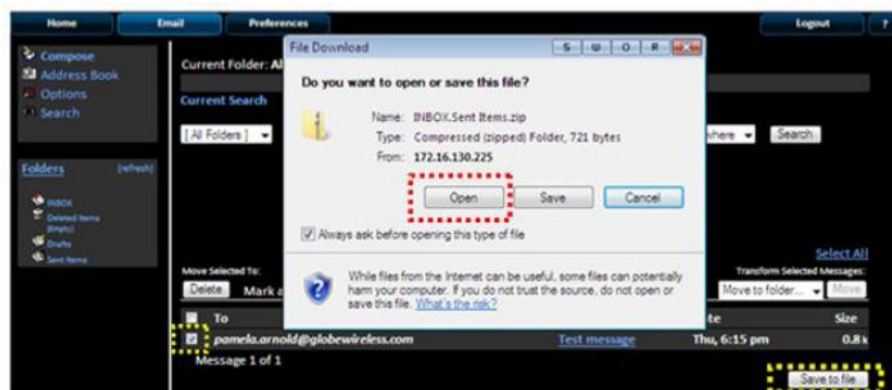

- Step 6: Click the **Open** button to open and view the message or click the **Save** button to display the **Save As** screen.

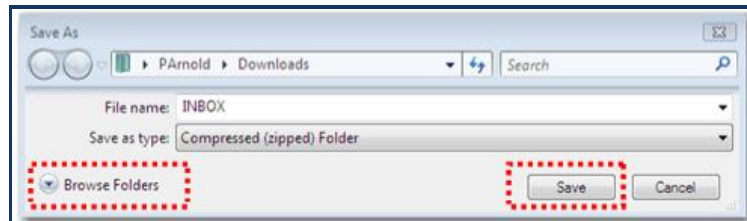

Note: The pop-up screen displays *where the message will be saved, filename* of the saved message, and *type* (compressed (zipped) folder) of file.

Step 7: Click the **Save** button to save the message or if you wish to save it into a different area or folder, click the **Browse Folders** button to navigate to a folder to which you wish to save the message.

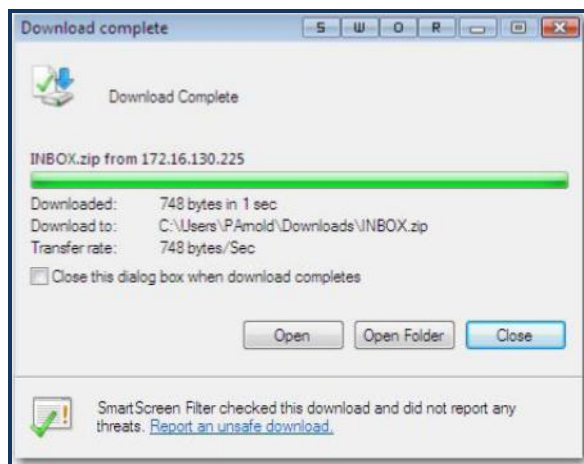

Step 8: The **Download Complete** screen is displayed. At this point you can click either **Open** to view the saved message or **Close**.

10.2.5 Folders Pane

The Folders pane contains default folders such as:

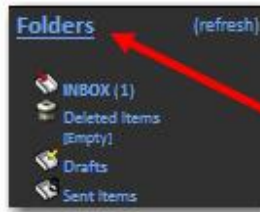

- Inbox
- Deleted Items
- Drafts
- Sent Items

The user can also *create, delete, and rename new folders.*

10.2.5.1 Create a new folder

Step 1: Click on the **Folders** link to display the **Create Folder** screen.



Step 2: Type the name of the folder to create in the field. Click **Create**.

Note: In the above example, a folder named **Private Emails** was previously created; the folder, **Family** becomes a *child* folder of the previously created *parent* folder and is now shown in the **Folders Pane**.



10.2.5.2 Rename a Folder

Step 1: Click the drop-down arrow in the **Rename a Folder** field and select a folder to rename from the drop-down list (e.g., *Private Emails*).

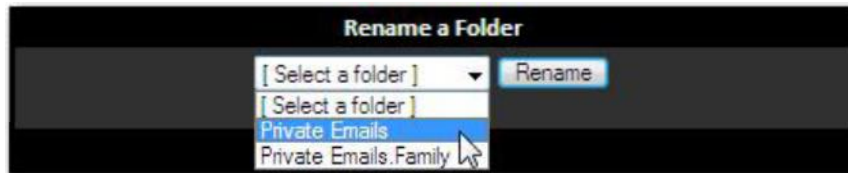

Step 2: Click the **Rename** button.



Step 3: Type the new name of the folder (e.g., *Private*) and click the **Submit** button.

Note: As shown in the following graphic, the *parent* folder has been renamed from **Private Emails** to **Private**. The *child* folder (**Family**) is displayed beneath the renamed *parent* folder.

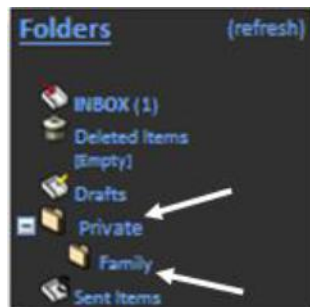

10.2.5.3 Delete a Folder



Step 1: Click the drop-down arrow in the **Delete Folder** field and select a folder to delete (in this example, we will delete the *Parent* folder, **Private**.)

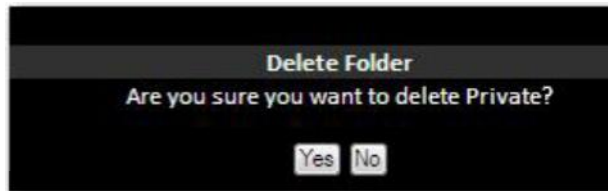

Step 2: Click the **Yes** button. A **Deleted folder successfully** pop-up screen is displayed.

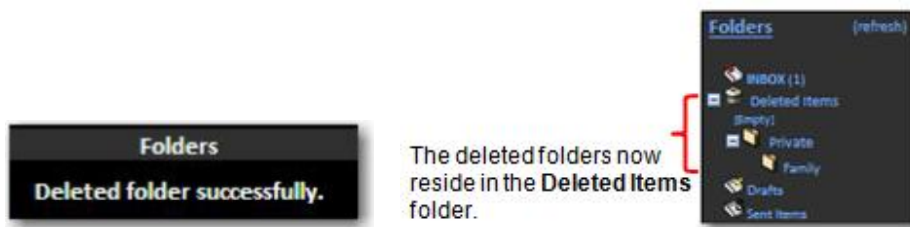

Note: Whenever a *Parent* folder is deleted, all subsequent *child* folders are automatically deleted as well. Both deleted folders now reside in the **Deleted Items Folder** (above graphic).

Step 3: To delete the folders from the **Deleted Items** folder, click on the **[Empty]** link. The deleted *Parent* and subsequent *Child* folders are removed.



10.2.5.4 Unsubscribe / Subscribe

- **Unsubscribing** to a folder is the same as *hiding* it from the folders pane so that it cannot be seen. Performing this action can improve system performance
- **Subscribing** to a folder allows you to view it in the folders pane, thus being notified when new mail arrives to the folder



Step 1: To subscribe/unsubscribe to/from a folder, click to select the folder from the list.

Step 2: Click the **Unsubscribe** or **Subscribe** button.

Note: Prior to unsubscribing from a *parent* folder, you must first unsubscribe from all of the *child* folders.

10.2.5.5 Inbox

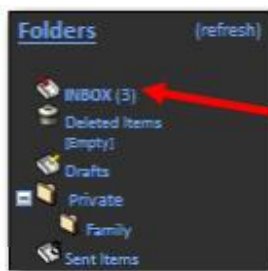

The **INBOX** displays the number of messages residing within.

Step 1: Click on **INBOX** to display the contents of the inbox.

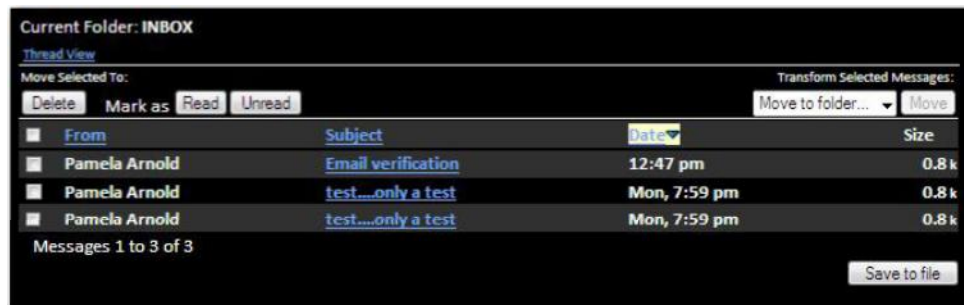

From within the **Inbox**, you have the option to delete a message, mark as *read / unread*, or move one or more messages to another folder.



- Step 2: Click to place a checkmark into the checkbox next to the message to which you wish to take some action.
- Step 3: To delete a message, click the **Delete** button to place the message into the **Deleted Items** folder.
- Step 4: To mark a read message as unread or an unread message as read, click the appropriate button.
- Step 5: To move one or more messages to another folder, click the drop-down arrow in the Move field and select the folder to move the message to from the drop-down list.

Note: To Save a message to file, click the **Save to file** button and refer to Step 5: in the **Folder Preferences** section of this document.

10.2.5.6 Deleted Items Folder



The **Deleted Items** folder contains messages that have been deleted. They remain in this folder until removed permanently.

Step 1: To delete items from the **Deleted Items** folder click on **[empty]** to display the following message:

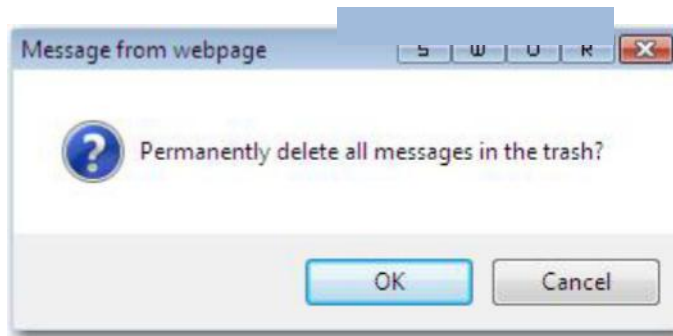

Step 2: Click the **OK** button to complete the action.

10.2.5.7 Drafts Folder



The **Drafts Folder** contains all the draft messages.

Step 1: Click on **Drafts** to display the contents of the folder.

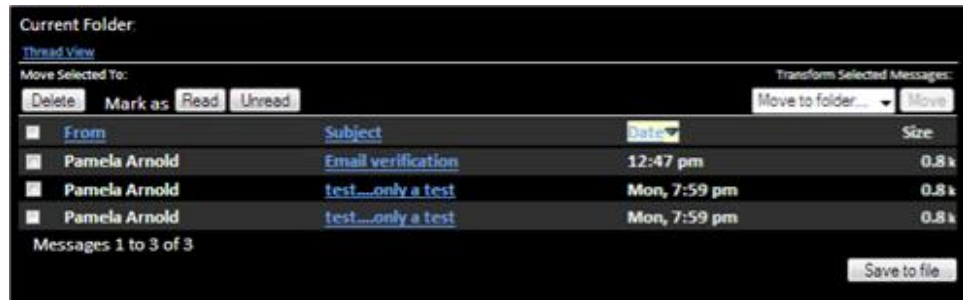

From within **Drafts**, you have the option to delete a draft message, mark as read / unread, or move one or more draft messages to another folder.



- Step 2: Click to place a checkmark into the checkbox next to the draft message to which you wish to take some action.
- Step 3: To delete a draft message, click the **Delete** button to place the message into the **Deleted Items** folder.
- Step 4: To mark a read message as unread or an unread message as read, click the appropriate button.
- Step 5: To move one or more draft messages to another folder, click the drop-down arrow in the **Move** field and select the folder to move the draft message to from the drop-down list.

Note: To Save a message to file, click the **Save to file** button and refer to Step 5: in the **Folder Preferences** section of this document.

10.2.5.8 Sent Items Folder

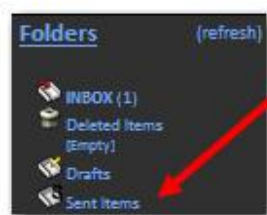

The **Sent Items Folder** contains all the sent messages.

Step 1: Click on **Sent Items** to display the contents of the folder.

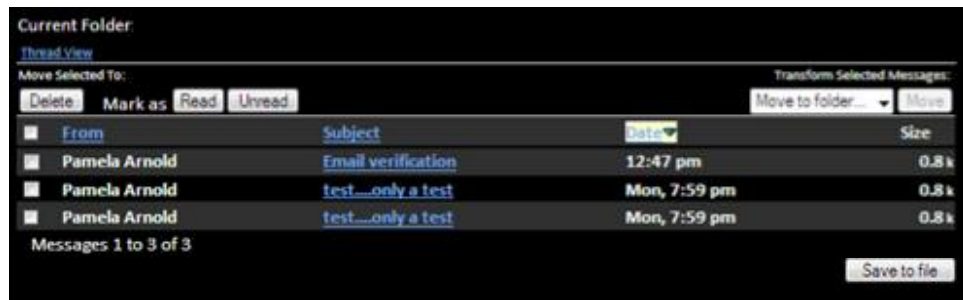

From within **Sent Items**, you have the option to delete a sent message, mark as read / unread, or move one or more sent items to another folder.



Step 2: Click to place a checkmark into the checkbox next to the sent message to which you wish to take some action.

Step 3: To delete a sent message, click the **Delete** button to place the message into the **Deleted Items** folder.

Step 4: To mark a read message as unread or an unread message as read, click the appropriate button.

Step 5: To move one or more sent messages to another folder, click the drop-down arrow in the **Move** field and select the folder to move the sent message to from the drop-down list.

Note: To Save a message to file, click the **Save to file** button and refer to Step 5: in the **Folder Preferences** section of this document.

10.3 Preferences Tab

The **Preferences Tab** contains prepaid user email delivery settings for the currently logged in user. Each user may configure their individual preferences.

Click the **Preferences Tab** to display the following screen.

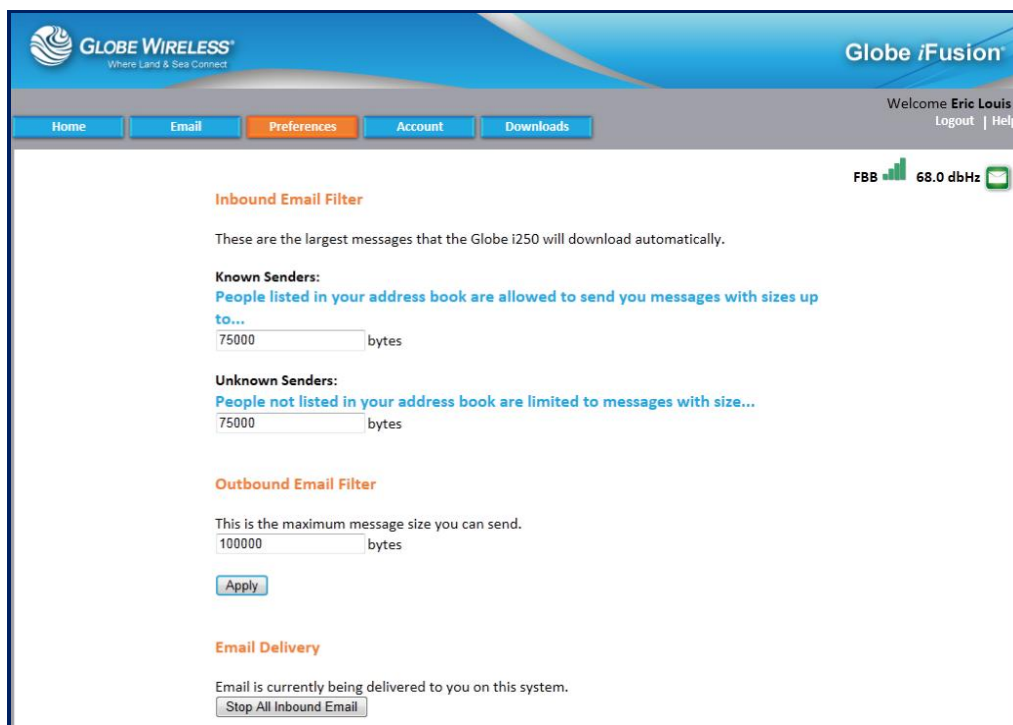

The screenshot shows the 'Preferences' tab in the Globe iFusion web interface. The page has a blue header with the Globe Wireless logo and 'Globe iFusion' text. Below the header is a navigation bar with tabs for 'Home', 'Email', 'Preferences' (which is active), 'Account', and 'Downloads'. The main content area is titled 'Inbound Email Filter' and contains the following sections:

- Inbound Email Filter:** A heading followed by the text 'These are the largest messages that the Globe i250 will download automatically.'
- Known Senders:** A heading followed by the text 'People listed in your address book are allowed to send you messages with sizes up to...'. Below this is a text input field containing '75000' and the label 'bytes'.
- Unknown Senders:** A heading followed by the text 'People not listed in your address book are limited to messages with size...'. Below this is a text input field containing '75000' and the label 'bytes'.
- Outbound Email Filter:** A heading followed by the text 'This is the maximum message size you can send.'. Below this is a text input field containing '100000' and the label 'bytes'.
- An 'Apply' button.
- Email Delivery:** A heading followed by the text 'Email is currently being delivered to you on this system.'. Below this is a 'Stop All Inbound Email' button.

In the top right corner of the page, there is a status bar showing 'Welcome Eric Louis', 'Logout | Help', and a signal strength indicator 'FBB 68.0 dBHz'.

To keep mail costs down, the **Inbound Email Filters** can use your address book to prevent senders from sending you large messages.

The **Globe iFusion®** distinguishes two kinds of senders: **Known** and **Unknown**. The **Globe iFusion®** provides you the ability to specify the maximum size message for both Known and Unknown Senders. With these two values you can control the size of a message you are willing to receive. Messages larger than the size specified are not transmitted to the **Globe iFusion®** and you pay no delivery costs for them.

- **Known Senders** are people whose email addresses are in your address book. Typically a user might accept larger messages from people he knows.
- **Unknown Senders** are people not in your address book. A user might limit unknown people to a much smaller maximum message size. Setting one of the values to 0 bytes will block all email from that class of senders. For example, setting the Unknown Senders value to 0 will block all email from people not in your address book.

The **Outbound Email Filter** is also provided to help you protect yourself from accidentally sending an overly large message. This filter works the same way as the other filters. The byte value you enter here is the largest message that you wish the **Globe iFusion®** to send.

To stop all email deliveries, click the **Stop All Inbound Email** button at the bottom of the screen.

10.4 Account Tab

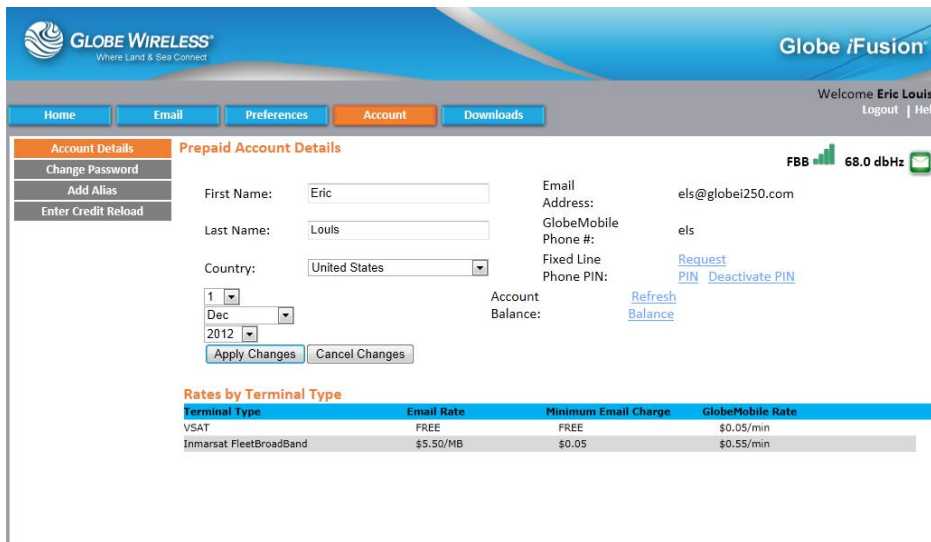

The screenshot shows the 'Account' tab in the Globe iFusion web interface. The page title is 'Globe iFusion' and the user is logged in as 'Eric Louis'. The navigation menu includes 'Home', 'Email', 'Preferences', 'Account', and 'Downloads'. The 'Account' sub-tab is active, showing 'Prepaid Account Details'. The form includes fields for 'First Name' (Eric), 'Last Name' (Louis), 'Country' (United States), and 'Account Balance' (1 Dec 2012). There are also links for 'Change Password', 'Add Alias', and 'Enter Credit Reload'. A table titled 'Rates by Terminal Type' is displayed below the form.

Terminal Type	Email Rate	Minimum Email Charge	GlobeMobile Rate
VSAT	FREE	FREE	\$0.05/min
Inmarsat FleetBroadBand	\$5.50/MB	\$0.05	\$0.55/min

The Account screen contains the following sub-tabs:

- Account Details (*default*)
- Change Password
- Add Alias
- Enter Credit Reload

10.4.1 Account Details (default) Sub-Tab

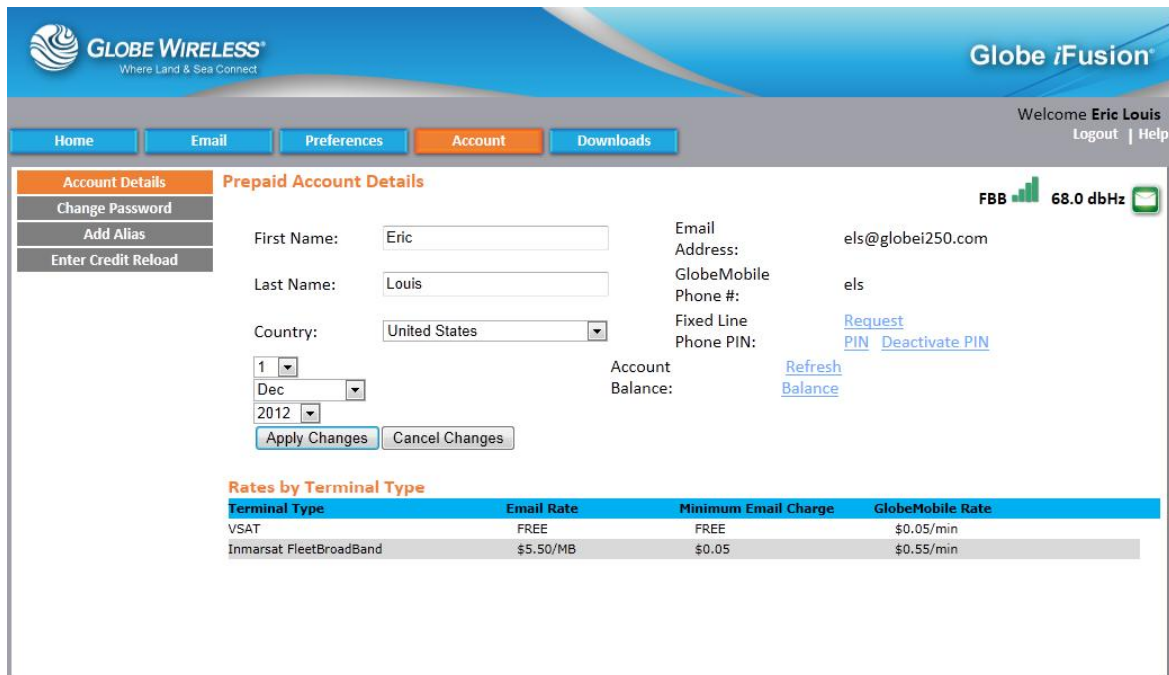

The screenshot shows the 'Account Details' sub-tab selected in the 'Account' menu. The page displays 'Prepaid Account Details' for user Eric Louis. The account information includes: First Name: Eric, Last Name: Louis, Country: United States, Account Number: 1, and Account Balance: Dec 2012. Contact information includes Email: els@globei250.com, GlobeMobile Phone #: els, and Fixed Line Phone PIN. There are links for 'Request PIN' and 'Deactivate PIN'. A signal strength indicator shows 'FBB 68.0 dBHz'. A table below shows rates by terminal type.

Terminal Type	Email Rate	Minimum Email Charge	GlobeMobile Rate
VSAT	FREE	FREE	\$0.05/min
Inmarsat FleetBroadBand	\$5.50/MB	\$0.05	\$0.55/min

10.4.2 Change Password Sub-Tab

Click the **Change Password** Sub-tab to display the **Password Change** screen.

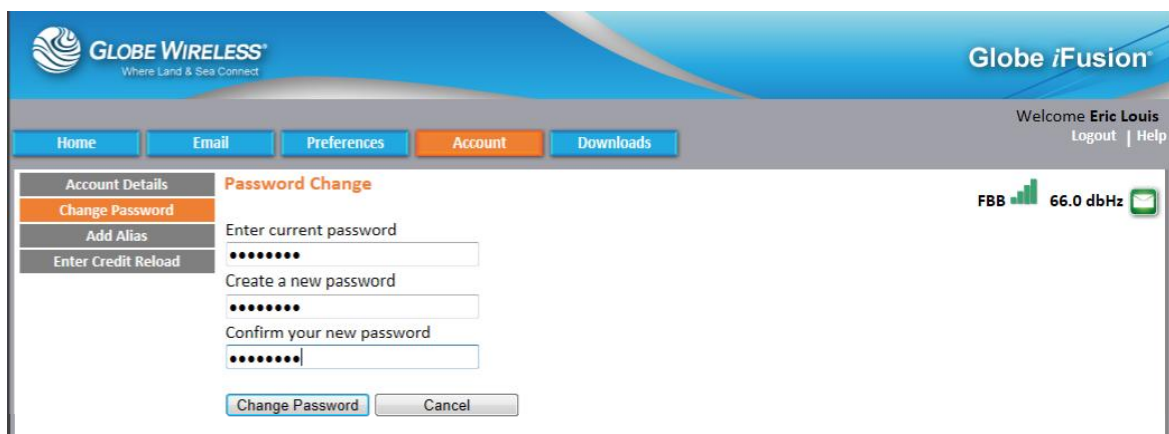

The screenshot shows the 'Password Change' sub-tab selected in the 'Account' menu. The page displays three input fields for password change: 'Enter current password', 'Create a new password', and 'Confirm your new password'. There are 'Change Password' and 'Cancel' buttons at the bottom. A signal strength indicator shows 'FBB 66.0 dBHz'.

Step 1: Type your existing password into the **Enter current password** field.

Step 2: Type the new password into the next two fields (**Create new** and **Confirm**).

Step 3: Click on the **Change Password** button.

10.4.3 Add Alias Sub-Tab

Step 1: Click the **Add Alias Sub-Tab** to display the **Email Account Aliases** screen.

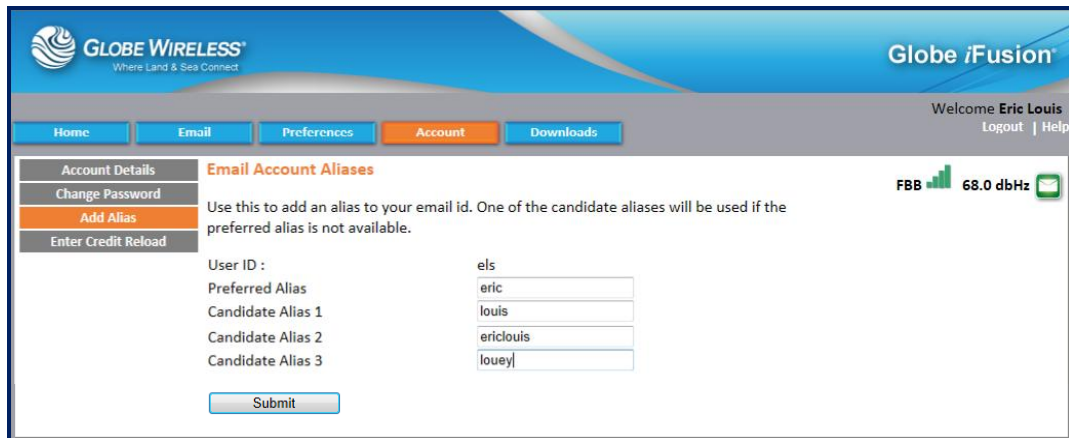

The screenshot shows the 'Email Account Aliases' screen. At the top, there is a navigation bar with 'Home', 'Email', 'Preferences', 'Account', and 'Downloads'. Below this is a sidebar menu with 'Account Details', 'Change Password', 'Add Alias', and 'Enter Credit Reload'. The main content area is titled 'Email Account Aliases' and contains the following text: 'Use this to add an alias to your email id. One of the candidate aliases will be used if the preferred alias is not available.' Below this text are five input fields: 'User ID' (with value 'els'), 'Preferred Alias' (with value 'eric'), 'Candidate Alias 1' (with value 'louis'), 'Candidate Alias 2' (with value 'ericlouis'), and 'Candidate Alias 3' (with value 'louey'). A 'Submit' button is located at the bottom of the form. In the top right corner, there is a signal strength indicator showing 'FBB' and '68.0 dbHz'.

Step 2: Type your Preferred and candidate Alias in the fields. All Alias fields must be populated.

Step 3: Click on the **Submit** button.

10.4.4 Enter Credit Reload Sub-Tab

Step 1: Click on the **Enter Credit Reload Sub-Tab** to display the **Credit Reload** screen.

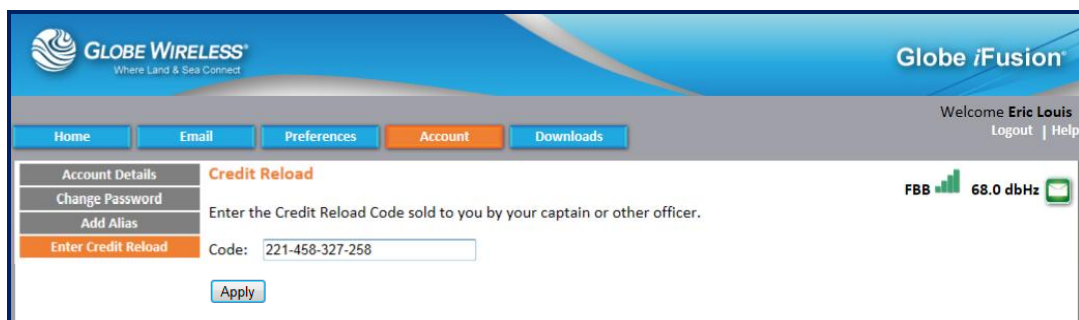

The screenshot shows the 'Credit Reload' screen. It features the same navigation bar and sidebar menu as the previous screen. The main content area is titled 'Credit Reload' and contains the text: 'Enter the Credit Reload Code sold to you by your captain or other officer.' Below this text is a single input field labeled 'Code:' with the value '221-458-327-258'. An 'Apply' button is located at the bottom of the form. The top right corner shows the same signal strength indicator as the previous screen.

Step 2: Enter the reload number you purchased from the captain or designated officer into the **Code:** field.

Step 3: Click the **Apply** button.

10.5 Downloads Tab

Click on the Downloads Tab to display the **Free Downloads** screen.

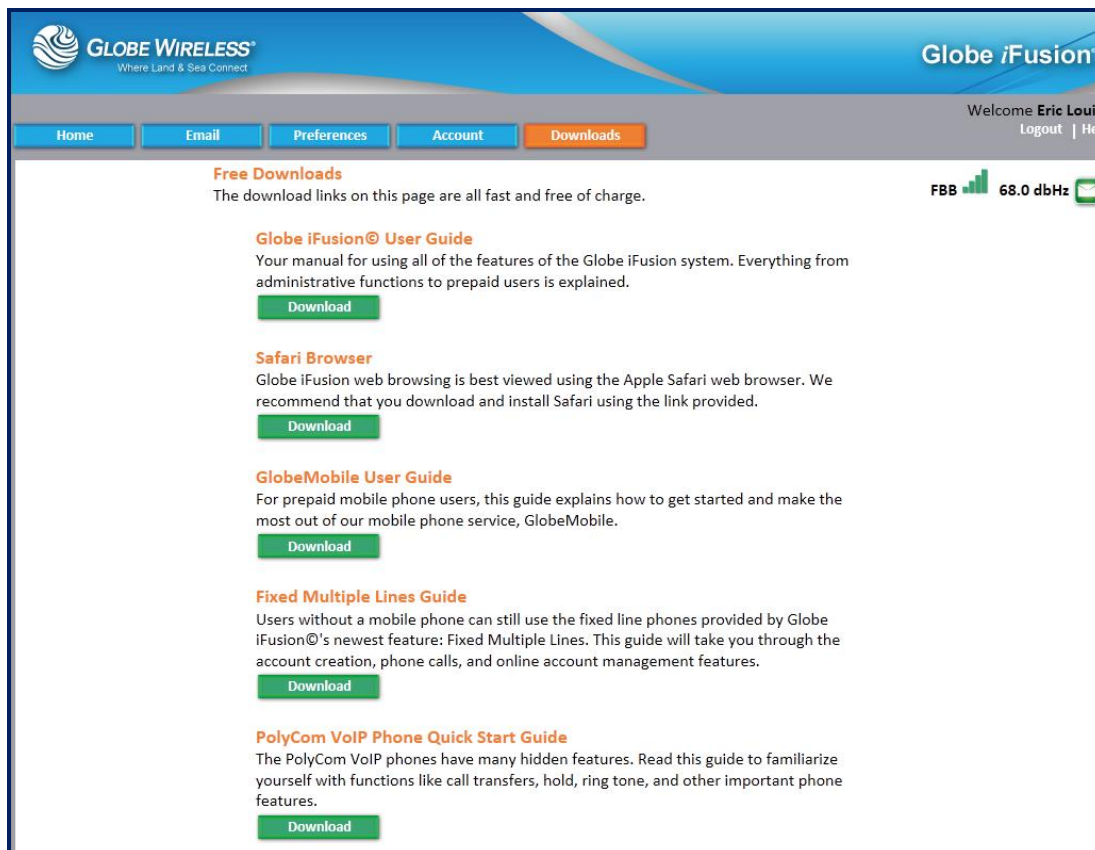

The screenshot shows the 'Free Downloads' section of the Globe iFusion user interface. At the top, there is a navigation bar with tabs for Home, Email, Preferences, Account, and Downloads. The 'Downloads' tab is selected. Below the navigation bar, the page title is 'Free Downloads' and a sub-header states 'The download links on this page are all fast and free of charge.' On the right side, there is a signal strength indicator showing 'FBB' and '68.0 dbHz'. The main content area lists five download links, each with a brief description and a 'Download' button:

- Globe iFusion® User Guide**: Your manual for using all of the features of the Globe iFusion system. Everything from administrative functions to prepaid users is explained. [Download](#)
- Safari Browser**: Globe iFusion web browsing is best viewed using the Apple Safari web browser. We recommend that you download and install Safari using the link provided. [Download](#)
- GlobeMobile User Guide**: For prepaid mobile phone users, this guide explains how to get started and make the most out of our mobile phone service, GlobeMobile. [Download](#)
- Fixed Multiple Lines Guide**: Users without a mobile phone can still use the fixed line phones provided by Globe iFusion®'s newest feature: Fixed Multiple Lines. This guide will take you through the account creation, phone calls, and online account management features. [Download](#)
- PolyCom VoIP Phone Quick Start Guide**: The PolyCom VoIP phones have many hidden features. Read this guide to familiarize yourself with functions like call transfers, hold, ring tone, and other important phone features. [Download](#)

Step 1: Select a download you wish to perform from the Free Downloads list and press the corresponding **Download** button.

Step 2: Follow the steps displayed to complete the download.

Step 3: If there are additional downloads you wish to perform, repeat the above steps.

11.0 Web Browsing Users

When the **Web Browsing** user logs in, the following screen is displayed.

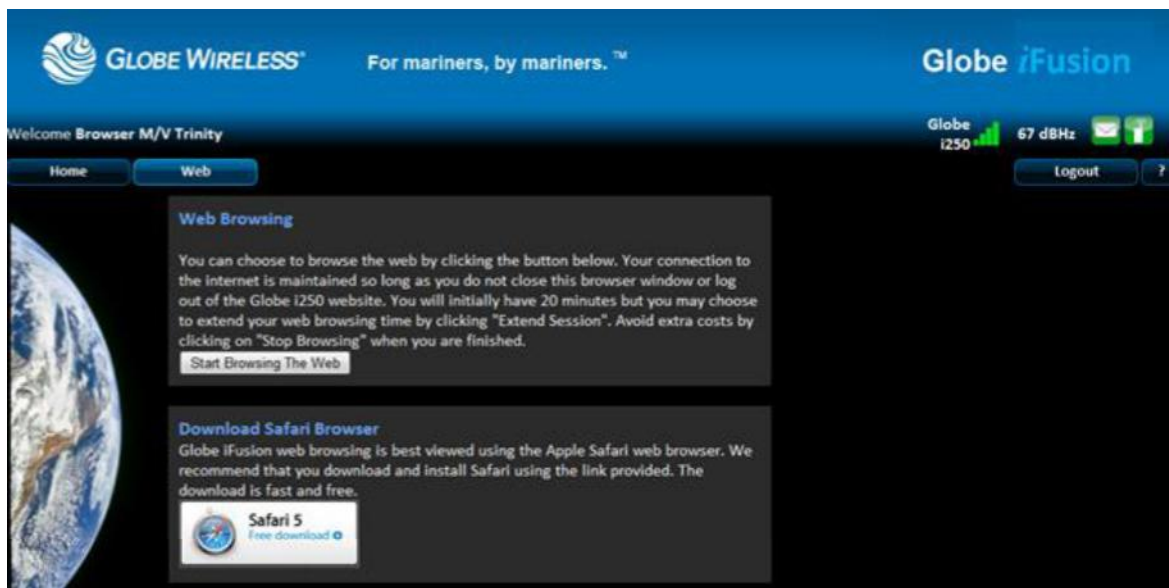

Note: As noted on the screen, it is recommended that the user download the (free) **Safari Browser** by clicking the link on the **Web Browsing** screen.

11.1 Start a Web Browsing Session

Step 1: Click the **Web** Tab to display the **Web Browsing** screen.

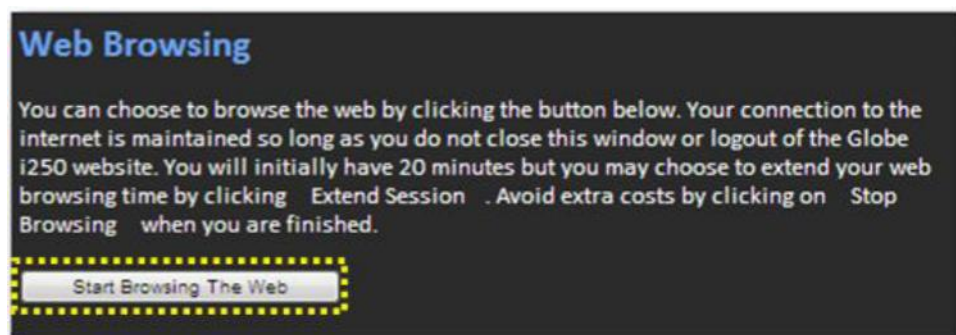

Step 2: Click on the **Start Browsing the Web** button to start a Web Browsing session.

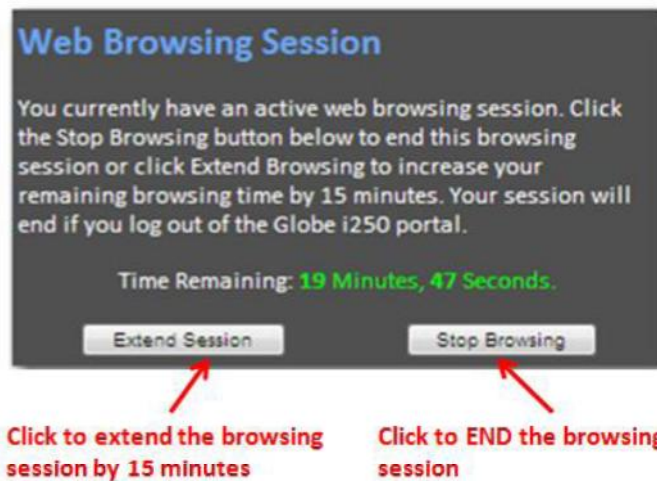

The web browsing session will remain active so long as there is time left and the web browsing page is left open. If you leave the web browsing page on this browser window, the session will be dropped. For that reason it is recommended that you open another browser window or tab and use that to access the internet for web browsing.

11.2 Stop or Extend a Web Browsing Session

Click the **Stop Browsing** button to end the session and return to the beginning screen.

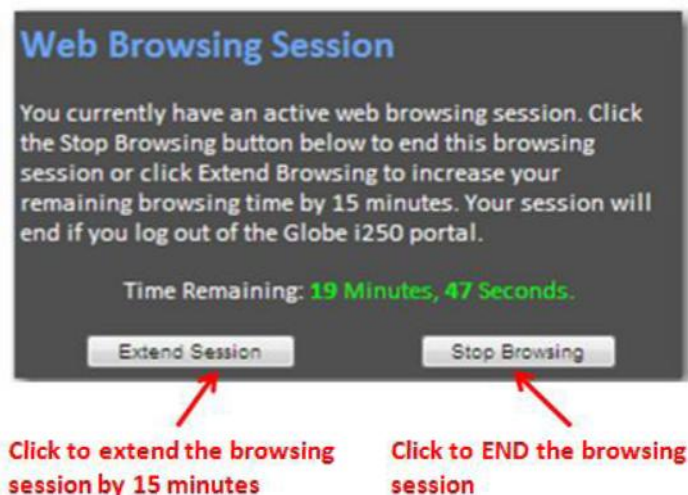



SWG-125 Rev. G

June 2013

Click the **Extend Session** button to extend the browsing session.

Note: Each time the **Extend Session** button is pressed, the browsing time is increased in 15-minute increments.



SWG-125 Rev. G

June 2013

This page intentionally left blank.

12.0 Troubleshooting

This section is a guide on how to resolve basic user issues. If these basic steps fail, please contact Globe Wireless Customer Support:

Within the United States or Canada: 1-(877)-535-0653

Overseas: 1-(321)-308-0112

Email: customersupport@globewireless.com

12.1 Basic User Issues and Solutions

Cannot Make Voice or Fax Calls (FleetBroadband & GlobeMobile)

1.	Check the FleetBroadband handset to determine if the terminal has sufficient signal strength Change ocean region if necessary
2.	Does the telephone LED on the FleetBroadband terminal display as ORANGE ? A call is in progress. Wait until the telephone LED displays GREEN .

Note: A maximum of two simultaneous calls can be handled by the **Globe iFusion®** system.

GCC Cannot Make Data IP Calls / GlobeMobile SMS Messages Not Transferring

1.	Is the globe icon on the terminal showing RED ? It is likely that the data connection has stopped on the FleetBroadband terminals. The terminals are configured to automatically connect to data services. Occasionally, it may be necessary to make a data connection on the FleetBroadband terminal. Please note that it does not need to be deactivated after usage.
2.	Does the telephone LED on the FleetBroadband terminal display as ORANGE ? <ul style="list-style-type: none"> A call is in progress. Wait until the telephone LED displays GREEN. From handset press MENU > DATA > STATUS > ACTIVATE PRIMARY The globe LED on the terminal should now display as GREEN .

Terminal Unresponsive Cannot Make Voice, Fax or Data Calls

1. The FleetBroadband terminal may have locked up.
Power cycle the terminal in order to reboot it. Wait approximately 10 minutes before attempting to call again. All LED's should display as **GREEN**.

12.2 Frequently Asked Questions

Can I use my GlobeMobile SIM on other GlobeMobile vessels?

- Yes. Rates may differ from vessel to vessel depending upon the satellite solution and plans aboard.

How do I connect to GlobeMobile?

- The **GlobeMobile** SIM is designed to automatically recognize and select the **GWireless** network. Phones will display **GWireless**, or one of the following network codes: **310-720** or **310 72** once the mobile phone is registered in the **Globe iFusion®**. Select this and connect. If connection cannot be made, see your mobile phone User Guide for information to perform the necessary steps manually.

How do I receive calls or SMS messages?

- You will have a standard U.S. cell (mobile) phone number that can send and receive SMS messages. Note that you will be charged for all inbound calls as well as all SMS messages sent and received to cover satellite & system costs.

Note: At this time you will not be able to receive incoming mobile phone calls. Only outbound calling is available.

Can I have a local phone number?

- At this time Globe Wireless can only offer U.S. phone numbers.

How much will it cost people to send SMS messages to me?

- Users will pay their telephone provider's standard rates for SMS messaging to U.S. cell (mobile) phone destinations. You will also be charged a fee to cover satellite airtime costs.

Can I call other users onboard the vessel via GlobeMobile and how much will it cost?

- You can call other users onboard the same vessel and these calls are free of charge.



SWG-125 Rev. G

June 2013

Can all cell (mobile) phones be used with GlobeMobile?

- **GlobeMobile** uses an 1800MHz frequency range and the cell (mobile) phone must be able to use this range. This is the same frequency used in most European countries.

Note: **GlobeMobile SIM cards will only work in *unlocked* mobile phones.** Some mobile devices are *locked* to a particular carrier. If this is the case you will *not* be able to use the Globe Wireless **SIM** card in your current device.



SWG-125 Rev. G

June 2013

This page intentionally left blank.

APPENDIX A: Updating the Globe *iFusion*® Software

- Step 1: Obtain a **Globe *iFusion*®** USB Thumb Drive with the latest released software and place it into one of the front USB slots.
- Step 2: Power on the **Globe *iFusion*®** from the front panel.
- Step 3: The system will reboot using the front panel **Globe *iFusion*®** USB drive and start an install update automatically.
- Step 4: Once the software installation is complete and the **Globe *iFusion*®** automatically powers off, remove the USB Thumb Drive and power on the **Globe *iFusion*®** from the front panel again.
- Step 5: The **Globe *iFusion*®** may automatically reboot two more times before it is ready for use.



SWG-125 Rev. G

June 2013

This page intentionally left blank.

APPENDIX B: Updating the Globe *iFusion*® Firmware

Step 1: Using the **Globe *iFusion*®** console, login as **root** and use **ce1177** as the password.

Warning: The following step prevents the **Globe *iFusion*® Core** from being power cycled. It is extremely important that this step be followed to prevent damaging the **FBB Core**.

Step 2: At the prompt, enter the following command: `bgan_safe_mode`. The monitor displays "System is in Safe Mode".

Step 3: Monitor the front of the **Globe *iFusion*®**, and when the READY light alternates between red and green, it is safe to continue with the procedure.

Step 4: Using the PC connected to the terminals' WAN 2 Port, open the web browser and type <http://10.97.97.35:9980> in the address field. The **Globe *iFusion*® FBB Web Interface** login screen will appear.

Step 5: Enter the following into the username and password fields:

- **Username:** `service_rep`
- **Password:** `eb0lg`

Step 6: Click the Settings icon near the top of the page.

Step 7: Click on the Admin tab, beneath the icons.

Step 8: Click on the Firmware Upgrade tab on the left side of the screen.

Step 9: Click on the Firmware Upgrade button.

Step 10: Monitor the front of the **Globe *iFusion*®** and watch for the terminal to reboot into safe mode. All four (4) of the FBB Core LEDs should begin and continue flashing amber.

Step 11: After waiting 2 minutes, the PC will have reestablished its network connection. Refresh the PC screen and log back into the FBB Web Interface page using the same username and password as in Step 5 (Username - `service_rep`; Password - `eb0lg`). Click the Login button.

Step 12: The FBB **Web Interface** will again open and the **Globe iFusion® CONTROL PANEL** will appear displaying **Safe Mode**. Click the **Browse** button. Browse and open the **latest released** firmware package to be uploaded.

Note: The typical Firmware convention will appear as: **GW_i250-FB250-r00X.X.X.fb**

Step 13: Click the Upload button. The Firmware will begin transferring files.

Step 14: Monitor the FBB Web Interface page and wait for the download to complete.

Step 15: While still monitoring the **FBB Web Interface**, click the **Reboot Terminal** link to exit **safe mode**, and monitor the unit through the complete rebooting sequences.

Step 16: Using the **Globe iFusion** console, again type the command bgan_safe_mode. The monitor displays “System is not in Safe Mode”.

Step 17: Using the **Globe iFusion®** console, type reboot, and press Enter. Monitor the unit through the complete rebooting sequence. The unit will power off; then restart. When the reboot sequence is complete the READY light will flash steady green.

Step 18: Return to the FBB Web Interface and click on the Settings icon.

Step 19: Click on the Terminal Info button and verify the Software Version listed is the same as the version that was just downloaded.

Step 20: Power off the **Globe iFusion®** from the front panel.

Step 21: Remove the **RF** cable connector from the **Globe iFusion®**.

APPENDIX C: Restoring Factory Defaults for the Globe *iFusion*® Software

Perform the following steps to restore the factory defaults and update the **Globe *iFusion*®** software:

- Step 1: Obtain a **Globe *iFusion*®** USB Thumb Drive with the latest released software and place it into one of the front USB slots on the **Globe *iFusion*®** unit.
- Step 2: Power on the **Globe *iFusion*®** from the front panel.
- Step 3: Watch for the **Globe *iFusion*®** USB Installer to appear.
- Step 4: Immediately arrow down to the *Extras Menu* and press **Enter**.
- Step 5: Watch for the **Force Globe *iFusion*® Rebuild **Warning**** to appear and press **Enter**.
- Step 6: Watch for the prompt: “*Are you sure you wish to proceed*”. Type “**y**” and then press **Enter**.

Note: The system will reboot from the **Globe *iFusion*®** USB drive and start an install update automatically. The install process takes approximately ten minutes to complete.

- Step 7: Once the software installation is complete and the system automatically powers off, remove the USB Thumb Drive and power on the **Globe *iFusion*®** from the front panel again.

Note: The **Globe *iFusion*®** may automatically reboot up to two more times before it is ready for use.



SWG-125 Rev. G

June 2013

This page intentionally left blank.

APPENDIX D: Technical Specifications

Globe iFusion® Technical Specifications



FB250 Antenna	
Weight	3.8kg (8.37lbs)
Dimensions	27.7cm (H) x 31.95cm (D) (10.9 in (H) x 12.57 in (D))
Storage Temperature	-40°C to +80°C (-40°F to +176°F)
Operational Temperature	-25°C to +55°C (-13°F to +131°F)
Cable Loss	12dB max @ 1.6GHz



FB250 Antenna

Below Deck Equipment (BDE)	
Dimensions	8.89cm x 48.26cm x 35.56cm (3.5 in x 19 in x 14 in)
Storage Temperature	-40°C to +80°C (-40°F to +176°F)
Operational Temperature	0°C to +55°C (32°F to +131°F)



Globe iFusion®

GSM Antenna (BTS)	
Weight	2.0kg (4.41 lbs)
Dimensions	22.2cm (H) x 29.1cm (W) x 6.3cm (Depth) (8.74 in (H) x 11.45 in (W) x 2.48 in (Depth))
Storage Temperature	-40°C to +80°C (-40°F to +176°F)
Operational Temperature	-5°C to +45°C (23°F to +113°F)



GSM Antenna

Handset (Optional)	
Weight	0.48kg (1.05 lbs)
Dimensions	2.4cm x 5.6cm x 14.5cm (0.95 in x 2.2 in x 5.7 in)



Optional Handset

Communication Services	
Voice	4kbps, 3.1kHz
Standard IP	284 / 284kbps
Streaming IP	32, 64, 128kbps
Fax	G3
SMS	Up to 160 characters

Certifications
Inmarsat Approved
Compliant to: IEC 60945
Certification Mark: CE

Power Supply
AC Power Input 100-240 VAC

Below Deck Equipment Interfaces		
1 x IEC AC Power Input 100-240 VAC	3 x RJ45 WAN Ethernet Ports	3 x DB9 RS-232 Ports
1 x N Antenna Connection	1 x RJ45 PoE BTS Port	1 x GPS Output
2 x RJ11 POTS Handset and FAX	4 x RJ45 LAN Ethernet Ports	1 x VGA Output
1 x RJ11 GlobeMobile Telephone In	1 x RJ45 Handset	1 x Power (Service) Switch
3 x RJ11 Telephone Out	4 x USB Ports for UPS Management	Status LEDs

Globe *iFusion*® Front Panel Dimensions and Description

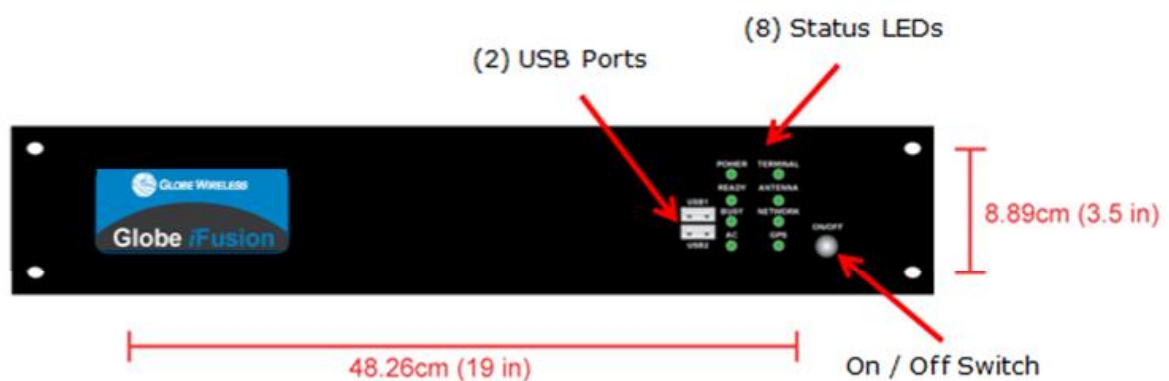

Globe *iFusion*® Rear Panel

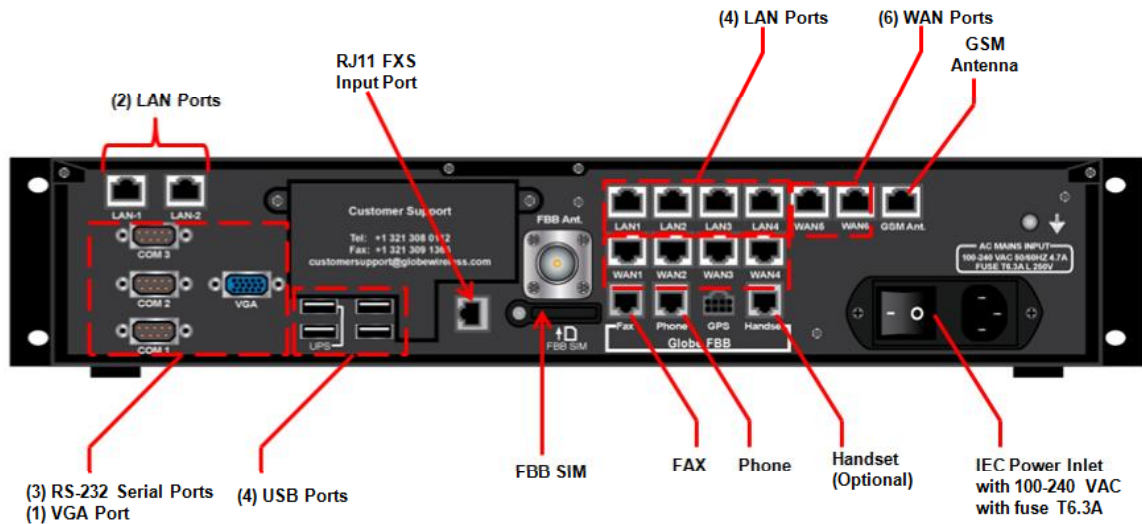

Rear Panel of Globe *iFusion*® i250 and i500

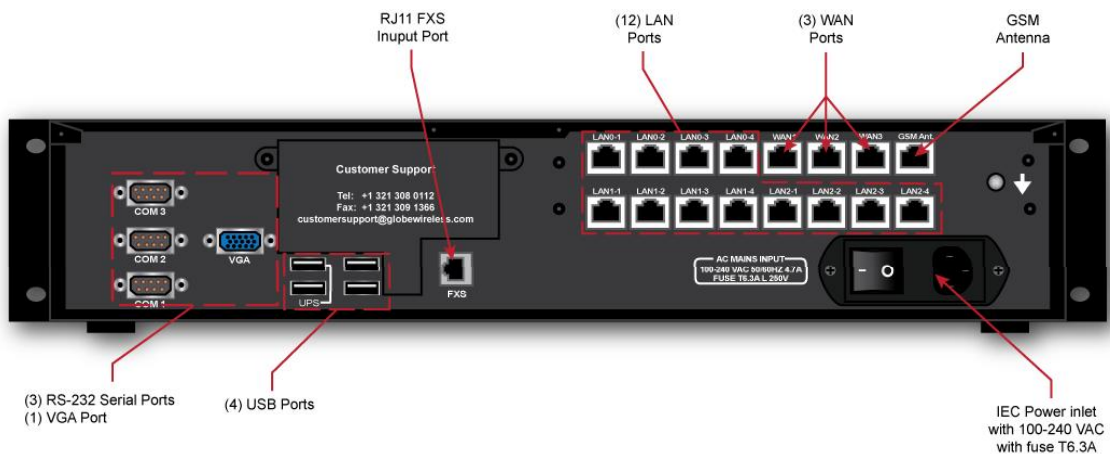

Rear Panel of Globe *iFusion*® iS



SWG-125 Rev. G

June 2013

This page intentionally left blank.



SWG-125 Rev. G

June 2013

APPENDIX E: Contact Information

For further assistance, contact the **Globe Wireless Customer Service Center** at:

- Within the United States or Canada: 1-(877)-535-0653
- Overseas: 1-(321)-308-0112
- Email: customersupport@globewireless.com

Globe Wireless also encourages emails to our quality department with comments and suggestions.

Please email comments and suggestions to: quality@globewireless.com



SWG-125 Rev. G

June 2013

This page intentionally left blank.