

**Test Report No. 7191058477-EEC13/11**  
dated 17 Jun 2013



PSB Singapore

**Note:** This report is issued subject to the Testing and Certification Regulations of the TÜV SÜD Group and the General Terms and Conditions of Business of TÜV SÜD PSB Pte Ltd. In addition, this report is governed by the terms set out within this report.

Choose certainty.  
Add value.

FORMAL REPORT ON TESTING IN ACCORDANCE WITH  
47 CFR FCC Parts 2, 15, and 25 : 2012  
OF A  
**MARITIME SATELLITE VOICE & DATA ROUTER**  
[ Model : Globe i250-S3 ]  
[ FCC ID : YC6GLOBEI250S3BDE ]

**TEST FACILITY** TÜV SÜD PSB Pte Ltd,  
Electrical & Electronics Centre (EEC), Product Services,  
No. 1 Science Park Drive, Singapore 118221

**FCC REG. NO.** 99142 (3m and 10m Semi-Anechoic Chamber, Science Park)

**IND. CANADA REG. NO.** 2932I-1 (3m and 10m Semi-Anechoic Chamber, Science Park)

**PREPARED FOR** Globe Wireless LLC  
1571 Robert J. Conlan Blvd  
Palm Bay, FL 32905 USA

Tel : +1 (321) 727-9766 Fax : +1 (321) 727-9497

**QUOTATION NUMBER** 219170176 & 219146087

**JOB NUMBER** 7191058477 & 7191027290

**TEST PERIOD** 24 Feb 2012 – 14 Mar 2012 & 20 May 2013 - 26 May 2013

PREPARED BY

  
Quek Keng Huat  
Higher Associate Engineer

APPROVED BY

  
Lim Cher Hwee  
Assistant Vice President



Laboratory:  
TÜV SÜD PSB Pte. Ltd.  
No.1 Science Park Drive  
Singapore 118221

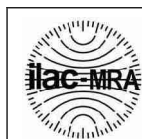

LA-2007-0380-A  
LA-2007-0381-F  
LA-2007-0382-B  
LA-2007-0383-G  
LA-2007-0384-G  
LA-2007-0385-E  
LA-2007-0386-C  
LA-2010-0464-D

The results reported herein have been performed in accordance with the laboratory's terms of accreditation under the Singapore Accreditation Council - Singapore Laboratory Accreditation Scheme. Tests/Calibrations marked "Not SAC-SINGLAS Accredited" in this Report are not included in the SAC-SINGLAS Accreditation Schedule for our laboratory.

Phone : +65-6885 1333  
Fax : +65-6776 8670  
E-mail: testing@tuv-sud-psb.sg  
www.tuv-sud-psb.sg  
Co. Reg : 199002667R

Regional Head Office:  
TÜV SÜD Asia Pacific Pte. Ltd.  
3 Science Park Drive, #04-01/05  
The Franklin, Singapore 118223  
TUV®



**TABLE OF CONTENTS**

TEST SUMMARY .....	3
PRODUCT DESCRIPTION .....	5
SUPPORTING EQUIPMENT DESCRIPTION.....	6
EUT OPERATING CONDITIONS.....	7
CONDUCTED EMISSION TEST .....	8
RADIATED EMISSION TEST.....	12
RF OUTPUT POWER TEST .....	16
UNWANTED EMISSIONS AT ANTENNA TERMINAL TEST .....	22
RADIATED SPURIOUS EMISSION TEST.....	74
PROTECTION OF AERONAUTICAL RADIO NAVIGATION SATELLITE SERVICE TEST.....	80
FREQUENCY STABILITY (TEMPERATURE VARIATION) TEST.....	99
FREQUENCY STABILITY (VOLTAGE VARIATION) TEST.....	104
MAXIMUM PERMISSIBLE EXPOSURE (MPE) TEST .....	108
ANNEX A EUT PHOTOGRAPHS / DIAGRAMS .....	110
ANNEX B USER MANUAL TECHNICAL DESCRIPTION BLOCK & CIRCUIT DIAGRAMS.....	143
ANNEX C FCC LABEL & POSITION.....	144



**TEST SUMMARY**

The product was tested in accordance with the customer's specifications.

**Test Results Summary**

Test Standard	Description	Pass / Fail
47 CFR FCC Parts 2, 15 and 25: 2012		
15.107(a), 15.207	Conducted Emissions	Pass
15.109	Radiated Emissions (Class B)	Pass
2.1046(a), 25.204	RF Output Power	Pass
2.1051, 25.202(f)	Unwanted Emissions at Antenna Terminal	Pass
2.1053, 25.202(f)	Radiated Spurious Emissions	Pass
25.216(h)(i)(j)	Protection of Aeronautical Radio Navigation Satellite Service	Pass
2.1055, 25.202(d)	Frequency Stability (Temperature Variation)	Pass
2.1055, 25.202(d)	Frequency Stability (Voltage Variation)	Pass
1.1310	Maximum Permissible Exposure	Refer to page 108 for details

**TEST SUMMARY**

**Notes**

- Six channels as listed below, which respectively represents the lower, middle and upper (transmit and receive) of the Equipment Under Test (EUT). Each channel was configured to operate under the test mode condition.

<u>Transmit Channel</u>	<u>Frequency (GHz)</u>	<u>Receive Channel</u>	<u>Frequency (GHz)</u>
Lower Channel	1.6266	Lower Channel	1.5251
Middle Channel	1.6435	Middle Channel	1.5420
Upper Channel	1.6600	Upper Channel	1.5589

- The following tests were based on conducted measurement method:
  - RF Output Power
  - Unwanted Emissions at Antenna Terminal
  - Frequency Stability (Temperature Variation)
  - Frequency Stability (Voltage Variation)
- All test measurement procedures are according to ANSI/TIA-603-B-2004.
- The EUT is a Class B device when in non-transmitting state and meets the FCC Part15B Class B requirements.
- Addvalue Communications Pte Ltd, the sole designer and manufacturer of the products to ODM/OEM client, Globe Wireless LLC, hereby **declaring Maritime Satellite Voice and Data Router models Globe i500-S3 & Globe i250-S3** are identically same in the aspect of hardware design of BELOW DECK EQUIPMENT (BDE). The difference lies only on the type of connecting external Antenna (Above Deck Equipment – ADE), models : FBB 500 & FBB250 which has change in RF power and physical size to differentiate the two products as a communication gateway system. Addvalue Communications Pte Ltd declares Globe i500-S3 product can be the representative for applicable testing and measurements.



SCALE 200%



SCALE 200%

- All the data in this report (except Conducted Emission test) is generated from **Maritime Satellite Voice and Data Router models Globe i500-S3 report 7191058477-EEC13/05** base on the above **declaration from Addvalue Communications Pte Ltd.**

**Modifications**

No modifications were made.



**PRODUCT DESCRIPTION**

Description	: The Equipment Under Test (EUT) is a <b>MARITIME SATELLITE VOICE &amp; DATA ROUTER.</b>
Applicant	: Globe Wireless LLC 1571 Robert J. Conlan Blvd Palm Bay, FL 32905 USA
Manufacturer	: Addvalue Communications Pte Ltd 28 Tai Seng Street, #06-02 Singapore 534106
Factor (ies)	: Beyonics Technology (Senai) Sdn Bhd Lot 3627, Jalan Harmoni 1, Batu 22, 81000 Kulai, Johor, Malaysia
Brand	: Globe iFusion
Model Number(s)	: Globe i250-S3
FCC ID	: YC6-GLOBEI250S3BDE
Serial Number	: BDU - NB500TA131500
Microprocessor	: FBB Core module – OMAP5912 Motherboard – ARM7JE-S
Operating / Transmitting Frequency	: Transmit - 1626.6MHz ~ 1660.4MHz Receive - 1525MHz ~ 1559MHz
Clock / Oscillator Frequency	: 25MHz
Modulation / Emissions Designator	: Receive: pi/4 QPSK and 16QAM Transmit: pi/4 QPSK and 16QAM
Antenna Gain	: 10.0dBi
Port / Connectors	: Refer to manufacturer's user manual / operating manual
Rated Input Power	: 100V-240V 60Hz/50Hz 4.7A
Accessories	: Primary Handset, 3m AC power cable



**SUPPORTING EQUIPMENT DESCRIPTION**

<b>Equipment Description (Including Brand Name)</b>	<b>Model, Serial &amp; FCC ID Number</b>	<b>Cable Description (List Length, Type &amp; Purpose)</b>
IBM ThinkPad	M/N: 1834-A58 S/N: LV-AV826 06/01 FCC ID: DoC	1.80m unshielded power cable 3.00m LAN cable
IBM Power Adapter (ThinkPad)	M/N: 08K8202 S/N: 11S08K8202Z1ZAC755N0NJ FCC ID: Verification	1.80m unshielded power cable
Dell Inspiron 6400	M/N: PP20L S/N: F195Q1S FCC ID: DoC	1.80m unshielded power cable 3.00m LAN cable
Dell Power Adapter (Inspiron 6400)	M/N: LA65NS-0-00 S/N: CN-0DF263-71615-757-72F4 FCC ID : Verification	1.80m unshielded power cable
Wideye Corded Analog Handset	M/N: SB1 / AH100 S/N: Nil FCC ID: Nil	1.80m unshielded power cable 3.00m LAN cable
Space Com Above Deck	M/N: BGAN-FB250 S/N: 4526P004 FCC ID: Nil	1.80m unshielded power cable 3.00m LAN cable



**EUT OPERATING CONDITIONS**

**47 CFR FCC Parts 1, 2, 15 and 25**

- 1. RF Output Power**
- 2. Unwanted Emissions at Antenna Terminal**
- 3. Radiated Spurious Emissions**
- 4. Protection of Aeronautical Radio Navigation Satellite Service**
- 5. Frequency Stability (Temperature Variation)**
- 6. Frequency Stability (Voltage Variation)**
- 7. Maximum Permissible Exposure**

The EUT was exercised by operating in following modes with the EUT simulating the transmission and reception using the client's provided test programs, "3CDaemon" and "UT Console\_Serial".

Satellite Transmission Mode

- Continuous RF transmission at lower channel at maximum RF power
- Continuous maximum RF transmission at middle channel at maximum RF power
- Continuous maximum RF transmission at upper channel at maximum RF power

Satellite Reception (Receive) Mode

- Continuous RF reception at lower channel
- Continuous RF reception at middle channel
- Continuous RF reception at upper channel



**CONDUCTED EMISSION TEST**

**47 CFR FCC Parts 15.107(a) and 15.207 Conducted Emission Limits**

Frequency Range (MHz)	Limit Values (dB $\mu$ V)	
	Quasi-peak (Q-P)	Average (AV)
0.15 - 0.5	66 – 56 *	56 – 46 *
0.5 - 5.0	56	46
5.0 - 30.0	60	50

\* Decreasing linearly with the logarithm of the frequency

**47 CFR FCC Parts 15.107(a) and 15.207 Conducted Emission Test Instrumentation**

Instrument	Model	S/No	Cal Due Date
Schaffner EMI Receiver	SMR4503	040	20 Nov 2013
Agilent EMC Analyzer-SA7	E7403A	US41160167	28 May 2014
Schaffner LISN –LISN7 (Ref)	NNB42	00008	28 Jan 2014
Schaffner LISN –LISN10 (EUT)	NNB42	04/10055	31 Oct 2013







**CONDUCTED EMISSION TEST**

**47 CFR FCC Parts 15.107(a) and 15.207 Conducted Emission Test Setup**

1. The EUT and supporting equipment were set up in accordance with the requirements of the standard on top of a 1.5m x 1m x 0.8m high, non-metallic table.
2. The power supply for the EUT was fed through a 50Ω/50μH EUT LISN, connected to filtered mains.
3. The RF OUT of the EUT LISN was connected to the EMI test receiver via a low-loss coaxial cable.
4. All other supporting equipment were powered separately from another LISN.

**47 CFR FCC Parts 15.107(a) and 15.207 Conducted Emission Test Method**

1. The EUT was switched on and allowed to warm up to its normal operating condition.
2. A scan was made on the NEUTRAL line over the required frequency range using an EMI test receiver.
3. High peaks, relative to the limit line, were then selected.
4. The EMI test receiver was then tuned to the selected frequencies and the necessary measurements made with a receiver bandwidth setting of 9kHz. Both Quasi-peak and Average measurements were made.
5. Steps 2 to 4 were then repeated for the LIVE line.

**Sample Calculation Example**

At 20 MHz	Q-P limit = 60.0 dBμV
Transducer factor of LISN, pulse limiter & cable loss at 20 MHz = 11.2 dB	
Q-P reading obtained directly from EMI Receiver = 40.0 dBμV (Calibrated for system losses)	
Therefore, Q-P margin = 60.0 - 40.0 = 20.0	i.e. 20.0 dB below Q-P limit

**CONDUCTED EMISSION TEST**



**Conducted Emissions Test Setup (Front View)**



**Conducted Emissions Test Setup (Rear View)**



**CONDUCTED EMISSION TEST**

**47 CFR FCC Parts 15.107(a) and 15.207 Conducted Emission Results**

Operating Mode	Continuous Satellite Transmission	Temperature	22°C
Test Input Power	110V 60Hz	Relative Humidity	55%
Line Under Test	AC Mains	Atmospheric Pressure	1030mbar
		Tested By	Chang Wai Kit

Frequency (MHz)	Q-P Value (dBµV)	Q-P Limit (dBµV)	Q-P Margin (dB)	AV Value (dBµV)	AV Limit (dBµV)	AV Margin (dB)	Line	Channel
0.1916	47.6	64.0	16.4	43.4	54.0	10.6	Live	Low Channel Bearer Type: 0 (Worst)
0.1928	47.5	63.9	16.4	42.9	53.9	11.0	Neutral	
10.0923	42.4	60.0	17.6	35.4	50.0	14.6	Neutral	
10.2018	42.2	60.0	17.8	35.6	50.0	14.4	Live	
10.2040	42.9	60.0	17.1	37.0	50.0	13.0	Neutral	
18.0088	37.6	60.0	22.4	36.1	50.0	13.9	Live	

Notes

- All possible modes of operation were investigated from 150kHz to 30MHz. Only the worst case emissions measured, using the correct CISPR detectors, are reported. All other emissions were relatively insignificant.
- A "positive" margin indicates a PASS as it refers to the margin present below the limit line at the particular frequency. Conversely, a "negative" margin indicates a FAIL.
- EMI receiver Resolution Bandwidth (RBW) and Video Bandwidth (VBW) settings:  
9kHz - 30MHz  
RBW: 9kHz                      VBW: 30kHz
- Conducted Emissions Measurement Uncertainty  
All test measurements carried out are traceable to national standards. The uncertainty of the measurement at a confidence level of approximately 95%, with a coverage factor of 2, in the range 9kHz – 30MHz is ±2.2dB.



**RADIATED EMISSION TEST**

**47 CFR FCC Part 15.109 Radiated Emission Limits (Class B)**

Frequency Range (MHz)	Quasi-Peak Limit Values (dB $\mu$ V/m) @ 3m
30 - 88	40.0
88 - 216	43.5
216 - 960	46.0
Above 960	54.0*

\* Above 1GHz, average detector was used. A peak limit of 20dB above the average limit does apply.

**47 CFR FCC Part 15.109 Radiated Emission Test Instrumentation**

Instrument	Model	S/No	Cal Due Date
R&S Test Receiver – ESI1	ESI40	100010	05 Jun 2014
Schaffner Bilog Antenna –(30MHz-2GHz) BL3 (Ref)	CBL6112B	2549	07 Jan 2014
Agilent Preamplifier(1GHz-26.5GHz) (PA18)	8449D	3008A02305	05 Oct 2013
Teseq Preamplifier (9kHz-1GHz)	LNA6901	72267	22 Jun 2013
EMCO Horn Antenna(1GHz-18GHz)	3115	0003-6088	03 Mar 2014

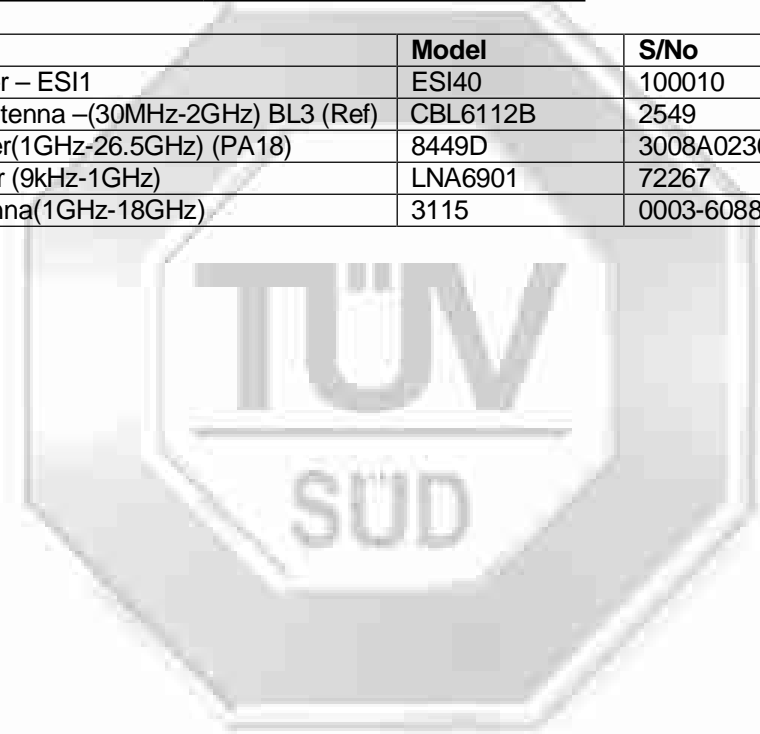



**RADIATED EMISSION TEST**

**47 CFR FCC Part 15.109 Radiated Emission Test Setup**

1. The EUT and supporting equipment were set up in accordance with the requirements of the standard as shown in the setup photos.
2. The filtered power supply for the EUT and supporting equipment were tapped from the appropriate power sockets located on the turntable.
3. The relevant broadband antenna was set at the required test distance away from the EUT and supporting equipment boundary.

**47 CFR FCC Part 15.109 Radiated Emission Test Method**

1. The EUT was switched on and allowed to warm up to its normal operating condition.
2. A prescan was carried out to pick the worst emission frequencies from the EUT. For EUT which is a portable device, the prescan was carried out by rotating the EUT through three orthogonal axes to determine which altitude and equipment arrangement produces such emissions.
3. The test was carried out at the selected frequency points obtained from the prescan in step 2. Maximization of the emissions, was carried out by rotating the EUT, changing the antenna polarization, and adjusting the antenna height in the following manner:
  - a. Vertical or horizontal polarisation (whichever gave the higher emission level over a full rotation of the EUT) was chosen.
  - b. The EUT was then rotated to the direction that gave the maximum emission.
  - c. Finally, the antenna height was adjusted to the height that gave the maximum emission.
4. A Quasi-peak measurement was made for that frequency point if it was less than or equal to 1GHz. For frequency point that above 1GHz, both Peak and Average measurements were carried out.
5. Steps 3 and 4 were repeated for the next frequency point, until all selected frequency points were measured.
6. The frequency range covered was from 30MHz to 10<sup>th</sup> harmonic of the highest frequency used or generated by the EUT, using the Bi-log antenna for frequencies from 30MHz up to 1GHz, and the Horn antenna above 1GHz.

**Sample Calculation Example**

At 300 MHz	Q-P limit = 37.0 dB $\mu$ V/m
Log-periodic antenna factor & cable loss at 300 MHz = 18.5 dB	
Q-P reading obtained directly from EMI Receiver = 31.0 dB $\mu$ V/m (Calibrated level including antenna factors & cable losses)	
Therefore, Q-P margin = 37.0 - 31.0 = 6.0	i.e. 6.0 dB below Q-P limit

**RADIATED EMISSION TEST**

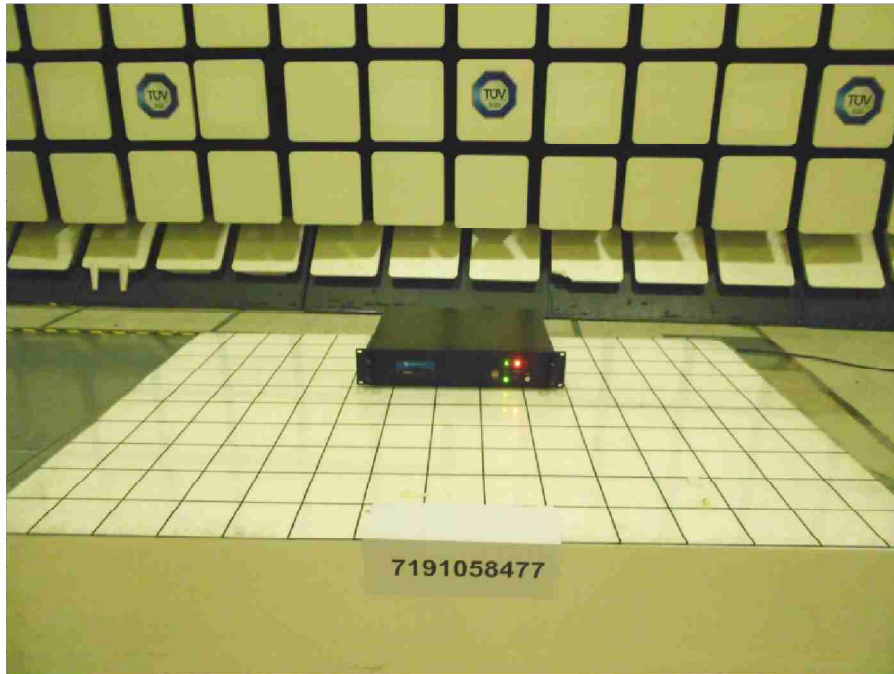

**Radiated Emissions Test Setup (Front View)**

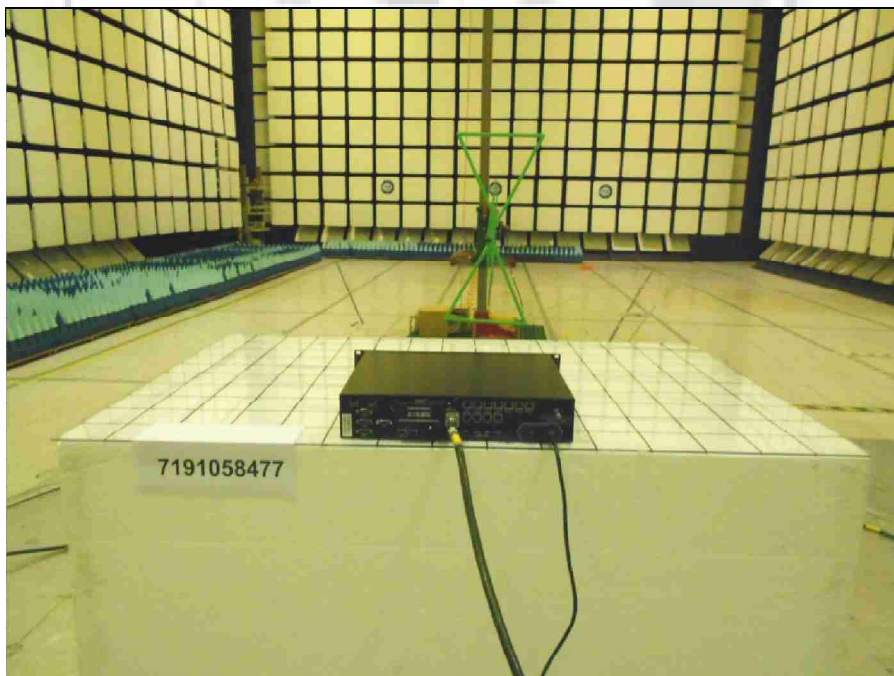

**Radiated Emissions Test Setup (Rear View)**





**RADIATED EMISSION TEST**

**47 CFR FCC Part 15.109 Radiated Emission Results**

Operating Mode	Continuous Satellite Transmission	Temperature	18°C
Test Input Power	110V 60Hz	Relative Humidity	58%
Test Distance	3m	Atmospheric Pressure	1030mbar
		Tested By	Zechs Ng Chee Siong

Spurious Emissions ranging from 30MHz – 1GHz

Frequency (MHz)	Q-P Value (dBµV/m)	Q-P Limit (dBµV/m)	Q-P Margin (dB)	Height (cm)	Azimuth (Degrees)	Pol (H/V)
99.5840	35.9	43.5	7.6	315	123	H
165.9490	35.3	43.5	8.2	132	251	H
601.5790	13.4	46.0	32.6	243	167	H
763.4770	34.2	46.0	11.8	100	213	V
902.1280	21.8	46.0	24.2	100	273	H
975.7800	23.5	54.0	30.5	100	103	V

Spurious Emissions above 1GHz-18GHz

Freq (GHz)	Peak Value (dBµV/m)	Peak Limit (dBµV/m)	Peak Margin (dB)	AV Value (dBµV/m)	AV Limit (dBµV/m)	AV Margin (dB)	Height (cm)	Azimuth (Degrees)	Pol (H/V)
1.1250	49.0	74.0	25.0	42.4	54.0	11.6	108	241	V
1.4667	49.3	74.0	24.7	32.0	54.0	22.0	146	210	V
1.5000	52.3	74.0	21.7	47.4	54.0	6.6	108	207	V
2.0250	49.1	74.0	24.9	42.9	54.0	11.1	134	57	V
2.0999	47.6	74.0	26.4	41.9	54.0	12.1	120	211	V
4.5000	50.7	74.0	23.3	42.6	54.0	11.4	100	141	V

Notes

- All possible modes of operation were investigated. Only the worst case emissions measured, using the correct CISPR detectors, are reported. All other emissions were relatively insignificant.
- A "positive" margin indicates a PASS as it refers to the margin present below the limit line at the particular frequency. Conversely, a "negative" margin indicates a FAIL.
- EMI receiver Resolution Bandwidth (RBW) and Video Bandwidth (VBW) settings:  
30MHz - 1GHz  
 RBW: 120kHz            VBW: 1MHz  
>1GHz  
 RBW: 1MHz            VBW: 1MHz
- The highest frequency of internal sources of the EUT is above 1GHz, as such, the measurement was made up to 5<sup>th</sup> harmonic of the highest frequency used or generated by the EUT or 40GHz, whichever is lower.
- Radiated Emissions Measurement Uncertainty  
 All test measurements carried out are traceable to national standards. The uncertainty of the measurement at a confidence level of approximately 95%, with a coverage factor of 2, in the range 30MHz – 25.0GHz is ±4.0dB.



**RF OUTPUT POWER TEST**

**47 CFR FCC Parts 2.1046 and 25.204 RF Output Power Test Limits**

1. 25.204 Power Limits
  - (a) In bands shared coequally with terrestrial radio communication services, the equivalent isotropically radiated power transmitted in any direction towards the horizon by an earth station, other than an ESV, operating in frequency bands between 1GHz and 5GHz, shall not exceed the following limits except as provided for in paragraph (c) of this section:
    - +40dBW in any 4kHz band for  $\theta: 0^\circ$
    - +40dBW + 3.0dBW in any 4kHz band for  $0^\circ < \theta \leq 5^\circ$where  $\theta$  is the angle of elevation of the horizon viewed from the center of radiation of the antenna of the earth station and measured in degrees as positive above the horizontal plane and negative below it.
  - (c) For angles of evaluation of the horizon greater than  $5^\circ$  there shall be no restriction as to the equivalent isotropically radiated power transmitted by an earth station towards the horizon.
  - (d) Notwithstanding the e.i.r.p and e.i.r.p density limits specified in the station authorization, each earth station transmission shall be conducted at the lowest power level that will provide the required signal quality as indicated in the application and further amended by coordination agreements.
2. 2.1046 Measurements Required: RF Power Output
  - (a) For transmission other than single sideband, independent sideband and controlled carrier radiotelephone, power output shall be measured at the RF output terminals when the transmitter is adjusted accordance with the tune-up procedure to give the values of current and voltage on the circuit elements specified in 2.1033(c)(8). The electrical characteristics of the radio frequency load attached to the output terminals when this test is made shall be stated.
  - (c) For measurements conducted pursuant to paragraphs (a) and (b) of this section, all calculations and methods used by the applicant for determining carrier power or peak envelope power, as appropriate, on the basis of measured power in the radio frequency load attached to the transmitter output terminals shall be shown. Under the test conditions specified, no components of the emission spectrum shall exceed the limits specified in the applicable rule parts as necessary for meeting occupied bandwidth or emission limitations.

**47 CFR FCC Parts 2.1046 and 25.204 RF Output Power Test Instrumentation**

Instrument	Model	S/No	Cal Due Date
Agilent Spectrum Analyzer	E4440A	MY45304764	25 May 2014
Mini-Circuits Precision Fixed Attenuator	BW-S20W5+	Nil	Output Monitor
Instock Wireless Components Combiner	PD7120	Nil	Output Monitor





**RF OUTPUT POWER TEST**

**47 CFR FCC Parts 2.1046 and 25.204 RF Output Power Test Setup**

1. The EUT and supporting equipment were set up as shown in the setup photo.
2. The power supply for the EUT was connected to a filtered mains.
3. The RF antenna connector was connected to the Universal Radio Communication Tester, which set into power analyser mode via a RF attenuator and a low-loss coaxial cable.
4. The spectrum analyser was then calibrated to the power meter level as shown by the Universal Radio Communicator Tester with a calibrated RF signal source.
5. All other supporting equipment were powered separately from another filtered mains.

**47 CFR FCC Parts 2.1046 and 25.204 RF Output Power Test Method**

1. The EUT was switched on and allowed to warm up to its normal operating condition. The EUT was then configured to operate in the test mode, transmitting frequency at lower channel.
2. The maximum peak power of the transmitting frequency was measured and recorded.
3. The RF carrier peak and average pots were plotted.
4. The steps 2 to 4 were repeated with the transmitting frequency was set to middle and upper channels respectively.

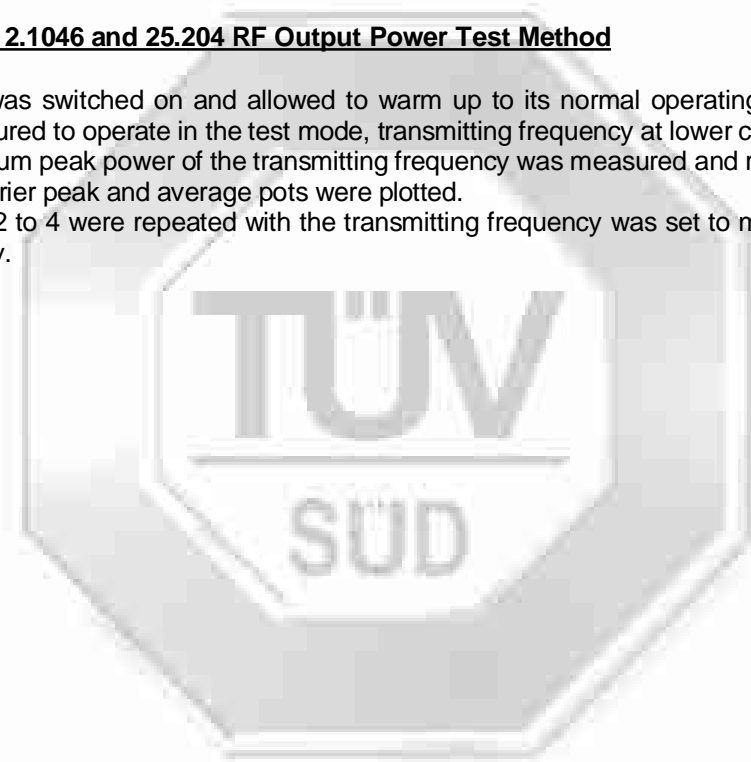

**RF OUTPUT POWER TEST**



**RF Output Power Test Setup**

**47 CFR FCC Parts 2.1046 and 25.204 RF Output Power Results**

Operating Mode	Continuous Satellite Transmission	Temperature	24°C
Test Input Power	110V 60Hz	Relative Humidity	60%
Antenna Gain	10.0dBi	Atmospheric Pressure	1030mbar
Attached Plots	1 – 6	Tested By	Kyaw Soe Hein, Liau Lee Yin

Frequency (GHz)	Channel	Peak Output Power (dBm)		Average Output Power (dBm)	
		EIRP	ERP	EIRP	ERP
1.6266	Lower	45.2	43.1	45.2	43.1
1.6435	Middle	47.2	45.1	47.2	45.1
1.6600	Upper	46.3	44.2	46.3	44.2

**Notes**

1. **RF Output Power Measurement Uncertainty**  
All test measurements carried out are traceable to national standards. The uncertainty of the measurement at a confidence level of 95%, with a coverage factor of 2 is  $\pm 1.0$ dB.

RF OUTPUT POWER TEST

Output Power Plots

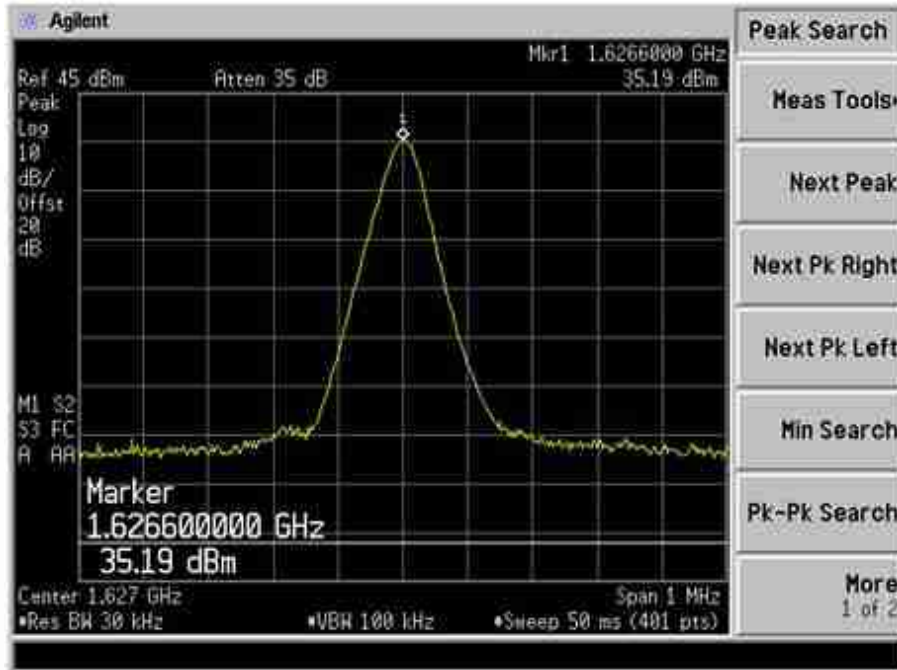

Plot 1 – Lower Channel (Peak)

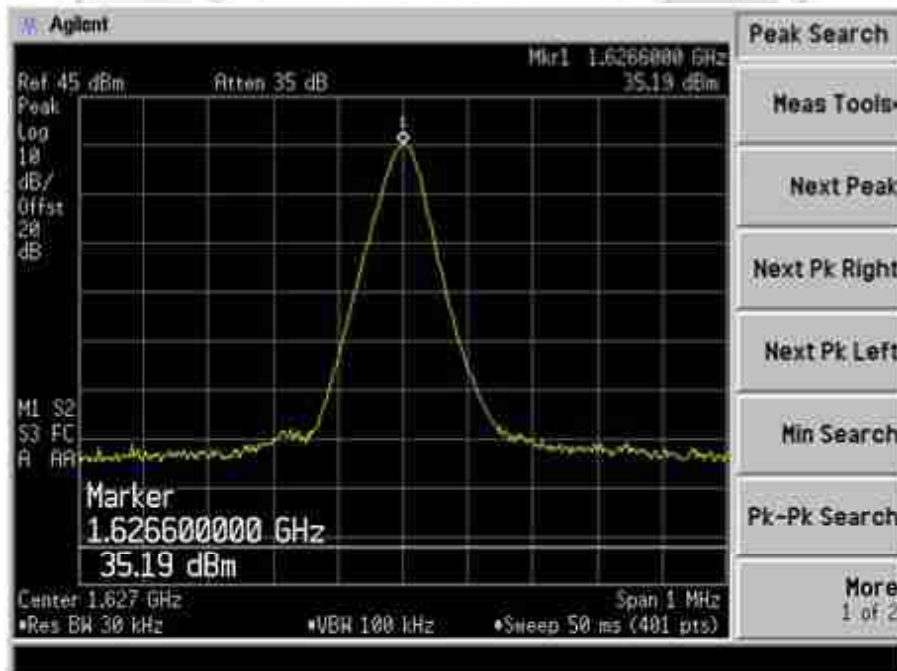

Plot 2 – Lower Channel (Average)

RF OUTPUT POWER TEST

Output Power Plots

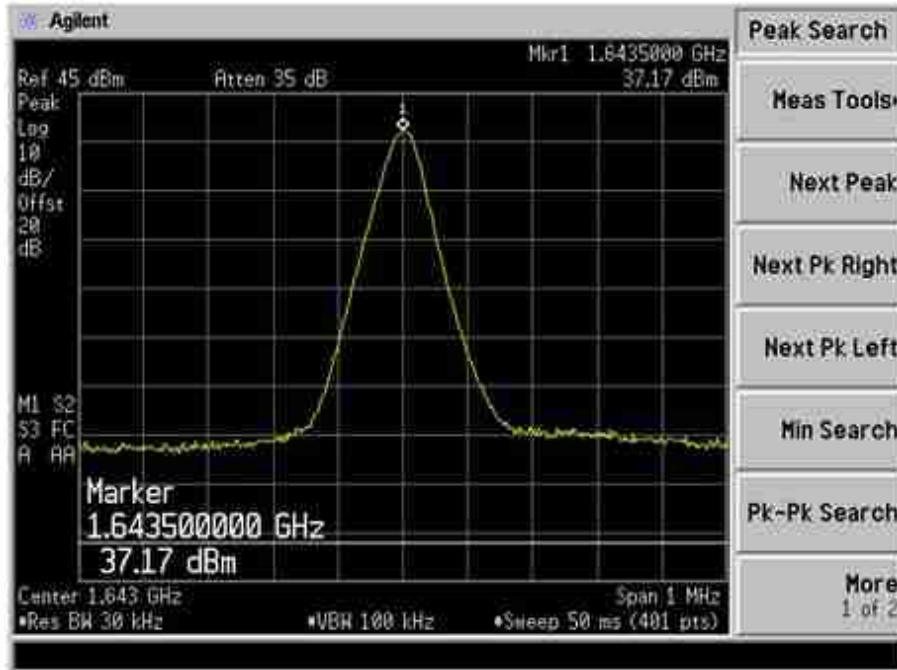

Plot 3 – Middle Channel (Peak)

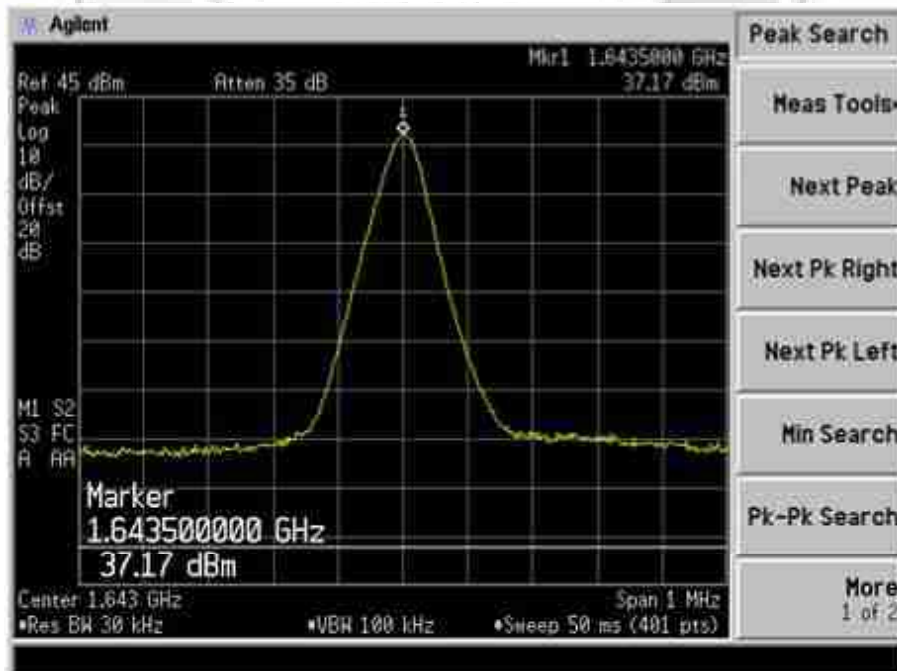

Plot 4 – Middle Channel (Average)

RF OUTPUT POWER TEST

Output Power Plots

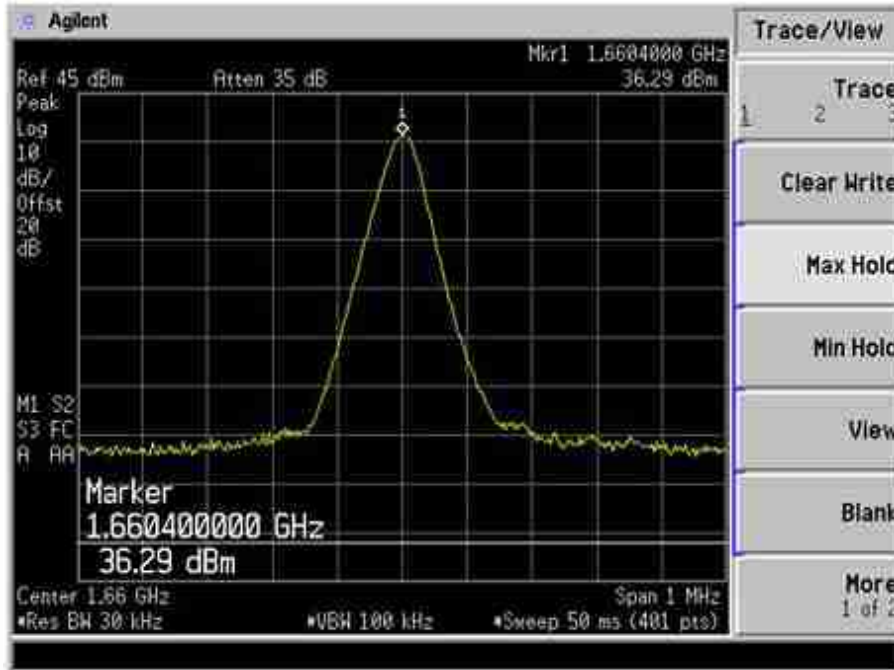

Plot 5 – Upper Channel (Peak)

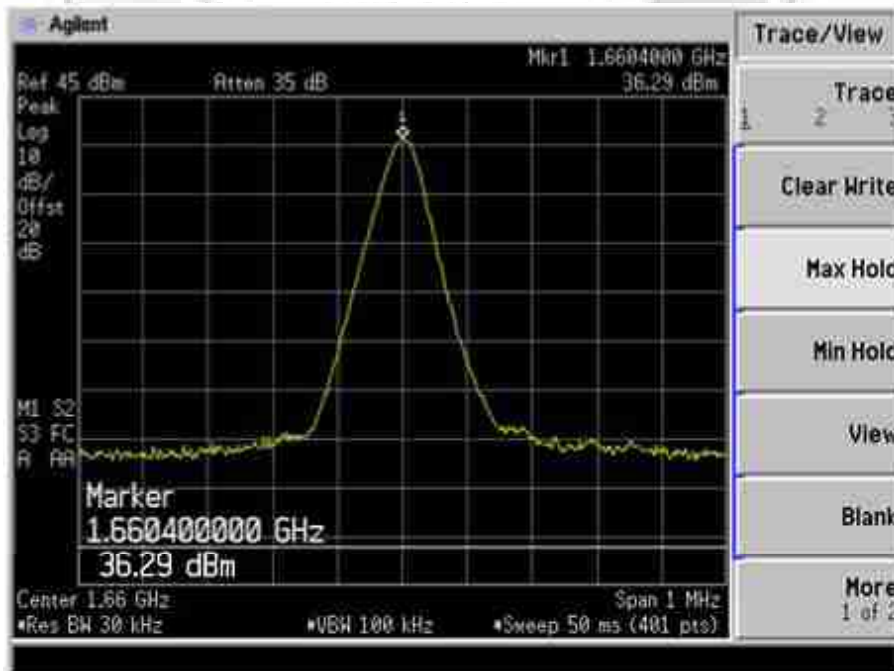

Plot 6 – Upper Channel (Average)

**UNWANTED EMISSIONS AT ANTENNA TERMINAL TEST**

**FCC Parts 2.1051 and 25.202(f) Unwanted Emissions at Antenna Terminal Test Limits**

1. 25.202 Emissions Limitations
  - (f) The mean power of the emissions shall be attenuated below the mean output power of the transmitter in accordance with the following schedule:
    - (1) In any 4kHz band, the center frequency of which is removed from the assigned frequency by more than 50% up to and including 100% of the authorized bandwidth: 25 decibels;
    - (2) In any 4kHz band, the center frequency of which is removed from the assigned frequency by more than 100% up to and including 250% of the authorized bandwidth: 35 decibels;
    - (3) In any 4kHz band, the center frequency of which is removed from the assigned frequency by more than 250% of the authorized bandwidth: an amount equal to 43 decibels plus 10 times logarithm (to the base 10) of the transmitter power in watts.
2. 2.1051 Measurements Required: Spurious Emissions at Antenna Terminals  
The radio frequency voltage or powers generated within the equipment and appearing on a spurious frequency shall be checked at the equipment output terminals when properly loaded with a suitable artificial antenna. Curves or equivalent data shall show the magnitude of each harmonic and other spurious emission that can be detected when the equipment is operated under the conditions specified in 2.1049 as appropriate. The magnitude of spurious emissions which are attenuated more than 20dB below the permissible value needed not be specified.

**FCC Parts 2.1051 and 25.202(f) Unwanted Emissions at Antenna Terminal Test Instrumentation**

Instrument	Model	S/No	Cal Due Date
Agilent Spectrum Analyzer	E4440A	MY45304764	25 May 2014
Mini-Circuits Precision Fixed Attenuator	BW-S20W5+	Nil	Output Monitor
Instock Wireless Components Combiner	PD7120	Nil	Output Monitor



**UNWANTED EMISSIONS AT ANTENNA TERMINAL TEST**

**47 CFR FCC Parts 2.1051 and 25.202(f) Unwanted Emissions at Antenna Terminal Test Setup**

1. The EUT and supporting equipment were set up as shown in the setup photo.
2. The power supply for the EUT was connected to a filtered mains.
3. The RF antenna connector was connected to the spectrum analyser via a RF attenuator and a low-loss coaxial cable.
4. All other supporting equipment were powered separately from another filtered mains.

**47 CFR FCC Parts 2.1051 and 25.202(f) Unwanted Emissions at Antenna Terminal Test Method**

1. The EUT was switched on and allowed to warm up to its normal operating condition. The EUT was then configured to operate in the test mode, transmitting frequency at lower channel.
2. The 26dB bandwidth of the transmitting channel was measured.
3. The emission mask was drawn based on the authorized bandwidth and the measured average output power.
4. The transmitting channel emissions were plotted.
5. The steps 2 to 5 were repeated with the transmitting frequency was set to middle and upper channels respectively.

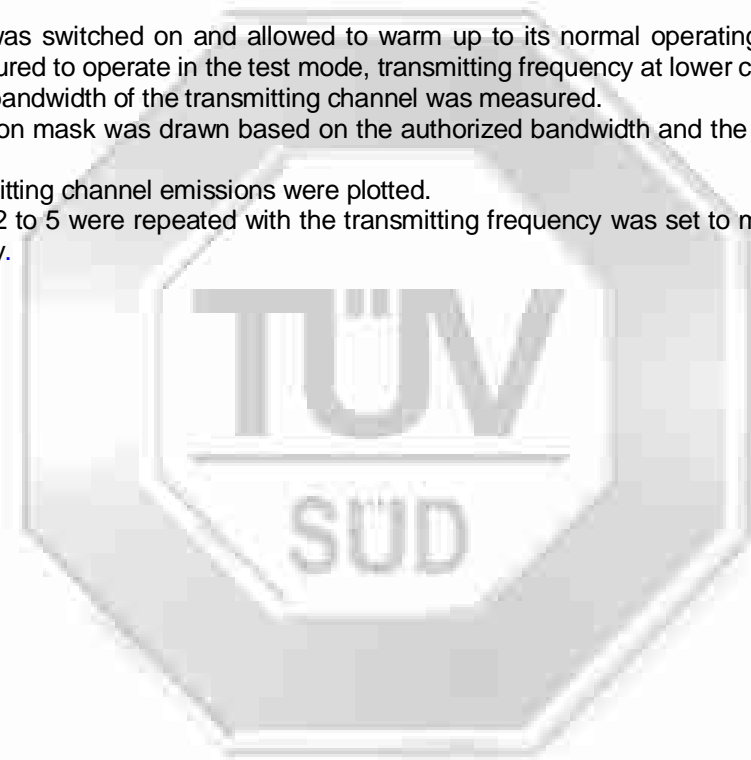



**UNWANTED EMISSIONS AT ANTENNA TERMINAL TEST**



**Unwanted Emissions at Antenna Terminal Test Setup**

**47 CFR FCC Parts 25.254(d)(6) and 2.1049 Occupied Bandwidth Results**

Operating Mode	Continuous Satellite Transmission	Temperature	23°C
Test Input Power	110V 60Hz	Relative Humidity	55%
Antenna Gain	10.0dBi	Atmospheric Pressure	1030mbar
Attached Plots	7 – 27 (26dB Bandwidth) 28 – 48 (In Band Emissions) 49 – 90 (Out of Band Spurious)	Tested By	Kyaw Soe Hein, Liau Lee Yin

All emissions are within the emission mask. Please refer to the attached plots.

**Notes**

1. The Resolution Bandwidth (RBW) was corrected from 4kHz by  $10\log_{10} [(used\ RBW) / 4kHz]$ .
2. Emission limits are computed based on following:
  - a. Emissions Limits (dBm) (50% - 100% authorised bandwidth) =  $P - 25 + CF$
  - b. Emissions Limits (dBm) (100% - 250% authorised bandwidth) =  $P - 35 + CF$
  - c. Emissions Limits (dBm) (> 250% authorised bandwidth) =  $P - [43 + 10 \log_{10} P_w] + 30 + CF$

where

P	=	Measured mean power in dBm
$P_w$	=	Measured mean power in W
CF	=	RBW correction factor (see Note 1)



UNWANTED EMISSIONS AT ANTENNA TERMINAL TEST

26dB Bandwidth Plots (Bearer Type: 0)

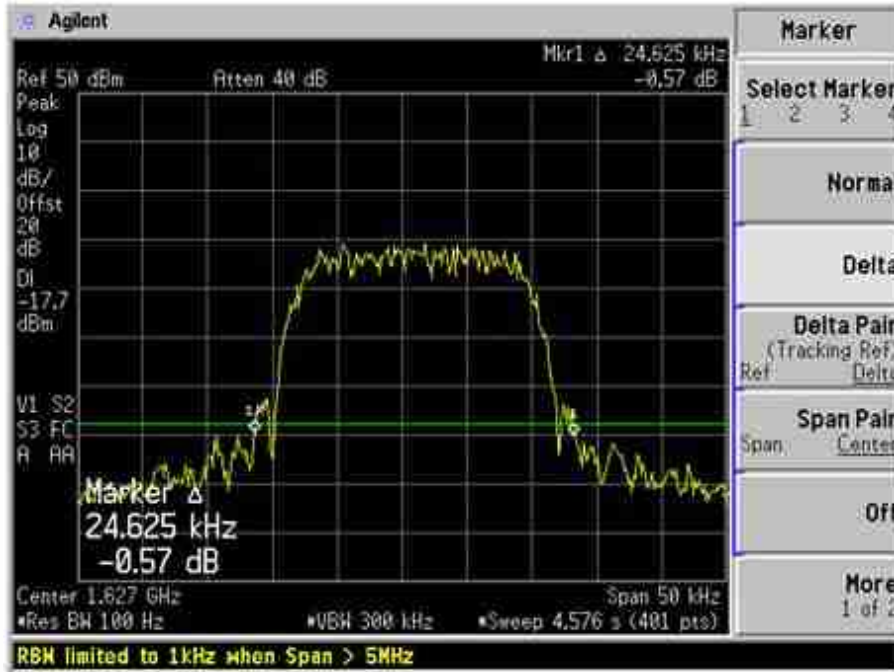

Plot 7 – Lower Channel

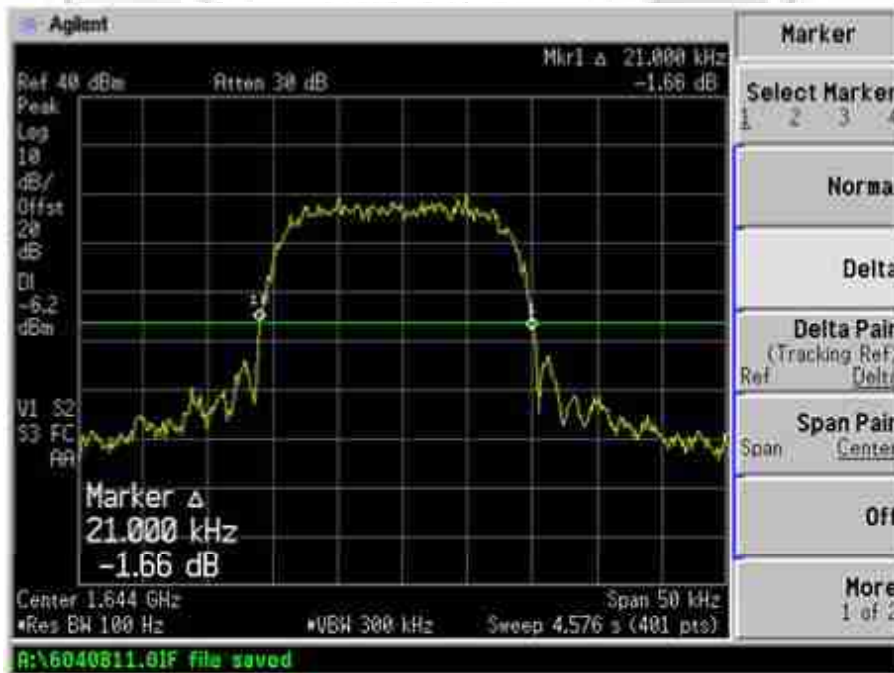

Plot 8 – Middle Channel

UNWANTED EMISSIONS AT ANTENNA TERMINAL TEST

26dB Bandwidth Plots (Bearer Type: 0)



Plot 9 - Upper Channel



UNWANTED EMISSIONS AT ANTENNA TERMINAL TEST

26dB Bandwidth Plots (Bearer Type: 3)

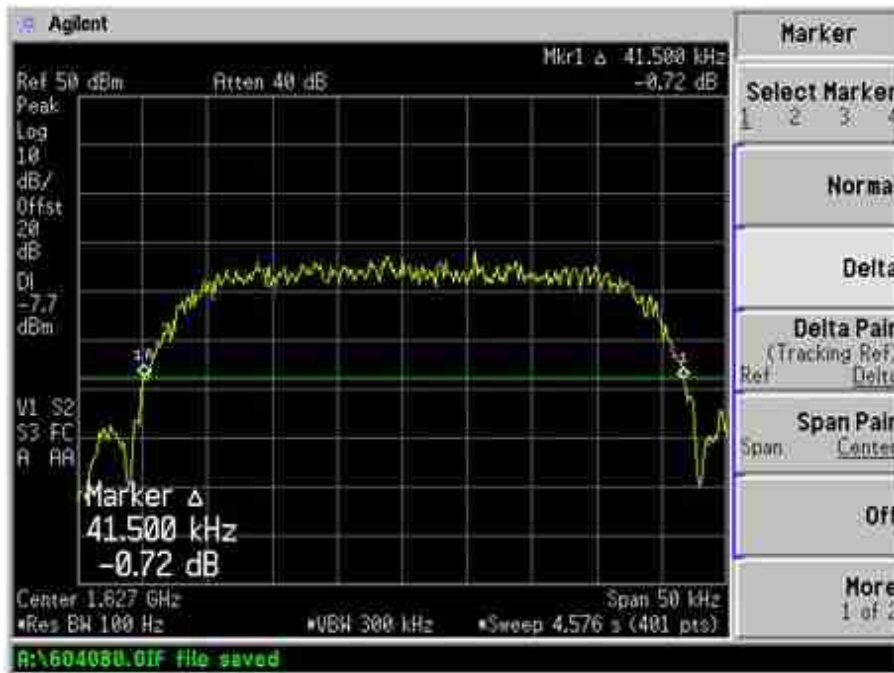

Plot 10 – Lower Channel

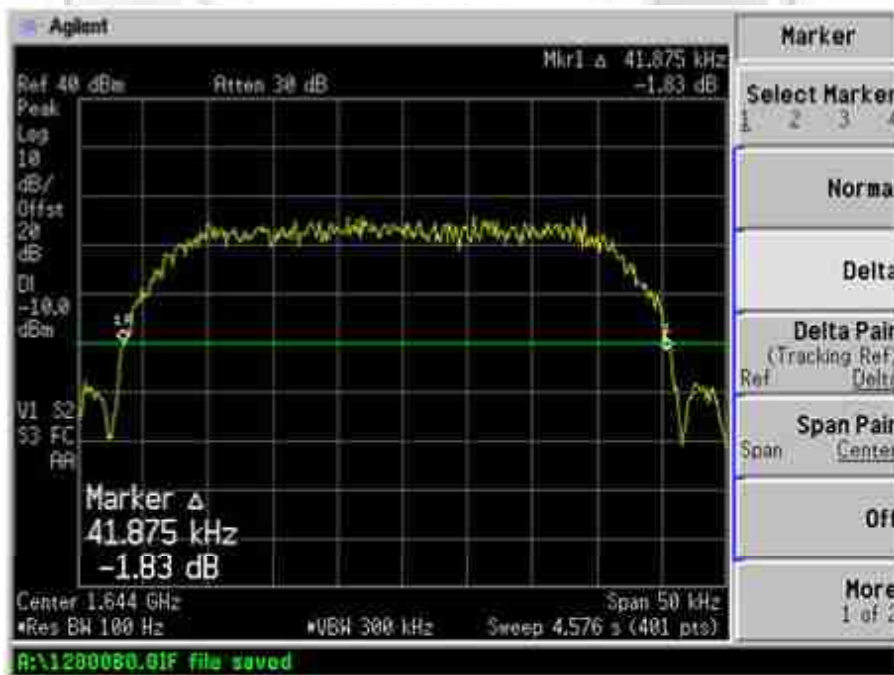

Plot 11 – Middle Channel



UNWANTED EMISSIONS AT ANTENNA TERMINAL TEST

26dB Bandwidth Plots (Bearer Type: 3)

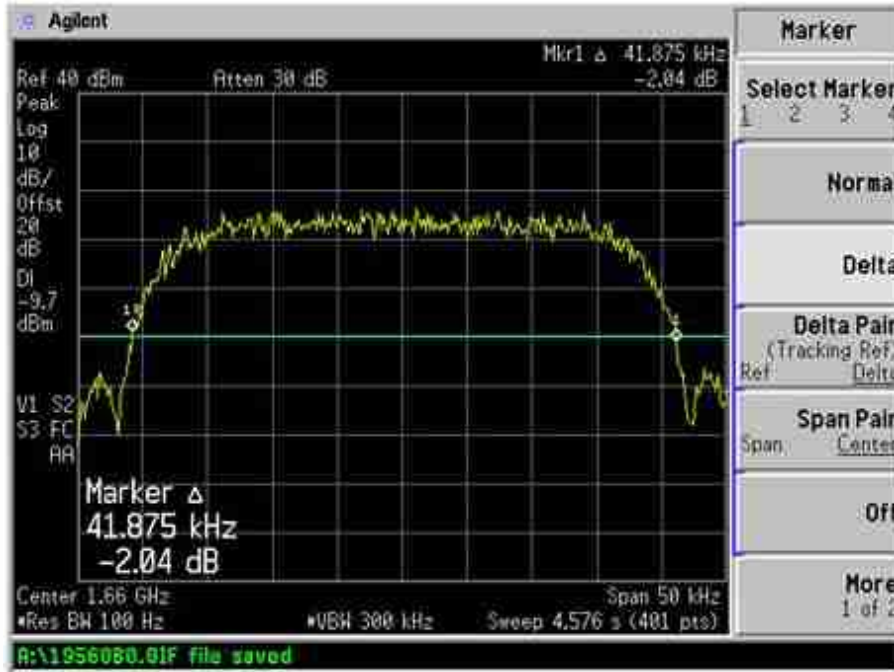

Plot 12 – Upper Channel

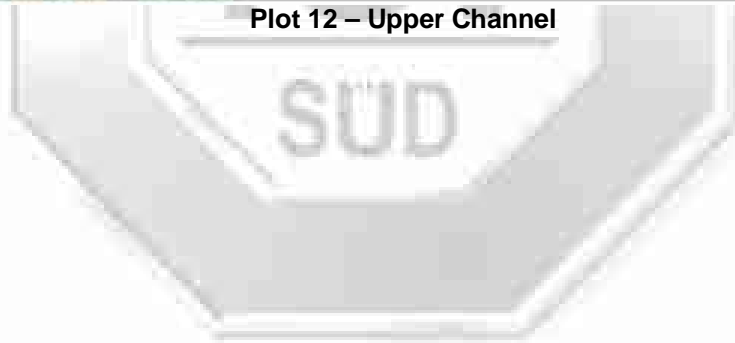

UNWANTED EMISSIONS AT ANTENNA TERMINAL TEST

26dB Bandwidth Plots (Bearer Type: 5)

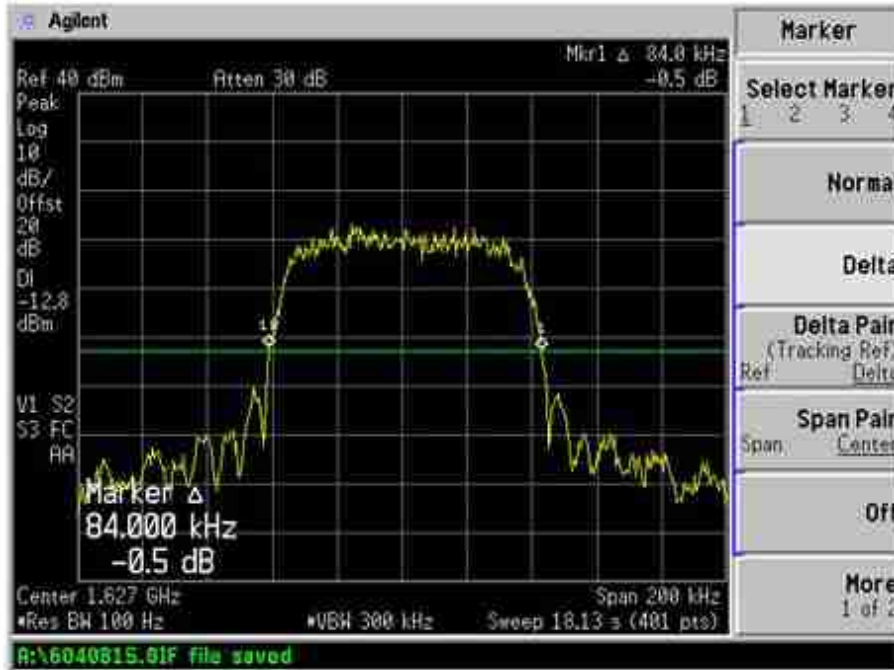

Plot 13 – Lower Channel

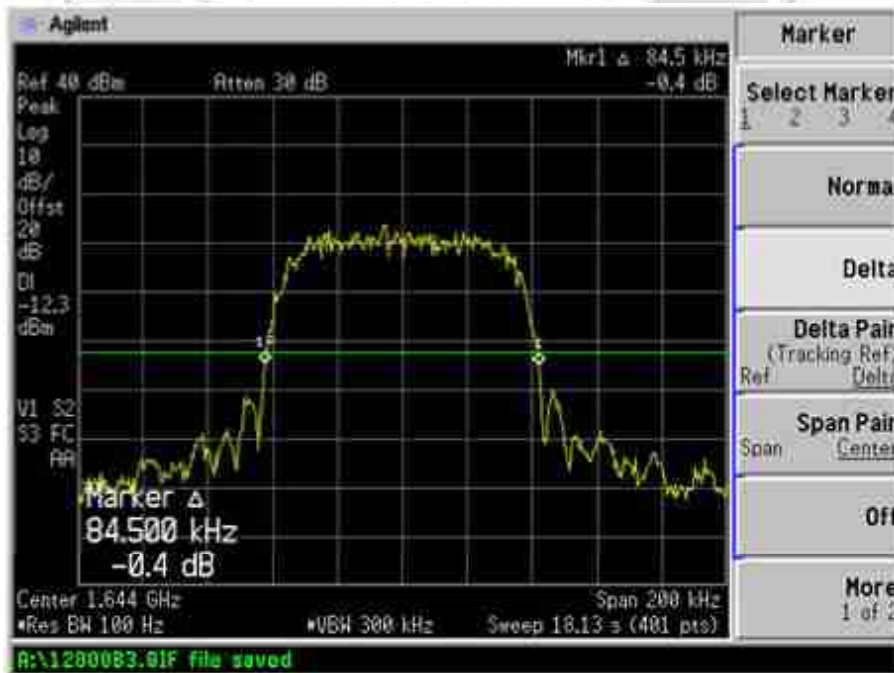

Plot 14 – Middle Channel

UNWANTED EMISSIONS AT ANTENNA TERMINAL TEST

26dB Bandwidth Plots (Bearer Type: 5)

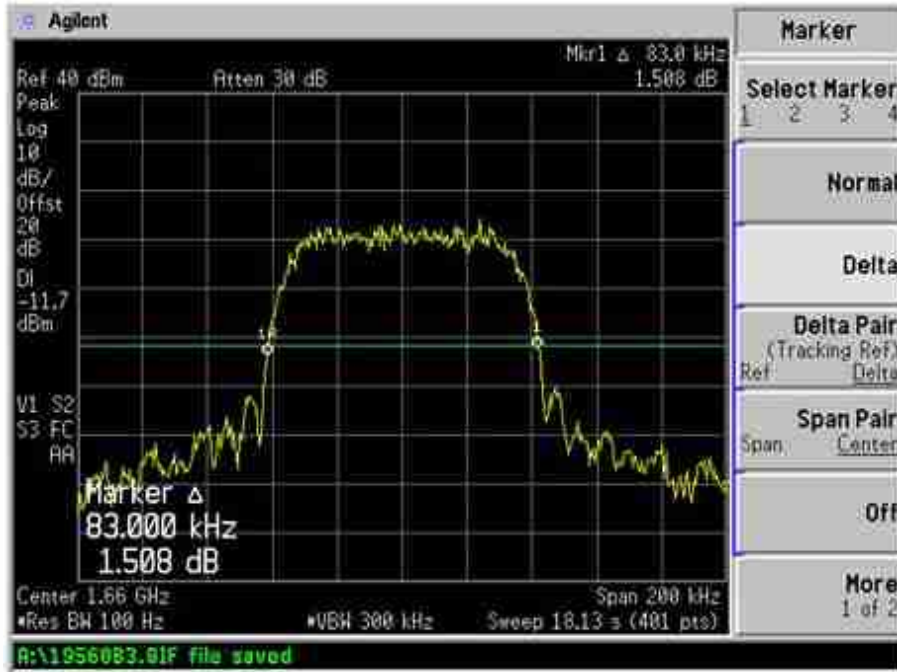

Plot 15 – Upper Channel

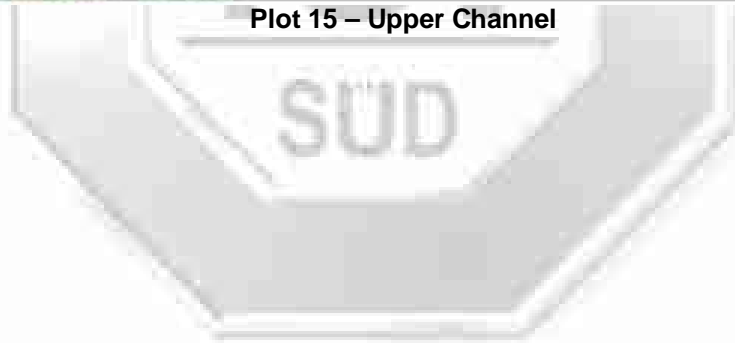



UNWANTED EMISSIONS AT ANTENNA TERMINAL TEST

26dB Bandwidth Plots (Bearer Type: 7)

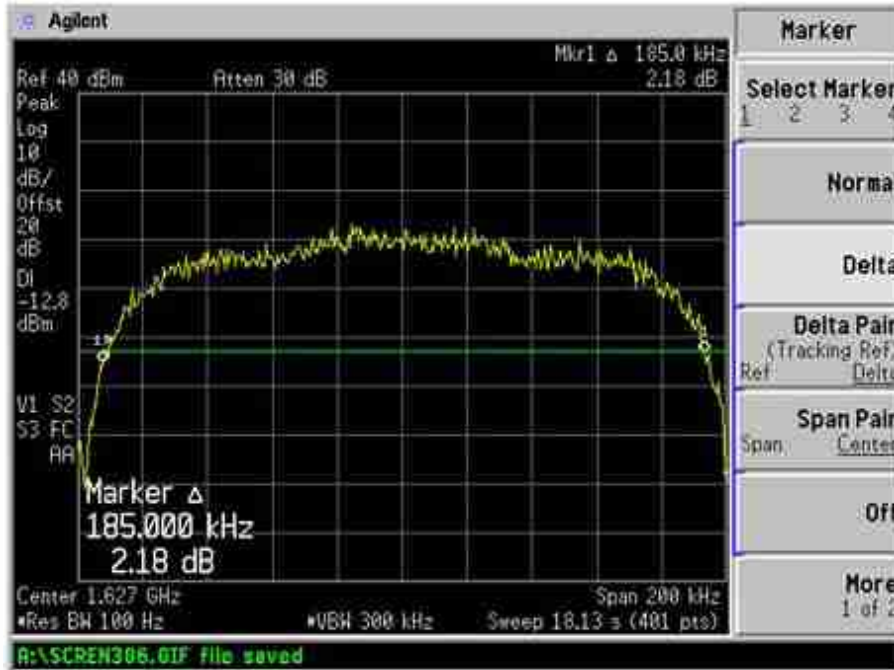

Plot 16 – Lower Channel

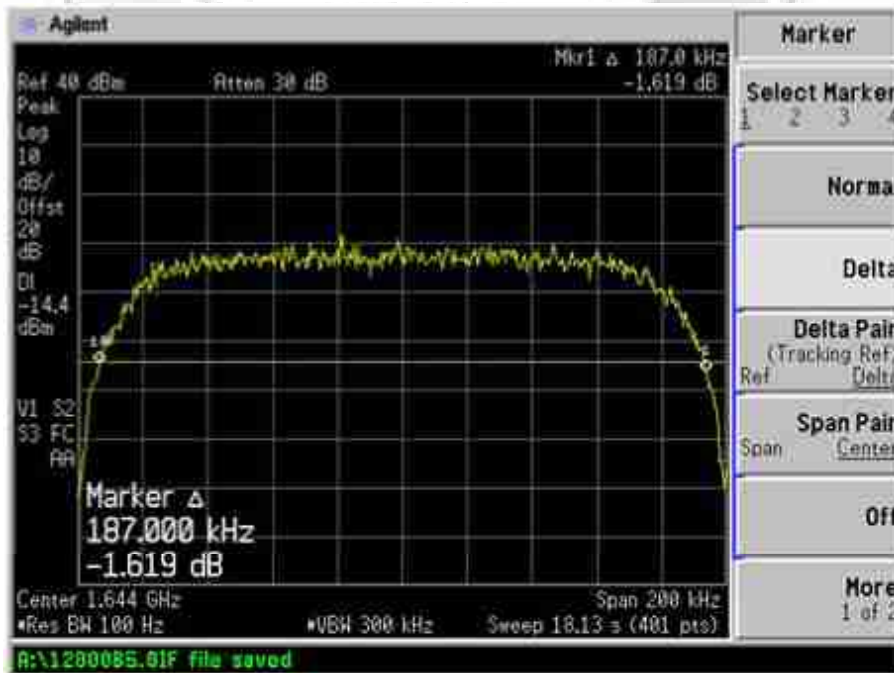

Plot 17 – Middle Channel

UNWANTED EMISSIONS AT ANTENNA TERMINAL TEST

26dB Bandwidth Plots (Bearer Type: 7)

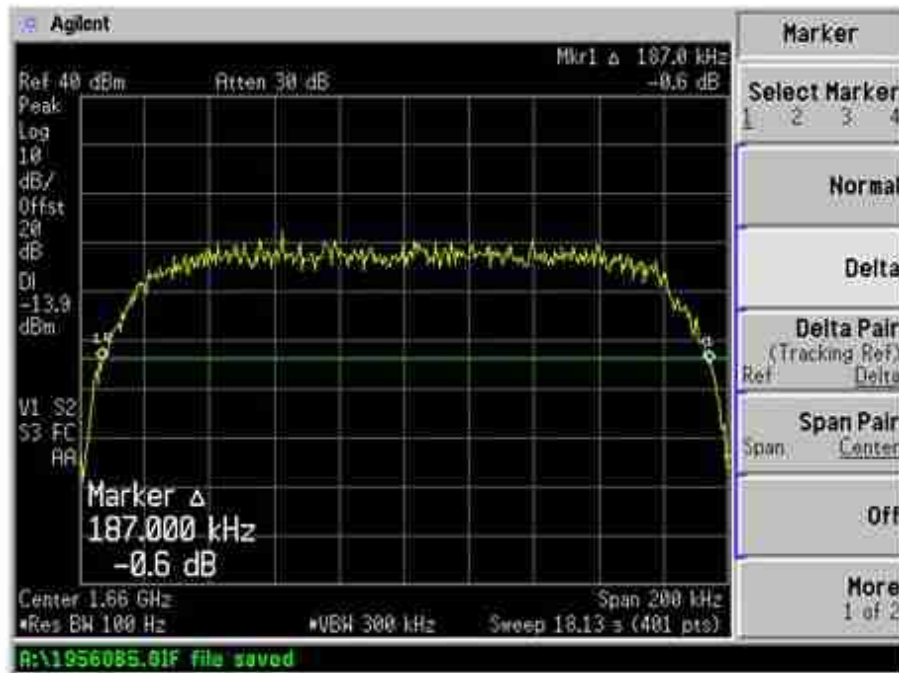

Plot 18 – Upper Channel

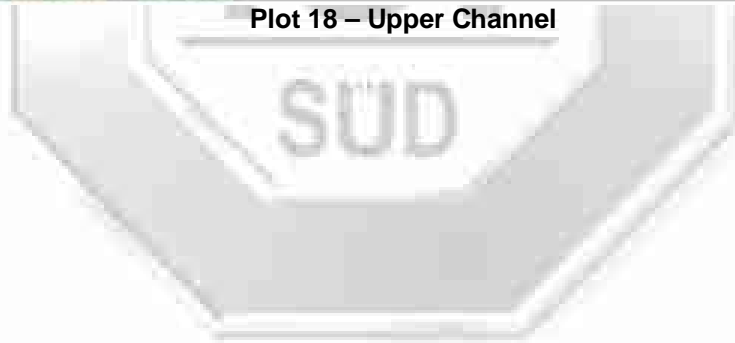



UNWANTED EMISSIONS AT ANTENNA TERMINAL TEST

26dB Bandwidth Plots (Bearer Type: 11)

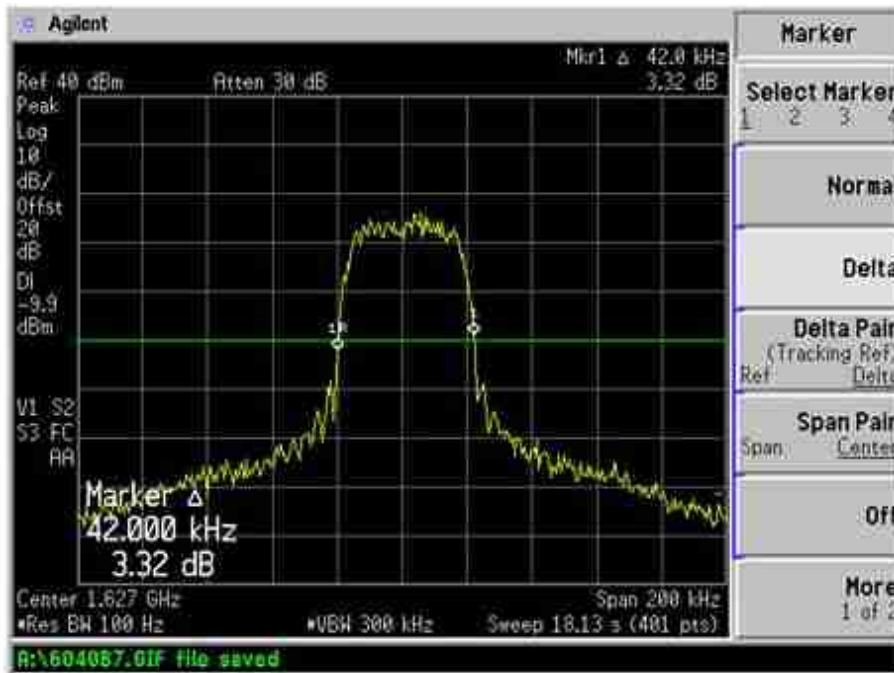

Plot 19 – Lower Channel

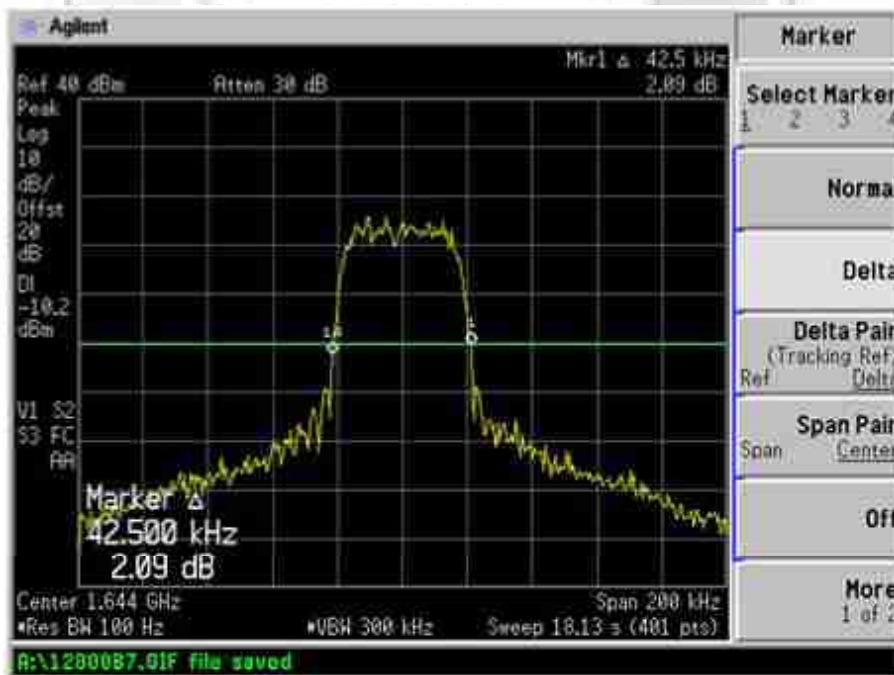

Plot 20 – Middle Channel

UNWANTED EMISSIONS AT ANTENNA TERMINAL TEST

26dB Bandwidth Plots (Bearer Type: 11)

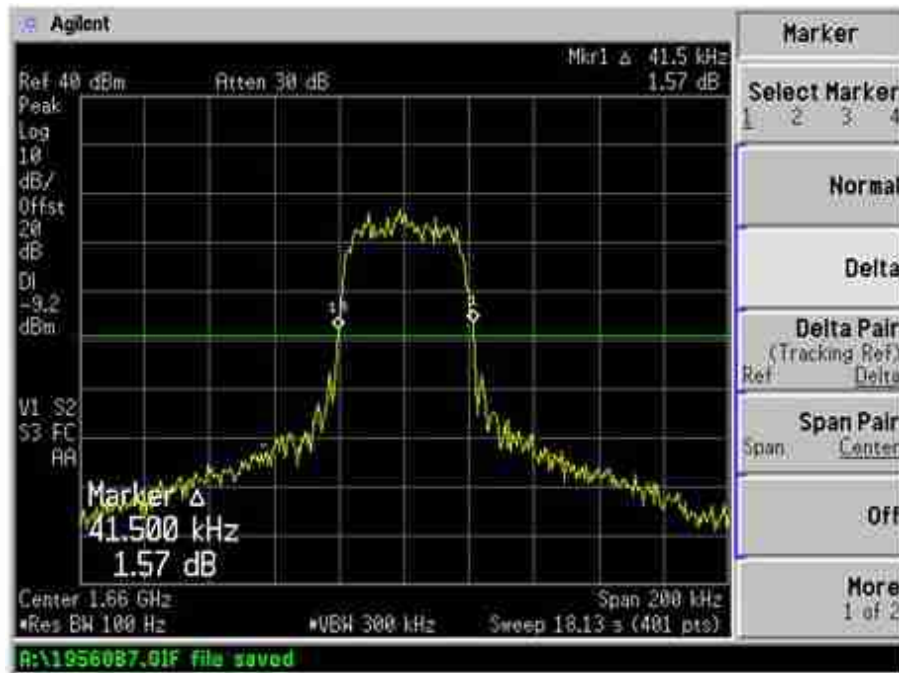

Plot 21 - Upper Channel

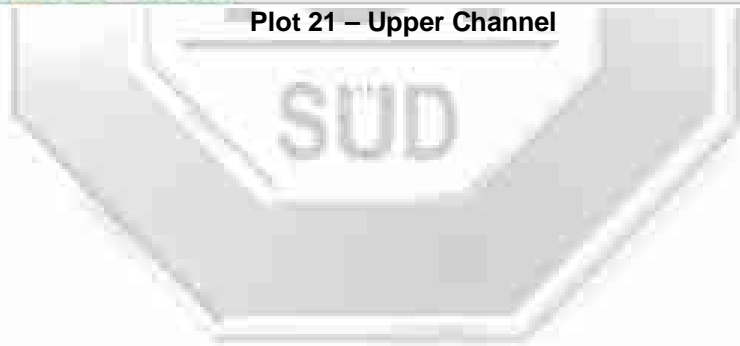

UNWANTED EMISSIONS AT ANTENNA TERMINAL TEST

26dB Bandwidth Plots (Bearer Type: 13)

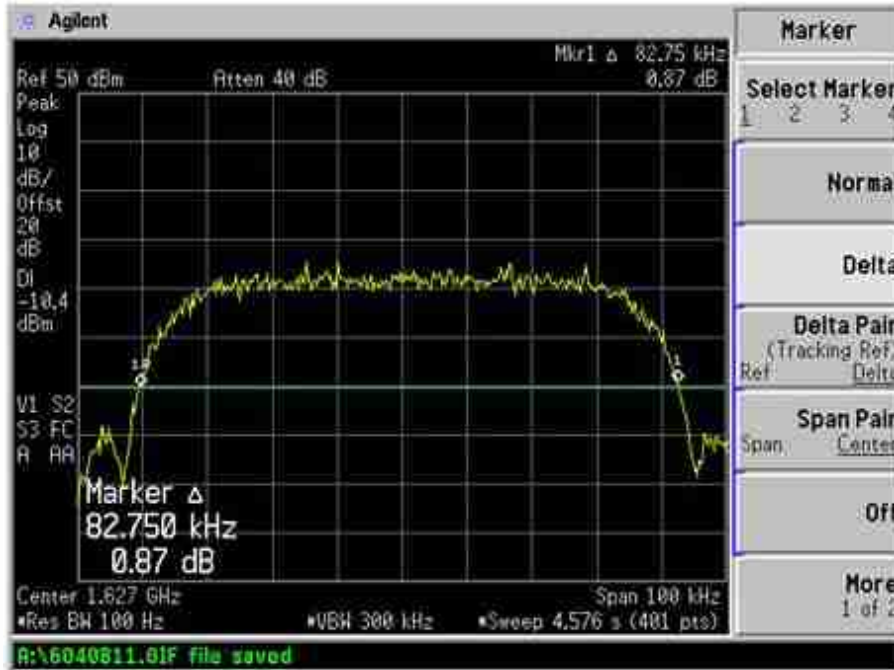

Plot 22 – Lower Channel

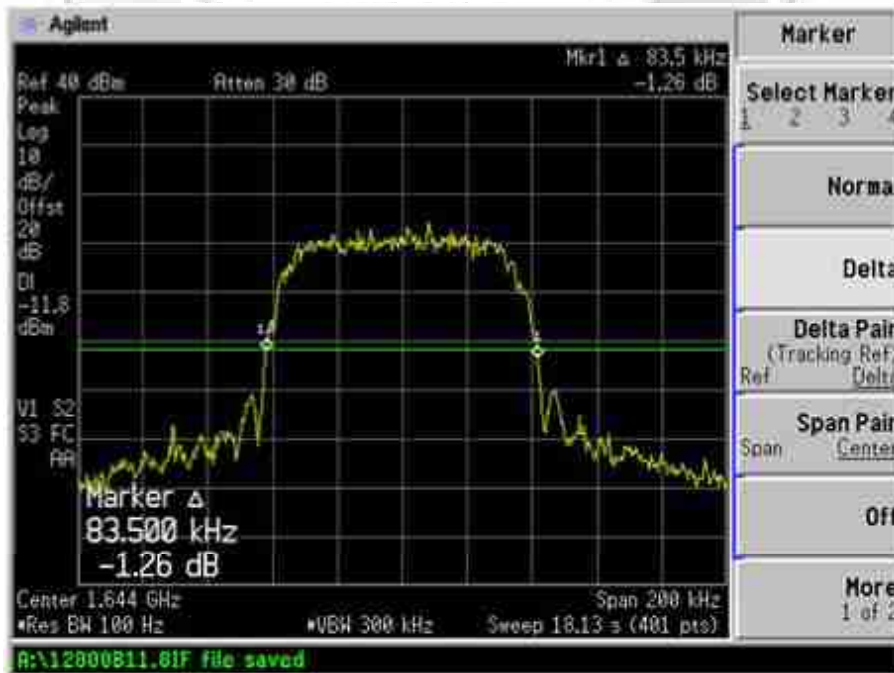

Plot 23 – Middle Channel

UNWANTED EMISSIONS AT ANTENNA TERMINAL TEST

26dB Bandwidth Plots (Bearer Type: 13)

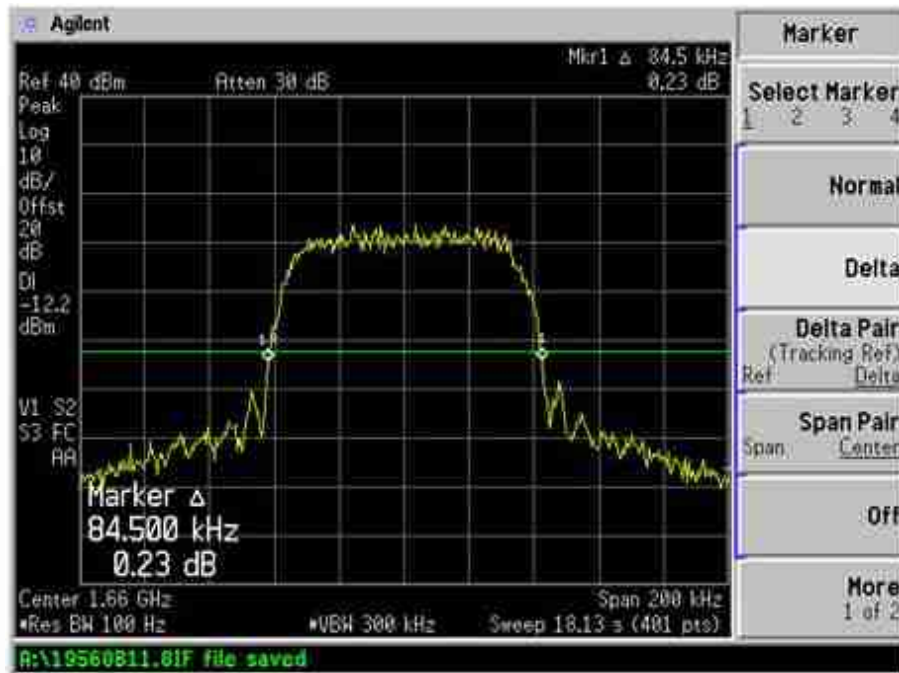

Plot 24 - Upper Channel

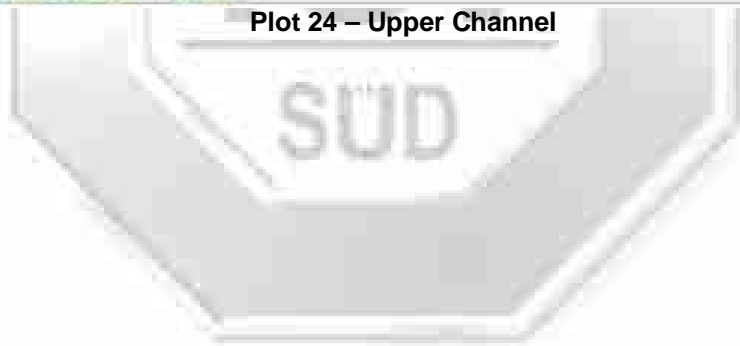

UNWANTED EMISSIONS AT ANTENNA TERMINAL TEST

26dB Bandwidth Plots (Bearer Type: 15)

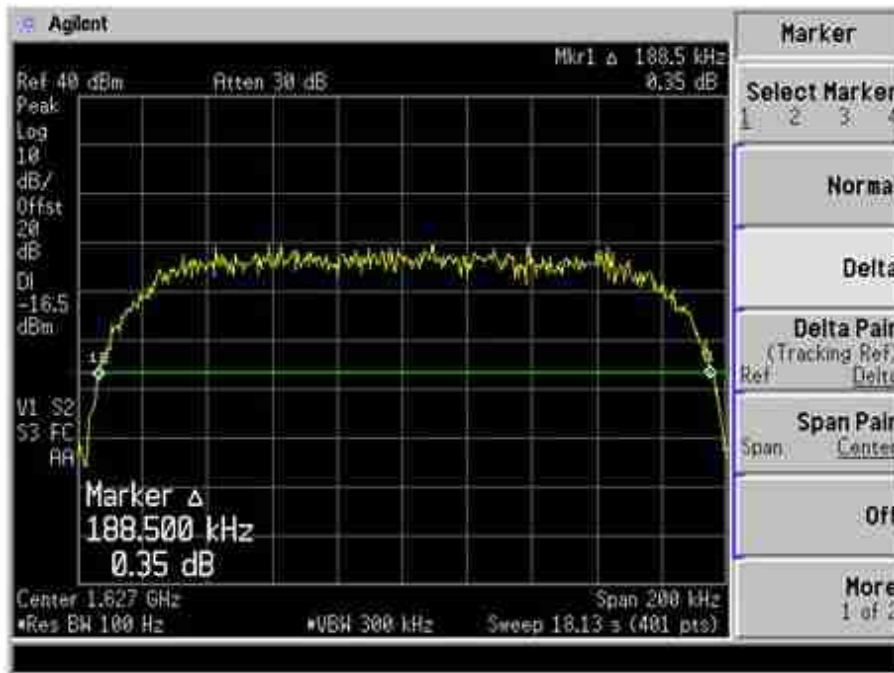

Plot 25 – Lower Channel

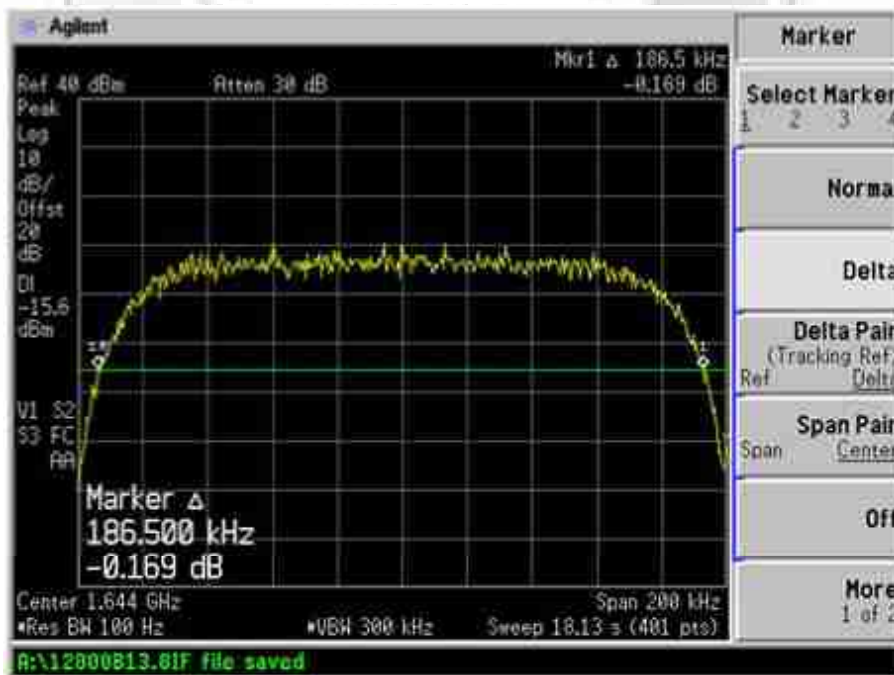

Plot 26 – Middle Channel

UNWANTED EMISSIONS AT ANTENNA TERMINAL TEST

26dB Bandwidth Plots (Bearer Type: 15)

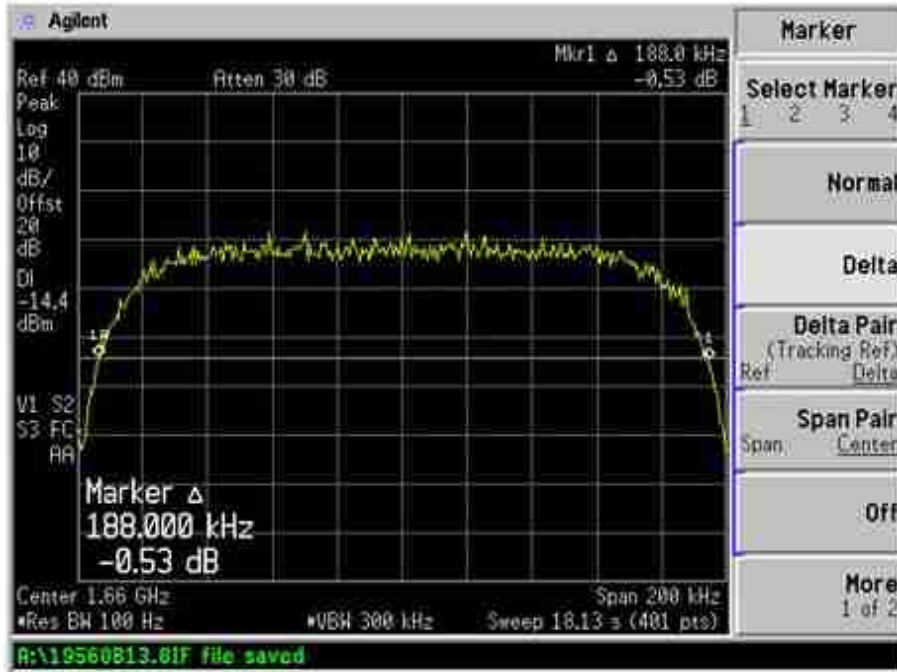

Plot 27 – Upper Channel

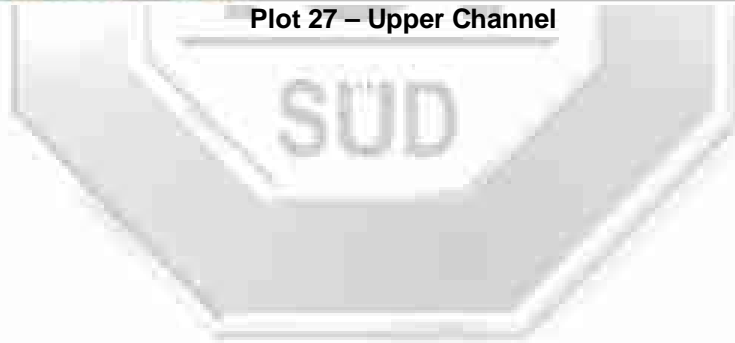



UNWANTED EMISSIONS AT ANTENNA TERMINAL TEST

In Band Emissions Plots (Bearer Type: 0)

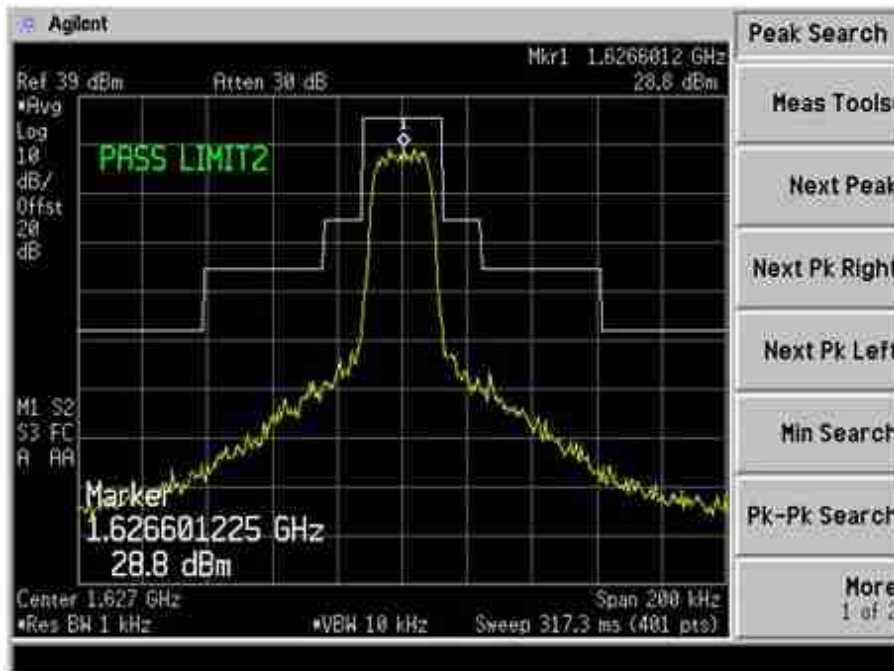

Plot 28 - Lower Channel

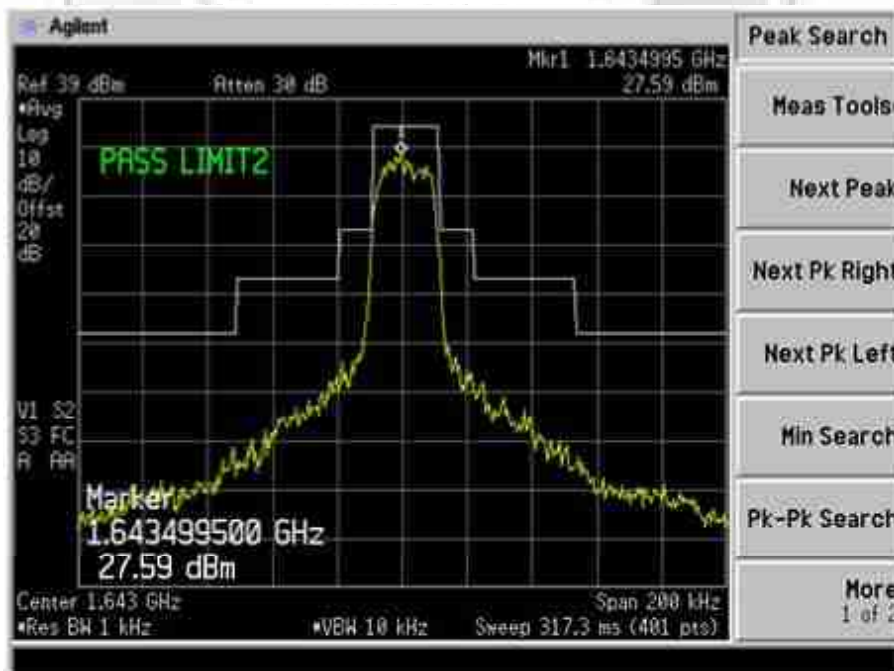

Plot 29 - Middle Channel



UNWANTED EMISSIONS AT ANTENNA TERMINAL TEST

In Band Emissions Plots (Bearer Type: 0)

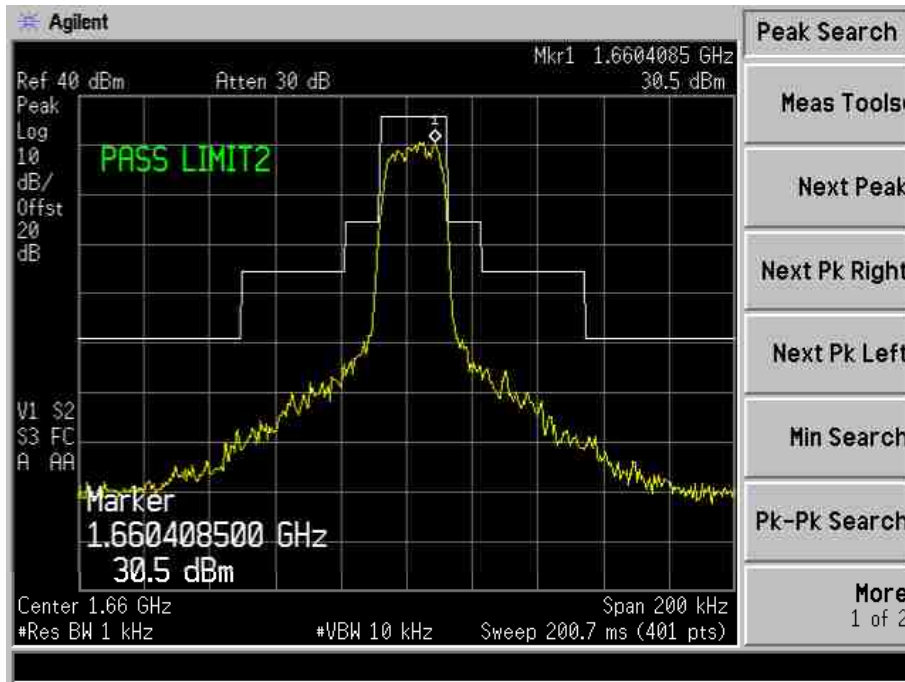

Plot 30 – Upper Channel





UNWANTED EMISSIONS AT ANTENNA TERMINAL TEST

In Band Emissions Plots (Bearer Type: 3)

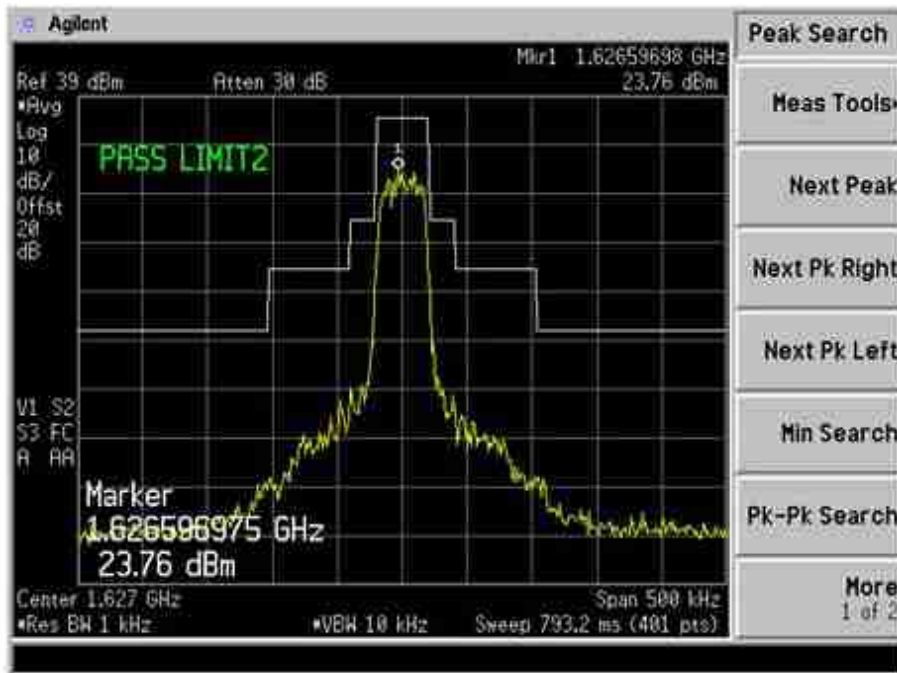

Plot 31 – Lower Channel

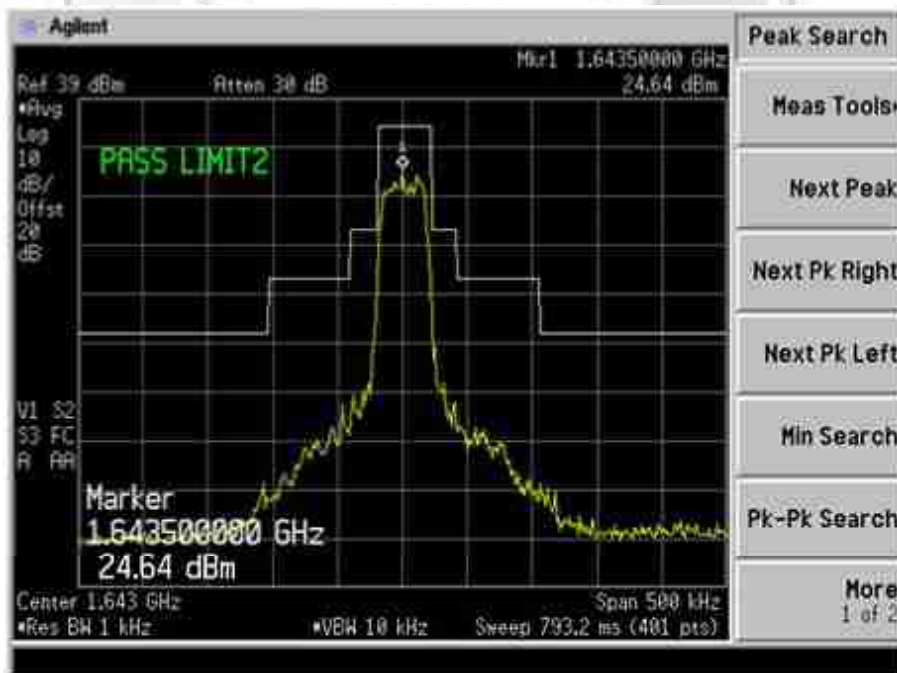

Plot 32 – Middle Channel



UNWANTED EMISSIONS AT ANTENNA TERMINAL TEST

In Band Emissions Plots (Bearer Type: 3)

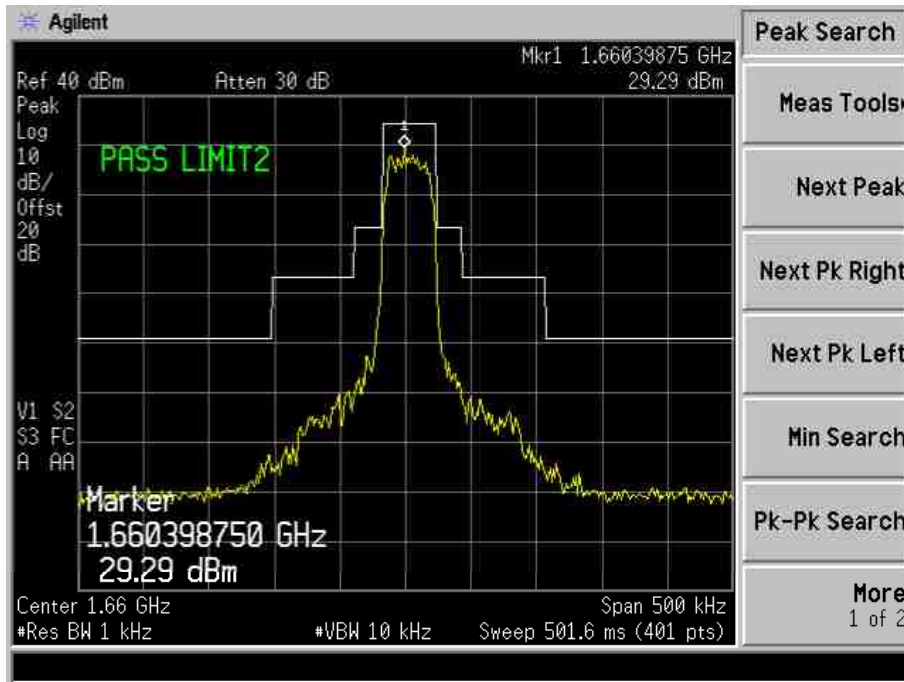

Plot 33 - Upper Channel

UNWANTED EMISSIONS AT ANTENNA TERMINAL TEST

In Band Emissions Plots (Bearer Type: 5)

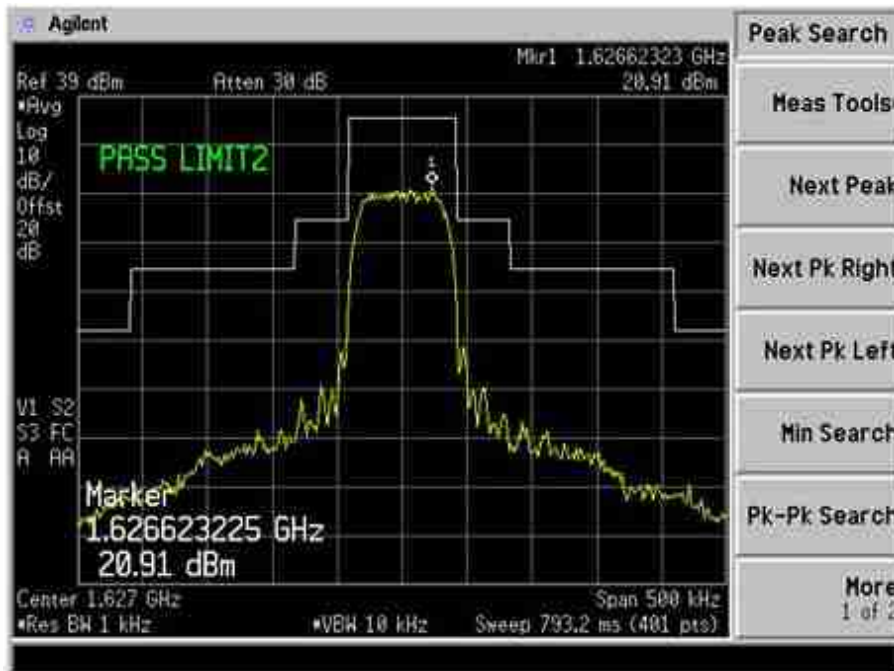

Plot 34 – Lower Channel

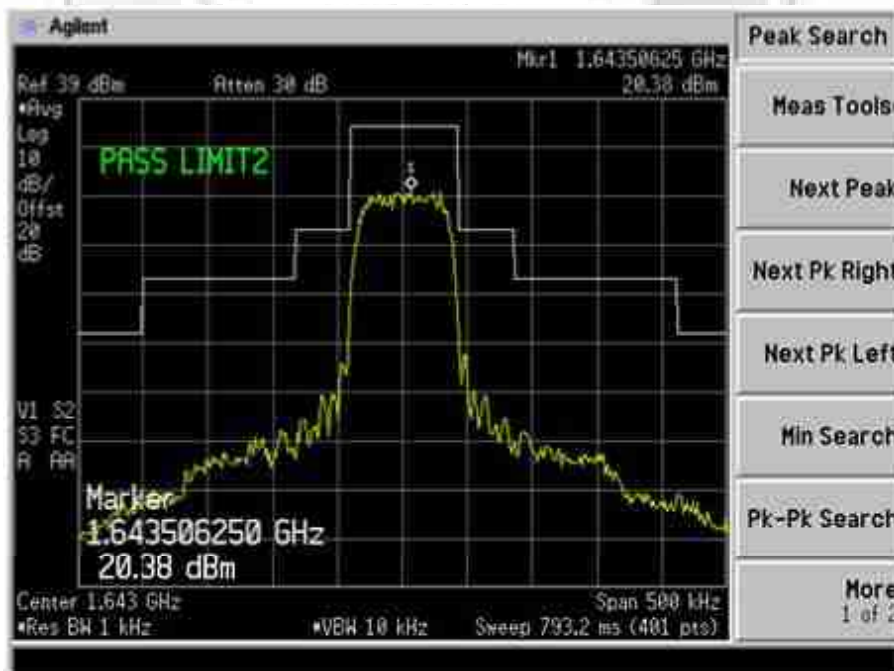

Plot 35 – Middle Channel



UNWANTED EMISSIONS AT ANTENNA TERMINAL TEST

In Band Emissions Plots (Bearer Type: 5)

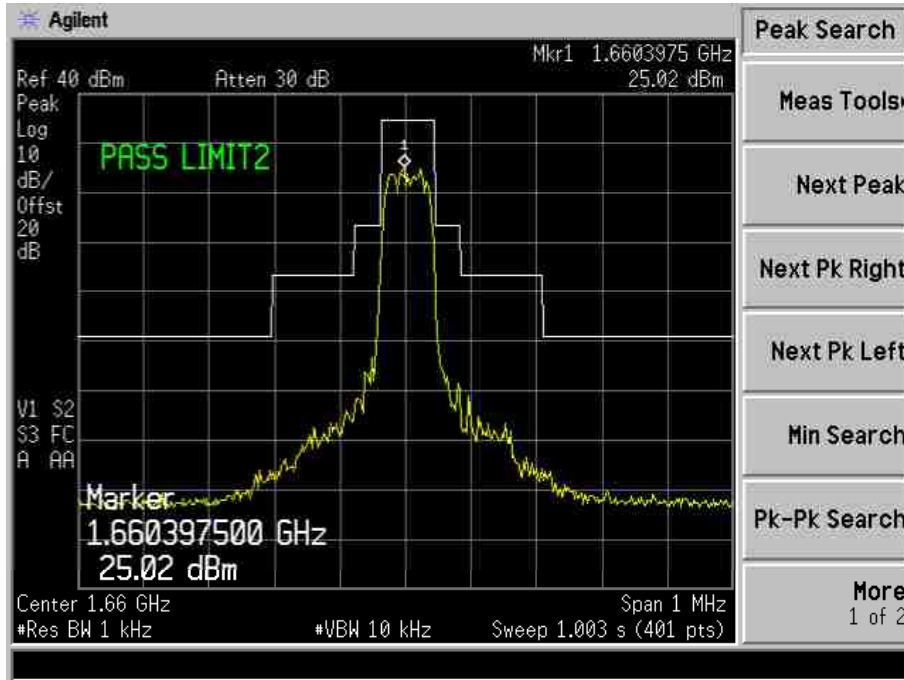

Plot 36 – Upper Channel



UNWANTED EMISSIONS AT ANTENNA TERMINAL TEST

In Band Emissions Plots (Bearer Type: 7)

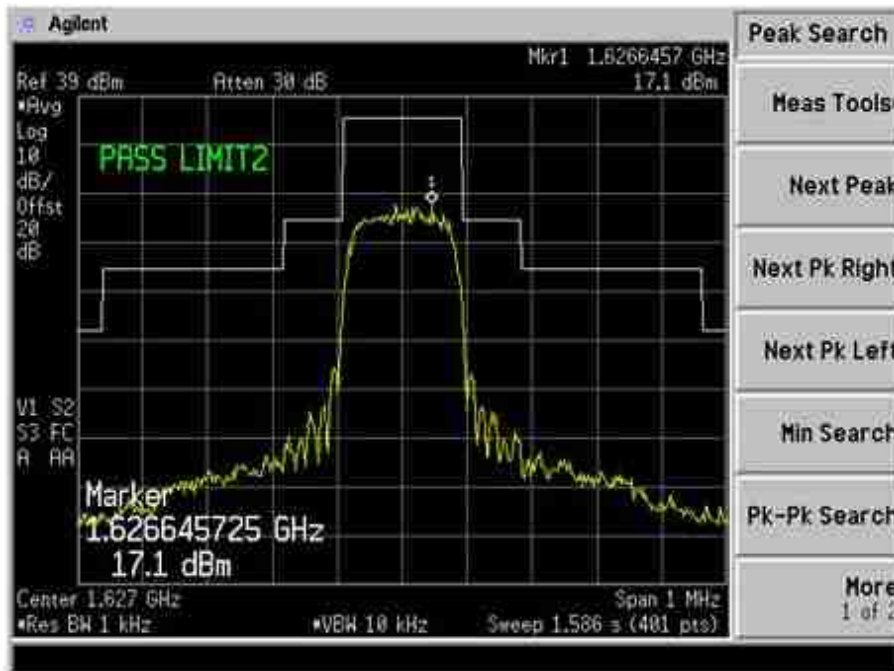

Plot 37 – Lower Channel

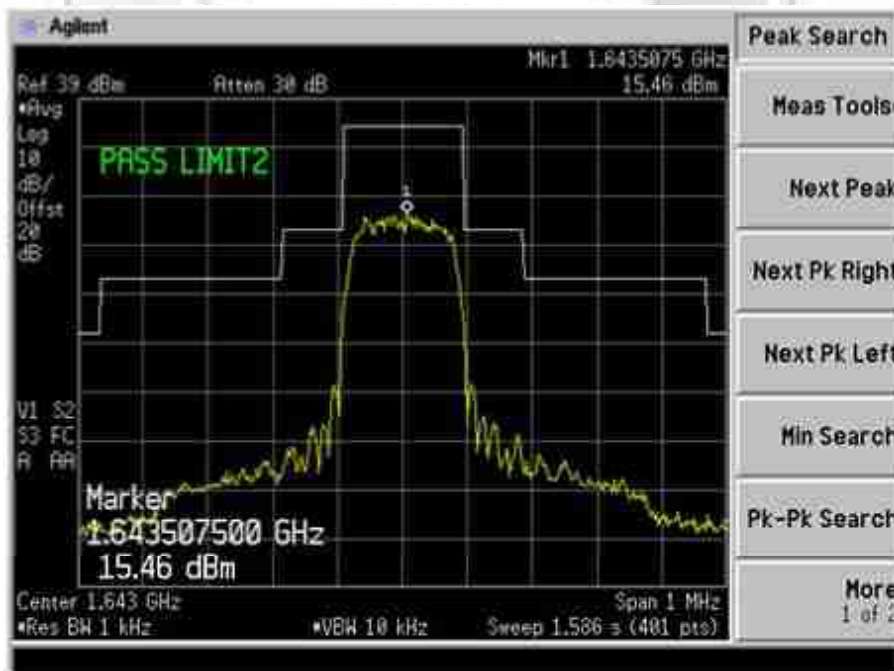

Plot 38 – Middle Channel



UNWANTED EMISSIONS AT ANTENNA TERMINAL TEST

In Band Emissions Plots (Bearer Type: 7)

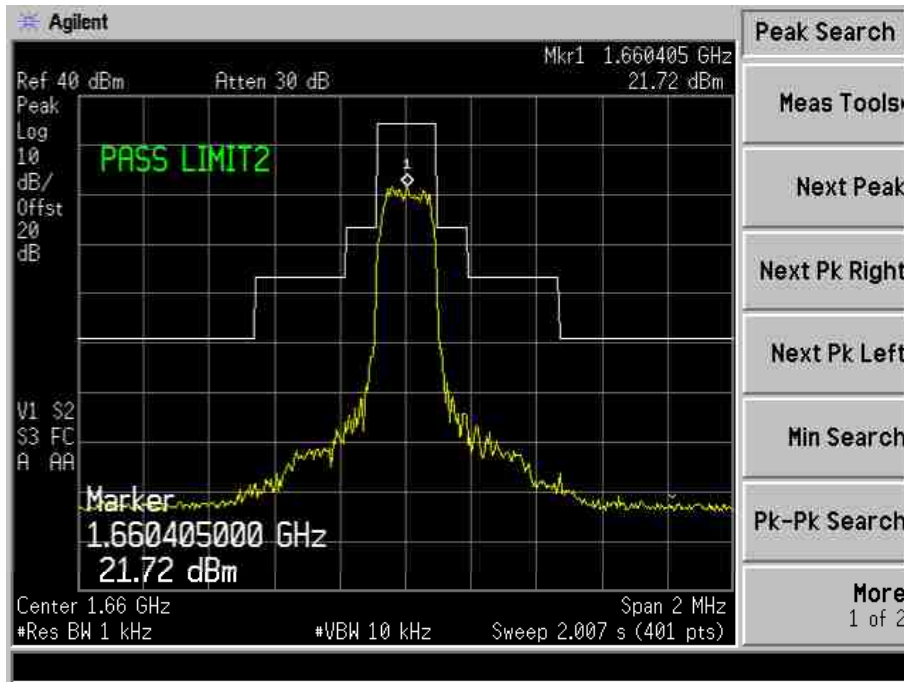

Plot 39 – Upper Channel





UNWANTED EMISSIONS AT ANTENNA TERMINAL TEST

In Band Emissions Plots (Bearer Type: 11)

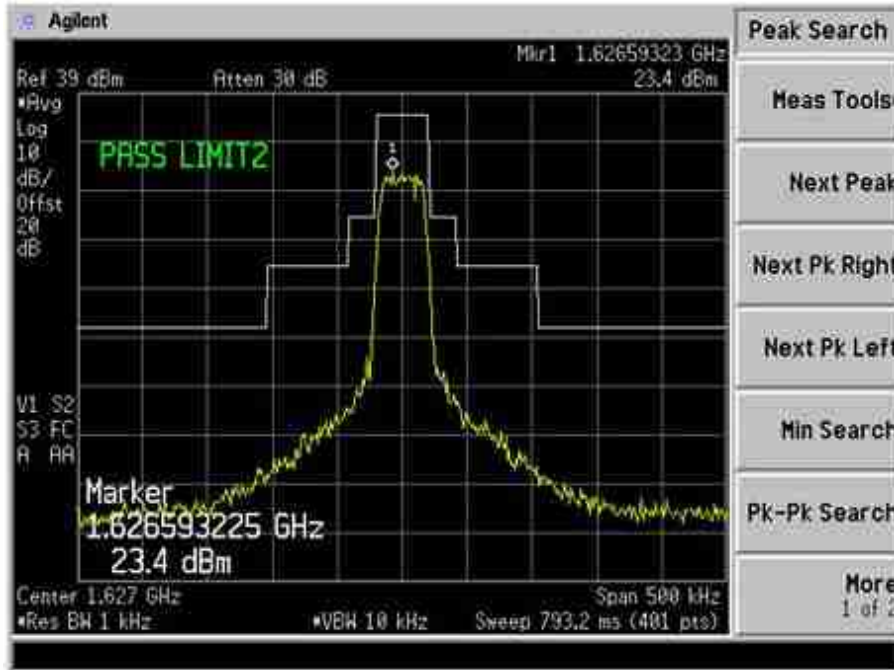

Plot 40 – Lower Channel

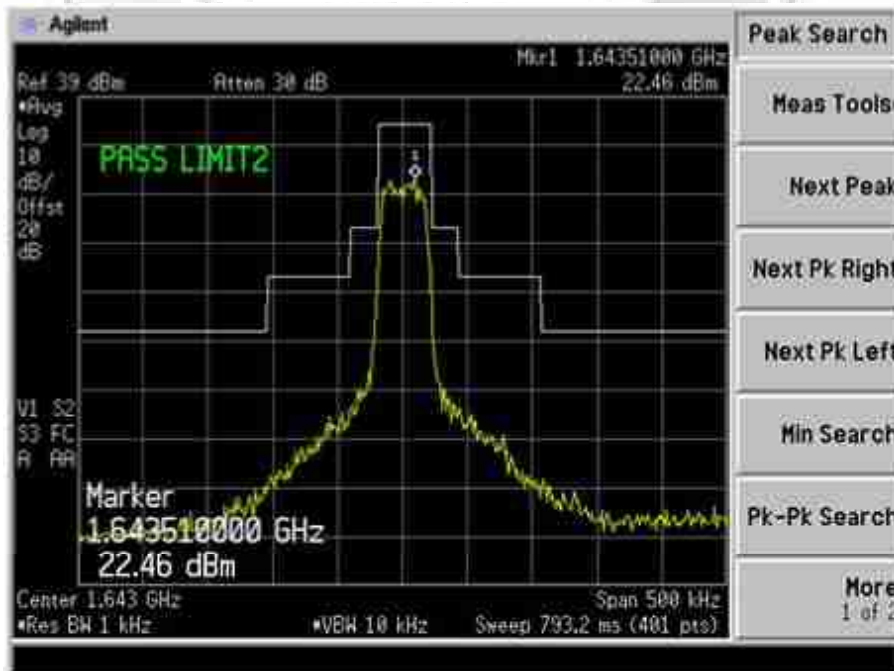

Plot 41 – Middle Channel





UNWANTED EMISSIONS AT ANTENNA TERMINAL TEST

In Band Emissions Plots (Bearer Type: 11)

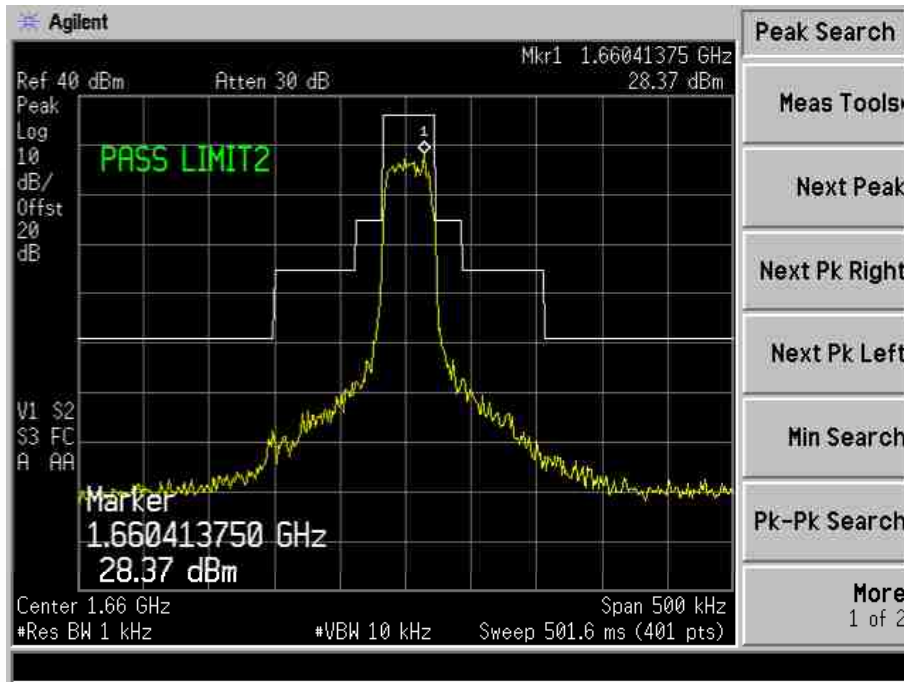

Plot 42 – High Channel



UNWANTED EMISSIONS AT ANTENNA TERMINAL TEST

In Band Emissions Plots (Bearer Type: 13)

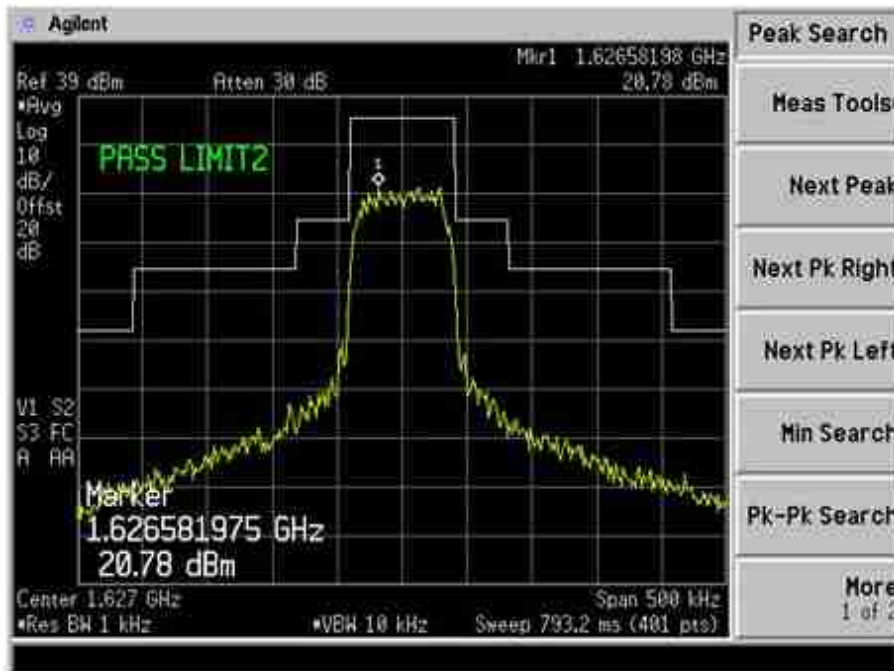

Plot 43 – Lower Channel

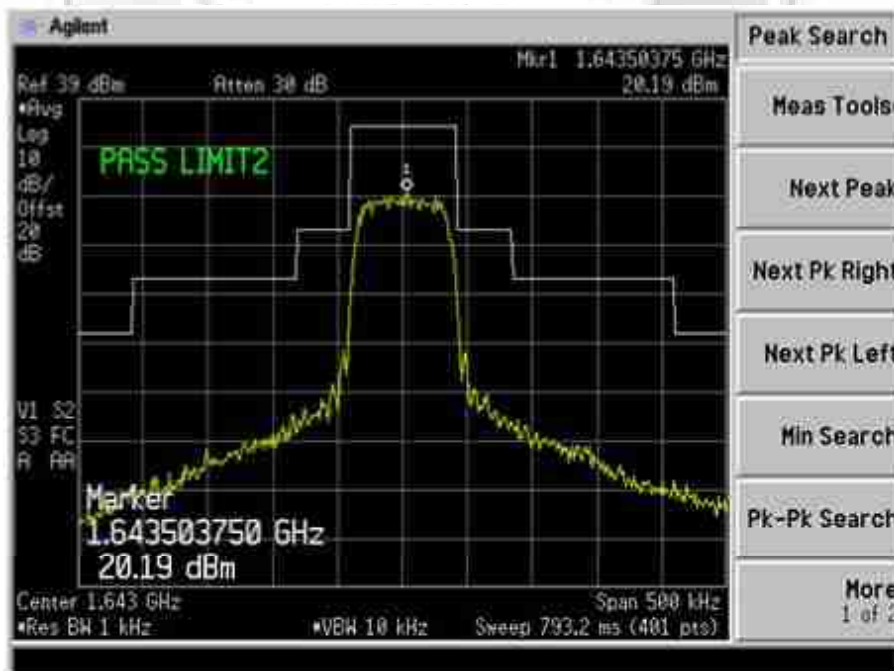

Plot 44 – Middle Channel



UNWANTED EMISSIONS AT ANTENNA TERMINAL TEST

In Band Emissions Plots (Bearer Type: 13)

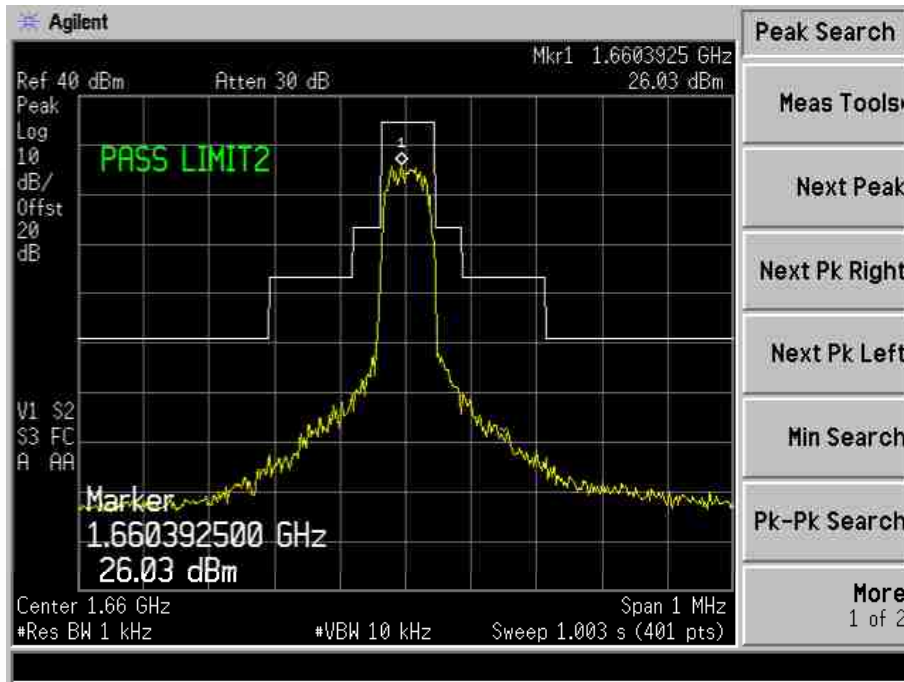

Plot 45 – Upper Channel

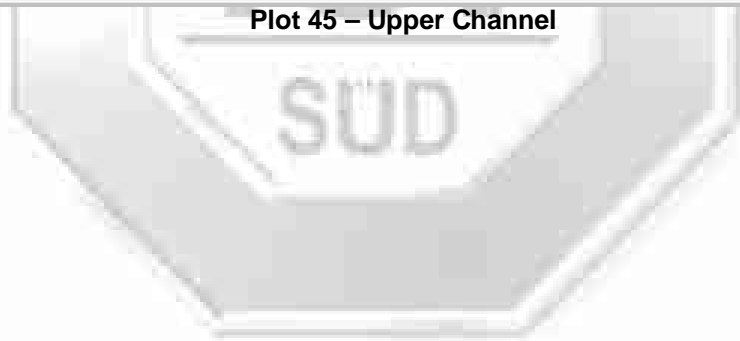

UNWANTED EMISSIONS AT ANTENNA TERMINAL TEST

In Band Emissions Plots (Bearer Type: 15)

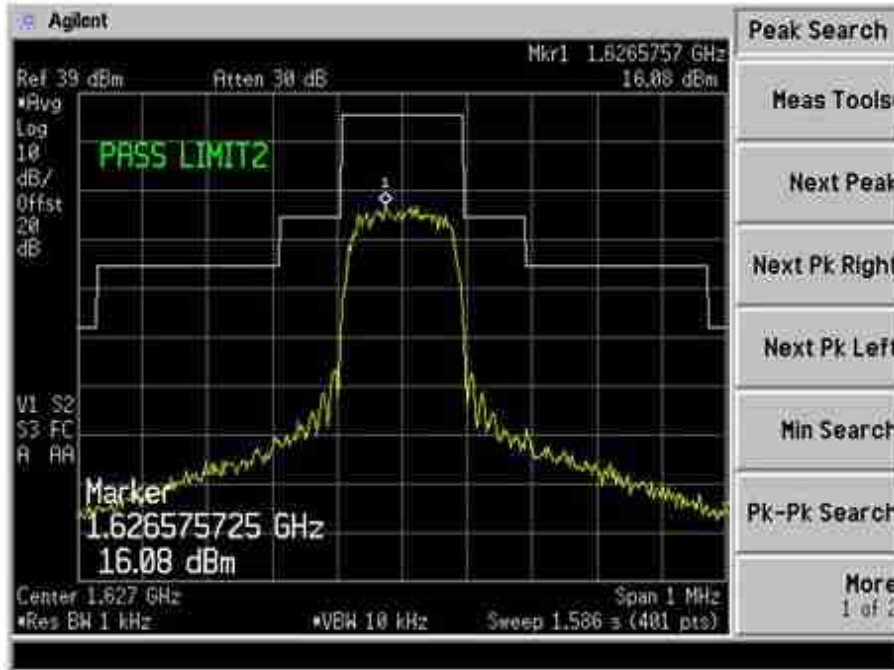

Plot 46 – Lower Channel

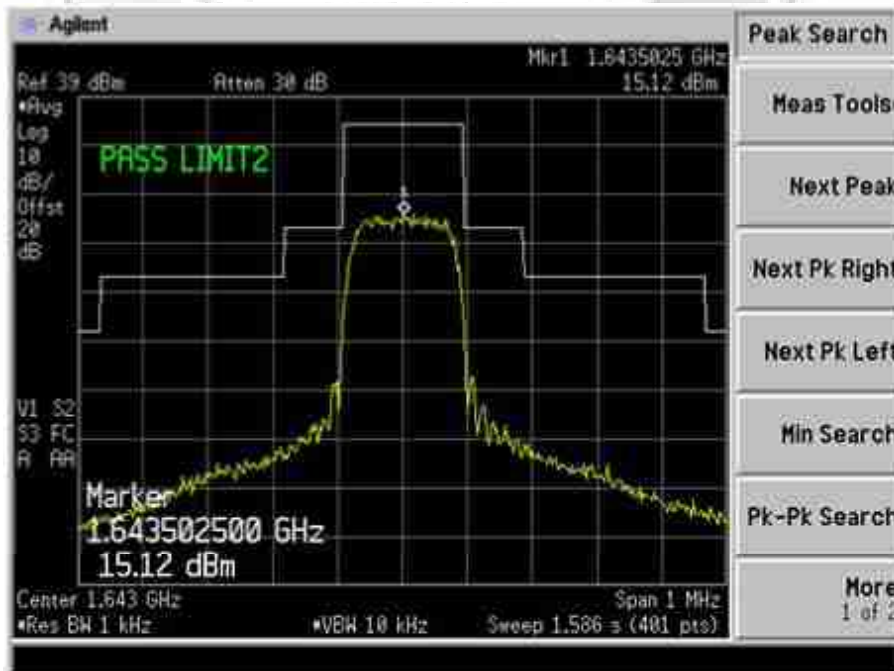

Plot 47 – Middle Channel



UNWANTED EMISSIONS AT ANTENNA TERMINAL TEST

In Band Emissions Plots (Bearer Type: 15)

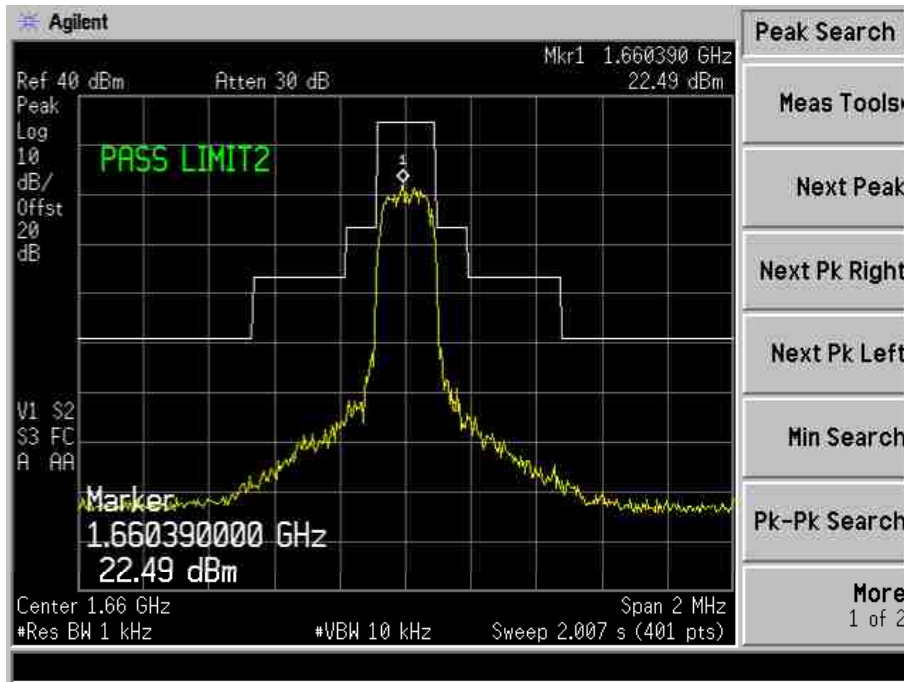

Plot 48 – Upper Channel



UNWANTED EMISSIONS AT ANTENNA TERMINAL TEST

Out of Band Spurious Plots (Bearer Type: 0)

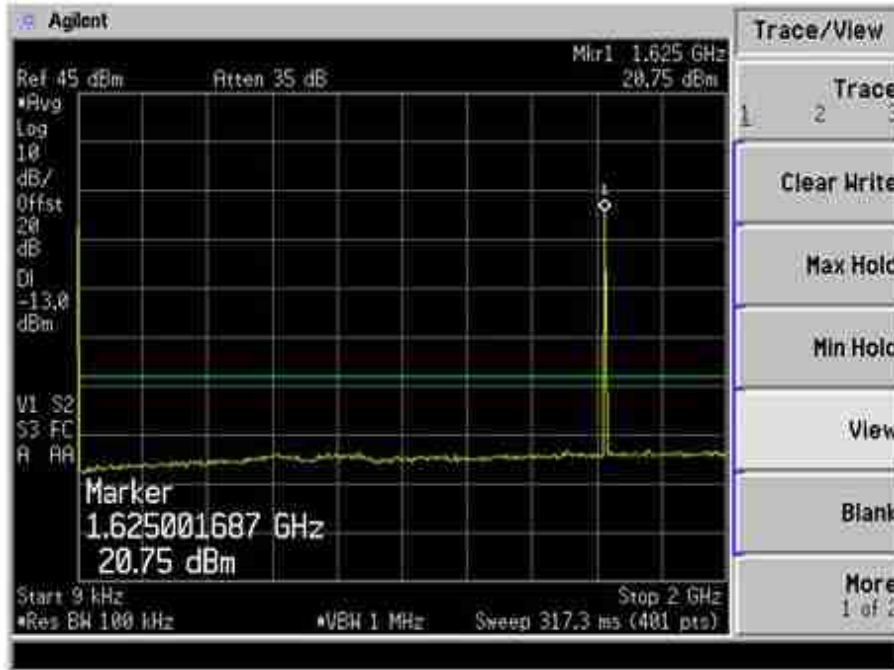

Plot 49 – Lower Channel

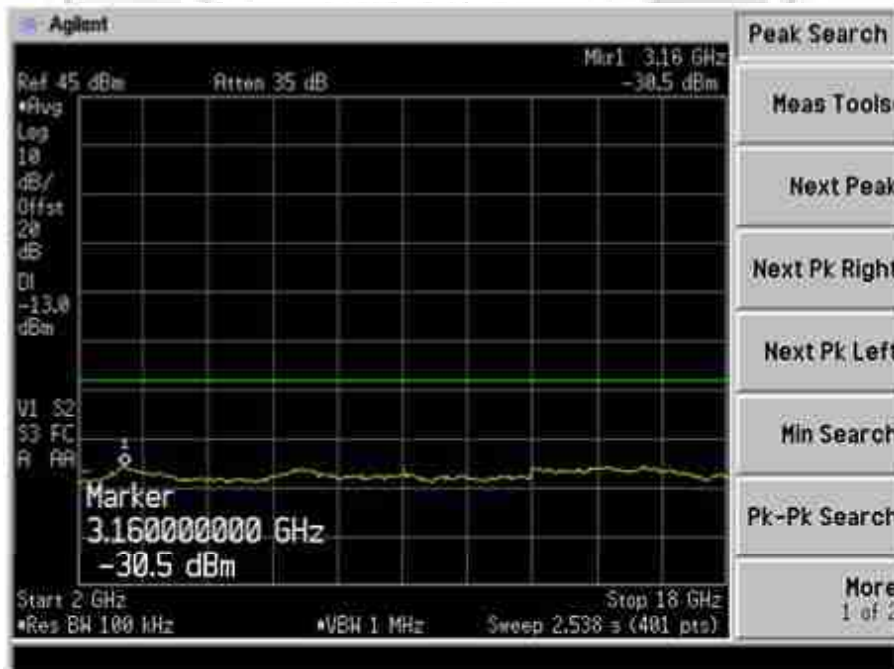

Plot 50 – Lower Channel



UNWANTED EMISSIONS AT ANTENNA TERMINAL TEST

Out of Band Spurious Plots (Bearer Type: 0)

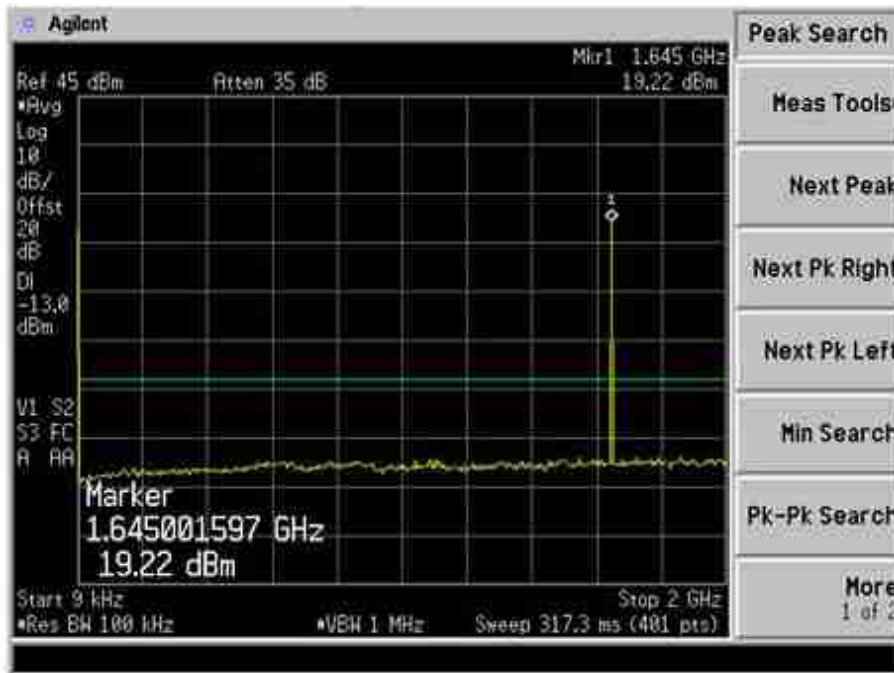

Plot 51 – Middle Channel



Plot 52 – Middle Channel



UNWANTED EMISSIONS AT ANTENNA TERMINAL TEST

Out of Band Spurious Plots (Bearer Type: 0)

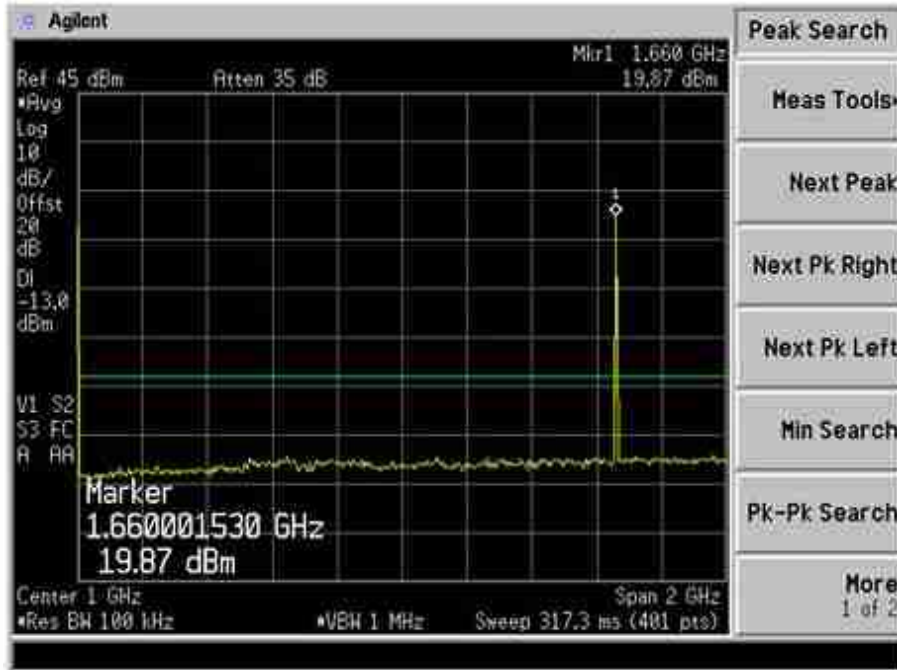

Plot 53 – Upper Channel

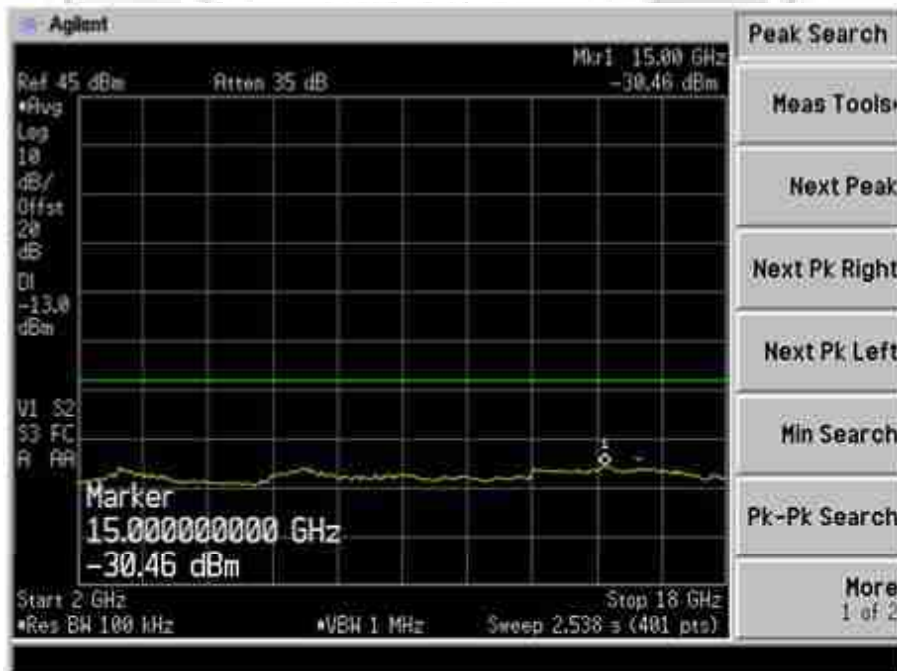

Plot 54 – Upper Channel

UNWANTED EMISSIONS AT ANTENNA TERMINAL TEST

Out of Band Spurious Plots (Bearer Type: 3)

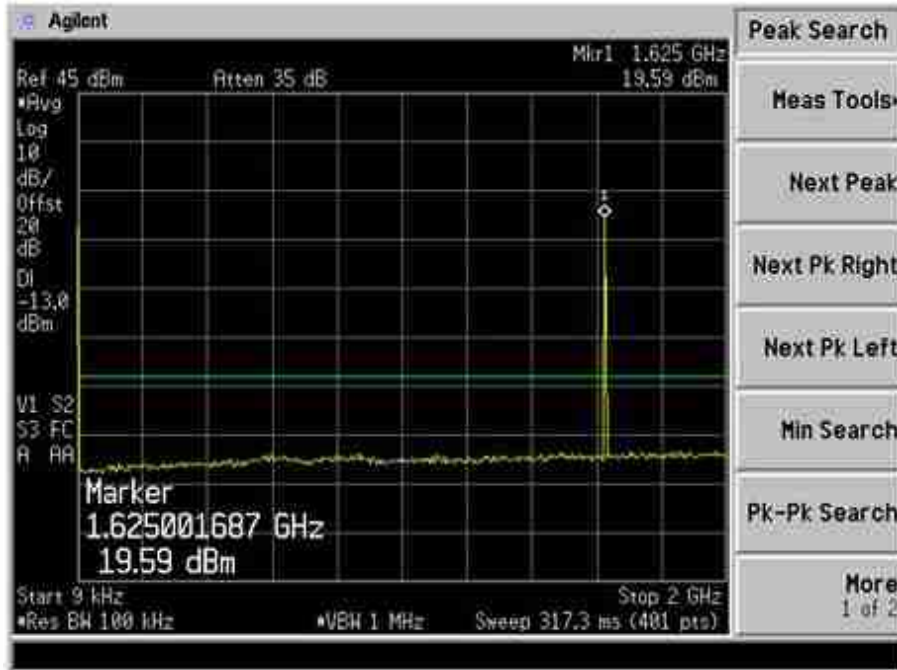

Plot 55 – Lower Channel

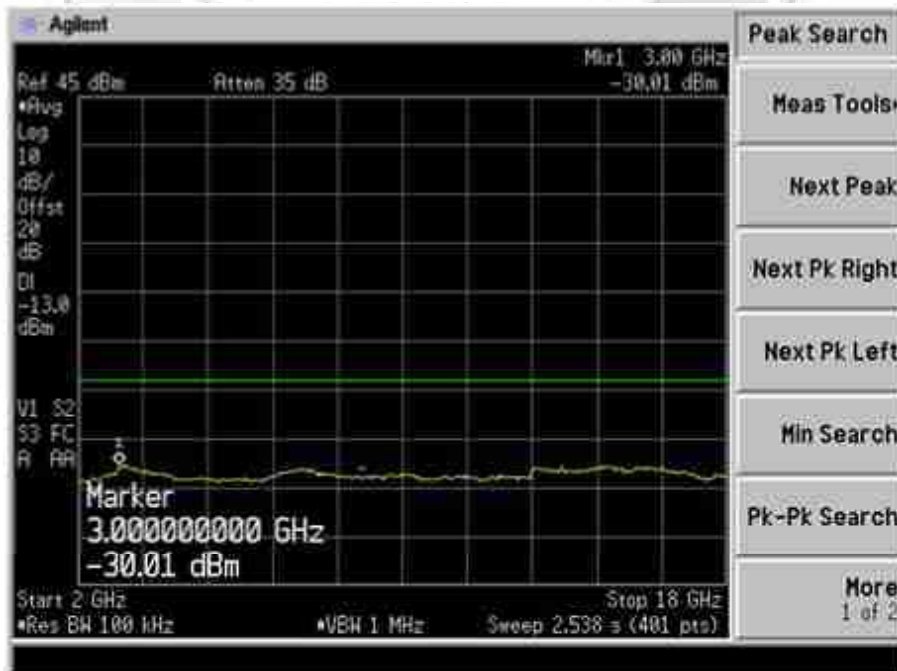

Plot 56 – Lower Channel



UNWANTED EMISSIONS AT ANTENNA TERMINAL TEST

Out of Band Spurious Plots (Bearer Type: 3)

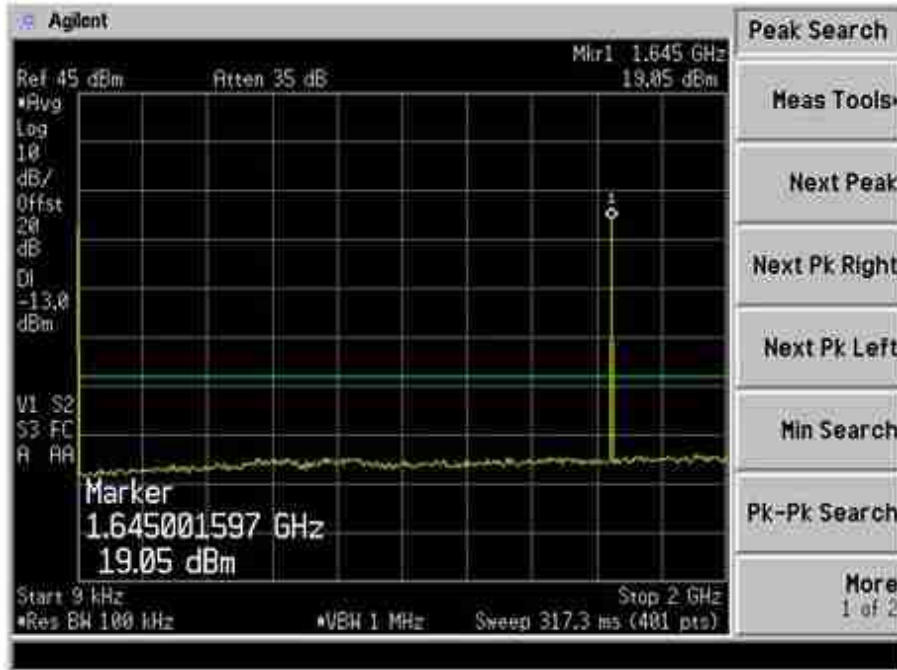

Plot 57 – Middle Channel

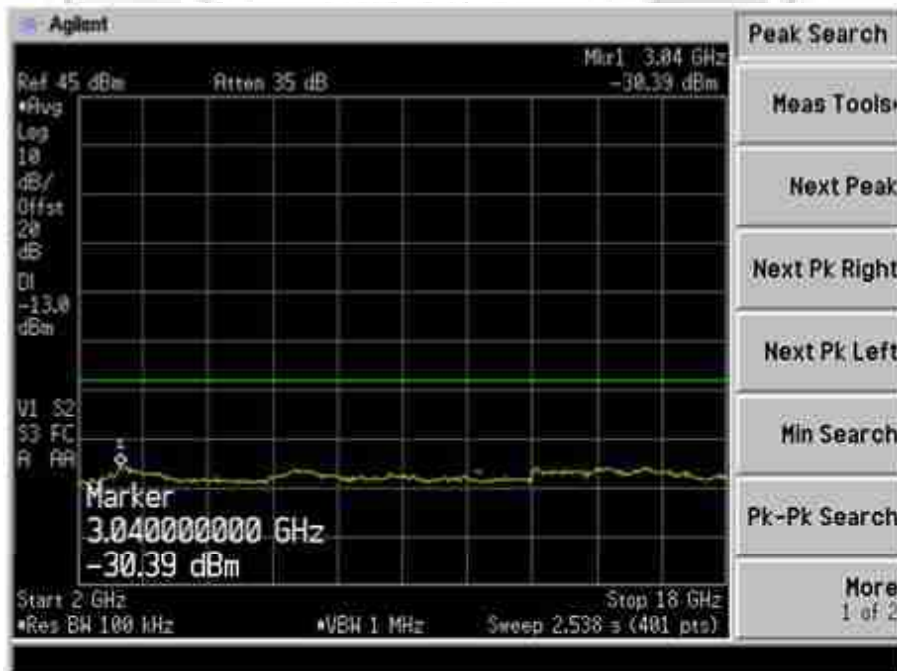

Plot 58 – Middle Channel

UNWANTED EMISSIONS AT ANTENNA TERMINAL TEST

Out of Band Spurious Plots (Bearer Type: 3)

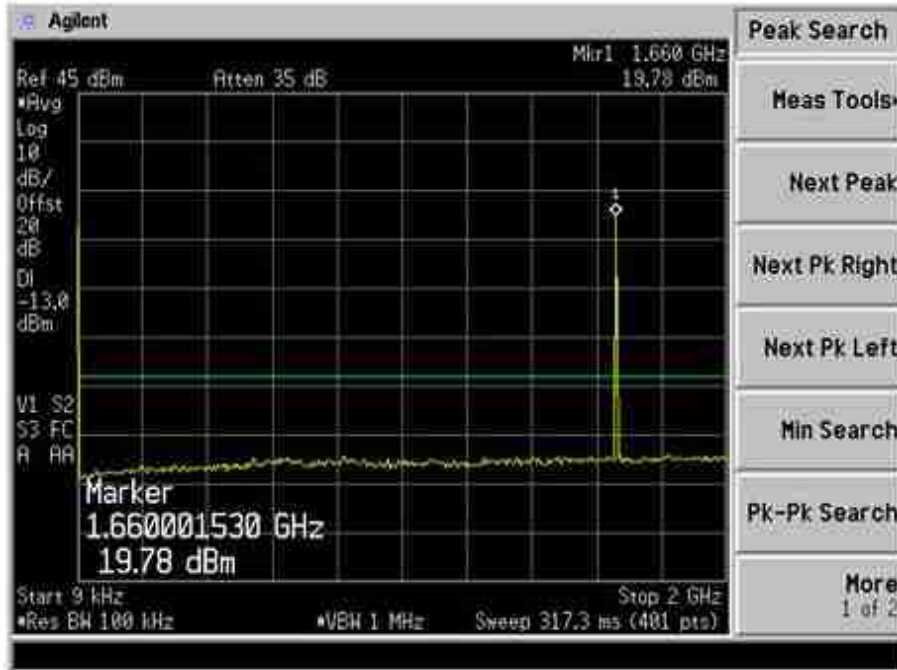

Plot 59 – Upper Channel

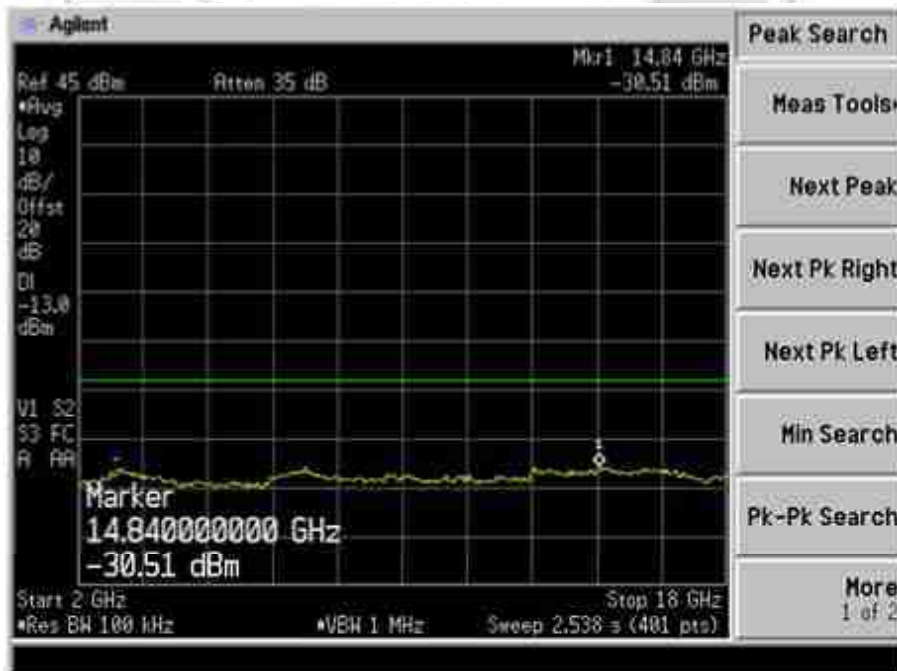

Plot 60 – Upper Channel



UNWANTED EMISSIONS AT ANTENNA TERMINAL TEST

Out of Band Spurious Plots (Bearer Type: 5)

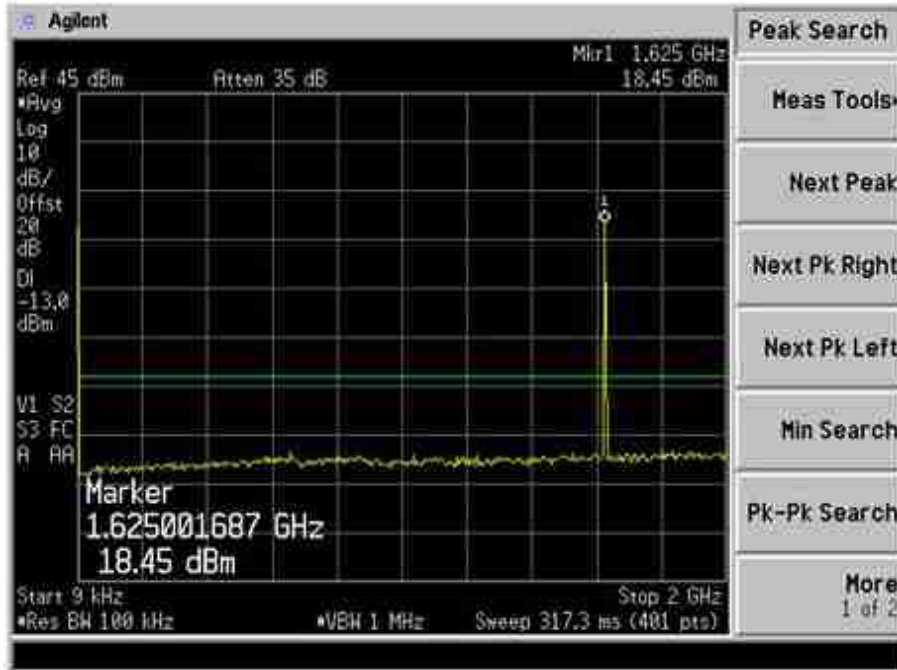

Plot 61 – Lower Channel

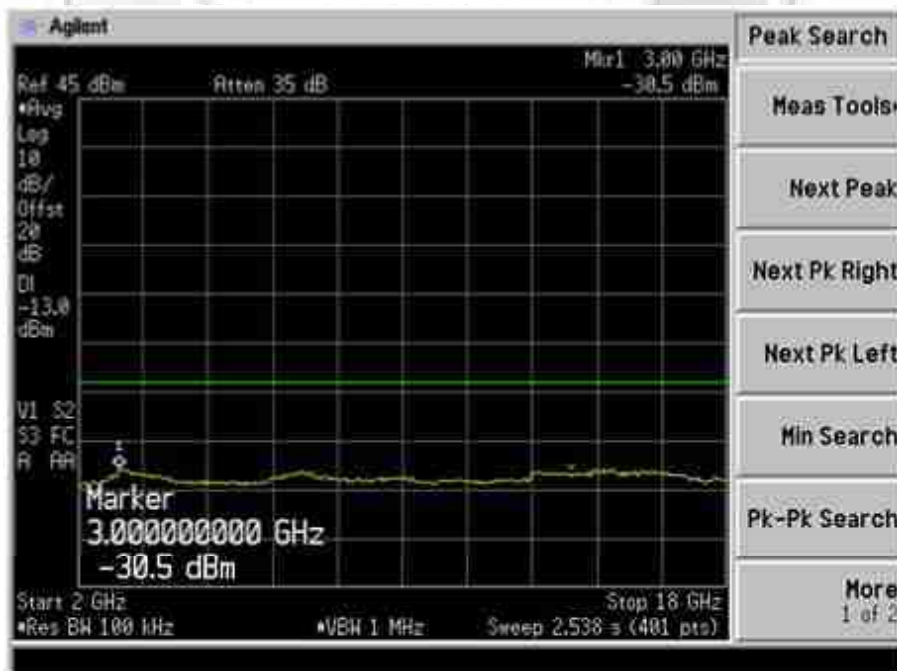

Plot 62 – Lower Channel



UNWANTED EMISSIONS AT ANTENNA TERMINAL TEST

Out of Band Spurious Plots (Bearer Type: 5)

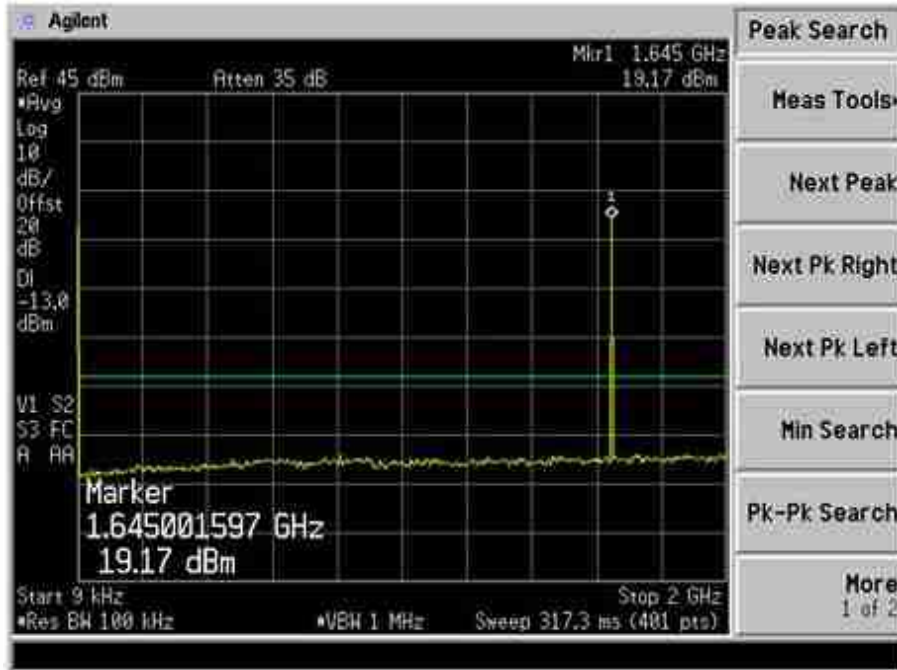

Plot 63 – Middle Channel

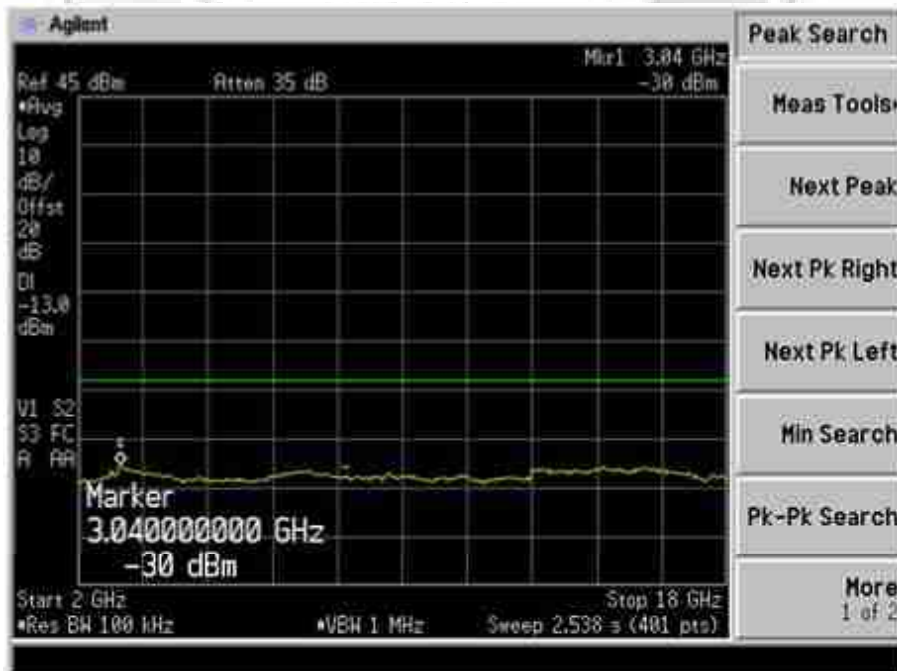

Plot 64 – Middle Channel

UNWANTED EMISSIONS AT ANTENNA TERMINAL TEST

Out of Band Spurious Plots (Bearer Type: 5)

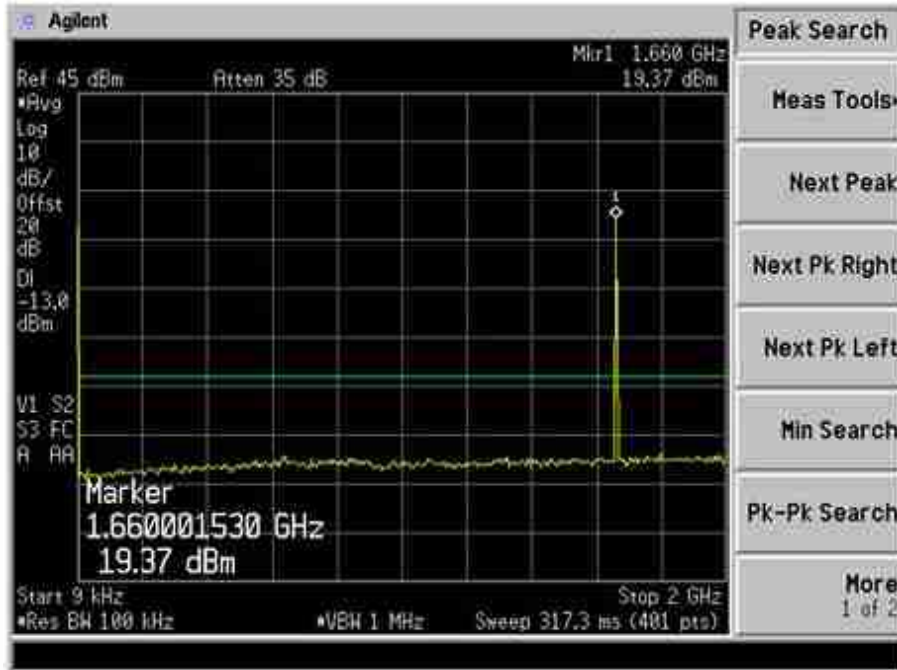

Plot 65 – Upper Channel



Plot 66 – Upper Channel





UNWANTED EMISSIONS AT ANTENNA TERMINAL TEST

Out of Band Spurious Plots (Bearer Type: 7)

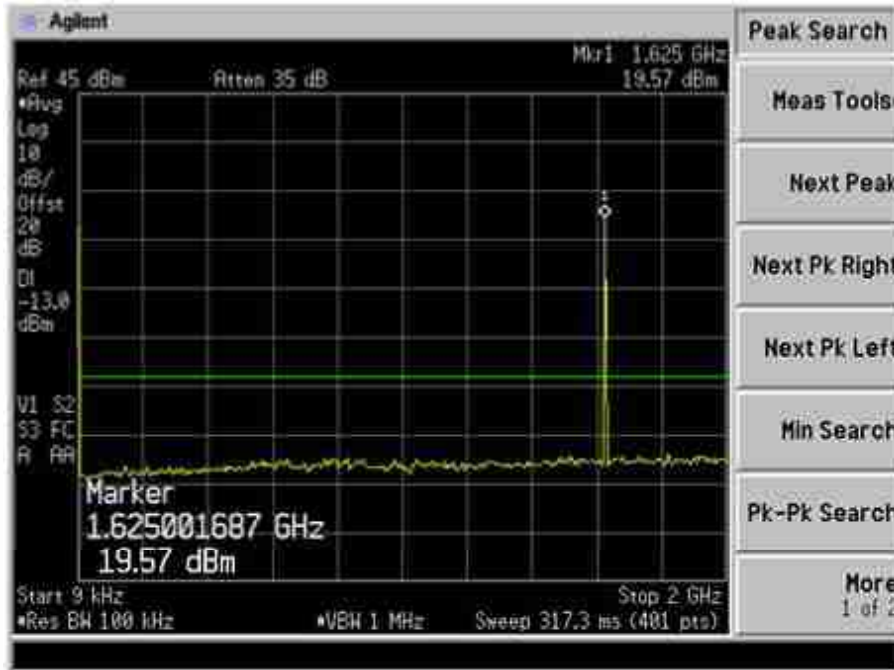

Plot 67 – Lower Channel

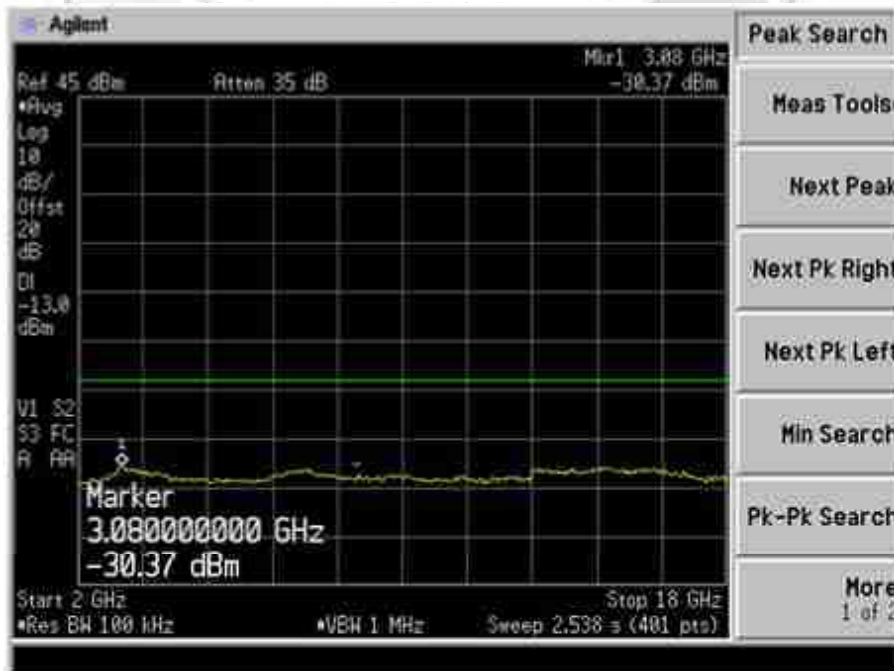

Plot 68 – Lower Channel

UNWANTED EMISSIONS AT ANTENNA TERMINAL TEST

Out of Band Spurious Plots (Bearer Type: 7)

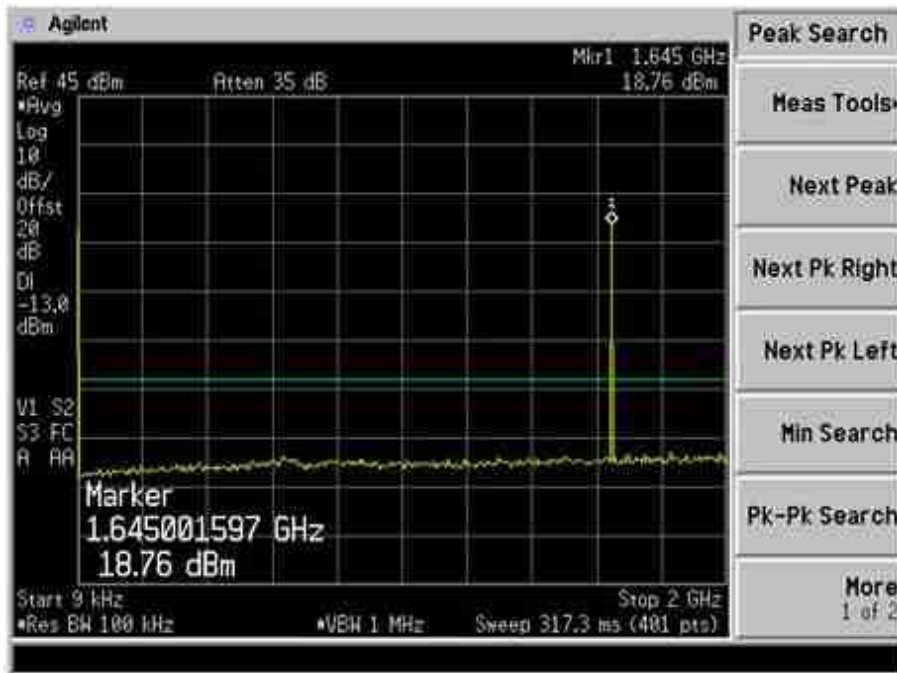

Plot 69 – Middle Channel

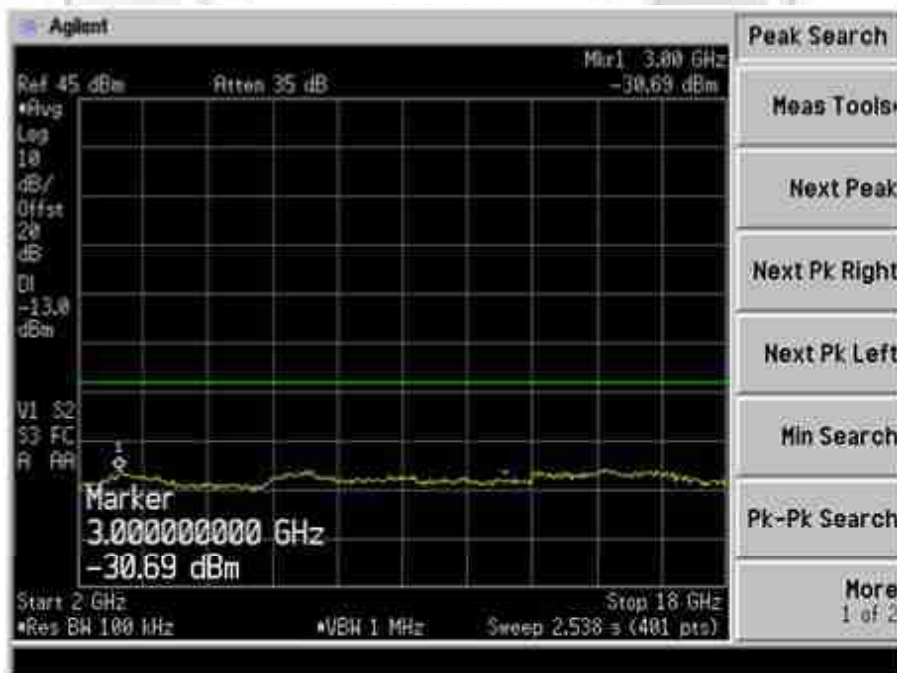

Plot 70 – Middle Channel

UNWANTED EMISSIONS AT ANTENNA TERMINAL TEST

Out of Band Spurious Plots (Bearer Type: 7)

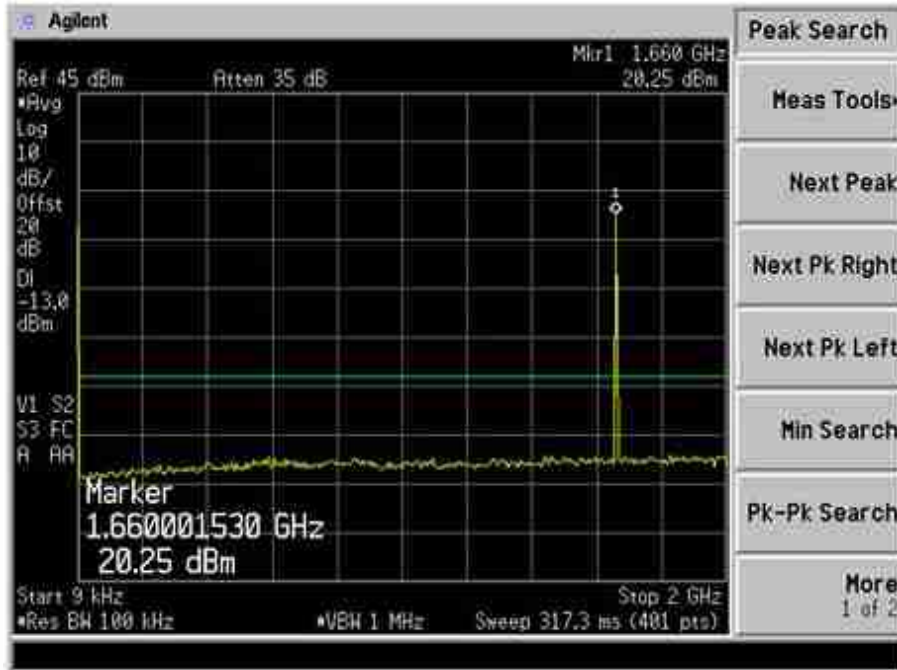

Plot 71 – Upper Channel

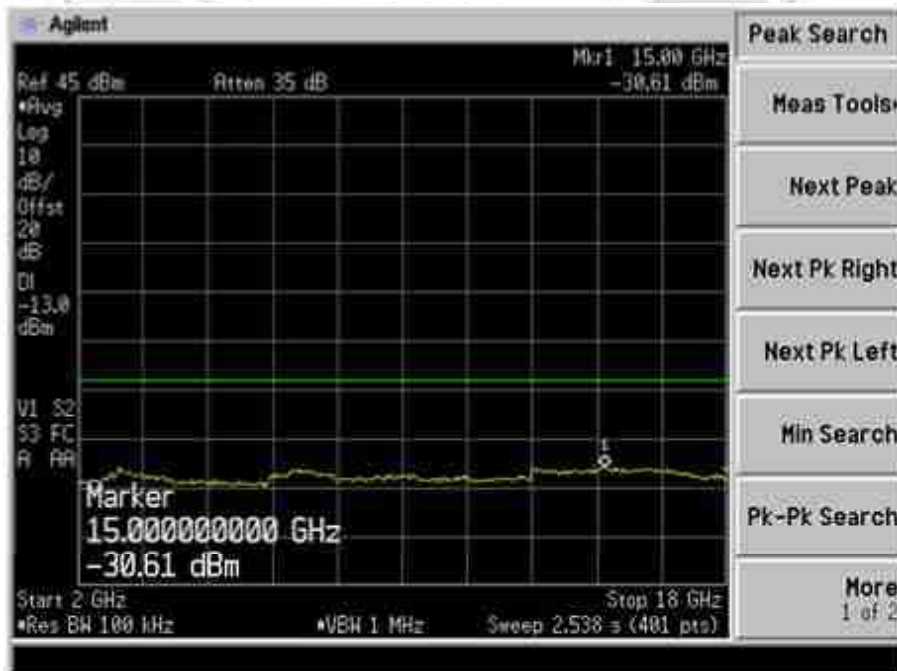

Plot 72 – Upper Channel



UNWANTED EMISSIONS AT ANTENNA TERMINAL TEST

Out of Band Spurious Plots (Bearer Type: 11)

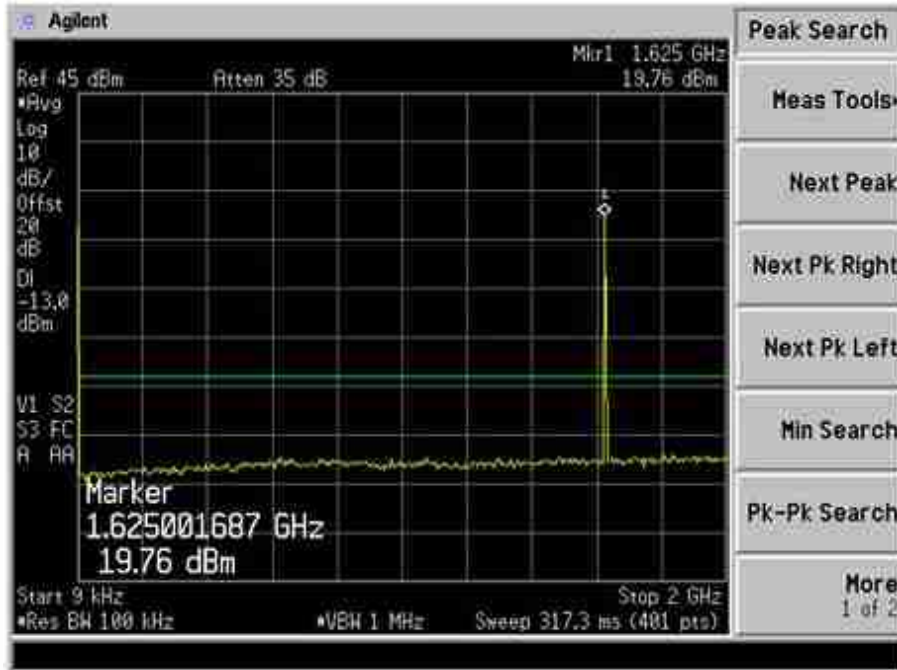

Plot 73 – Lower Channel

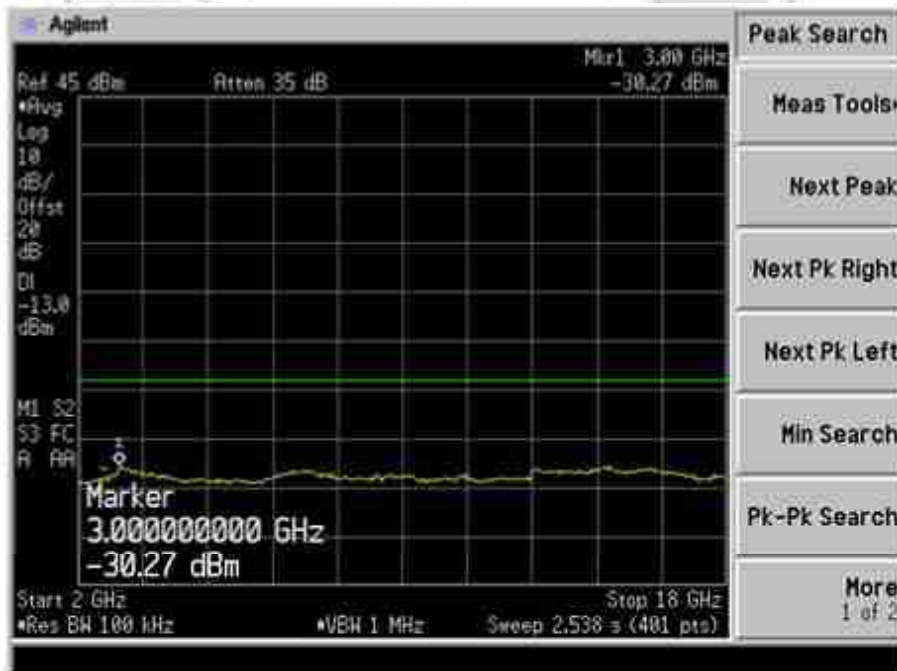

Plot 74 – Lower Channel

UNWANTED EMISSIONS AT ANTENNA TERMINAL TEST

Out of Band Spurious Plots (Bearer Type: 11)

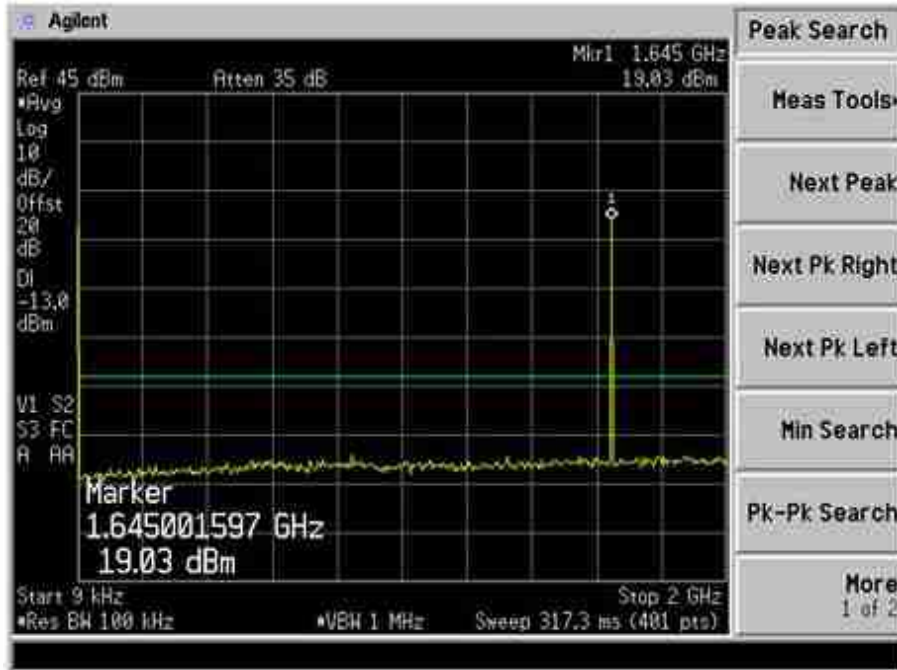

Plot 75 – Middle Channel

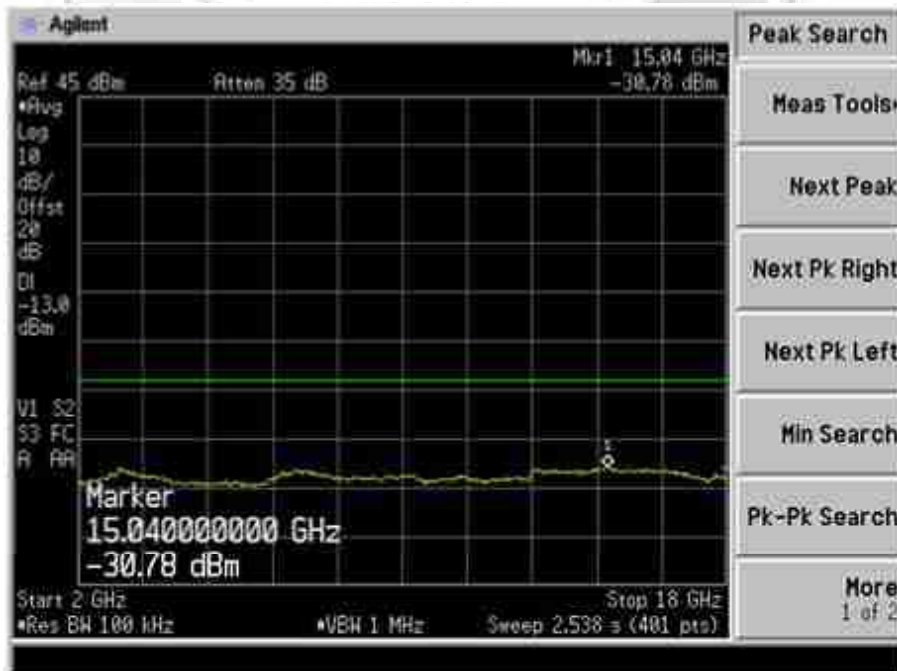

Plot 76 – Middle Channel



UNWANTED EMISSIONS AT ANTENNA TERMINAL TEST

Out of Band Spurious Plots (Bearer Type: 11)

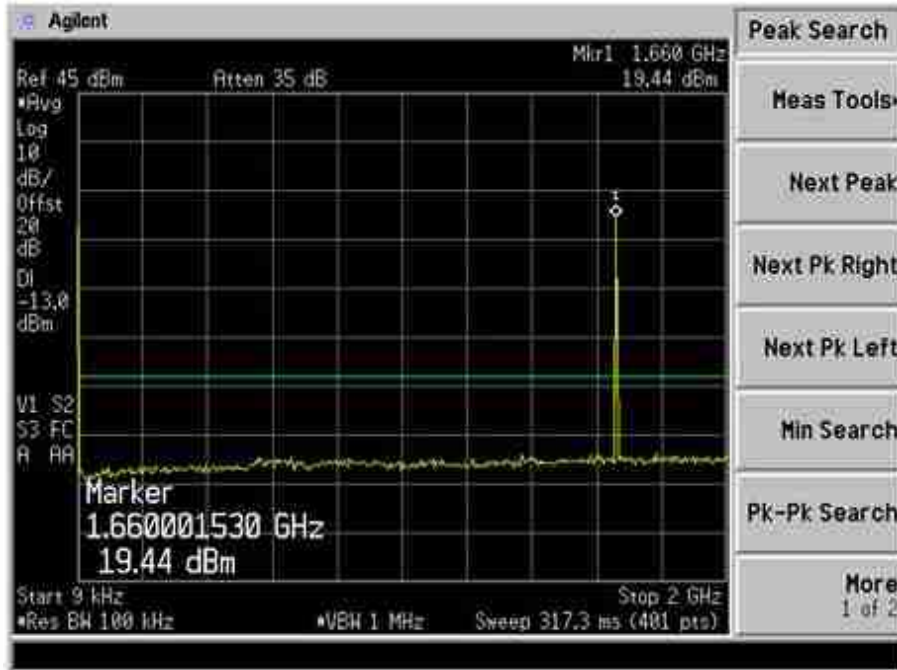

Plot 77 – Upper Channel

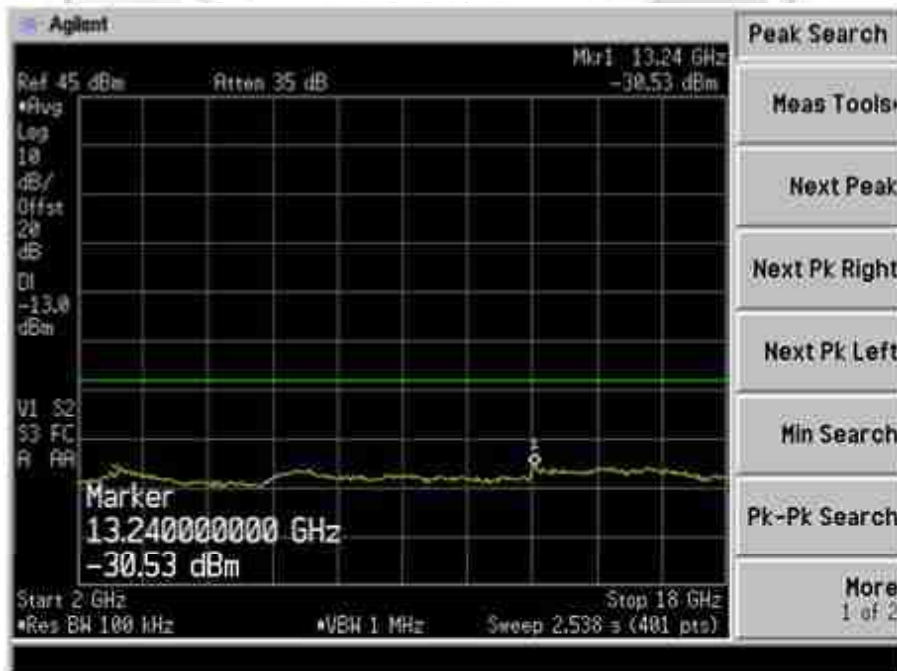

Plot 78 – Upper Channel

UNWANTED EMISSIONS AT ANTENNA TERMINAL TEST

Out of Band Spurious Plots (Bearer Type: 13)

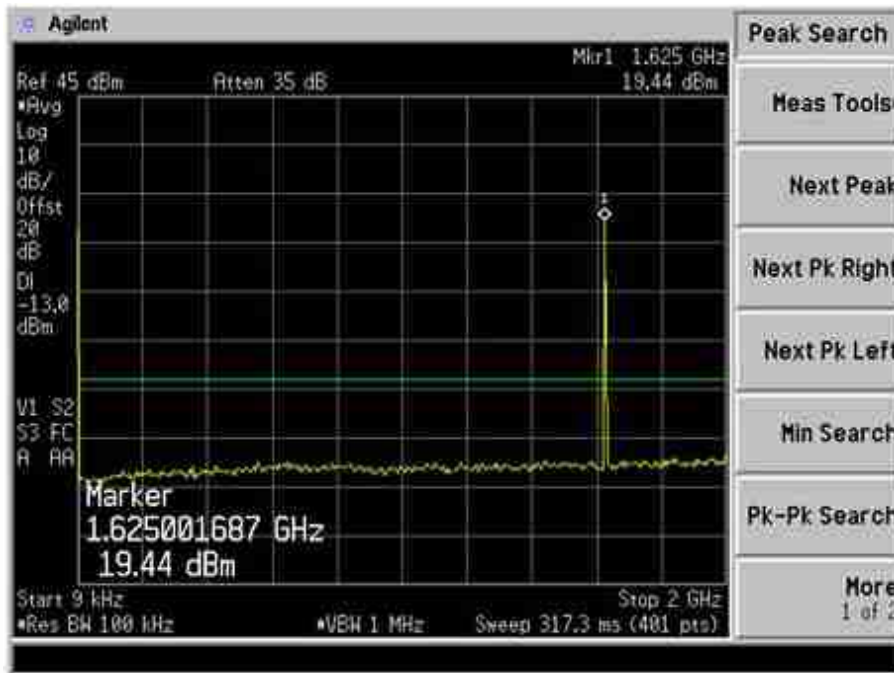

Plot 79 – Lower Channel

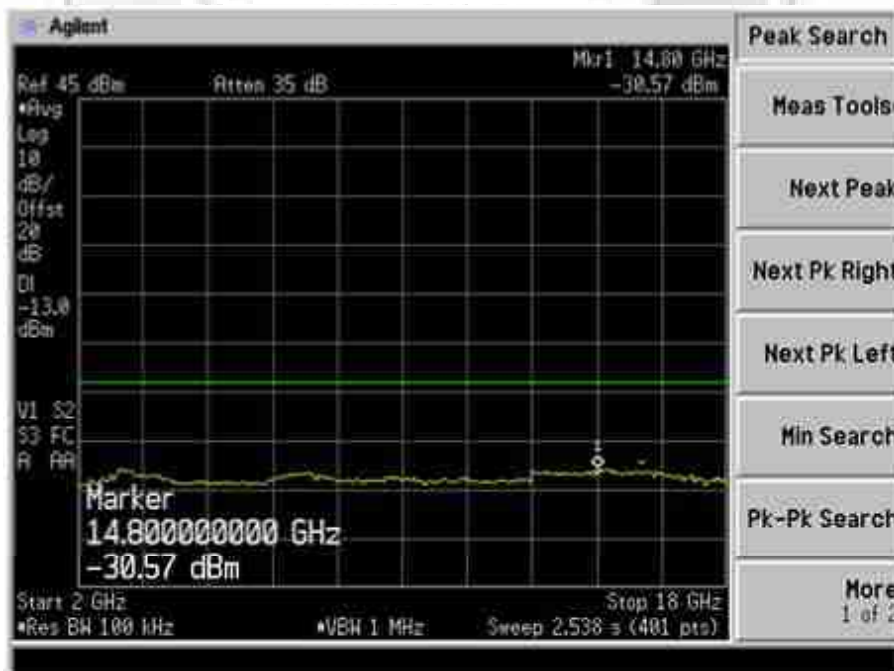

Plot 80 – Lower Channel



UNWANTED EMISSIONS AT ANTENNA TERMINAL TEST

Out of Band Spurious Plots (Bearer Type: 13)

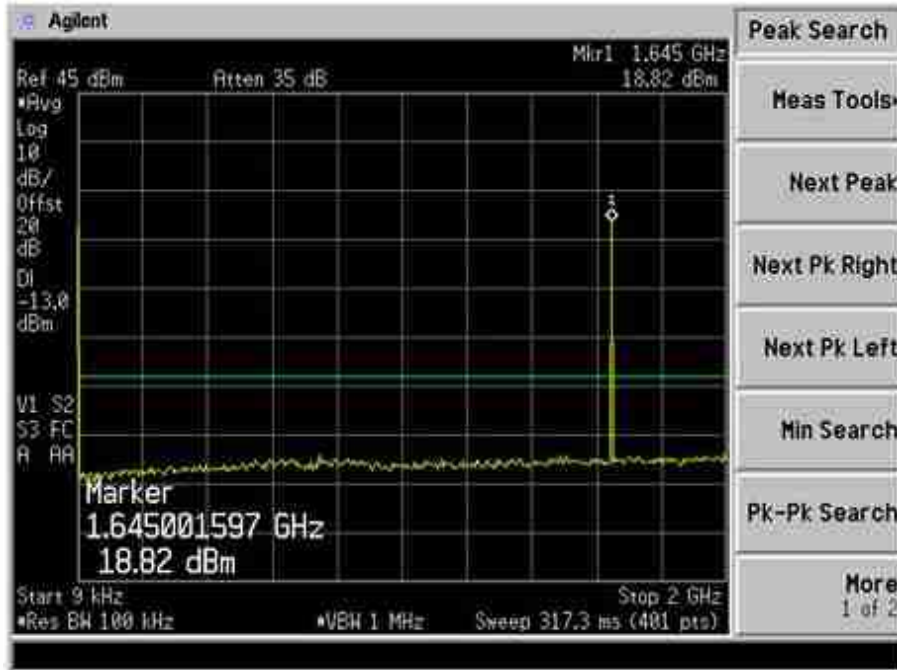

Plot 81 – Middle Channel

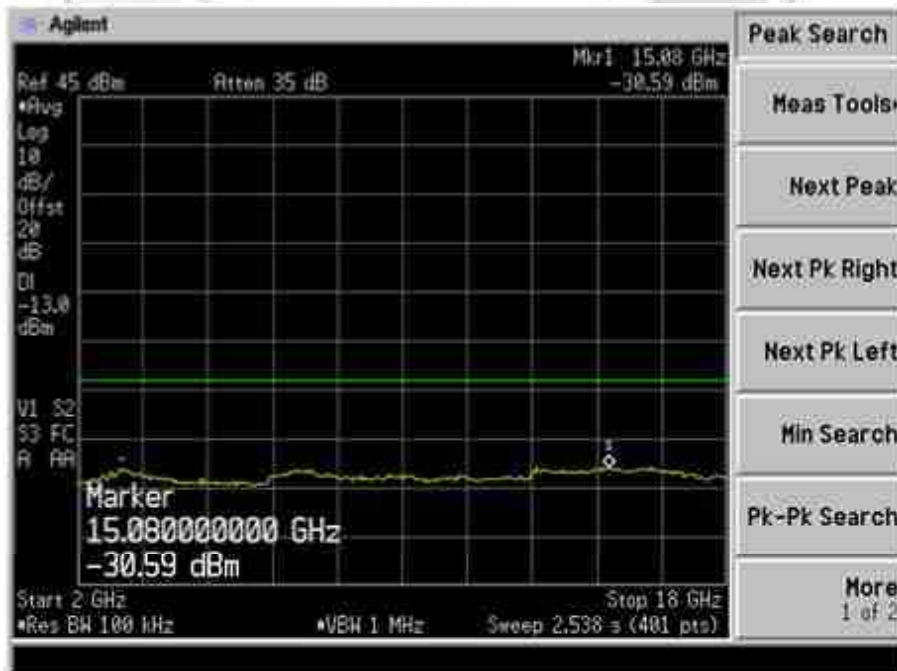

Plot 82 – Middle Channel



UNWANTED EMISSIONS AT ANTENNA TERMINAL TEST

Out of Band Spurious Plots (Bearer Type: 13)

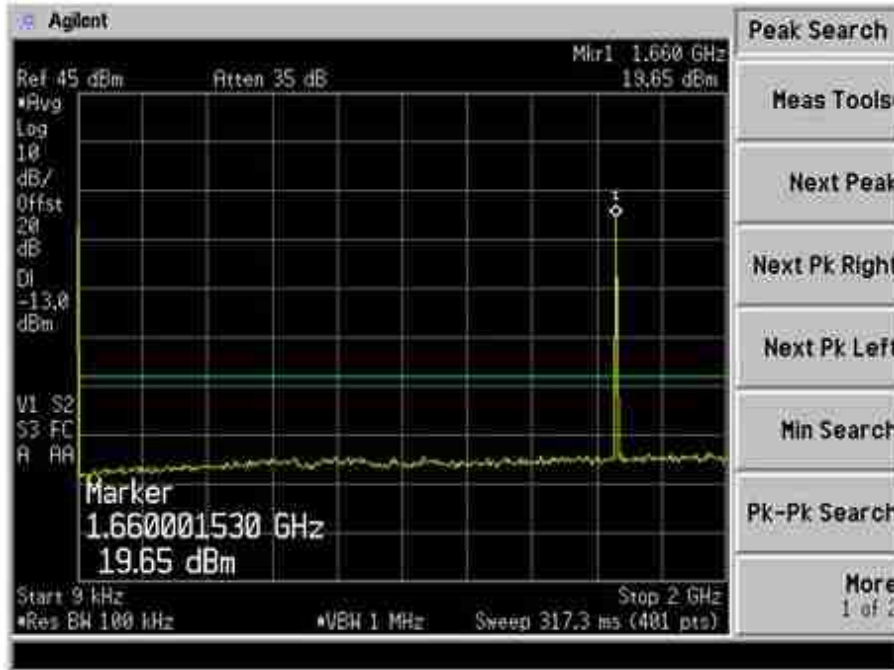

Plot 83 – Upper Channel

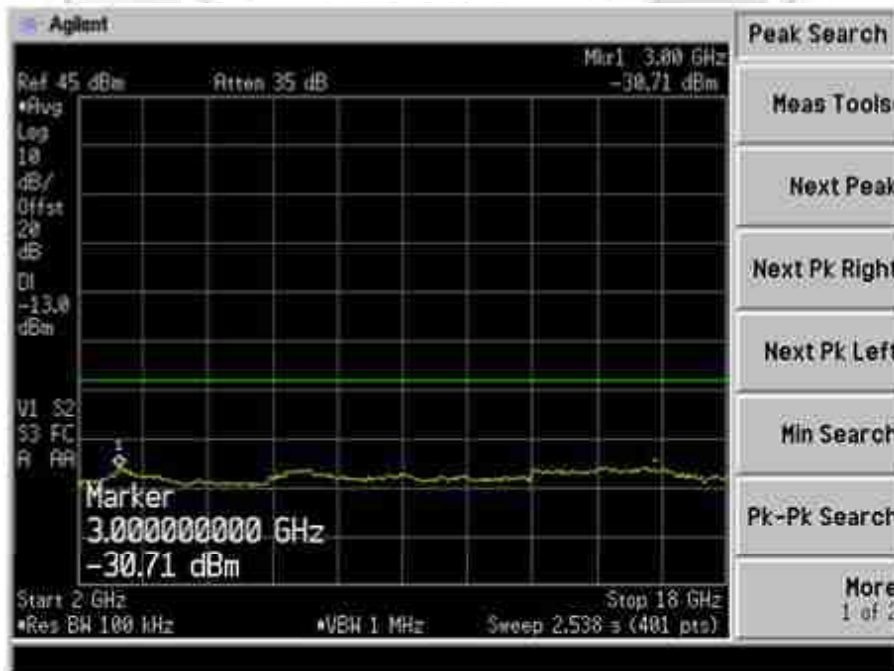

Plot 84 – Upper Channel

UNWANTED EMISSIONS AT ANTENNA TERMINAL TEST

Out of Band Spurious Plots (Bearer Type: 15)

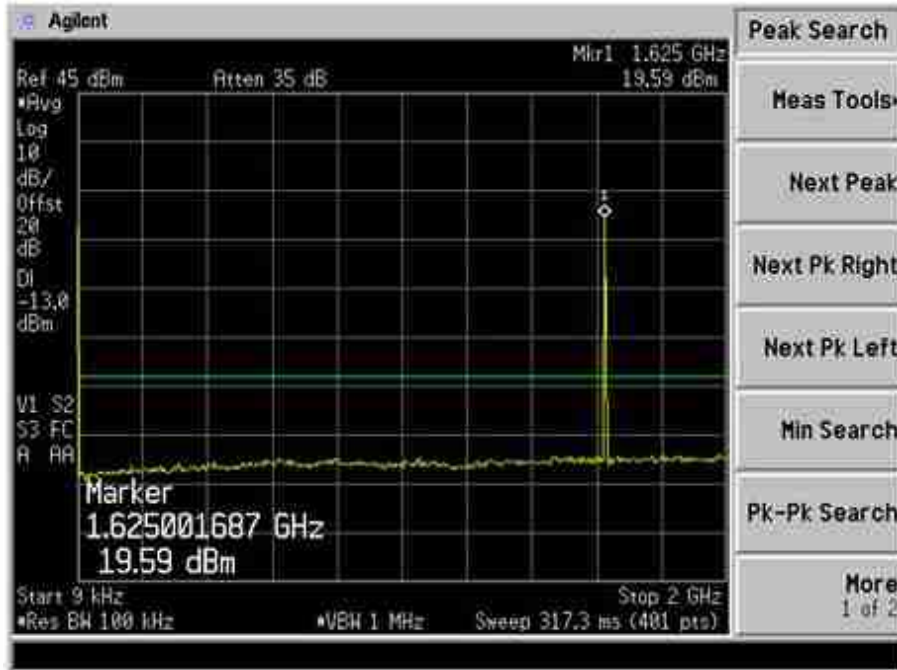

Plot 85 – Lower Channel

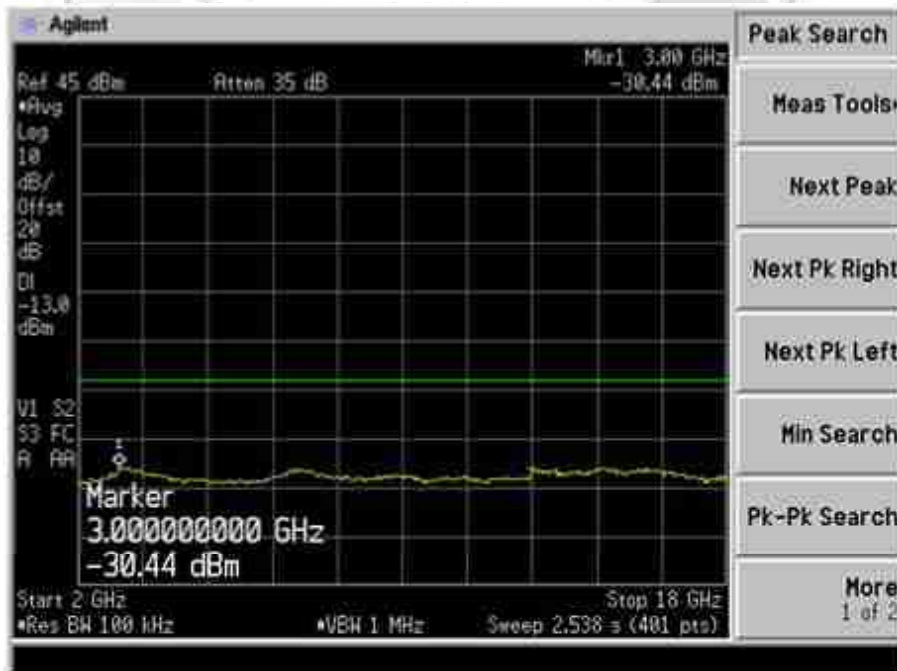

Plot 86 – Lower Channel

UNWANTED EMISSIONS AT ANTENNA TERMINAL TEST

Out of Band Spurious Plots (Bearer Type: 15)

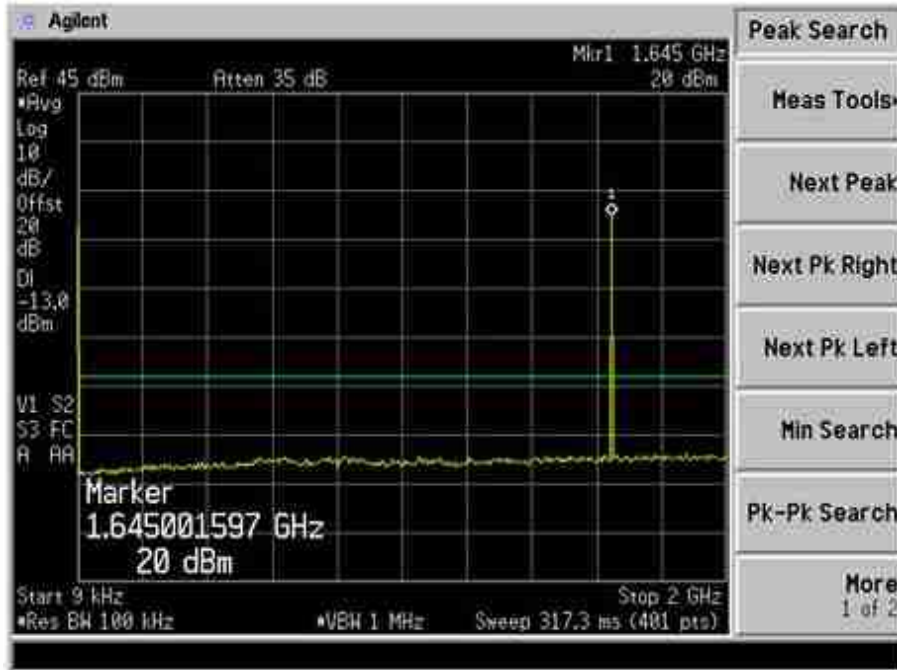

Plot 87 – Middle Channel

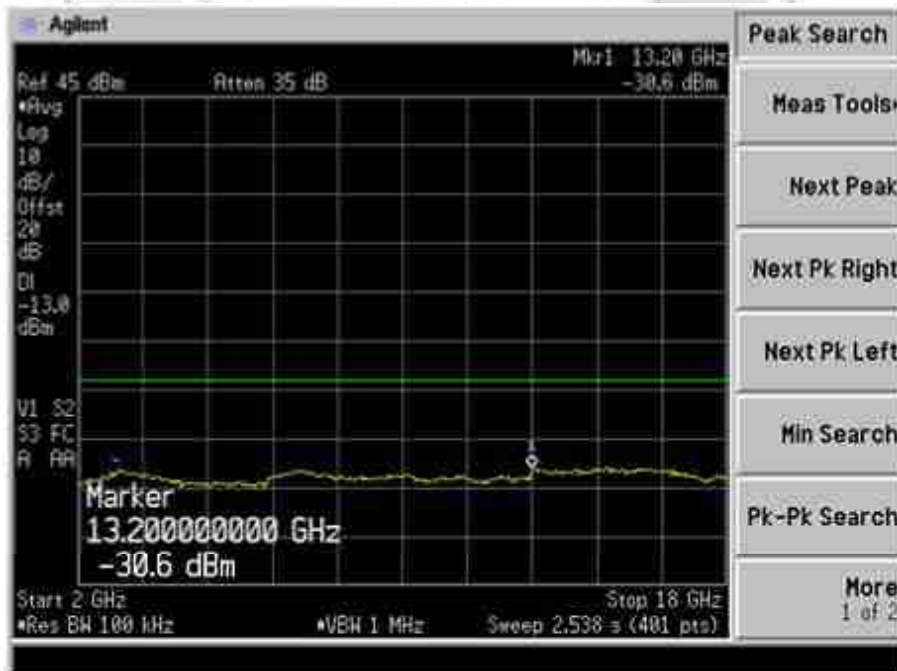

Plot 88 – Middle Channel

UNWANTED EMISSIONS AT ANTENNA TERMINAL TEST

Out of Band Spurious Plots (Bearer Type: 15)

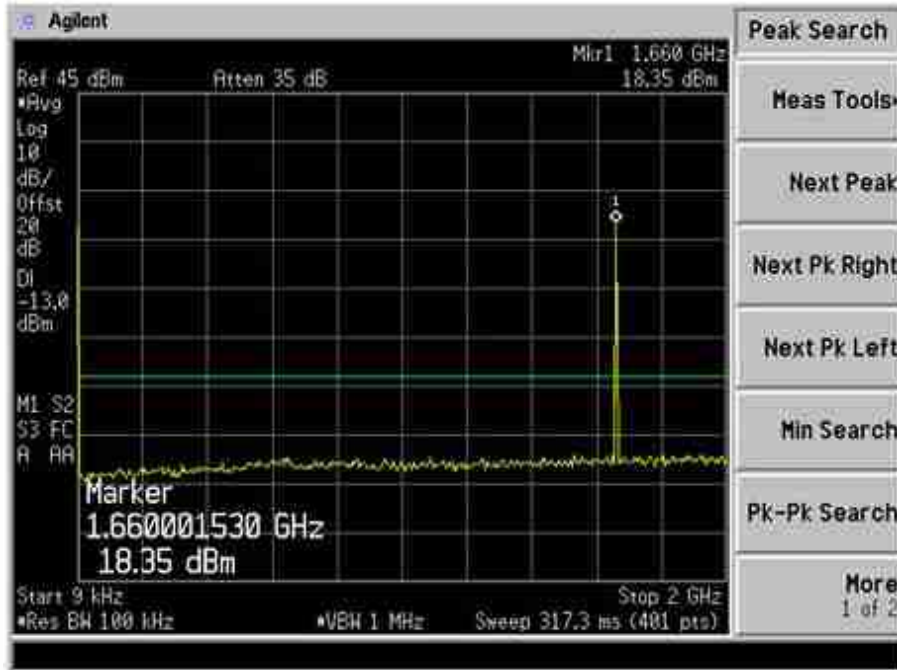

Plot 89 – Upper Channel

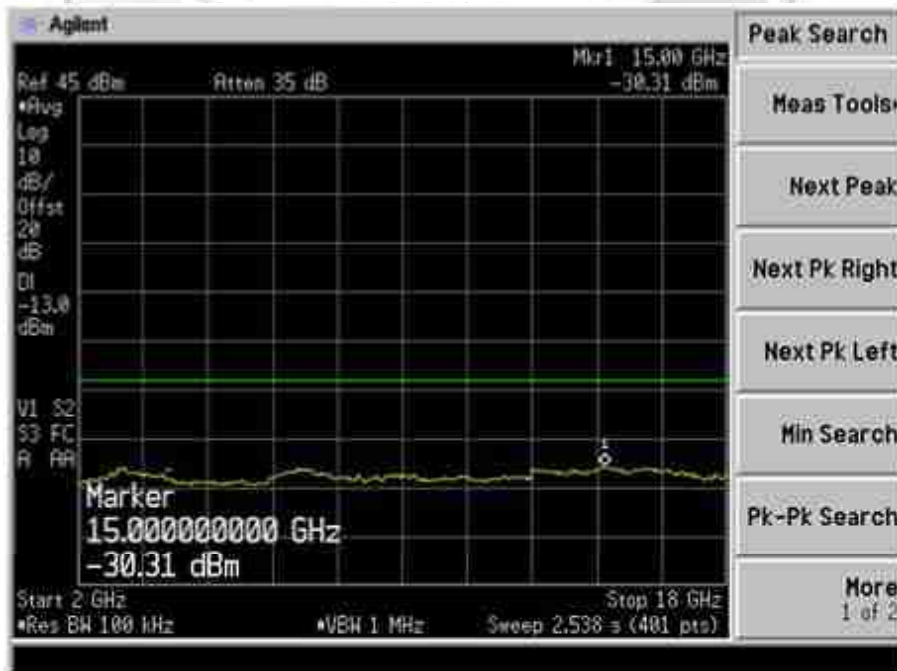

Plot 90 – Upper Channel



**RADIATED SPURIOUS EMISSION TEST**

**47 CFR FCC Parts 2.1053 and 25.202(f) Radiated Spurious Emission Limits**

1. 25.202 Emissions Limitations
  - (f) The mean power of the emissions shall be attenuated below the mean output power of the transmitter in accordance with the following schedule:
    - (1) In any 4kHz band, the center frequency of which is removed from the assigned frequency by more than 50% up to and including 100% of the authorized bandwidth: 25 decibels;
    - (2) In any 4kHz band, the center frequency of which is removed from the assigned frequency by more than 100% up to and including 250% of the authorized bandwidth: 35 decibels;
    - (3) In any 4kHz band, the center frequency of which is removed from the assigned frequency by more than 250% of the authorized bandwidth: an amount equal to 43 decibels plus 10 times logarithm (to the base 10) of the transmitter power in watts.
  
2. 2.1053 Measurements Required: Field Strength of Spurious Emissions
  - (a) Measurement shall be made to detect spurious emissions that may be radiated directly from the cabinet, control circuits, power leads, or intermediate circuit elements under normal conditions of installation and operation. Curves or equivalent data shall be supplied showing the magnitude of each harmonic and other spurious emission. For this test, single sideband, independent sideband, and controlled carrier transmitters shall be modulated under the conditions specified in paragraph (c) of 2.1049, as appropriate. For equipment operating on frequencies below 890MHz, an open field test is normally required, with the measuring instrument antenna located in the far-field at all test frequencies. Information submitted shall include the relative radiated power of each spurious emission with reference to the rated power output of the transmitter, assuming all emissions are radiated from half-wave dipole antennas.
  - (b) The measurements specified in paragraph (a) of this section shall be made for the following equipment:
    - (1) Those in which the spurious emission are required to be 60dB or more below the mean power of the transmitter.
    - (2) All equipment operating on frequencies higher than 25MHz.
    - (3) All equipment where the antenna is an integral part of, and attached directly to the transmitter.
    - (4) Other types of equipment as required, when deemed necessary by the Commission.

**47 CFR FCC Parts 2.1053 and 25.202(f) Radiated Spurious Emission Test Instrumentation**

Instrument	Model	S/No	Cal Due Date
R&S Test Receiver – ESI1	ESI40	100010	05 Jun 2014
Schaffner Bilog Antenna –(30MHz-2GHz) BL3 (Ref)	CBL6112B	2549	07 Jan 2014
Agilent Preamplifier(1GHz-26.5GHz) (PA18)	8449D	3008A02305	05 Oct 2013
Teseq Preamplifier (9kHz-1GHz)	LNA6901	72267	22 Jun 2013
EMCO Horn Antenna(1GHz-18GHz) – H14 (Ref)	3115	0003-6087	12 Jul 2013
EMCO Horn Antenna – H15	3115	0003-6088	20 May 2014
Schaffner Bilog Antenna –(30MHz-2GHz) BL3 (Ref)	CBL6112B	2549	19 Jan 2014
Schaffner Bilog Antenna(30MHz-2GHz) – BL4	CBL6112B	2593	19 Oct 2013
HP Synthesized Sweeper – SG3	83620A	3250A01594	23 Aug 2013





## RADIATED SPURIOUS EMISSION TEST

### 47 CFR FCC Parts 2.1053 and 25.202(f) Radiated Spurious Emission Test Setup

1. The EUT and supporting equipment were set up in accordance with the requirements of the standard on top of a 1.5m X 1.0m X 0.8m high, non-metallic table.
2. The filtered power supply for the EUT and supporting equipment were tapped from the appropriate power sockets located on the turntable.
3. The relevant antenna was set at the required test distance away from the EUT and supporting equipment boundary

### 47 CFR FCC Parts 2.1053 and 25.202(f) Radiated Spurious Emission Test Method

1. The EUT was set to transmit at the maximum power at the lower channel with the modulation on at normal test condition.
2. The receiving antenna (test antenna) was set at vertical polarization with the height of 1m.
3. With the spectrum analyser was set to max hold enabled (peak detector mode), the spurious emissions were searched and recorded. For EUT which is a portable device, the spurious emission search was carried out by rotating the EUT through three orthogonal axes to determine which attitude and equipment arrangement produces worst emissions.
4. For each spurious emission found, the test antenna was raised or lowered through the specified range of heights (1m – 4m) until a maximum signal level was detected on the test receiver.
5. The EUT was then rotated through 360° in the horizontal plane until the maximum signal was received. The maximum received signal level was recorded as A (in dBm).
6. The EUT was replaced with the substitution antenna with the antenna input was connected to the signal generator via a 10dB attenuator (if required).
7. The signal generator was set to the found spurious frequency. The output level of the signal generator was adjusted until the test receiver was at least 20dB above the level when the signal generator was switched off.
8. The test antenna was raised and lowered through the specified range of heights (1m – 4m) until the maximum signal level was received on the test receiver.
9. The substitution antenna was rotated until the maximum level was detected on the test receiver.
10. The output level of the signal generator was adjusted until the received signal level at the test receiver was equal to the level recorded in step 5 (A dBm). The signal generator output level was recorded as B (in dBm).
11. The spurious emission level, P (e.i.r.p) was computed as followed:  
$$P \text{ (e.i.r.p)} = B - C - D + E$$

where

C	=	cable loss between the signal generator and the substitution
D	=	attenuation level if attenuator is used
E	=	substitution antenna gain
12. The steps 2 to 11 were repeated with the receiving antenna was set to horizontal polarization.
13. Comparison was made on both measured results with vertical and horizontal polarizations. The highest value out of vertical and horizontal polarizations was recorded.
14. The steps 2 to 13 were repeated until all the spurious emissions (up to 10<sup>th</sup> harmonics of the carrier frequency) were measured.
15. The steps 1 to 14 were repeated with the EUT was set to operate at the middle and upper channels respectively.

**RADIATED SPURIOUS EMISSION TEST**

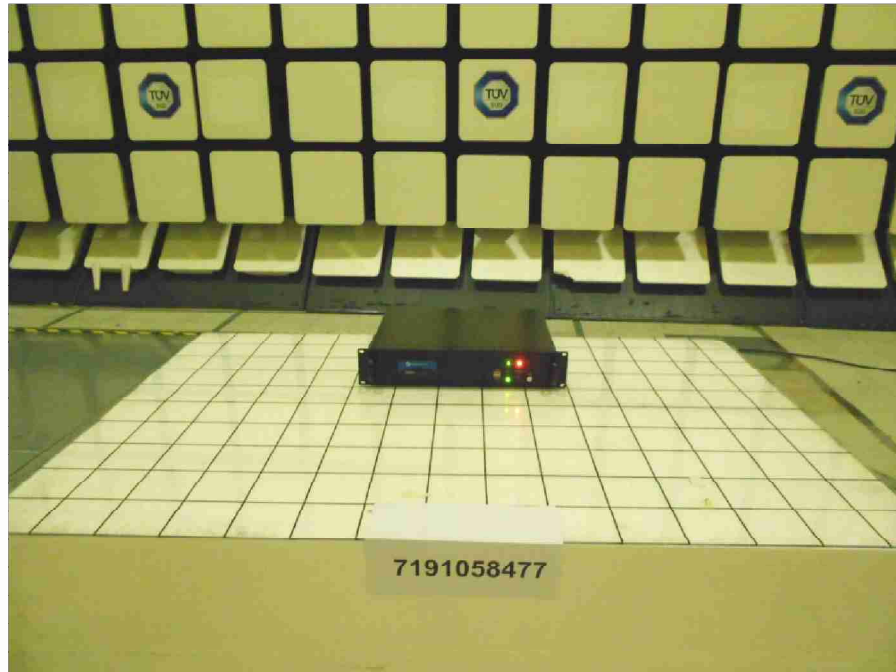

**Radiated Spurious Emissions Test Setup (Front View)**

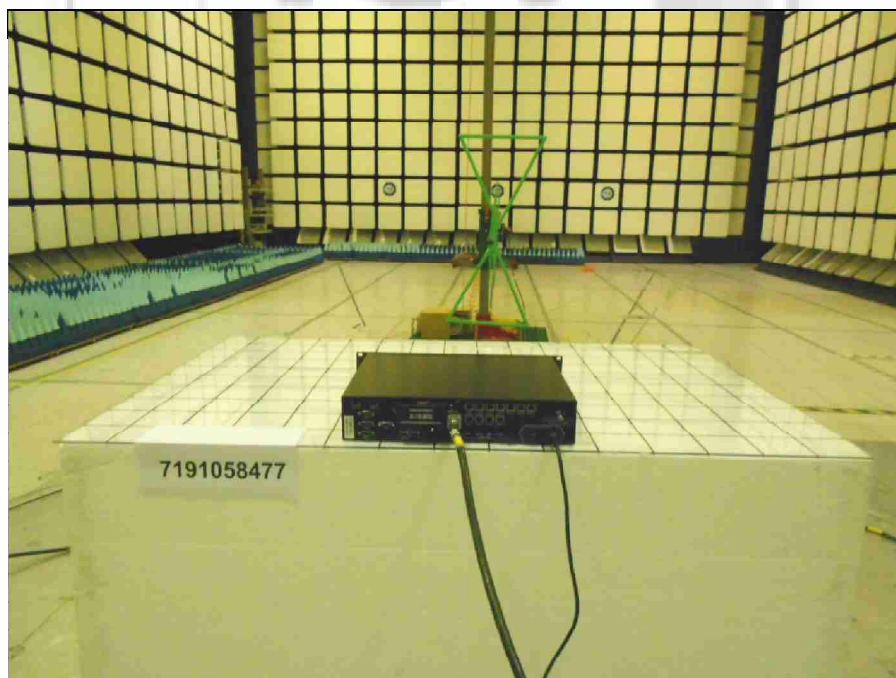

**Radiated Spurious Emissions Test Setup (Rear View)**



**RADIATED SPURIOUS EMISSIONS TEST**

**47 CFR FCC Parts 2.1053 and 25.202(f) Radiated Spurious Emission Results**

Operating Mode	Continuous Satellite Transmission	Temperature	24°C
Test Input Power	110V 60Hz	Relative Humidity	60%
Test Distance	3m	Atmospheric Pressure	1030mbar
Type Bearer	15 (Worst Bearer)	Tested By	Kyaw Soe Hein

**Lower Channel 30MHz – 1000MHz**

Frequency (MHz)	Amplitude (dBm)	Limit (dBm)
58.3020	-42.4	-13.0
84.4280	-43.6	-13.0
161.7150	-46.7	-13.0
329.3530	-55.8	-13.0
736.4730	-64.1	-13.0
829.0000	-66.6	-13.0

**Middle Channel 30MHz – 1000MHz**

Frequency (MHz)	Amplitude (dBm)	Limit (dBm)
59.3910	-44.7	-13.0
83.3390	-43.5	-13.0
161.7150	-48.0	-13.0
277.1020	-50.3	-13.0
328.2640	-55.9	-13.0
830.0880	-68.1	-13.0

**Upper Channel 30MHz – 1000MHz**

Frequency (MHz)	Amplitude (dBm)	Limit (dBm)
59.3910	-44.4	-13.0
84.4280	-44.0	-13.0
160.6270	-47.6	-13.0
277.1020	-52.3	-13.0
329.3530	-56.2	-13.0
921.5270	-66.3	-13.0



**RADIATED SPURIOUS EMISSIONS TEST**

**47 CFR FCC Parts 2.1053 and 25.202(f) Radiated Spurious Emission Results**

Operating Mode	Continuous Satellite transmission.	Temperature	24°C
Test Input Power	110V 60Hz	Relative Humidity	60%
Test Distance	3m	Atmospheric Pressure	1030mbar
Type Bearer	15 (Worst Bearer)	Tested By	Kyaw Soe Hein

**Lower Channel 1000MHz – 17000MHz**

Frequency (MHz)	Amplitude (dBm)	Limit (dBm)
1016.8330	-68.3	-13.0
1056.1110	-66.9	-13.0
1875.3330	-72.7	-13.0
2301.7780	-61.6	-13.0
2492.5560	-61.6	-13.0
4832.3890	-69.1	-13.0

**Middle Channel 1000MHz – 17000MHz**

Frequency (MHz)	Amplitude (dBm)	Limit (dBm)
1016.8330	-64.0	-13.0
1819.2220	-62.0	-13.0
1869.7220	-61.9	-13.0
2492.5560	-63.7	-13.0
2576.7220	-63.9	-13.0
4220.7780	-70.2	-13.0

**Upper Channel 1000MHz – 17000MHz**

Frequency (MHz)	Amplitude (dBm)	Limit (dBm)
1016.8330	-68.5	-13.0
1819.2220	-75.5	-13.0
1852.8890	-72.1	-13.0
1880.9450	-73.4	-13.0
1931.4450	-74.8	-13.0
2486.9450	-65.4	-13.0



**RADIATED SPURIOUS EMISSIONS TEST**

Notes

1. All possible modes of operation were investigated. Only the worst case emissions measured. All other emissions were relatively insignificant.
2. A "positive" margin indicates a PASS as it refers to the margin present below the limit line at the particular frequency. Conversely, a "negative" margin indicates a FAIL.
3. The Resolution Bandwidth (RBW) was corrected from 4kHz by  $10\log_{10} [(used\ RBW) / 4kHz]$ .
4. EMI receiver Resolution Bandwidth (RBW) and Video Bandwidth (VBW) settings:  
30MHz - 20GHz  
RBW: 100kHz      VBW: 300kHz
5. Emission limits are computed based on following:
  - a. Emissions Limits (dBm) (50% - = P - 25 + CF  
100% authorised bandwidth)
  - b. Emissions Limits (dBm) (100% - = P - 35 + CF  
250% authorised bandwidth)
  - c. Emissions Limits (dBm) (> 250% = P - [43 + 10 log<sub>10</sub> P<sub>w</sub>] + 30 + CF  
authorised bandwidth)where  
P = Measured mean power in dBm  
P<sub>w</sub> = Measured mean power in W  
CF = RBW correction factor (see Note 4)
6. Radiated Spurious Emissions Measurement Uncertainty  
All test measurements carried out are traceable to national standards. The uncertainty of the measurement at a confidence level of approximately 95%, with a coverage factor of 2, in the range 30MHz – 25GHz is ±4.0dB.



**PROTECTION OF AERONAUTICAL RADIO NAVIGATION SATELLITE SERVICE TEST**

**47 CFR FCC Part 25.216(h)(i)(j) Protection of Aeronautical Radio Navigation Satellite Service Limits**

25.216(h)(i)(j) Limits on Emissions from Mobile Earth Stations for Protection of Aeronautical Radionavigation-Satellite Service

- (h) Mobile earth stations manufactured more than six months after Federal Register publication of the rule changes adopted in FC 03-283 (from November 6, 2003) with assigned uplink frequencies in the 1626.5MHz - 1660.5MHz band shall suppress the power density of emissions in the 1605MHz - 1610MHz band-segment to an extent determined by linear interoperation from -70dBW/MHz at 1605MHz to -46dBW/MHz at 1610MHz, averaged over any 2ms active transmission interval. The e.i.r.p of discrete emissions of less than 700Hz bandwidth from such stations shall not exceed a level determined by linear interoperation from -80dBW at 1605MHz to -56dBW at 1610MHz, averaged over any 2ms active transmission interval.
- (i) The e.i.r.p density of carrier-off state emissions from mobile earth stations manufactured more than six months after Federal Register publication of the rule changes adopted in FCC 03-283 with assigned uplink frequencies between 1GHz and 3GHz shall not exceed -80dBW/MHz in the 1559MHz - 1610MHz band averaged over any 2ms interval.
- (j) A Root-Mean-Square detector shall be used for all power density measurements.

**47 CFR FCC Part 25.216(h)(i)(j) Protection of Aeronautical Radio Navigation Satellite Service Test Instrumentation**

Instrument	Model	S/No	Cal Due Date
Agilent Spectrum Analyzer	E4440A	MY45304764	25 May 2014
EMCO Horn Antenna(1GHz-18GHz) – H14 (Ref)	3115	0003-6087	12 Jul 2013





**PROTECTION OF AERONAUTICAL RADIO NAVIGATION SATELLITE SERVICE TEST**

**47 CFR FCC Part 25.216(h)(i)(j) Protection of Aeronautical Radio Navigation Satellite Service Test Setup**

1. The EUT and supporting equipment were set up in accordance with the requirements of the standard on top of a 1.5m X 1.0m X 0.8m high, non-metallic table.
2. The filtered power supply for the EUT and supporting equipment were tapped from the appropriate power sockets located on the turntable.
3. The relevant antenna was set at the required test distance away from the EUT and supporting equipment boundary

**47 CFR FCC Part 25.216(h)(i)(j) Protection of Aeronautical Radio Navigation Satellite Service Test Method**

1. The EUT was set to transmit at the maximum power at the lower channel with the modulation on at normal test condition.
2. The receiving antenna (test antenna) was set at vertical polarization with the height of 1m.
3. A prescan was carried out in the frequency range under investigations with the EMI receiver set to max hold mode. For EUT which is a portable device, the prescan was carried out by rotating the EUT through three orthogonal axes to determine which attitude and equipment arrangement produces such emissions.
4. Maximization of the emissions, was carried out by rotating the EUT, changing the antenna polarization, and adjusting the antenna height in the following manner:
  - a. Vertical or horizontal polarisation (whichever gave the higher emission level over a full rotation of the EUT) was chosen.
  - b. The EUT was then rotated to the direction that gave the maximum emission.
  - c. Finally, the antenna height was adjusted to the height that gave the maximum emission.
5. The maximized emissions were plotted with inclusion of corrector factor of measured radiated emissions to EIRP.
6. The steps 1 to 5 were repeated with the EUT was set to operate at the middle and upper channels respectively.
7. The measurements were repeated with the EUT in carrier off state (standby).

**PROTECTION OF AERONAUTICAL RADIO NAVIGATION SATELLITE SERVICE TEST**

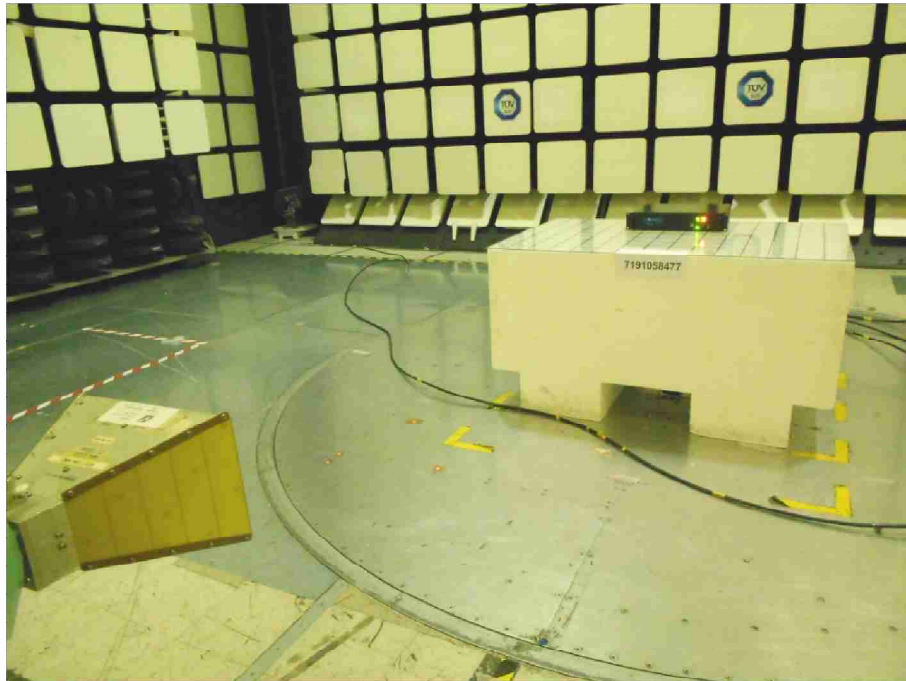

**Protection of Aeronautical Radio Navigation Satellite Service Test Setup (Front View)**

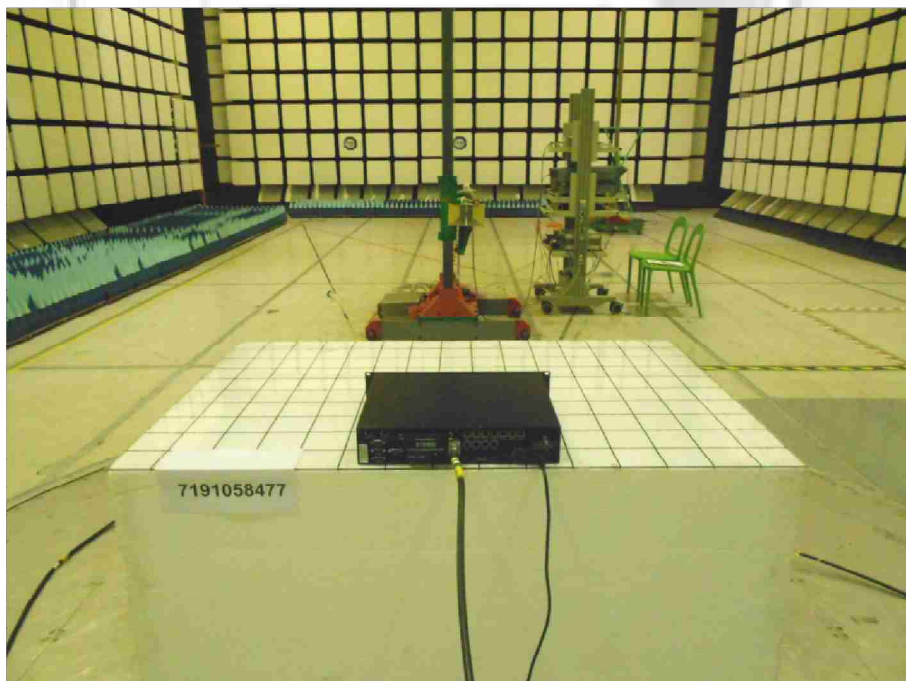

**Protection of Aeronautical Radio Navigation Satellite Service Test Setup (Rear View)**



**PROTECTION OF AERONAUTICAL RADIO NAVIGATION SATELLITE SERVICE TEST**

**47 CFR FCC Part 25.216(h)(i)(j) Protection of Aeronautical Radio Navigation Satellite Service Results**

Operating Mode	Continuous Satellite Transmission	Temperature	24°C
Test Input Power	110V 60Hz	Relative Humidity	60%
Test Distance	3m	Atmospheric Pressure	1030mbar
Attached Plots	91 – 111	Tested By	Dylan Lin, Zechs Ng

All spurious signals found were below the specified limit. Please refer to the attached plots.

Operating Mode	Satellite off (Standby)	Temperature	24°C
Test Input Power	110V 60Hz	Relative Humidity	60%
Test Distance	3m	Atmospheric Pressure	1030mbar
Attached Plots	112	Tested By	Dylan Lin, Zechs Ng

All spurious signals found were below the specified limit. Please refer to the attached plots.

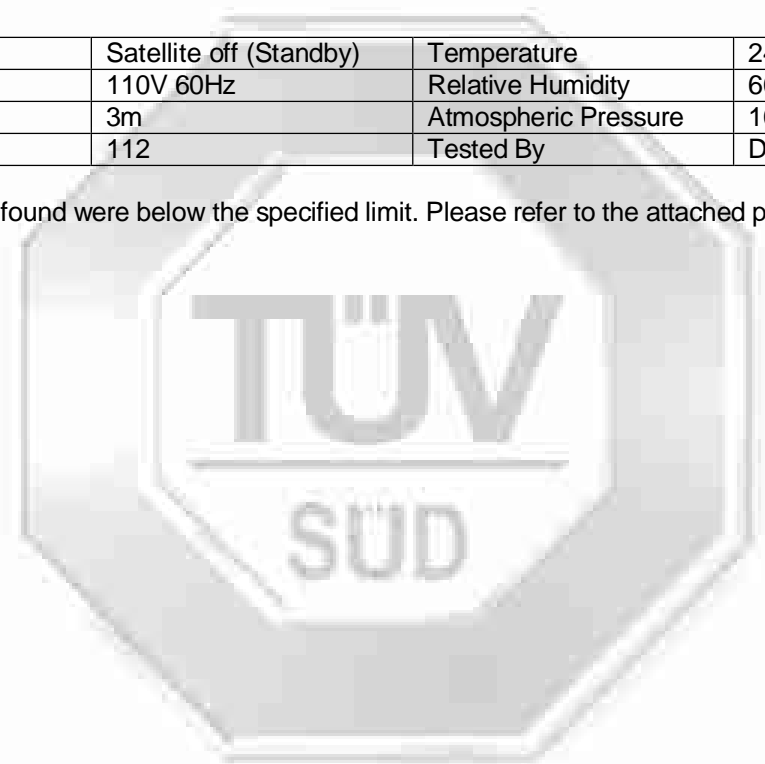



PROTECTION OF AERONAUTICAL RADIO NAVIGATION SATELLITE SERVICE TEST

Type Bearer: 0 - Transmitter On

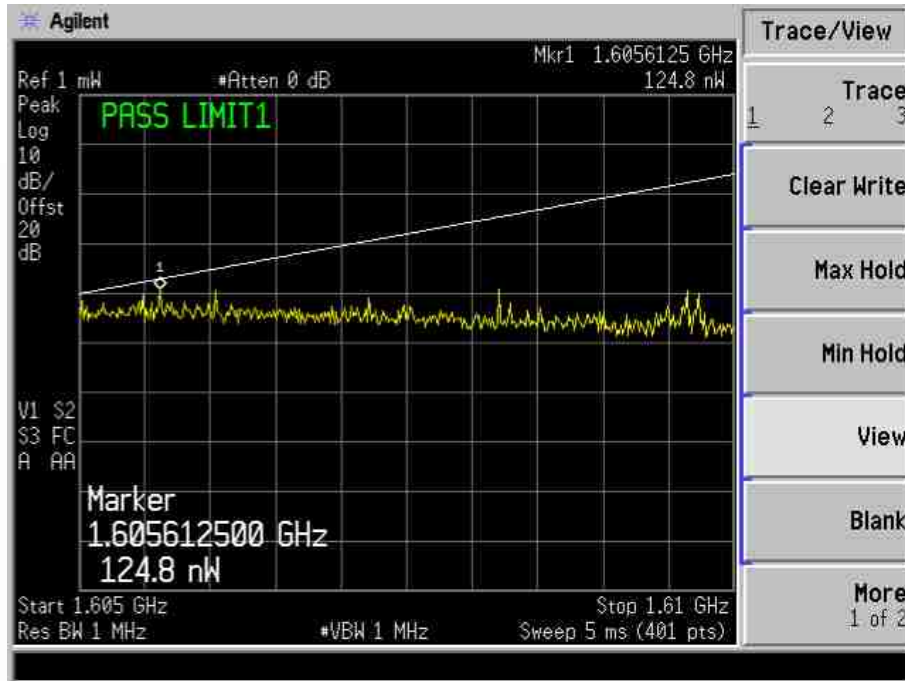

Plot 91 – Lower Channel

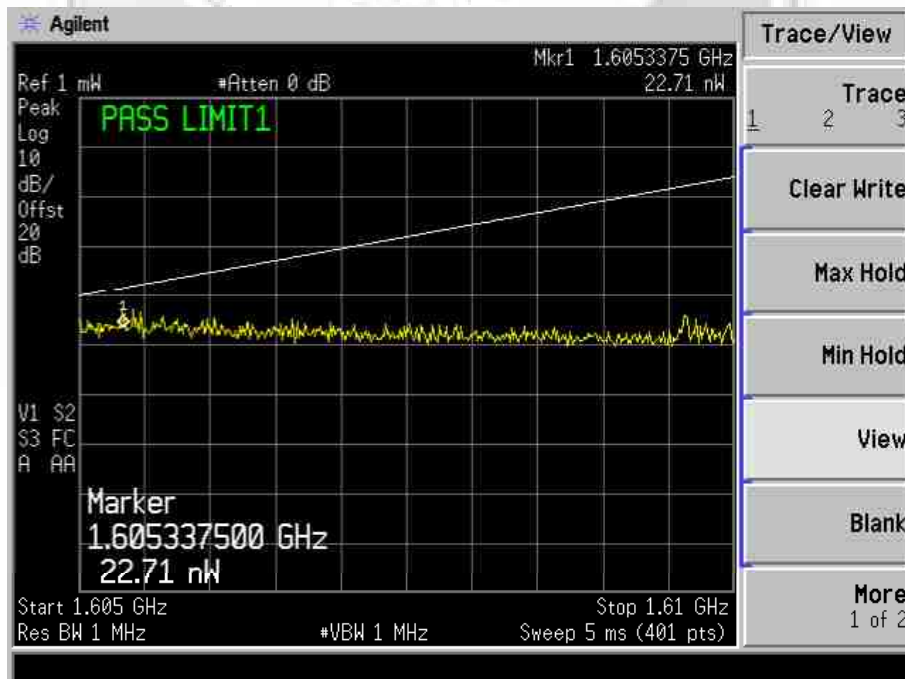

Plot 92 – Middle Channel



PROTECTION OF AERONAUTICAL RADIO NAVIGATION SATELLITE SERVICE TEST

Type Bearer: 0 - Transmitter On

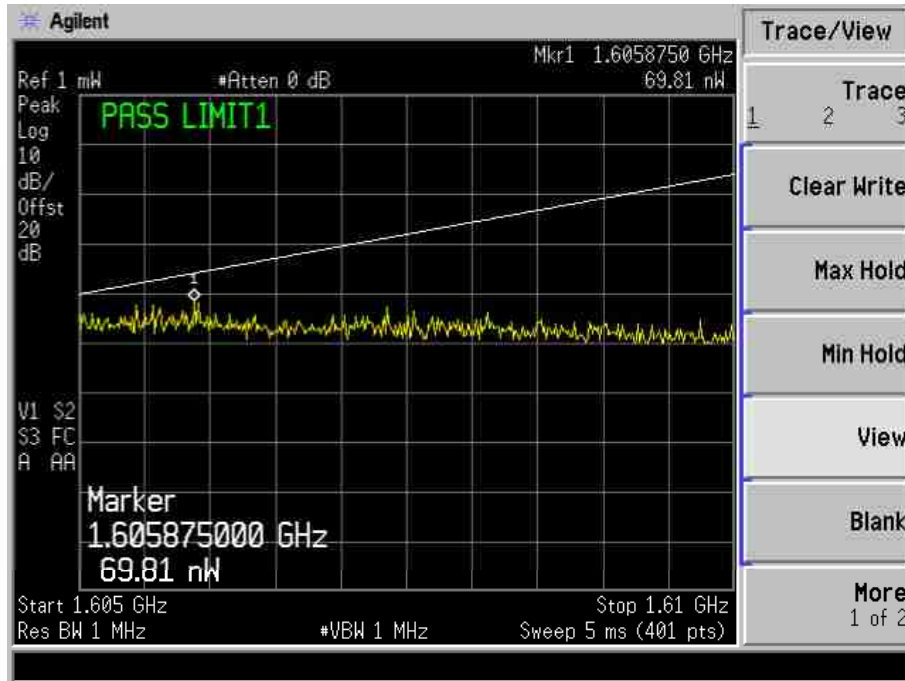

Plot 93 – Upper Channel





PROTECTION OF AERONAUTICAL RADIO NAVIGATION SATELLITE SERVICE TEST

Type Bearer: 3 - Transmitter On

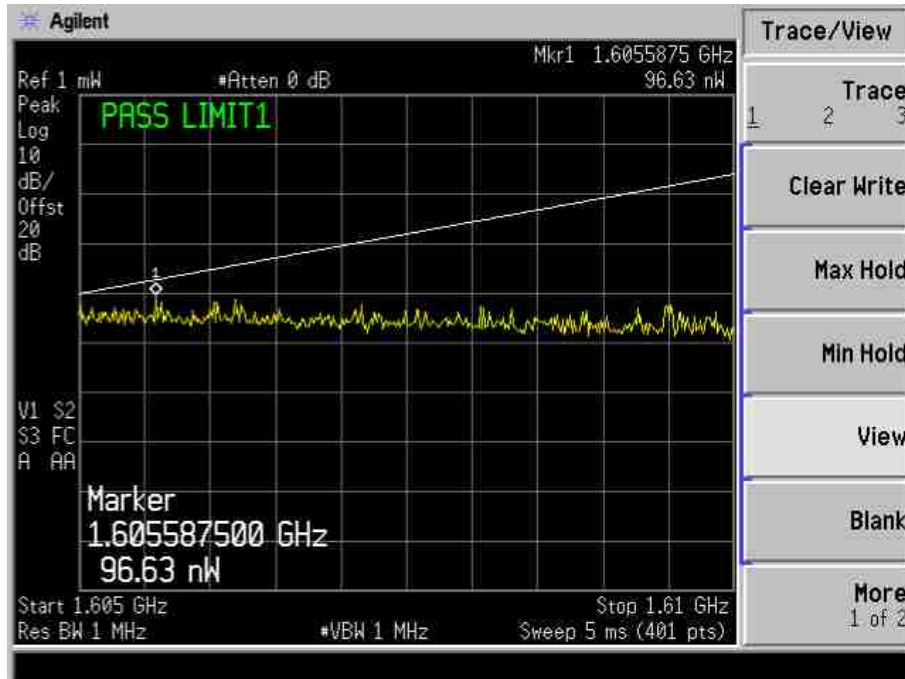

Plot 94 – Lower Channel

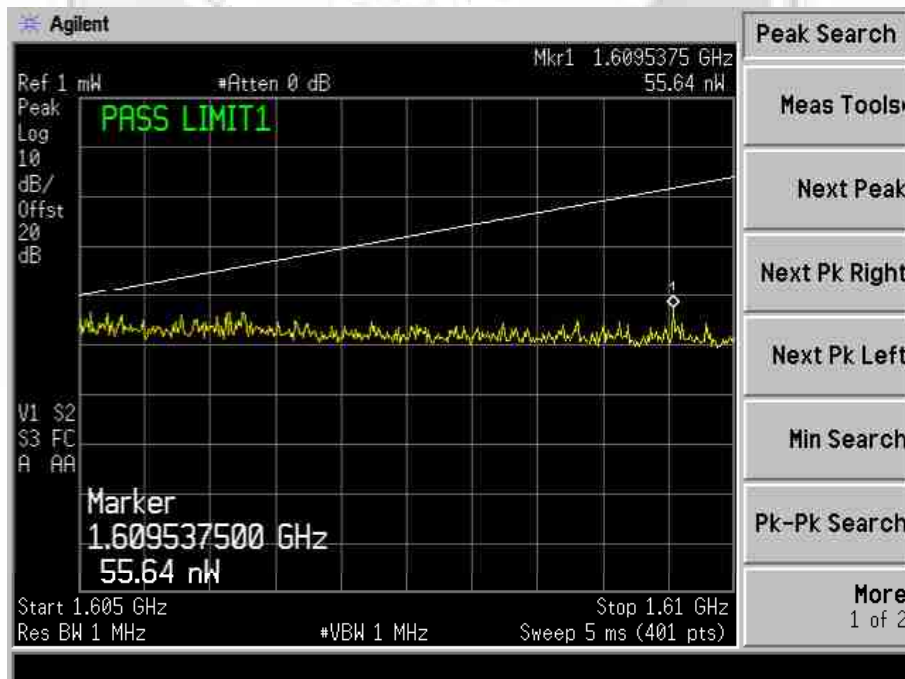

Plot 95 – Middle Channel





PROTECTION OF AERONAUTICAL RADIO NAVIGATION SATELLITE SERVICE TEST

Type Bearer: 3 - Transmitter On

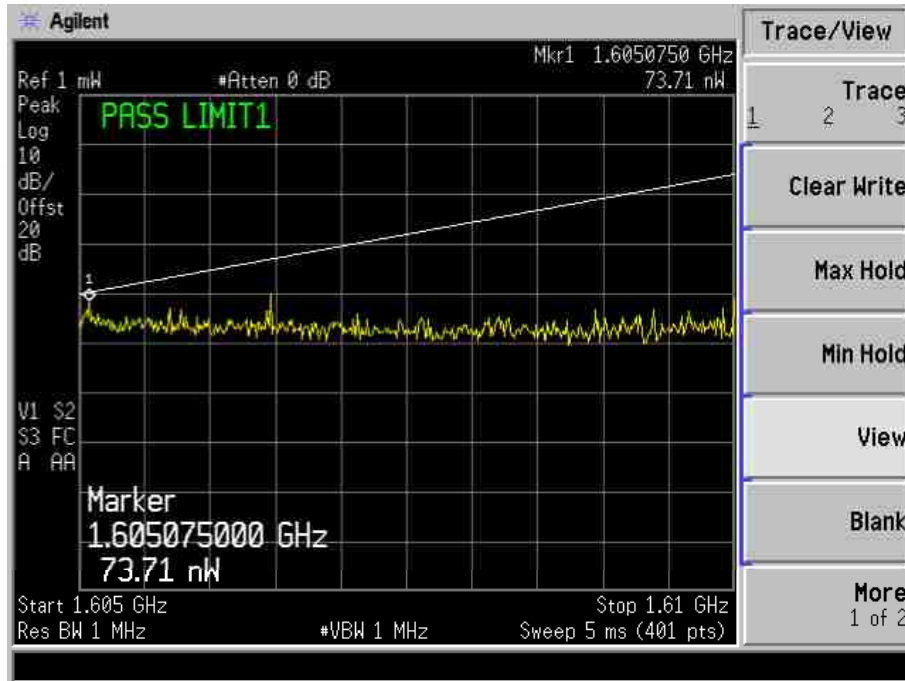

Plot 96 – Upper Channel





PROTECTION OF AERONAUTICAL RADIO NAVIGATION SATELLITE SERVICE TEST

Type Bearer: 5 - Transmitter On

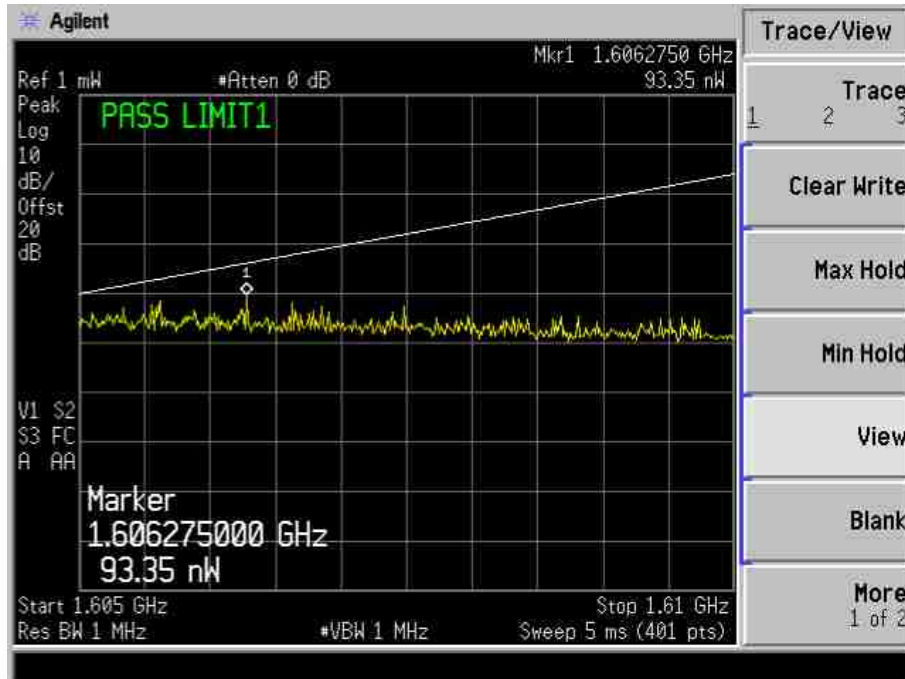

Plot 97 – Lower Channel

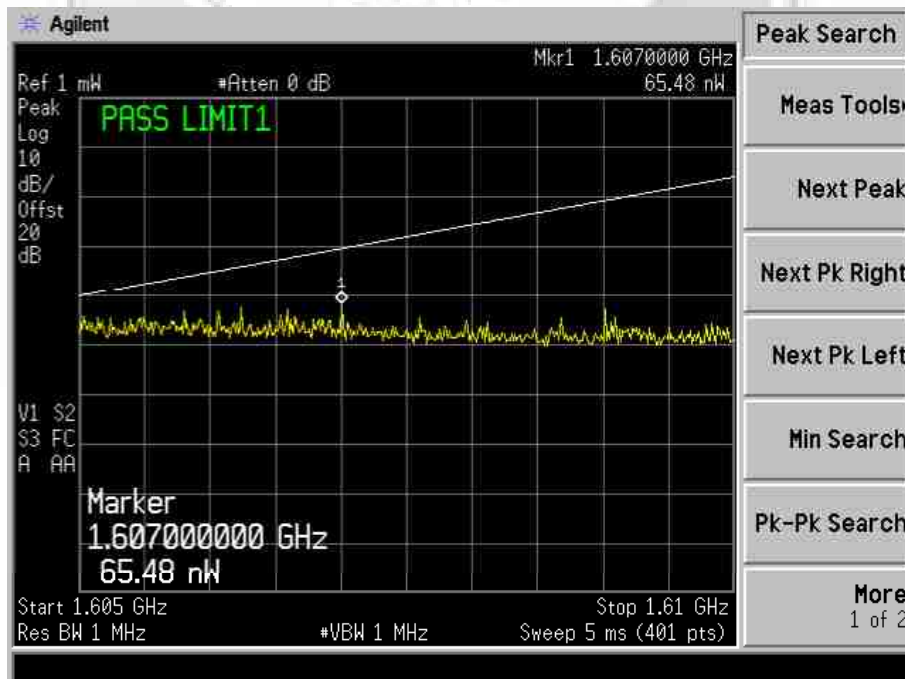

Plot 98 – Middle Channel



PROTECTION OF AERONAUTICAL RADIO NAVIGATION SATELLITE SERVICE TEST

Type Bearer: 5 - Transmitter On

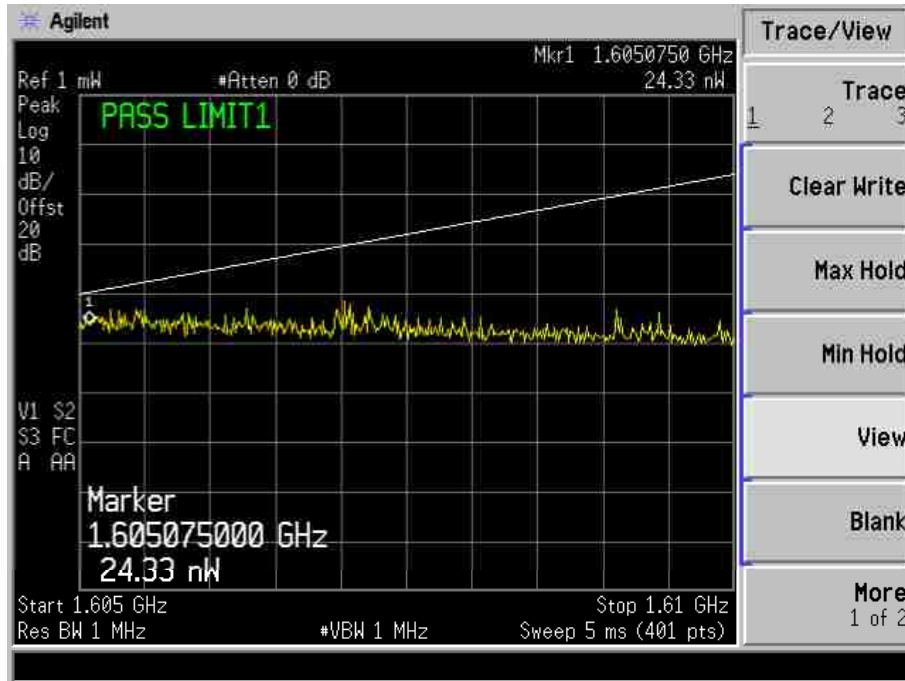

Plot 99 – Upper Channel





PROTECTION OF AERONAUTICAL RADIO NAVIGATION SATELLITE SERVICE TEST

Type Bearer: 7 - Transmitter On

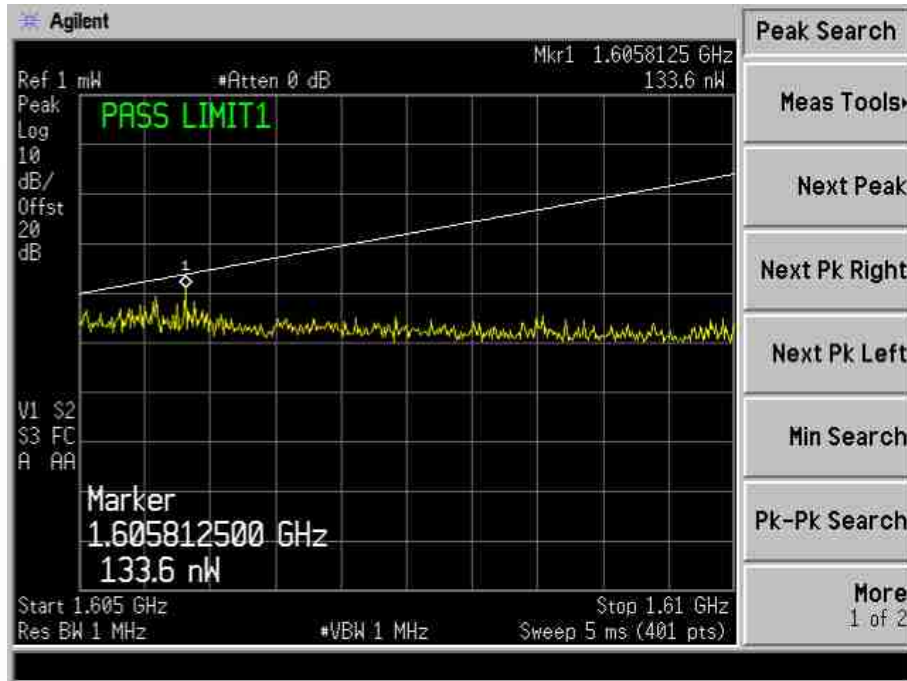

Plot 100 – Lower Channel

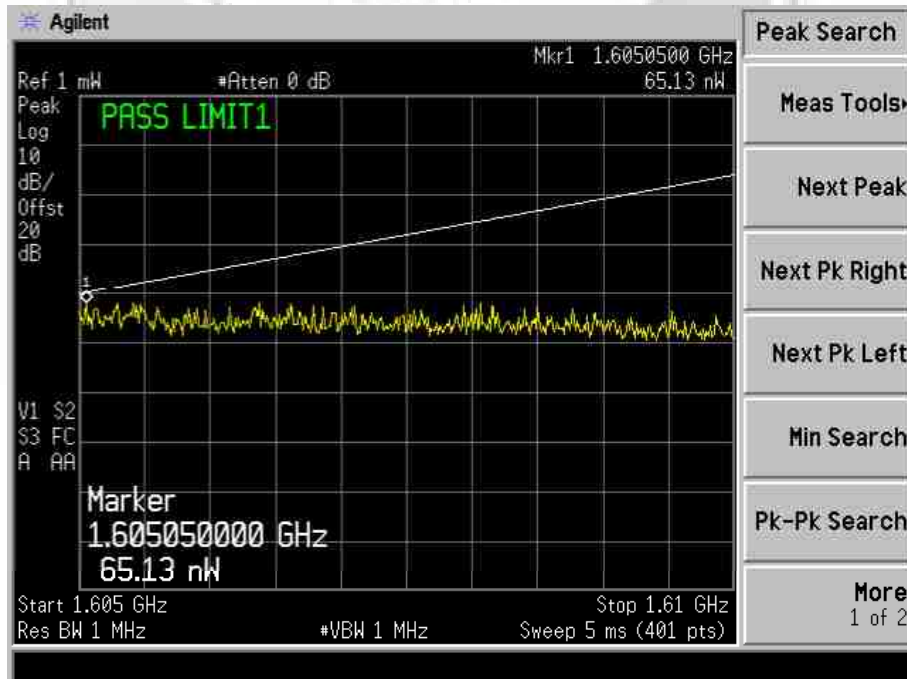

Plot 101 – Middle Channel



PROTECTION OF AERONAUTICAL RADIO NAVIGATION SATELLITE SERVICE TEST

Type Bearer: 7 - Transmitter On

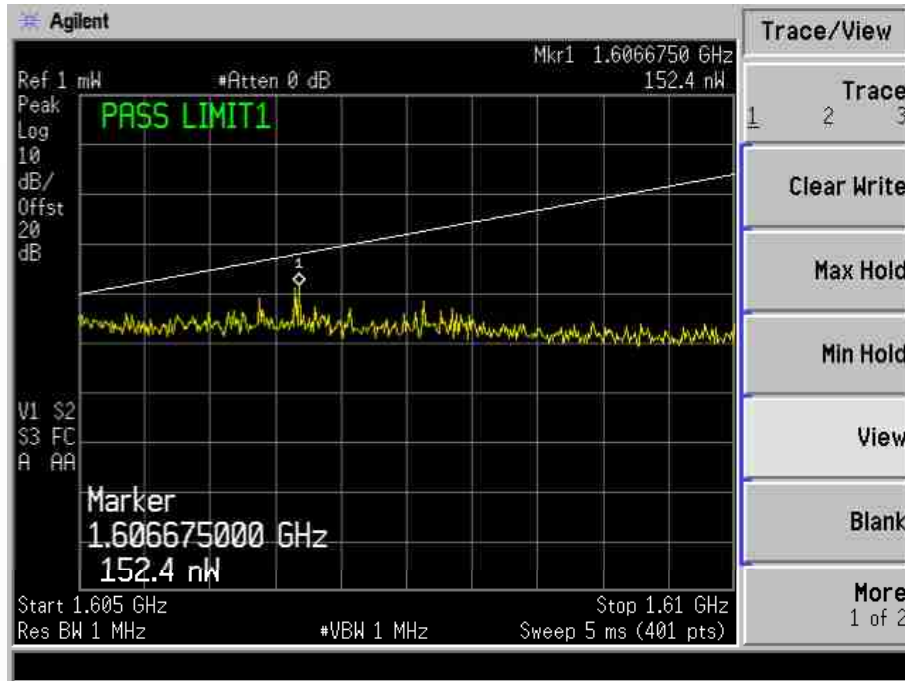

Plot 102 – Upper Channel

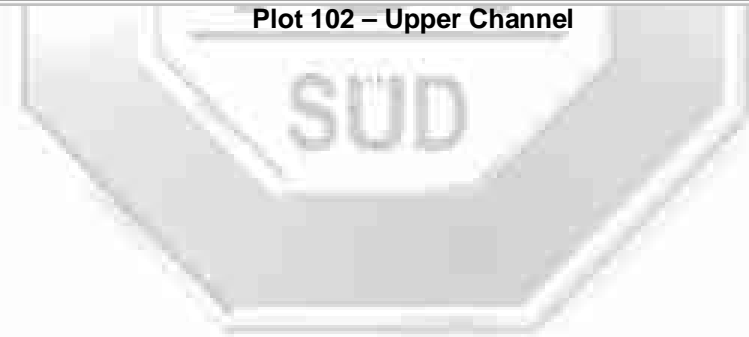



PROTECTION OF AERONAUTICAL RADIO NAVIGATION SATELLITE SERVICE TEST

Type Bearer: 11 - Transmitter On

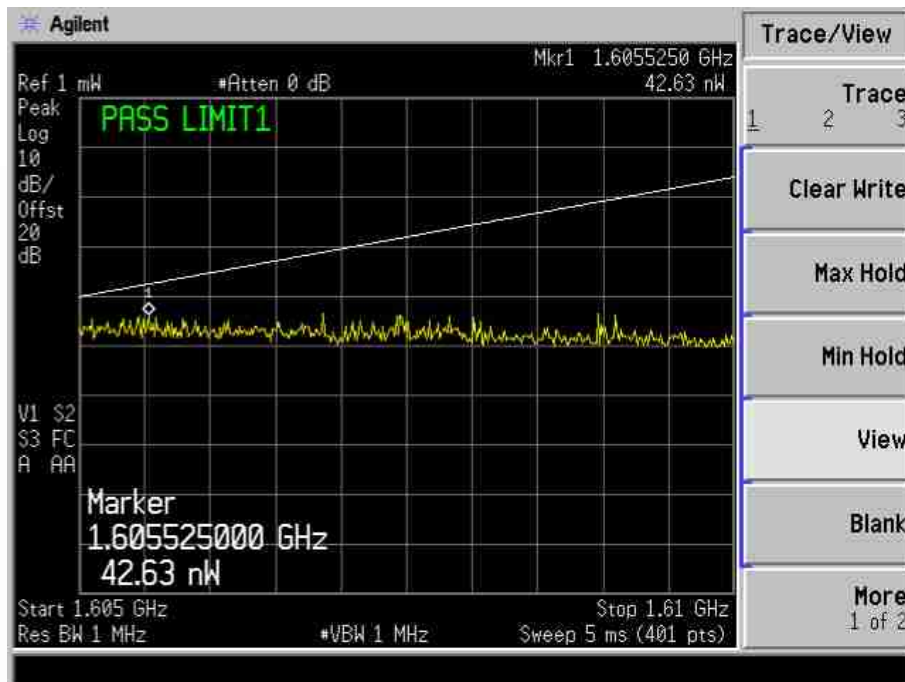

Plot 103 – Lower Channel

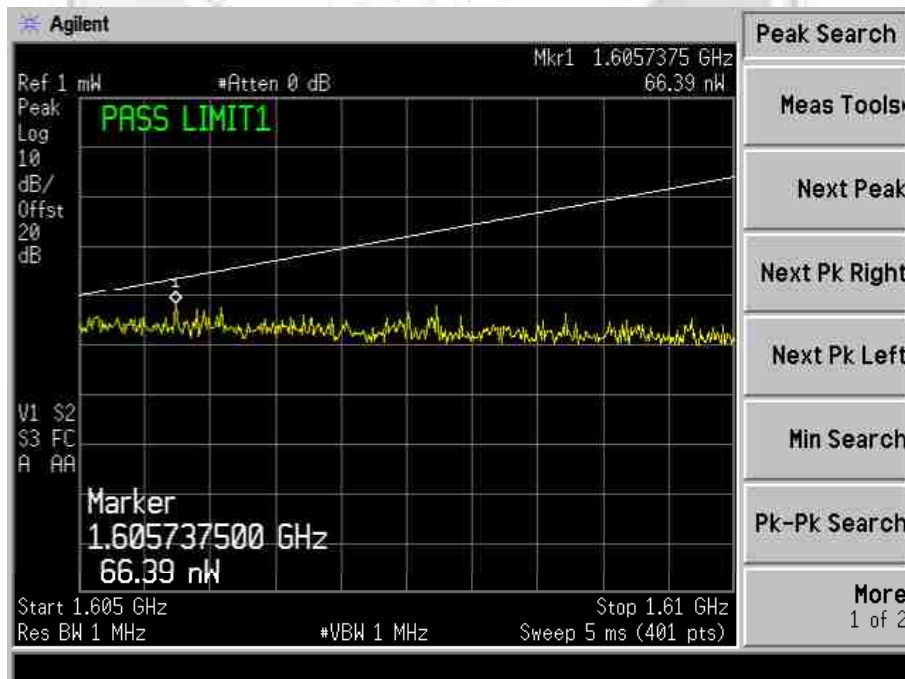

Plot 104 – Middle Channel





PROTECTION OF AERONAUTICAL RADIO NAVIGATION SATELLITE SERVICE TEST

Type Bearer: 11 - Transmitter On

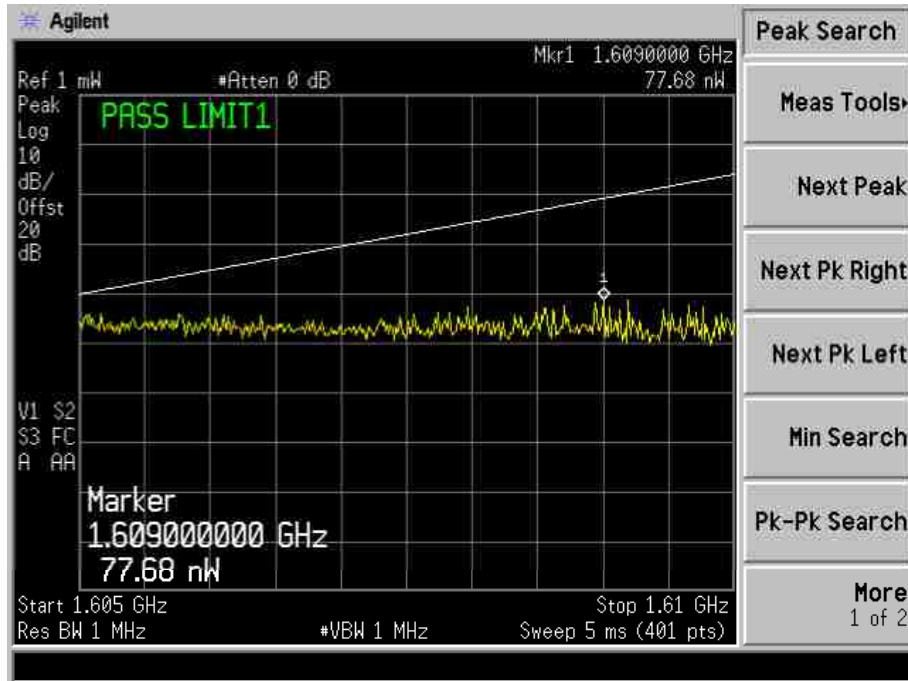

Plot 105 – Upper Channel





PROTECTION OF AERONAUTICAL RADIO NAVIGATION SATELLITE SERVICE TEST

Type Bearer: 13 - Transmitter On

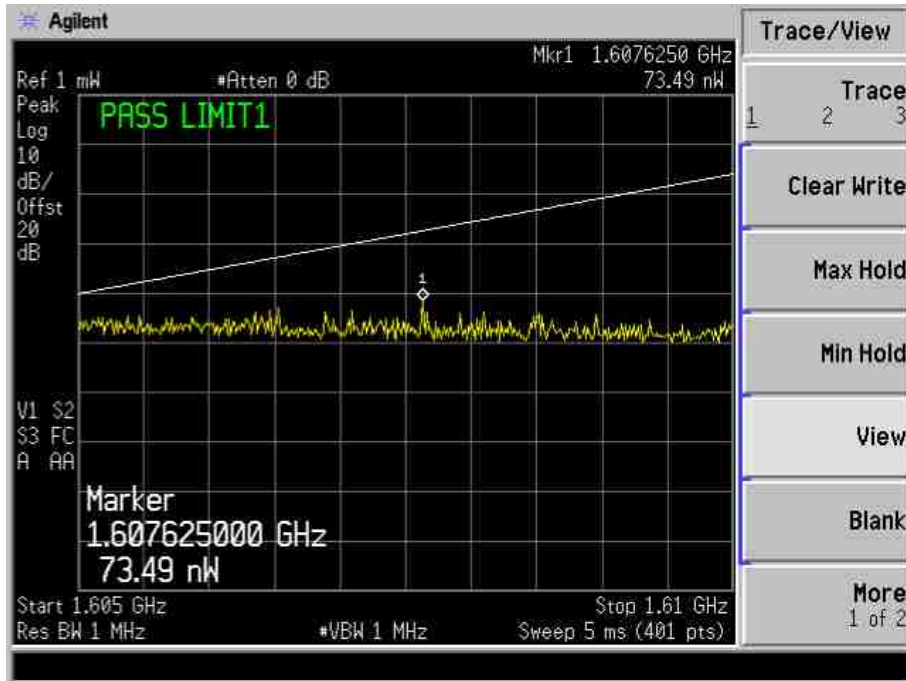

Plot 106 – Lower Channel

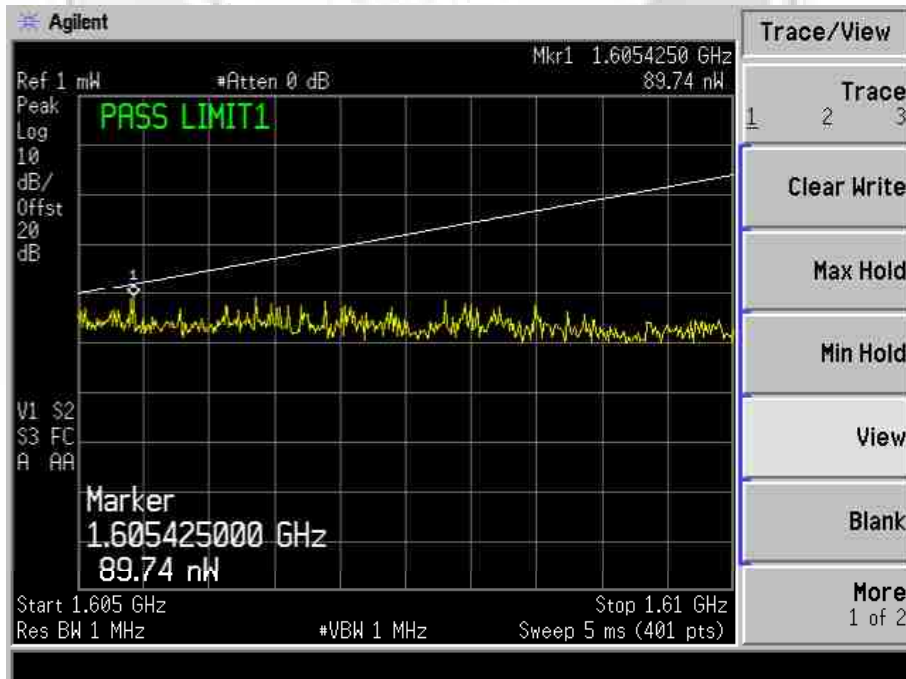

Plot 107 – Middle Channel



PROTECTION OF AERONAUTICAL RADIO NAVIGATION SATELLITE SERVICE TEST

Type Bearer: 13 - Transmitter On

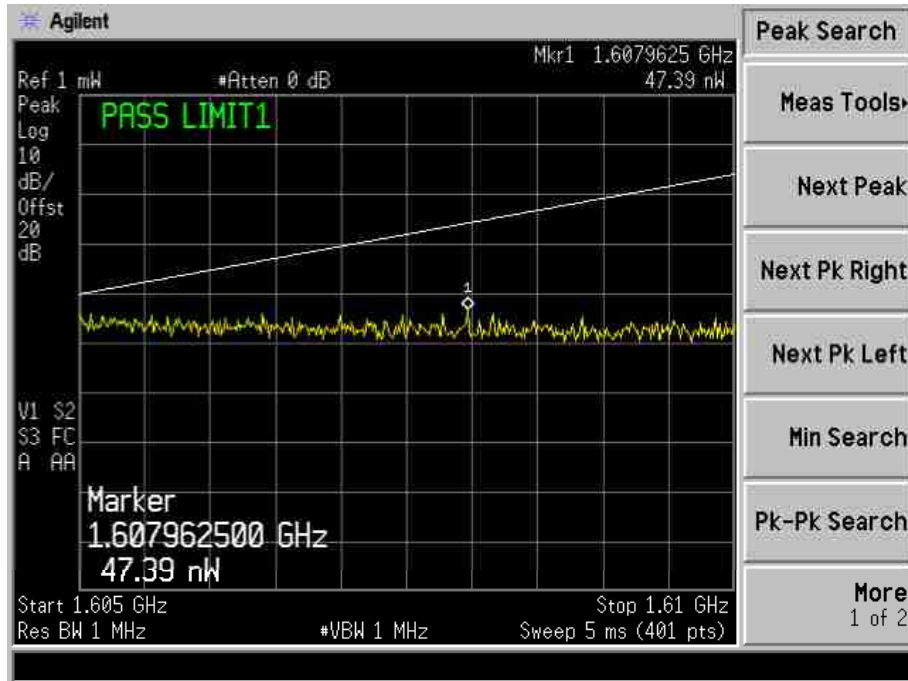

Plot 108 – Upper Channel

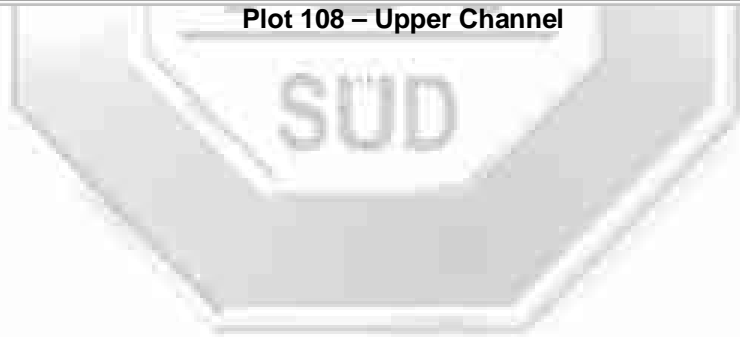



PROTECTION OF AERONAUTICAL RADIO NAVIGATION SATELLITE SERVICE TEST

Type Bearer: 15 - Transmitter On

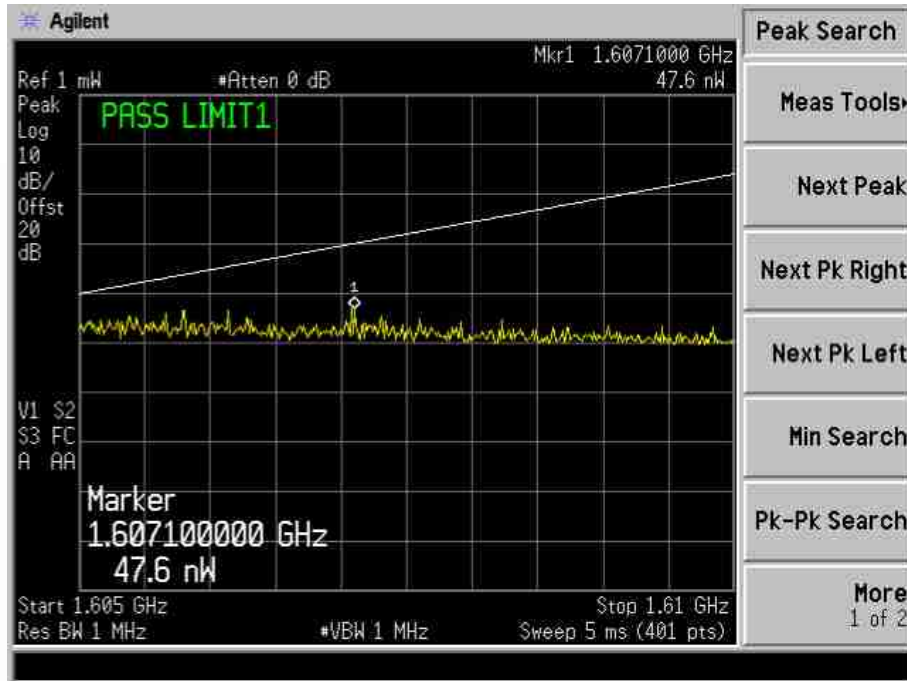

Plot 109 – Lower Channel

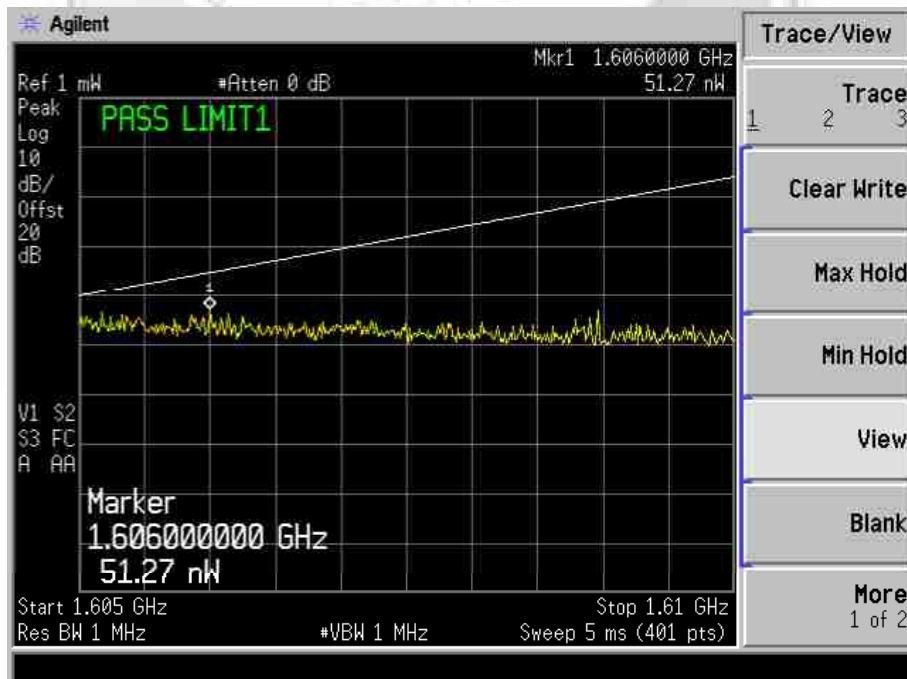

Plot 110 – Middle Channel



PROTECTION OF AERONAUTICAL RADIO NAVIGATION SATELLITE SERVICE TEST

Type Bearer: 15 - Transmitter On

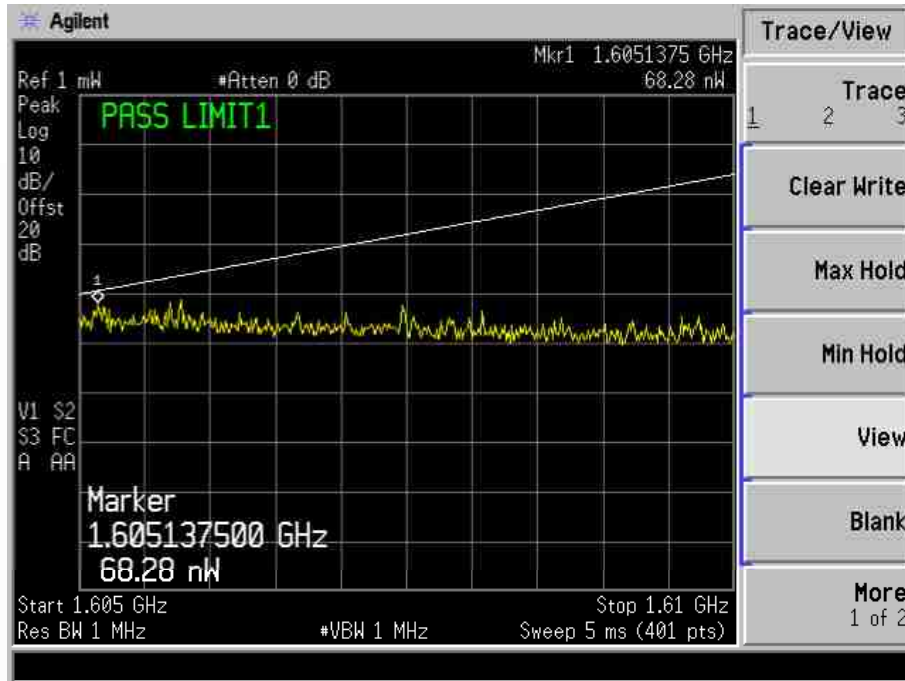

Plot 111 – Upper Channel





PROTECTION OF AERONAUTICAL RADIO NAVIGATION SATELLITE SERVICE TEST

Carrier Off

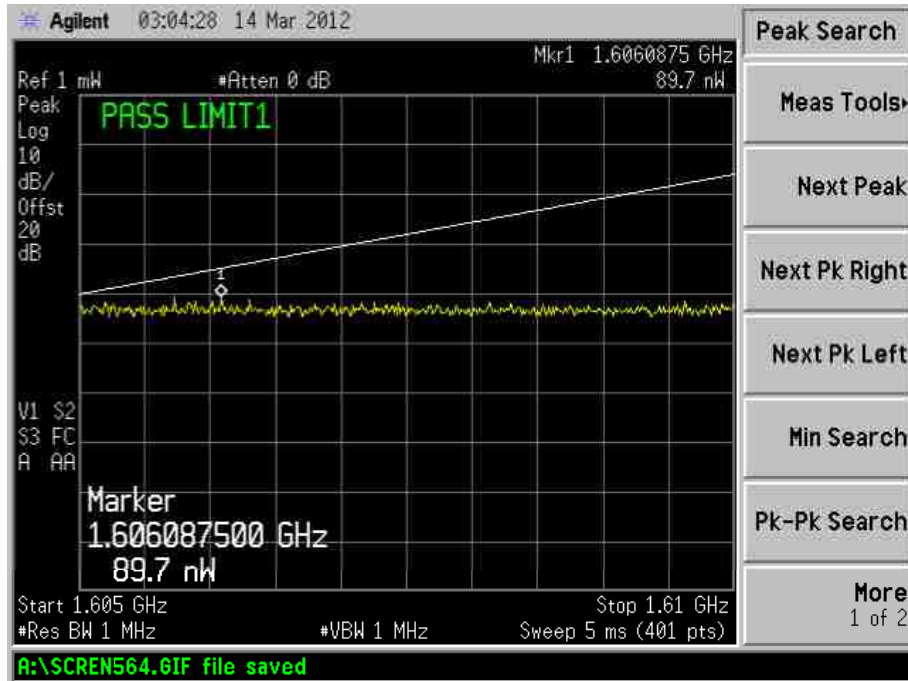

Plot 112 – Lower Channel





## FREQUENCY STABILITY (TEMPERATURE VARIATION) TEST

### 47 CFR FCC Parts 2.1055 and 25.202(d) Frequency Stability (Temperature Variation) Test Limits

1. 25.202(d) Frequency Tolerance, Earth Stations  
The carrier frequency of each earth station transmitter authorised in these services shall be maintained within 0.001% (10ppm) of the reference frequency.
2. 2.1055 Measurements Required: Frequency Stability
  - (a) The frequency stability shall be measured with variation of ambient temperature as follows:
    - (1) From -30°C to +50°C for all equipment except that specified in paragraphs (a)(2) and (3) of this section.
    - (b) Frequency measurements shall be made at the extremes of the specified temperature range and at interval of not more than 10°C throughout the range. A period of time sufficient to stabilize all of the components of the oscillator circuit at each temperature level shall be allowed prior to frequency measurement. The short term transient effects on the frequency of the transmitter due to keying (except for broadcast transmitters) and any heating element cycling normally occurring at each ambient temperature level also shall be shown. Only the portion of portions of the transmitter containing the frequency determining and stabilizing circuitry need to be subjected to the temperature variation test.
  - (d) The frequency stability shall be measured with variation of primary supply voltage as follows:
    - (1) Vary primary supply voltage from 85 to 115 percent of the nominal value for other than hand carried battery equipment.
    - (2) For hand carried, battery powered equipment, reduce primary supply voltage to the battery operating end point which shall be specified by the manufacturer.
    - (3) The supply voltage shall be measured at the input to the cable normally provided with the equipment, or at the power supply terminals if cables are not normally provided. Effects on frequency of transmitter keying (except for broadcast transmitters) and any heating element cycling at the nominal supply voltage and at each extreme also shall be shown.

### 47 CFR FCC Parts 2.1055 and 25.202(d) Frequency Stability (Temperature Variation) Test Instrumentation

Instrument	Model	S/No	Cal Due Date
Agilent Universal Counter	53132A	3736A0628	25 May 2014
Mini-Circuits Precision Fixed Attenuator	BW-S20W5+	Nil	Output Monitor
Instock Wireless Components Combiner	PD7120	Nil	Output Monitor



## FREQUENCY STABILITY (TEMPERATURE VARIATION) TEST

### 47 CFR FCC Parts 2.1055 and 25.202(d) Frequency Stability (Temperature Variation) Test Setup

1. The EUT and supporting equipment were set up as shown in the test setup photo. A temperature-controlled chamber was used.
2. The EUT was connected to an appropriate power source while all other supporting equipment were powered separately from another power source.
3. The RF antenna connector of the EUT was connected to the spectrum analyser via a RF attenuator and a low-loss coaxial cable.

### 47 CFR FCC Parts 2.1055 and 25.202(d) Frequency Stability (Temperature Variation) Test Method

1. The temperature chamber was set at 20°C and permitted to stabilize. The EUT was set to transmit at lower channel without modulation. The carrier frequency was measured as the reference frequency.
2. With the EUT power removed, the temperature of the temperature chamber was set to -30°C and permitted to stabilize.
3. The EUT was turned on and set to operate at lower channel without modulation. The maximum change in the carrier frequency was recorded within a minute.
4. The EUT was powered off and the temperature was raised to -20°C.
5. The EUT was left stabilized for at least an hour before next measurement was taken as described in step 3.
6. The steps 4 and 5 were repeated with increment of temperature in 10°C step until the temperature reached 50°C.
7. The steps 1 to 6 were repeated with the EUT was set to operate at the middle and upper channels respectively.

**FREQUENCY STABILITY (TEMPERATURE VARIATION) TEST**



**Frequency Stability (Temperature Variation) Test Setup**

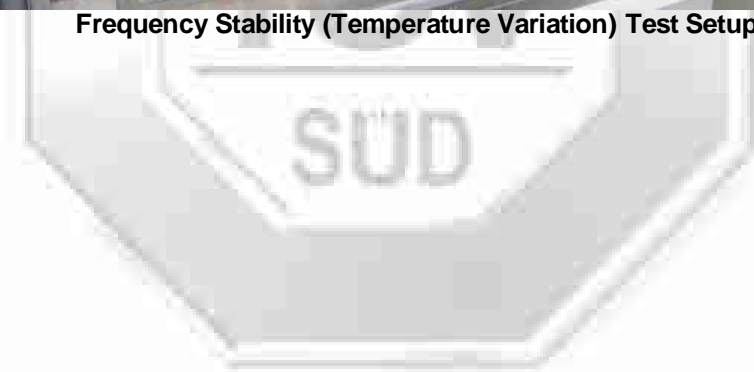



**FREQUENCY STABILITY (TEMPERATURE VARIATION) TEST**

**47 CFR FCC Parts 2.1055 and 25.202(d) Frequency Stability (Temperature Variation) Results**

Operating Mode	Continuous Satellite Transmission	Temperature	See table below
Test Input Power	110V 60Hz	Relative Humidity	70%
		Atmospheric Pressure	1030mbar
		Tested By	Chelmin Li

**Lower Channel**

Temperature (°C)	Measured Frequency (GHz)	Reference Channel Frequency (GHz)	Deviation (Hz)	Limit (Hz)
-30	1.626600518	1.626600000	518.000000	+/-16266
-20	1.626600457	1.626600000	457.000000	+/-16266
-10	1.626600477	1.626600000	477.000000	+/-16266
0	1.626600718	1.626600000	718.000000	+/-16266
10	1.626600834	1.626600000	834.000000	+/-16266
20	1.626600845	1.626600000	845.000000	+/-16266
30	1.626600907	1.626600000	907.000000	+/-16266
40	1.626600936	1.626600000	936.000000	+/-16266
50	1.626600988	1.626600000	988.000000	+/-16266

**Middle Channel**

Temperature (°C)	Measured Frequency (GHz)	Reference Channel Frequency (GHz)	Deviation (Hz)	Limit (Hz)
-30	1.643500582	1.643500000	582.000000	+/-16435
-20	1.643500449	1.643500000	449.000000	+/-16435
-10	1.643500546	1.643500000	546.000000	+/-16435
0	1.643500782	1.643500000	782.000000	+/-16435
10	1.643500883	1.643500000	883.000000	+/-16435
20	1.643500887	1.643500000	887.000000	+/-16435
30	1.643500959	1.643500000	959.000000	+/-16435
40	1.643500983	1.643500000	983.000000	+/-16435
50	1.643501032	1.643500000	1032.000000	+/-16435



**FREQUENCY STABILITY (TEMPERATURE VARIATION) TEST**

**47 CFR FCC Parts 2.1055 and 25.202(d) Frequency Stability (Temperature Variation) Results**

Operating Mode	Continuous Satellite Transmission	Temperature	See table below
Test Input Power	110V 60Hz	Relative Humidity	70%
		Atmospheric Pressure	1030mbar
		Tested By	Chelmin Li

**Upper Channel**

Temperature (°C)	Measured Frequency (GHz)	Reference Channel Frequency (GHz)	Deviation (Hz)	Limit (Hz)
-30	1.660400491	1.660400000	491.000000	+/-16604
-20	1.660400418	1.660400000	418.000000	+/-16604
-10	1.660400542	1.660400000	542.000000	+/-16604
0	1.660400774	1.660400000	774.000000	+/-16604
10	1.660400856	1.660400000	856.000000	+/-16604
20	1.660400857	1.660400000	857.000000	+/-16604
30	1.660400938	1.660400000	938.000000	+/-16604
40	1.660400952	1.660400000	952.000000	+/-16604
50	1.660401008	1.660400000	1008.000000	+/-16604

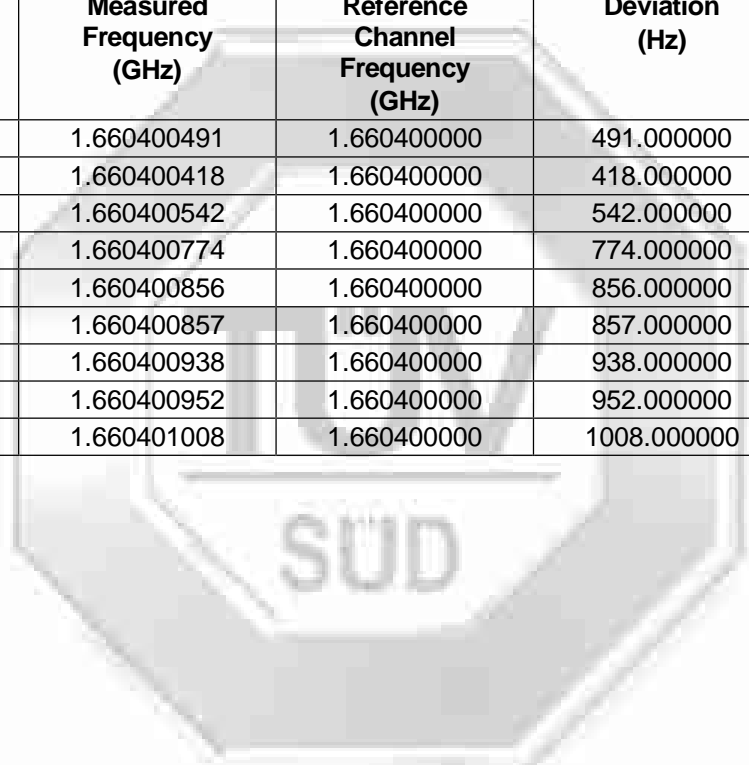

## FREQUENCY STABILITY (VOLTAGE VARIATION) TEST

### 47 CFR FCC Parts 2.1055 and 25.202(d) Frequency Stability (Voltage Variation) Test Limits

1. 25.202(d) Frequency Tolerance, Earth Stations  
The carrier frequency of each earth station transmitter authorised in these services shall be maintained within 0.001% (10ppm) of the reference frequency.
2. 2.1055 Measurements Required: Frequency Stability
  - (a) The frequency stability shall be measured with variation of ambient temperature as follows:
    - (1) From -30°C to +50°C for all equipment except that specified in paragraphs (a)(2) and (3) of this section.
    - (b) Frequency measurements shall be made at the extremes of the specified temperature range and at interval of not more than 10°C throughout the range. A period of time sufficient to stabilize all of the components of the oscillator circuit at each temperature level shall be allowed prior to frequency measurement. The short term transient effects on the frequency of the transmitter due to keying (except for broadcast transmitters) and any heating element cycling normally occurring at each ambient temperature level also shall be shown. Only the portion of portions of the transmitter containing the frequency determining and stabilizing circuitry need to be subjected to the temperature variation test.
  - (d) The frequency stability shall be measured with variation of primary supply voltage as follows:
    - (1) Vary primary supply voltage from 85 to 115 percent of the nominal value for other than hand carried battery equipment.
    - (2) For hand carried, battery powered equipment, reduce primary supply voltage to the battery operating end point which shall be specified by the manufacturer.
    - (3) The supply voltage shall be measured at the input to the cable normally provided with the equipment, or at the power supply terminals if cables are not normally provided. Effects on frequency of transmitter keying (except for broadcast transmitters) and any heating element cycling at the nominal supply voltage and at each extreme also shall be shown.

### 47 CFR FCC Parts 2.1055 and 25.202(d) Frequency Stability (Voltage Variation) Test Instrumentation

Instrument	Model	S/No	Cal Due Date
Agilent Universal Counter	53132A	3736A0628	25 May 2014
Mini-Circuits Precision Fixed Attenuator	BW-S20W5+	Nil	Output Monitor
Instock Wireless Components Combiner	PD7120	Nil	Output Monitor
Voltac Variable Voltage Transformer	SB-10	6239	Output Monitor





## FREQUENCY STABILITY (VOLTAGE VARIATION) TEST

### 47 CFR FCC Parts 2.1055 and 25.202(d) Frequency Stability (Voltage Variation) Test Setup

1. The EUT and supporting equipment were set up as shown in the test setup photo. A temperature-controlled chamber was used.
2. The EUT was connected to an appropriate power source while all other supporting equipment were powered separately from another power source.
3. The RF antenna connector of the EUT was connected to the spectrum analyser via a RF attenuator and a low-loss coaxial cable.

### 47 CFR FCC Parts 2.1055 and 25.202(d) Frequency Stability (Voltage Variation) Test Method

1. The temperature chamber was set at 20°C and permitted to stabilize. The EUT was set to transmit at lower channel without modulation. The carrier frequency was measured as the reference frequency.
2. The EUT was powered from 85% of the nominal supplied voltage and set to operate at lower channel without modulation.
3. The EUT power was varied from 85% to 115% of the nominal supplied voltage. The carrier frequency variation was recorded.
4. The steps 1 to 3 were repeated with the EUT was set to operate at the middle and upper channels respectively.

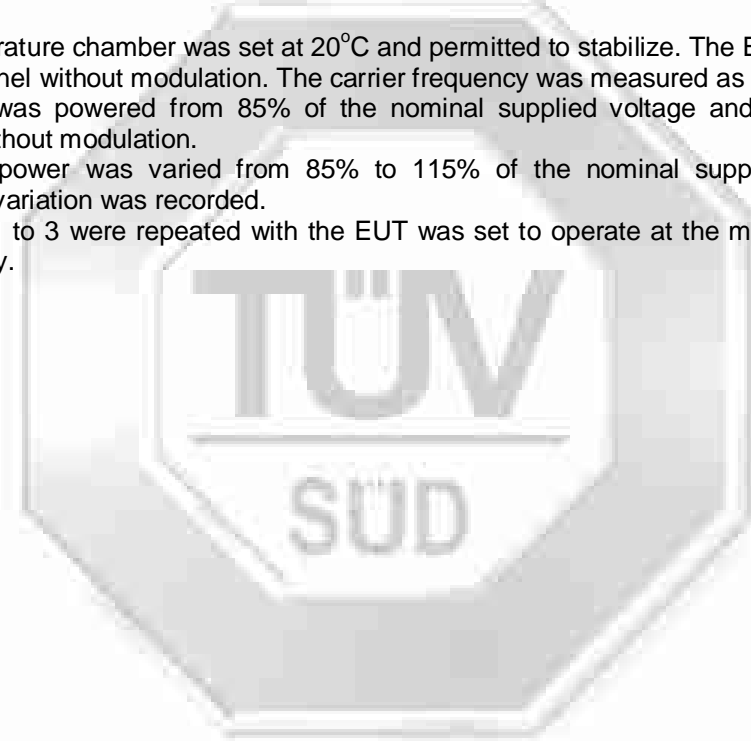

**FREQUENCY STABILITY (VOLTAGE VARIATION) TEST**



**Frequency Stability (Voltage Variation) Test Setup**

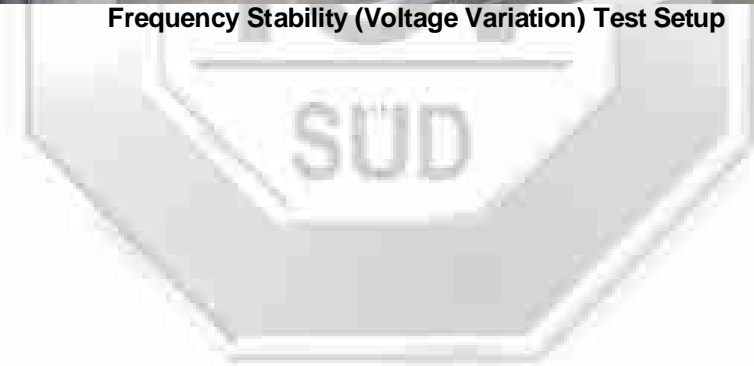



**FREQUENCY STABILITY (VOLTAGE VARIATION) TEST**

**47 CFR FCC Parts 2.1055 and 25.202(d) Frequency Stability (Voltage Variation) Results**

Operating Mode	Continuous Satellite Transmission	Temperature	20°C
Test Input Power	See table below	Relative Humidity	70%
		Atmospheric Pressure	1030mbar
		Tested By	Chelmin Li

**Lower Channel**

Voltage (Vac)	Measured Frequency (GHz)	Nominal Channel Frequency (GHz)	Deviation (Hz)	Limit (Hz)
93.5	1.626600878	1.626600000	878.000000	+/-16266
110.0	1.626600863	1.626600000	863.000000	+/-16266
126.5	1.626600897	1.626600000	897.000000	+/-16266

**Middle Channel**

Voltage (V)	Measured Frequency (GHz)	Nominal Channel Frequency (GHz)	Deviation (Hz)	Limit (Hz)
93.5	1.643500930	1.643500000	930.000000	+/-16435
110.0	1.643500887	1.643500000	887.000000	+/-16435
126.5	1.643500942	1.643500000	942.000000	+/-16435

**Upper Channel**

Voltage (V)	Measured Frequency (GHz)	Nominal Channel Frequency (GHz)	Deviation (Hz)	Limit (Hz)
93.5	1.660400900	1.660400000	900.000000	+/-16604
110.0	1.660400857	1.660400000	857.000000	+/-16604
126.5	1.660400913	1.660400000	913.000000	+/-16604



**MAXIMUM PERMISSIBLE EXPOSURE (MPE) TEST**

**47 CFR FCC Part 1.1310 Maximum Permissible Exposure (MPE) Limits**

The EUT shows compliance to the requirements of this section, which states the MPE limits for general population / uncontrolled exposure are as shown below:

Frequency Range (MHz)	Electric Field Strength (V/m)	Magnetic Field Strength (A/m)	Power Density (mW/cm <sup>2</sup> )	Average Time (min)
0.3 - 1.34	614	1.63	100 <sup>Note 2</sup>	30
1.34 - 30	824 / f	2.19 / f	180 / f <sup>2</sup> <sup>Note 2</sup>	30
30 - 300	27.5	0.073	0.2	30
300 - 1500	-	-	f / 1500	30
1500 - 100000	-	-	1.0	30

Notes

1. f = frequency in MHz
2. Plane wave equivalent power density

**47 CFR FCC Part 1.1310 Maximum Permissible Exposure Computation**

The minimum distance to the EUT was computed from the following formula:

$$S = (30GP) / (377d^2)$$

where

$$S = 10W/m^2$$

$$P = 5.2119W$$

$$d = \text{Test distance}$$

$$G = \text{Numerical isotropic gain, 10.0 (10.0dBi)}$$

Substituting the relevant parameters into the formula:

$$d = \sqrt{[(30GP) / 377S]}$$

$$= 0.65m$$

∴ The EUT shall maintain at least at 0.65m from operators to comply with MPE criteria.

**Test Report No. 7191058477-EEC13/11**  
**dated 17 Jun 2013**



PSB Singapore

Please note that this Report is issued under the following terms :

1. This report applies to the sample of the specific product/equipment given at the time of its testing/calibration. The results are not used to indicate or imply that they are applicable to other similar items. In addition, such results must not be used to indicate or imply that TÜV SÜD PSB approves, recommends or endorses the manufacturer, supplier or user of such product/equipment, or that TÜV SÜD PSB in any way "guarantees" the later performance of the product/equipment. Unless otherwise stated in this report, no tests were conducted to determine long term effects of using the specific product/equipment.
2. The sample/s mentioned in this report is/are submitted/supplied/manufactured by the Client. TÜV SÜD PSB therefore assumes no responsibility for the accuracy of information on the brand name, model number, origin of manufacture, consignment or any information supplied.
3. Nothing in this report shall be interpreted to mean that TÜV SÜD PSB has verified or ascertained any endorsement or marks from any other testing authority or bodies that may be found on that sample.
4. This report shall not be reproduced wholly or in parts and no reference shall be made by the Client to TÜV SÜD PSB or to the report or results furnished by TÜV SÜD PSB in any advertisements or sales promotion.
5. Unless otherwise stated, the tests were carried out in TÜV SÜD PSB Pte Ltd, No.1 Science Park Drive Singapore 118221.

July 2011

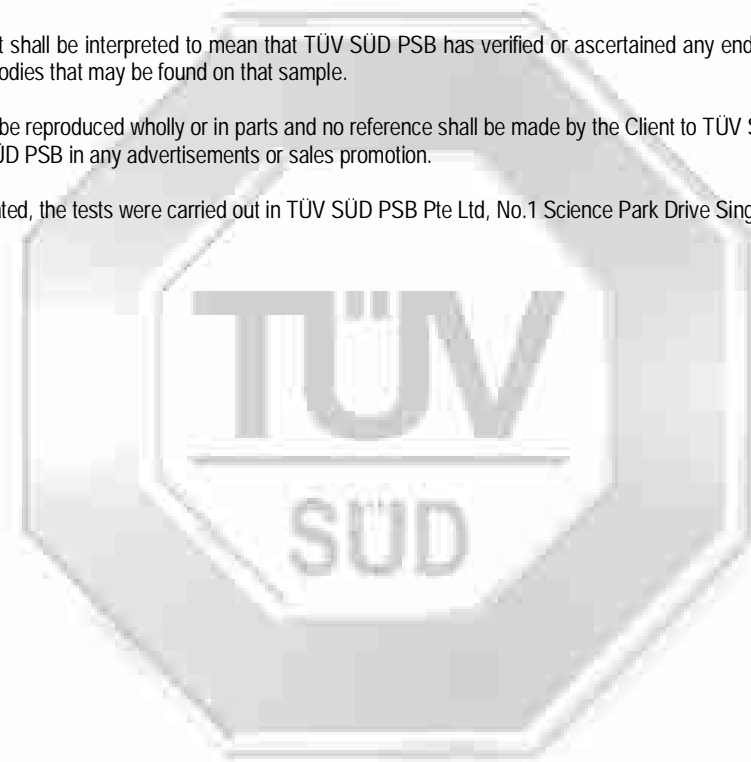



**ANNEX A EUT PHOTOGRAPHS / DIAGRAMS**

---





**ANNEX A EUT PHOTOGRAPHS / DIAGRAMS**

**EUT PHOTOGRAPHS – MAIN UNIT**



**Front View**



**Rear View**

**ANNEX A EUT PHOTOGRAPHS / DIAGRAMS**

**EUT PHOTOGRAPHS – ANTENNA UNIT**



**Front View**



ANNEX A EUT PHOTOGRAPHS / DIAGRAMS

EUT PHOTOGRAPHS – ANTENNA UNIT



Internal Front View

ANNEX A EUT PHOTOGRAPHS / DIAGRAMS

EUT PHOTOGRAPHS – ANTENNA UNIT



Antenna Board PCB Component Side



ANNEX A EUT PHOTOGRAPHS / DIAGRAMS

EUT PHOTOGRAPHS – ANTENNA UNIT

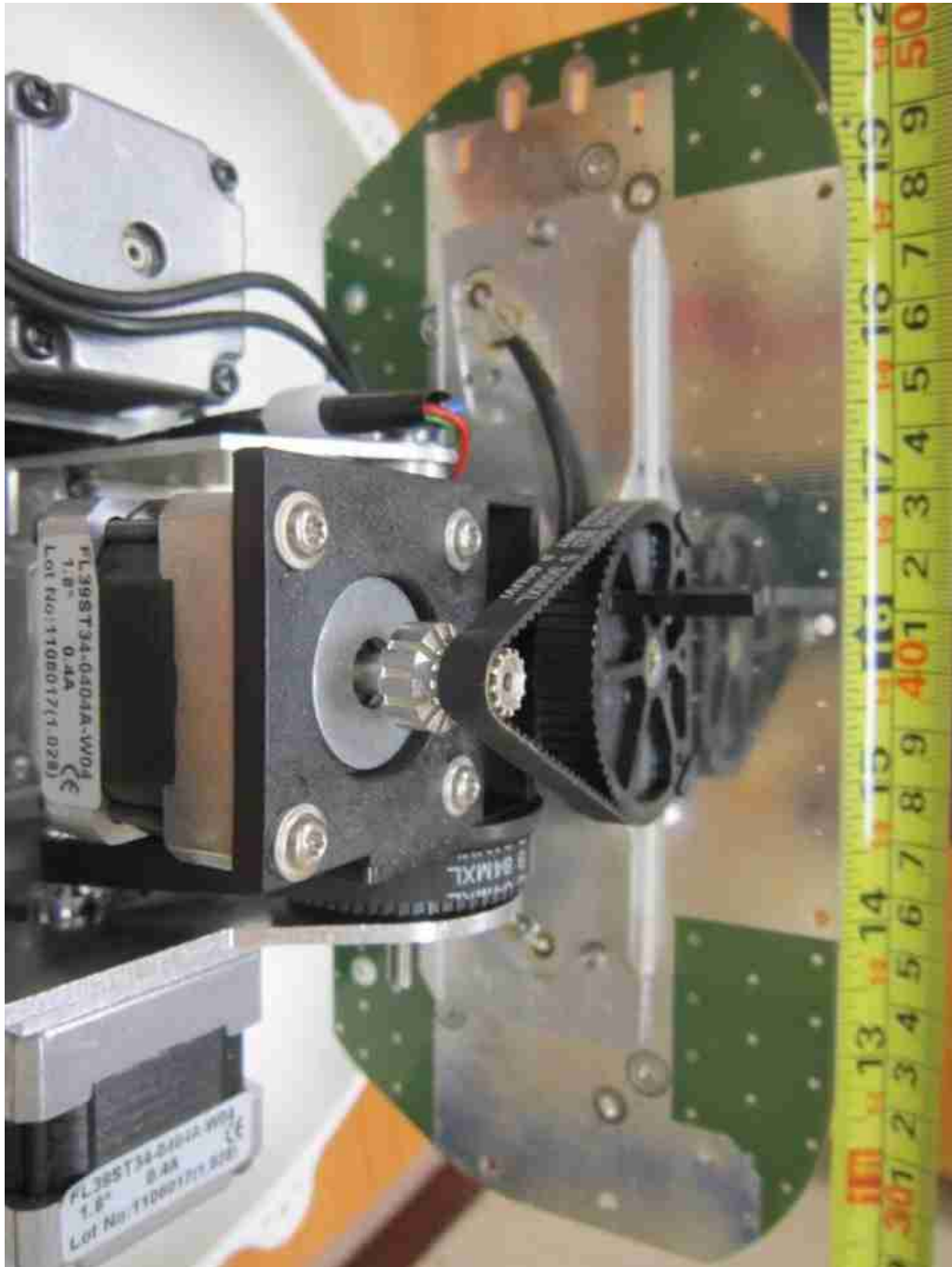

Antenna Board PCB Trace Side

ANNEX A EUT PHOTOGRAPHS / DIAGRAMS

EUT PHOTOGRAPHS – ANTENNA UNIT



RF ATC Board PCB Component Side



ANNEX A EUT PHOTOGRAPHS / DIAGRAMS

EUT PHOTOGRAPHS – ANTENNA UNIT



RF ATC Board PCB Component Side

ANNEX A EUT PHOTOGRAPHS / DIAGRAMS

EUT PHOTOGRAPHS – MAIN UNIT



Internal View 1



ANNEX A EUT PHOTOGRAPHS / DIAGRAMS

EUT PHOTOGRAPHS – MAIN UNIT

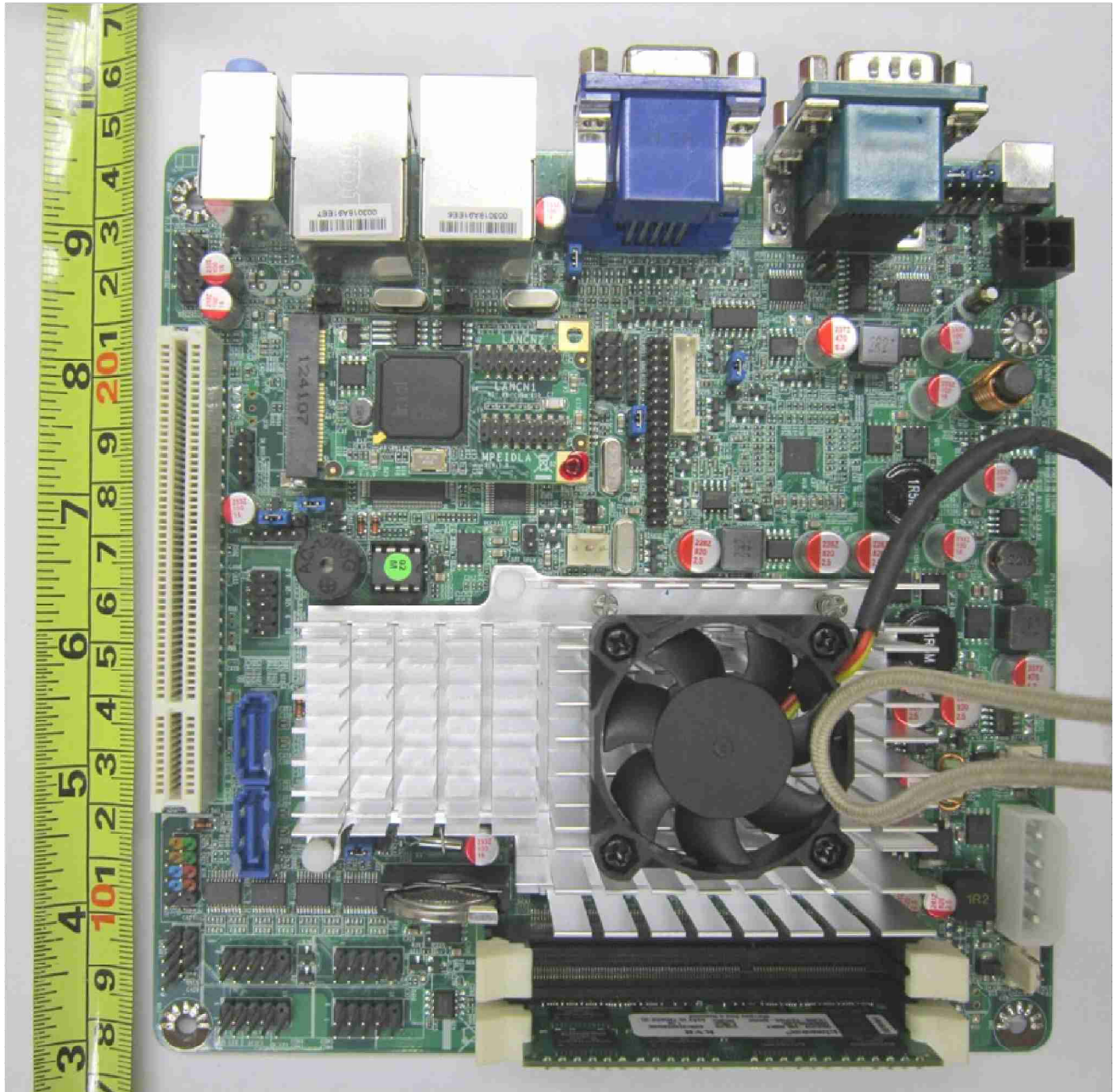

Mother-Board PCB Component Side

ANNEX A EUT PHOTOGRAPHS / DIAGRAMS

EUT PHOTOGRAPHS – MAIN UNIT



Mother-Board PCB Trace Side

ANNEX A EUT PHOTOGRAPHS / DIAGRAMS

EUT PHOTOGRAPHS – MAIN UNIT

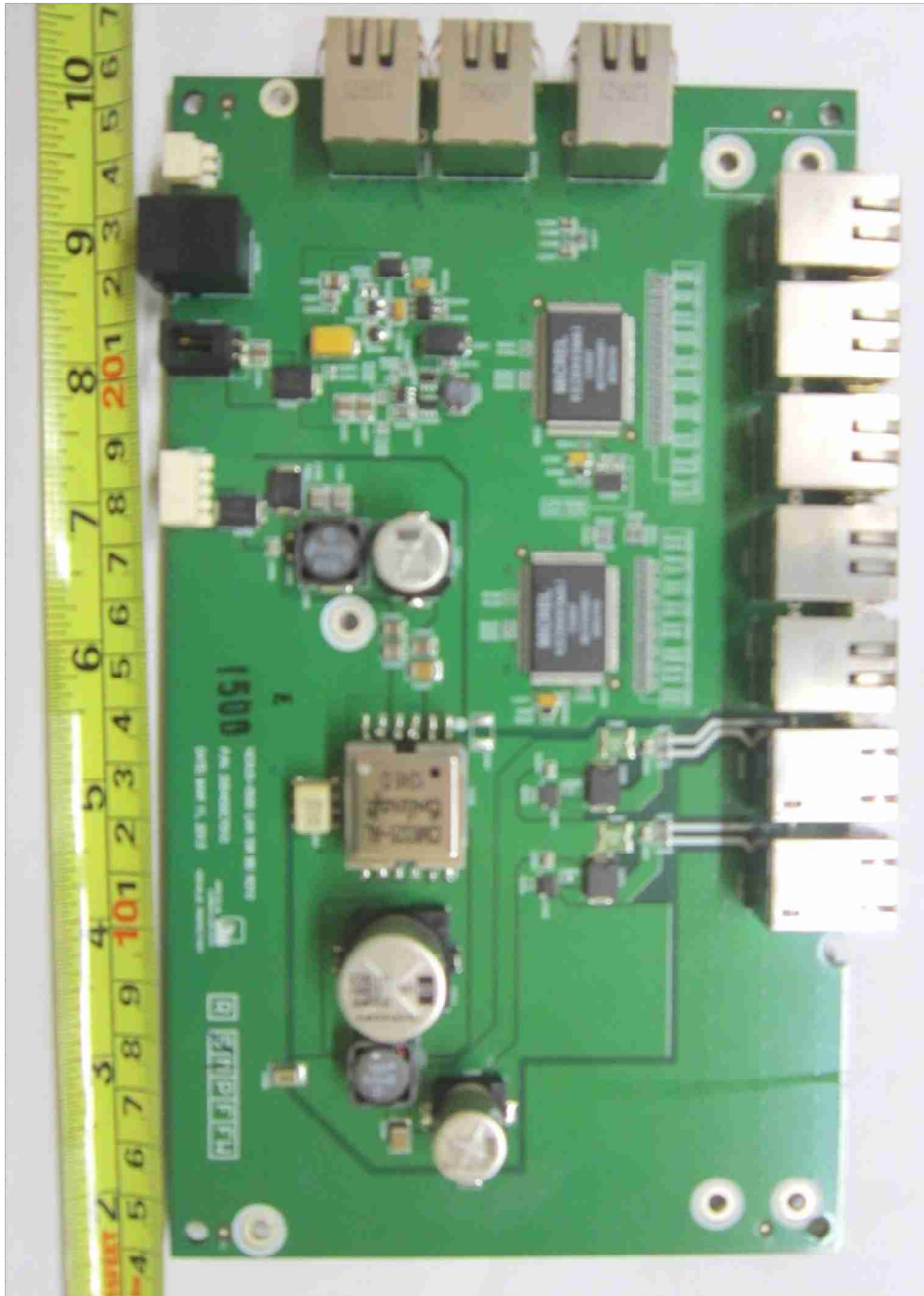

LAN Switch PCB Component Side



ANNEX A EUT PHOTOGRAPHS / DIAGRAMS

EUT PHOTOGRAPHS – MAIN UNIT

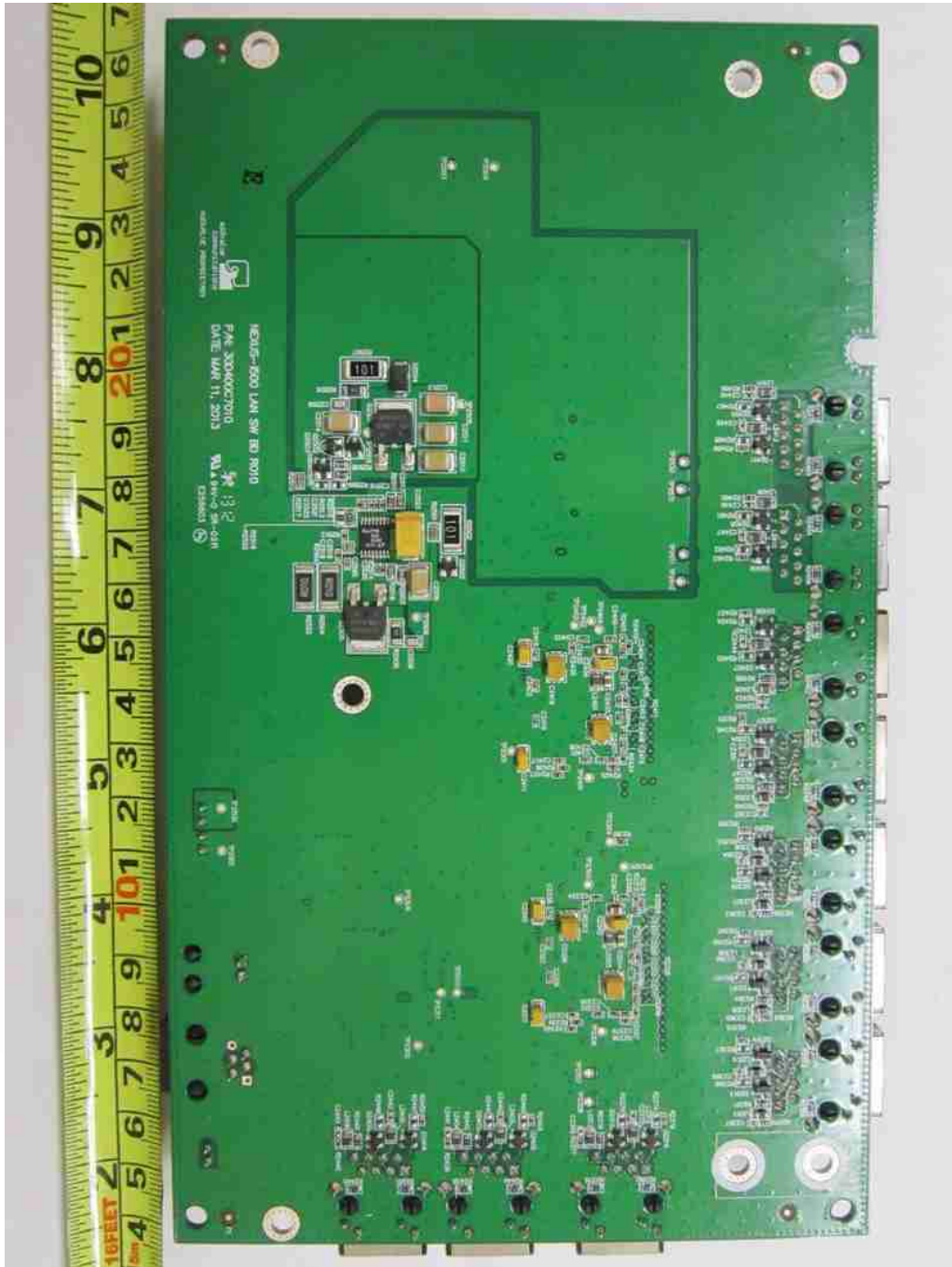

LAN Switch PCB Trace Side



ANNEX A EUT PHOTOGRAPHS / DIAGRAMS

EUT PHOTOGRAPHS – MAIN UNIT

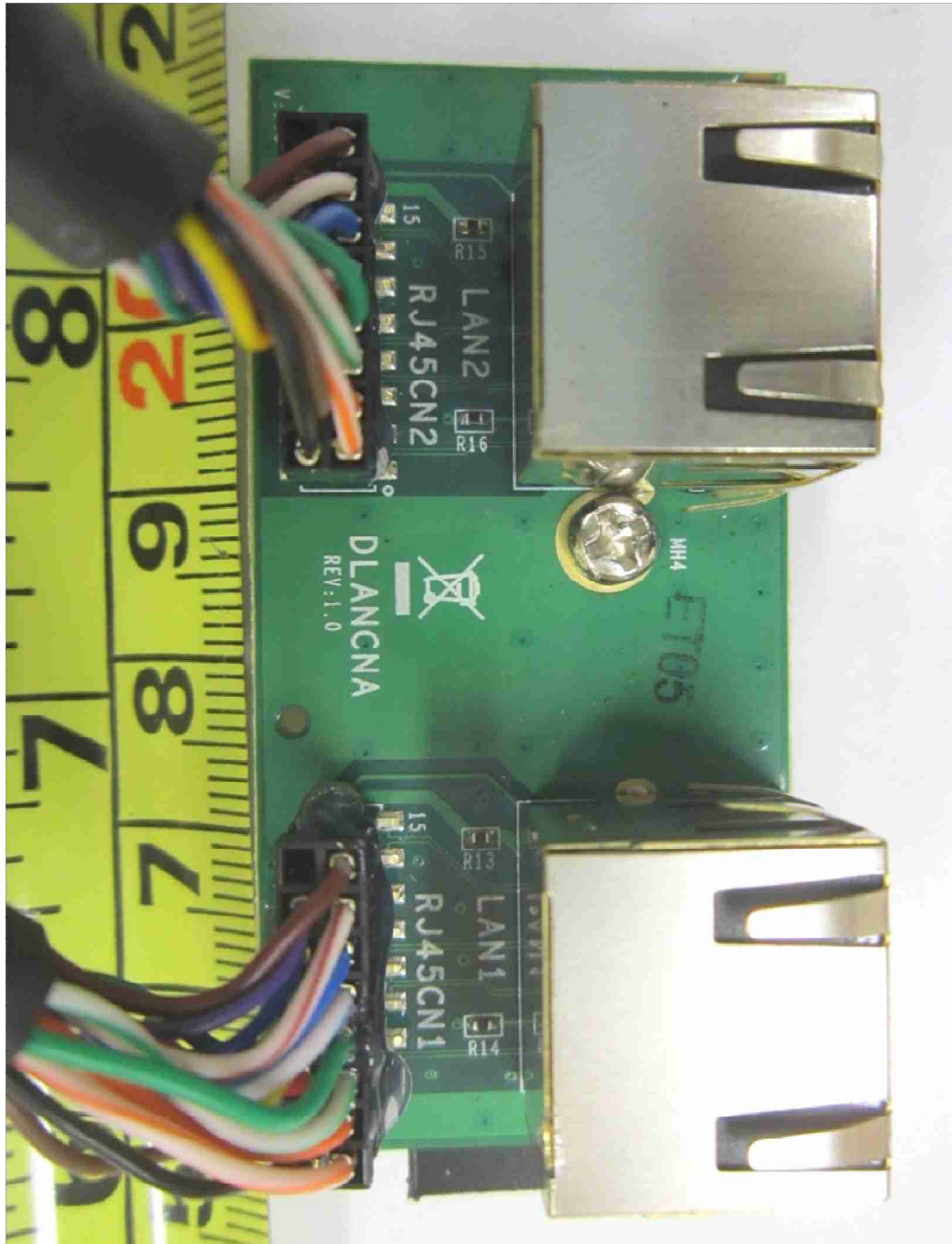

2-LAN Port PCB Component Side

**ANNEX A EUT PHOTOGRAPHS / DIAGRAMS**

**EUT PHOTOGRAPHS – MAIN UNIT**

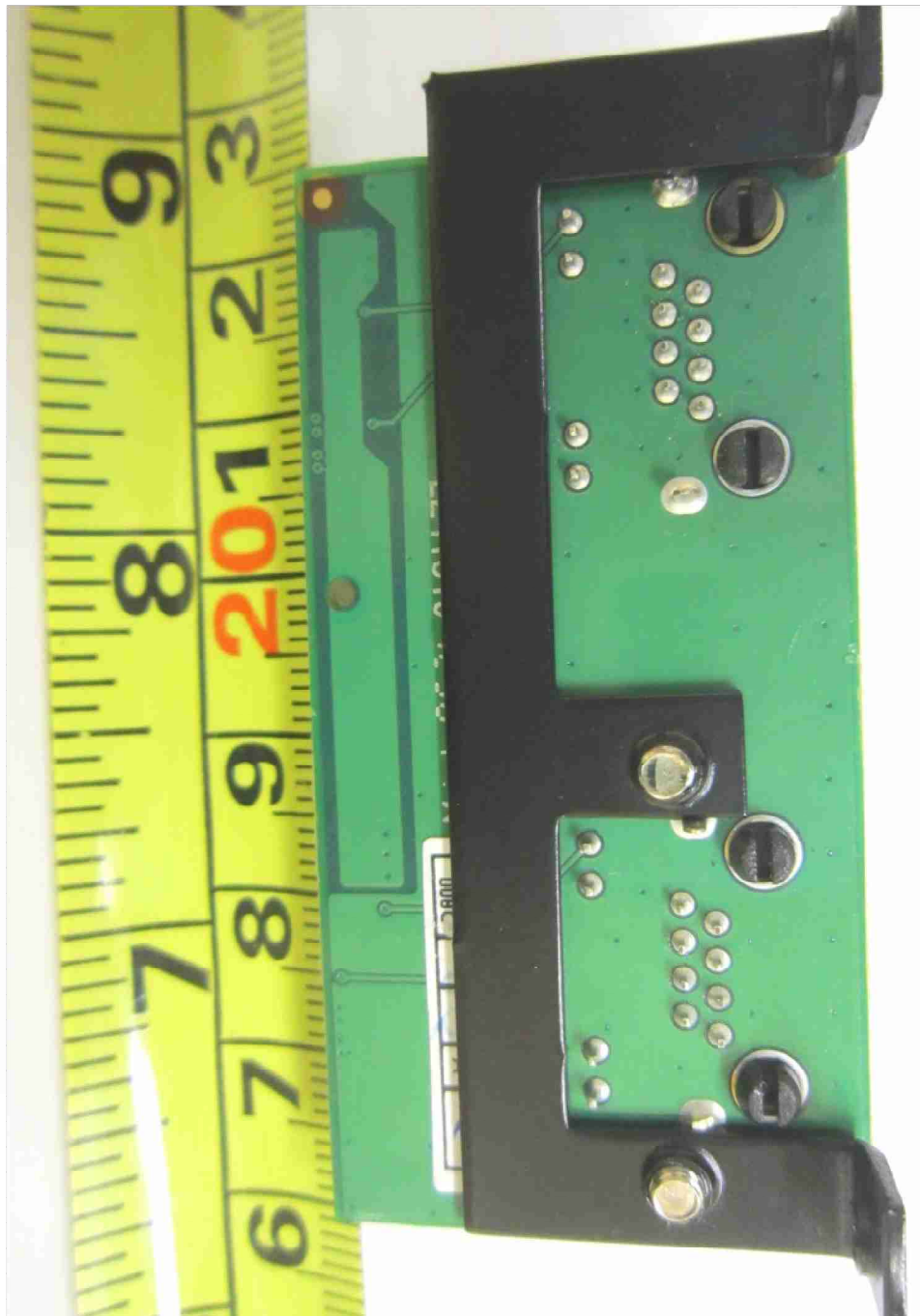

**2-LAN Port PCB Trace Side**

ANNEX A EUT PHOTOGRAPHS / DIAGRAMS

EUT PHOTOGRAPHS – MAIN UNIT

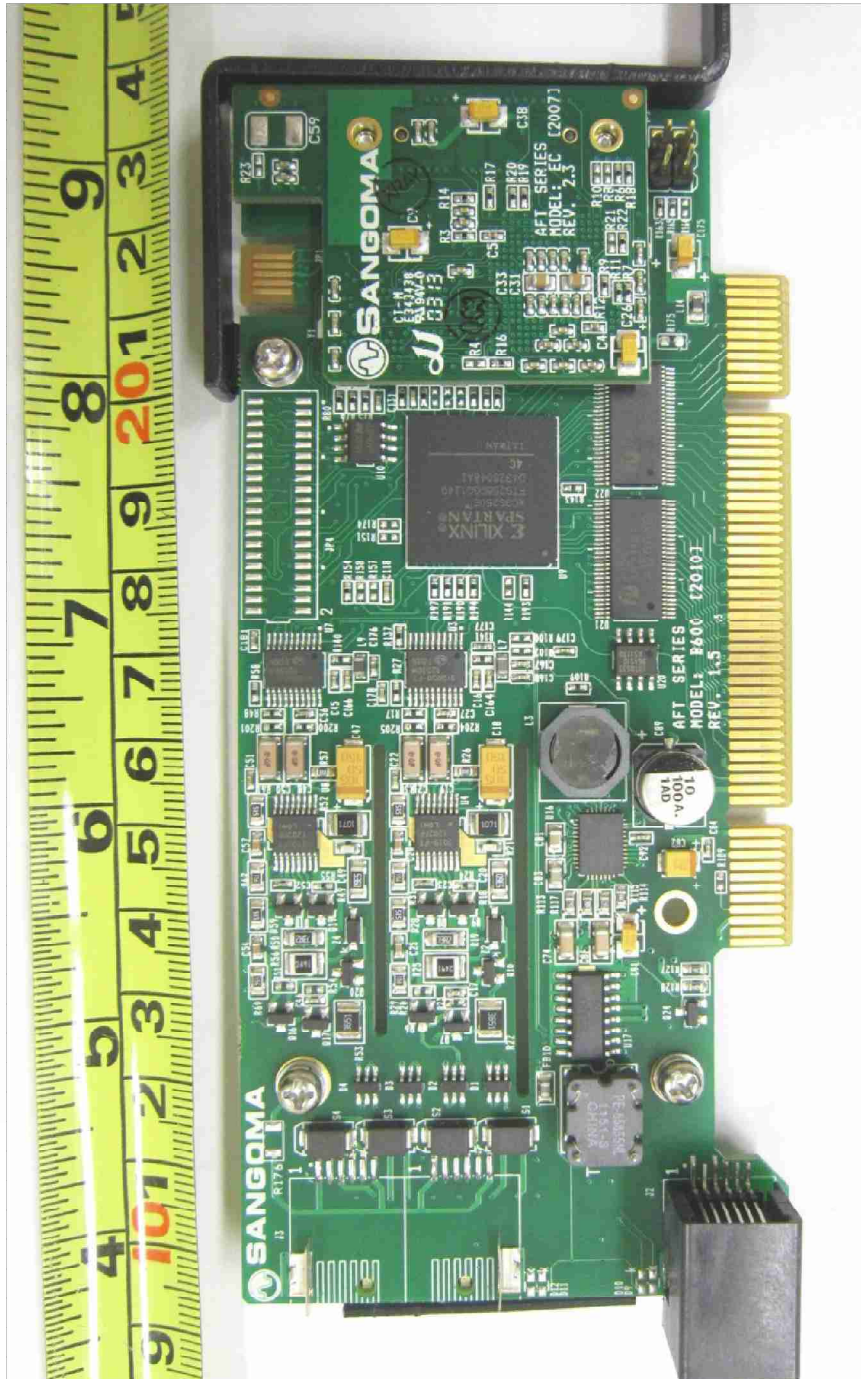

Analog Voice Card PCB Component Side



ANNEX A EUT PHOTOGRAPHS / DIAGRAMS

EUT PHOTOGRAPHS – MAIN UNIT

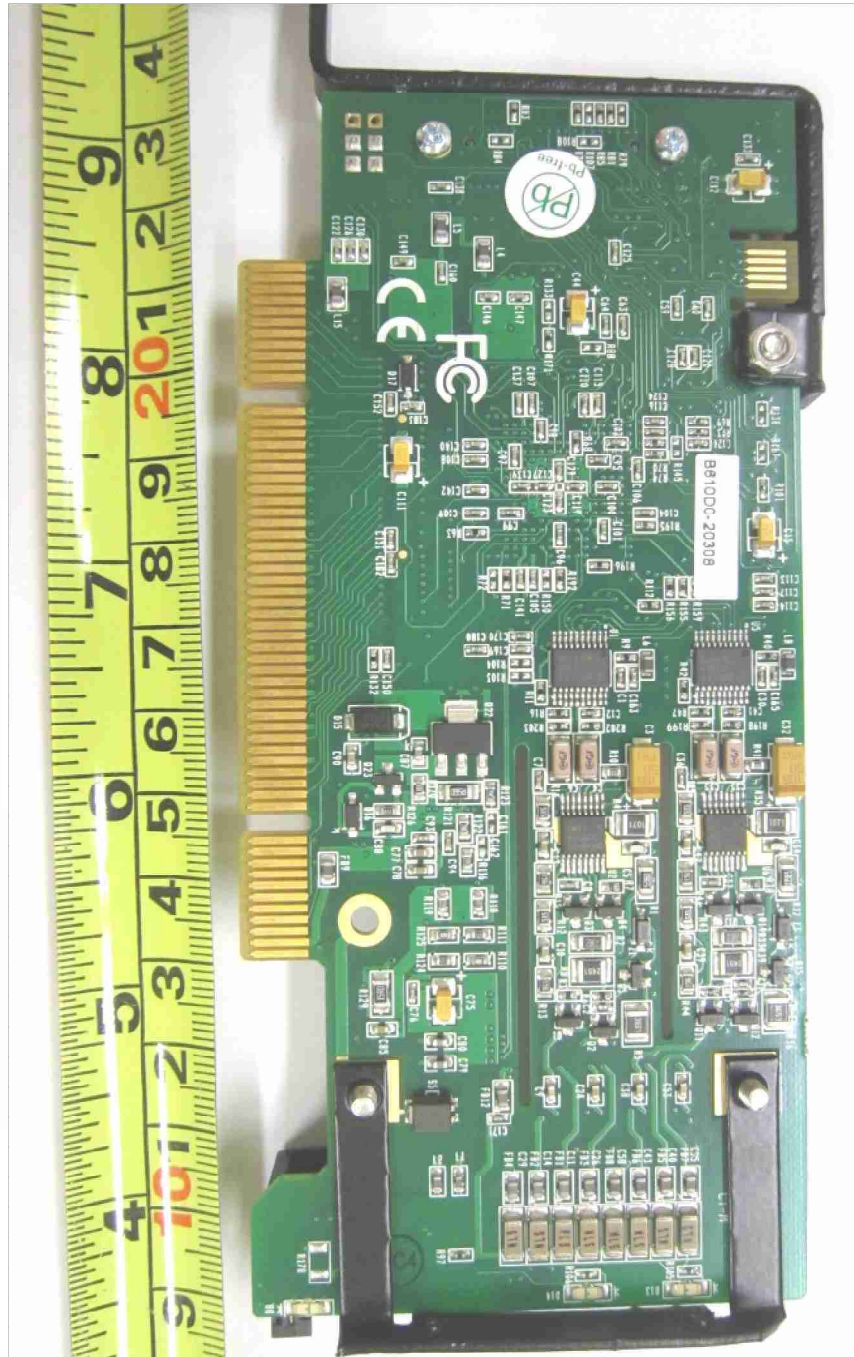

Analog Voice Card PCB Trace Side

ANNEX A EUT PHOTOGRAPHS / DIAGRAMS

EUT PHOTOGRAPHS – MAIN UNIT

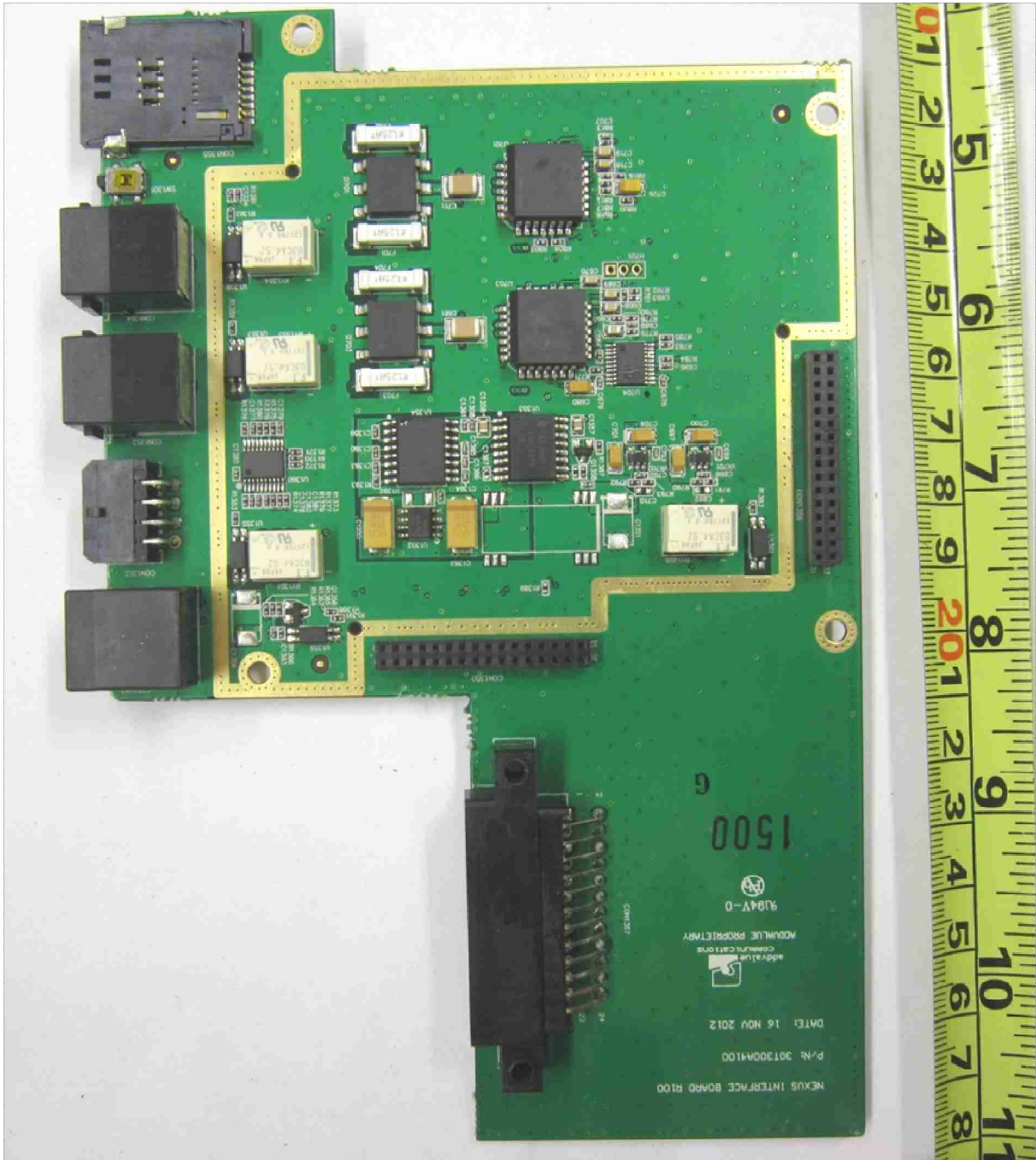

Interface Board PCB Component Side

ANNEX A EUT PHOTOGRAPHS / DIAGRAMS

EUT PHOTOGRAPHS – MAIN UNIT



Interface Board PCB Trace Side



ANNEX A EUT PHOTOGRAPHS / DIAGRAMS

EUT PHOTOGRAPHS – MAIN UNIT

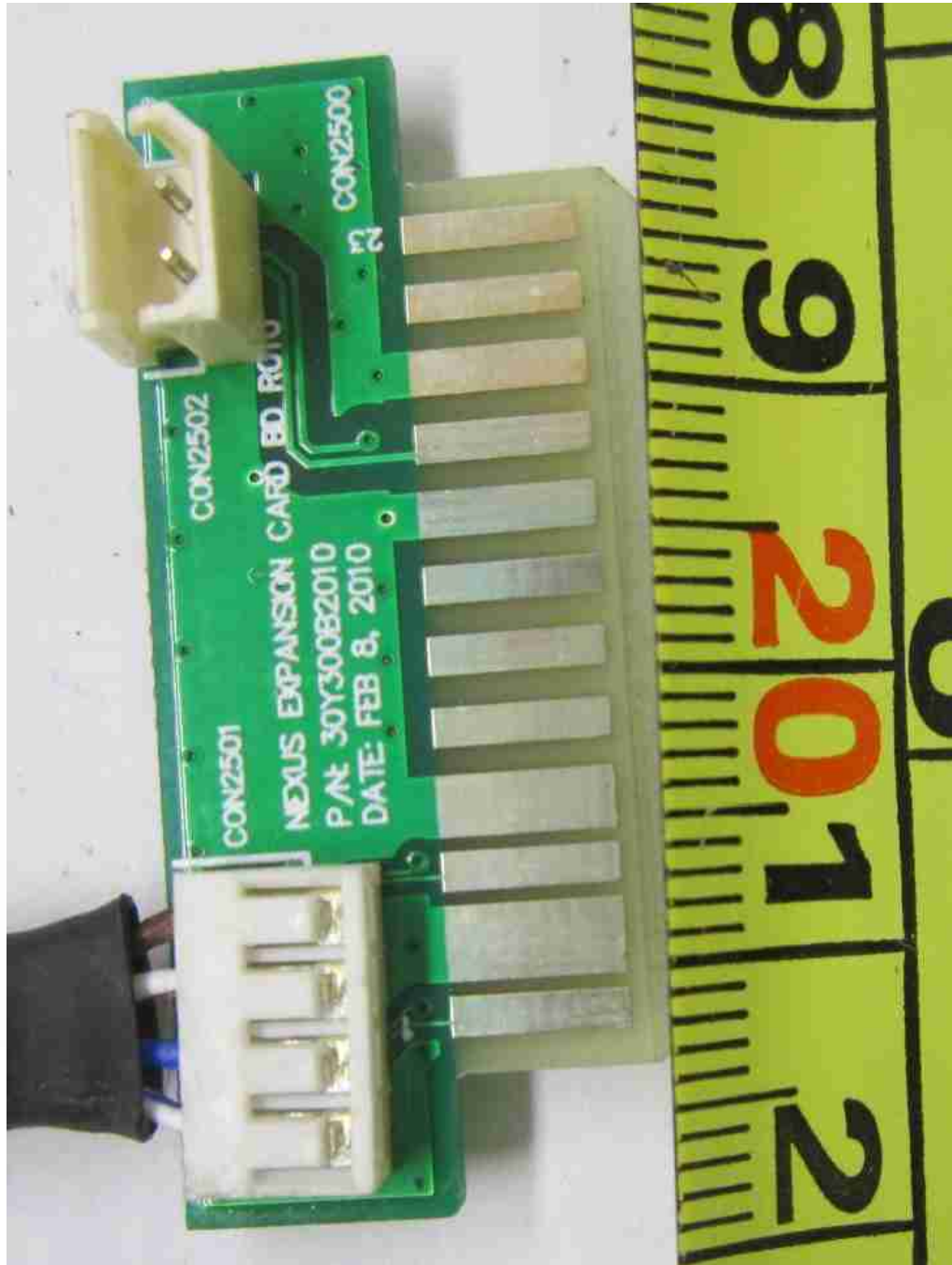

Adapter Board PCB Component Side

ANNEX A EUT PHOTOGRAPHS / DIAGRAMS

EUT PHOTOGRAPHS – MAIN UNIT



Adapter Board PCB Trace Side

ANNEX A EUT PHOTOGRAPHS / DIAGRAMS

EUT PHOTOGRAPHS – MAIN UNIT

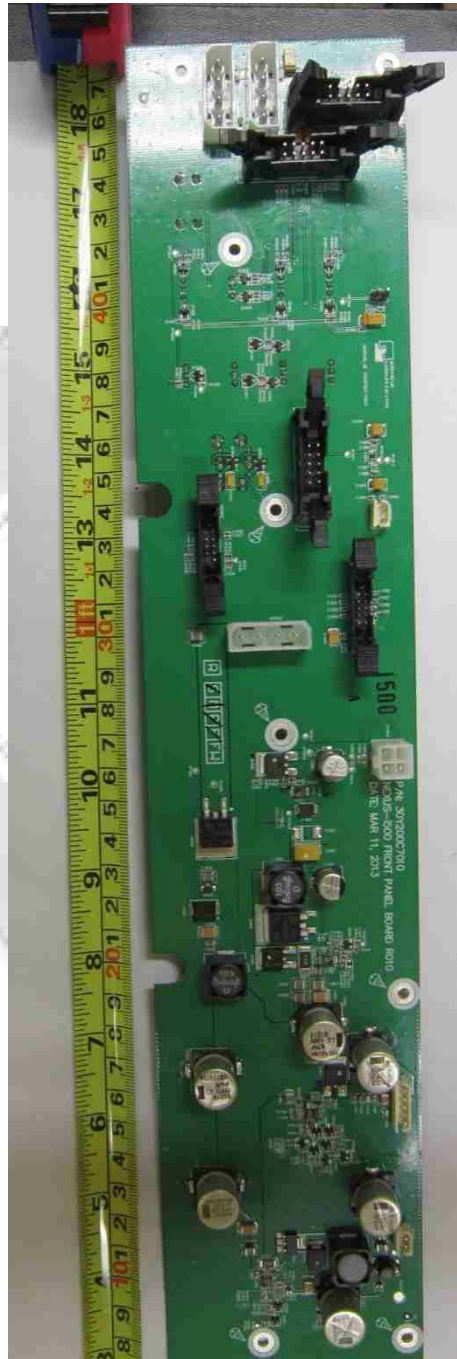

Front Panel PCB Component Side

ANNEX A EUT PHOTOGRAPHS / DIAGRAMS

EUT PHOTOGRAPHS – MAIN UNIT



Front Panel PCB Trace Side



ANNEX A EUT PHOTOGRAPHS / DIAGRAMS

EUT PHOTOGRAPHS – MAIN UNIT

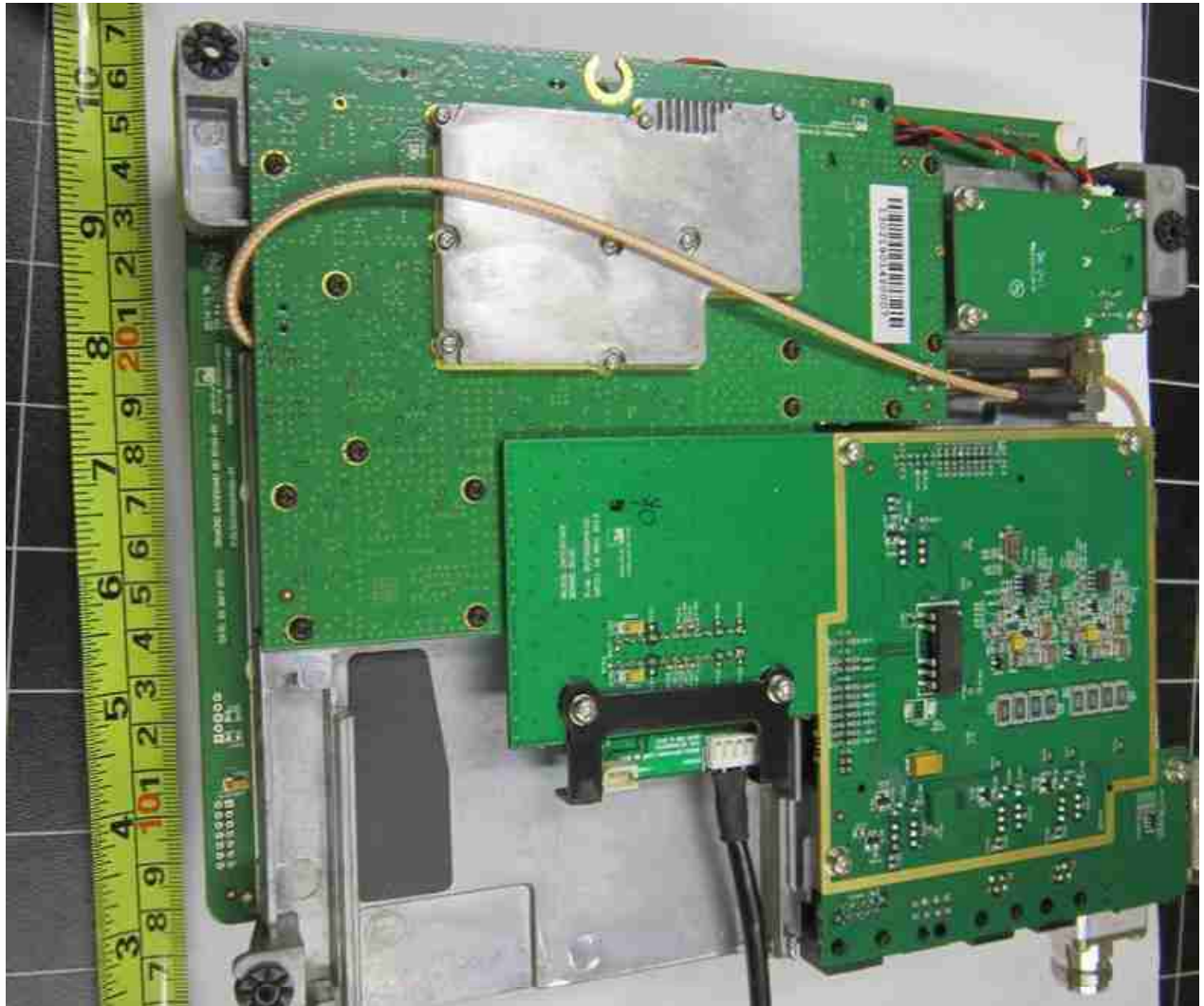

FBB Core Module Internal

ANNEX A EUT PHOTOGRAPHS / DIAGRAMS

EUT PHOTOGRAPHS – MAIN UNIT

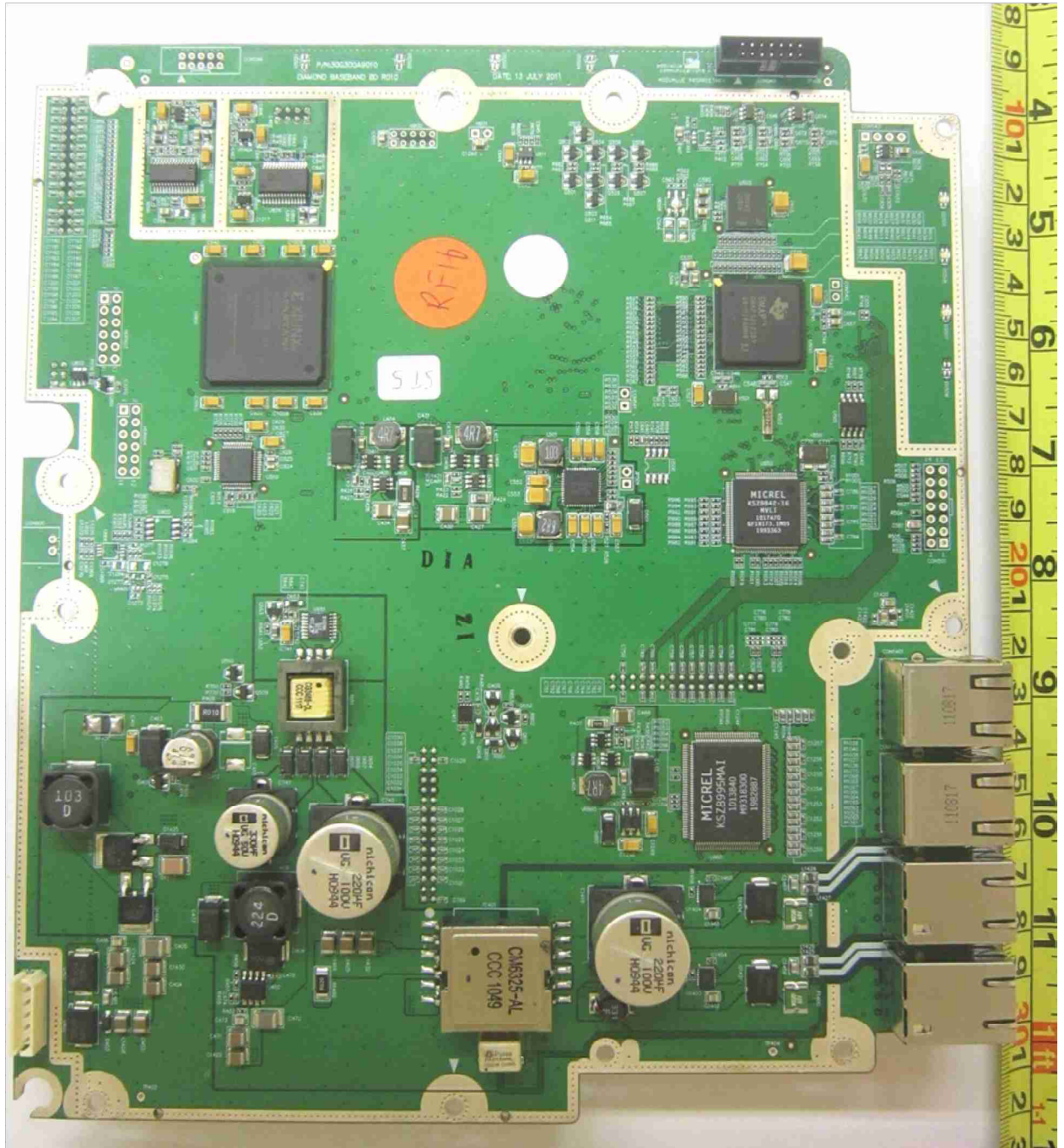

FBB Core Module Baseband PCB Component Side



ANNEX A EUT PHOTOGRAPHS / DIAGRAMS

EUT PHOTOGRAPHS – MAIN UNIT

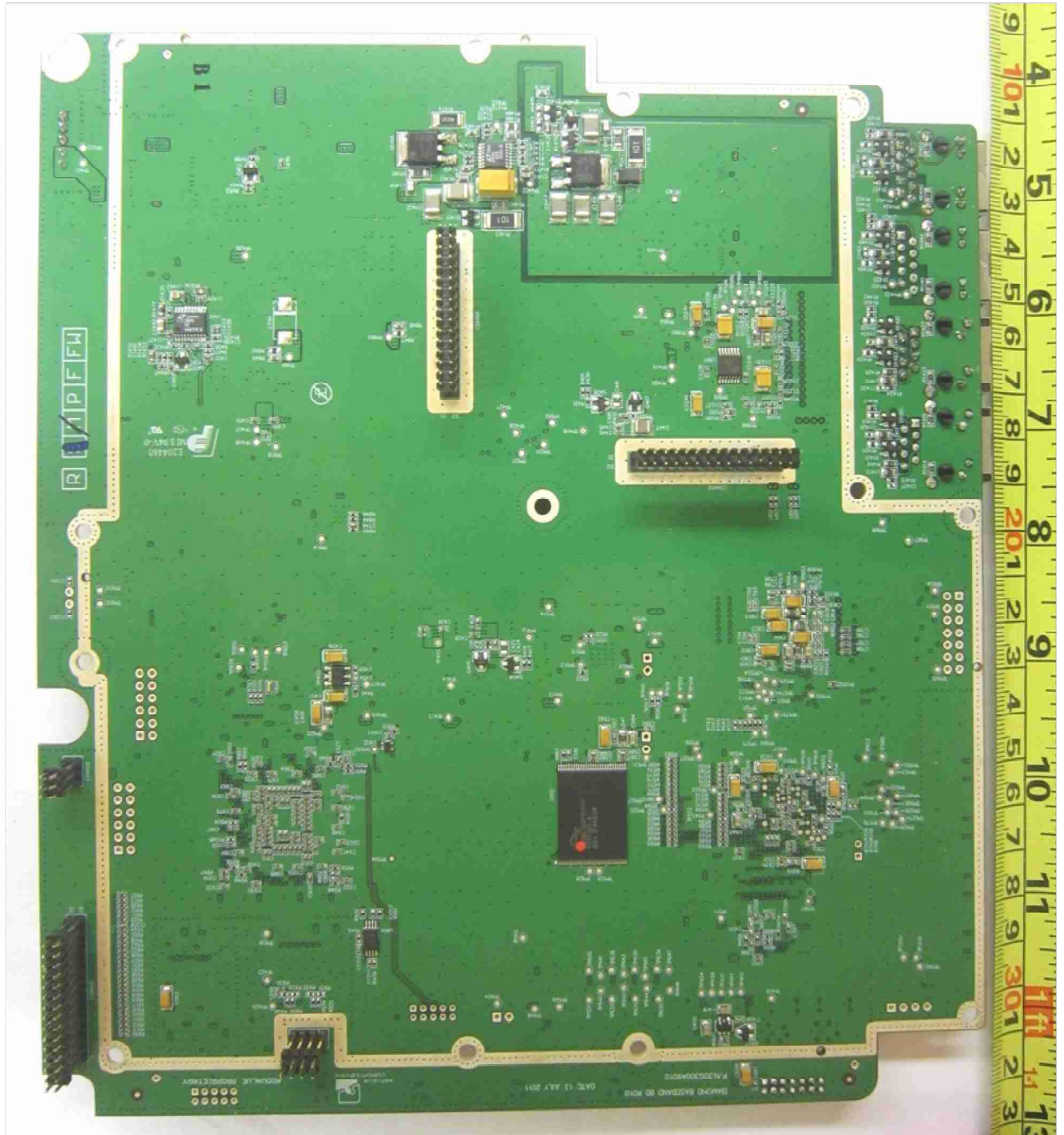

FBB Core Module Baseband PCB Trace Side

**ANNEX A EUT PHOTOGRAPHS / DIAGRAMS**

**EUT PHOTOGRAPHS – MAIN UNIT**

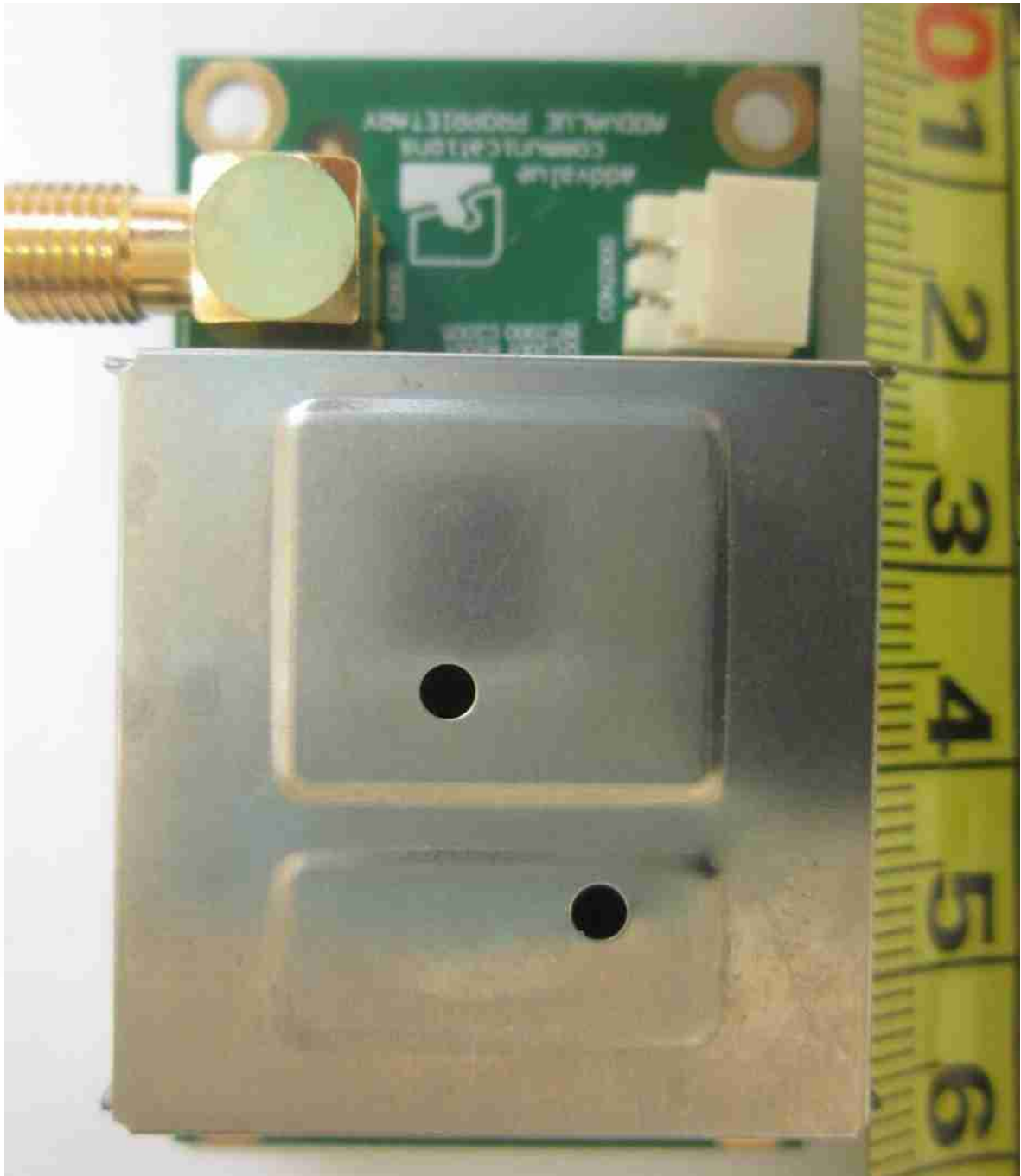

**FBB Core Module Crystal Board PCB Component Side**

ANNEX A EUT PHOTOGRAPHS / DIAGRAMS

EUT PHOTOGRAPHS – MAIN UNIT



FBB Core Module Crystal Board PCB Trace Side



ANNEX A EUT PHOTOGRAPHS / DIAGRAMS

EUT PHOTOGRAPHS – MAIN UNIT

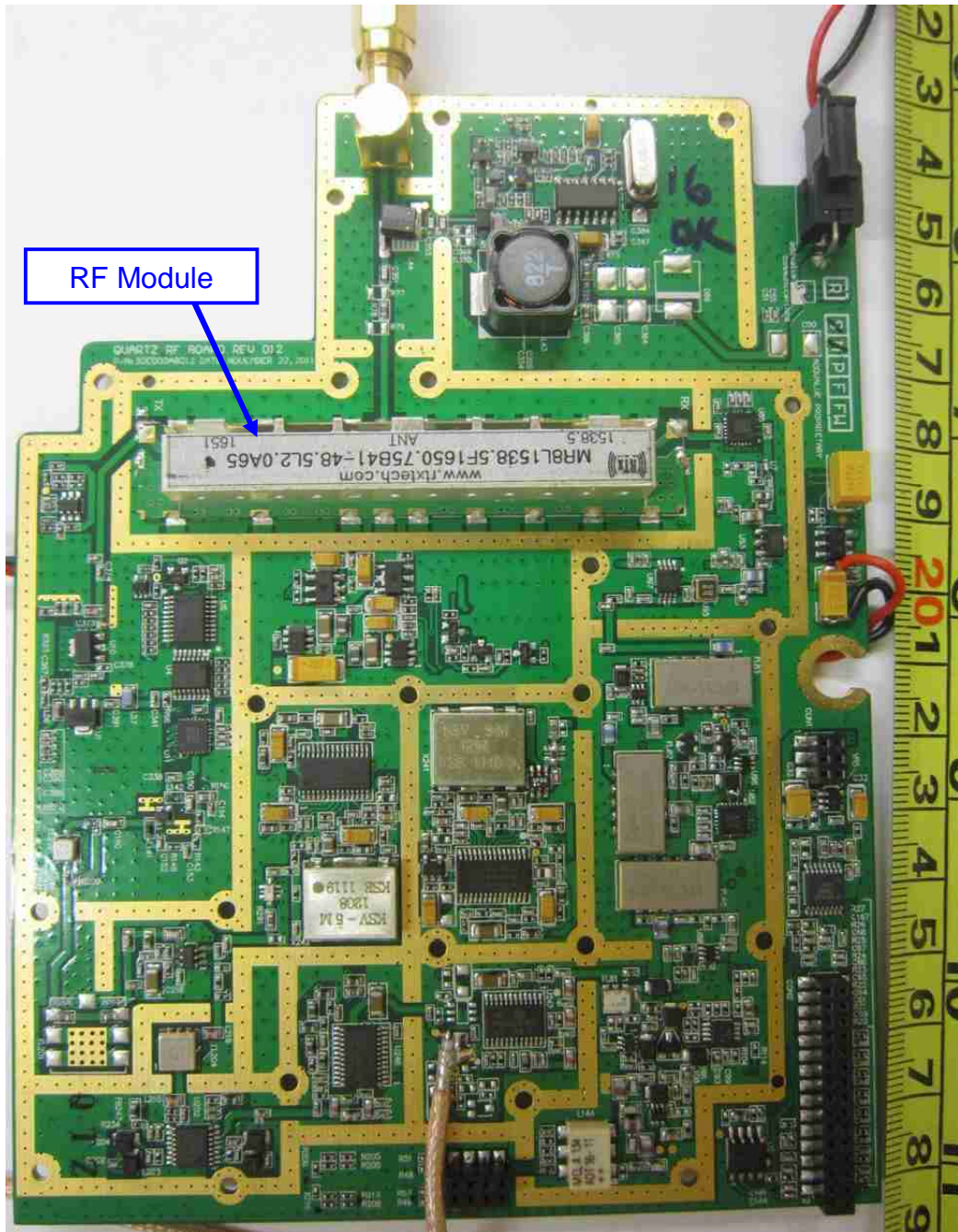

FBB Core Module RF Module PCB Component Side

ANNEX A EUT PHOTOGRAPHS / DIAGRAMS

EUT PHOTOGRAPHS – MAIN UNIT

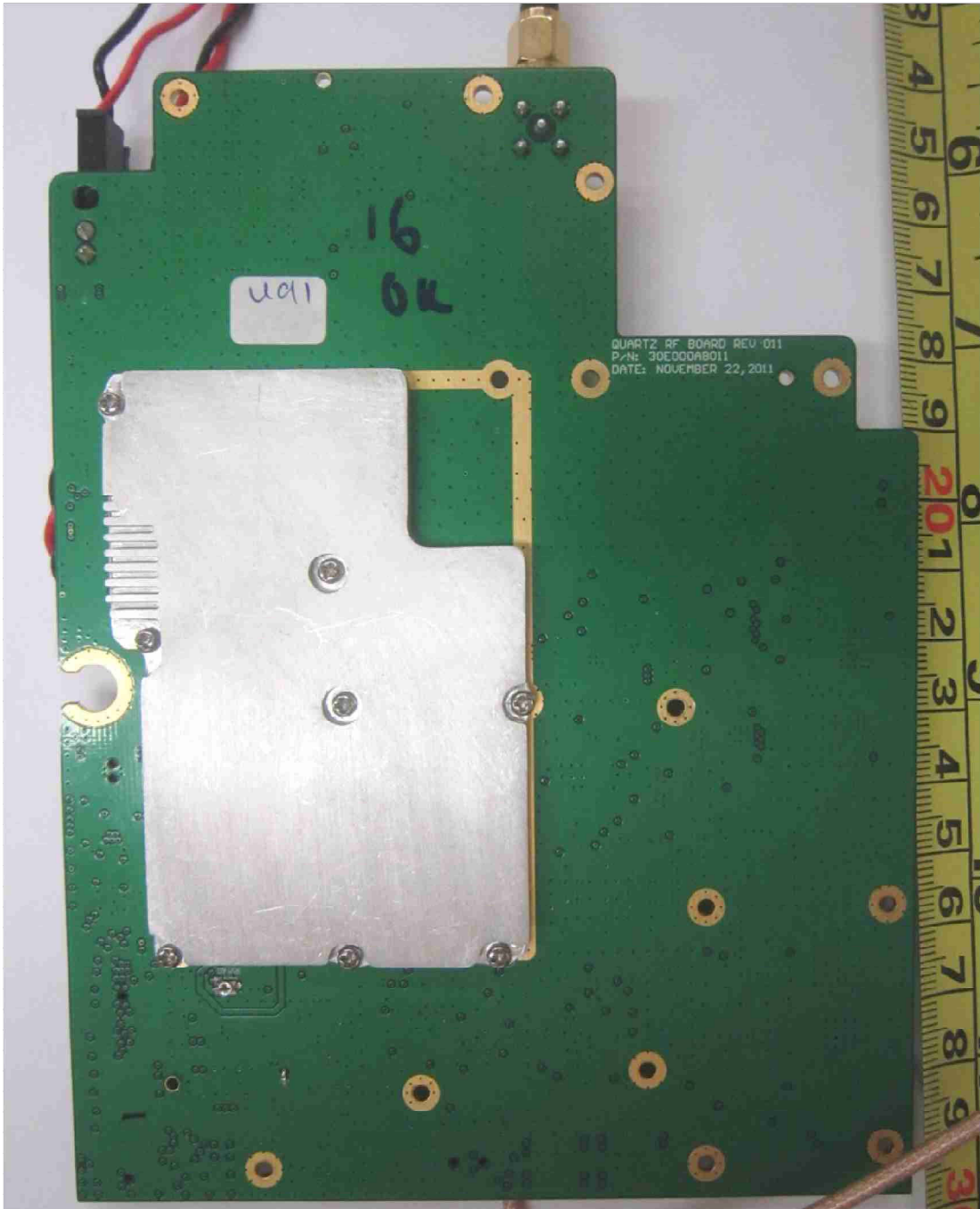

FBB Core Module RF Module PCB Trace Side

ANNEX A EUT PHOTOGRAPHS / DIAGRAMS

EUT PHOTOGRAPHS – MAIN UNIT

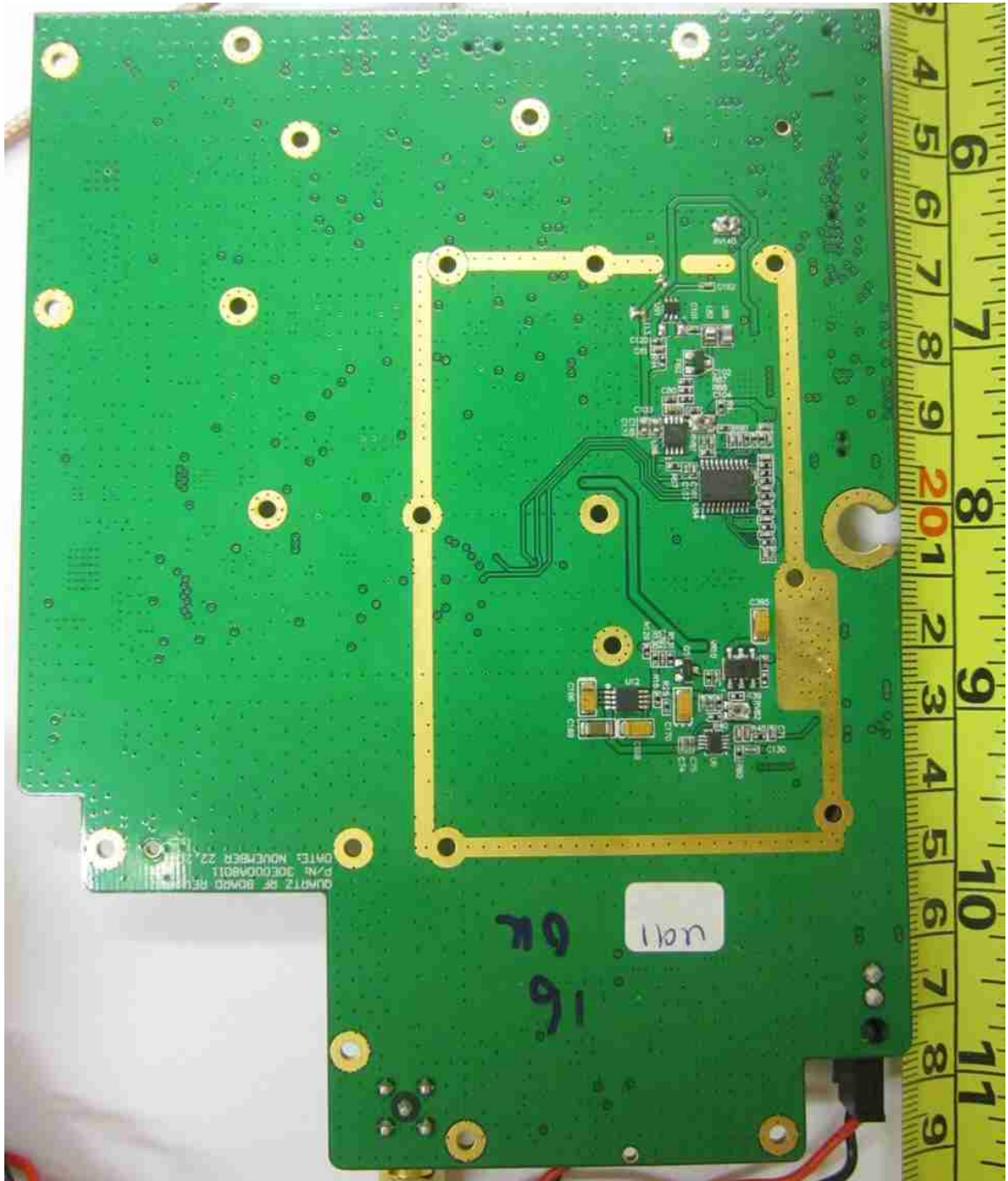

FBB Core Module RF Module Circuit with RF Shield Removed



ANNEX A EUT PHOTOGRAPHS / DIAGRAMS

EUT PHOTOGRAPHS – MAIN UNIT



Power Supply Unit Front View



Power Supply Unit Rear View

ANNEX A EUT PHOTOGRAPHS / DIAGRAMS

EUT PHOTOGRAPHS – MAIN UNIT



Solid State Drive



**ANNEX B USER MANUAL TECHNICAL DESCRIPTION BLOCK & CIRCUIT DIAGRAMS**

---

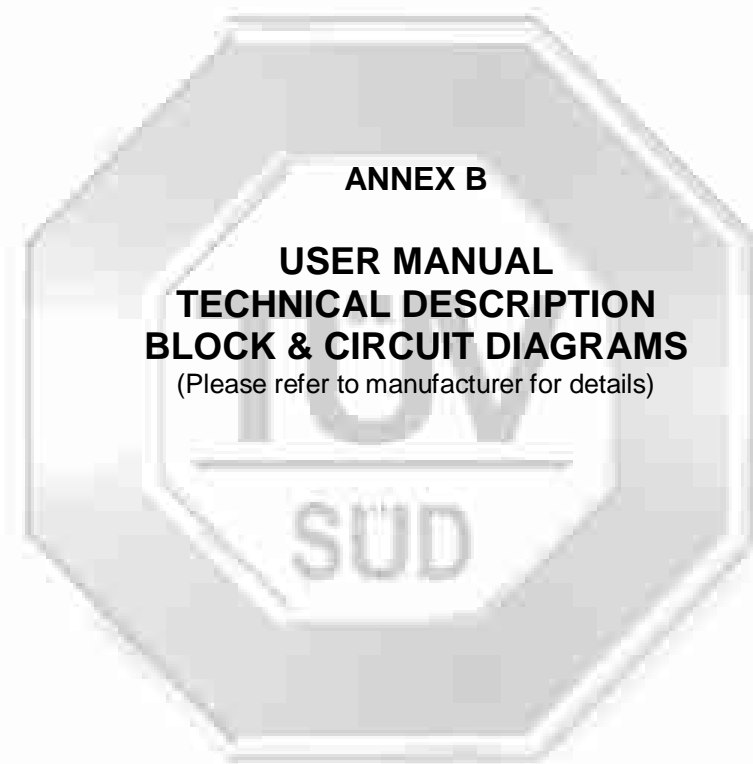



**ANNEX C FCC LABEL & POSITION**

---



**ANNEX C FCC LABEL & POSITION**

Labelling requirements per Section 2.925 & 15.19

The label shown will be permanently affixed at a conspicuous location on the device and be readily visible to the user at the time of purchase.



**SCALE 200%**  
Sample Label

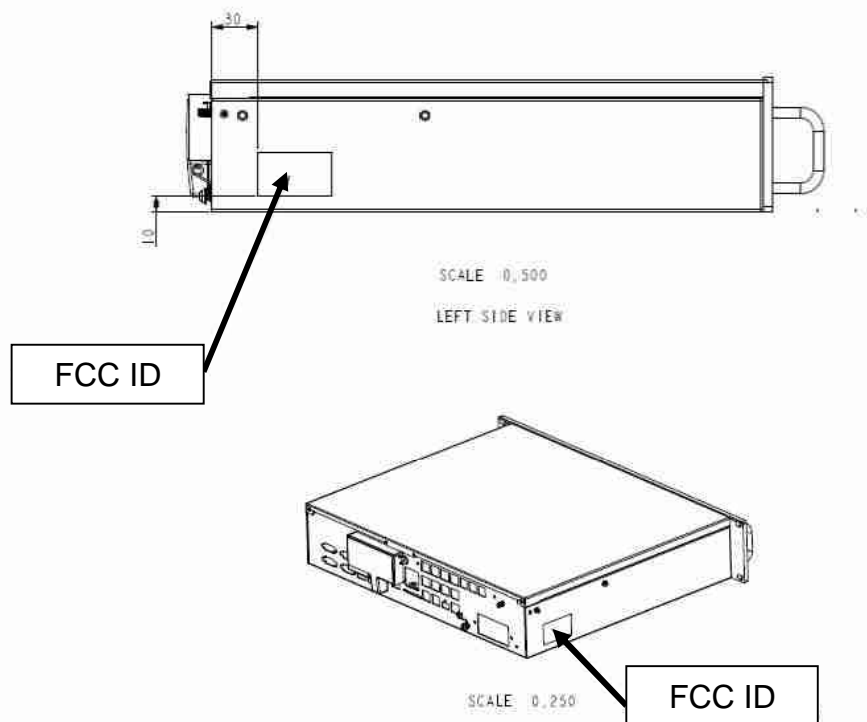

**Physical Location of FCC Label on EUT**