

MultiTel 2
915 MHz

e l e r o



EN

Operating instructions

Keep the operating instructions in a safe place!

182030031_US_0514



Translation from the original German version.

All other documents in different languages are translations of the original version.

All rights reserved in the event of registration of patents, working models or design patents.

Contents

1	General information	5
1.1	Notes on the operating instructions	5
1.2	Standards and Directives	5
1.3	Intended use	6
1.4	Predictable misuse	6
1.5	Warranty and liability	7
1.6	Manufacturer's customer service	7
2	Safety	8
2.1	General safety instructions	8
2.2	Safety principles	8
2.3	General obligations of the operator	9
2.4	Requirements for personnel	10
2.5	Safety instructions for the technical status	10
2.6	Safety instructions for operation	11
3	Product description	11
3.1	General information	11
3.2	Device explanation	12
3.3	Product types	13
3.4	Technical data	13
4	Operation	15
4.1	Bidirectional radio system	15
4.2	Initial operation	15
4.3	Power supply	16
4.4	Operating mode	16
4.5	Menu mode	24
4.6	Programming the transmitter	32
4.7	Changing the batteries	40
4.8	Cleaning and care of the device	40

5	US Declaration of conformity	41
6	Troubleshooting	42
7	Repair	43
8	Address	43
9	Disposal	44

1 General information

1.1 Notes on the operating instructions

The contents are arranged by the life phases of the MultiTel 2 radio remote control (referred to below as the "device").

The manufacturer reserves the right to make changes to the technical data in the operating instructions. They may differ from the actual model of the device without fundamentally changing the basic information and losing validity. The current status of the technical data can be requested from the manufacturer at any time. Claims based on the above will not be accepted. Deviations from statements in the text and illustrations are possible and will depend on the technical development, equipment and accessories of the device. The manufacturer will provide information on special models with the sales documentation. Other information will remain unaffected by the above.

1.2 Standards and Directives

The basic occupational health and safety requirements of the applicable laws, standards and directives have been incorporated into the design. The safety of the device is confirmed by the declaration of conformity (see Chapter 5, EC Declaration of Conformity). All information on safety in the operating instructions are based on the current laws and regulations applicable in Germany. All information in the operating instructions must be observed at all times. In addition to the safety instructions in the operating instructions the regulations for accident prevention, environmental protection and occupational health and

safety applicable at the place of use must be observed and complied with. Regulations and standards for risk assessment can be found in the EC declaration of conformity.

1.3 Intended use

The device is intended for use in the field of building technology (for controlling electrically operated roller shutters, awnings, venetian blinds, roller blinds, electric lighting and electric heaters). It is a multichannel radio hand-held transmitter. Any other uses must be discussed beforehand with the manufacturer, elero GmbH Antriebstechnik (see Chapter 8, Address).

The operator will be solely responsible for any damage arising from use of the device that is not in conformity with the intended use. The manufacturer does not accept any liability for personal injury and property damage caused by misuse or process errors, improper operation and commissioning.

Conformity with the intended use as specified in the operating instructions is the only guarantee of safe and error-free use and the operational safety of the device.

1.4 Predictable misuse

Predictable misuse is considered use that is not in accordance with the purposes approved by the manufacturer, elero GmbH Antriebstechnik (for address see Chapter 8, Address).

1.5 Warranty and liability

The General Terms of Supply and Delivery of the manufacturer, elero GmbH Antriebstechnik (for address see Chapter 8, Address) are applicable. The terms and conditions of sale and delivery are a component of the sales documentation and are handed over to the operator on delivery. Liability claims in the event of personal injury and property damage will not be accepted if they are the result of one or more of the following causes:

- Device opened by the customer (breakage of seal)
- Improper use of the device
- Incorrect installation, commissioning or operation of the device
- Structural modifications to the device without approval in writing by the manufacturer
- Operation of the device with incorrectly installed connections, defective safety equipment or incorrectly installed safety and protective equipment
- Non-observance of the occupational health and safety regulations and instructions in the operating instructions
- Exceeding the specified technical data

1.6 Manufacturer's customer service

The device must be repaired by the manufacturer only if it needs repair. See Chapter 8 "Address" for where to send the device to customer service for repair.

If you did not purchase the device directly from elero, contact the supplier of the device.

Have the serial number ready for the customer service. It is on the name plate on the back of the device.



2 Safety

2.1 General safety instructions

The operating instructions contain all safety instructions that must be observed to avoid and prevent dangers arising from using the device in combination with the motors and components that it controls in its various life cycles. The device is guaranteed for safe use if all safety instructions are observed.

2.2 Safety principles

The device is designed and constructed in accordance with the state of the art and accepted safety technical rules and is inherently safe. The basic occupational health and safety requirements of the applicable laws, standards and directives have been incorporated into the design of the device. The safety of the device is confirmed by declaration of incorporation.

All information on safety is based on the currently valid regulations of the European Union. In other countries the operator must ensure compliance with the applicable laws and national regulations.

In addition to the safety instructions in the operating instructions the generally applicable regulations for accident prevention, environmental protection and occupational health and safety applicable at the place of use must be observed and complied with.

The device may be used only if it is in good technical condition and used safely in conformity with the regulations and in awareness of possible hazards as directed by the operating instructions. The device is designed for use as specified in the chapter on "Proper use". Improper use

of the device may result in danger for life and limb of the user or other persons and damage to the device and other property. Accidents or near-accidents when using the device, which could cause or may have caused injury to persons and/or damage in the vicinity, must be reported directly to the manufacturer without delay.

All safety instructions on the device and in the operating instructions must be observed at all times. In addition to the safety instructions, the operator must ensure compliance with all applicable national and international regulations and additional applicable regulations regarding operational safety, accident prevention and environmental protection. Only trained technicians qualified to work safely and authorized are permitted to carry out any work on the device.

2.3 General obligations of the operator

- The operator is required to use the device only if it is good and safe condition. In addition to the safety instructions in the operating instructions, the general safety and accident prevention regulations, the requirements of DIN VDE 0100 the environmental protection regulations of the country of use must be observed.
- The operator is responsible for ensuring that all work on the device is conducted by trained technicians who have been authorised and trained in safe operation.
- The operator or authorised personnel are also responsible for accident-free operation.

2.4 Requirements for personnel

- ❑ Every person authorised to work with the device must have read and understood the complete operating instructions before carrying out the appointed work. This is also applicable if the person has already worked or had training with a similar device.
- ❑ All work on the device is conducted by trained technicians who have been authorised and trained in safe operation. All operatives must be familiarised with the dangers of working with the device before starting any work with it.
- ❑ All persons are permitted to conduct only work in accordance with their qualifications. The area of responsibility of the person must be clearly defined.
- ❑ No person who is appointed to work with the device may have any physical restrictions that could temporarily or permanently reduce attention span and judgement (e.g. fatigue).
- ❑ Minors or persons under the influence of alcohol, drugs or medications are not permitted to use the device or conduct any assembly, disassembly or cleaning work.

2.5 Safety instructions for the technical status

- ❑ The operator is required to use the device only if it is good and safe condition. The technical status must conform to the legal requirements at all times.
- ❑ If hazards to persons or changes in operating characteristics are detected, the device must be taken out of service immediately and reported to the operator of the system.
- ❑ The device must not be modified, attached or converted in any way without approval by the manufacturer.

2.6 Safety instructions for operation

- ❑ The operator of the device is required to ensure that the device is in safe operating condition before commissioning.
- ❑ This is also required at regular intervals to be defined by the operator during the life of the device. The operator is responsible for inspections before starting operation.

3 Product description

3.1 General information

The device is a multichannel radio hand-held transmitter. It can be used exclusively for bidirectional data communications (compatible with the elero ProLine 2 program).

It is used to control roller shutters, venetian blinds and sunshades, for switching electrical lighting equipment and electric heaters.

3.2 Device explanation

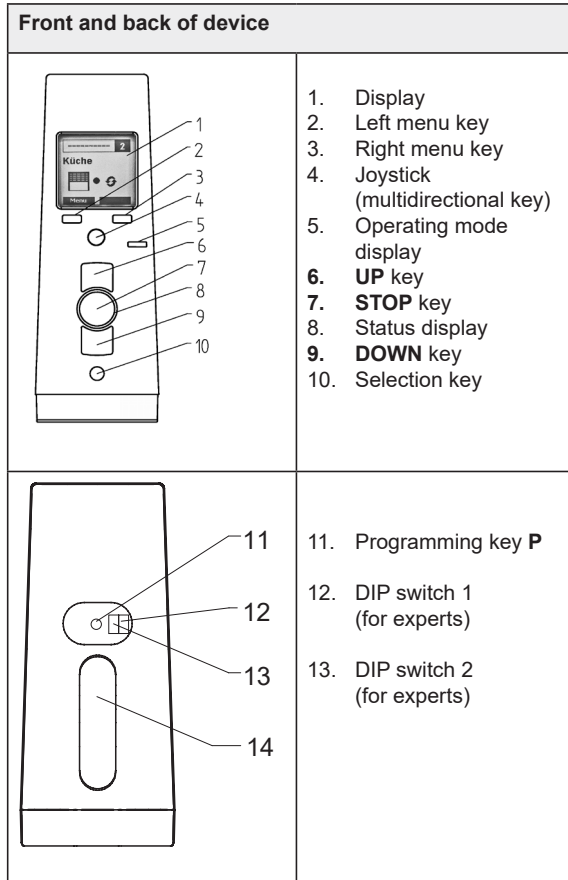

Tab. 1 Explanation of device (pictures of front and back)

3.3 Product types

The device can be supplied in different models (each within a specific frequency range: 867, 868, 915 MHz). See the order confirmation for the exact configuration of your device.

3.4 Technical data



All information in this chapter is based on an ambient temperature of 20 °C (± 5 °C).

3.4.1 Table of technical parameters

MultiTel 2 technical data	
Operating voltage	3V DC
Battery type	2 x LR06 (AA)
IP Code	IP 20
Approved ambient temperature [°C]	0 to 55
Radio frequency [MHz]	915
Emitted power [dBm]	2
Weight (incl. batteries) [g]	140
Delivery	including wall bracket

Tab. 2 MultiTel 2 technical parameters



The values of your device, which depend on the model, can be found on the name plate.

3.4.2 Mounting of the wall bracket

The wall bracket consists of a top and bottom section.

- Before installing the unit in the required position, check that the transmitter and receiver are functioning perfectly.
- Push the bracket upper and lower parts to separate them.
- Fix the bracket lower part onto the wall using the screws and dowels provided.
- Install the wall bracket where the holes are away from any electrical wires.

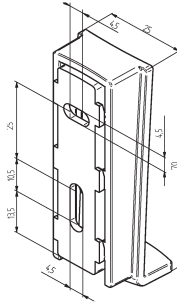

3.4.3 Product features

- ❑ 15-channel hand-held radio transmitter for bidirectional communications between transmitter and receiver(s)
- ❑ Selection key for switching between "Auto/Manual" with automatic status display by LED and "Hand" or "Auto" icon
- ❑ UP/Stop/Down keys for manual operation
- ❑ Programming button on the back of the device (can be operated with cover)
- ❑ Menu-controlled function setting with plain-text displays and channel and product management with editing options in a maximum of two text fields per channel
- ❑ Display menu control in 14 languages in backlit display
- ❑ Configuration options for up to five different groups (combination of up to a maximum of 5 programmed channels from the available individual channels)
- ❑ Master channel for common addressing of all individual channels, availability of master channel can be switched

- ❑ Selection of the individual channels, group channels or the master channel with display function
- ❑ Information on executed commands by status LED and display icons

4 Operation

This chapter contains basic information on using the operating instructions and the device.

4.1 Bidirectional radio system

A bidirectional radio system transmits radio signals to radio receivers and enables feedback from radio receiver to the transmitter. The radio signal can be sent directly to the target receiver. If this is not possible, the radio signal is routed via other bidirectional devices until the signal reaches the target receiver. The target receiver carries out the command and sends a confirmation back to the transmitter. The prerequisite for bidirectional radio is therefore that all components can transmit and receive radio signals.

4.2 Initial operation

Press any key to activate the hand-held transmitter; Display, status display and operating mode display light up. When using the device for the first time select the required language in the menu control.

4.3 Power supply

The device is powered by two AA batteries. When using batteries make sure that there are two identical 1.5 V batteries. The device switches off automatically if the batteries are flat. Low batteries are indicated by a battery indicator in the top section of the display (toolbar) beside the channel number display.



Important:

Replacing batteries:
see Chapter 4.6, Replacing batteries.

4.4 Operating mode

The channel display indicates when the device is ready for use.

The display backlighting switches off automatically if keys are not pressed and/or the joystick is not moved for longer than 2 minutes.

After programming the transmitter channel to a receiver, in the operating mode a product-specific pictogram with an icon showing the current movement status and an icon for automatic or manual mode of the receiver is displayed. The display can show the pictograms for roller shutters (standard), interior shading (roller blind), venetian blind, awning, light or heating. The icons for the movement status and automatic or manual operation of the receiver are shown on the right of the product pictograms.

The bottom display row shows the functions that can be selected with the two selection keys (soft keys) in the current operating mode.

Example 1 of a display in the operating mode

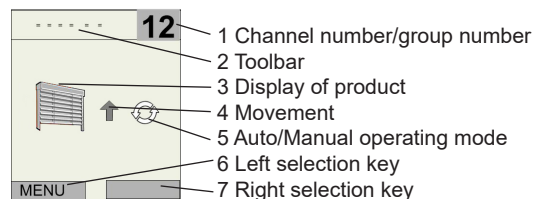

Fig. 1 Display in operating mode (example 1):
Channel 12, programmed venetian blind,
automatic active, movement up

Example 2 of a display in the operating mode

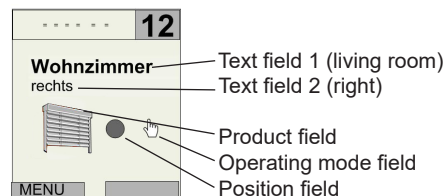

Fig. 2 Display in operating mode (example 2):
Channel 12, programmed venetian blind,
stop status, manual active;
Text field 1 (living room) and
text field 2 (right) individually entered

A group pictogram is shown for a group channel and for the master channel (combination of all channels, "All"). A channel or group number is not displayed in the master channel.



Important:



If there are different products in a single channel after programming, the product pictogram is shown with an additional reference to different products (product combination).







This is applicable only if "INTERNAL" is selected in the Settings - Product Selection menu, because only in this case is the product type returned by the programmed receiver displayed.

4.4.1 Icons in the device display





Pictograms in the toolbar	
	Battery indicator (low battery capacity)



Tab. 3 Pictograms in the toolbar of the display

Icons in the product field	
	Roller shutter
	Interior shading



Icons in the product field	
	Venetian blinds
	Awning
	Light
	Heating
	Combination of different products in the single channel
	Display of group and master channel

Tab. 4 Icons in the product field of the display

Icons in the position field	
	Up
	Down
	Upper end position
	Lower end position

Icons in the position field	
	Intermediate position reached (roller shutter, awning; venetian blind)
	Ventilation position, fabric tautening or tilting position reached (roller shutter, awning; venetian blind)
	STOP status

Tab. 5 Icons in the position field of the display

Icons in the operating mode field	
	Manual mode of receiver
	Automatic mode of receiver

Tab. 6 Icons in the operating mode of the display field

4.4.2 Status LED

A radio signal is displayed by the illumination of the status display (LED ring around the STOP key).

The status LED can display different colours:

Status display (status LED) and its meaning	
orange flashing	Channel not yet programmed to a receiver

Status display (status LED) and its meaning	
orange fast flashing	Channel in programming mode, previously programmed receivers cannot be operated. Lights continuously every three seconds in group mode
orange, then green	Receiver has received the signal sent by the hand-held transmitter and responded
orange, the red flashing	Receiver has not received the signal sent by the hand-held transmitter
red and green 2 x alternately, then red	Channel deleted in receiver and transmitter

Tab. 7 Status displays and their meaning

The transmission power and radio range are reduced as the battery power decreases (reduced battery capacity). If the status LED does not light up when a key is pressed, the batteries must be replaced (see Chapter 4.6, Replacing batteries).

4.4.3 Group control unit and master channel (All)

A group refers to the control of several receivers (channels) at the same time. The selected group is controlled by a travel command.

With the MultiTel 2 individual channels can be combined into five different groups for group control. The master channel ("All" channel selection in the display) controls all available channels simultaneously.

4.4.4 Joystick (multidirectional key)

The joystick (4-way key) is the master control unit for navigating in the display menus. You can use it to select any of 15 channels by pressing "down" or "up". Only the programmed channels are displayed in the operating mode.

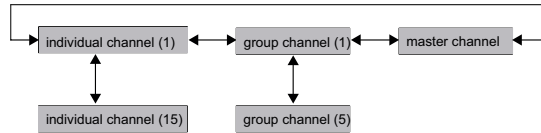

Fig. 3 Navigation in channels, groups, master channel

If multiple single channels are allocated to different groups, the joystick can be used to select up to five configurable group control units simply by moving it to the side.

Channels are allocated to a group with the "Administration" menu (see menu structure in "Menu mode", Chapter 4.5).

There is an additional channel for the master channel, to which all individual channels are assigned. The master channel is selected by moving the joystick slightly to the side.

4.4.5 Selection button

Press the selection key briefly to query the current automatic status and the receiver position of the programmed receiver and to update on the hand-held transmitter.

After pressing the key briefly, all channels, including channels that have not been programmed yet, can be selected with the joystick for 30 seconds; after 30 seconds only the programmed channels are visible.

Press the selection key for a longer time (longer than 1 second) to switch the operating mode of the channel (between "Auto" and "Manual").

"Manual" operating mode:

The operating mode indicator lights up red and the operating mode in the display switches between "manual" and "automatic".

- The receiver now carries out manual travel commands only and does not respond to automatic travel commands.



Important:

All automatic functions are disabled in the receivers, the receiver does not respond to automatic timer commands and shading commands from programmed sensors.

Exception:

Alarm movements are a result of reported alarms of corresponding sensors (e.g. wind and rain sensors) are still executed.

"Automatic" operating mode:

The operating mode indicator shows green and the operating mode display switches to "Auto".

- The receiver now executes automatic **and** manual travel commands.



Important:

Switching the operating mode in the master channel changes the "Auto" or "Manual" operating mode for all individual channels.

Switching the operating mode within a group changes the "Auto" or "Manual" operating mode for all individual channels of the group.

A different "Auto" **and** "Manual" operating mode in individual channels is shown in the display with an orange operating mode indicator and "Automatic icon" **and** "Manual icon" side by side.

4.4.6 UP, DOWN and STOP keys

Actuating the keys initiates a travel operation or a stop in the channel of the programmed receiver.

4.5 Menu mode

The functions of the device are divided into menus.

In the initial display select "Menu" and then the desired menu or submenu.

Exiting the current menu level: Select "Back", if necessary select "Back" repeatedly until you are returned to the initial display or otherwise press and hold "Back".

Entering text: To enter text (e.g. for naming groups and channels), you can use the text input to select upper and lower case, numeric characters, special characters and accented characters. The selected character set is visually supported by highlighting the allocated icons in the display.

Dialogue guidance in the display is menu-guided. All functions can be accessed via the various menus.

See diagram below for a view of the complete menu structure:

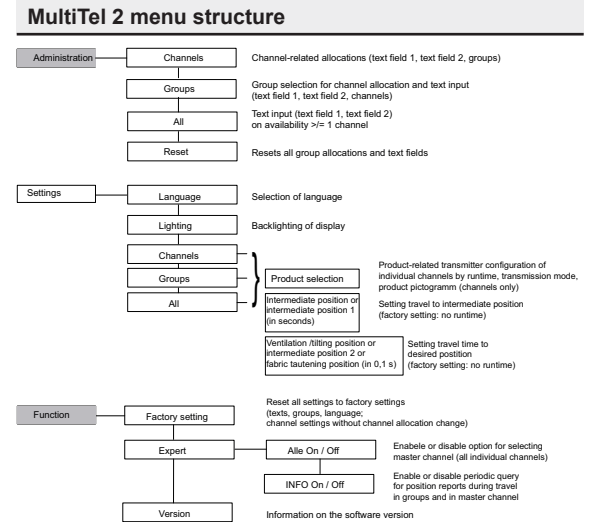

Fig. 4 Menu structure of the MultiTel 2

Key functions

Selections and changes in the menus are made with the joystick and the left and right menu keys. The assignment of the menu keys is defined depending on the context by a correspondingly allocated text field.

Joystick functions in menu mode in the MultiTel 2	
Movement down	Scrolls down or changes the value (-).
Movement up	Scrolls up or changes the value (+).
Movement to the left/right	Changes the setting ranges or activates the field.

Tab. 8 Joystick functions in the MultiTel 2

Important:



If the device is in menu mode and the buttons are not touched for more than 30 seconds, the operating type switches to the operating mode.

4.5.1 "Administration" menu

The following chapter structure corresponds to the menu structure in the MultiTel 2. The "Administration" menu offers the option of selecting individual channels, groups (group channels) or the master channel and giving them names. Individual channels can also be allocated to different groups; all individual channels are automatically allocated to the master channel.

"Channels" submenu

A selected channel can be allocated to one or more groups. A name for the selected channel can be defined in two text fields each with a maximum of 15 characters.

"Groups" submenu

Individual channels (maximum 5 channels per group) can be allocated for five selectable groups. A name for the selected group can be defined in two text fields each with a maximum of 15 characters



Important:

The group allocation is only available if at least two programmed individual channels are available.

"All" submenu

A name for the master channel can be defined in two text fields each with a maximum of 15 characters. This submenu is not available in the event of cut-out in "Menu: Function - Expert".

"Reset" submenu

Resets all group allocations and text fields: All names and allocations can be reset to the factory settings by selecting the "Rest" menu.

4.5.2 "Settings" menu

You can make various function settings in the "Settings" menu.

"Language" submenu

A language for the menu texts can be selected from the list.

Display languages in the MultiTel 2 display		
German	English	French
Italian	Spanish	Portuguese
Dutch	Swedish	Danish
Polish	Hungarian	Czech
Slovenian	Turkish	

Tab. 9 Available languages in MultiTel 2

- "Save" menu key

(Display) "Lighting" submenu

You can switch the display backlighting on or off. The backlighting automatically switches off after 10 seconds if a key is not pressed. The lighting is enabled in the factory setting.

"Channel settings" submenu

"Group" submenu

"All" submenu (with activated function only)

The above three submenus ("Channel Settings", "Group", "All") branch further into three submenus

- "Product selection"
- "Intermediate position"
- "Ventilation/tilting position"

Product selection (for channels only)

Regardless of products previously defined during programming (INTERNAL setting), the product view can be redefined individually for the channel with the assigned pictogram.

- "Save" menu key



Important:

The customised product views will be lost and must be redefined if the device is reset to the factory settings.

Intermediate position

You can set a runtime from zero to 360 seconds for approaching an intermediate position from the top end position if the radio receiver product (roller shutter, venetian blind, awning) does not support saving an independent intermediate position.

The runtime can be set in 1-second steps by time preselection by joystick or intuitively with the **DOWN** or **UP** key with travel distance setting; the factory setting for the intermediate position runtime is zero seconds (no runtime setting).

- "Save" menu key

The intermediate position is approached by the defined runtime by double-clicking the **DOWN** key.

Ventilation/tilting position

You can set a runtime in 0.1-second steps for approaching a ventilation position (roller shutter) or tilting position (venetian blind) from the bottom end position if the radio receiver product does not support saving an independent intermediate position.

The runtime can be set in 0.1-second steps by time preselection by joystick or intuitively with the **DOWN** or **UP** key with travel distance setting; the factory setting for the ventilation position runtime is zero seconds (no runtime setting).

- "Save" menu key

4.5.3 "Function" menu

Factory setting submenu

The selection and confirmation of this menu item resets all settings to the factory setting, except for the channel-related receiver allocation (language, customised texts, group allocations, runtimes, product display, automatic mode status). Settings must be redefined if necessary.

Factory settings of the MultiTel 2		Standard setting
Administration • Channels • Groups • All	Allocations text field 1 text field 2	none empty empty
Settings	Language Lighting	German On
Settings • Channels • Groups • All	Product selection Intermediate position Ventilation position	Roller shutter or depending on programmed receiver Without runtime setting Without runtime setting
Function • Expert	All On/Off INFO On/Off	All On INFO On

Tab. 10 Factory settings of the MultiTel 2

Expert submenu

"All On/Off"

The master channel is available in the factory setting: "All On".

If this is not wanted or does not appear appropriate (e.g. with mixed operation with roller shutters and awnings), the function can be disabled with "All Off".

If the "All Off" setting is selected, the control and programming options of the master channel are disabled.

"INFO On/Off"

On or Off function for the periodic query of the individual channels when starting and during travel motion in the group or in the master channel. The shut-off of radio traffic during transmission in the group or in the master channel. In the case of cut-out the position display is updated by the internal of the transmitter.

"Version" submenu

Display of current firmware version

4.6 Programming the transmitter

A maximum of 15 individual channels is available for programming receivers. Press the selection key briefly to allow all channels to be available for selection for programming for 30 seconds. After selection of the channel the programming process can be started with the **P** key. All channels will also be displayed during the programming process if a programming process is started with the **P** key. During a programming process the user can switch between empty and previously programmed channels (except when programming a channel with more than 10 simultaneous receivers).

Condition:

The bidirectional receiver is installed.

For programming in front of the programmed blind.

1. With electrical receivers which have already been installed, switch the fuse off, and on again a few seconds later. The receiver is now in programming mode for about 5 minutes.
2. Press the programming key **P** on the back of the device briefly (approx. 1 second) until the status display lights up briefly. The blind moves up and down for approx. two minutes, showing that the receiver is in programming mode.
3. Press the **UP** key immediately (maximum 1 second) after the start of an upward movement. The status display lights up briefly. The blind stops briefly, starts moving again and then moves downwards.
4. Press the **DOWN** key immediately (maximum 1 second) after the start of any downward movement. The status display lights up briefly. The blind stops. The channel is now programmed by the transmitter.

Important:



If the blind does not stop, it must be programmed again. A programming process can be cancelled by pressing the **STOP** key for six seconds.

4.6.1 Programming additional transmitters

Important:



If **multiple receivers** are connected to the **same feeder**, they are all in programming mode for approximately 5 seconds after switching on the power.

If the **P** button on the transmitter is pressed, all the receivers start programming mode at the same time (movement up and down). Randomly different intervals between movements up and down cause the receivers to become offset against one another. The longer programming is delayed, the greater the offset will be.

You can stop the short movements up and down by briefly pressing the **STOP** button on a transmitter which has already been programmed. Programming mode in the receiver is cancelled.

You can now assign the transmitter without having to disconnect individual receivers. If the blind moves in the wrong direction, delete the transmitter and restart the programming process (see Chapter 4.5.12 "Deleting positions/deleting transmitters").

If you wish to program additional transmitters to a receiver:

1. Press the **UP** and **DOWN** keys and the programming button **P** (back of the device) simultaneously (for 3 seconds) on a transmitter that is already programmed for the receiver. The status display lights up briefly. The receiver is now in programming mode.
2. Press the programming button **P** on the transmitter to be programmed, until the status display lights up briefly. The receiver is now in programming mode (movements up and down).
3. Press the **UP** key immediately (maximum 1 second) after an upward movement has started. The status display lights up briefly. The blind stops briefly, starts moving again, stops and then moves in the **DOWN** direction.
4. Press the **DOWN** key immediately (maximum 1 second) after the start of a downward movement. The status display lights up briefly. The blind stops.

The transmitter is now programmed.

If more than 10 bidirectional receivers are being programmed at the same time, the transmitter channel in programming mode switches to group mode. Group mode is indicated by fast flashing with pauses.

Programming in group mode is terminated after 2 minutes without pressing a key or the joystick or by pressing the **STOP** key for 6 seconds.

Important:



For venetian blinds, a jogging mode for quickly reaching receivers which are further away is not possible in a transmitter channel with more than 10 programmed receivers.

4.6.2 Synchronous programming mode

If a transmitter must be programmed for multiple receivers at the same time:

1. Press the **DOWN** key and the programming button **P** (back of the device) simultaneously (for 3 seconds) on a transmitter that is already programmed for the receivers. The status display flashes. The receivers are now in programming mode.
 2. Press the programming button **P** on the transmitter to be programmed, until the status display lights up briefly. The receivers are now in programming mode (movements up and down).
 3. Press the **UP** key immediately (maximum 1 second) after an upward movement has started. The status display lights up briefly. The blinds stop briefly, start moving again, stop and then move in the **DOWN** direction.
 4. Press the **UP** key immediately (maximum 1 second) after the start of a downward movement. The status display lights up briefly. The blinds remain stopped.
- The transmitter is now programmed.

4.6.3 Stopping programming mode in transmitter

Press and hold the **STOP** key for at least 6 seconds until the status display shows orange.

4.6.4 Approaching end positions of roller shutter, awning, venetian blind

Condition:

The transmitter is now programmed. The end positions have been set.

Approaching the lower end position (roller shutter/awning)

Press the **DOWN** key briefly. The blind approaches the lower end position or the awning opens completely.

Approaching the lower end position (venetian blind)



Press the **DOWN** key until the status display lights up briefly. The blind approaches the lower end position. Press the **DOWN** key briefly (jogging mode with drive YES, pulse operation with Combio Pulse). The blind moves briefly and then stops.

Approaching the upper end position (roller shutter / awning)

Press the **UP** key briefly. The blind approaches the upper end position or the awning closes.

Approaching the upper end position (venetian blind)

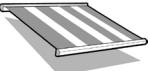
Press the **UP** key until the status display lights up briefly. The blind approaches the upper end position. Press the **UP** key briefly (jogging mode with drive JA, pulse operation with Combio Pulse), the blind moves briefly and then stops.

Intermediate position of blinds				
	Roller shutter	Awning	Venetian blinds	Interior shading
				
Pos ▼	Intermediate position	Intermediate position	Intermediate position	Intermediate position 1
Pos ▲	Ventilation position	Fabric tensioning	Tilting position	Intermediate position 2

Tab. 11 Intermediate positions of blinds

4.6.5 Programming the intermediate position in the receiver

Requirement

The transmitter is now programmed. The end positions of the drive have been set. The blind/shutter is at its upper end position.

1. Traverse the blind to the desired position with the **DOWN** key. Keep pressing the **DOWN** button.
2. Press the **STOP** key also. The blind will stop. The status display lights up briefly. The intermediate position is programmed.

4.6.6 Programming the ventilation/tilting position in the receiver

Requirement

The transmitter is now programmed. The end positions of the drive have been set. The blind/shutter is at its lower end position.

- Traverse the blind in the UP direction with the **UP** key until the ventilation gaps open or the slat tilt position is reached. Keep pressing the **UP** button while it is moving. In addition press the **STOP** button. The blind will stop. The status display lights up briefly. The ventilation/tilt position is programmed.

Approaching the intermediate position

Requirement

The transmitter is now programmed. The blind/shutter is at its upper end position.

1. Press the **DOWN** button briefly twice. The status display lights up briefly.
2. The blind travels to the stored intermediate position. Venetian blinds are automatically tilted after reaching the intermediate position if a tilting position has

been programmed. If an intermediate position is not programmed, the blind moves down to the bottom end position (not if Combio Pulse is used).

Approaching the ventilation/tilting position Requirement

The transmitter is now programmed.

The blind/shutter is at its lower end position.

1. Press the **UP** button briefly twice. The status display lights up briefly.
2. The blind travels to the stored ventilation / tilting position. If a ventilation/tilting position is not programmed, the blind moves down to the bottom end position (not if Combio Pulse is used).

4.6.7 Operation of transmitter with Combio JA Pulse

A Combio-915 JA pulse for exact setting of the slats can be used with venetian blind drives. Press the **UP** or **DOWN** key to move for the preset pulse time of the Combio Pulse.

The user can change the pulse time. This is done by pressing and holding the **STOP** and **UP** keys for 6 seconds. The drive starts moving in short pulses. As soon as the blind has moved the desired distance, release the **UP** key then release the **STOP** key. The new pulse time is saved. The new pulse time is equal to the total of all pulse times while programming the pulse time. After 30 pulses the Combio JA Pulse terminates programming the pulse time.

4.6.8 Deleting positions/deleting transmitters

Deleting the intermediate position in the receiver

1. Press both the **STOP** button and the **DOWN** button.
2. Press and hold this key combination for approx. 3 seconds. The status display lights up briefly.

Deleting the ventilation/tilting position in the receiver

1. Press both the **STOP** button and the **UP** button.
2. Press and hold this key combination for approx. 3 seconds. The status display lights up briefly.

Deleting the transmitter channel in the receiver

- Press both the **STOP** key and the programming button **P** (back of the device).
3. Press and hold this key combination for approx. 6 seconds until the status display lights up briefly orange and then red. The channel (or the group) in the transmitter is also deleted.

Deleting all the transmitters in the receiver

1. Press the **STOP** key, the programming button **P** (back of the device) and the **UP** key and the **DOWN** key together.
2. Press and hold this key combination for approx. 6 seconds. The status display lights up orange-green briefly twice, followed by red. The channel (or the group) in the transmitter is also deleted.

4.6.9 Expert settings

DIP switch 1 on the back of the device, under the cover:
OEM setting

4.7 Changing the batteries



Important:

Replace batteries only with batteries of the identical type.

1. Unscrew the device at the bottom with a suitable tool and remove the cover.
2. Remove the batteries.
3. Insert the two new identical batteries (AA, LR 06, Mignon) in the correct position (note polarity).
4. Replace the cover and screw it to the device.



Fig. 5 Replacing batteries for the MultiTel 2

4.8 Cleaning and care of the device

- Use a soft, clean and dry cloth to clean the surface of the device.
- Do not use cleaning agents and solvents.
- Keep the device dry.
- Do not use or store the device in dusty or dirty environments.
- Do not store the device at high temperatures.
- Do not store the device at low temperatures.
- Do not try to open the device other than as described in the operating instructions.
- Unauthorised modifications may damage device and violate regulations applicable to radio devices.
- Do not drop the device, do not subject it to impact and do not shake it. Rough treatment may damage sensitive electronic circuits and mechanical components in the device.
- Keep the device clear of magnets or magnetic fields.

5 US Declaration of conformity

FCC ID: YBU2825

IC: 8929A-2825

USA (FCC)

Part 15 Statement gem. FCC 15.19/RSS Gen Issue 3 Sect. 7.1.3

This device (elero MultiTel-915) complies with Part 15 of the FCC Rules and with Industry Canada license-exempt RSS standard(s). Operation is subject to the following two conditions:

- (1) this device may not cause harmful interference, and
- (2) this device must accept any interference received, including interference that may cause undesired operation.

Canada, Industry Canada (IC)

Le présent appareil (elero MultiTel-915) est conforme aux CNR d'Industrie Canada applicables aux appareils radio exempts de licence. L'exploitation est autorisée aux deux conditions suivantes :

- (1) l'appareil ne doit pas produire de brouillage, et
- (2) l'utilisateur de l'appareil doit accepter tout brouillage radioélectrique subi, même si le brouillage est susceptible d'en compromettre le fonctionnement.

Caution:

Changes or modifications not expressly approved by the party responsible for compliance could void the user's authority to operate the equipment.

Information:

This equipment has been tested and found to comply with the limits for a Class B digital device, pursuant to part 15 of the FCC Rules. These limits are designed to provide reasonable protection against harmful interference in a residential installation. This equipment generates, uses and can radiate radio frequency energy and, if not installed

and used in accordance with the instructions, may cause harmful interference to radio communications. However, there is no guarantee that interference will not occur in a particular installation. If this equipment does cause harmful interference to radio or television reception, which can be determined by turning the equipment off and on, the user is encouraged to try to correct the interference by one or more of the following measures:

- Reorient or relocate the receiving antenna.
- Increase the separation between the equipment and receiver.
- Connect the equipment into an outlet on a circuit different from that to which the receiver is connected.
- Consult the dealer or an experienced radio/ TV technician for help

6 Troubleshooting

Fault	Cause	Remedy
Drive does not run; status display does not light up	Batteries are low Batteries are incorrectly installed	Insert new batteries Insert batteries correctly
Drive does not run; status display lights up red or flashes orange	1. The receiver is outside of sending range 2. Receiver out of order or faulty 3. Receiver not yet programmed	1. Reduce distance to the receiver 2. Switch on or exchange receiver 3. Program receiver
Desired drive does not run	Incorrect group or channel selected	Select correct group or channel

End positions are approached inaccurately	End positions not yet set	Have the end positions set by a trained specialist in accordance with the product instructions
Drive operates in the wrong direction	Directions are incorrectly allocated	Delete transmitter and reprogram

Tab. 12 Troubleshooting the MultiTel 2

7 Repair

Please contact your dealer if you have any questions.

Please always provide the following information:

- Item number and name on the type plate
- Type of fault
- Previously occurring and unusual incidents
- Accompanying conditions
- Own presumption

8 Address

elero GmbH
Maybachstr. 30
73278 Schlierbach, GERMANY

www.elero.com

Please visit us on the internet if you require a contact outside Germany.

9 Disposal

The current applicable international, national and regional laws and regulations must be observed for disposal of the device.



Ensure that materials and assemblies are recycled, disassembled and separated to prevent environmental and health hazards during recycling and disposal.

Material groups such as plastics and metals of various types must be sorted for recycling and disposal.

Disposal of electrical and electronic components:

Electrical and electronic components must be disposed of in accordance with the applicable laws and national regulations.

