

TEST REPORT
 No.: 6-0111-11-1-3a

According to:
FCC Regulations
 Part 15.247 & 15.209
 Part 15.109 Class B
IC Regulations
 RSS-210, Issue 8
 RSS-Gen, Issue 3

for

Robert Bosch Car Multimedia GmbH

Bluetooth Radio Navigation Nissan LCN2 (7 612 051 140)

FCC-ID: YBN-LCN20
 IC: 9595A-LCN20







Laboratory Accreditation and Listings			
 DAkKS Deutsche Akkreditierungsstelle D-PL-12047-01-01	 FEDERAL COMMUNICATIONS COMMISSION USA Reg. No.: 736496 MRA US-EU 0003	 Industry Canada Reg. No.: 3462D-1 Reg. No.: 3462D-2 Reg. No.: 3462D-3	 Voluntary Controls for Electromagnetic Emissions Reg. No.: R-2665, R-2666 C-2914, T-1967, G-301
 WiFi ALLIANCE AUTHORIZED RF LABORATORY	 CTIA Authorized Test Lab LAB CODE 20011130-00		
accredited according to DIN EN ISO/IEC 17025			
<p align="center"> CETECOM GmbH Laboratory Radio Communications & Electromagnetic Compatibility Im Teelbruch 116 • 45219 Essen • Germany Registered in Essen, Germany, Reg. No.: HRB Essen 8984 Tel.: + 49 (0) 20 54 / 95 19-954 • Fax: + 49 (0) 20 54 / 95 19-964 E-mail: info@cetecom.com • Internet: www.cetecom.com </p>			

Table of contents

1. SUMMARY OF TEST RESULTS.....	3
2. ADMINISTRATIVE DATA	5
2.1. Identification of the testing laboratory.....	5
2.2. Test location	5
2.3. Organizational items.....	5
2.4. Applicant’s details	5
2.5. Manufacturer’s details	5
3. EQUIPMENT UNDER TEST (EUT).....	6
3.1. Additional declaration and description of main EUT	6
3.2. EUT: Type, S/N etc. and short descriptions used in this test report	6
3.3. Auxiliary Equipment (AE): Type, S/N etc. and short descriptions.....	7
3.4. EUT set-ups	7
3.5. Configuration of cables used for testing	7
3.6. EUT operating modes	7
4. DESCRIPTION OF TEST SET-UP’S.....	8
4.1. Test Set-up for conducted measurements	8
4.2. Test set-up for radiated measurements	9
5. MEASUREMENTS	10
5.1. 20-dB Bandwidth.....	10
5.2. 20dBc Emission specification.....	13
5.3. Power specification.....	16
5.4. Radiated field strength emissions below 30 MHz	18
5.5. Radiated field strength emissions, 30 MHz - 1 GHz	22
5.6. Radiated emissions, above 1GHz	25
5.7. Radiated measurement: Max. E.I.R.P Power.....	29
5.8. Band-Edge compliance measurements	31
5.9. Channel carrier frequency separation for FHHS-systems.....	32
5.10. Specification for hopping channel numbers and time of occupancy for FHHS-systems.....	33
5.11. Requirements on channel use, average channel use, input bandwidth and synchronization between signals for FHHS-systems	35
5.12. Measurement uncertainties	36
6. ACCREDITATION DETAILS OF CETECOM’S LABORATORIES AND TEST SITES	36
7. INSTRUMENTS AND ANCILLARY.....	37
7.1. Used equipment “CTC”	37

Table of annex

	Total pages
ANNEX 1: MEASUREMENT DIAGRAMS	51
ANNEX 2: EXTERNAL EUT PHOTOGRAPHS	5
ANNEX 3: SET UP PHOTOGRAPHS	3
ANNEX 4: INTERNAL EUT PHOTOGRAPHS	8

The listed attachments are an integral part of this report.

1. Summary of test results

The test results apply exclusively to the test samples as presented in this Report. The CETECOM GmbH does not assume responsibility for any conclusions and generalizations taken in conjunction with other specimens or samples of the type of the item presented to tests.

The presented Car Navigation unit incorporates a Bluetooth® transmitter for the 2.4GHz ISM Band. Following tests have been performed to show compliance with applicable FCC Part 2 and Part 15C rules of the FCC CFR 47, Edition 27 January 2012 and Industry Canada RSS-210, Issue 8 and RSS-Gen, Issue 3 regulations. Other operation modes of the device have not been tested according manufacturer request.

1.1. TESTS OVERVIEW USA FCC and Canada IC Standards (RSS)

TEST CASES	PORT	REFERENCES & LIMITS			EUT set-up	EUT operating mode	Result
		FCC Standard	RSS Section	TEST LIMIT			
TX-Mode							
20dB Bandwidth	Antenna terminal (conducted)	§15.247(a)(1)	RSS-210 Issue 8: A8.1 (a)(b)	At least 25kHz or 2/3 of 20dB bandwidth	2	1	Passed
Channel carrier frequency separation					2	1	
99% occupied bandwidth	Antenna terminal (conducted)	--	RSS-210 Issue 8: Chapter 4.6.1	99% Power bandwidth	2	1	Passed
Channel use, average channel use, input bandwidth and synchronization between signals	--	§15.247(a)(1)	RSS-210 Issue 8: A8.1	See specification	--	--	Not performed remark 1
Channel average occupancy time and number of channels	Antenna terminal (conducted)	§15.247(a)(1) (iii)	RSS-210 Issue 8: A8.1(d)	0.4 seconds	2	1	Passed
Transmitter output power	Transmitter Peak output power	Antenna terminal (conducted)	§15.247(b)(1)	RSS-210 Issue 8: A8.4 (2)	2	1	Passed
Transmitter Output power radiated	Cabinet (radiated)	§15.247(b)(4)	RSS-210 Issue 8:A8.4 (4)	< 0.125mW (EIRP) for antenna with directional gain less 6dBi	1	1	Passed
Out-Of-Band RF-emissions	Antenna terminal (conducted)	§15.205 §15.209 §15.247 (d)	RSS-210 Issue 8: A8.5	20 dBc & Emissions in restricted bands must meet the general field-strength radiated limits	2	1	Passed
Band-Edge emissions							

General field strength emissions + restricted bands	Cabinet + Interconnecting cables (radiated)	§15.247 (d) §15.205 §15.209	RSS-210 Issue 8, Chapter 2.5 RSS-Gen: Issue 3: §7.2.5 Table 5+6	Emissions in restricted bands must meet the general field-strength radiated limits	1	1	Passed
AC-Power Lines Conducted Emissions	AC-Power lines	§15.207	RSS-Gen, Issue 3: Chapter 7.2.4, Table 4	FCC §15.107 class B limits §15.207 limits IC: Table 4, Chapter 7.2.4	--	--	Not performed, no AC mains connection

Remark: 1.) See applicants declaration for compliance with Bluetooth® Core specification

RX Mode							
AC-Power Lines Conducted Emissions	AC-Power lines	§15.107	RSS-Gen, Issue 3: Chapter 7.2.4	FCC §15.107 class B limits §15.207 limits IC: Table 2, Chapter 7.2.2	--	--	Not performed, no AC mains connection
RECEIVER Radiated emissions	Cabinet + Interconnecting cables (radiated)	§15.109 §15.33 §15.35	RSS-Gen, Issue 3: Chapter 6.1	FCC 15.109 class B limits IC-limits: Table 1, Chapter 6	1	2	Passed Remark 1

Remarks:--

I declare that all measurements were performed by me or under my supervision and that all measurements have been performed and are correct to my best knowledge and belief to Industry Canada standards. All requirements as shown in above table are met in accordance with enumerated standards.

Dipl.-Ing. W. Richter
Responsible for test section



GmbH
Im Teelbruch 116
45219 Essen
Tel.: + 49 (0) 20 54 / 30 19 - 0
Fax: + 49 (0) 20 54 / 05 19 - 997

Dipl.-Ing. C. Lorenz
Responsible for test report

2. Administrative Data

2.1. Identification of the testing laboratory

Company name:	CETECOM GmbH
Address:	Im Teelbruch 116 45219 Essen - Kettwig Germany
Responsible for testing laboratory:	Dipl.-Ing. W. Richter
Deputy:	Dipl.-Ing. J. Schmitt

2.2. Test location

2.2.1. Test laboratory "CTC"

Company name:	see chapter 2.1. Identification of the testing laboratory
---------------	---

2.3. Organizational items

Order No.:	6-0111-11-1
Responsible for test report and project leader:	Dipl.-Ing. C. Lorenz
Receipt of EUT:	2011-11-08
Date(s) of test:	2011-11-09 to 2012-01-04
Date of report:	2012-01-29

Version of template:	11.12 _All.Dotm

2.4. Applicant's details

Applicant's name:	Robert Bosch Car Multimedia GmbH
Address:	Robert-Bosch-Str. 200 31139 Hildesheim Germany
Contact person:	Mr. Manfred Aufzug

2.5. Manufacturer's details

Manufacturer's name:	please see Applicant's details
Address:	please see Applicant's details

3. Equipment under test (EUT)

3.1. Additional declaration and description of main EUT

Main function	Radio Navigation with integrated Bluetooth® transmitter		
Type	Nissan LCN2 (7 612 051 140)		
Frequency range	2402 – 2480 MHz		
Type of modulation	GFSK, Pi/4-DQPSK, 8DPSK		
Number of channels	78		
EMISSION DESIGNATOR(S)	GFSK: 889KFXD Pi/4DQPSK: 1M1GXD 8DPSK: 1M2GXD		
Antenna Type	Integrated, 2.3dBi according customers information		
MAX Field strength (radiated) TX-Mode	43.07 dBµV/m@3m distance and 1504.6 MHz		
MAX Field strength (radiated) RX-Mode	29.64 dBµV/m@3m distance and 31.76 MHz		
FCC-ID	YBN-LCN20		
Canada	9595A-LCN20		
Installed option	Not tested within this test report: GPS unit, RADIO FM, Satellite RADIO, CD music unit		
Special EMI components	--		
Power supply	13.5 DC nominal		
EUT sample type	<input type="checkbox"/> Production	<input checked="" type="checkbox"/> Pre-Production	<input type="checkbox"/> Engineering

3.2. EUT: Type, S/N etc. and short descriptions used in this test report

Short description*)	EUT	Type	S/N serial number	HW hardware status	SW software status
EUT A	Bluetooth Radio Navigation	Nissan LCN2 (7 612 051 140)	(CM0140 B 0002060) #RAD sample	08 & BT Module: 206A/C830	lp83_111201 & BT FIRMWARE: C830
EUT B	Bluetooth Radio Navigation	Nissan LCN2 (7 612 051 140)	(CM0140 B 0002061) #COND sample	08 & BT Module: 206A/C830	lp83_111201 & BT FIRMWARE: C830

*) EUT short description is used to simplify the identification of the EUT in this test report.

3.3. Auxiliary Equipment (AE): Type, S/N etc. and short descriptions

AE short description *)	Auxiliary Equipment	Type	S/N serial number	HW hardware status	SW software status
AE 1	Car cable harness	For EUT A/B	--	--	--

*) AE short description is used to simplify the identification of the auxiliary equipment in this test report.

3.4. EUT set-ups

EUT set-up no. *)	Combination of EUT and AE	Remarks
Set. 1	EUT A + AE 1	Set-up used for radiated tests.
Set. 2	EUT B + AE 1	Set-up used for conducted tests. 20dBc conducted spurious emission tests have been performed up to 4GHz only (due to connector frequency range)

*) EUT set-up no. is used to simplify the identification of the EUT set-up in this test report.

3.5. Configuration of cables used for testing

Cable number	Item	Type	S/N serial number	HW hardware status	Cable length
Cable 1	Car cable harness	For EUT A/B	--	--	Approx. 1,2m

3.6. EUT operating modes

EUT operating mode no. *)	Description of operating modes	Additional information
op. 1	TX Mode	The EUT was set to Bluetooth continuous TX test mode. A base station from Rohde&Schwarz CBT32 was used for setting up different channels and operating modes (packet types/modulations)
op. 2	RX-Mode	The EUT was set to Bluetooth continuous RX test mode. A base station from Rohde&Schwarz CBT32 was used for setting up this operating mode.

*) EUT operating mode no. is used to simplify the test report.

4. DESCRIPTION OF TEST SET-UP'S

4.1. Test Set-up for conducted measurements

EUT's RF-signal is first attenuated before it is feed to the spectrum analyzer. Customers RF-adapters are used in case of no suitable RF-Adapters are mounted on the EUT. The specific attenuation losses for the RF-signal path is determined within a path-loss calibration and the measurement readings corrected therefore. The Test-PC as shown in the schematic was not necessary for this project.

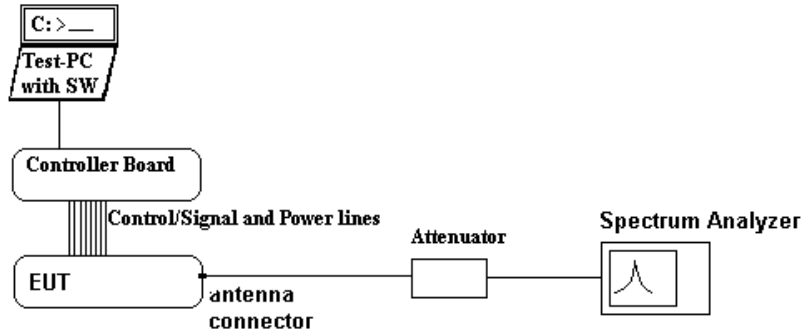

Schematic: Test set-up 3: conducted for RF-tests

4.2. Test set-up for radiated measurements

MEASUREMENT METHOD (30 MHz <math><f < 1\text{ GHz}</math>):

A EMI analyzer together with a broadband antenna was used in order to identify the emissions from the EUT by

positioning the antenna close to the EUT surfaces. The interconnecting cables and equipment position were varied in order to maximize the emissions. Then most critical frequencies are recorded for further investigations. Based on the exploratory measurements, the most critical frequencies are re-measured by maintaining the EUT's operating mode, cable position, etc. The EUT was placed on a non-conductive support of 0.8 m height. By rotating the turntable angle in the range 0 to 360 degree, the EUT itself either over 3-orthogonal axis (not defined usage position) or 2-orthogonal axis (defined usage position) and the measurement antenna height from 1 meter to 4 meters, the maximized emissions are recorded. The measurements are performed for both polarizations of the measuring antenna: horizontal and vertical.

MEASUREMENT METHOD (1 GHz <math><f < 26.5\text{ GHz}</math>):

The EUT and accessories are placed on a non-conducting tipping table of 0.8 meter height (semi-anechoic chamber) or 1.55m height (fully-anechoic chamber) which is situated in the middle of the turntable. The turntable can rotate the device under test 360 degree, the tipping table can rotate the device from laid to standing position. This way the device under test can be rotated in all three orthogonal planes in order to maximize the detected emissions. The turn- and tipping table are controlled by a controller unit. All positions manipulations are software controlled from a operator PC.

The measurements are performed for both receiving antenna polarisations: vertical and horizontal.

Up to 18 GHz a measurement distance of 3 meters is used, above 18 GHz the distance is 1 meter. A biconical-logarithmic antenna up to 1 GHz and a logarithmic-periodic antenna for frequencies above 1 GHz up to 26.5 GHz is used. For frequencies above 26.5 GHz a horn antenna is used, pls. compare the equipment list for more details.

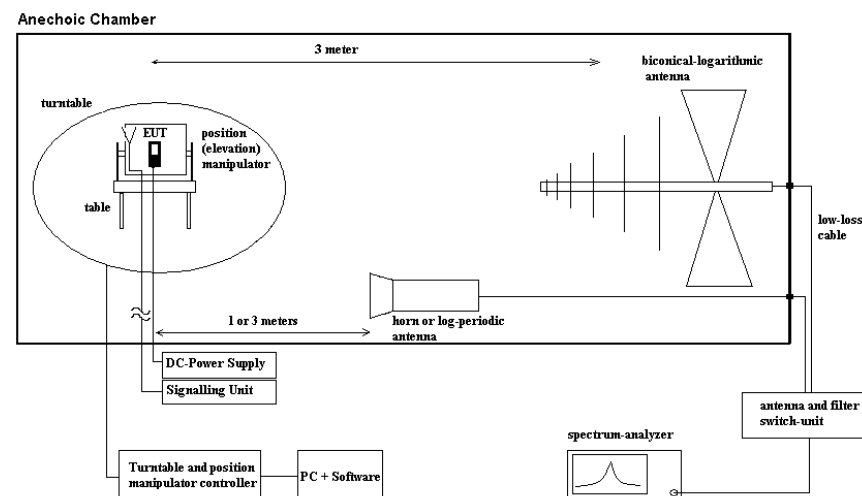

The EUT is powered either by a external DC-supply with nominal voltage or a AC/DC power supply as accessory. The communication signalling (if necessary for operation) is performed from outside the chamber with a communication test simulator (CMU200 from Rohde&Schwarz) and a signalling antenna place near the EUT.

Schematic: radiated measurements test set-up

5. Measurements

5.1. 20-dB Bandwidth

TEST LOCATION AND EQUIPMENT (for reference numbers please see chapter 'List of test equipment')

test location	<input checked="" type="checkbox"/> CETECOM Essen (Chapter. 2.2.1)	<input type="checkbox"/> Please see Chapter. 2.2.2	<input type="checkbox"/> Please see Chapter. 2.2.3
test site	<input type="checkbox"/> 441 EMI SAR	<input type="checkbox"/> 487 SAR NSA	<input type="checkbox"/> 337 OATS
receiver	<input type="checkbox"/> 377 ESCS30	<input type="checkbox"/> 001 ESS	<input checked="" type="checkbox"/> 347 Radio.lab.
Power supply	<input checked="" type="checkbox"/> 354 NGPE 40	<input checked="" type="checkbox"/> 489 ESU	<input type="checkbox"/>
otherwise	<input checked="" type="checkbox"/> 530 10dB Attenuator	<input checked="" type="checkbox"/> cable K15	

REFERENCES: §15.247(a)(1), RSS-210: A8.1(b)

(1) *Frequency hopping systems* shall have hopping channel carrier frequencies separated by a minimum of 25 kHz or the 20 dB bandwidth of the hopping channel, whichever is greater. Alternatively, frequency hopping systems operating in the 2400-2483.5 MHz band may have hopping channel carrier frequencies that are separated by 25 kHz or two-thirds of the 20 dB bandwidth of the hopping channel, whichever is greater, provided the systems operate with an output power no greater than 125 mW.

(2) DSSS Systems using *digital modulation techniques* may operate in the 902-928 MHz, 2400-2483.5 MHz, and 5725-5850 MHz bands. The minimum 6 dB bandwidth shall be at least 500 kHz.

EUT SETTINGS:

For FHSS-systems hopping mode was switched-off so fixed three different channels could be measured. The EUT was instructed to send with maximum power (if adjustable) according applicants instructions. Different modulation characteristics have been checked, e.g. data rates which EUT can operate.

MEASUREMENT METHOD:

The measurement was performed with the RBW set to 10kHz. The span was set to cover the complete carrier. Three carrier frequencies (low/middle/high) were used for showing the compliance with this requirement. A DELTA Marker method was set to measure the bandwidth compared to the highest In-Band power. The operating modes have been varied (e.g. data rate, modulation scheme, etc.). If applicable the hopping-mode is switched off.

Also the **99% emission bandwidth** was measured. Two markers are placed on frequency points such that left to lower f-marker and right to higher f-marker only 1% of the TX-power is contained. Between the markers, 99% of the power is laying. The RBW value is readjusted and the measurement repeated until the RBW/EBW ratio is around 1%.

SPECTRUM-ANALYZER SETTINGS:

Span	Set as to fully display the emissions and approximate 20dB below the PEAK level
Resolution Bandwidth (RBW)	Set to approx 1% of the emission width
Video Bandwidth (VBW)	3 times the resolution bandwidth
Sweep time	Coupled and low enough to have no gaps within power envelope
Detector	Sample (if bin width: Span/no. of frequency points SA < 0.5*RBW SA otherwise Peak detector)
Sweep mode	Repetitive Mode, MAX-HOLD

Results for 20dB Bandwidth

DH5 Modulation

Set-up no.: 2 Op. Mode: 1	20 dB BANDWIDTH [kHz]		
T _{NOM} =21°C, V _{NOM} = 4.1V	Low channel = 0 (2402 MHz)	Middle channel =39 (2441 MHz)	High channel = 78 (2480 MHz)
Maximum Value	873.3974	877.4038	877.4038

Remark: see diagrams/results in separate document A1

2DH3 Modulation

Set-up no.: 2 Op. Mode: 1	20 dB BANDWIDTH [kHz]		
T _{NOM} =21°C, V _{NOM} = 4.1V	Low channel = 0 (2402 MHz)	Middle channel =39 (2441 MHz)	High channel = 78 (2480 MHz)
Maximum Value	1209.9358	1205.9294	1201.9230

Remark: see diagrams/results in separate document A1

3DH5 Modulation

Set-up no.: 2 Op. Mode: 1	20 dB BANDWIDTH [kHz]		
T _{NOM} =21°C, V _{NOM} = 4.1V	Low channel = 0 (2402 MHz)	Middle channel =39 (2441 MHz)	High channel = 78 (2480 MHz)
Maximum Value	1229.9679	1233.9743	1241.9871

Remark: see diagrams/results in separate document A1

Results for 99% bandwidth:

The maximum results of 20dBc channels have been re-measured also for 99% bandwidth.

DH5 Modulation

Set-up no.: 2 Op. Mode: 1	99 dB BANDWIDTH [kHz]		
T _{NOM} =21°C, V _{NOM} = 4.1V	Low channel = 0 (2402 MHz)	Middle channel =39 (2441 MHz)	High channel = 78 (2480 MHz)
Maximum Value	--	889.4230	--

Remark: see diagrams/results in separate document A1

2DH3 Modulation

Set-up no.: 2 Op. Mode: 1	99% BANDWIDTH [kHz]		
T _{NOM} =21°C, V _{NOM} = 4.1V	Low channel = 0 (2402 MHz)	Middle channel =39 (2441 MHz)	High channel = 78 (2480 MHz)
Maximum Value	1189.9038	--	--

Remark: see diagrams/results in separate document A1

3DH5 Modulation

Set-up no.: 2 Op. Mode: 1	99% BANDWIDTH [kHz]		
T _{NOM} =21°C, V _{NOM} = 4.1V	Low channel = 0 (2402 MHz)	Middle channel =39 (2441 MHz)	High channel = 78 (2480 MHz)
Maximum Value	--	--	1205.9294

Remark: see diagrams/results in separate document A1

VERDICT: pass

5.2. 20dBc Emission specification

TEST LOCATION AND EQUIPMENT (for reference numbers please see chapter 'List of test equipment')

test location	<input checked="" type="checkbox"/> CETECOM Essen (Chapter. 2.2.1)	<input type="checkbox"/> Please see Chapter. 2.2.2	<input type="checkbox"/> Please see Chapter. 2.2.3
test site	<input type="checkbox"/> 441 EMI SAR	<input type="checkbox"/> 487 SAR NSA	<input type="checkbox"/> 337 OATS
receiver	<input type="checkbox"/> 377 ESCS30	<input type="checkbox"/> 001 ESS	<input checked="" type="checkbox"/> 489 ESU
spectr. analys.	<input type="checkbox"/> 489 ESU	<input type="checkbox"/> 120 FSEM	<input type="checkbox"/> 264 FSEK
power supply	<input type="checkbox"/> 456 EA 3013A	<input type="checkbox"/> 457 EA 3013A	<input type="checkbox"/> 459 EA 2032-50
otherwise	<input checked="" type="checkbox"/> 530 10dB Attenuator	<input checked="" type="checkbox"/> cable K15	<input type="checkbox"/> 268 EA- 3050

REFERENCES: §15.247, §15.205, RSS-210: A8.5

(d) In any 100 kHz bandwidth outside the frequency band in which the spread spectrum or digitally modulated intentional radiator is operating, the radio frequency power that is produced by the intentional radiator shall be at least 20 dB below that in the 100 kHz bandwidth within the band that contains the highest level of the desired power, based on either an RF conducted or a radiated measurement, provided the transmitter demonstrates compliance with the peak conducted power limits.

EUT SETTINGS:

For FHSS-systems hopping mode was switched-off so fixed three different channels could be measured. The EUT was instructed to send with maximum power (if adjustable) according applicants instructions.

MEASUREMENT METHOD:

The frequency spectrum was investigated for conducted (up to 4GHz) and (4-18GHz) spurious emissions values lower than 20dB related to the RF-carrier power value. Three carrier frequencies (low/middle/high channel) were used for showing the compliance with this requirement. The detector were chosen according §15.209(d). The video bandwidth (VBW) was chosen 10 times the resolution bandwidth (RBW). The frequency scan was up to 10 times the highest channel frequency within the operational mode. The spectrum-analyzer was set to MAX-PEAK Detector, MAX-Hold Mode, the power level In-band was recorded with PEAK Detector.

Set-up no.: 2 Op. Mode: 1 (DH1-Modulation)	RF-CONDUCTED TEST: 20 dBc SPURIOUS EMISSIONS					
	Low channel = (2402 MHz)		Middle channel = 39 (2441 MHz)		High channel = 78 (2480 MHz)	
	Level Reference (In-Band) = 106.04 dBµV -> Limit = 86.04 dBuV		Level Reference (In-Band) = 106.63 dBµV /m -> Limit = 86.63 dBuV		Level Reference (In-Band) = 106.60 dBµV /m -> Limit = 86.60 dBuV	
Frequency Range	Frequency [MHz]	Value [dBc]	Frequency [MHz]	Value [dBc]	Frequency [MHz]	Value [dBc]
30 .. 1000 MHz	Peaks from set-up (AE-equipment)	> 45.39	Peaks from set-up (AE-equipment)	> 44.51	Peaks from set-up (AE-equipment)	> 45.51
1 GHz - 4 GHz	2966.34	>44.82	2663.46	>45.97	3259.6	> 45.49
4GHz – 18GHz	Not performed, only worst-case power modulation/Packet tested -> 3DH1 packet type tested (pls. Compare power conducted measurements in chapter 5.3)					
18..25GHz	Only radiated overview measurements -> noise level					
Band-Edge (no hopping)	--	47.95	--	--	--	50.57
Band-Edge (Hopping mode)	--	48.61	--	--	--	48.87

Remark: The limit on the diagrams is 20dB under the reference level measured In-Band for each channel

Set-up no.: 2 Op. Mode: 1 2DH5- Modulation	RF-CONDUCTED TEST: 20 dBc SPURIOUS EMISSIONS					
Frequency Range	Low channel =0 (2402 MHz)		Middle channel = 39 (2441 MHz)		High channel = 78 (2480 MHz)	
	Level Reference (In-Band) = 105.85 dB μ V /m -> Limit = 85.85 dBuV		Level Reference (In-Band) = 106.43 dB μ V /m -> Limit = 86.43 dBuV		Level Reference (In-Band) = 106.46 dB μ V /m -> Limit = 86.46 dBuV	
	Frequency [MHz]	Value [dBc]	Frequency [MHz]	Value [dBc]	Frequency [MHz]	Value [dBc]
30 .. 1000 MHz	Peaks from set-up (AE-equipment)	>50.73	Peaks from set-up (AE-equipment)	>48.92	Peaks from set-up (AE-equipment)	>45.11
1 GHz - 4 GHz	3192.3	>45.07	3596.15	>45.81	3504.8	>45.52
4GHz – 18GHz	Not performed, only worst-case power modulation/Packet tested -> 3DH1 packet type tested (pls. Compare power conducted measurements in chapter 5.3)					
18..25GHz	Only radiated overview measurements -> noise level					
Band-Edge (no hopping)	--	46.21	--	--	--	49.53
Band-Edge (Hopping mode)	--	47.36	--	--	--	49.24

Remark: The limit on the diagrams is 20dB under the reference level measured In-Band for each channel

Set-up no.: 2 Op. Mode: 1 (3DH1-Modulation)	RF-CONDUCTED TEST: 20 dBc SPURIOUS EMISSIONS					
	Low channel = 0 (2402 MHz)		Middle channel = 39 (2441 MHz)		High channel = 78 (2480 MHz)	
	Level Reference (In-Band) = 105.83 dB μ V -> Limit = 85.83 dBuV		Level Reference (In-Band) = 106.50 dB μ V -> Limit = 86.50 dBuV		Level Reference (In-Band) = 106.49 dB μ V -> Limit = 86.49 dBuV	
Frequency Range	Frequency [MHz]	Value [dBc]	Frequency [MHz]	Value [dBc]	Frequency [MHz]	Value [dBc]
30 .. 1000 MHz	Peaks from set-up (AE-equipment)	>48.3	Peaks from set-up (AE-equipment)	>49.27	Peaks from set-up (AE-equipment)	>49.29
1 GHz - 4 GHz	2730.76	>44.73	3466.34	>44.63	3524.03	>45.29
Band-Edge (no hopping)	--	48.39	--	--	--	48.61
Band-Edge (Hopping mode)	--	48.77	--	--	--	46.81

Remark: The limit on the diagrams is 20dB under the reference level measured In-Band for each channel

Set-up no.: 2 Op. Mode: 1 (3DH1-Modulation)	RF-RADIATED TEST: 20 dBc SPURIOUS EMISSIONS					
	Low channel = (2402 MHz)		Middle channel = 39 (2441 MHz)		High channel = 78 (2480 MHz)	
	Level Reference (In-Band) = 90.43 dB μ V/m (PK) -> Limit = 70.43 dB μ V/m		Level Reference (In-Band) = 92.28 dB μ V/m (PK) -> Limit = 72.28 dB μ V/m		Level Reference (In-Band) = 93.68 dB μ V/m (PK) -> Limit = 73.68 dB μ V/m	
Frequency Range	Frequency [MHz]	Value [dBc]	Frequency [MHz]	Value [dBc]	Frequency [MHz]	Value [dBc]
4GHz – 18GHz	17622.04	>37.41	17833.36	>39.11	17683.76	>40.31
18..25GHz	Only radiated overview measurements -> noise level					

Remark: The limit on the diagrams is 20dB under the reference level measured In-Band for each channel

VERDICT: pass

5.3. Power specification

TEST LOCATION AND EQUIPMENT (for reference numbers please see chapter 'List of test equipment')

test location	<input checked="" type="checkbox"/> CETECOM Essen (Chapter. 2.2.1)	<input checked="" type="checkbox"/> 443 System CTC-FAR-EMI-	<input type="checkbox"/> Please see Chapter. 2.2.3
test site	<input type="checkbox"/> 441 EMI SAR	<input type="checkbox"/> 487 SAR NSA	<input type="checkbox"/> 337 OATS
receiver	<input type="checkbox"/> 377 ESCS30	<input type="checkbox"/> 001 ESS	<input checked="" type="checkbox"/> 347 Radio.lab.
spectr. analys.	<input type="checkbox"/> 489 ESU	<input type="checkbox"/> 120 FSEM	<input checked="" type="checkbox"/> 489 ESU
power supply	<input type="checkbox"/> 456 EA 3013A	<input type="checkbox"/> 457 EA 3013A	<input type="checkbox"/> 264 FSEK
otherwise	<input type="checkbox"/> 459 EA 2032-50	<input type="checkbox"/> 268 EA- 3050	<input type="checkbox"/> 494 AG6632A
	<input checked="" type="checkbox"/> 530 10dB Attenuator	<input checked="" type="checkbox"/> cable K15	<input checked="" type="checkbox"/> 354 NGPE 40

REFERENCE: §15.247(B)(1) AND RSS-210: A8.4 (2)

The maximum peak conducted output power of the intentional radiator shall not exceed the following:

(1) For frequency hopping systems (FHHS) operating in the 2400-2483.5 MHz band employing at least 75 non-overlapping hopping channels, and all frequency hopping systems in the 5725-5850 MHz band: 1 watt. For all other frequency hopping systems in the 2400-2483.5 MHz band: 0.125 watts.

(2) For frequency hopping systems operating in the 902-928 MHz band: 1 watt for systems employing at least 50 hopping channels; and, 0.25 watts for systems employing less than 50 hopping channels, but at least 25 hopping channels, as permitted under paragraph (a)(1)(i) of this section.

(3) For systems using digital modulation (DSSS) in the 902-928 MHz, 2400-2483.5 MHz, and 5725-5850 MHz bands: 1 Watt. As an alternative to a peak power measurement, compliance with the one Watt limit can be based on a measurement of the maximum conducted output power. Maximum Conducted Output Power is defined as the total transmit power delivered to all antennas and antenna elements averaged across all symbols in the signalling alphabet when the transmitter is operating at its maximum power control level. Power must be summed across all antennas and antenna elements. The average must not include any time intervals during which the transmitter is off or is transmitting at a reduced power level. If multiple modes of operation are possible (e.g., alternative modulation methods), the maximum conducted output power is the highest total transmit power occurring in any mode.

(4) The conducted output power limit specified in paragraph (b) of this section is based on the use of antennas with directional gains that do not exceed 6 dBi. Except as shown in paragraph (c) of this section, if transmitting antennas of directional gain greater than 6 dBi are used, the conducted output power from the intentional radiator shall be reduced below the stated values in paragraphs (b)(1), (b)(2), and (b)(3) of this section, as appropriate, by the amount in dB that the directional gain of the antenna exceeds 6 dBi.

ANTENNA CHARACTERISTICS:

- Directional Gain < 6 dBi (measured: difference between measured conducted and radiated eirp. power)
- Directional Gain > 6 dBi (measured / applicant's declaration) -> conducted power reduction necessary

EUT SETTINGS:

For FHHS-systems hopping mode was switched-off so fixed three different channels could be measured. The EUT was instructed to send with maximum power (if adjustable) according applicants instructions. Different modulation characteristics have been checked, e.g. data rates which EUT can operate.

MEASUREMENT METHOD:

The measurement was performed in non-hopping transmission mode with the carrier set to lowest/middle and highest channel. The power was also checked for different data rates, modulation scheme or packet types if applicable.

SETTINGS ON SPECTRUM-ANALYZER:

Center Frequency	Nominal channel frequency
Span	20 MHz
Resolution Bandwidth (RBW)	3 MHz > 20dB-Bandwidth of the signal
Video Bandwidth (VBW)	3 times the resolution bandwidth = 10MHz
Sweep time	coupled
Detector	Peak, Max hold mode
Sweep Mode	Repetitive mode

5.3.1. CONDUCTED MEASUREMENT: MAX. PEAK POWER

- Maximum declared antenna gain [isotropic]: 2.3 dBi

Results (only extract): compare Annex A1 for all power values among possible modulations/Data-Rates

MAX PEAK POWER (conducted) [dBm]			
Set-up no.: 2 Op-Mode : 1	Low channel = 0 (2402 MHz)	Middle channel = 39 (2441 MHz)	High channel = 78 (2480 MHz)
Measured Peak power for DH1 Packet type [dBm]	-- ^{1.)}	-0.59	-- ^{1.)}
Measured Peak power for 2DH5 Packet type [dBm]	-- ^{1.)}	-- ^{1.)}	1.05
Measured Peak power for 3DH1 Packet type [dBm]	-- ^{1.)}	1.53	1.53
Limit	0.125 Watt (21dBm)		

Remark: 1.) not maximum value, pls. Consult Annex A1 for full reported power values.

VERDICT: passed

5.4. Radiated field strength emissions below 30 MHz

5.4.1. Test location and equipment (for reference numbers please see chapter 'List of test equipment')

test location	<input checked="" type="checkbox"/> CETECOM Essen (Chapter. 2.2.1)	<input type="checkbox"/> Please see Chapter. 2.2.2	<input type="checkbox"/> Please see Chapter. 2.2.3
test site	<input checked="" type="checkbox"/> 441 EMI SAR	<input type="checkbox"/> 487 SAR NSA	<input type="checkbox"/> 347 Radio.lab.
receiver	<input type="checkbox"/> 377 ESCS30	<input checked="" type="checkbox"/> 001 ESS	<input type="checkbox"/>
spectr. analys.	<input type="checkbox"/> 584 FSU	<input type="checkbox"/> 120 FSEM	<input type="checkbox"/> 264 FSEK
antenna	<input type="checkbox"/> 574 BTA-L	<input type="checkbox"/> 133 EMCO3115	<input type="checkbox"/> 302 BBHA9170
signaling	<input type="checkbox"/> 392 MT8820A	<input type="checkbox"/> 436 CMU	<input type="checkbox"/> 547 CMU
otherwise	<input type="checkbox"/> 400 FTC40x15E	<input type="checkbox"/> 401 FTC40x15E	<input type="checkbox"/> 110 USB LWL
DC power	<input checked="" type="checkbox"/> 456 EA 3013A	<input type="checkbox"/> 457 EA 3013A	<input type="checkbox"/> 459 EA 2032-50
line voltage	<input type="checkbox"/> 230 V 50 Hz via public mains	<input type="checkbox"/> 060 110 V 60 Hz via PAS 5000	<input type="checkbox"/> 482 Filter Matrix
			<input type="checkbox"/> 378 RadiSense
			<input type="checkbox"/> 494 AG6632A
			<input type="checkbox"/> 498 NGPE 40

5.4.2. STANDARDS AND LIMITS: CFR 47, §15.205, §15.209, RSS-Gen, ANSI C63.10:2009,

Frequency [MHz]	Field strength		Measurement distance [meters]	Remarks
	[µV/m]	[dBuV/m]		
0.009 – 0.490	2400/f (kHz)	67.6 – 20Log(f) (kHz)	300	Correction factor used due to measurement distance of 3m
0.490 – 1.705	24000/f (kHz)	87.6 – 20 Log(f) (kHz)	30	Correction factor used due to measurement distance of 3m
1.705 – 30	30	29.54	30	Correction factor used due to measurement distance of 3m

Remark: * decreases with the logarithm of the frequency

5.4.3. TEST CONDITION AND MEASUREMENT TEST SET-UP

link to test system (if used):	<input checked="" type="checkbox"/> air link	<input type="checkbox"/> cable connection	<input type="checkbox"/>
EUT-grounding	<input checked="" type="checkbox"/> none	<input type="checkbox"/> with power supply	<input type="checkbox"/> additional connection
Equipment set up	<input checked="" type="checkbox"/> table top	<input type="checkbox"/> floor standing	
Climatic conditions	Temperature: (22±3°C)		Rel. humidity: (40±20)%
EMI-Receiver (Analyzer) Settings	Span/Range: 9kHz to 150kHz; 150 kHz to 30 MHz RBW/VBW: 200Hz/auto; 10 kHz/ auto (ANSI63.10/CISPR#16) Detector/ Mode: PEAK, TRACE max-hold mode, repetitive scan for exploratory measurements Quasi-Peak, for final measurement on critical frequencies (f<1GHz)		

5.4.4. GENERAL MEASUREMENT PROCEDURES:

The measurement test set-up and test procedure are in accordance with the provisions described in ANSI 63.10: 2009

The **Equipment under Test (EUT)** was set-up to defined operating mode and installed (connected) to accessory equipment according the general description of use given by the applicant.

The measurement loop antenna was situated in 3m distance to the EUT. Between EUT and measurement antenna absorbers are covering the GND-Plane. With these absorbers the chamber fulfills CIPR16-1-4 site VSWR-criteria. Radiated magnetic emission measurements were made with the antenna situated in 1 meter height. The loop antenna was moved at least to 2-perpendicular axes (antenna vector in direction of EUT and parallel to EUT) in order to maximize the emissions, the EUT itself either over 3-orthogonal axes (no defined usage position) or 2-orthogonal axis (defined usage position) by the position manipulator.

According the standard the compliance should be checked in 30m and 300m measurement distance. Therefore a additional extrapolation factor was used in order to normalize the measurement data. The frequency dependent extrapolation factor used for this reduced measurement distance, can be found on the end of this chapter

5.4.5. MEASUREMENT RESULTS

Due to uncritical measurements (only noise floor) measurements have been performed only with 3DH5 packets

Channel 0:

Set-up No.		1								
Operating Mode		1								
Diagram no.	Frequency (MHz)	MaxPeak (dBμV/m)	Meas. Time (ms)	Bandwidth (kHz)	Antenna height (cm)	Polarity	Turntable position (deg)	Corr. (dB) (C _F)	Margin (dB) (M)	Limit (dBμV/m) (L _T)
3.01 3.02	0.009 to 0.150	<-56.92		0.2	100	--	0°..360°	300 to 3m	>20	See diagram
	0.150 to 0.5	<-62.64		10				300 to 3m	>20	
	0.5 to 30	<-17.44		10				300 to 3m 30 to 3m	>12.1	29.54

Remark: --

Channel 39:

Set-up No.		1								
Operating Mode		1								
Diagram no.	Frequency (MHz)	MaxPeak (dBμV/m)	Meas. Time (ms)	Bandwidth (kHz)	Antenna height (cm)	Polarity	Turntable position (deg)	Corr. (dB) (C _F)	Margin (dB) (M)	Limit (dBμV/m) (L _T)
3.03 3.04	0.009 to 0.150	<-57.34	10	0.2	100	--	0°..360°	300 to 3m	>20	See diagram
	0.150 to 0.5	<-63.64		10				300 to 3m	>20	
	0.5 to 30	<17.57		10				300 to 3m 30 to 3m	>11.97	29.54

Remark: --

Channel 78:

Set-up No.		1								
Operating Mode		1								
Diagram no.	Frequency (MHz)	MaxPeak (dBµV/m)	Meas. Time (ms)	Bandwidth (kHz)	Antenna height (cm)	Polarity	Turntable position (deg)	Corr. (dB) (C _F)	Margin (dB) (M)	Limit (dBµV/m) (L _T)
3.05 3.06	0.009 to 0.150	<-57.28	10	0.2	100	--	0°..360°	300 to 3m	>20	See diagram
	0.150 to 0.5	<-63.46		10				300 to 3m	>20	
	0.5 to 30	<17.15		10				300 to 3m 30 to 3m	>12.39	29.54

Remark: --

<p>Margin to Limit:</p> $M = L_T - R_R + C_F + D_F$ $= L_T - R_R + (AF_{ANTENNA} + Cable_{LOSS}) + D_F$ <p>Remark: positive margin means passed result</p>	<p>Abbreviations used:</p> <ul style="list-style-type: none"> • R_R : Receiver readings in dBµV/m • C_F: Transducer in dB = AF (antenna factor) + CL (cable loss) • D_F : distance correction factor (if different measurement distance used than specified in the standard) • L_T : Limit in dBµV/m
---	---

VERDICT: Summary of measurement results for radiated frequencies below 30 MHz - Passed

5.4.6. Correction factors due to reduced meas. distance (f < 30 MHz)

The used correction factors when the measurement distance is reduced, are taken from IIEC Transaction EMC, Vol 47, No.3, Aug. 2005, Journal Paper "EXTRAPOLATING NEAR-FIELD EMISSIONS OF LOW-FREQUENCY LOOP TRANSMITTERS".

Used Transducer factor (f < 30 MHz)

Frequency [MHz]	AF [dB]	Corection factor		cable loss [dB]	Transducer Faktor [dB]
		300m to 3m [dB]	30m to 3m [dB]		
0,09	20,30	-116,7	-	0,00	-96,31
0,10	20,29	-115,0	-	0,00	-94,61
0,13	20,32	-114,5	-	0,00	-94,05
0,15	20,25	-113,9	-	0,00	-93,50
0,17	20,26	-113,1	-	0,00	-92,67
0,19	20,27	-116,6	-	0,00	-96,14
0,21	20,24	-112,2	-	0,00	-91,75
0,23	20,21	-111,3	-	0,00	-90,86
0,25	20,20	-111,3	-	0,00	-90,85
0,27	20,23	-110,4	-	0,00	-89,90
0,29	20,21	-108,3	-	0,00	-87,80
0,31	20,21	-107,9	-	0,00	-87,38
0,35	20,19	-105,2	-	0,00	-84,66
0,39	20,19	-116,7	-	0,00	-96,12
0,43	20,17	-102,1	-	0,00	-81,50
0,47	20,18	-99,1	-	0,00	-78,45
0,51	20,18	-	-56,4	0,10	-35,61
0,57	20,16	-	-56,2	0,10	-35,37
0,63	20,17	-	-65,1	0,10	-44,20
0,69	20,15	-	-56,0	0,10	-35,06
0,75	20,16	-	-55,7	0,10	-34,69
0,81	20,16	-	-55,7	0,10	-34,63
0,87	20,15	-	-55,5	0,10	-34,38
0,93	20,14	-	-55,4	0,10	-34,23
1,00	20,14	-	-54,9	0,20	-33,56
1,20	20,15	-	-54,9	0,20	-33,35
1,40	20,16	-	-54,4	0,30	-32,54
1,70	20,16	-	-53,7	0,30	-31,54
2,00	20,15	-	-52,2	0,40	-29,65
2,20	20,14	-	-52,0	0,40	-29,26
2,40	20,13	-	50,9	0,40	73,83
2,70	20,11	-	-49,8	0,50	-26,49
3,00	20,10	-	-47,8	0,50	-24,20
3,20	20,09	-	-46,5	0,50	-22,71
3,40	20,08	-	-45,6	0,50	-21,62
3,70	20,06	-	-43,3	0,50	-19,04
4,00	20,05	-	-41,8	0,60	-17,15
4,40	20,04	-	-40,1	0,60	-15,06
4,80	20,04	-	-38,1	0,70	-12,56
5,20	20,00	-	-37,4	0,70	-11,50
5,60	19,97	-	-36,8	0,70	-10,53
6,00	19,96	-	-35,1	0,70	-8,44
6,80	19,94	-	-33,5	0,80	-5,96
7,60	20,02	-	-30,3	0,80	-1,88
8,40	20,12	-	-28,1	0,80	1,22
9,20	20,15	-	-27,0	0,80	3,15
10,00	20,20	-	-23,9	0,90	7,20
11,00	20,22	-	-21,2	0,90	10,92
12,00	20,19	-	-20,8	0,90	12,29
13,00	20,20	-	-20,4	0,90	13,70
14,00	20,29	-	-19,8	1,00	15,49
15,00	20,45	-	-19,1	1,00	17,35
16,00	20,57	-	-18,9	1,00	18,67
17,00	20,64	-	-18,7	1,00	19,94
18,00	20,71	-	-18,4	1,10	21,41
19,00	20,79	-	-18,3	1,10	22,59
20,00	20,86	-	-18,3	1,10	23,66
22,00	20,87	-	-18,2	1,10	25,77
24,00	20,62	-	-18,3	1,10	27,42
26,00	20,10	-	-18,4	1,20	28,90
28,00	19,66	-	-18,4	1,20	30,46
30,00	19,56	-	-18,4	1,20	32,36

5.5. Radiated field strength emissions, 30 MHz - 1 GHz

5.5.1. TEST LOCATION AND EQUIPMENT (for reference numbers please see chapter 'List of test equipment')

test location	<input checked="" type="checkbox"/> CETECOM Essen (Chapter. 2.2.1)	<input type="checkbox"/> Please see Chapter. 2.2.2	<input type="checkbox"/> Please see Chapter. 2.2.3			
test site	<input checked="" type="checkbox"/> 441 EMI SAR	<input type="checkbox"/> 487 SAR NSA				
receiver	<input checked="" type="checkbox"/> 377 ESCS30	<input checked="" type="checkbox"/> 001 ESS	<input type="checkbox"/>			
spectr. analys.	<input type="checkbox"/> 584 FSU	<input type="checkbox"/> 120 FSEM	<input type="checkbox"/> 264 FSEK			
antenna	<input type="checkbox"/> 574 BTA-L	<input type="checkbox"/> 133 EMCO3115	<input type="checkbox"/> 302 BBHA9170	<input type="checkbox"/> 289 CBL 6141	<input type="checkbox"/> 030 HFH-Z2	<input type="checkbox"/> 477 GPS
signaling	<input type="checkbox"/> 392 MT8820A	<input type="checkbox"/> 436 CMU	<input type="checkbox"/> 547 CMU			
otherwise	<input type="checkbox"/> 400 FTC40x15E	<input type="checkbox"/> 401 FTC40x15E	<input type="checkbox"/> 110 USB LWL	<input checked="" type="checkbox"/> 482 Filter Matrix		
DC power	<input checked="" type="checkbox"/> 456 EA 3013A	<input type="checkbox"/> 457 EA 3013A	<input type="checkbox"/> 459 EA 2032-50	<input type="checkbox"/> 268 EA- 3050	<input type="checkbox"/> 494 AG6632A	<input type="checkbox"/> 498 NGPE
line voltage	<input type="checkbox"/> 230 V 50 Hz via public mains	<input type="checkbox"/> 060 110 V 60 Hz via PAS 5000				

5.5.2. STANDARDS AND LIMITS: CFR 47, PART 15B, §15.209, RSS-Gen, ANSI C63.4:2009 (RX), 63.10:2009 (TX)

Frequency [MHz]	<input checked="" type="checkbox"/> Radiated emission limits, Class B, 3 meters	
	QUASI-Peak [microvolts/meter]	QUASI-Peak [dBµV/m]
30-88	100	40
88-216	150	43,5
216-960	200	46,0
above 960	500	54,0

5.5.3. TEST CONDITION AND MEASUREMENT TEST SET-UP

link to test system (if used):	<input checked="" type="checkbox"/> air link	<input type="checkbox"/> cable connection	<input type="checkbox"/>
EUT-grounding	<input checked="" type="checkbox"/> none	<input type="checkbox"/> with power supply	<input type="checkbox"/> additional connection
Equipment set up	<input checked="" type="checkbox"/> table top 0.8m height	<input type="checkbox"/> floor standing	
Climatic conditions	Temperature: (22±3°C)		Rel. humidity: (40±20)%
EMI-Receiver (Analyzer) Settings	Span/Range: 30 MHz to 1 GHz RBW/VBW: 120 kHz / (auto)		

5.5.4. RESTRICTED BANDS OF OPERATION, §15.205

MHz	MHz	MHz	GHz
0.090-0.110	16.42-16.423	399.9-410	4.5-5.15
0.495-0.505	16.69475-16.69525	608-614	5.35-5.46
2.1735-2.1905	16.80425-16.80475	960-1240	7.25-7.75
4.125-4.128	25.5-25.67	1300-1427	8.025-8.5
4.20725-4.20775	37.5-38.25	1645.5-1646.5	9.3-9.5
6.215-6.218	73-74.6	1660-1710	10.6-12.7
6.26775-6.26825	74.8-75.2	1718.8-1722.2	13.25-13.4
6.31175-6.31225	108-121.94	2200-2300	14.47-14.5
8.291-8.294	123-138	2310-2390	15.35-16.2
8.362-8.366	149.9-150.05	2483.5-2500	17.7-21.4
8.37625-8.38675	156.52475-156.52525	2690-2900	22.01-23.12
8.41425-8.41475	156.7-156.9	3260-3267	23.6-24.0
12.29-12.293	162.0125-167.17	3332-3339	31.2-31.8
12.51975-12.52025	167.72-173.2	3345.8-3358	36.43-36.5
12.57675-12.57725	240-285	3600-4400	--
13.36-13.41	322-335.4	--	--

Remark: only spurious emissions are allowed within these frequency bands not exceeding the limits per §15.209

5.5.5. GENERAL MEASUREMENT PROCEDURES:

The measurement test set-up and test procedure are in accordance with the provisions described in ANSI63.10:2009

The *Equipment under Test* (EUT) set-up to defined operating mode and installed (connected) to accessory equipment according the general description of use given by the applicant.

5.5.6. MEASUREMENT RESULTS FOR TX MODE

Channel low (Channel 0)

Set-up No.		1								
Operating Mode		1								
Diagram no.	Frequency (MHz)	MaxPeak (dBµV/m)	Meas. Time (ms)	Bandwidth (kHz)	Antenna height (cm)	Polarity	Turntable position (deg)	Corr. (dB) (C _F)	Margin (dB) (M)	Limit (dBµV/m) (L _T)
2.01 2.02	36.64	27.58	10	120	1-4m	H/V	0°..360°	--	12.42	40.0
	943.64	41.66	10	120	1-4m	H/V	0°..360°	--	4.34	46.0

Remark: --

Channel Middle (Channel 39)

Set-up No.		1								
Operating Mode		1								
Diagram no.	Frequency (MHz)	MaxPeak (dBµV/m)	Meas. Time (ms)	Bandwidth (kHz)	Antenna height (cm)	Polarity	Turntable position (deg)	Corr. (dB) (C _F)	Margin (dB) (M)	Limit (dBµV/m) (L _T)
2.03 2.04	31.20	30.98	10	120	1-4m	H/V	0°..360°	--	9.02	40.0
	951.92	41.87	10	120	1-4m	H/V	0°..360°	--	4.13	46.0

Remark: --

Channel high (Channel 78)

Set-up No.		1								
Operating Mode		1								
Diagram no.	Frequency (MHz)	MaxPeak (dBµV/m)	Meas. Time (ms)	Bandwidth (kHz)	Antenna height (cm)	Polarity	Turntable position (deg)	Corr. (dB) (C _F)	Margin (dB) (M)	Limit (dBµV/m) (L _T)
2.05 2.06	30.60	28.08	10	120	1-4m	H/V	0°..360°	--	11.92	40.0
	973.76	41.72	10	120	1-4m	H/V	0°..360°	--	12.28	46.0

Remark: --

5.5.7. MEASUREMENT RESULTS FOR RX MODE

Channel middle (Channel 39)

Set-up No.		1								
Operating Mode		2								
Diagram no.	Frequency (MHz)	MaxPeak (dBµV/m)	Meas. Time (ms)	Bandwidth (kHz)	Antenna height (m)	Polarity	Turntable position (deg)	Corr. (dB) (C _F)	Margin (dB) (M)	Limit (dBµV/m) (L _T)
2.07 2.08	31.76	29.64	10	120	1-4m	H/V	0°..360°	--	10.36	40.0
	961.08	42.26	10	120	1-4m	H/V	0°..360°	--	11.74	46.0

Remark: --

<p>Margin to Limit:</p> $M = L_T - R_R + C_F + D_F$ $= L_T - R_R + (AF_{ANTENNA} + Cable_{LOSS}) + D_F$ <p>Remark: positive margin means passed result</p>	<p>Abbreviations used:</p> <ul style="list-style-type: none"> • R_R : Receiver readings in dBµV/m • C_F: Transducer in dB = AF (antenna factor) + CL (cable loss) • D_F: distance correction factor (if different measurement distance used than specified in the standard) • L_T : Limit in dBµV/m
---	--

5.5.8. VERDICT

Summary of measurement results for radiated emissions above 30 MHz and below 1 GHz : Passed

5.6. Radiated emissions, above 1GHz

TEST LOCATION AND EQUIPMENT (for reference numbers please see chapter 'List of test equipment')

test site	<input type="checkbox"/> 441 EMI SAR	<input type="checkbox"/> 348 EMI cond.	<input checked="" type="checkbox"/> 443 EMI FAR	<input type="checkbox"/> 347 Radio.lab.	<input type="checkbox"/> 337 OATS	<input type="checkbox"/>
equipment	<input type="checkbox"/> 331 HC 4055	<input type="checkbox"/>	<input type="checkbox"/>	<input type="checkbox"/>	<input type="checkbox"/>	<input type="checkbox"/>
spectr. analys.	<input type="checkbox"/> 584 FSU	<input type="checkbox"/> 120 FSEM	<input type="checkbox"/> 264 FSEK	<input checked="" type="checkbox"/> 489 ESU	<input type="checkbox"/>	<input type="checkbox"/>
antenna meas	<input type="checkbox"/> 574 BTA-L	<input type="checkbox"/> 289 CBL 6141	<input type="checkbox"/> 608 HL 562	<input checked="" type="checkbox"/> 549 HL025	<input type="checkbox"/> 302 BBHA9170	<input type="checkbox"/> 477 GPS
antenna meas	<input type="checkbox"/> 123 HUF-Z2	<input type="checkbox"/> 132 HUF-Z3	<input type="checkbox"/> 030 HFH-Z2	<input type="checkbox"/>	<input type="checkbox"/>	<input type="checkbox"/>
antenna subst	<input type="checkbox"/> 071 HUF-Z2	<input type="checkbox"/> 020 EMCO3115	<input type="checkbox"/> 063 LP 3146	<input type="checkbox"/> 303 BBHA9170	<input type="checkbox"/>	<input type="checkbox"/>
power meter	<input type="checkbox"/> 009 NRV	<input type="checkbox"/> 010 URV5-Z2	<input type="checkbox"/> 011 URV5-Z2	<input type="checkbox"/>	<input type="checkbox"/>	<input type="checkbox"/>
signalgener.	<input type="checkbox"/> 008 SMG	<input type="checkbox"/> 140 SMHU	<input type="checkbox"/> 263 SMP04	<input type="checkbox"/>	<input type="checkbox"/>	<input type="checkbox"/>
power meter	<input type="checkbox"/> 262 NRV-S	<input type="checkbox"/> 266 NRV-Z31	<input type="checkbox"/> 265 NRV-Z33	<input type="checkbox"/> 261 NRV-Z55	<input type="checkbox"/> 356 NRV-Z1	<input type="checkbox"/>
multimeter	<input type="checkbox"/> 341 Fluke 112	<input type="checkbox"/>	<input type="checkbox"/>	<input type="checkbox"/>	<input type="checkbox"/>	<input type="checkbox"/>
signaling	<input type="checkbox"/> 392 MT8820A	<input type="checkbox"/> 436 CMU	<input type="checkbox"/> 547 CMU			
DCpower	<input checked="" type="checkbox"/> 611 E3632A 0	<input type="checkbox"/> 087 EA3013	<input type="checkbox"/> 354 NGPE 40	<input type="checkbox"/> 349 car battery	<input type="checkbox"/> 350 Car battery	<input type="checkbox"/>
line voltage	<input type="checkbox"/> 230 V 50 Hz via public mains		<input type="checkbox"/> 060 110 V 60 Hz via PAS 5000			

STANDARDS AND LIMITS: CFR 47, §15.109 (CLASS B), RSS-Gen, RSS-210, ANSI C63.4:2009 (RX), 63.10:2009 (TX)

Frequency [MHz]	Radiated emission limits, 3 meters measurement distance			
	<input checked="" type="checkbox"/> 3 meters measurement distance			
	AV		Peak	
	[microvolts/meter]	[dBuV/m]	[microvolts/meter]	[dBuV/m]
above 1GHz	500	54.0	5000	74.0

TEST CONDITION AND MEASUREMENT TEST SET-UP

link to test system (if used):	<input checked="" type="checkbox"/> air link	<input type="checkbox"/> cable connection	<input type="checkbox"/>
EUT-grounding	<input checked="" type="checkbox"/> none	<input type="checkbox"/> with power supply	<input type="checkbox"/> additional connection
Equipment set up	<input checked="" type="checkbox"/> table top 1.5m height		<input type="checkbox"/> floor standing
Climatic conditions	Temperature: (22±3°C)		Rel. humidity: (40±20)%
Spectrum-Analyzer settings	Span/Frequency range : 1..18 GHz RBW/VBW: 1 MHz / 3 MHz Detector/ Mode: Peak, MAX-hold, repetitive scan for exploratory measurement PEAK/ AVERAGE, for final measurement for critical frequencies Antenna Polarisation Horizontal / Vertical		

GENERAL MEASUREMENT PROCEDURES:

The measurement test set-up and test procedure are in accordance with the provisions described in ANSI 63.4: 2009 for RX operating mode and ANSI 63.10:2009 for TX operating mode.

The *Equipment under Test* (EUT) was placed on a non-conductive positioning table of 0.8 or 1.5 meter height depending from the frequency range. The measuring distance was set to 3 meter for frequencies up to 18GHz and 1 meter above 18GHz.

The EUT was set-up to defined operating mode and installed (connected) to accessory equipment according the general description of use given by the applicant.

1. Step exploratory measurement: see above description as in the frequency range lower 1GHz.

2. Step Final Measurement(1 GHz <math>f < 18 GHz)</math>: On the Worst-Case EUT configuration, frequency components with a margin lower than 6 dB to the limits, will be re-measured by maintaining the EUT's operating mode, cable position, etc.. For find the worst-case emission, the turntable was changed in the range 0 to 360 degree and the EUT itself either over 3-orthogonal axis (not defined usage position) or 2-orthogonal axis (defined usage position). The measurements are performed for both polarizations of the measuring antenna: horizontal and vertical.

5.6.1. MEASUREMENT RESULTS FOR TX MODE

Set-up No.:		1									
Operating Mode:		1									
Channel no.		0									
Diagram no.	Frequency (MHz)	MaxPeak (dBμV/m)	Meas Time (ms)	Bandwidth (kHz)	Antenna height (cm)	Polarity	Turntable position (deg)	Corr. (dB) (C _F)	Margin (dB) (M)	Limit (dBμV/m) (L _T)	
2.10	PK-detector										
	1000-2800	<60.0	10	1000	155	H/V	0°..360°	--	>14	74.0	
	AV-detector										
	1503.9	43.11	100	1000	155	H	312°	30.27	10.88	54.0	
1000-2800	<46.0	10	1000	155	H/V	0°..360°	--	>8.0			
2.11	PK-detector										
	2800..18000	< 64.13	10	1000	155	H/V	0°..360°	--	>9.87	74.0	
	AV-detector										
	2800..18000	<50.51	10	1000	155	H/V	0°..360°	--	>4.49	54.0	
--1.)	18000-25000	<60.41 (PK) <50.10 (AV)	10	500	--	--	--	--	>13.59 (PK) >4.83 (AV)	74 (PK) 54 (AV)	

Remark: Overview measurement only -> no critical harmonics found

Set-up No.:		1									
Operating Mode:		1									
Channel no.		39									
Diagram no.	Frequency (MHz)	MaxPeak (dBμV/m)	Meas Time (ms)	Bandwidth (kHz)	Antenna height (cm)	Polarity	Turntable position (deg)	Corr. (dB) (C _F)	Margin (dB) (M)	Limit (dBμV/m) (L _T)	
2.12	PK-detector										
	1000-2800	<58.0	10	1000	155	H/V	0°..360°	--	>12.0	74.0	
	AV-detector										
	1170.1	40.75	100	1000	155	H	166°	27.51	13.20	54.0	
1000-2800	<46.0	10	1000	155	H/V	0°..360°	--	>8.0			
2.13	PK-detector										
	2800..18000	< 63.42	10	1000	155	H/V	0°..360°	--	>10.58	74.0	
	AV-detector										
	2800..18000	<50.27	10	1000	155	H/V	0°..360°	--	>4.73	54.0	
--1.)	18000-25000	<60.15 (PK) <50.23 (AV)	10	500	--	--	--	--	>13.85 (PK) >3.77 (AV)	74 (PK) 54 (AV)	

Remark: Overview measurement only -> no critical harmonics found

Set-up No.:		1									
Operating Mode:		1									
Channel no.		78									
Diagram no.	Frequency (MHz)	MaxPeak (dB μ V/m)	Meas Time (ms)	Bandwidth (kHz)	Antenna height (cm)	Polarity	Turntable position (deg)	Corr. (dB) (C _F)	Margin (dB) (M)	Limit (dB μ V/m) (L _T)	
2.14	PK-detector										
	1000-2800	<57.94	10	1000	155	H/V	0°..360°	--	>16.06	74.0	
	AV-detector										
	1169.4	40.67	100	1000	155	V	166.0	27.51	13.3	54.0	
	1436.5	42.33	100	1000	155	V	-26.0	29.73	11.7		
	1504.6	43.07	100	1000	155	H	316.0	30.28	10.9		
1000-2800	<46.0	10	1000	155	H/V	0°..360°	--	>8.0			
2.15	PK-detector										
	2800..18000	< 64.00	10	1000	155	H/V	0°..360°	--	>10.0	74.0	
	AV-detector										
	2800..18000	<50.5	10	1000	155	H/V	0°..360°	--	>4.5	54.0	
--1.)	18000-25000	<60.12 (PK) <50.22 (AV)	10	500	--	--	--	--	>13.88 (PK) >3.78 (AV)	74 (PK) 54 (AV)	

Remark: Overview measurement only -> no critical harmonics found

5.6.2. MEASUREMENT RESULTS FOR RX MODE

Set-up No.:		1								
Operating Mode:		1								
Channel no.		78								
Diagram no.	Frequency (MHz)	MaxPeak (dBμV/m)	Meas Time (ms)	Bandwidth (kHz)	Antenna height (cm)	Polarity	Turntable position (deg)	Corr. (dB) (C _F)	Margin (dB) (M)	Limit (dBμV/m) (L _T)
2.22a	PK-detector									
	1000-2800	<47.84	10	1000	155	H/V	0°..360°	--	>26.20	74.0
	AV-detector									
	1000-2800	<31.99	10	1000	155	H/V	0°..360°	--	>22.0	54.0
2.22b	PK-detector									
	2800..6000	< 45.63	10	1000	155	H/V	0°..360°	--	>29.80	74.0
	AV-detector									
	2800..6000	<31.58	10	1000	155	H/V	0°..360°	--	>22.40	54.0
2.22c	6000-20000	<67.77 (PK) < 52.78 (AV)	10	1000	155	H/V	0°..360°	--	>6.23 (PK) >2.3 (AV)	54.0

Remark: --

<p>Margin to Limit:</p> $M = L_T - R_R + C_F + D_F$ $= L_T - R_R + (AF_{ANTENNA} + Cable_{LOSS}) + D_F$ <p>Remark: positive margin means passed result</p>	<p>Abbreviations used:</p> <ul style="list-style-type: none"> • R_R : Receiver readings in dBμV/m • C_F: Transducer in dB = AF (antenna factor) + CL (cable loss) • D_F : distance correction factor (if different measurement distance used than specified in the standard) • L_T : Limit in dBμV/m
---	---

VERDICT

Summary of measurement results for radiated emissions above 1 GHz: Passed

5.7. Radiated measurement: Max. E.I.R.P Power

Test location and equipment (for reference numbers please see chapter 'List of test equipment')

test site	<input type="checkbox"/> 441 EMI SAR	<input type="checkbox"/> 348 EMI cond.	<input checked="" type="checkbox"/> 443 EMI FAR	<input type="checkbox"/> 347 Radio.lab.	<input type="checkbox"/> 337 OATS	<input type="checkbox"/>
equipment	<input type="checkbox"/> 331 HC 4055	<input type="checkbox"/>	<input type="checkbox"/>	<input type="checkbox"/>	<input type="checkbox"/>	<input type="checkbox"/>
Spectr. analys.	<input type="checkbox"/> 489 ESU	<input type="checkbox"/> 120 FSEM	<input type="checkbox"/> 264 FSEK	<input checked="" type="checkbox"/> 489 ESU	<input type="checkbox"/>	<input type="checkbox"/>
antenna meas	<input checked="" type="checkbox"/> 549 HL025	<input type="checkbox"/> 289 CBL 6141	<input type="checkbox"/> 439 HL 562	<input type="checkbox"/> 133 EMCO3115	<input type="checkbox"/> 302 BBHA9170	<input type="checkbox"/> 477 GPS
antenna subst	<input type="checkbox"/> 071 HUF-Z2	<input type="checkbox"/> 020 EMCO3115	<input type="checkbox"/> 063 LP 3146	<input type="checkbox"/> 303 BBHA9170	<input type="checkbox"/>	<input type="checkbox"/>
power meter	<input type="checkbox"/> 009 NRV	<input type="checkbox"/> 010 URV5-Z2	<input type="checkbox"/> 011 URV5-Z2	<input type="checkbox"/>	<input type="checkbox"/>	<input type="checkbox"/>
Signalgener.	<input type="checkbox"/> 008 SMG	<input type="checkbox"/> 140 SMHU	<input type="checkbox"/> 263 SMP04	<input type="checkbox"/>	<input type="checkbox"/>	<input type="checkbox"/>
power meter	<input type="checkbox"/> 262 NRV-S	<input type="checkbox"/> 266 NRV-Z31	<input type="checkbox"/> 265 NRV-Z33	<input type="checkbox"/> 261 NRV-Z55	<input type="checkbox"/> 356 NRV-Z1	<input type="checkbox"/>
DCpower	<input checked="" type="checkbox"/> 611 E3632A	<input type="checkbox"/> 087 EA3013	<input type="checkbox"/> 354 NGPE 40	<input type="checkbox"/> 349 car battery	<input type="checkbox"/> 350 Car battery	<input type="checkbox"/>

EUT SETTINGS:

For FHHS-systems hopping mode was switched-off so fixed three different channels could be measured. The EUT was instructed to send with maximum power (if adjustable) according applicants instructions. Different modulation characteristics have been checked, e.g. data rates which EUT can operate.

Measurement method: a field strength measurement was performed in 3m distance to the EUT. General measurement procedures as shown in chapter 4.2 applies therefore. Using transformation formula between field strength and e.i.r.p. power as shown in ANSI63.10: 2009, chapter 7.8.2 is used for conversion. In addition a 2dB bandwidth correction factor applied: $10 * \log(6\text{dB BW/RBW}=1\text{MHz})$

MAX. FIELD STRENGTH MEASURED IN 3m DISTANCE

Maximum Radiated field strength@3m distance			
Set-up no.: 1 Op. Mode: 1 (DH5)	Low channel = 0 (2402 MHz)	Middle channel = 39 (2441 MHz)	High channel = 78 (2480 MHz)
Determined field strength [dBuV/m] in 3m distance with RBW=1MHz	91.37 (PK) 88.85 (AV)	94.12 (PK) 91.67 (AV)	95.20 (PK) 92.60 (AV)
Value in dBm using conversion formula and assumed numeric Gain=1: $E = \sqrt{\left(\frac{30 * P * G}{d^2}\right)}$	-3.85 (PK)	-1.10 (PK)	-0.02 (PK)
Bandwidth correction factor ^{1.)}	0 (RBW=1MHz > 20dB BW)		
e.i.r.p. power [dBm] assumed 0dBi gain	-3.85	-1.10	-0.02
Actual declared gain of antenna by applicant [dBi]	2.3		
Final Result e.i.r.p. [dBm]:	-1.55	1.2	2.28

Remark: 1.) see 20dB BW results before in chapter 5.1

Maximum Radiated field strength@3m distance			
Set-up no.: 1 Op. Mode: 1 (3DH5)	Low channel = 0 (2402 MHz)	Middle channel = 39 (2441 MHz)	High channel = 78 (2480 MHz)
Determined field strength [dBuV/m] in 3m distance with RBW=1MHz	92.28 (PK) 86.42 (AV)	95.09 (PK) 89.24 (AV)	96.14 (PK) 90.66 (AV)
Value in dBm using conversion formula and assumed numeric Gain=1: $E = \sqrt{\left(\frac{30 * P * G}{d^2}\right)}$	-2.94 (PK)	-0.13 (PK)	0.91 (PK)
Bandwidth correction factor ^{1.)}	0.89	0.90	0.93
e.i.r.p. power [dBm] assumed 0dBi gain	-2.04	0.77	1.84
Actual declared gain of antenna by applicant [dBi]	2.3		
Final Result e.i.r.p. [dBm]:	0.26	3.07	4.14

Remark: 1.) see 20dB BW results before in chapter 5.1

VERDICT: pass, Maximum value: 4.14 dBm (antenna gain < 6 dBi)

5.8. Band-Edge compliance measurements

TEST LOCATION AND EQUIPMENT (for reference numbers please see chapter 'List of test equipment')

test location	<input checked="" type="checkbox"/> CETECOM Essen (Chapter. 2.2.1)	<input checked="" type="checkbox"/> 443 System CTC-FAR-EMI-	<input type="checkbox"/> Please see Chapter. 2.2.3			
test site	<input type="checkbox"/> 441 EMI SAR	<input type="checkbox"/> 487 SAR NSA	<input type="checkbox"/> 337 OATS	<input type="checkbox"/> 347 Radio.lab.	<input type="checkbox"/>	<input type="checkbox"/>
receiver	<input type="checkbox"/> 377 ESCS30	<input type="checkbox"/> 001 ESS	<input checked="" type="checkbox"/> 489 ESU	<input type="checkbox"/>	<input type="checkbox"/>	<input type="checkbox"/>
antenna meas	<input checked="" type="checkbox"/> 549 HL025	<input type="checkbox"/> 289 CBL 6141	<input type="checkbox"/> 439 HL 562	<input type="checkbox"/> 133 EMCO3115	<input type="checkbox"/> 302 BBHA9170	
power supply	<input checked="" type="checkbox"/> 611 E3632A	<input type="checkbox"/> 457 EA 3013A	<input type="checkbox"/> 459 EA 2032-50	<input type="checkbox"/> 268 EA- 3050	<input checked="" type="checkbox"/> 494 AG6632A	<input type="checkbox"/> 498 NGPE 40
otherwise	<input type="checkbox"/> 530 10dB Attenuator			<input type="checkbox"/> cable K15		

MEASUREMENT METHOD:

A Delta marker method was used for showing compliance to restricted bands according §15.205. The method is according Public Notice “Marker-Delta method”, Extract from DA00-705. The method consists of three independent steps:

1. Step: Prior to the measurement the fundamental radiated In-Band field strength was performed. The determined value is used as reference value.
2. Step: Second step consist of finding the relative attenuation between the fundamental emission and the maximum local out-of-band emission (within 2 MHz range around the band edge either on the band-edge directly or some modulation product if the level is greater than that on the band-edge) when measured with lower resolution bandwidth.
3. Step: The delta value recorded in step 2 will be subtracted from value recorded in step 1, thus giving the required field strength at the band-edge. This value must fulfil the requirements for radiated spurious emissions in restricted bands in §15.205 with the general limits of §15.209.

EUT SETTINGS:

For frequency-hopping systems (FHSS) the measurement is done in hopping mode off at fixed low and high channels.

For DTS systems the measurement was performed with 3DH5 modulation.

RESULTS

Set-up: 1				
Op. Mode: 1				
$T_{NOM} = 21^{\circ}C$, $V_{NOM} = 13.5 V$	Fundamental field strength-radiated [dBµV/m]	Delta Marker Value [dB]	Value at Band-Edge [dBµV/m]	Verdict
Channel Low	92.28 (PK) 86.42 (AV)	43.03	47.94	Passed
Channel High	96.14 (PK) 90.66 (AV)	51.68	38.98	Passed

VERDICT: pass

5.9. Channel carrier frequency separation for FHHS-systems

TEST LOCATION AND EQUIPMENT (for reference numbers please see chapter 'List of test equipment')

test location	<input checked="" type="checkbox"/> CETECOM Essen (Chapter. 2.2.1)	<input type="checkbox"/> Please see Chapter. 2.2.2	<input type="checkbox"/> Please see Chapter. 2.2.3
test site	<input type="checkbox"/> 441 EMI SAR	<input type="checkbox"/> 487 SAR NSA	<input type="checkbox"/> 337 OATS
receiver	<input type="checkbox"/> 377 ESCS30	<input type="checkbox"/> 001 ESS	<input checked="" type="checkbox"/> 489 ESU
spectr. analys.	<input type="checkbox"/> 381 380 FSBS	<input type="checkbox"/> 120 FSEM	<input type="checkbox"/> 264 FSEK
otherwise	<input checked="" type="checkbox"/> 530 10dB Attenuator		<input checked="" type="checkbox"/> cable K15

REFERENCES: §15.247(a)(1), RSS-210:A8.1(b)

(1) FHHS Frequency hopping systems shall have hopping channel carrier frequencies separated by a minimum of 25 kHz or the 20 dB bandwidth of the hopping channel, whichever is greater. Alternatively, frequency hopping systems operating in the 2400-2483.5 MHz band may have hopping channel carrier frequencies that are separated by 25 kHz or two-thirds of the 20 dB bandwidth of the hopping channel, whichever is greater, provided the systems operate with an output power no greater than 125 mW.

(2) DSSS Systems using digital modulation techniques may operate in the 902-928 MHz, 2400-2483.5 MHz, and 5725-5850 MHz bands. The minimum 6 dB bandwidth shall be at least 500 kHz.

MEASUREMENT METHOD

The measurement to prove this requirement was performed with a low RBW of 100kHz, peak detector and trace Hold-Max function in order to resolve each frequency carrier separately.

The span of the frequency analyzer was set to cover the carrier investigated as well as its neighbour channels. A frequency DELTA Marker method was set to measure the frequency separation between the channels.

RESULTS

Set-up No. 2 Op. Mode 1	CHANNEL SEPARATION
T _{NOM} =21°C V _{NOM} =13.5V	Measured around middle channel 39 (2441 MHz)
Measured Result for: DH5 and 3DH1 packet types	1 MHz
Applicants declared value	1 MHz

LIMIT

Either:

1. 25 kHz or 20dB BW

Or

2. 25kHz and 2/3of BW if Power<125mW

VERDICT: pass

5.10. Specification for hopping channel numbers and time of occupancy for FHHS-systems

5.10.1. Test location and equipment (for reference numbers please see chapter 'List of test equipment')

test location	<input checked="" type="checkbox"/> CETECOM Essen (Chapter. 2.2.1)	<input type="checkbox"/> Please see Chapter. 2.2.2	<input type="checkbox"/> Please see Chapter. 2.2.3
test site	<input type="checkbox"/> 441 EMI SAR	<input type="checkbox"/> 487 SAR NSA	<input type="checkbox"/> 337 OATS
receiver	<input type="checkbox"/> 377 ESCS30	<input type="checkbox"/> 001 ESS	<input checked="" type="checkbox"/> 489 ESU
spectr. analys.	<input type="checkbox"/> 489 ESU	<input type="checkbox"/> 120 FSEM	<input type="checkbox"/> 264 FSEK
power supply	<input type="checkbox"/> 456 EA 3013A	<input type="checkbox"/> 457 EA 3013A	<input type="checkbox"/> 459 EA 2032-50
otherwise	<input checked="" type="checkbox"/> 530 10dB Attenuator		<input checked="" type="checkbox"/> cable K15

REFERENCE: §15.247(A)(1)(III) AND RSS-210, A8.1(d)

Frequency hopping systems in the 2400-2483.5 MHz band shall use at least 15 channels. The average time of occupancy on any channel shall not be greater than 0.4 seconds within a period of 0.4 seconds multiplied by the number of hopping channels employed. Frequency hopping systems may avoid or suppress transmissions on a particular hopping frequency provided that a minimum of 15 channels are used.

METHOD FOR MEASUREMENT OF THE CHANNEL NUMBERS:

The measurement was performed with spectrum analyzer’s RBW set to 100kHz. The device was set to work within the defined specification with frequency hopping mode set on. The spectrum-analyzer was set to MAX-Hold positive peak detector mode. After a trace stabilization period the trace is recorded and the number of channels counted.

RESULTS

SET-UP NO. 2 OP. MODE 1	NUMBER OF CHANNELS
T _{NOM} = 21°C V _{NOM} = 13.5 V	79

Remark: see diagrams enclosed in the separate annex A1, for better accuracy reading the sweep over the declared frequency range was splitted in two separated sweeps.

METHOD FOR MEASURING THE OCCUPANCY TIME:

The measurement was performed with a spectrum analyzer set to ZERO span. The device was set to work within the defined specification with frequency hopping mode on. The spectrum-analyzer was set the MAX-Hold positive peak detector mode. The sweep time set as long as necessary to capture the full signal burst per hopping channel. The burst on-period is captured by setting appropriate markers in the rising and falling edges.

RESULTS

SET-UP NO. 2 OP. MODE 1	OCCUPANCY TIME PER TRANSMISSION [ms]		
	DH3 modulation	2DH5 modulation	3DH1 modulation
T _{NOM} = 21°C V _{NOM} = 13.5V	1.6987 ms	2.9487 ms	448.71 μs

Remarks: diagrams can be found in separate annex A1

Calculations

Formula for calculating the dwell time (pseudo-hopping sequence over all channels assumed):

$$\text{Average Dwell Time: } \textit{Timeslot length} \cdot \frac{\textit{Hop rate}}{\textit{number of hopping channels}} \cdot \textit{time period}$$

For Bluetooth® following is valid:

The maximum staying time of 0.4 seconds within a 31.6 second period in data mode is constant for Bluetooth® devices and independent from the packet type. For longer packet types the hopping data rate is reduced according to the packet type length in order to comply with this requirement.

- DH1/2DH1/3DH1 Paket type:** Hop rate 1600 1/s (basic hop rate)
- DH3/2DH3/3DH3 Paket type:** Hop rate 1600 1/s /3 = approx. 533.33 1/s
- DH5/2DH5/3DH5 Paket type:** Hop rate 1600 1/s /5 = approx. 320 1/s

On one channel **per one second:**

DH1/2DH1/3DH1 Paket types: 1600 1/s /79 channels: 20.25 transmissions; per 31.6 seconds period = approx 640 transmissions

DH3/2DH3/3DH3 Paket types: 533.33 1/s /79 channels: 6.75 transmissions; per 31.6 seconds period = approx. 214 transmissions

DH5/2DH5/3DH5 Paket types: 320 1/s /79 channels: 4.05 transmissions; per 31.6seconds period = approx. 128 transmissions

Measured pulse width for **different** packet types/modulations (see annex A1 for diagrams):

- DH1/2DH1/3DH1:** 448.71 us – total time per 31.6 seconds period => 448.71us * 640 transmissions = 287.17ms
- DH3/2DH3/3DH3:** 1.698ms - total time per 31.6seconds period => 1.698ms * 214 transmissions = 363.37ms
- DH5/2DH5/3DH5:** 2.948ms –total time per 31.6 seconds period=> 2.948ms * 128 transmissions = 377.34ms

VERDICT: Pass < 400 msec

5.11. Requirements on channel use, average channel use, input bandwidth and synchronization between signals for FHSS-systems

REQUIREMENT:

The system shall hop to channel frequencies that are selected at the system hopping rate from a pseudo randomly ordered list of hopping frequencies.

RESULT:

The above requirement is implemented in the firmware of the device. Please find applicant's separate declaration of compliance with Bluetooth tests and Core specifications.

REQUIREMENT:

Each frequency must be used equally on the average by each transmitter.

RESULT:

The above requirement is implemented in the firmware of the device. Please find applicant's separate declaration of compliance with Bluetooth tests and Core specifications.

REQUIREMENT:

The system receivers shall have input bandwidths that match the hopping channel bandwidths of their corresponding transmitters and ..

RESULT:

Please find applicant's separate declaration of compliance with Bluetooth tests and Core specifications.

REQUIREMENT:

The system receivers shall shift frequencies in synchronization with the transmitted signals.

RESULT:

The synchronization requirement is implemented in the firmware of the device – Please find applicant's separate declaration of compliance with Bluetooth® Core specifications.

5.12. Measurement uncertainties

The reported uncertainties are calculated based on the standard uncertainty multiplied with the appropriate coverage factor **k**, such that a confidence level of approximately 95% is achieved. For uncertainty determination, each component used in the concrete measurement set-up was taken in account and it's contribution to the overall uncertainty according it's statistical distribution calculated.

Following table shows expectable uncertainties for each measurement type performed.

RF-Measurement	Frequency range	Calculated uncertainty based on a confidence level of 95%	Remarks:
Power Output conducted	9 kHz .. 20 GHz	1 dB	--
Power Output radiated	30 MHz .. 4 GHz	3,17 dB	Substitution method
Conducted emissions on antenna ports	9 kHz .. 20 GHz	1 dB	--
Radiated emissions enclosure	150 kHz .. 30 MHz	5 dB	Magnetic field
	30 MHz .. 1 GHz	4.2 dB	E-Field
	1 GHz .. 20 GHz	3.17 dB	Substitution method
Occupied bandwidth	9 kHz .. 4 GHz	0,1272 ppm (Delta Marker)	Frequency error
		1 dB	Power
Emission bandwidth	9 kHz .. 4 GHz	0.1272 ppm (Delta Marker)	Frequency error
		1 dB	Power
Frequency stability	9 kHz .. 20 GHz	0,0636 ppm	--
Conducted emissions on AC-mains port (U _{CISPR})	9 kHz .. 150 kHz	4 dB	--
	150 kHz .. 30 MHz	3.6 dB	--

Table: measurement uncertainties, valid for conducted/radiated measurements

6. Accreditation details of CETECOM's laboratories and test sites

Ref.-No.	Accreditation Certificate	Valid for laboratory area or test site	Accreditation Body
-	D-PL-12047-01-01	All laboratories and test sites of CETECOM GmbH, Essen	DAkKS, Deutsche Akkreditierungsstelle GmbH
337 487 558 348 348	736496	Radiated Measurements 30 MHz to 1 GHz, 3 m / 10 m (OATS) Radiated Measurements 30 MHz to 1 GHz, 3 m (SAR) Radiated Measurements above 1 GHz, 3 m (FAR) Mains Ports Conducted Interference Measurements Telecommunication Ports Conducted Interference Measur.	FCC, Federal Communications Commission Laboratory Division, USA (MRA US-EU 0003)
337 487 550 558	3462D-1 3462D-2 3462D-2 3462D-3	Radiated Measurements 30 MHz to 1 GHz, 3 m / 10 m (OATS) Radiated Measurements 30 MHz to 1 GHz, 3 m (SAR) Radiated Measurements 1 GHz to 6 GHz, 3 m (SAR) Radiated Measurements above 1 GHz, 3 m (FAR)	IC, Industry Canada Certification and Engineering Bureau
337 487 550 348 348	R-2665 R-2666 G-301 C-2914 T-1967	Radiated Measurements 30 MHz to 1 GHz, 3 m / 10 m (OATS) Radiated Measurements 30 MHz to 1 GHz, 3 m (SAR) Radiated Measurements 1 GHz to 6 GHz, 3 m (SAR) Mains Ports Conducted Interference Measurements Telecommunication Ports Conducted Interference Measur.	VCCI, Voluntary Control Council for Interference by Information Technology Equipment, Japan
OATS = Open Area Test Site, SAR = Semi Anechoic Room, FAR = Fully Anechoic Room			

7. Instruments and Ancillary

7.1. Used equipment “CTC”

The “Ref.-No” in the left column of the following tables allows the clear identification of the laboratory equipment.

7.1.1. Test software and firmware of equipment

Ref.-No.	Equipment	Type	Serial-No.	Version of Firmware or Software during the test
001	Emi Test Receiver	ESS	825132/017	Firm.= 1.21 , OTP=2.0, GRA=2.0
012	Signal Generator (EMS-cond.)	SMY 01	839069/027	Firm.= V 2.02
013	Power Meter (EMS cond.)	NRVD	839111/003	Firm.= V 1.51
017	Digital Radiocommunication Tester	CMD 60 M	844365/014	Firmware = V 3.52 .22.01.99, DECT = D2.87 13.01.99
053	Audio Analyzer	UPA3	860612/022	Firm. V 4.3
119	RT Harmonics Analyzer dig. Flickermeter	B10	G60547	Firm.= V 3.1DHG
140	Signal Generator	SMHU	831314/006	Firm.= 3.21
261	Thermal Power Sensor	NRV-Z55	825083/0008	EPROM-Datum 02.12.04, SE EE 1 B
262	Power Meter	NRV-S	825770/0010	Firm.= 2.6
263	Signal Generator	SMP 04	826190/0007	Firm.=3.21
264	Spectrum Analyzer	FSEK 30	826939/005	Bios=2.1, Analyzer= 3.20
295	Racal Digital Radio Test Set	6103	1572	UNIT Firmware= 4.04, SW-Main=4.04, SW-BBP=1.04, SW-DSP=1.02, Hardboot=1.02, Softboot=2.02
298	Univ. Radio Communication Tester	CMU 200	832221/091	R&S Test Firmware =3.53 /3.54 (current Testsoftw. f. all band used
323	Digital Radiocommunication Tester	CMD 55	825878/0034	Firm.= 3.52 .22.01.99
331	Climatic Test Chamber -40/+80 Grad	HC 4055	43146	TSI 1.53
335	System-CTC-EMS-Conducted	System EMS Conducted	-	EMC 32 V 8.40
340	Digital Radiocommunication Tester	CMD 55	849709/037	Firm.= 3.52 .22.01.99
355	Power Meter	URV 5	891310/027	Firm.= 1.31
365	10V Insertion Unit 50 Ohm	URV5-Z2	100880	Eprom Data = 31.03.08
366	Ultra Compact Simulator	UCS 500 M4	V0531100594	Firm. UCS 500=001925/3.06a02, rc=ISMIEC 4.10
371	Bluetooth Tester	CBT32	100153	CBT V5.30+ SW-Option K55
377	Emi Test Receiver	ESCS 30	100160	Firm.= 2.30, OTP= 02.01, GRA= 02.36
378	Broadband RF Field Monitor	RadiSense III	03D00013SNO-08	Firm.= V.03D13
383	Signal Generator	SME 03	842 828 /034	Firm.= 4.61
389	Digital Multimeter	Keithley 2000	0583926	Firm. = A13 (Mainboard) A02 (Display)
392	Radio Communication Tester	MT8820A	6K00000788	Firm.= 4.50 #005, IPL=4.01#001,OS=4.02#001, GSM=4.41#013, W-CDMA= 4.54#004, scenario= 4.52#002
436	Univ. Radio Communication Tester	CMU 200	103083	R&S Test Firmware Base=5.14, Mess-Software= GSM:5.14 WCDMA:5.14 (current Testsoftw. F. all band to be used ,
441	CTC-SAR-EMI Cable Loss	System EMI field (SAR) Cable	-	EMC 32 Version 8.40
442	CTC-SAR-EMS	System EMS field (SAR)	-	EMC 32 Version 8.40
443	CTC-FAR-EMI-RSE	System CTC-FAR-EMI-RSE	-	Spuri 7.2.5 or EMC 32 Ver. 8.40
444	CTC-FAR-EMS field	System-EMS-Field (FAR)	-	EMC 32 Version 8.40
460	Univ. Radio Communication Tester	CMU 200	108901	R&S Test Firmware Base=5.14, GSM=5.14 WCDMA=5.14 (current Testsoftw.,f. all band to be used,
489	Emi Test Receiver	ESU40	1000-30	Firmware=4.43 SP3, Bios=V5.1-16-3, Spec. =01.00
491	ESD Simulator dito	ESD dito	dito307022	V 2.30
524	Voltage Drop Simulator	VDS 200	0196-16	Software Nr. 000037 Version V4.20a01
526	Burst Generator	EFT 200 A	0496-06	Software Nr. 000034 Version V2.32
527	Micro Pulse Generator	MPG 200 B	0496-05	Software-Nr. 000030 Version V2.43
528	Load Dump Simulator	LD 200B	0496-06	Software-Nr. 000031 Version V2.35a01
546	Univ. Radio Communication Tester	CMU 200	106436	R&S Test Firmware Base=5.14, GSM=5.14 WCDMA=5.14 (current Testsoftw.,f. all band to be used
547	Univ. Radio Communication Tester	CMU 200	835390/014	R&S Test Firmware Base=V5.1403 (current Testsoftw., f. all band used, GSM = 5.14 WCDMA: = 5.14
584	Spectrum Analyzer	FSU 8	100248	2.82_SP3
594	Univ. Radio Communication Tester	CMW500	101757	Firmware Base=2.0.20.9, LTE=2.0.20.8. CDMA= 2.0.10
597	Univ. Radio Communication Tester	CMU 200	100347	R&S Test Firmware Base=5.01, GSM=5.02 WCDMA= not installed, Mainboard= µP1=V.850
598	Spectrum Analyzer	FSEM 30 (Reserve)	831259/013	Firmware Bios 3.40 , Analyzer 3.40 Sp 2

7.1.2. Single instruments and test systems

Ref.-No.	Equipment	Type	Serial-No.	Manufacturer	Interval of calibration	Remark	Cal due
001	Emi Test Receiver	ESS	825132/017	Rohde & Schwarz	12 M	-	31.03.2012
005	AC - LISN (50 Ohm/50µH, test site 1)	ESH2-Z5	861741/005	Rohde & Schwarz	24/12 M	-	31.03.2012
007	DC - LISN (50 Ohm/5µH)	ESH3-Z6	892563/002	Rohde & Schwarz	24/12 M	-	31.03.2012
009	Power Meter (EMS-radiated)	NRV	863056/017	Rohde & Schwarz	24 M	-	31.03.2013
016	Line Impedance Simulating Network	Op. 24-D	B6366	Spitzenberger+Spies	36 M	-	31.03.2013
020	Horn Antenna 18 GHz (Subst 1)	3115	9107-3699	EMCO	36/12 M	-	31.03.2013
021	Loop Antenna (H-Field)	6502	9206-2770	EMCO	36 M	-	31.03.2013
030	Loop Antenna (H-field)	HFH-Z2	879604/026	Rohde & Schwarz	36 M	-	31.03.2012
033	RF-current probe (100kHz-30MHz)	ESH2-Z1	879581/18	Rohde & Schwarz	24 M	-	31.03.2013
057	relay-switch-unit (EMS system)	RSU	494440/002	Rohde & Schwarz	pre-m	1a	
060	power amplifier (DC-2kHz)	PAS 5000	B6363	Spitzenberger+Spies	-	3	
066	notch filter (WCDMA; FDD1)	WRCT 1900/2200-5/40-10EEK	5	Wainwright GmbH	12 M	1c	30.06.2012
086	DC - power supply, 0 -10 A	LNG 50-10	-	Heinzinger Electronic	pre-m	2	
087	DC - power supply, 0 -5 A	EA-3013 S	-	Elektro Automatik	pre-m	2	
090	Helmholtz coil: 2x10 coils in series	-	-	RWTÜV	-	4	
091	USB-LWL-Converter	OLS-1	007/2006	Ing. Büro Scheiba	-	4	
099	passive voltage probe	ESH2-Z3	299.7810.52	Rohde & Schwarz	36 M	-	31.03.2012
100	passive voltage probe	Probe TK 9416	without	Schwarzbeck	36 M	-	31.03.2012
110	USB-LWL-Converter	OLS-1	-	Ing. Büro Scheiba	-	4	
119	RT Harmonics Analyzer dig. Flickermeter	B10	G60547	BOCONSULT	36 M	-	31.03.2013
134	horn antenna 18 GHz (Subst 2)	3115	9005-3414	EMCO	12 M	-	31.03.2012
136	adjustable dipole antenna (Dipole 1)	3121C-DB4	9105-0697	EMCO	12 M	-	31.03.2012
140	Signal Generator	SMHU	831314/006	Rohde & Schwarz	24 M	-	31.03.2012
248	attenuator	SMA 6dB 2W	-	Radiall	pre-m	2	
249	attenuator	SMA 10dB 10W	-	Radiall	pre-m	2	
252	attenuator	N 6dB 12W	-	Radiall	pre-m	2	
256	attenuator	SMA 3dB 2W	-	Radiall	pre-m	2	
257	hybrid	4031C	04491	Narda	pre-m	2	
260	hybrid coupler	4032C	11342	Narda	pre-m	2	
261	Thermal Power Sensor	NRV-Z55	825083/0008	Rohde & Schwarz	24/12 M	-	31.03.2012
262	Power Meter	NRV-S	825770/0010	Rohde & Schwarz	24 M	-	31.03.2012
263	Signal Generator	SMP 04	826190/0007	Rohde & Schwarz	36 M	-	31.03.2013
264	Spectrum Analyzer	FSEK 30	826939/005	Rohde & Schwarz	12 M	-	31.03.2014
265	peak power sensor	NRV-Z33, Model 04	840414/009	Rohde & Schwarz	24 M	-	31.03.2012
266	peak power sensor	NRV-Z31, Model 04	843383/016	Rohde & Schwarz	24 M	-	31.03.2012
267	notch filter GSM 850	WRCA 800/960-6EEK	9	Wainwright GmbH	pre-m	2	
268	AC/DC power supply	EA 3050-A	9823636	Elektro Automatik	pre-m	2	
270	termination	1418 N	BB6935	Weinschel	pre-m	2	
271	termination	1418 N	BE6384	Weinschel	pre-m	2	
272	attenuator (20 dB) 50 W	Model 47	BF6239	Weinschel	pre-m	2	
273	attenuator (10 dB) 100 W	Model 48	BF9229	Weinschel	pre-m	2	
274	attenuator (10 dB) 50 W	Model 47 (10 dB) 50 W	BG0321	Weinschel	pre-m	2	
275	DC-Block	Model 7003 (N)	C5129	Weinschel	pre-m	2	
276	DC-Block	Model 7006 (SMA)	C7061	Weinschel	pre-m	2	
279	power divider	1515 (SMA)	LH855	Weinschel	pre-m	2	
287	pre-amplifier 25MHz - 4GHz	AMF-2D-100M4G-35-10P	379418	Miteq	12 M	1c	30.06.2012
291	high pass filter GSM 850/900	WHJ 2200-4EE	14	Wainwright GmbH	12 M	1c	30.06.2012
298	Univ. Radio Communication Tester	CMU 200	832221/091	Rohde & Schwarz	pre-m	3	
300	AC LISN (50 Ohm/50µH, 1-phase)	ESH3-Z5	892 239/020	Rohde & Schwarz	24/12 M	-	31.03.2012
301	attenuator (20 dB) 50W, 18GHz	47-20-33	AW0272	Lucas Weinschel	pre-m	2	
302	horn antenna 40 GHz (Meas 1)	BBHA9170	155	Schwarzbeck	36 M	-	31.03.2014
303	horn antenna 40 GHz (Subst 1)	BBHA9170	156	Schwarzbeck	36 M	-	31.03.2014
331	Climatic Test Chamber -40/+80 Grad	HC 4055	43146	Heraeus Vötsch	24 M	-	30.11.2012
341	Digital Multimeter	Fluke 112	81650455	Fluke	24 M	-	31.03.2012
342	Digital Multimeter	Voltcraft M-4660A	IB 255466	Voltcraft	24 M	-	31.03.2013
347	laboratory site	radio lab.	-	-	-	5	
348	laboratory site	EMI conducted	-	-	-	5	
354	DC - Power Supply 40A	NGPE 40/40	448	Rohde & Schwarz	pre-m	2	
355	Power Meter	URV 5	891310/027	Rohde & Schwarz	24 M	-	31.03.2012
356	power sensor	NRV-Z1	882322/014	Rohde & Schwarz	24 M	-	31.03.2013
357	power sensor	NRV-Z1	861761/002	Rohde & Schwarz	24 M	-	31.03.2013
373	V-Network 5µH/50 Ohm	ESH3-Z6	100535	Rohde & Schwarz	24/12 M	-	31.03.2012
376	Horn Antenna 6 GHz	BBHA9120 E	BBHA 9120 E 179	Schwarzbeck	12 M	-	31.03.2012
377	Emi Test Receiver	ESCS 30	100160	Rohde & Schwarz	12 M	-	31.03.2012
389	Digital Multimeter	Keithley 2000	0583926	Keithley	24 M	-	31.03.2013
392	Radio Communication Tester	MT8820A	6K00000788	Anritsu	12 M	-	31.03.2012
431	Model 7405	Near-Field Probe Set	9305-2457	EMCO	-	4	
436	Univ. Radio Communication Tester	CMU 200	103083	Rohde & Schwarz	12 M	-	31.03.2012
441	CTC-SAR-EMI Cable Loss	System EMI field (SAR)	-	CETECOM	12 M	5	31.10.2012

Ref.-No.	Equipment	Type	Serial-No.	Manufacturer	Interval of calibration	Remark	Cal due
		Cable					
443	CTC-FAR-EMI-RSE	System CTC-FAR-EMI-RSE	-	ETS-Lindgren/CETECOM	12 M	5	30.06.2012
448	notch filter WCDMA_FDD II	WRCT 1850.0/2170.0-5/40-10SSK	5	Wainwright Instruments GmbH	12 M	1c	30.06.2012
449	notch filter WCDMA FDD V	WRCT 824.0/894.0-5/40-8SSK	1	Wainwright	12 M	1c	30.06.2012
454	Oscilloscope	HM 205-3	9210 P 29661	Hameg	-	4	
456	DC-Power supply 0-5 A	EA 3013 S	207810	Elektro Automatik	pre-m	2	
459	DC -Power supply 0-5 A , 0-32 V	EA-PS 2032-50	910722	Elektro Automatik	pre-m	2	
460	Univ. Radio Communication Tester	CMU 200	108901	Rohde & Schwarz	12 M	-	31.03.2012
463	Universal source	HP3245A	2831A03472	Agilent	-	4	
466	Digital Multimeter	Fluke 112	89210157	Fluke USA	24 M	-	31.03.2012
467	Digital Multimeter	Fluke 112	89680306	Fluke USA	24 M	-	31.03.2012
468	Digital Multimeter	Fluke 112	90090455	Fluke USA	24 M	-	31.03.2012
477	ReRadiating GPS-System	AS-47	-	Automotive Cons. Fink	-	3	
480	power meter (Fula)	NRVS	838392/031	Rohde & Schwarz	24 M	-	31.03.2013
482	filter matrix	Filter matrix SAR 1	-	CETECOM (Brl)	-	1d	
484	pre-amplifier 2,5 - 18 GHz	AMF-5D-02501800-25-10P	1244554	Miteq	12 M	-	30.07.2012
487	System CTC NSA-Verification SAR-EMI	System EMI field (SAR) NSA	-	ETS Lindgren/CETECOM	24 M	-	30.09.2013
489	Emi Test Receiver	ESU40	1000-30	Rohde & Schwarz	12 M	-	31.03.2012
502	band reject filter	WRCG 1709/1786-1699/1796-	SN 9	Wainwright	pre-m	2	
503	band reject filter	WRCG 824/849-814/859-60/10SS	SN 5	Wainwright	pre-m	2	
512	notch filter GSM 850	WRCA 800/960-02/40-6EEK	SN 24	Wainwright	12 M	1c	30.06.2012
517	relais switch matrix	HF Relais Box Keithley System	SE 04	Keithley	pre-m	2	
523	Digital Multimeter	L4411A	MY46000154	Agilent	24 M	-	31.03.2013
529	6 dB Broadband resistive power divider	Model 1515	LH 855	Weinschel	pre-m	2	
530	10 dB Broadband resistive power divider	R 416110000	LOT 9828	-	pre-m	2	
546	Univ. Radio Communication Tester	CMU 200	106436	R&S	12 M	-	31.03.2012
547	Univ. Radio Communication Tester	CMU 200	835390/014	Rohde & Schwarz	12 M	-	31.03.2012
548	Digital-Barometer	GBP 2300	without	Greisinger GmbH	36/12 M	-	31.03.2012
549	Log.Per-Antenna	HL025	1000060	Rohde & Schwarz	36/12 M	-	31.03.2012
552	high pass filter 2,8-18GHz	WHKX 2.8/18G-10SS	4	Wainwright	12 M	1c	30.07.2012
558	System CTC FAR S-VSWR	System CTC FAR S-VSWR	-	CTC	24 M	-	31.07.2013
574	Biconilog Hybrid Antenna	BTA-L	980026L	Frankonia	36/12 M	-	30.03.2013
584	Spectrum Analyzer	FSU 8	100248	Rohde & Schwarz	12 M	-	31.03.2012
594	Univ. Radio Communication Tester	CMW500	101757	Rohde & Schwarz	24 M	-	31.03.2012
597	Univ. Radio Communication Tester	CMU 200	100347	Rohde & Schwarz	12 M	-	31.03.2012
598	Spectrum Analyzer	FSEM 30 (Reserve)	831259/013	Rohde & Schwarz	24 M	-	13.01.2013
600	power meter	NRVD (Reserve)	834501/018	Rohde & Schwarz	24 M	-	31.03.2013
601	medium-sensitivity diode sensor	NRV-Z5 (Reserve)	8435323/003	Rohde & Schwarz	24 M	-	12.01.2013
602	peak power sensor	NRV-Z32 (Reserve)	835080	Rohde & Schwarz	24 M	-	12.01.2013
608	UltraLog-Antenna	HL 562	830547/009	Rohde & Schwarz	36/12 M	-	31.03.2014
611	DC power supply	E3632A	KR 75305854	Agilent	pre-m	2	
612	DC power supply	E3632A	MY 40001321	Agilent	pre-m	2	
613	Attenuator	R416120000 20dB 10W	Lot. 9828	Radiall	pre-m	2	

7.1.3. Legend

Note / remarks		Calibrated during system calibration:
	1a	System CTC-SAR-EMS (Ref.-No. 442)
	1b	System-CTC-EMS-Conducted (Ref.-No. 335)
	1c	System CTC-FAR-EMI-RSE (Ref.-No . 443)
	1d	System CTC-SAR-EMI (Ref.-No . 441)
	1e	System CTC-OATS (EMI radiated) (Ref.-No. 337)
	1 f	System CTC-CTIA-OTA (Ref.-No . 420)
	1 g	System CTC-FAR-EMS (Ref.-No . 444)
	2	Calibration or equipment check immediately before measurement
	3	Regulatory maintained equipment for functional check or support purpose
	4	Ancillary equipment without calibration e.g. mechanical equipment or monitoring equipment
	5	Test System

Interval of calibration	12 M	12 month
-------------------------	------	----------

	24 M	24 month
	36 M	36 month
	24/12 M	Calibration every 24 months, between this every 12 months internal validation
	36/12 M	Calibration every 36 months, between this every 12 months internal validation
	Pre-m	Check before starting the measurement
	-	Without calibration