



Hildesheim
09 December 2019

From

Our Reference

Tel

Report

Issue

Topic

A-IVI Scope 3 Internal Pictures

Description

Pictures of PCBs used in A-IVI Scope 3 units

Product Type: Radio-Navigation-System

Model Names: AIVIH61L1

Brand: Robert Bosch Car Multimedia GmbH



Hildesheim
09 December 2019

From	Our Reference	Tel
------	---------------	-----

Report
Issue
Topic A-IVI Scope 3 Internal Pictures

Contend

1 Pictures of disassembly 3

2 Main PCB 8

2.1 Main PCB “J” V01..... 8

 2.1.1 Main PCB “J” V01 Top side US insertion 8

 2.1.2 Main PCB “J” V01 Bottom side US insertion..... 8

3 XM Module (all US / CAN variants) 9

4 Switch PCBs 10

4.1 Switch PCB “H61L-8” 10

 4.1.1 Switch PCB “H61L-8” Top side 10

 4.1.2 Switch PCB “H61L-8” Bottom side 11

5 Bluetooth/Wi-Fi Module (all variants) 12

5.1 Bluetooth/Wi-Fi Module without Shielding (all variants) 12

5.2 Bluetooth/Wi-Fi Module bottom side 13

Hildesheim
09 December 2019

From | Our Reference | Tel |

Report
Issue
Topic A-IVI Scope 3 Internal Pictures

1 Pictures of disassembly

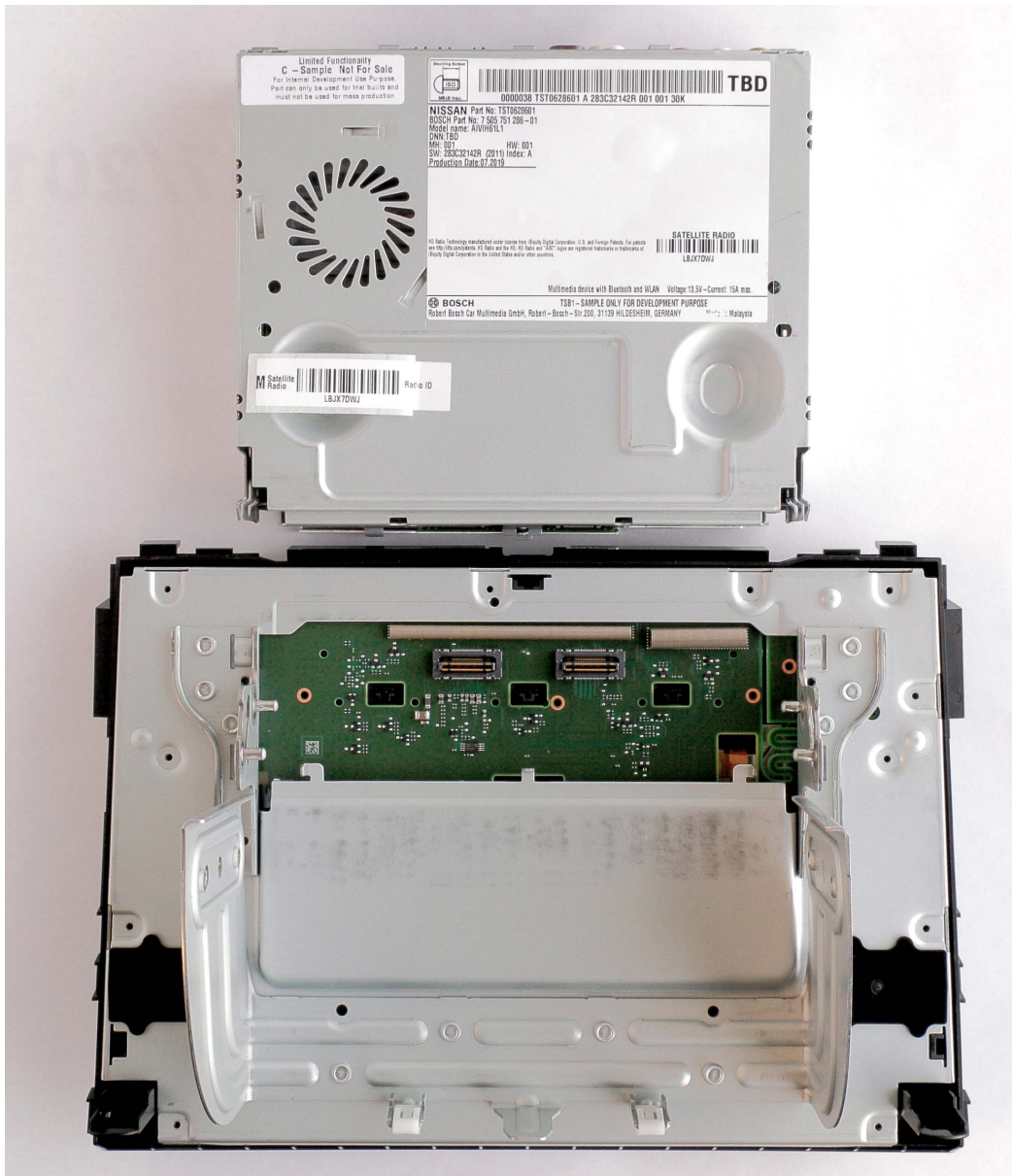

Hildesheim
09 December 2019

From | Our Reference

Tel

Report

Issue

Topic A-IVI Scope 3 Internal Pictures

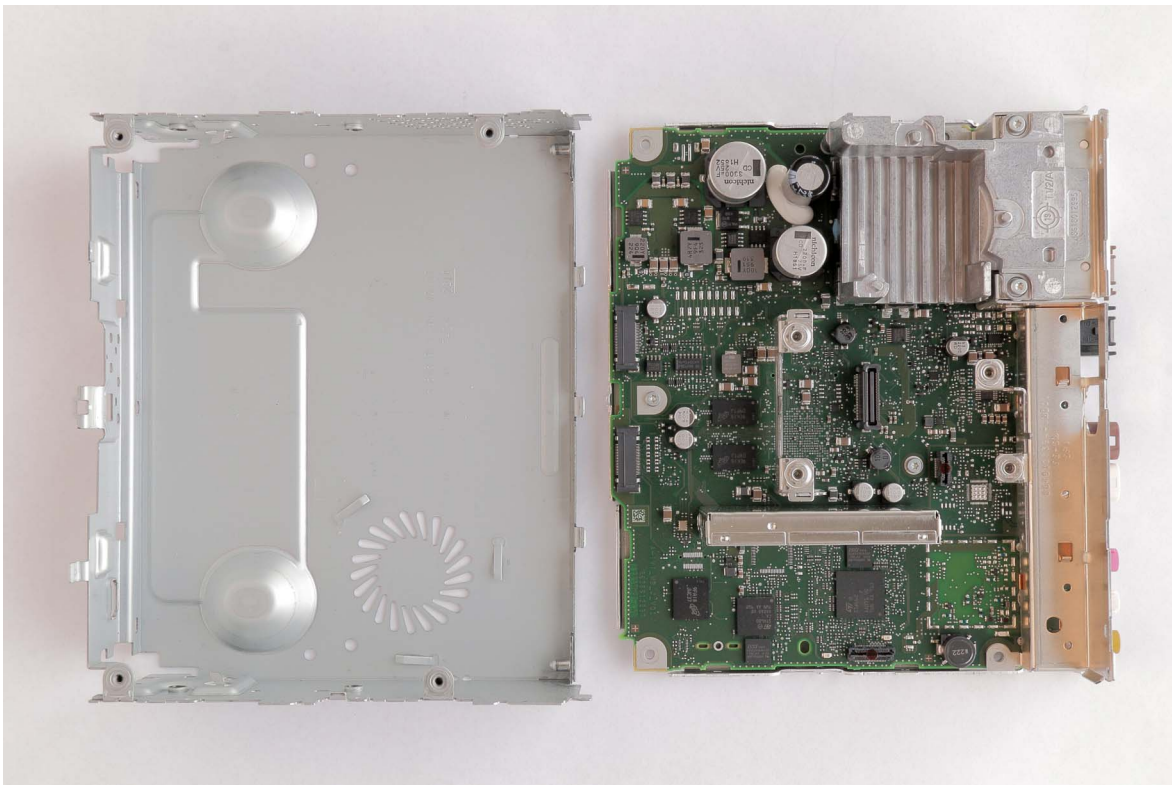



Hildesheim
09 December 2019

From

Our Reference

Tel

Report

Issue

Topic A-IVI Scope 3 Internal Pictures

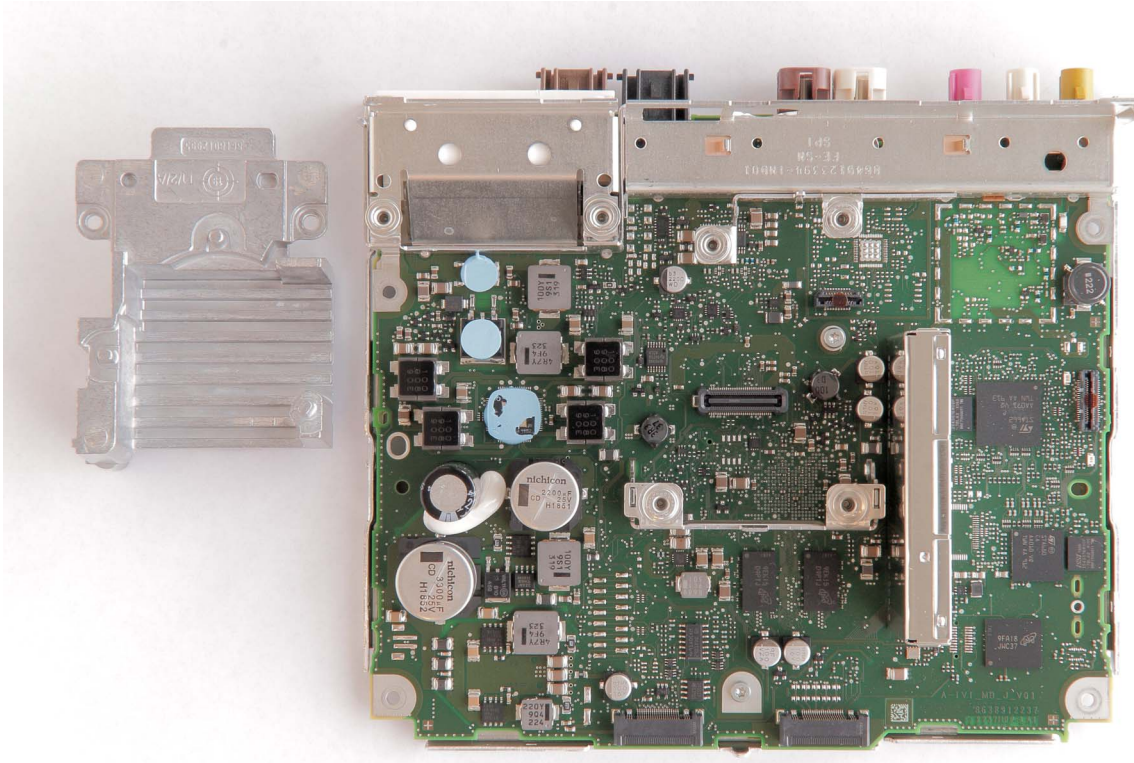

Hildesheim
09 December 2019

From | Our Reference | Tel

Report
Issue
Topic A-IVI Scope 3 Internal Pictures

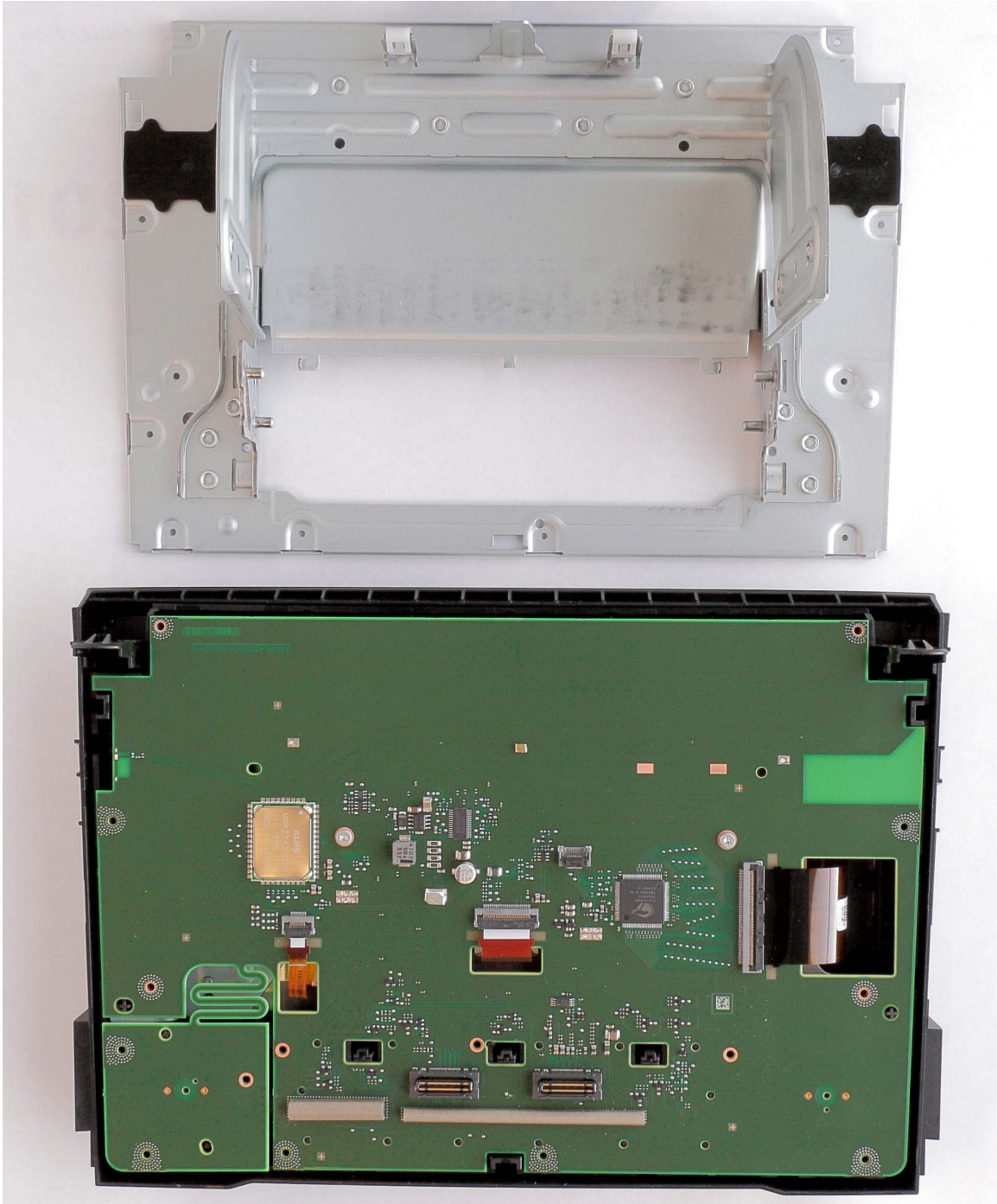



Hildesheim
09 December 2019

From | Our Reference | Tel

Report
Issue
Topic A-IVI Scope 3 Internal Pictures

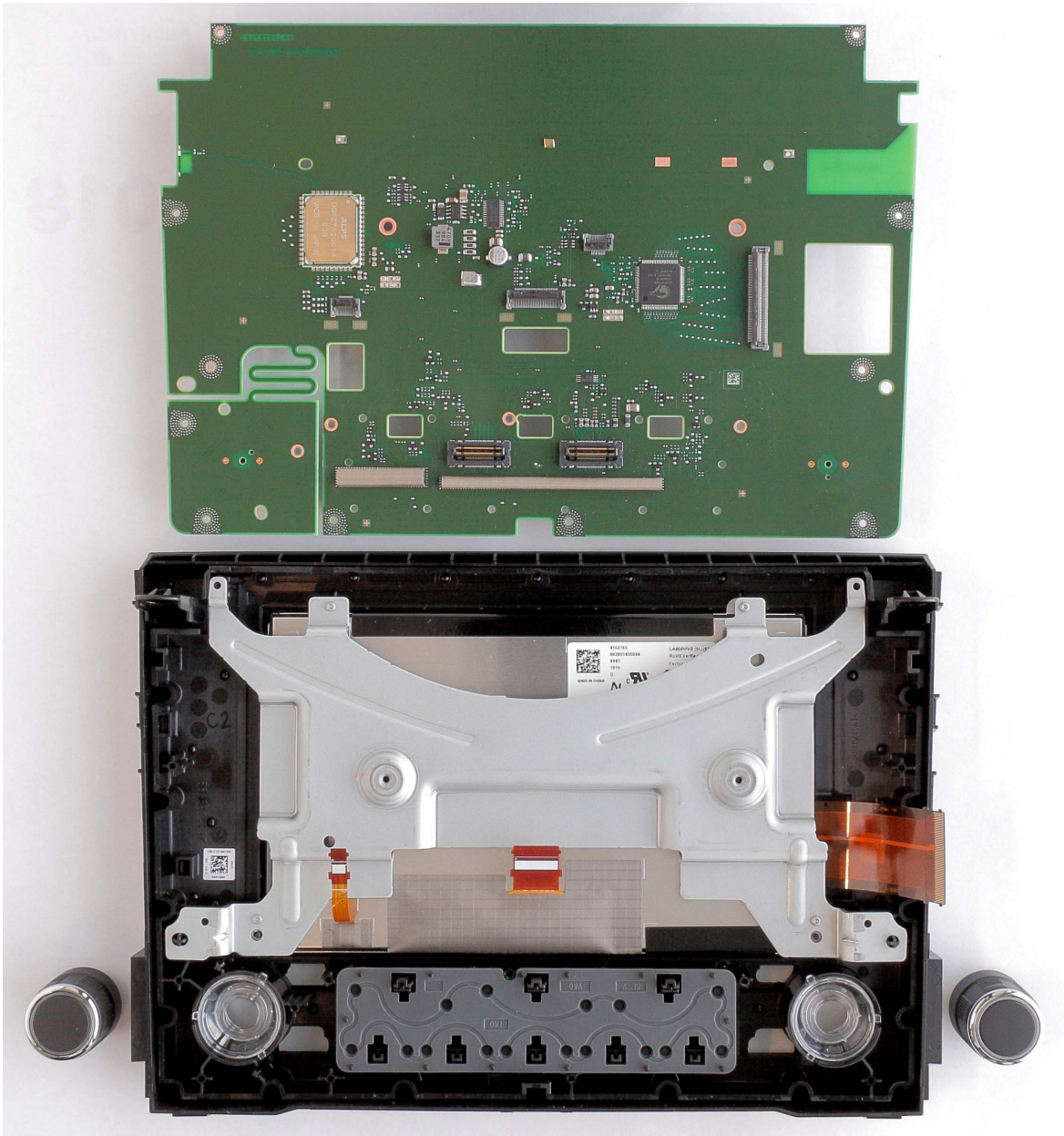

Hildesheim
09 December 2019

From | Our Reference | Tel |

Report
Issue
Topic A-IVI Scope 3 Internal Pictures

2 Main PCB

2.1 Main PCB “J” V01

Circuit and layout name / version: A-IVI_MB_J_V01
Update of “B” V01. Small layout improvements mainly for reliability

2.1.1 Main PCB “J” V01 Top side US insertion

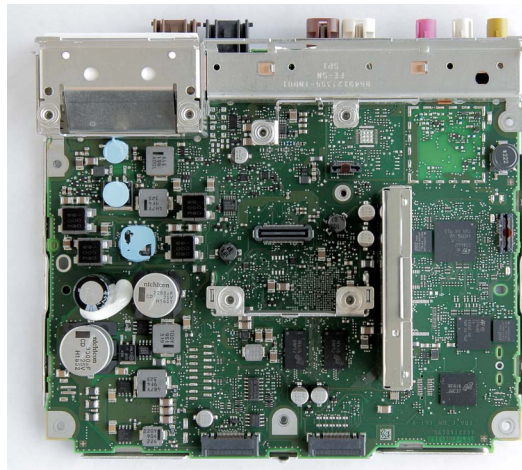

2.1.2 Main PCB “J” V01 Bottom side US insertion

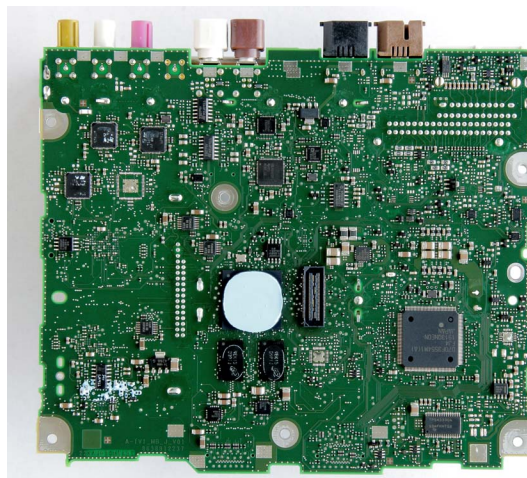



Hildesheim
09 December 2019

From | Our Reference | Tel

Report
Issue
Topic A-IVI Scope 3 Internal Pictures

3 XM Module (all US / CAN variants)

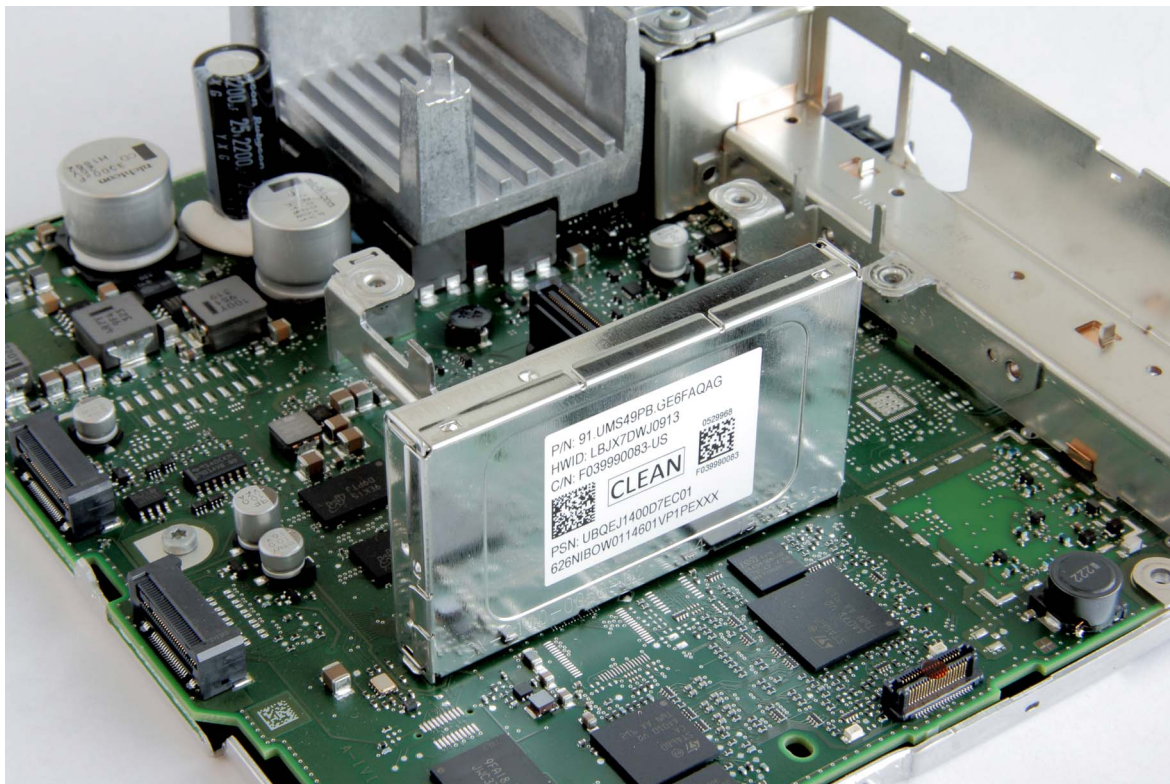

Hildesheim
09 December 2019

From | Our Reference | Tel

Report
Issue
Topic A-IVI Scope 3 Internal Pictures

4 Switch PCBs

4.1 Switch PCB “H61L-8”

Circuit and layout name / version: A-IVI_SB_H61L-8_V01

4.1.1 Switch PCB “H61L-8” Top side

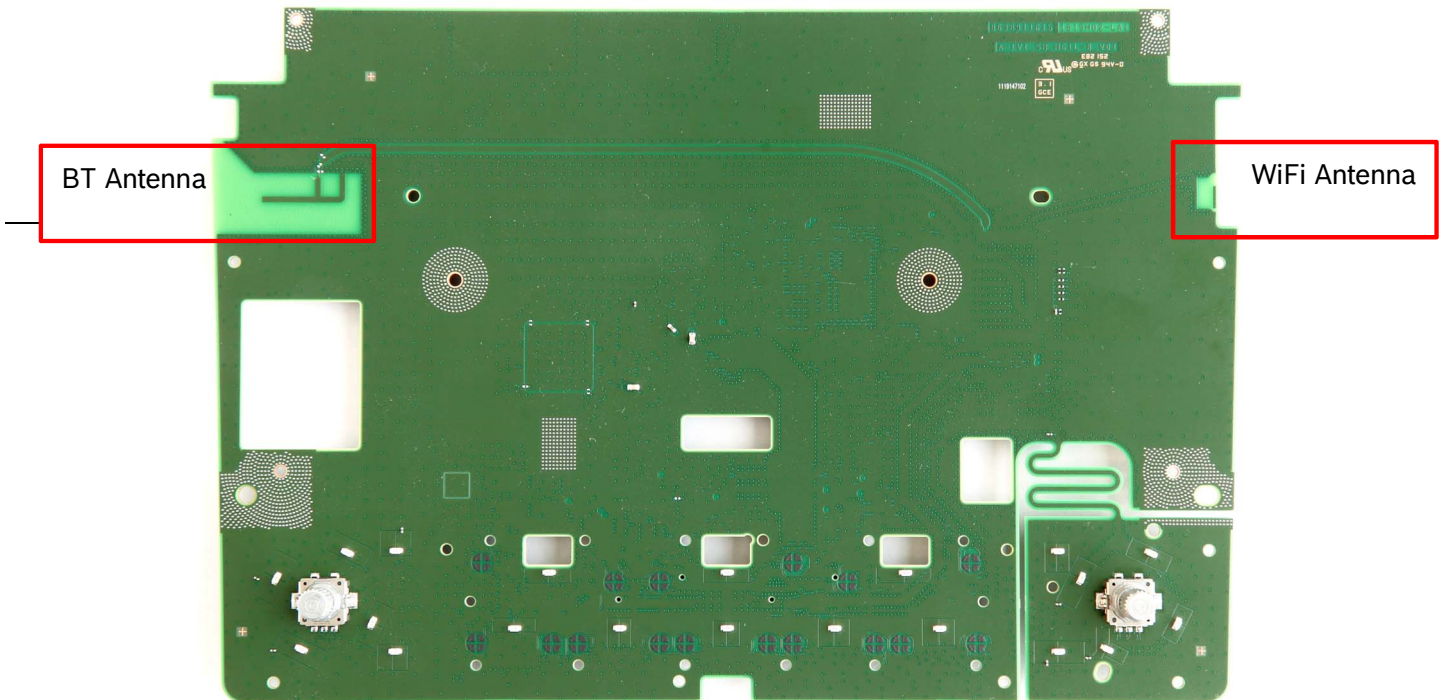

Hildesheim
09 December 2019

From | Our Reference | Tel

Report
Issue
Topic A-IVI Scope 3 Internal Pictures

4.1.2 Switch PCB “H61L-8” Bottom side

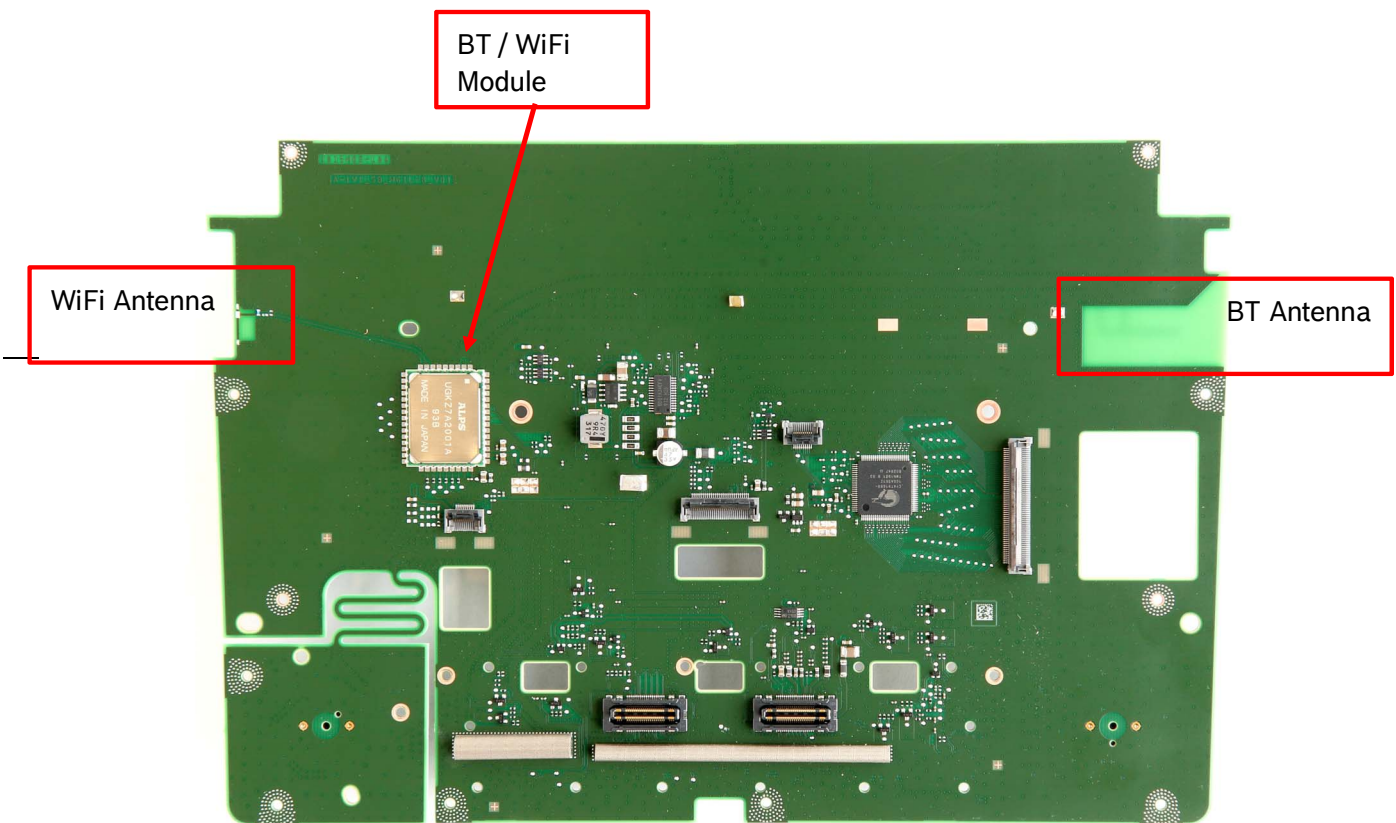

From | Our Reference | Tel

Report
Issue
Topic A-IVI Scope 3 Internal Pictures

5 Bluetooth/Wi-Fi Module (all variants)



5.1 Bluetooth/Wi-Fi Module without Shielding (all variants)



Yellow mark: Marking of ICs also include individual production information and could be different from the photo

Hildesheim
09 December 2019

From | Our Reference | Tel

Report
Issue
Topic A-IVI Scope 3 Internal Pictures

5.2 Bluetooth/Wi-Fi Module bottom side

