

# FCC Radio Test Report

## FCC ID: YBN-AIVIL42P0

This report concerns (check one):  Original Grant  Class I Change  Class II Change

**Project No.** : 1807C078  
**Equipment** : Car Radio with navigation, BT and WLAN  
**Test Model** : AIVIL42P0  
**Series Model** : N/A  
**Applicant** : Bosch Car Multimedia GmbH  
**Address** : Robert-Bosch-Straße 200; 31139 Hildesheim

**Date of Receipt** : Jul. 11, 2018  
**Date of Test** : Jul. 11, 2018 ~ Jul. 17, 2018  
**Issued Date** : Jul. 25, 2018  
**Tested by** : BTL Inc.

**Testing Engineer** : Chay Cai  
(Chay Cai)

**Technical Manager** : David Mao  
(David Mao)

**Authorized Signatory** : Steven Lu  
(Steven Lu)

# **B T L I N C .**

No.3, Jinshagang 1st Road, Shixia, Dalang Town, Dongguan,  
Guangdong, China.

TEL: +86-769-8318-3000 FAX: +86-769-8319-6000



### **Declaration**

**BTL** represents to the client that testing is done in accordance with standard procedures as applicable and that test instruments used has been calibrated with standards traceable to international standard(s) and/or national standard(s).

**BTL's** reports apply only to the specific samples tested under conditions. It is manufacture's responsibility to ensure that additional production units of this model are manufactured with the identical electrical and mechanical components. **BTL** shall have no liability for any declarations, inferences or generalizations drawn by the client or others from **BTL** issued reports.

The report must not be used by the client to claim product certification, approval, or endorsement by NVLAP, NIST, or any agency of the U.S. Government.

This report is the confidential property of the client. As a mutual protection to the clients, the public and ourselves, the test report shall not be reproduced, except in full, without our written approval.

**BTL's** laboratory quality assurance procedures are in compliance with the **ISO Guide 17025** requirements, and accredited by the conformity assessment authorities listed in this test report.

**BTL** is not responsible for the sampling stage, so the results only apply to the sample as received.

The information, data and test plan are provided by manufacturer, so it is manufacturer's responsibility to ensure that the apparatus meets the essential requirements in all the possible configurations as representative of its intended use.

### **Limitation**

For the use of the authority's logo is limited unless the Test Standard(s)/Scope(s)/Item(s) mentioned in this test report is (are) included in the conformity assessment authorities acceptance respective.

**Table of Contents****Page**

<b>1 . CERTIFICATION</b>	<b>6</b>
<b>2 . SUMMARY OF TEST RESULTS</b>	<b>7</b>
2.1 TEST FACILITY	8
2.2 MEASUREMENT UNCERTAINTY	8
<b>3 . GENERAL INFORMATION</b>	<b>9</b>
3.1 GENERAL DESCRIPTION OF EUT	9
3.2 DESCRIPTION OF TEST MODES	10
3.3 TABLE OF PARAMETERS OF TEXT SOFTWARE SETTING	12
3.4 BLOCK DIAGRAM SHOWING THE CONFIGURATION OF SYSTEM TESTED	13
3.5 DESCRIPTION OF SUPPORT UNITS	13
<b>4 . EMC EMISSION TEST</b>	<b>14</b>
4.1 RADIATED EMISSION MEASUREMENT	14
4.1.1 RADIATED EMISSION LIMITS	14
4.1.2 TEST PROCEDURE	15
4.1.3 DEVIATION FROM TEST STANDARD	15
4.1.4 TEST SETUP	16
4.1.5 EUT OPERATING CONDITIONS	18
4.1.6 EUT TEST CONDITIONS	18
4.1.7 TEST RESULTS (9KHZ TO 30MHZ)	18
4.1.8 TEST RESULTS (30MHZ TO 1000MHZ)	18
4.1.9 TEST RESULTS (ABOVE 1000MHZ)	18
<b>5 . BANDWIDTH TEST</b>	<b>19</b>
5.1 APPLIED PROCEDURES	19
5.1.1 TEST PROCEDURE	19
5.1.2 DEVIATION FROM STANDARD	19
5.1.3 TEST SETUP	19
5.1.4 EUT OPERATION CONDITIONS	19
5.1.5 EUT TEST CONDITIONS	19
5.1.6 TEST RESULTS	19
<b>6 . MAXIMUM AVG OUTPUT POWER TEST</b>	<b>20</b>
6.1 APPLIED PROCEDURES / LIMIT	20
6.1.1 TEST PROCEDURE	20
6.1.2 DEVIATION FROM STANDARD	20
6.1.3 TEST SETUP	20
6.1.4 EUT OPERATION CONDITIONS	20
6.1.5 EUT TEST CONDITIONS	20
6.1.6 TEST RESULTS	20

<b>Table of Contents</b>	<b>Page</b>
<b>7 . ANTENNA CONDUCTED SPURIOUS EMISSION</b>	<b>21</b>
<b>7.1 APPLIED PROCEDURES / LIMIT</b>	<b>21</b>
7.1.1 TEST PROCEDURE	21
7.1.2 DEVIATION FROM STANDARD	21
7.1.3 TEST SETUP	21
7.1.4 EUT OPERATION CONDITIONS	21
7.1.5 EUT TEST CONDITIONS	21
7.1.6 TEST RESULTS	21
<b>8 . POWER SPECTRAL DENSITY TEST</b>	<b>22</b>
<b>8.1 APPLIED PROCEDURES / LIMIT</b>	<b>22</b>
8.1.1 TEST PROCEDURE	22
8.1.2 DEVIATION FROM STANDARD	22
8.1.3 TEST SETUP	22
8.1.4 EUT OPERATION CONDITIONS	22
8.1.5 EUT TEST CONDITIONS	22
8.1.6 TEST RESULTS	22
<b>9 . MEASUREMENT INSTRUMENTS LIST</b>	<b>23</b>
<b>10 . EUT TEST PHOTO</b>	<b>25</b>
<b>APPENDIX A - RADIATED EMISSION (9KHZ TO 30MHZ)</b>	<b>30</b>
<b>APPENDIX B - RADIATED EMISSION (30MHZ TO 1000MHZ)</b>	<b>35</b>
<b>APPENDIX C - RADIATED EMISSION (ABOVE 1000MHZ)</b>	<b>42</b>
<b>APPENDIX D - BANDWIDTH</b>	<b>139</b>
<b>APPENDIX E - MAXIMUM AVG OUTPUT POWER</b>	<b>148</b>
<b>APPENDIX F - ANTENNA CONDUCTED SPURIOUS EMISSION</b>	<b>151</b>
<b>APPENDIX G - POWER SPECTRAL DENSITY</b>	<b>176</b>

### REPORT ISSUED HISTORY

Issued No.	Description	Issued Date
BTL-FCCP-2-1807C078	Original Issue.	Jul. 25, 2018

## 1. CERTIFICATION

Equipment : Car Radio with navigation, BT and WLAN  
Brand Name : Bosch  
Test Model : AIVIL42P0  
Series Model : N/A  
Applicant : Bosch Car Multimedia GmbH  
Manufacturer : #1 Bosch Car Multimedia GmbH  
                  #2 Bosch Car Multimedia Portugal, S.A.  
Address : #1 Robert-Bosch-Straße 200; 31139 Hildesheim  
              #2 Rua Max Grundig, 35-Lomar, 4705-820 Braga  
Factory : Robert Bosch (Malaysia)  
Address : Free Trade Zone 11900, Bayan Lepas, Penang  
Date of Test : Jul. 11, 2018 ~ Jul. 17, 2018  
Test Sample : Engineering Sample No.: D180705792 for conducted, D180705794 for  
                  radiated  
Standard(s) : FCC Part15, Subpart C (15.247) / ANSI C63.10-2013

The above equipment has been tested and found compliance with the requirement of the relative standards by BTL Inc.

The test data, data evaluation, and equipment configuration contained in our test report (Ref No. BTL-FCCP-2-1807C078) were obtained utilizing the test procedures, test instruments, test sites that has been accredited by the Authority of NVLAP according to the ISO-17025 quality assessment standard and technical standard(s).

**Test results included in this report is only for the WLAN 2.4G part.**

## 2. SUMMARY OF TEST RESULTS

Test procedures according to the technical standard(s):

Applied Standard(s): FCC Part15 (15.247) , Subpart C			
Standard(s) Section	Test Item	Judgment	Remark
15.247(d)	Antenna conducted Spurious Emission	PASS	
15.247(a)(2)	6dB Bandwidth	PASS	
15.247(b)(3)	AVG Output Power	PASS	
15.247(e)	Power Spectral Density	PASS	
15.203	Antenna Requirement	PASS	
15.247(d)/ 15.205/ 15.209	Transmitter Radiated Emissions	PASS	

**NOTE:**

(1) "N/A" denotes test is not applicable in this test report.

## 2.1 TEST FACILITY

The test facilities used to collect the test data in this report is at the location of No.3,Jinshagang 1st Road, Shixia, Dalang Town, Dongguan, Guangdong, China.

BTL's test firm number for FCC: 854385

BTL's designation number for FCC: CN5020

## 2.2 MEASUREMENT UNCERTAINTY

The measurement uncertainty figures shall be calculated according the methods described in the ETSI TR 100 028 and shall correspond to an expansion factor (coverage factor)  $k=1.96$  or  $k=2$ (which provide confidence levels of respectively 90% and 95.45% in the case where the distributions characterizing the actual measurement uncertainties are normal (Gaussian)). Measurement Uncertainty for a Level of Confidence of 95 %,  $U=2xUc(y)$ .

The BTL measurement uncertainty as below table:

### A. Radiated Measurement:

Test Site	Method	Measurement Frequency Range	Ant. H / V	U, (dB)
DG-CB03	CISPR	9KHz~30MHz	V	3.79
		9KHz~30MHz	H	3.57
		30MHz ~ 200MHz	V	3.82
		30MHz ~ 200MHz	H	3.78
		200MHz ~ 1,000MHz	V	4.10
		200MHz ~ 1,000MHz	H	4.06
		1GHz~18GHz	V	3.12
		1GHz~18GHz	H	3.68
		18GHz~40GHz	V	4.15
		18GHz~40GHz	H	4.14

Note: Unless specifically mentioned, the uncertainty of measurement has not been taken into account to declare the compliance or non-compliance to the specification.



### 3. GENERAL INFORMATION

#### 3.1 GENERAL DESCRIPTION OF EUT

Equipment	Car Radio with navigation, BT and WLAN	
Brand Name	Bosch	
Test Model	AIVIL42P0	
Series Model	N/A	
Model Difference	N/A	
Product Description	Operation Frequency	2412 ~ 2462 MHz
	Modulation Technology	802.11b:DSSS 802.11g:OFDM 802.11n:OFDM
	Bit Rate of Transmitter	802.11b: 11/5.5/2/1 Mbps 802.11g: 54/48/36/24/18/12/9/6 Mbps 802.11n up to 150 Mbps
	Average Output Power (Max.)	802.11b: 8.90 dBm 802.11g: 6.60 dBm 802.11n(20MHz): 6.50 dBm 802.11n(40MHz): 6.10 dBm
Power Source	DC voltage supplied from external power supply.	
Power Rating	DC 13.5V	

Note:

- For a more detailed features description, please refer to the manufacturer's specifications or the user's manual.
- Channel List:

CH01 - CH11 for 802.11b, 802.11g, 802.11n(20MHz) CH03 - CH09 for 802.11n(40MHz)							
Channel	Frequency (MHz)	Channel	Frequency (MHz)	Channel	Frequency (MHz)	Channel	Frequency (MHz)
01	2412	04	2427	07	2442	10	2457
02	2417	05	2432	08	2447	11	2462
03	2422	06	2437	09	2452		

#### 3. Table for Filed Antenna

Ant.	Brand	Model Name	Antenna Type	Connector	Gain (dBi)
1	N/A	N/A	Internal	N/A	6.60

Note:

Antenna Gain=6.6 dBi. So, the out power limit is  $30-6.6+6=29.4$ , the power density limit is  $8-6.6+6=7.4$ .

### 3.2 DESCRIPTION OF TEST MODES

To investigate the maximum EMI emission characteristics generated from EUT, the test system was pre-scanning tested based on the consideration of following EUT operation mode or test configuration mode which possibly have effect on EMI emission level. Each of these EUT operation mode(s) or test configuration mode(s) mentioned above was evaluated respectively.

Pretest Mode	Description
Mode 1	TX B MODE CHANNEL 01/06/11
Mode 2	TX G MODE CHANNEL 01/06/11
Mode 3	TX N-20MHZ MODE CHANNEL 01/06/11
Mode 4	TX N-40MHZ MODE CHANNEL 03/06/09

The EUT system operated these modes were found to be the worst case during the pre-scanning test as following:

For Radiated Test	
Final Test Mode	Description
Mode 1	TX B MODE CHANNEL 01/06/11
Mode 2	TX G MODE CHANNEL 01/06/11
Mode 3	TX N-20MHZ MODE CHANNEL 01/06/11
Mode 4	TX N-40MHZ MODE CHANNEL 03/06/09

For Band Edge Test	
Final Test Mode	Description
Mode 1	TX B MODE CHANNEL 01/06/11
Mode 2	TX G MODE CHANNEL 01/06/11
Mode 3	TX N-20MHZ MODE CHANNEL 01/06/11
Mode 4	TX N-40MHZ MODE CHANNEL 03/06/09

6dB Spectrum Bandwidth	
Final Test Mode	Description
Mode 1	TX B MODE CHANNEL 01/06/11
Mode 2	TX G MODE CHANNEL 01/06/11
Mode 3	TX N-20MHZ MODE CHANNEL 01/06/11
Mode 4	TX N-40MHZ MODE CHANNEL 03/06/09

Maximum AVG Output Power	
Final Test Mode	Description
Mode 1	TX B MODE CHANNEL 01/06/11
Mode 2	TX G MODE CHANNEL 01/06/11
Mode 3	TX N-20MHZ MODE CHANNEL 01/06/11
Mode 4	TX N-40MHZ MODE CHANNEL 03/06/09

Power Spectral Density	
Final Test Mode	Description
Mode 1	TX B MODE CHANNEL 01/06/11
Mode 2	TX G MODE CHANNEL 01/06/11
Mode 3	TX N-20MHZ MODE CHANNEL 01/06/11
Mode 4	TX N-40MHZ MODE CHANNEL 03/06/09

**Note:**

- (1) The measurements are performed at the high, middle, low available channels.
- (2) 802.11b mode: DSSS(11/5.5/2/1 Mbps)  
 802.11g mode: OFDM (54/48/36/24/18/12/9/6 Mbps)  
 802.11n HT20 mode : OFDM (MCS0/1/2/3/4/5/6/7)  
 802.11n HT40 mode : OFDM (MCS0/1/2/3/4/5/6/7)  
 For all tests except conducted output power, the highest output powers were set for final test.
- (3) For radiated below 1G test, the 802.11b is found to be the worst case and recorded.
- (4) The EUT was programmed to be in continuously transmitting mode and the transmit duty cycle is not less than 98%.

### 3.3 TABLE OF PARAMETERS OF TEXT SOFTWARE SETTING

During testing, channel & power controlling software provided by the customer was used to control the operating channel as well as the output power level. The RF output power selection is for the setting of RF output power expected by the customer and is going to be fixed on the firmware of the final end product power parameters of WLAN

Test software version	DutApi_w8887_BrdigeEth		
Frequency (MHz)	2412	2437	2462
802.11b	14	14	14
802.11g	11	11	11
802.11n (20MHz)	11	11	11
Frequency (MHz)	2422	2437	2452
802.11n (40MHz)	11	11	11

### 3.4 BLOCK DIAGRAM SHOWING THE CONFIGURATION OF SYSTEM TESTED

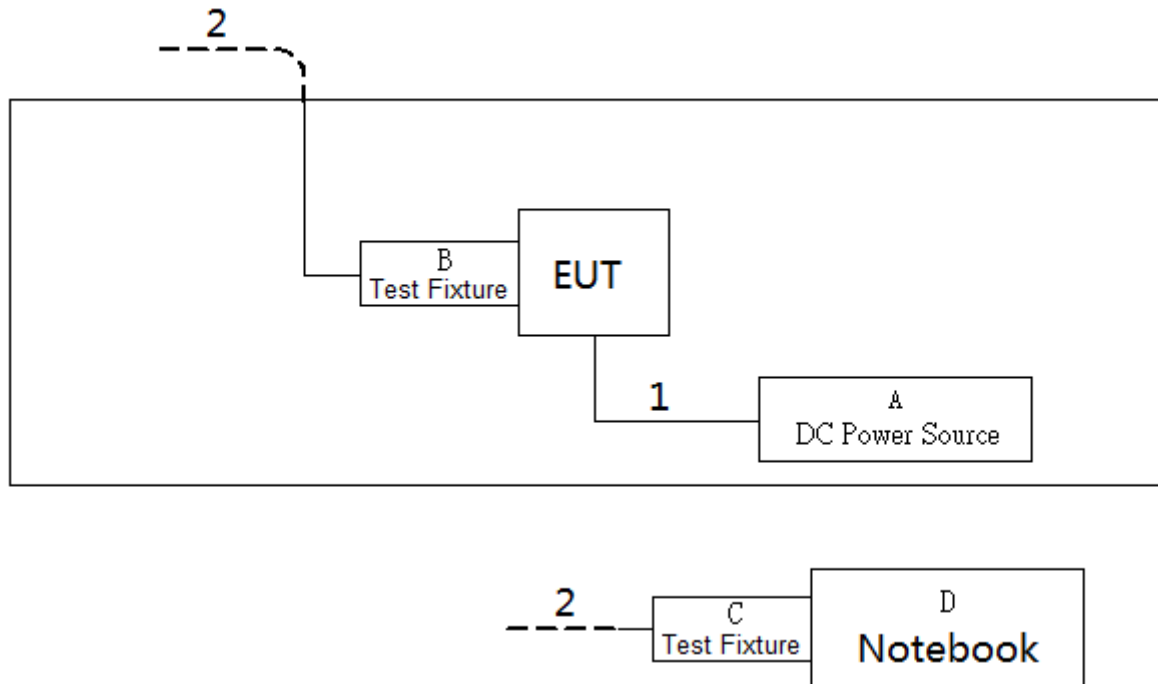

### 3.5 DESCRIPTION OF SUPPORT UNITS

The EUT has been tested as an independent unit together with other necessary accessories or support units. The following support units or accessories were used to form a representative test configuration during the tests.

Item	Equipment	Mfr/Brand	Model/Type No.	FCC ID	Series No.
A	DC Power Source	TRUE-POWER	GPC30300N	N/A	N/A
B	Test Fixture	N/A	N/A	N/A	N/A
C	Test Fixture	N/A	N/A	N/A	N/A
D	Notebook	DELL	DCSM	DOC	G7K832X

Item	Shielded Type	Ferrite Core	Length	Note
1	NO	NO	1m	DC Cable
2	NO	NO	10m	RJ45 Cable

## 4. EMC EMISSION TEST

### 4.1 RADIATED EMISSION MEASUREMENT

#### 4.1.1 RADIATED EMISSION LIMITS

In case the emission fall within the restricted band specified on 15.205(a), then the 15.209(a) limit in the table below has to be followed.

#### LIMITS OF RADIATED EMISSION MEASUREMENT (9KHz-1000MHz)

Frequency (MHz)	Field Strength (microvolts/meter)	Measurement Distance (meters)
0.009~0.490	2400/F(KHz)	300
0.490~1.705	24000/F(KHz)	30
1.705~30.0	30	30
30~88	100	3
88~216	150	3
216~960	200	3
960~1000	500	3

#### LIMITS OF RADIATED EMISSION MEASUREMENT (Above 1000MHz)

Frequency (MHz)	Band edge at 3m (dBμV/m)		Harmonic at 1.5m (dBμV/m)	
	Peak	Average	Peak	Average
Above 1000	74	54	80 (Note 5)	60(Note 5)

Notes:

- (1) The limit for radiated test was performed according to FCC PART 15C.
- (2) The tighter limit applies at the band edges.
- (3) Emission level (dBuV/m)=20log Emission level (uV/m).
- (4) The test result calculated as following:  
 Measurement Value = Reading Level + Correct Factor  
 Correct Factor = Antenna Factor + Cable Loss - Amplifier Gain(if use)  
 Margin Level = Measurement Value - Limit Value

(5)

$$FS_{\text{limit}} = FS_{\text{max}} - 20 \log \left( \frac{d_{\text{limit}}}{d_{\text{measure}}} \right)$$

$$20 \log d_{\text{limit}}/d_{\text{measure}} = 20 \log 3/1.5 = 6 \text{dB.}$$

Spectrum Parameter	Setting
Attenuation	Auto
Start Frequency	1000 MHz
Stop Frequency	10th carrier harmonic
RBW / VBW (Emission in restricted band)	1MHz / 3MHz for Peak, 1MHz / 1/T for Average

Receiver Parameter	Setting
Attenuation	Auto
Start ~ Stop Frequency	9KHz~90KHz for PK/AVG detector
Start ~ Stop Frequency	90KHz~110KHz for QP detector
Start ~ Stop Frequency	110KHz~490KHz for PK/AVG detector
Start ~ Stop Frequency	490KHz~30MHz for QP detector
Start ~ Stop Frequency	30MHz~1000MHz for QP detector

#### 4.1.2 TEST PROCEDURE

- a. The measuring distance of 3 m shall be used for measurements. The EUT was placed on the top of a rotating table 0.8 meter above the ground at a 3 meter semi-anechoic chamber. The table was rotated 360 degrees to determine the position of the highest radiation.(below 1GHz)
- b. The measuring distance of 3 m or 1.5m shall be used for measurements. The EUT was placed on the top of a rotating table 1.5 meter above the ground at a 3 meter semi-anechoic chamber. The table was rotated 360 degrees to determine the position of the highest radiation.(above 1GHz)
- c. The height of the equipment or of the substitution antenna shall be 0.8m or 1.5m; the height of the test antenna shall vary between 1 m to 4 m. Both horizontal and vertical polarizations of the antenna are set to make the measurement.
- d. For each suspected emission, the EUT was arranged to its worst case and then the antenna was tuned to heights find the maximum reading (used Bore sight function).
- e. The receiver system was set to peak and average detect function and specified bandwidth with maximum hold mode when the test frequency is above 1GHz.
- f. The initial step in collecting radiated emission data is a receiver peak detector mode pre-scanning the measurement frequency range. Significant peaks are then marked and then Quasi Peak detector mode re-measured.
- g. All readings are Peak unless otherwise stated QP in column of Note. Peak denotes that the Peak reading compliance with the QP Limits and then QP Mode measurement didn't perform. (below 1GHz)
- h. All readings are Peak Mode value unless otherwise stated AVG in column of Note. If the Peak Mode Measured value compliance with the Peak Limits and lower than AVG Limits, the EUT shall be deemed to meet both Peak & AVG Limits and then only Peak Mode was measured, but AVG Mode didn't perform. (above 1GHz)
- i. For the actual test configuration, please refer to the related Item -EUT Test Photos.

#### 4.1.3 DEVIATION FROM TEST STANDARD

No deviation

#### 4.1.4 TEST SETUP

(A) Radiated Emission Test Set-Up Frequency Below 1 GHz

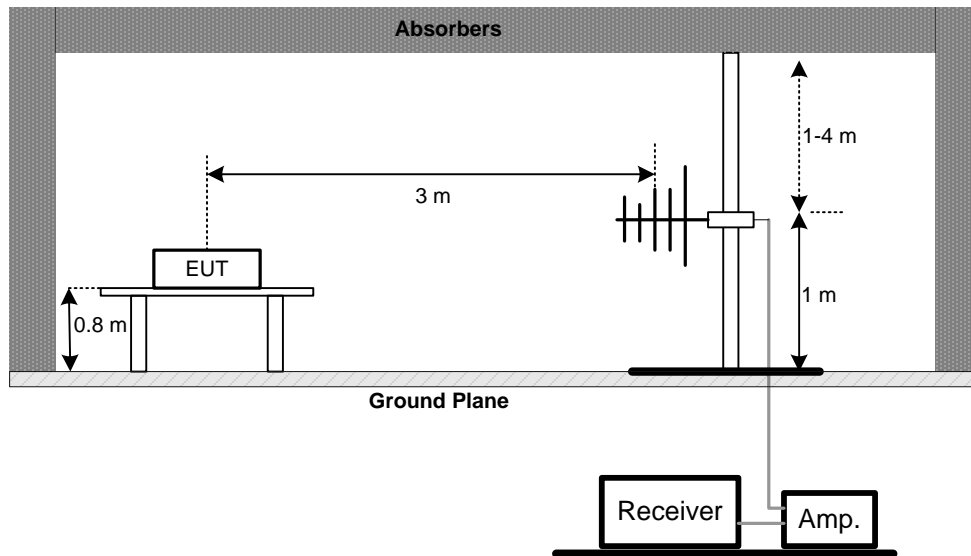



(B) Radiated Emission Test Set-Up Frequency Above 1 GHz  
Band edge

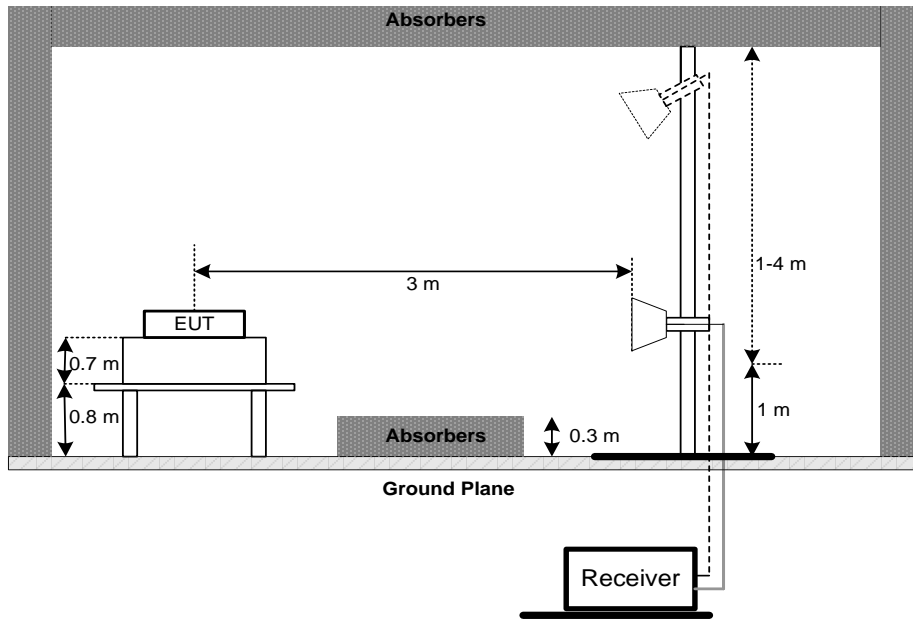

Harmonic

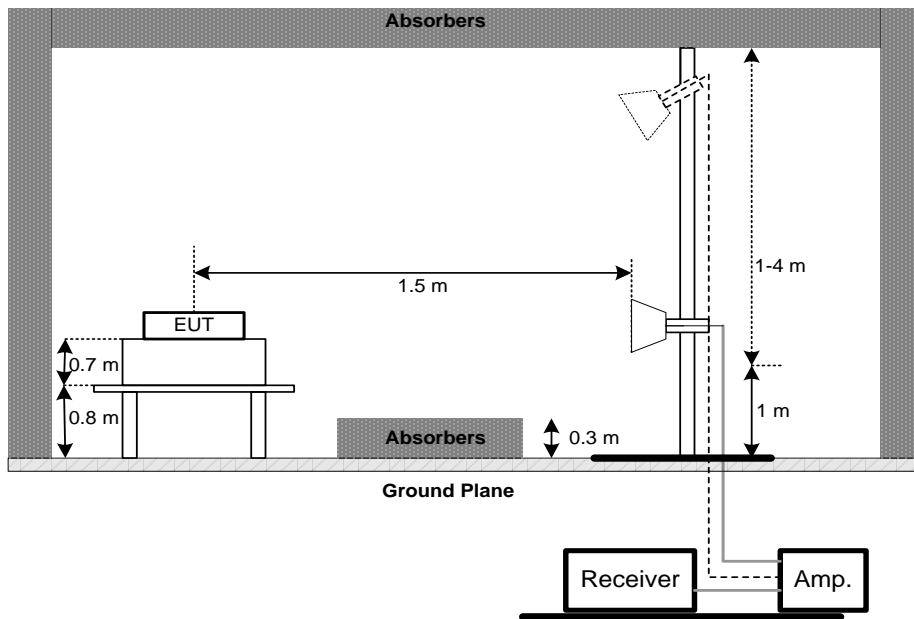

(C) For Radiated Emissions Below 30MHz

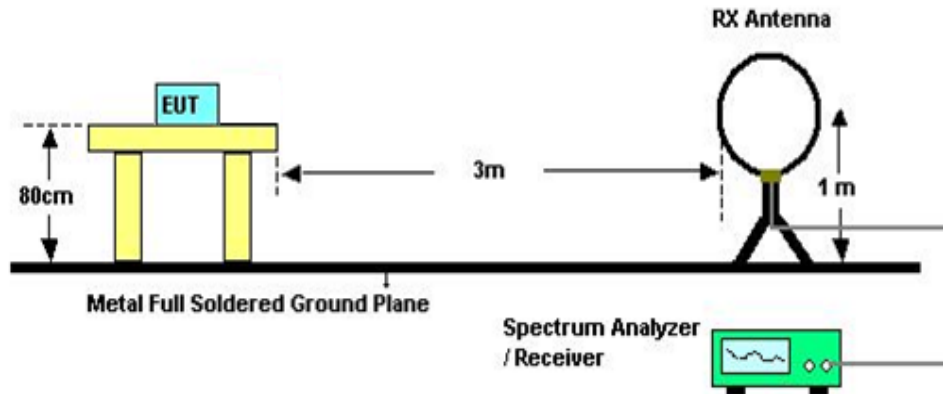

#### 4.1.5 EUT OPERATING CONDITIONS

The EUT was programmed to be in continuously transmitting mode.

#### 4.1.6 EUT TEST CONDITIONS

Temperature: 25°C    Relative Humidity: 55%    Test Voltage: DC 13.5V

#### 4.1.7 TEST RESULTS (9KHZ TO 30MHZ)

Please refer to the Appendix A.

Remark:

- (1) The amplitude of spurious emissions which are attenuated by more than 20 dB below the permissible value has no need to be reported.
- (2) Distance extrapolation factor =  $40 \log(\text{specific distance} / \text{test distance})$  (dB).
- (3) Limit line = specific limits (dBuV) + distance extrapolation factor.

#### 4.1.8 TEST RESULTS (30MHZ TO 1000MHZ)

Please refer to the Appendix B.

#### 4.1.9 TEST RESULTS (ABOVE 1000MHZ)

Please refer to the Appendix C.

Remark:

- (1) No limit: This is fundamental signal, the judgment is not applicable.  
For fundamental signal judgment was referred to Peak output test.

## 5. BANDWIDTH TEST

### 5.1 APPLIED PROCEDURES

FCC Part15 (15.247) , Subpart C			
Section	Test Item	Frequency Range (MHz)	Result
15.247(a)(2)	Bandwidth	2400-2483.5	PASS

#### 5.1.1 TEST PROCEDURE

- a. The EUT was directly connected to the spectrum analyzer and antenna output port as show in the block diagram below,
- b. Spectrum Setting: RBW= 100KHz, VBW=300KHz, Sweep time = 2.5 ms.

#### 5.1.2 DEVIATION FROM STANDARD

No deviation.

#### 5.1.3 TEST SETUP



#### 5.1.4 EUT OPERATION CONDITIONS

The EUT was programmed to be in continuously transmitting mode.

#### 5.1.5 EUT TEST CONDITIONS

Temperature: 25°C    Relative Humidity: 55%    Test Voltage: DC 13.5V

#### 5.1.6 TEST RESULTS

Please refer to the Appendix D.

## 6. MAXIMUM AVG OUTPUT POWER TEST

### 6.1 APPLIED PROCEDURES / LIMIT

FCC Part15 (15.247) , Subpart C				
Section	Test Item	Limit	Frequency Range (MHz)	Result
15.247(b)(3)	Maximum Output Power	1 Watt or 30dBm	2400-2483.5	PASS

#### 6.1.1 TEST PROCEDURE

- a. The EUT was directly connected to the power meter and antenna output port as show in the block diagram below,
- b. The maximum average conducted output power was performed in accordance with method 9.1.2 of FCC KDB 558074 D01 v04 DTS Meas Guidance.

#### 6.1.2 DEVIATION FROM STANDARD

No deviation.

#### 6.1.3 TEST SETUP

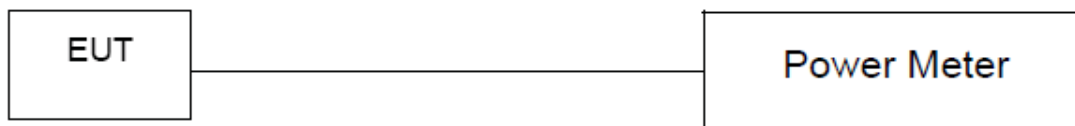

#### 6.1.4 EUT OPERATION CONDITIONS

The EUT was programmed to be in continuously transmitting mode.

#### 6.1.5 EUT TEST CONDITIONS

Temperature: 25°C    Relative Humidity: 55%    Test Voltage: DC 13.5V

#### 6.1.6 TEST RESULTS

Please refer to the Appendix E.

## 7. ANTENNA CONDUCTED SPURIOUS EMISSION

### 7.1 APPLIED PROCEDURES / LIMIT

In any 100 kHz bandwidth outside the frequency band in which the spread spectrum or digitally modulated device is operating, the RF power that is produced shall be at least 20 dB below that in the 100 kHz bandwidth within the band that contains the highest level of the desired power, based on either an RF conducted or a radiated measurement, provided that the transmitter demonstrates compliance with the peak conducted power limits. If the transmitter complies with the conducted power limits based on the use of RMS averaging over a time interval, as permitted under paragraph (b)(3) of this section, the attenuation required under this paragraph shall be 30 dB instead of 20 dB. Attenuation below the general limits specified in §15.209(a) is not required. In addition, radiated emissions which fall in the restricted bands, as defined in §15.205(a), must also comply with the radiated emission limits specified in §15.209(a) (see §15.205(c))

#### 7.1.1 TEST PROCEDURE

- a. The EUT was directly connected to the spectrum analyzer and antenna output port as show in the block diagram below,
- b. Spectrum Setting: RBW= 100KHz, VBW=300KHz, Sweep time = Auto.
- c. Offset=antenna gain+cable loss

#### 7.1.2 DEVIATION FROM STANDARD

No deviation.

#### 7.1.3 TEST SETUP



#### 7.1.4 EUT OPERATION CONDITIONS

The EUT was programmed to be in continuously transmitting mode.

#### 7.1.5 EUT TEST CONDITIONS

Temperature: 25°C    Relative Humidity: 55%    Test Voltage: DC 13.5V

#### 7.1.6 TEST RESULTS

Please refer to the Appendix F.

## 8. POWER SPECTRAL DENSITY TEST

### 8.1 APPLIED PROCEDURES / LIMIT

FCC Part15 (15.247) , Subpart C				
Section	Test Item	Limit	Frequency Range (MHz)	Result
15.247(e)	Power Spectral Density	8 dBm (in any 3KHz)	2400-2483.5	PASS

#### 8.1.1 TEST PROCEDURE

- a. The EUT was directly connected to the spectrum analyzer and antenna output port as show in the block diagram below,
- b. Spectrum Setting: RBW=3KHz, VBW=10KHz, Sweep time = Auto.

#### 8.1.2 DEVIATION FROM STANDARD

No deviation.

#### 8.1.3 TEST SETUP

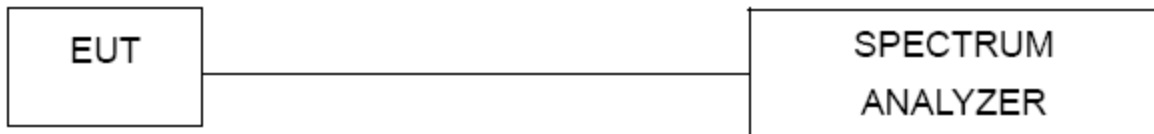

#### 8.1.4 EUT OPERATION CONDITIONS

The EUT was programmed to be in continuously transmitting mode.

#### 8.1.5 EUT TEST CONDITIONS

Temperature: 25°C    Relative Humidity: 55%    Test Voltage: DC 13.5V

#### 8.1.6 TEST RESULTS

Please refer to the Appendix G.

## 9. MEASUREMENT INSTRUMENTS LIST

Radiated Emission Measurement - Below 1GHz					
Item	Kind of Equipment	Manufacturer	Type No.	Serial No.	Calibrated until
1	Antenna	Schwarbeck	VULB9160	9160-3232	Mar. 11, 2019
2	Amplifier	HP	8447D	2944A09673	Oct. 19, 2018
3	Receiver	Agilent	N9038A	MY52130039	Aug. 20, 2018
4	Cable	emci	LMR-400(30MHz-1GHz)(8m+5m)	N/A	May. 25, 2019
5	Controller	CT	SC100	N/A	N/A
6	Controller	MF	MF-7802	MF780208416	N/A
7	Measurement Software	Farad	EZ-EMC Ver.NB-03A1-01	N/A	N/A
8	Antenna	EM	EM-6876-1	230	Feb. 07, 2019

Radiated Emission Measurement - Above 1GHz					
Item	Kind of Equipment	Manufacturer	Type No.	Serial No.	Calibrated until
1	Double Ridged Guide Antenna	ETS	3115	75789	Mar. 11, 2019
2	Broad-Band Horn Antenna	Schwarzbeck	BBHA 9170	9170319	Jun. 30, 2019
3	Amplifier	Agilent	8449B	3008A02274	Mar. 11, 2019
4	Microwave Preamplifier With Adaptor	EMC INSTRUMENT	EMC2654045	980039 & HA01	Mar. 11, 2019
5	Receiver	Agilent	N9038A	MY52130039	Aug. 20, 2018
6	Controller	CT	SC100	N/A	N/A
7	Controller	MF	MF-7802	MF780208416	N/A
8	Cable	N/A	CA500-SMSM-12M (1-26.5GHz)	N/A	Sep. 29, 2018
9	Measurement Software	Farad	EZ-EMC Ver.NB-03A1-01	N/A	N/A

6dB Bandwidth					
Item	Kind of Equipment	Manufacturer	Type No.	Serial No.	Calibrated until
1	Spectrum Analyzer	R&S	FSP40	100185	Aug. 20, 2018

AVG Output Power					
Item	Kind of Equipment	Manufacturer	Type No.	Serial No.	Calibrated until
1	Cable	emci	EMC104-SM-SM-9000(0.01GHz – 26.5GHz)	N/A	N/A
2	Power Sensor	Agilent	U2021XA	MY53020007	Mar. 11, 2019
3	Measurement Software	Keysight	EN300328v2.1.1(V1.01.40)	N/A	N/A

Antenna Conducted Spurious Emission					
Item	Kind of Equipment	Manufacturer	Type No.	Serial No.	Calibrated until
1	Spectrum Analyzer	R&S	FSP40	100185	Aug. 20, 2018

Power Spectral Density					
Item	Kind of Equipment	Manufacturer	Type No.	Serial No.	Calibrated until
1	Spectrum Analyzer	R&S	FSP40	100185	Aug. 20, 2018

Remark: "N/A" denotes no model name, serial no. or calibration specified.  
 All calibration period of equipment list is one year.



**10. EUT TEST PHOTO****Radiated Measurement Photos****9KHz to 30MHz**

### Radiated Measurement Photos

30MHz to 1000MHz

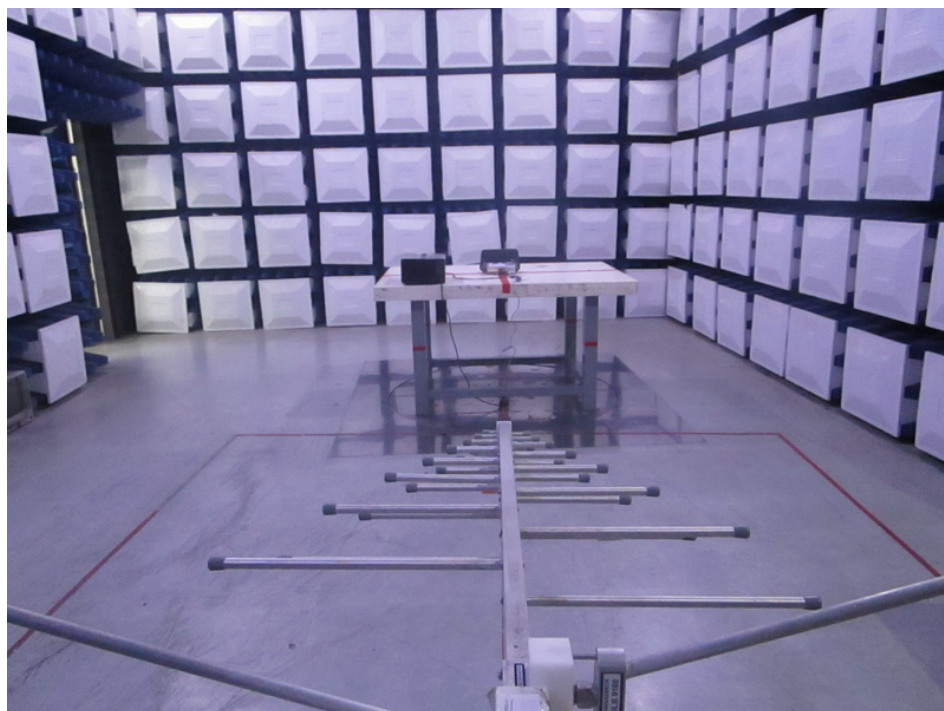
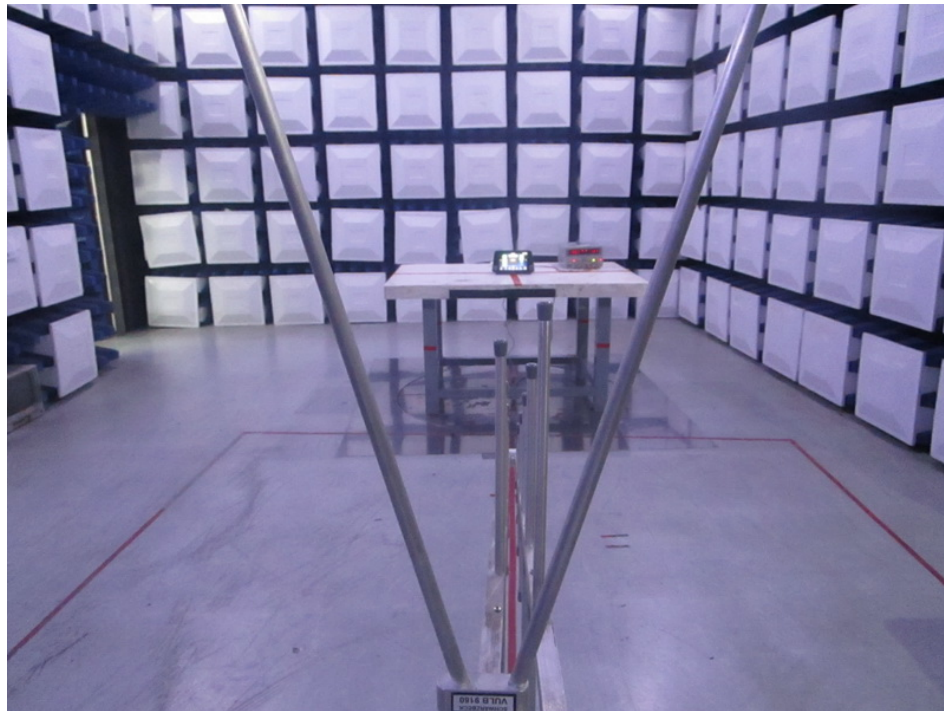

**Radiated Measurement Photos**

**1GHz to 18GHz**

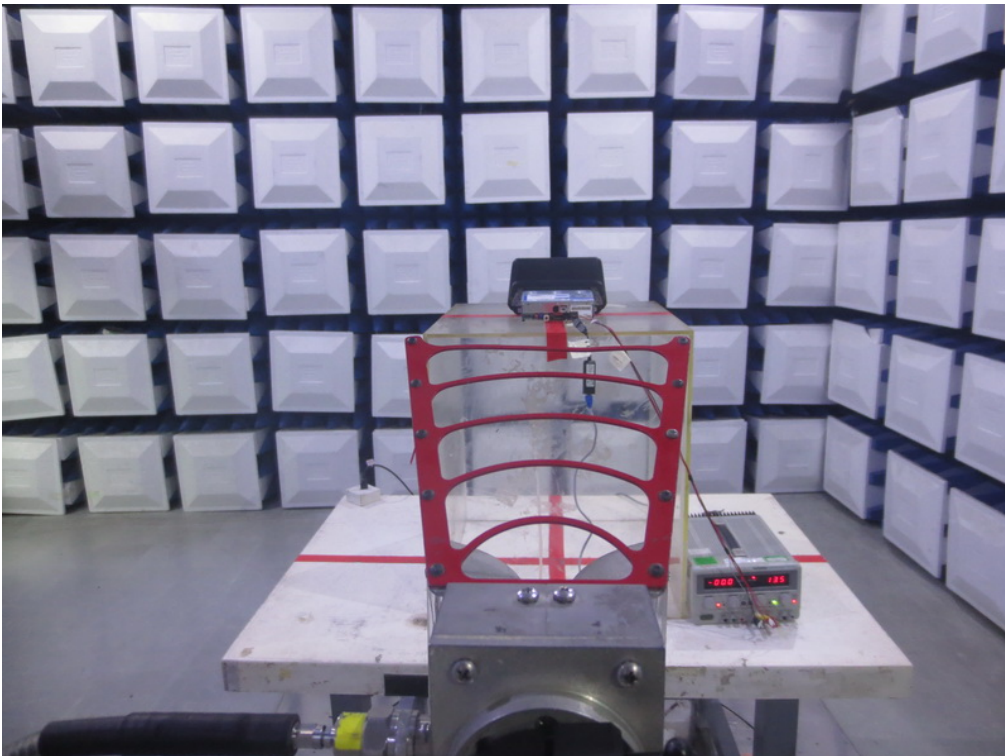

## Radiated Measurement Photos

18GHz to 26.5GHz

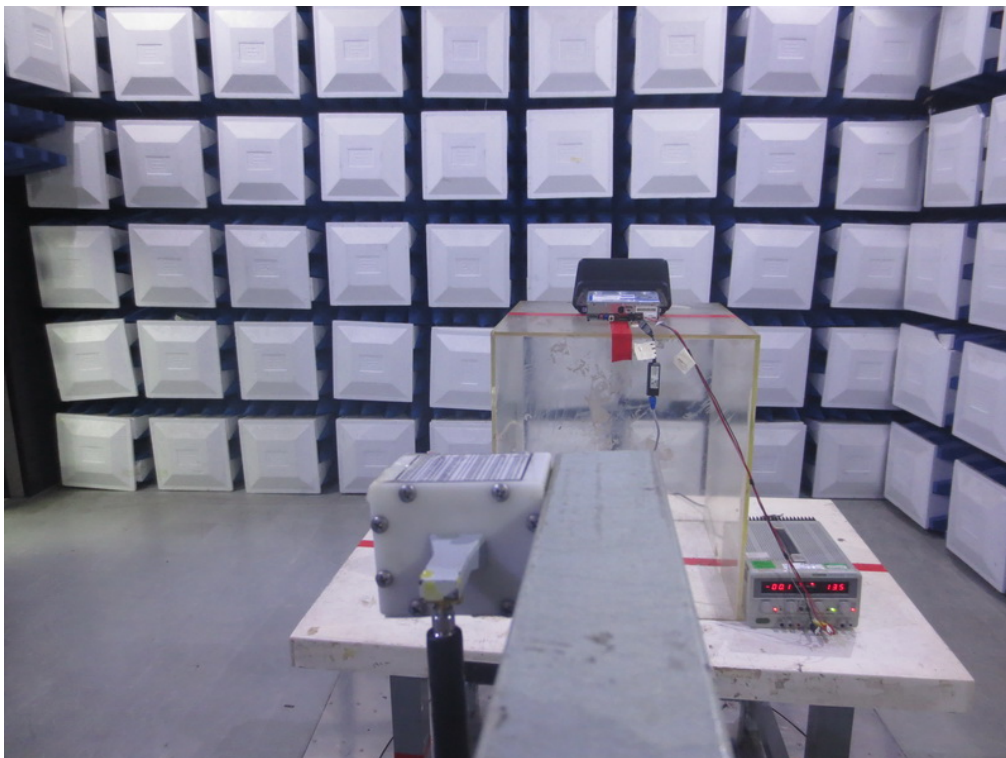
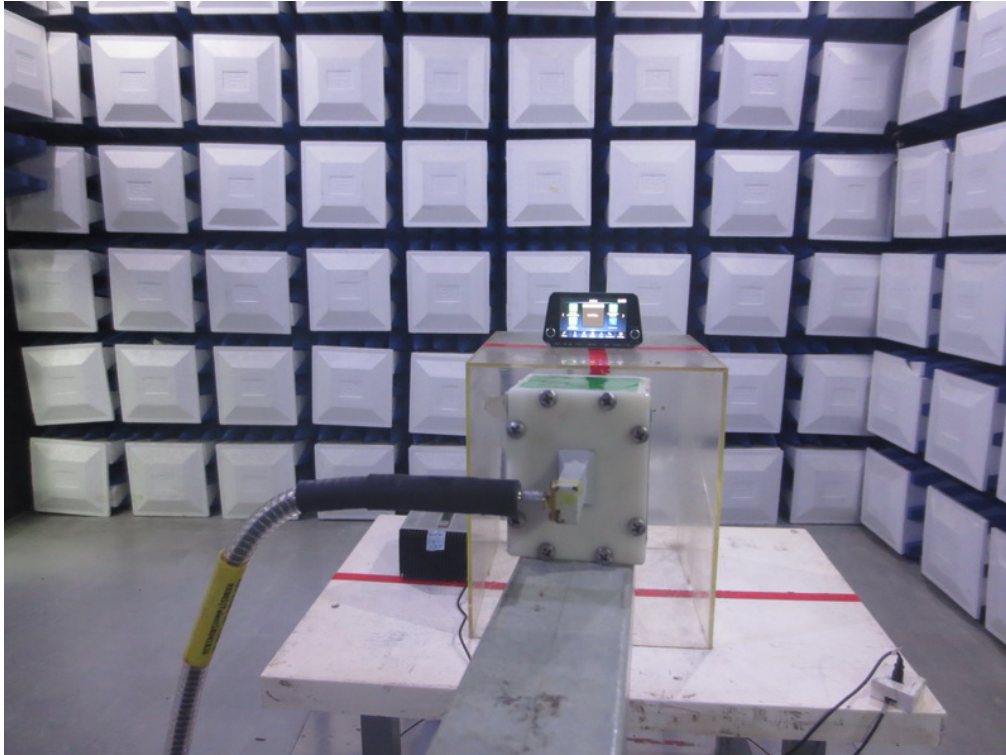

**Band Edge Measurement Photos**



## APPENDIX A - RADIATED EMISSION (9KHZ TO 30MHZ)

Test Mode: TX MODE

Ant 0°

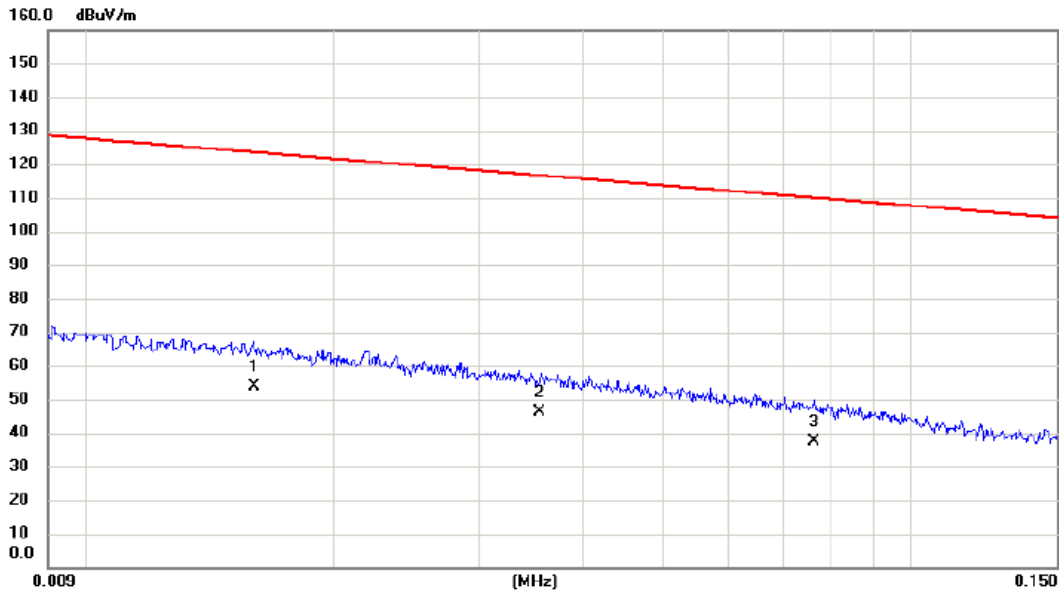

No.	Mk.	Freq. MHz	Reading Level dBuV	Correct Factor dB	Measure- ment dBuV/m	Limit dBuV/m	Margin dB	Detector	Comment
1	*	0.0160	33.21	20.58	53.79	123.52	-69.73	AVG	
2		0.0355	26.50	19.76	46.26	116.60	-70.34	AVG	
3		0.0761	18.60	19.00	37.60	109.98	-72.38	AVG	

Test Mode: TX MODE

Ant 0°

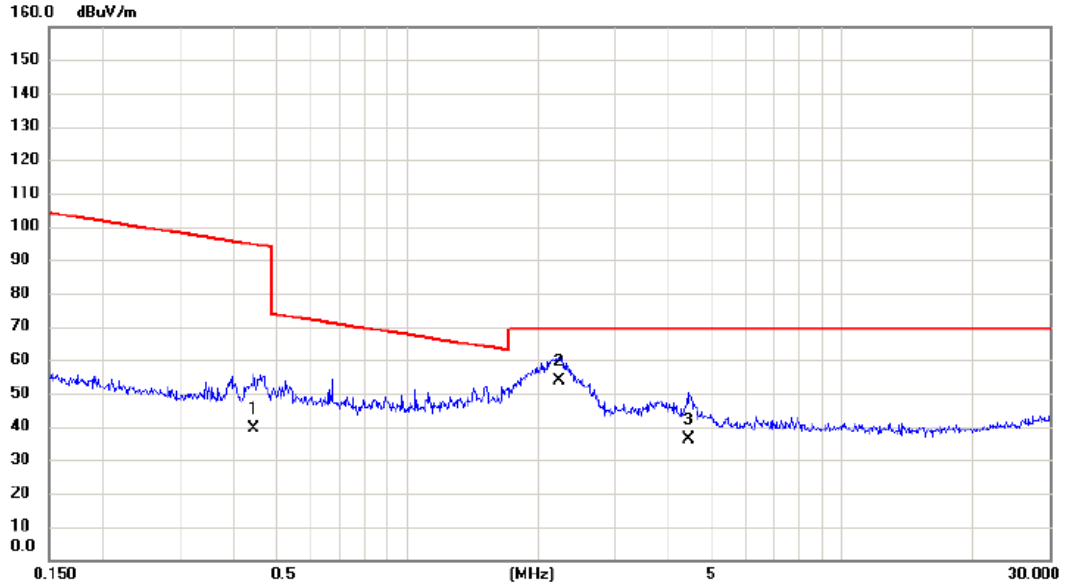

No.	Mk.	Freq. MHz	Reading Level dBuV	Correct Factor dB	Measure- ment dBuV/m	Limit dBuV/m	Margin dB	Detector	Comment
1		0.4444	22.50	16.99	39.49	94.65	-55.16	AVG	
2	*	2.2367	36.80	16.97	53.77	69.54	-15.77	QP	
3		4.4305	20.60	15.50	36.10	69.54	-33.44	QP	



Test Mode: TX MODE

Ant 90°

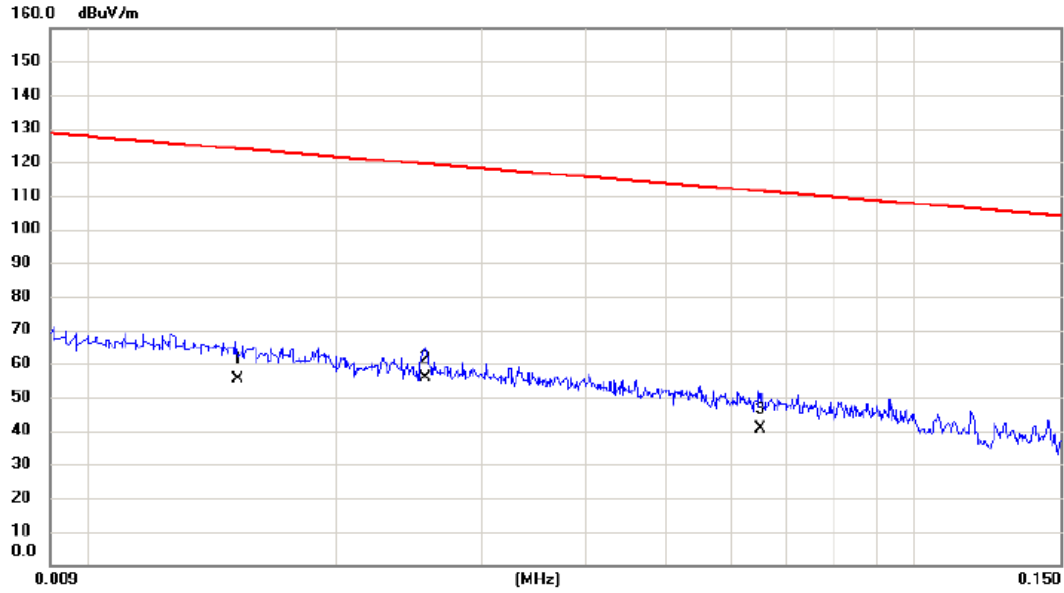

No.	Mk.	Freq. MHz	Reading Level dBuV	Correct Factor dB	Measure- ment dBuV/m	Limit dBuV/m	Margin dB	Detector	Comment
1		0.0152	34.80	20.69	55.49	123.97	-68.48	AVG	
2	*	0.0256	35.70	19.93	55.63	119.44	-63.81	AVG	
3		0.0650	21.40	19.23	40.63	111.35	-70.72	AVG	

Test Mode: TX MODE

Ant 90°

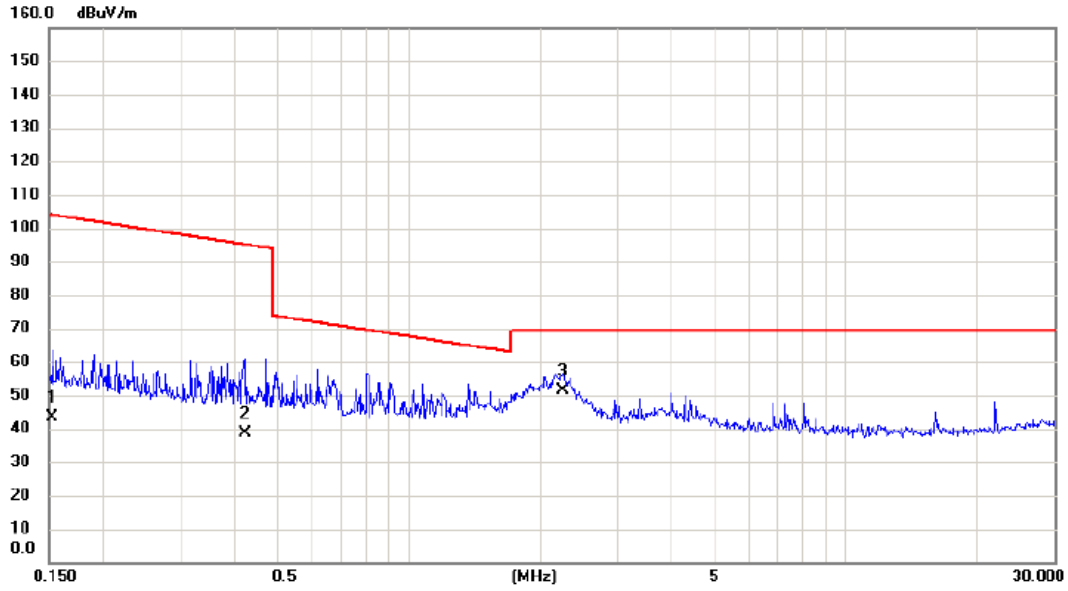

No.	Mk.	Freq. MHz	Reading Level dBuV	Correct Factor dB	Measure- ment dBuV/m	Limit dBuV/m	Margin dB	Detector	Comment
1		0.1532	26.30	17.24	43.54	103.90	-60.36	AVG	
2		0.4214	21.80	17.00	38.80	95.11	-56.31	AVG	
3	*	2.2486	34.60	16.96	51.56	69.54	-17.98	QP	

## APPENDIX B - RADIATED EMISSION (30MHZ TO 1000MHZ)

Test Mode: TX B MODE CHANNEL 01

**Vertical**

80 dBuV/m

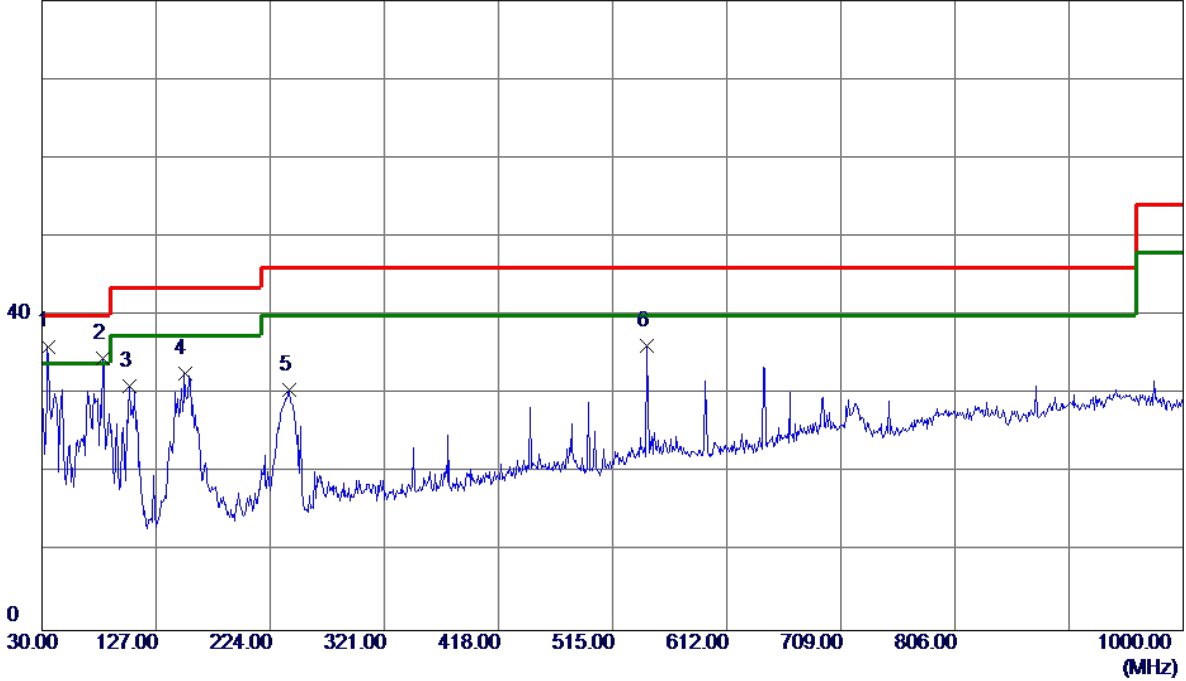

No.	Freq. MHz	Reading Level dBuV/m	Correct Factor dB	Measure ment dBuV/m	Limit dBuV/m	Margin dB	Detector	Comment
1 *	34.8500	50.97	-14.89	36.08	40.00	-3.92	Peak	
2	81.4100	53.26	-18.73	34.53	40.00	-5.47	Peak	
3	104.6900	48.40	-17.34	31.06	43.50	-12.44	Peak	
4	151.2500	44.05	-11.38	32.67	43.50	-10.83	Peak	
5	240.4900	45.22	-14.66	30.56	46.00	-15.44	Peak	
6	544.1000	41.91	-5.82	36.09	46.00	-9.91	Peak	

Test Mode: TX B MODE CHANNEL 01

Horizontal

80 dBuV/m

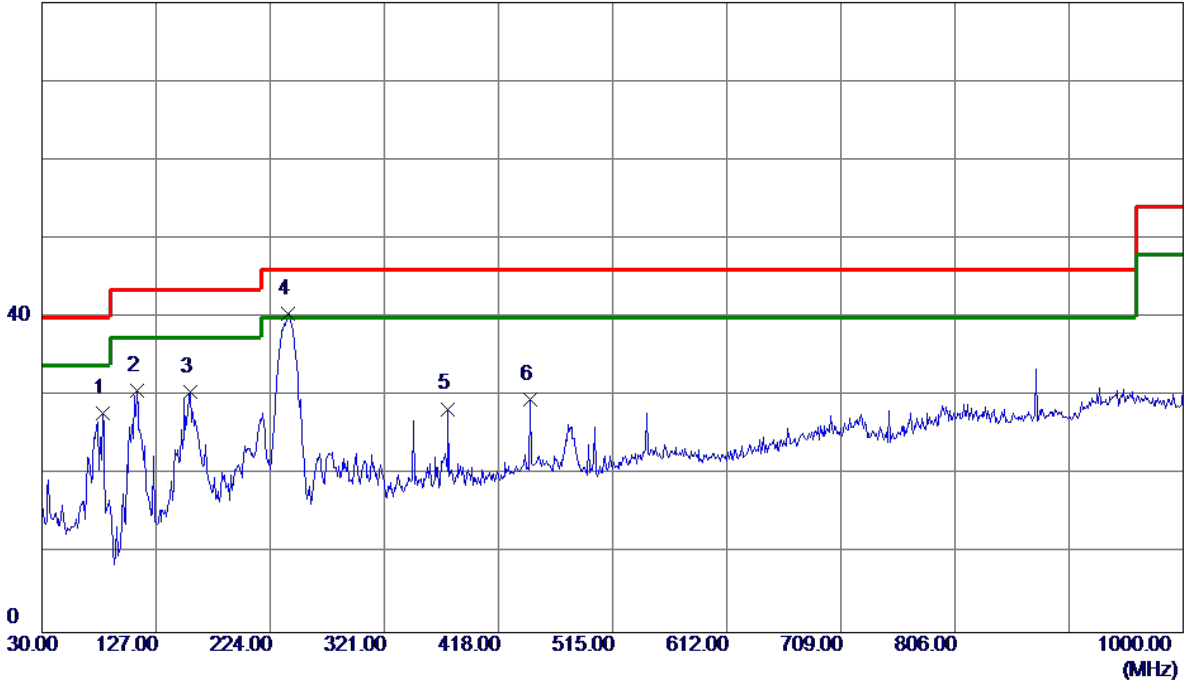

No.	Freq. MHz	Reading Level dBuV/m	Correct Factor dB	Measure ment dBuV/m	Limit dBuV/m	Margin dB	Detector	Comment
1	81.4100	46.59	-18.73	27.86	40.00	-12.14	Peak	
2	110.5100	46.88	-16.20	30.68	43.50	-12.82	Peak	
3	156.1000	41.57	-10.95	30.62	43.50	-12.88	Peak	
4 *	239.5200	55.14	-14.69	40.45	46.00	-5.55	Peak	
5	375.3200	38.62	-10.22	28.40	46.00	-17.60	Peak	
6	445.1600	37.13	-7.60	29.53	46.00	-16.47	Peak	

Test Mode: TX B MODE CHANNEL 06

**Vertical**

80 dBuV/m

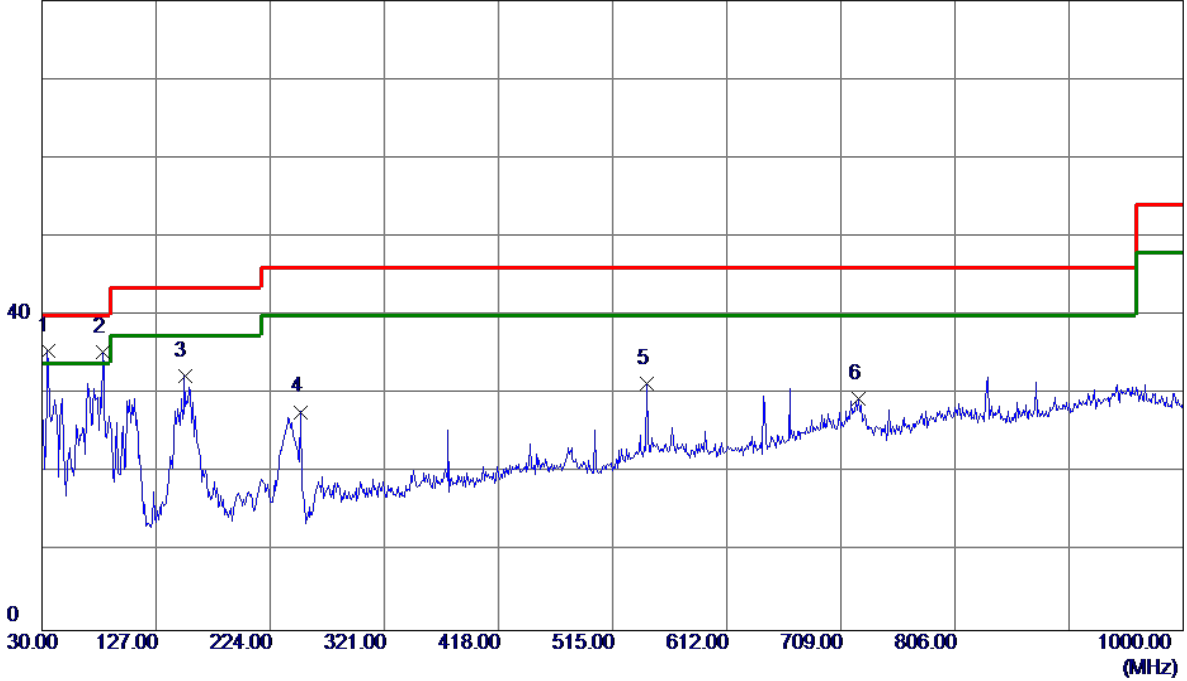

No.	Freq. MHz	Reading Level dBuV/m	Correct Factor dB	Measure ment dBuV/m	Limit dBuV/m	Margin dB	Detector	Comment
1 *	34.8500	50.46	-14.89	35.57	40.00	-4.43	Peak	
2	81.4100	54.03	-18.73	35.30	40.00	-4.70	Peak	
3	151.2500	43.74	-11.38	32.36	43.50	-11.14	Peak	
4	250.1900	42.04	-14.28	27.76	46.00	-18.24	Peak	
5	544.1000	37.13	-5.82	31.31	46.00	-14.69	Peak	
6	724.5200	32.79	-3.38	29.41	46.00	-16.59	Peak	

Test Mode: TX B MODE CHANNEL 06

Horizontal

80 dBuV/m

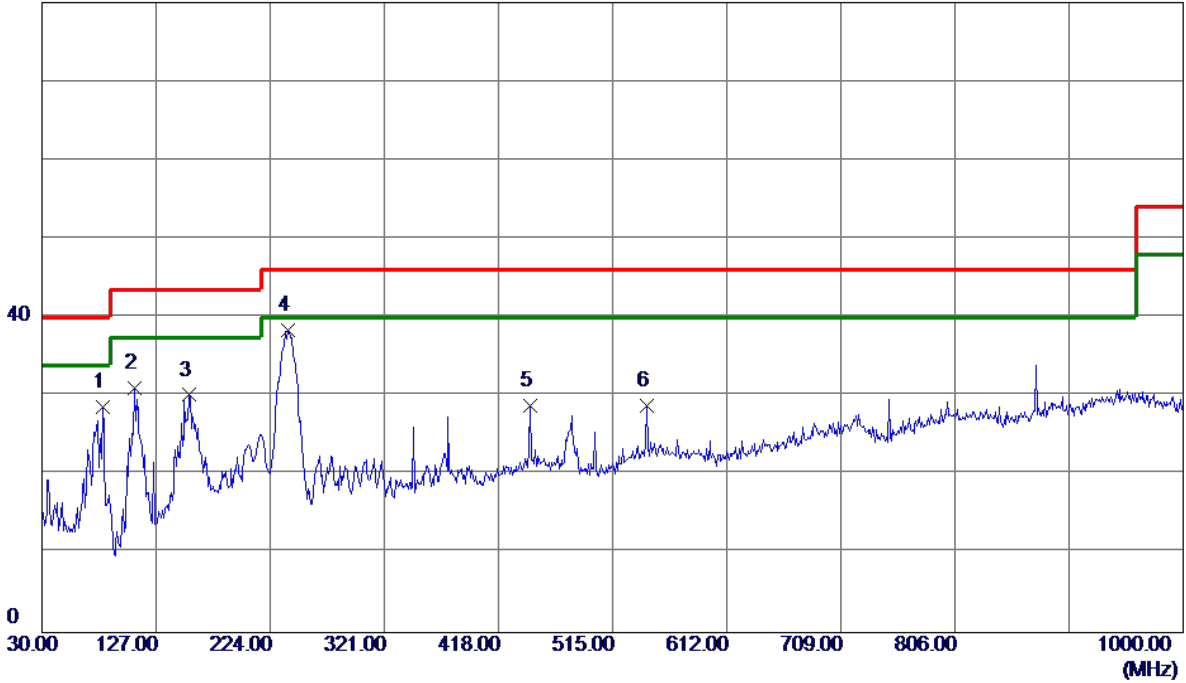

No.	Freq. MHz	Reading Level dBuV/m	Correct Factor dB	Measure ment dBuV/m	Limit dBuV/m	Margin dB	Detector	Comment
1	81.4100	47.39	-18.73	28.66	40.00	-11.34	Peak	
2	108.5700	47.63	-16.57	31.06	43.50	-12.44	Peak	
3	155.1300	41.19	-11.03	30.16	43.50	-13.34	Peak	
4 *	239.5200	53.08	-14.69	38.39	46.00	-7.61	Peak	
5	445.1600	36.37	-7.60	28.77	46.00	-17.23	Peak	
6	544.1000	34.68	-5.82	28.86	46.00	-17.14	Peak	

Test Mode: TX B MODE CHANNEL 11

**Vertical**

80 dBuV/m

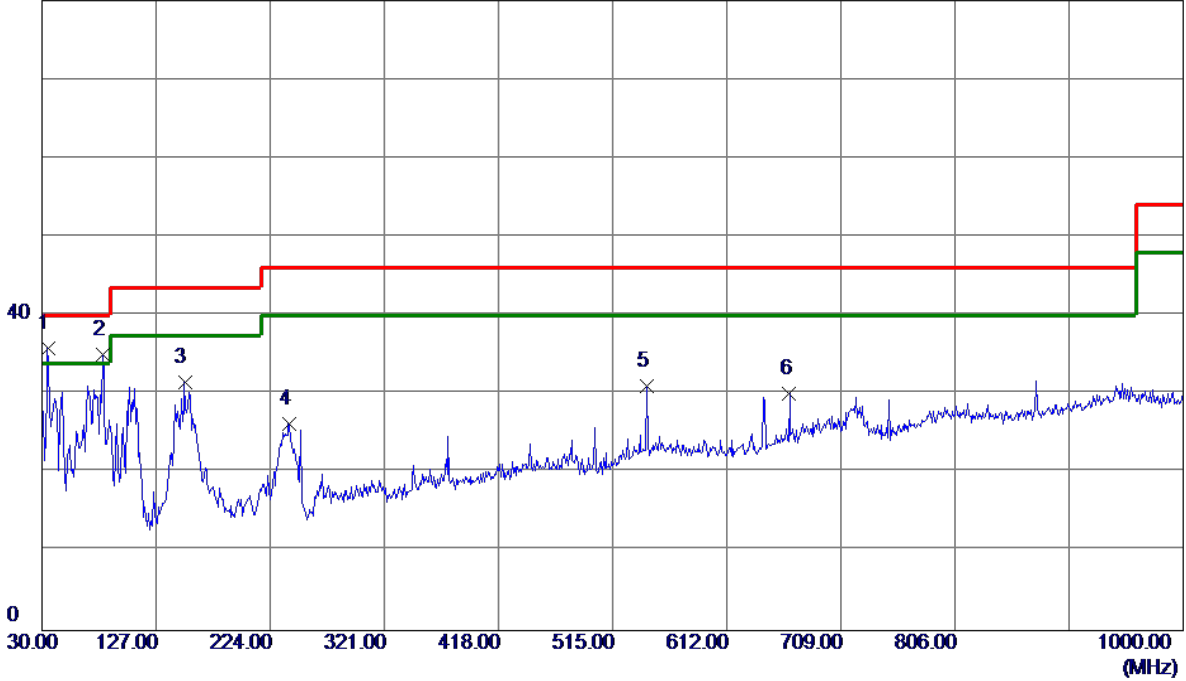

No.	Freq. MHz	Reading Level dBuV/m	Correct Factor dB	Measure ment dBuV/m	Limit dBuV/m	Margin dB	Detector	Comment
1 *	34.8500	50.80	-14.89	35.91	40.00	-4.09	Peak	
2	81.4100	53.79	-18.73	35.06	40.00	-4.94	Peak	
3	151.2500	42.85	-11.38	31.47	43.50	-12.03	Peak	
4	240.4900	40.87	-14.66	26.21	46.00	-19.79	Peak	
5	544.1000	36.82	-5.82	31.00	46.00	-15.00	Peak	
6	665.3500	34.49	-4.43	30.06	46.00	-15.94	Peak	



Test Mode: TX B MODE CHANNEL 11

**Horizontal**

80 dBuV/m

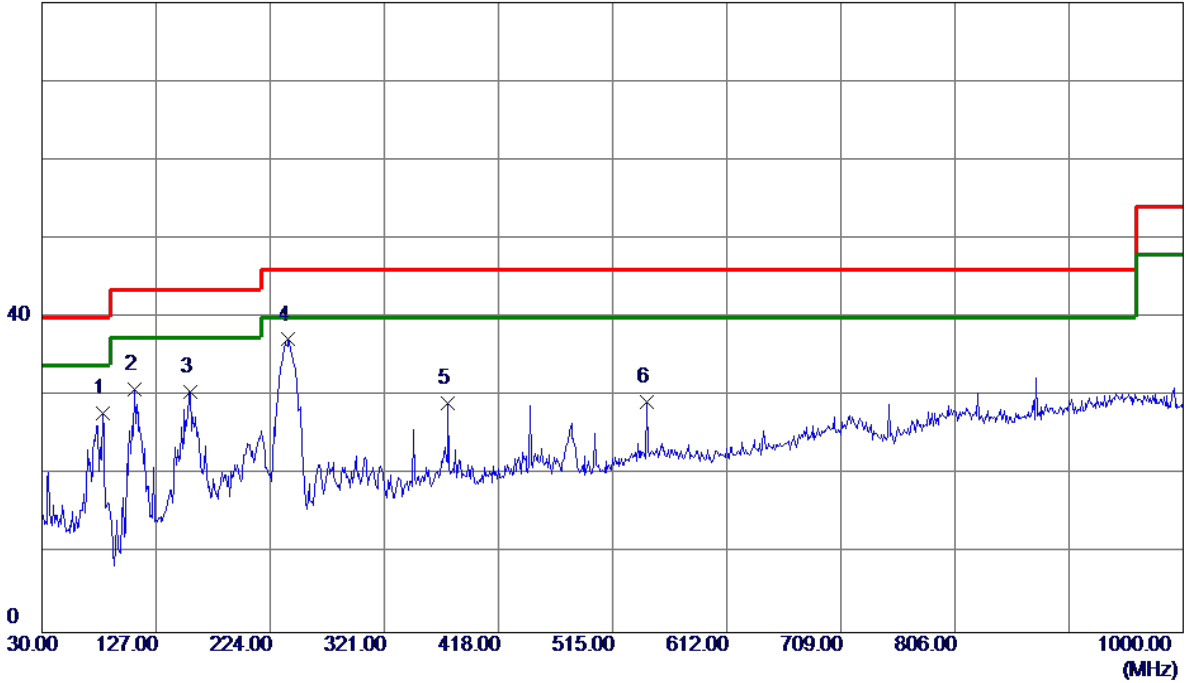

No.	Freq. MHz	Reading Level dBuV/m	Correct Factor dB	Measure ment dBuV/m	Limit dBuV/m	Margin dB	Detector	Comment
1	81.4100	46.50	-18.73	27.77	40.00	-12.23	Peak	
2	108.5700	47.46	-16.57	30.89	43.50	-12.61	Peak	
3	156.1000	41.58	-10.95	30.63	43.50	-12.87	Peak	
4 *	239.5200	51.89	-14.69	37.20	46.00	-8.80	Peak	
5	375.3200	39.31	-10.22	29.09	46.00	-16.91	Peak	
6	544.1000	35.04	-5.82	29.22	46.00	-16.78	Peak	

## APPENDIX C - RADIATED EMISSION (ABOVE 1000MHZ)

Orthogonal Axis :	X
Test Mode :	TX B MODE 2412MHz

**Vertical**

130 dBuV/m

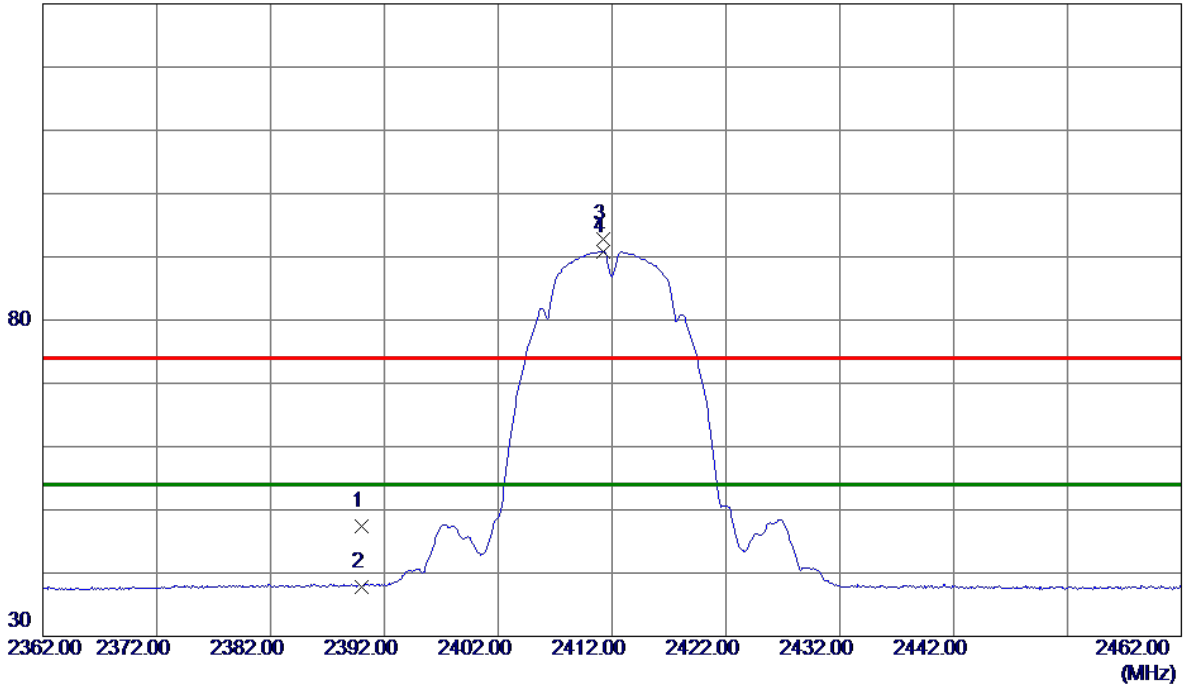

No.	Freq. MHz	Reading Level dBuV/m	Correct Factor dB	Measure ment dBuV/m	Limit dBuV/m	Margin dB	Detector	Comment
1	2390.0000	36.12	11.32	47.44	74.00	-26.56	Peak	
2	2390.0000	26.53	11.32	37.85	54.00	-16.15	AVG	
3	2411.2000	81.55	11.33	92.88	74.00	18.88	Peak	No Limit
4 *	2411.2000	79.53	11.33	90.86	54.00	36.86	AVG	No Limit

Orthogonal Axis :	X
Test Mode :	TX B MODE 2412MHz

**Vertical**

130 dBuV/m

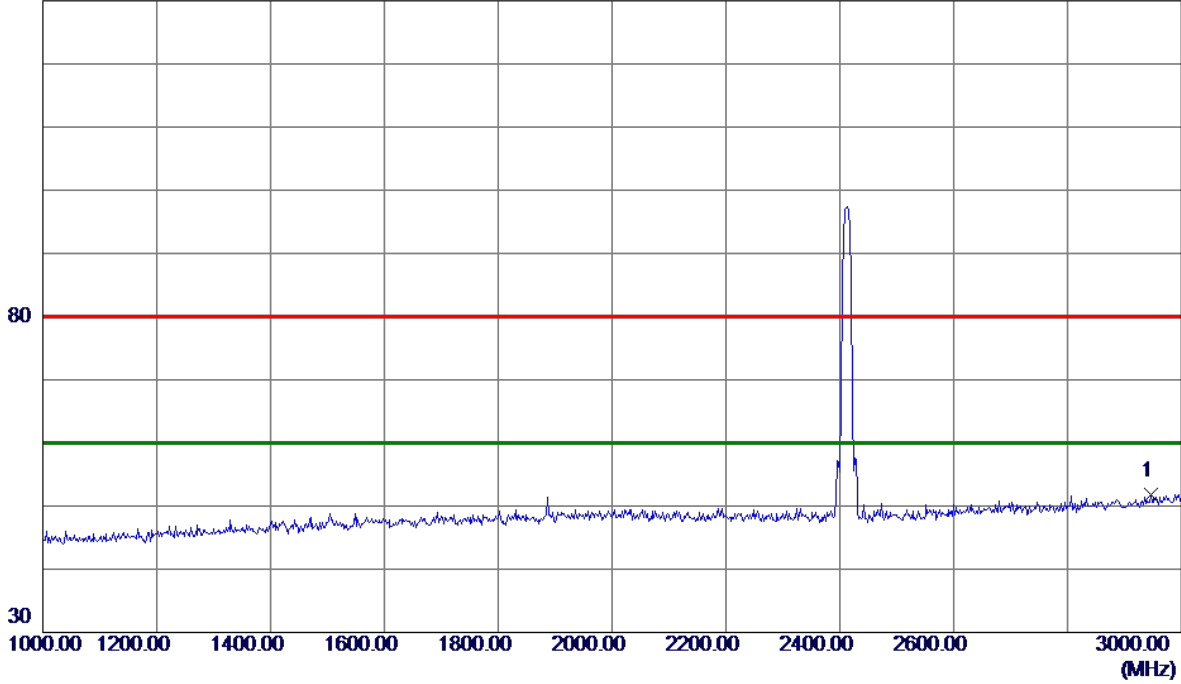

No.	Freq. MHz	Reading Level dBuV/m	Correct Factor dB	Measure ment dBuV/m	Limit dBuV/m	Margin dB	Detector	Comment
1 *	2946.0000	37.09	14.61	51.70	80.00	-28.30	Peak	

Orthogonal Axis :	X
Test Mode :	TX B MODE 2412MHz

**Vertical**

130 dBuV/m

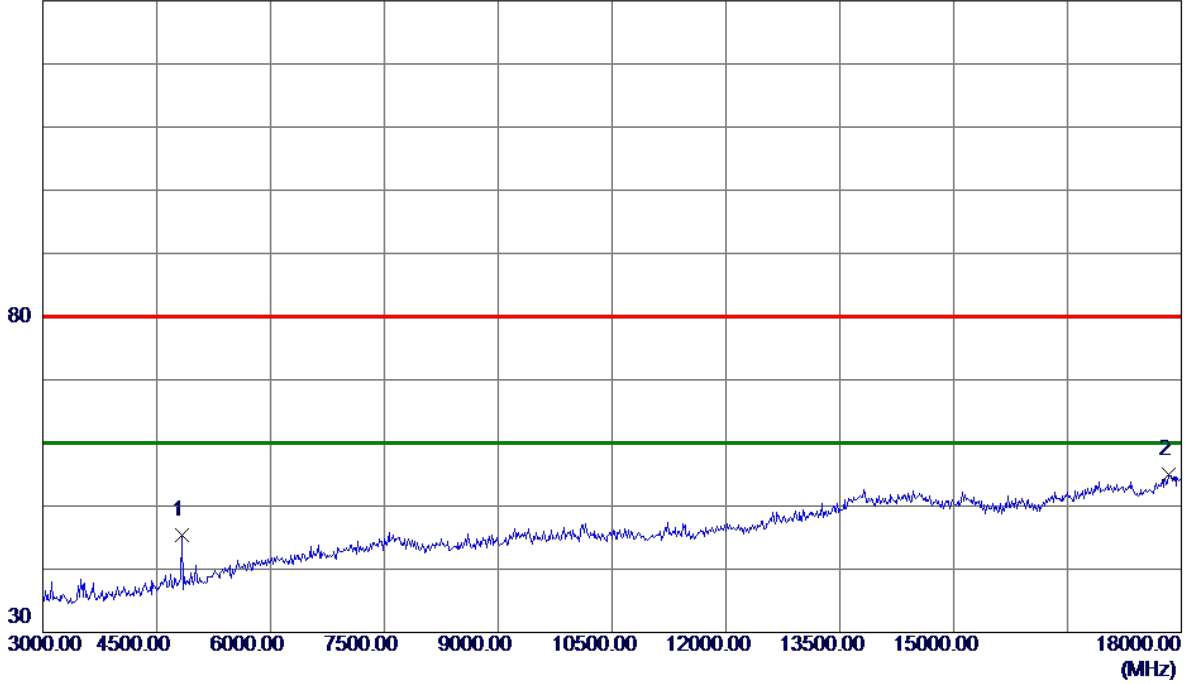

No.	Freq. MHz	Reading Level dBuV/m	Correct Factor dB	Measure ment dBuV/m	Limit dBuV/m	Margin dB	Detector	Comment
1	4830.0000	35.36	10.03	45.39	80.00	-34.61	Peak	
2 *	17835.0000	26.40	28.63	55.03	80.00	-24.97	Peak	

Orthogonal Axis :	X
Test Mode :	TX B MODE 2412MHz

**Vertical**

130 dBuV/m

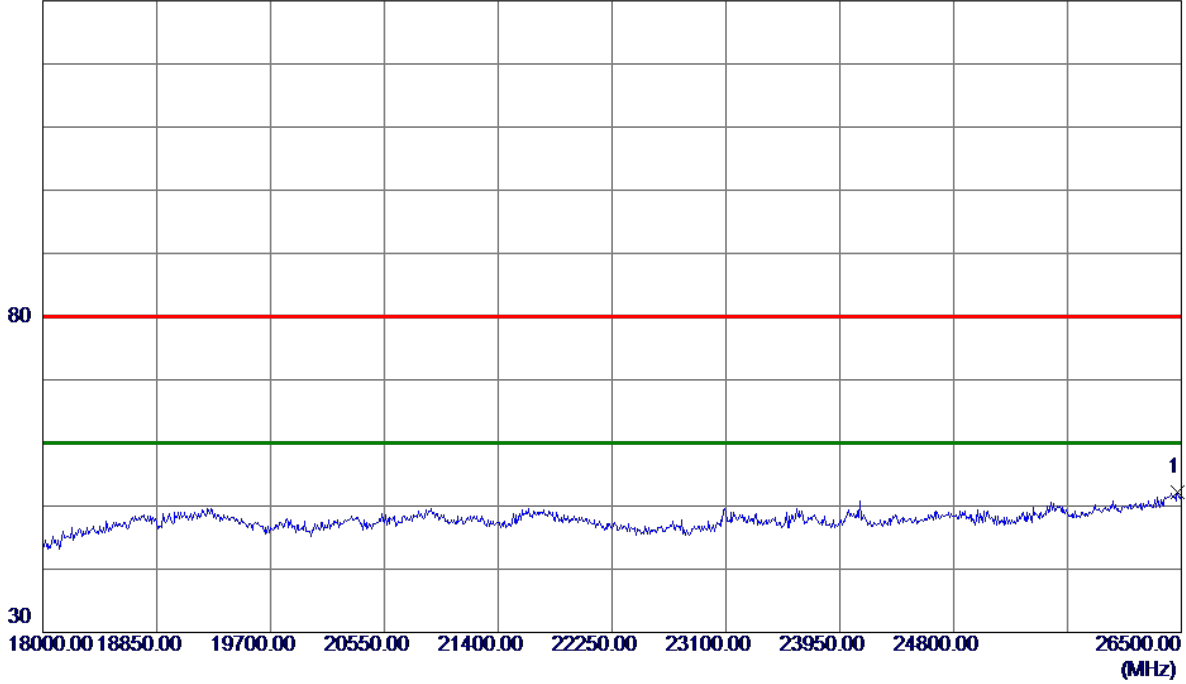

No.	Freq. MHz	Reading Level dBuV/m	Correct Factor dB	Measure ment dBuV/m	Limit dBuV/m	Margin dB	Detector	Comment
1 *	26474.5000	52.14	0.00	52.14	80.00	-27.86	Peak	

Orthogonal Axis :	X
Test Mode :	TX B MODE 2412MHz

**Horizontal**

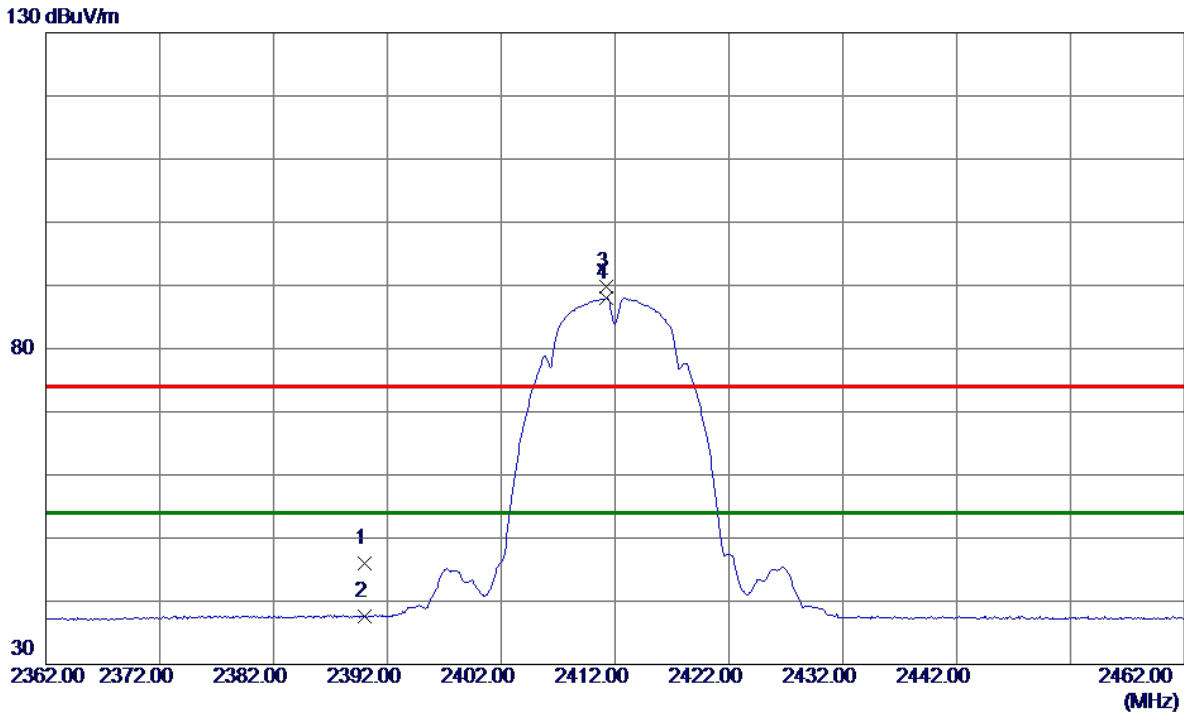

No.	Freq. MHz	Reading Level dBuV/m	Correct Factor dB	Measure ment dBuV/m	Limit dBuV/m	Margin dB	Detector	Comment
1	2390.0000	34.66	11.32	45.98	74.00	-28.02	Peak	
2	2390.0000	26.34	11.32	37.66	54.00	-16.34	AVG	
3	2411.2000	78.54	11.33	89.87	74.00	15.87	Peak	No Limit
4 *	2411.2000	76.64	11.33	87.97	54.00	33.97	AVG	No Limit

Orthogonal Axis :	X
Test Mode :	TX B MODE 2412MHz

**Horizontal**

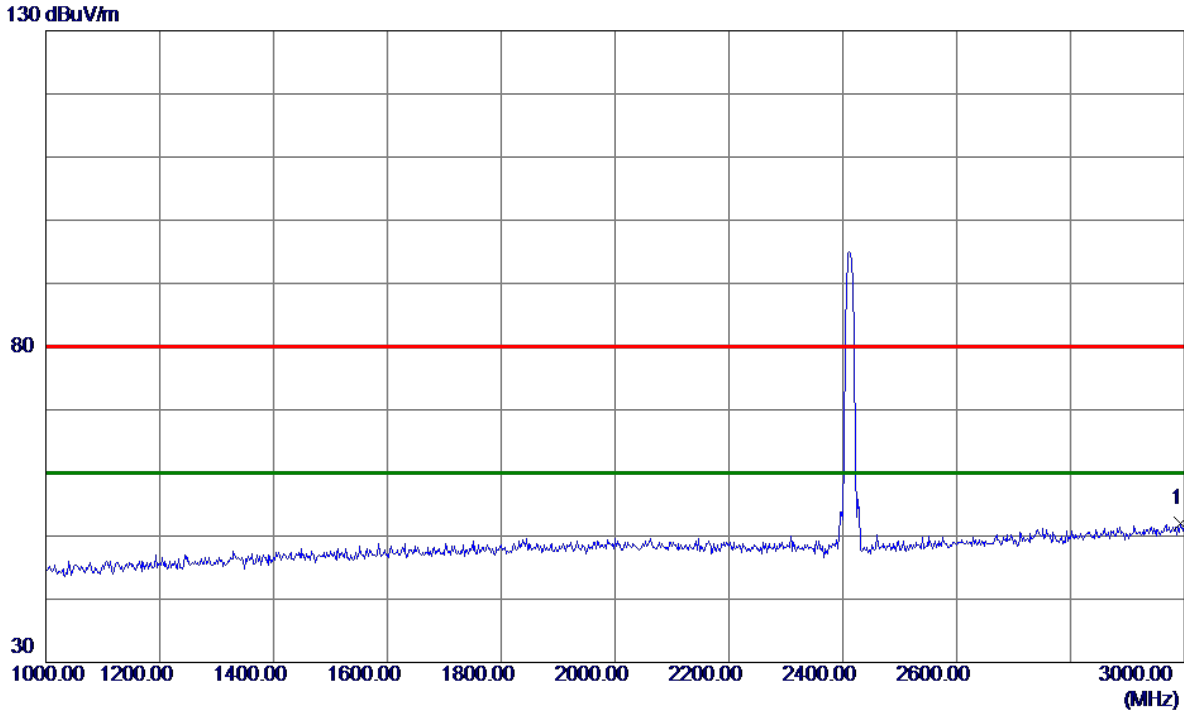

No.	Freq. MHz	Reading Level dBuV/m	Correct Factor dB	Measure ment dBuV/m	Limit dBuV/m	Margin dB	Detector	Comment
1 *	2994.0000	37.05	14.96	52.01	80.00	-27.99	Peak	



Orthogonal Axis :	X
Test Mode :	TX B MODE 2412MHz

**Horizontal**

130 dBuV/m

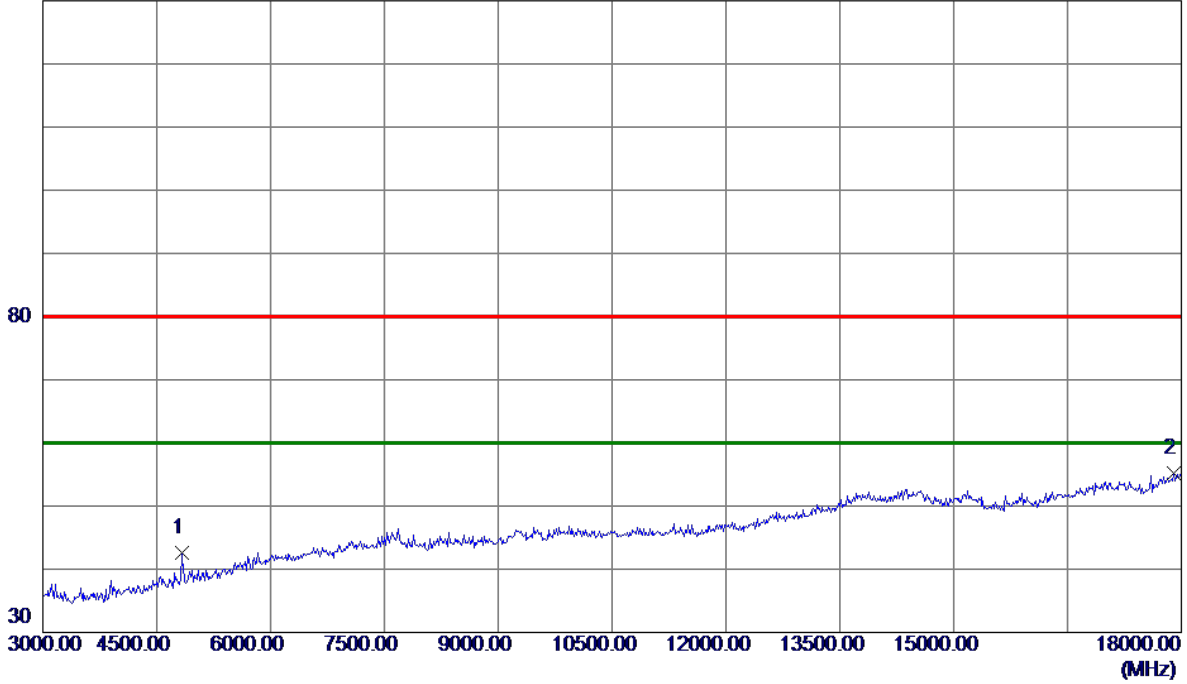

No.	Freq. MHz	Reading Level dBuV/m	Correct Factor dB	Measure ment dBuV/m	Limit dBuV/m	Margin dB	Detector	Comment
1	4830.0000	32.58	10.03	42.61	80.00	-37.39	Peak	
2 *	17895.0000	26.31	28.82	55.13	80.00	-24.87	Peak	

Orthogonal Axis :	X
Test Mode :	TX B MODE 2412MHz

**Horizontal**

130 dBuV/m

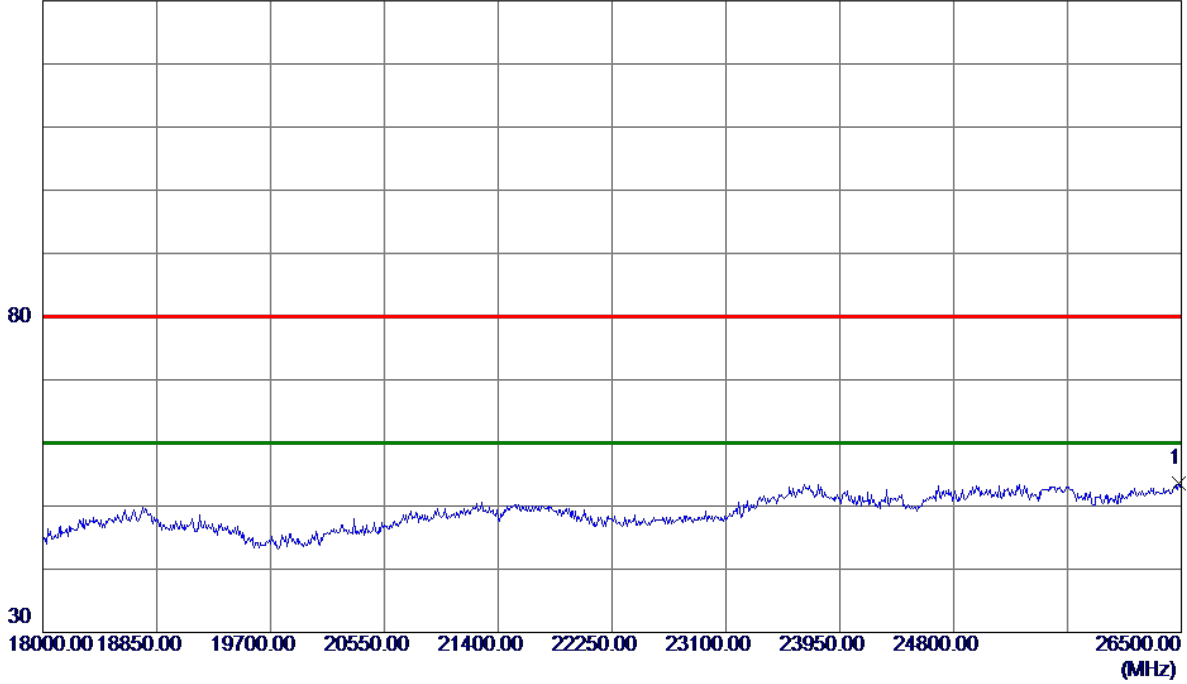

No.	Freq. MHz	Reading Level dBuV/m	Correct Factor dB	Measure ment dBuV/m	Limit dBuV/m	Margin dB	Detector	Comment
1 *	26483.0000	53.56	0.00	53.56	80.00	-26.44	Peak	

Orthogonal Axis :	X
Test Mode :	TX B MODE 2437MHz

**Vertical**

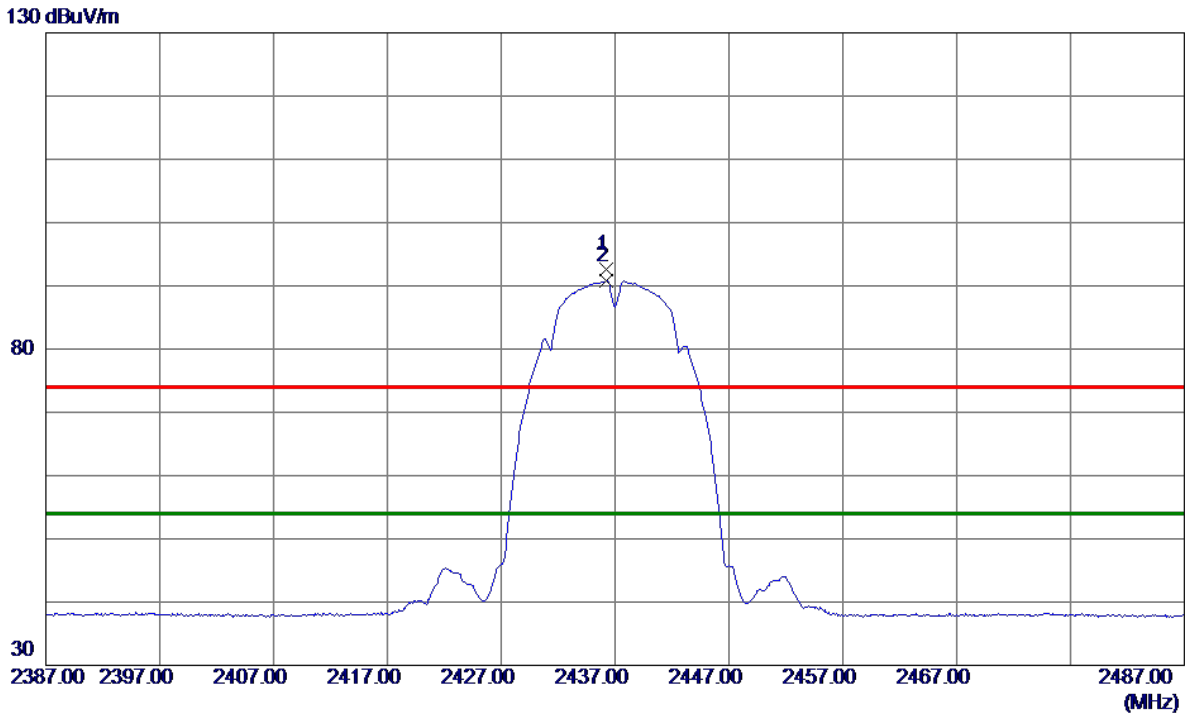

No.	Freq. MHz	Reading Level dBuV/m	Correct Factor dB	Measure ment dBuV/m	Limit dBuV/m	Margin dB	Detector	Comment
1	2436.2000	81.34	11.33	92.67	74.00	18.67	Peak	No Limit
2 *	2436.2000	79.40	11.33	90.73	54.00	36.73	AVG	No Limit

Orthogonal Axis :	X
Test Mode :	TX B MODE 2437MHz

**Vertical**

130 dBuV/m

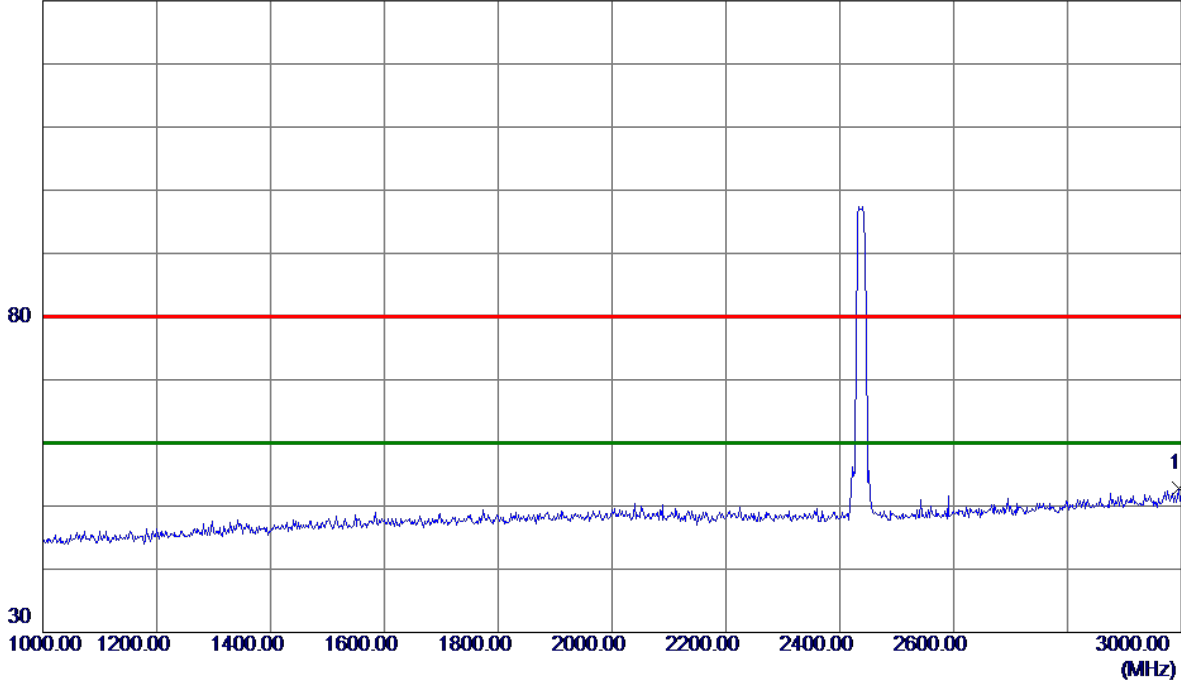

No.	Freq. MHz	Reading Level dBuV/m	Correct Factor dB	Measure ment dBuV/m	Limit dBuV/m	Margin dB	Detector	Comment
1 *	2996.0000	37.78	14.97	52.75	80.00	-27.25	Peak	

Orthogonal Axis :	X
Test Mode :	TX B MODE 2437MHz

**Vertical**

130 dBuV/m

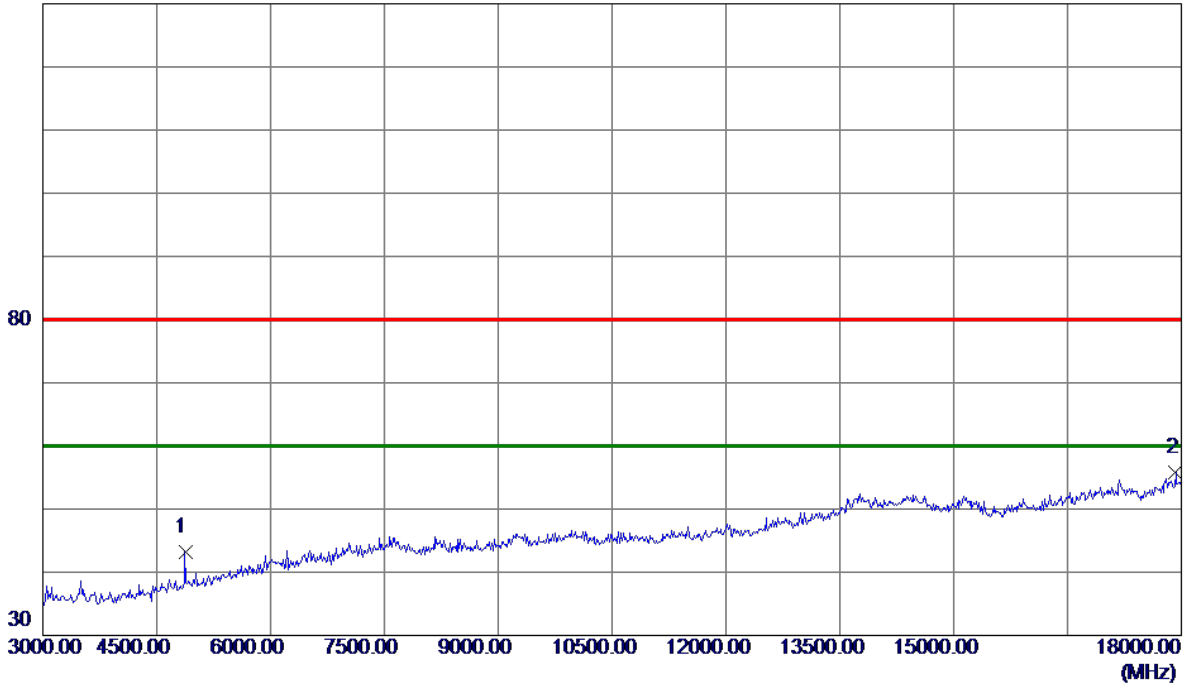

No.	Freq. MHz	Reading Level dBuV/m	Correct Factor dB	Measure ment dBuV/m	Limit dBuV/m	Margin dB	Detector	Comment
1	4875.0000	33.06	10.15	43.21	80.00	-36.79	Peak	
2 *	17925.0000	26.86	28.92	55.78	80.00	-24.22	Peak	

Orthogonal Axis :	X
Test Mode :	TX B MODE 2437MHz

**Vertical**

130 dBuV/m

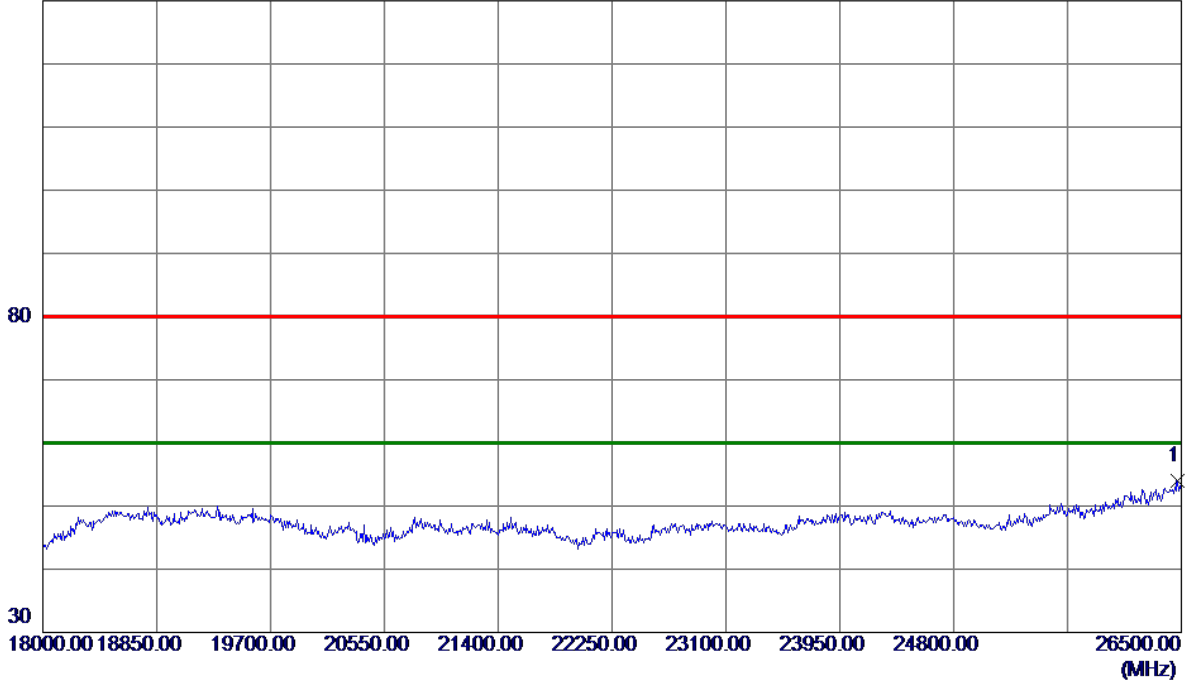

No.	Freq. MHz	Reading Level dBuV/m	Correct Factor dB	Measure ment dBuV/m	Limit dBuV/m	Margin dB	Detector	Comment
1 *	26474.5000	54.06	0.00	54.06	80.00	-25.94	Peak	

Orthogonal Axis :	X
Test Mode :	TX B MODE 2437MHz

**Horizontal**

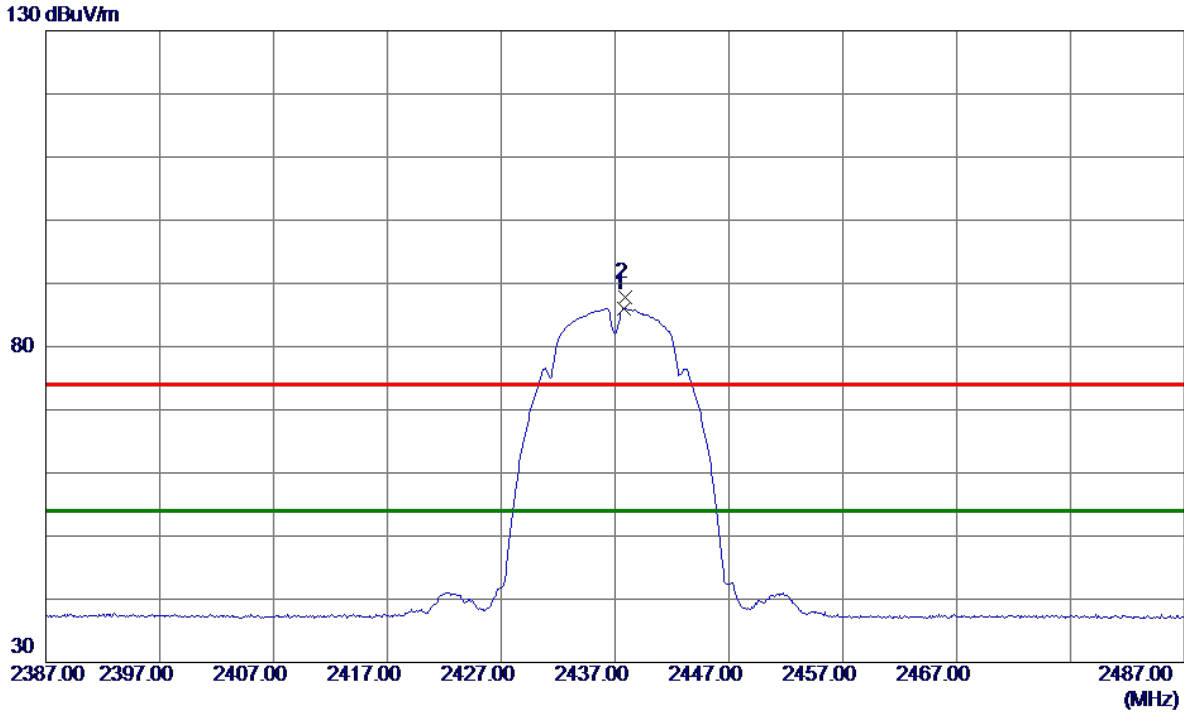

No.	Freq. MHz	Reading Level dBuV/m	Correct Factor dB	Measure ment dBuV/m	Limit dBuV/m	Margin dB	Detector	Comment
1 *	2437.8000	74.73	11.33	86.06	54.00	32.06	AVG	No Limit
2	2437.9000	76.55	11.33	87.88	74.00	13.88	Peak	No Limit

Orthogonal Axis :	X
Test Mode :	TX B MODE 2437MHz

**Horizontal**

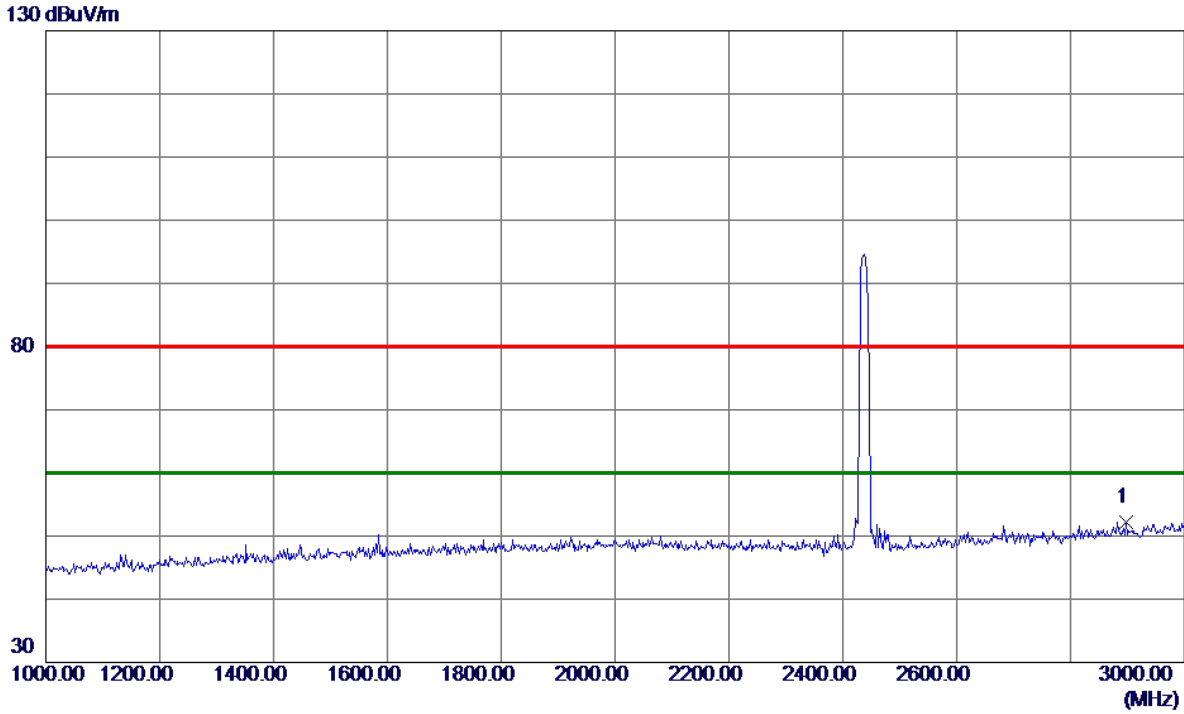

No.	Freq. MHz	Reading Level dBuV/m	Correct Factor dB	Measure ment dBuV/m	Limit dBuV/m	Margin dB	Detector	Comment
1 *	2898.0000	37.97	14.26	52.23	80.00	-27.77	Peak	



Orthogonal Axis :	X
Test Mode :	TX B MODE 2437MHz

**Horizontal**

130 dBuV/m

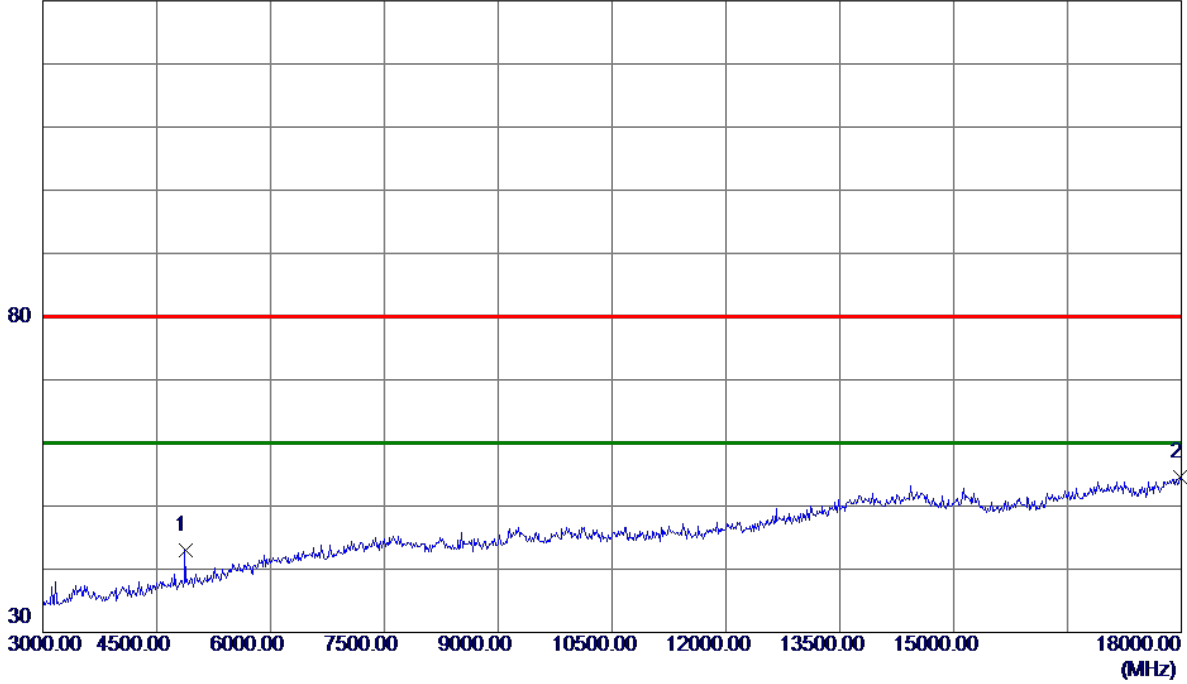

No.	Freq. MHz	Reading Level dBuV/m	Correct Factor dB	Measure ment dBuV/m	Limit dBuV/m	Margin dB	Detector	Comment
1	4875.0000	32.81	10.15	42.96	80.00	-37.04	Peak	
2 *	17985.0000	25.41	29.11	54.52	80.00	-25.48	Peak	

Orthogonal Axis :	X
Test Mode :	TX B MODE 2437MHz

### Horizontal

130 dBuV/m

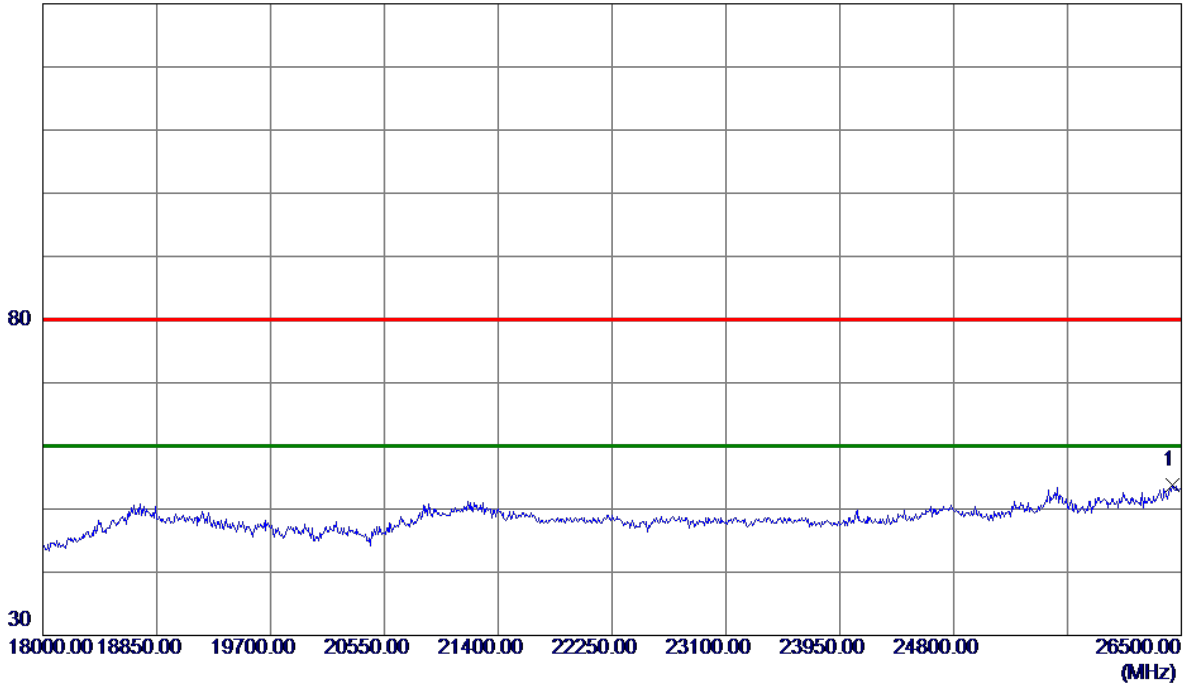

No.	Freq. MHz	Reading Level dBuV/m	Correct Factor dB	Measure ment dBuV/m	Limit dBuV/m	Margin dB	Detector	Comment
1 *	26432.0000	53.72	0.00	53.72	80.00	-26.28	Peak	

Orthogonal Axis :	X
Test Mode :	TX B MODE 2462MHz

**Vertical**

130 dBuV/m

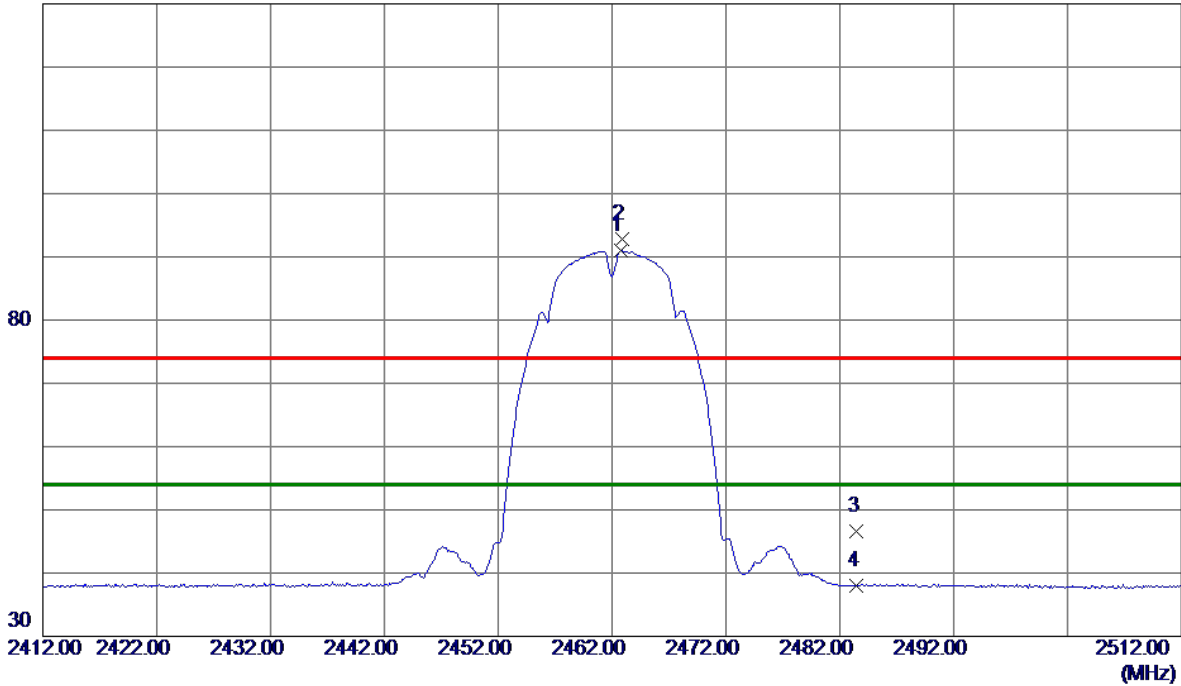

No.	Freq. MHz	Reading Level dBuV/m	Correct Factor dB	Measure ment dBuV/m	Limit dBuV/m	Margin dB	Detector	Comment
1 *	2462.8000	79.61	11.34	90.95	54.00	36.95	AVG	No Limit
2	2462.9000	81.48	11.34	92.82	74.00	18.82	Peak	No Limit
3	2483.5000	35.24	11.35	46.59	74.00	-27.41	Peak	
4	2483.5000	26.69	11.35	38.04	54.00	-15.96	AVG	

Orthogonal Axis :	X
Test Mode :	TX B MODE 2462MHz

**Vertical**

130 dBuV/m

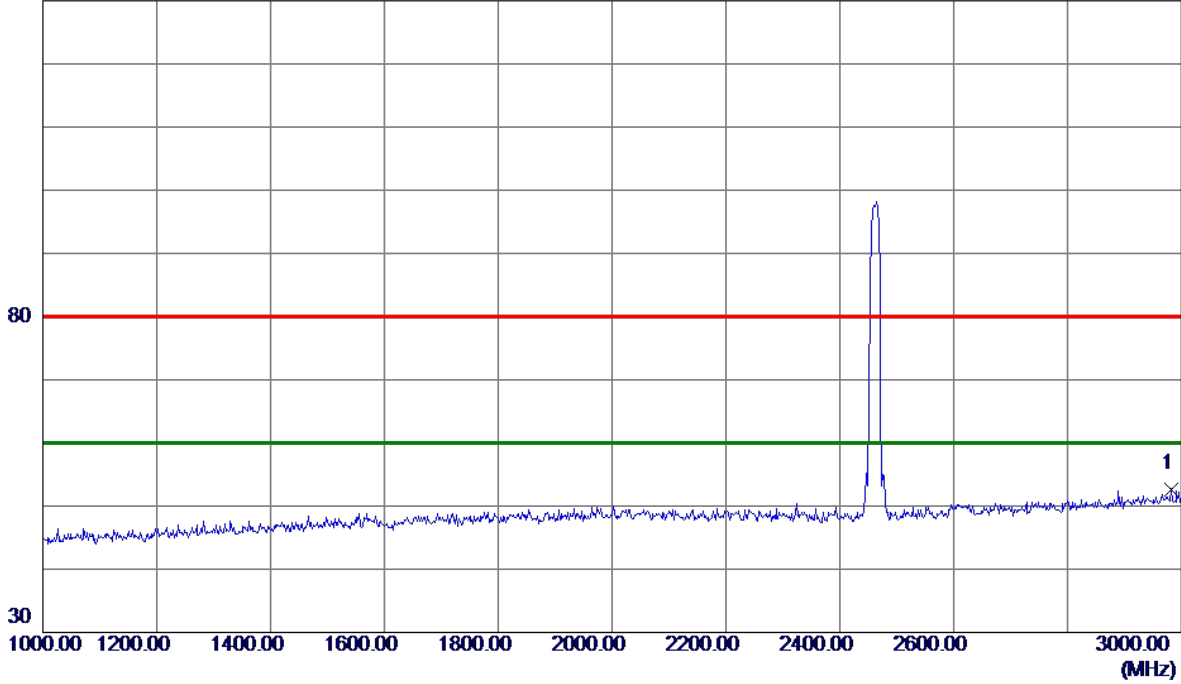

No.	Freq. MHz	Reading Level dBuV/m	Correct Factor dB	Measure ment dBuV/m	Limit dBuV/m	Margin dB	Detector	Comment
1 *	2982.0000	37.83	14.87	52.70	80.00	-27.30	Peak	

Orthogonal Axis :	X
Test Mode :	TX B MODE 2462MHz

**Vertical**

130 dBuV/m

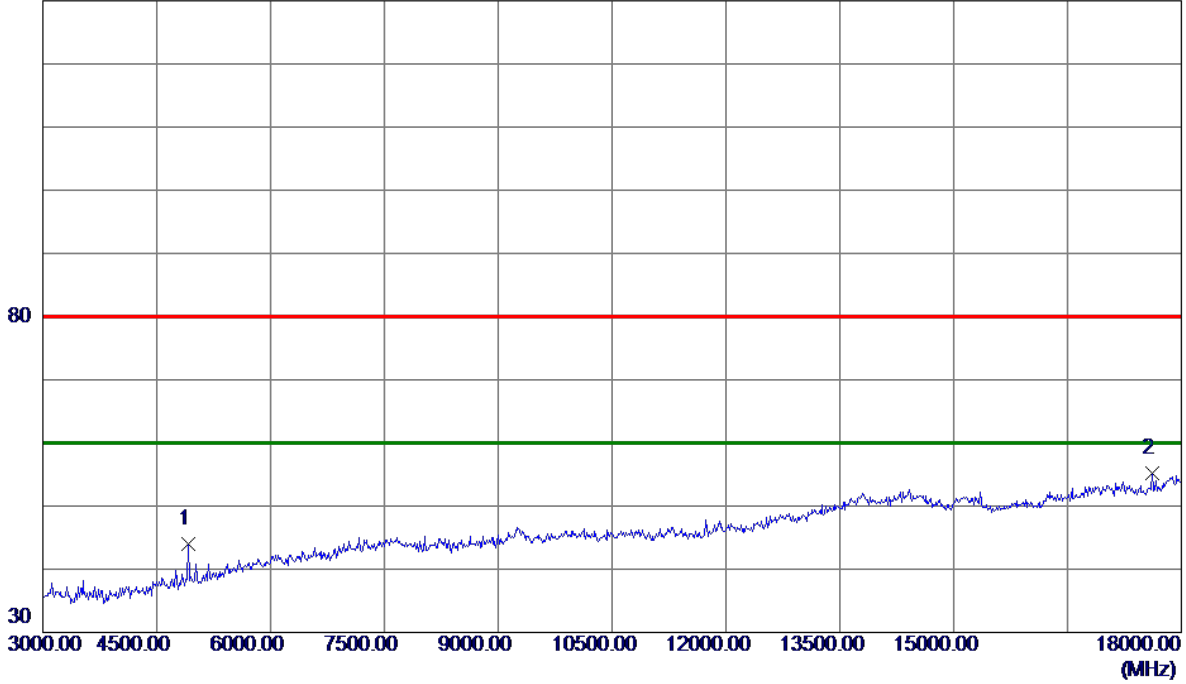

No.	Freq. MHz	Reading Level dBuV/m	Correct Factor dB	Measure ment dBuV/m	Limit dBuV/m	Margin dB	Detector	Comment
1	4920.0000	33.64	10.27	43.91	80.00	-36.09	Peak	
2 *	17610.0000	27.27	27.91	55.18	80.00	-24.82	Peak	

Orthogonal Axis :	X
Test Mode :	TX B MODE 2462MHz

**Vertical**

130 dBuV/m

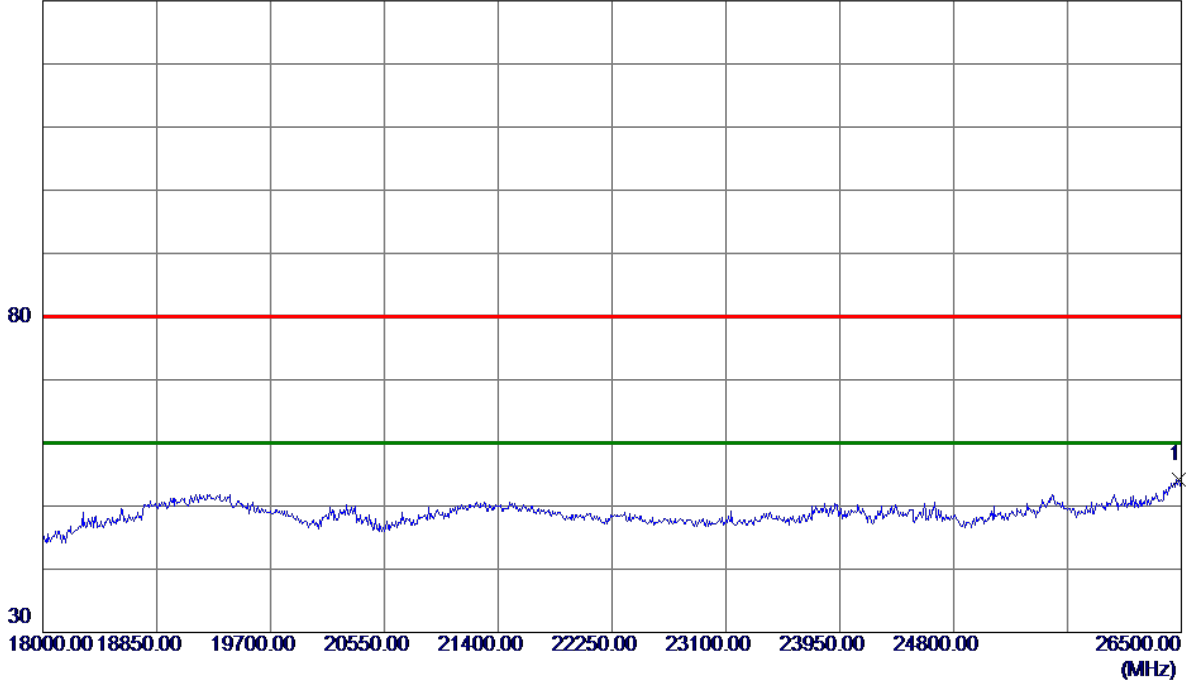

No.	Freq. MHz	Reading Level dBuV/m	Correct Factor dB	Measure ment dBuV/m	Limit dBuV/m	Margin dB	Detector	Comment
1 *	26483.0000	54.16	0.00	54.16	80.00	-25.84	Peak	

Orthogonal Axis :	X
Test Mode :	TX B MODE 2462MHz

**Horizontal**

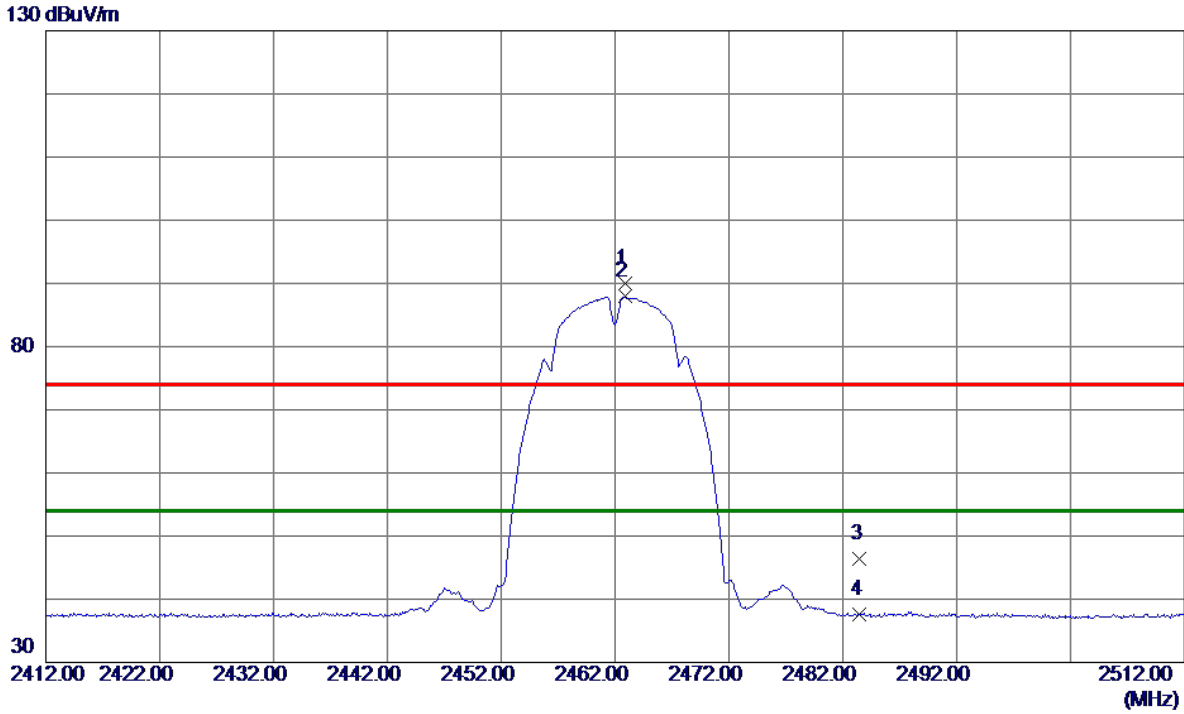

No.	Freq. MHz	Reading Level dBuV/m	Correct Factor dB	Measure ment dBuV/m	Limit dBuV/m	Margin dB	Detector	Comment
1	2462.9000	78.67	11.34	90.01	74.00	16.01	Peak	No Limit
2 *	2462.9000	76.64	11.34	87.98	54.00	33.98	AVG	No Limit
3	2483.5000	35.00	11.35	46.35	74.00	-27.65	Peak	
4	2483.5000	26.26	11.35	37.61	54.00	-16.39	AVG	

Orthogonal Axis :	X
Test Mode :	TX B MODE 2462MHz

**Horizontal**

130 dBuV/m

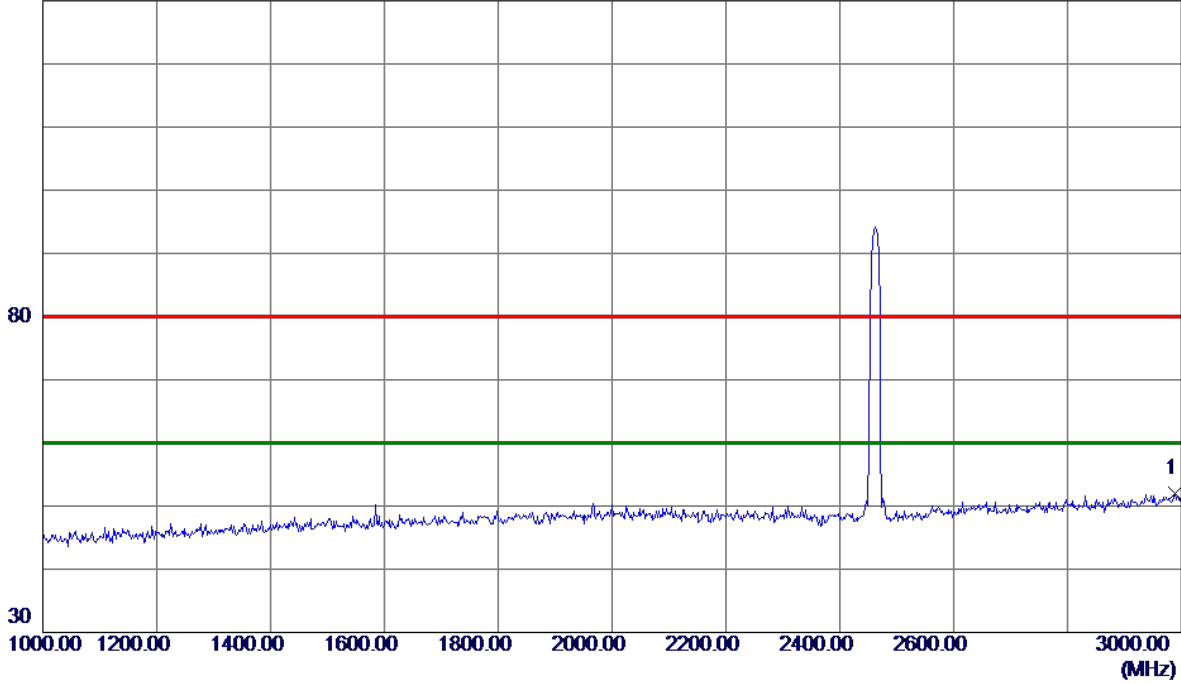

No.	Freq. MHz	Reading Level dBuV/m	Correct Factor dB	Measure ment dBuV/m	Limit dBuV/m	Margin dB	Detector	Comment
1 *	2988.0000	37.00	14.91	51.91	80.00	-28.09	Peak	



Orthogonal Axis :	X
Test Mode :	TX B MODE 2462MHz

**Horizontal**

130 dBuV/m

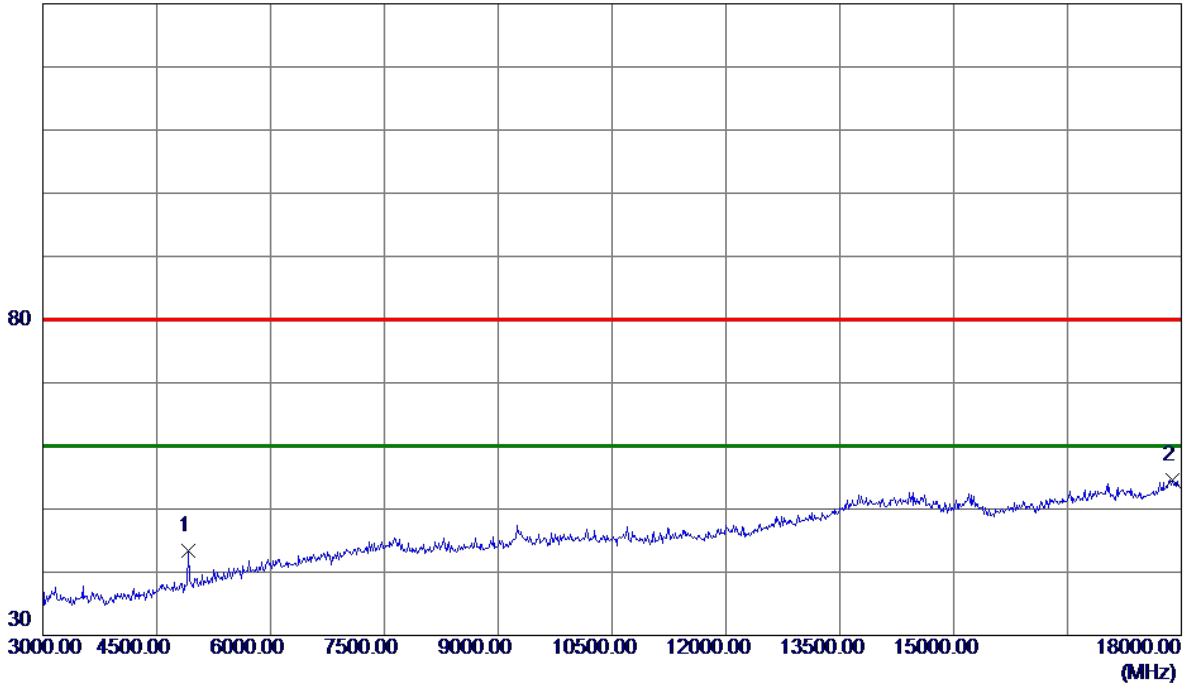

No.	Freq. MHz	Reading Level dBuV/m	Correct Factor dB	Measure ment dBuV/m	Limit dBuV/m	Margin dB	Detector	Comment
1	4920.0000	33.04	10.27	43.31	80.00	-36.69	Peak	
2 *	17880.0000	25.91	28.77	54.68	80.00	-25.32	Peak	

Orthogonal Axis :	X
Test Mode :	TX B MODE 2462MHz

**Horizontal**

130 dBuV/m

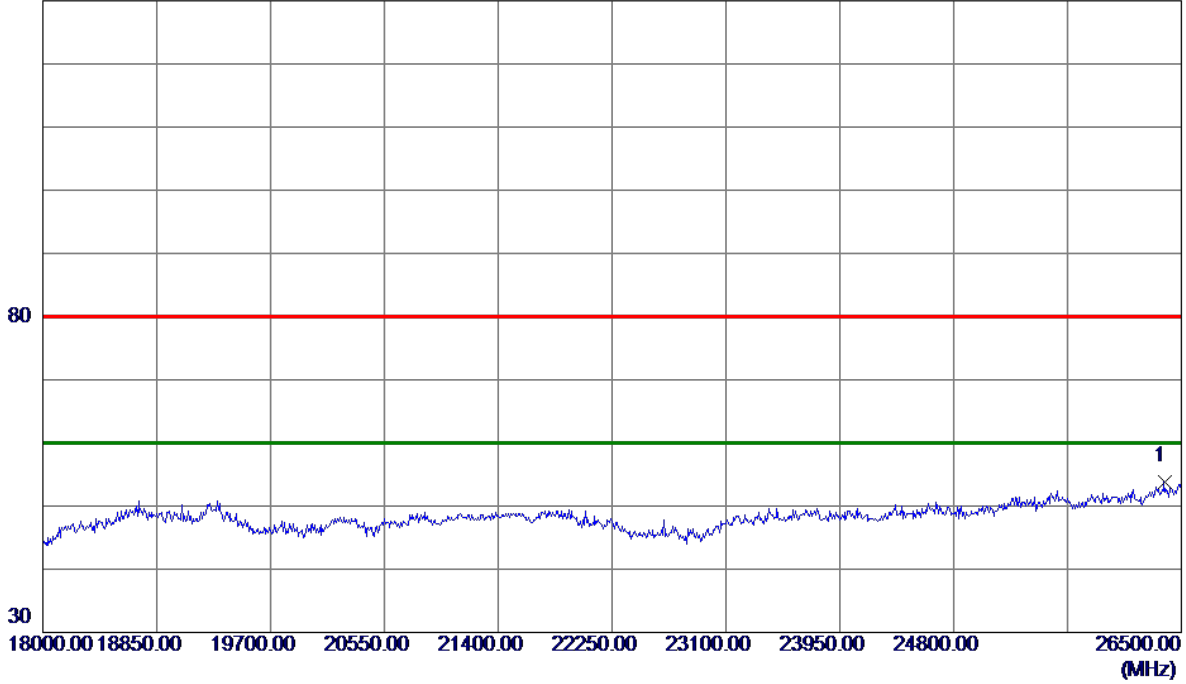

No.	Freq. MHz	Reading Level dBuV/m	Correct Factor dB	Measure ment dBuV/m	Limit dBuV/m	Margin dB	Detector	Comment
1 *	26372.5000	53.90	0.00	53.90	80.00	-26.10	Peak	

Orthogonal Axis :	X
Test Mode :	TX G MODE 2412MHz

**Vertical**

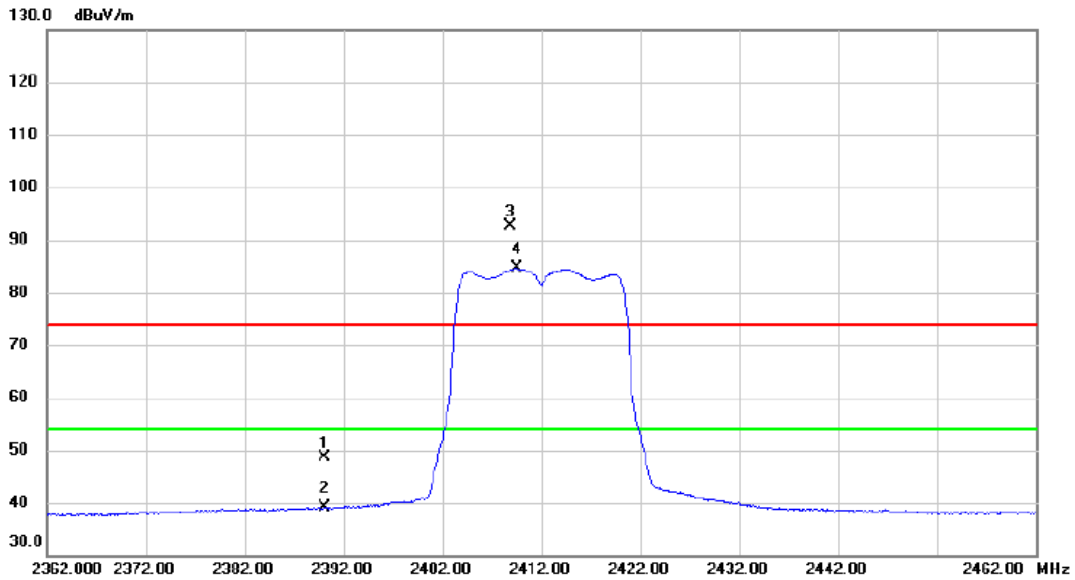

No.	Mk.	Freq. MHz	Reading Level dBuV	Correct Factor dB	Measure- ment dBuV/m	Limit dBuV/m	Margin dB	Detector	Comment
1		2390.000	37.35	11.31	48.66	74.00	-25.34	peak	
2		2390.000	27.70	11.31	39.01	54.00	-14.99	AVG	
3	X	2408.800	81.32	11.33	92.65	74.00	18.65	peak	No Limit
4	*	2409.600	73.25	11.33	84.58	54.00	30.58	AVG	No Limit

Orthogonal Axis :	X
Test Mode :	TX G MODE 2412MHz

**Vertical**

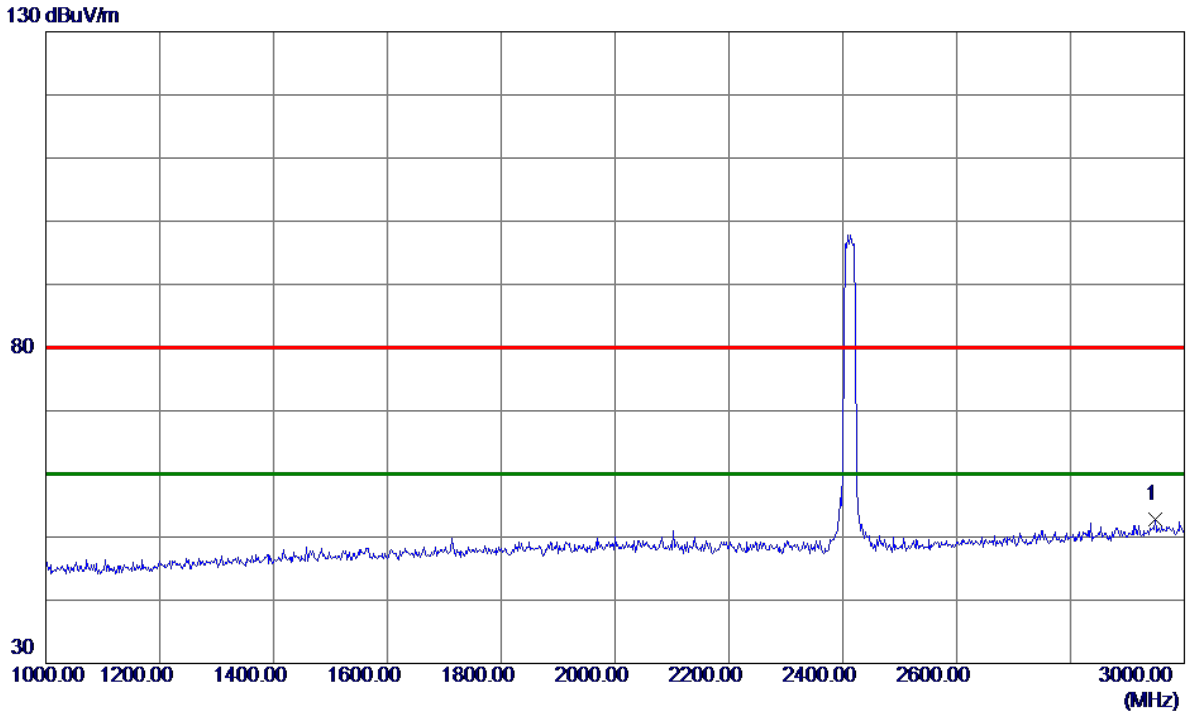

No.	Freq. MHz	Reading Level dBuV/m	Correct Factor dB	Measure ment dBuV/m	Limit dBuV/m	Margin dB	Detector	Comment
1 *	2948.0000	38.25	14.62	52.87	80.00	-27.13	Peak	

Orthogonal Axis :	X
Test Mode :	TX G MODE 2412MHz

**Vertical**

130 dBuV/m

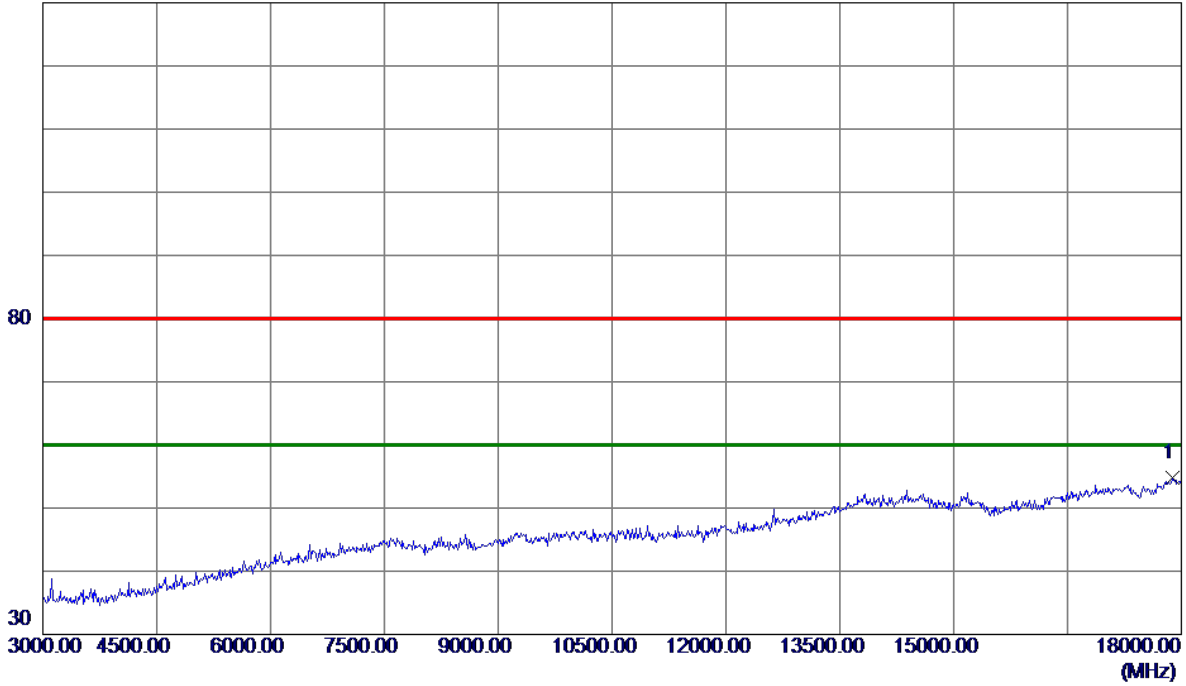

No.	Freq. MHz	Reading Level dBuV/m	Correct Factor dB	Measure ment dBuV/m	Limit dBuV/m	Margin dB	Detector	Comment
1 *	17880.0000	26.11	28.77	54.88	80.00	-25.12	Peak	

Orthogonal Axis :	X
Test Mode :	TX G MODE 2412MHz

**Vertical**

130 dBuV/m

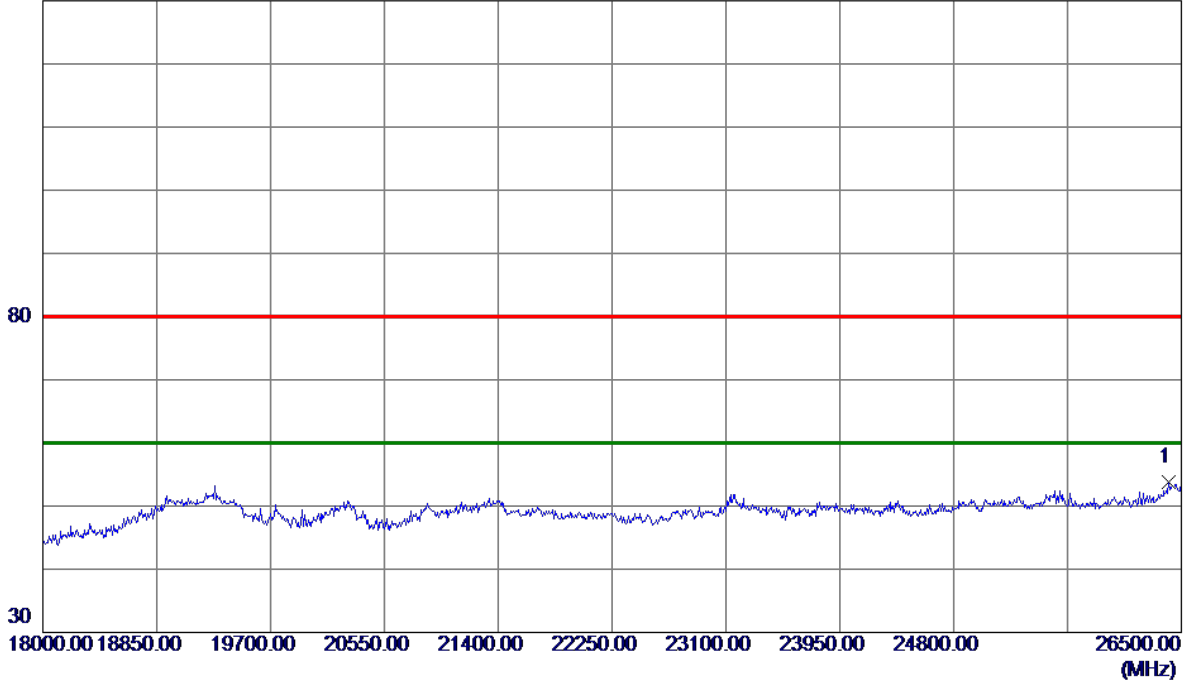

No.	Freq. MHz	Reading Level dBuV/m	Correct Factor dB	Measure ment dBuV/m	Limit dBuV/m	Margin dB	Detector	Comment
1 *	26406.5000	53.81	0.00	53.81	80.00	-26.19	Peak	

Orthogonal Axis :	X
Test Mode :	TX G MODE 2412MHz

**Horizontal**

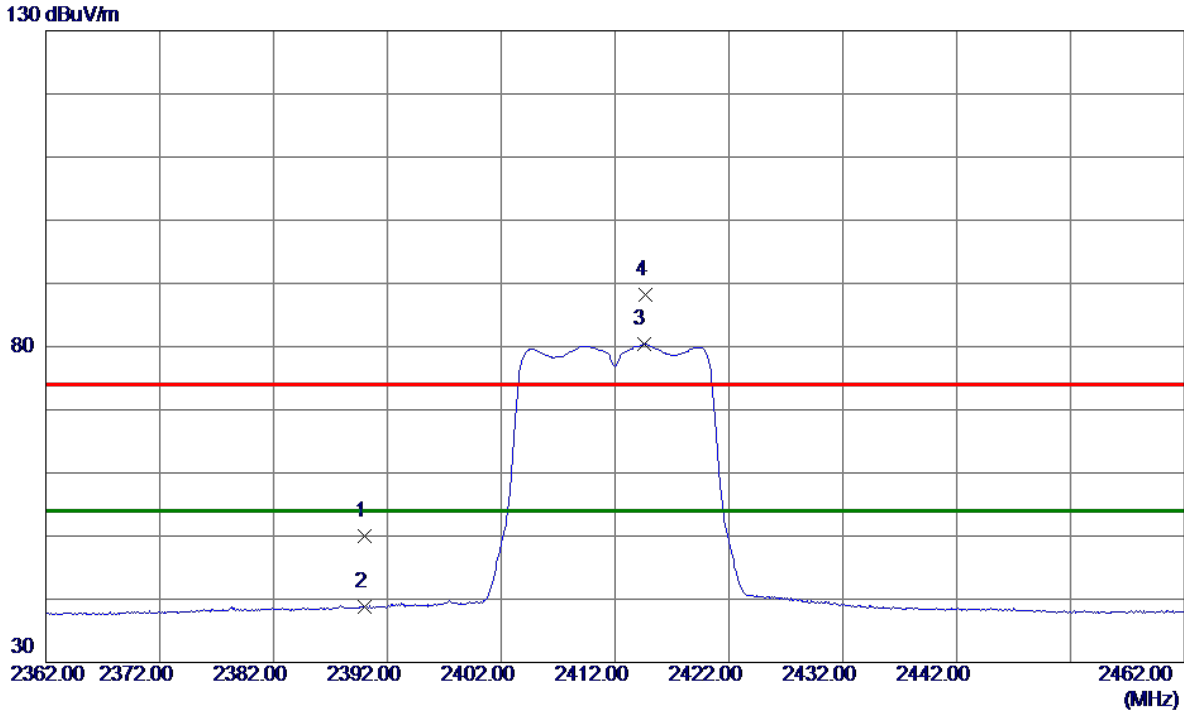

No.	Freq. MHz	Reading Level dBuV/m	Correct Factor dB	Measure ment dBuV/m	Limit dBuV/m	Margin dB	Detector	Comment
1	2390.0000	38.66	11.32	49.98	74.00	-24.02	Peak	
2	2390.0000	27.46	11.32	38.78	54.00	-15.22	AVG	
3 *	2414.5000	69.01	11.33	80.34	54.00	26.34	AVG	No Limit
4	2414.7000	76.91	11.33	88.24	74.00	14.24	Peak	No Limit

Orthogonal Axis :	X
Test Mode :	TX G MODE 2412MHz

**Horizontal**

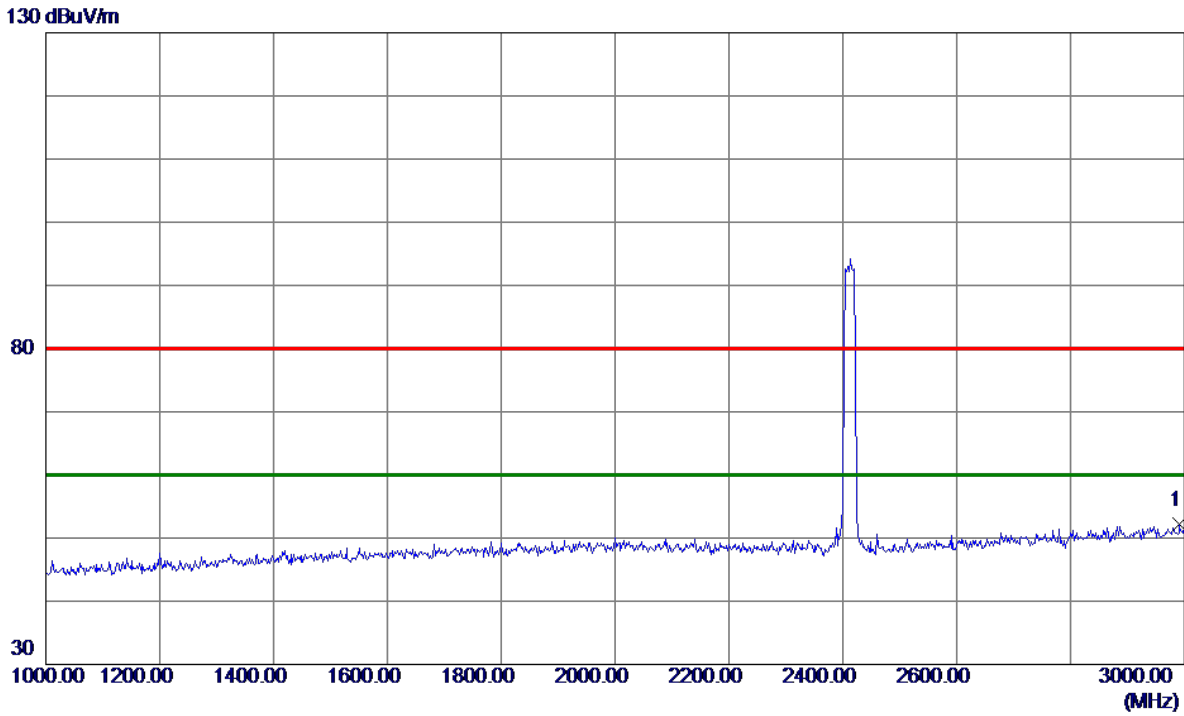

No.	Freq. MHz	Reading Level dBuV/m	Correct Factor dB	Measure ment dBuV/m	Limit dBuV/m	Margin dB	Detector	Comment
1 *	2992.0000	37.16	14.94	52.10	80.00	-27.90	Peak	



Orthogonal Axis :	X
Test Mode :	TX G MODE 2412MHz

**Horizontal**

130 dBuV/m

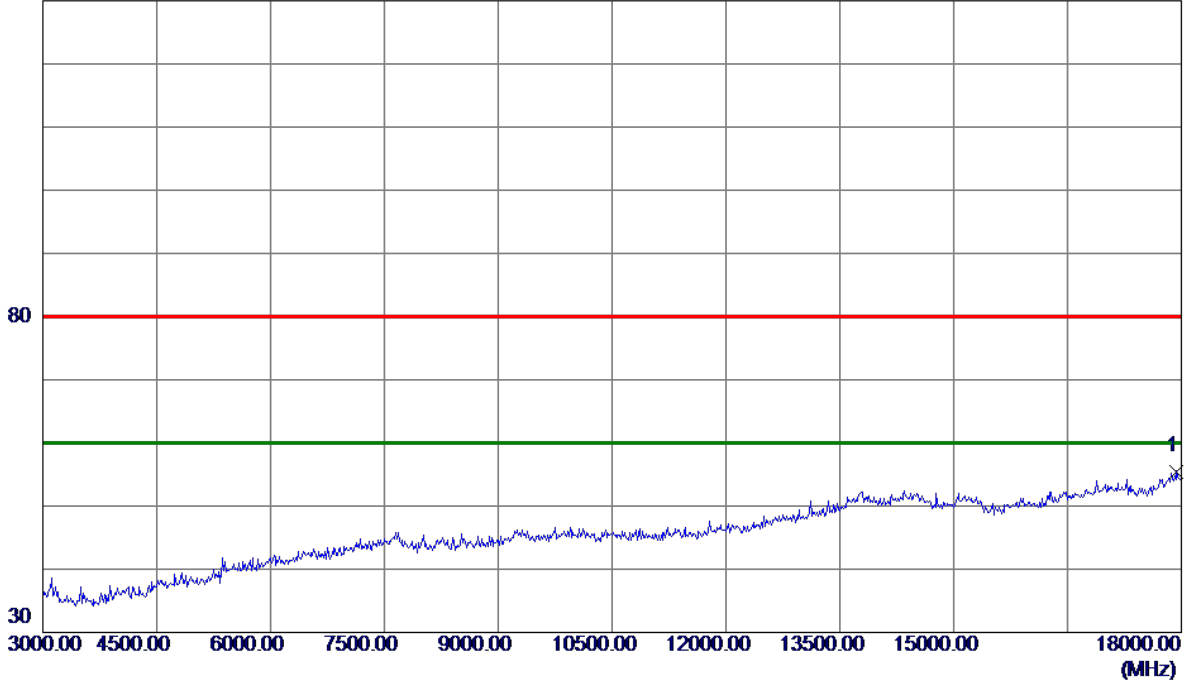

No.	Freq. MHz	Reading Level dBuV/m	Correct Factor dB	Measure ment dBuV/m	Limit dBuV/m	Margin dB	Detector	Comment
1 *	17940.0000	26.53	28.97	55.50	80.00	-24.50	Peak	

Orthogonal Axis :	X
Test Mode :	TX G MODE 2412MHz

**Horizontal**

130 dBuV/m

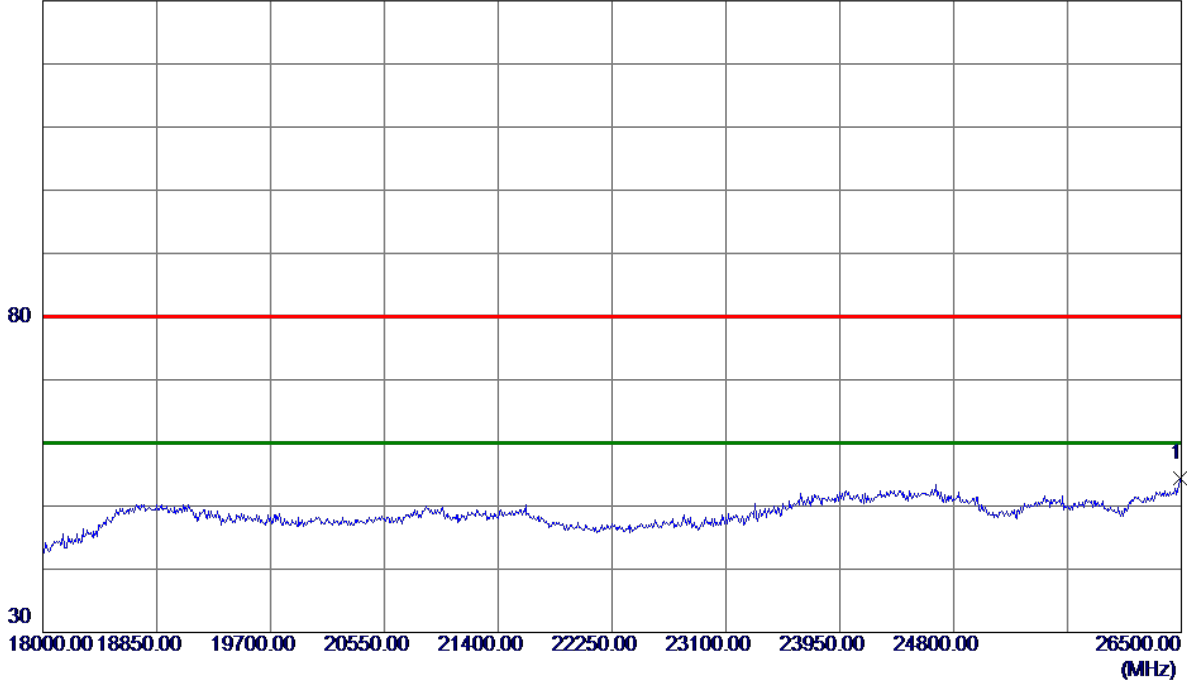

No.	Freq. MHz	Reading Level dBuV/m	Correct Factor dB	Measure ment dBuV/m	Limit dBuV/m	Margin dB	Detector	Comment
1 *	26491.5000	54.42	0.00	54.42	80.00	-25.58	Peak	

Orthogonal Axis :	X
Test Mode :	TX G MODE 2437MHz

**Vertical**

130 dBuV/m

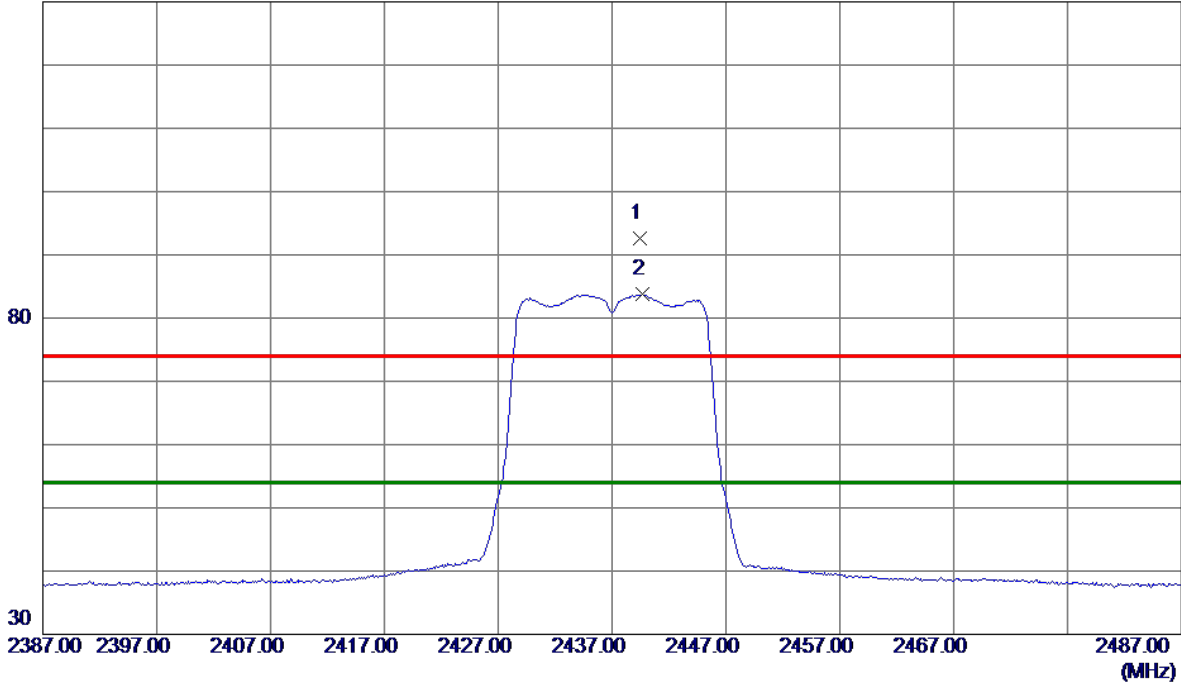

No.	Freq. MHz	Reading Level dBuV/m	Correct Factor dB	Measure ment dBuV/m	Limit dBuV/m	Margin dB	Detector	Comment
1	2439.4000	81.20	11.33	92.53	74.00	18.53	Peak	No Limit
2 *	2439.7000	72.40	11.33	83.73	54.00	29.73	AVG	No Limit

Orthogonal Axis :	X
Test Mode :	TX G MODE 2437MHz

**Vertical**

130 dBuV/m

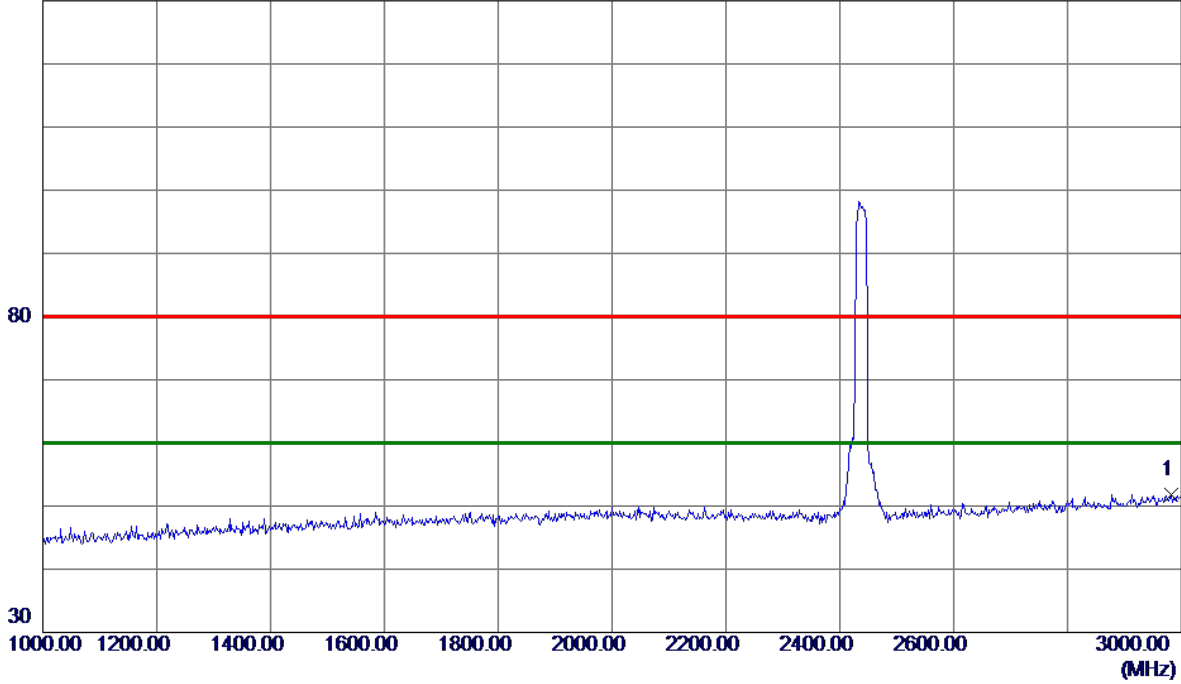

No.	Freq. MHz	Reading Level dBuV/m	Correct Factor dB	Measure ment dBuV/m	Limit dBuV/m	Margin dB	Detector	Comment
1 *	2982.0000	36.96	14.87	51.83	80.00	-28.17	Peak	

Orthogonal Axis :	X
Test Mode :	TX G MODE 2437MHz

**Vertical**

130 dBuV/m

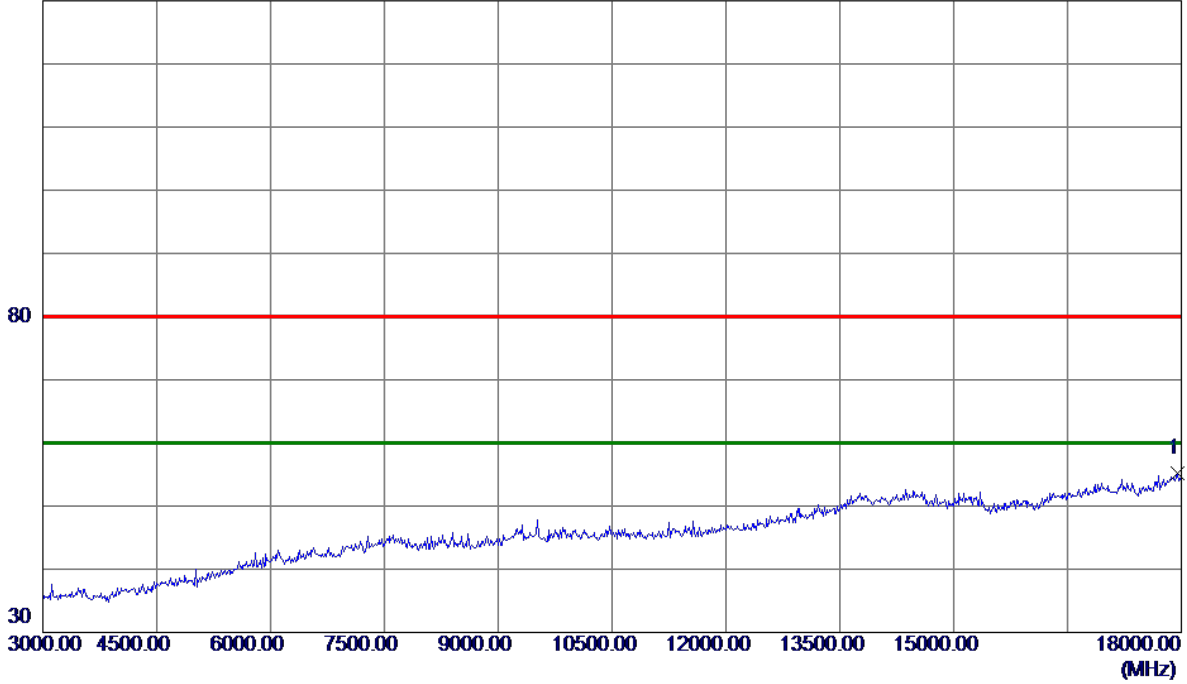

No.	Freq. MHz	Reading Level dBuV/m	Correct Factor dB	Measure ment dBuV/m	Limit dBuV/m	Margin dB	Detector	Comment
1 *	17955.0000	26.15	29.02	55.17	80.00	-24.83	Peak	

Orthogonal Axis :	X
Test Mode :	TX G MODE 2437MHz

**Vertical**

130 dBuV/m

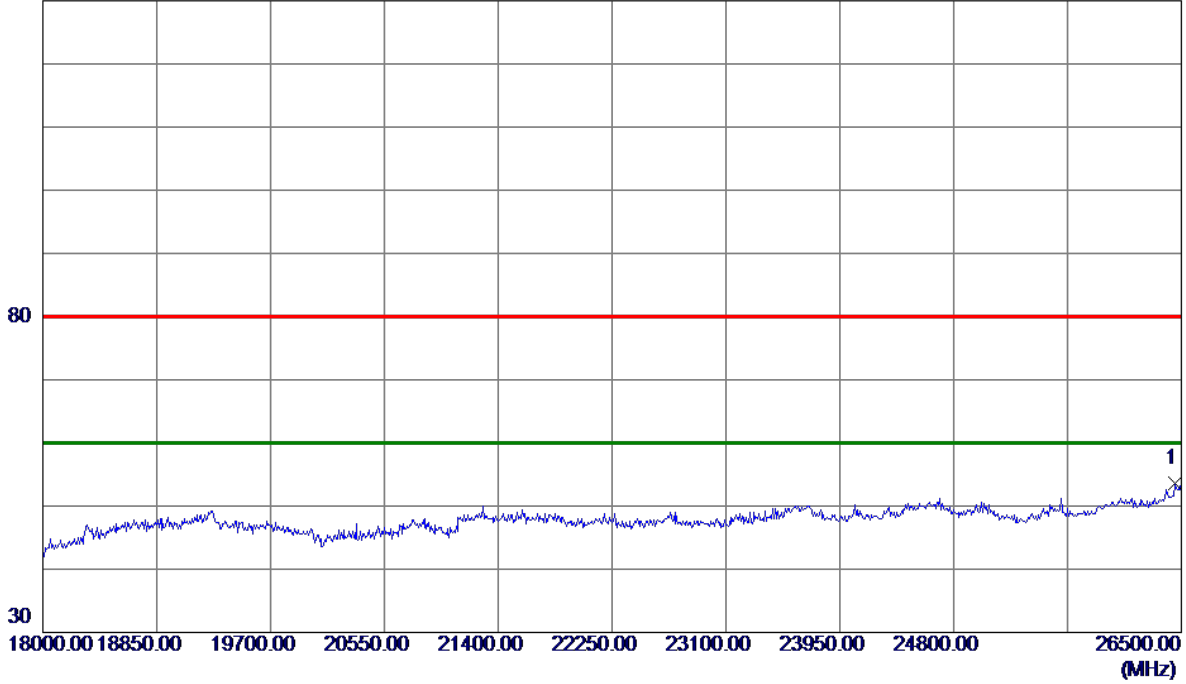

No.	Freq. MHz	Reading Level dBuV/m	Correct Factor dB	Measure ment dBuV/m	Limit dBuV/m	Margin dB	Detector	Comment
1 *	26449.0000	53.55	0.00	53.55	80.00	-26.45	Peak	

Orthogonal Axis :	X
Test Mode :	TX G MODE 2437MHz

**Horizontal**

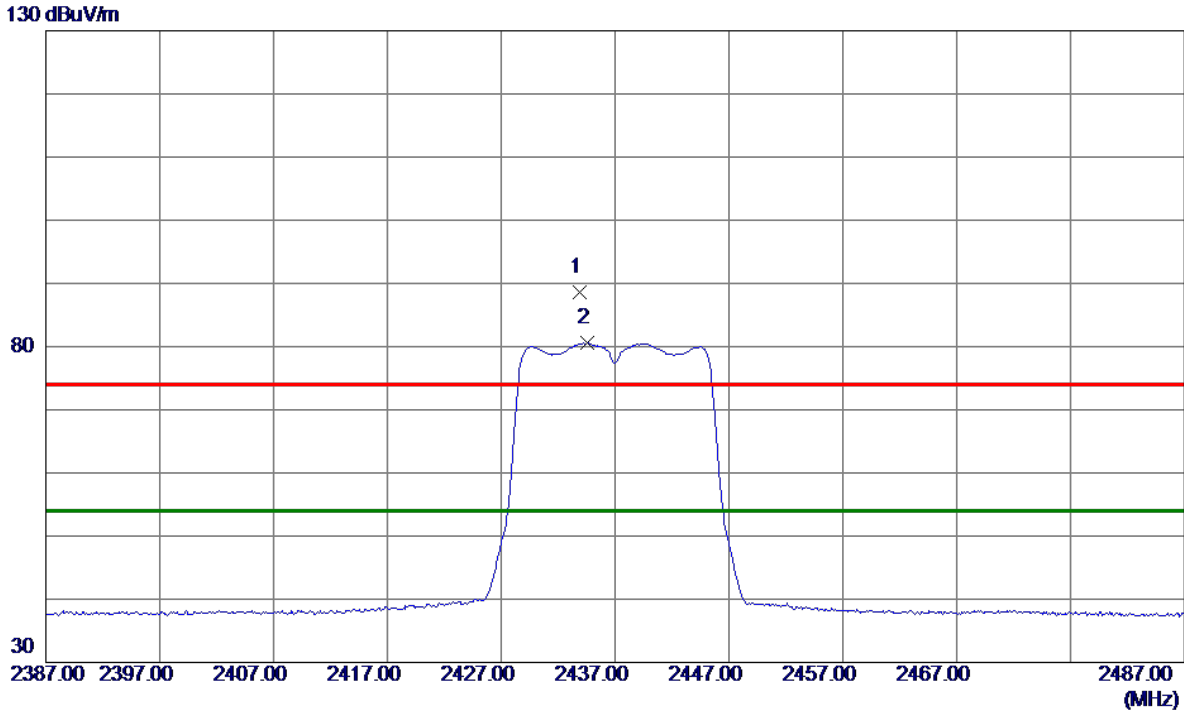

No.	Freq. MHz	Reading Level dBuV/m	Correct Factor dB	Measure ment dBuV/m	Limit dBuV/m	Margin dB	Detector	Comment
1	2433.9000	77.24	11.33	88.57	74.00	14.57	Peak	No Limit
2 *	2434.6000	69.25	11.33	80.58	54.00	26.58	AVG	No Limit

Orthogonal Axis :	X
Test Mode :	TX G MODE 2437MHz

**Horizontal**

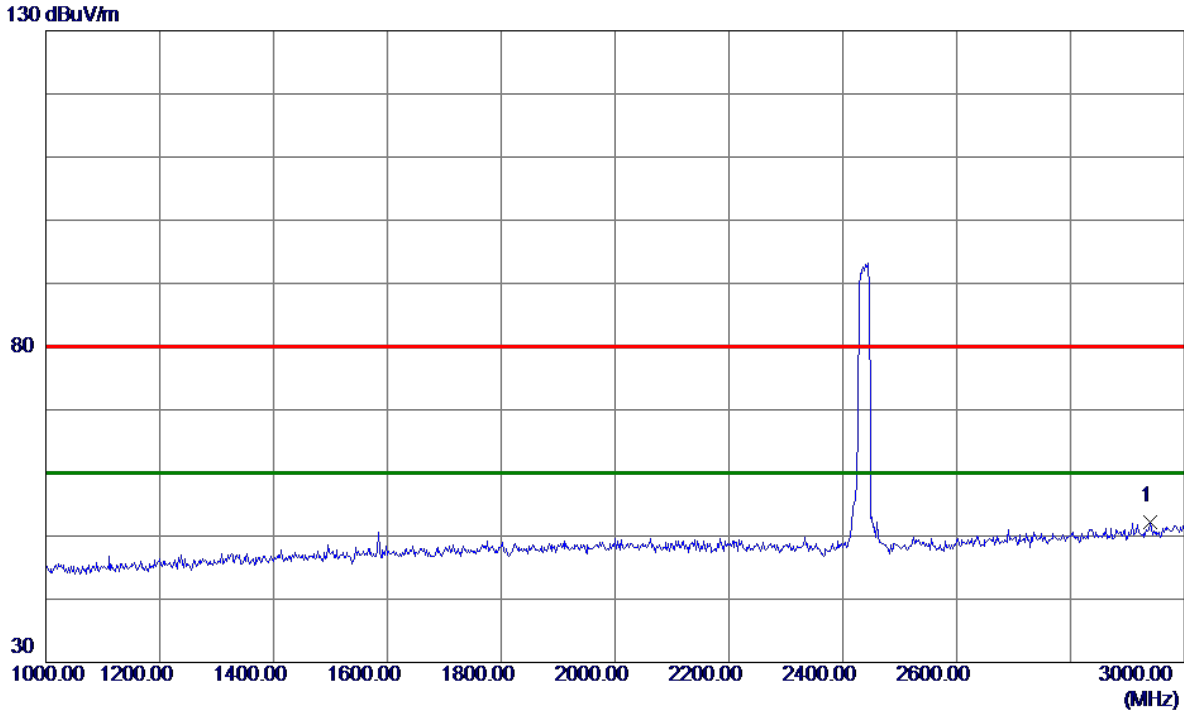

No.	Freq. MHz	Reading Level dBuV/m	Correct Factor dB	Measure ment dBuV/m	Limit dBuV/m	Margin dB	Detector	Comment
1 *	2940.0000	37.74	14.56	52.30	80.00	-27.70	Peak	



Orthogonal Axis :	X
Test Mode :	TX G MODE 2437MHz

**Horizontal**

130 dBuV/m

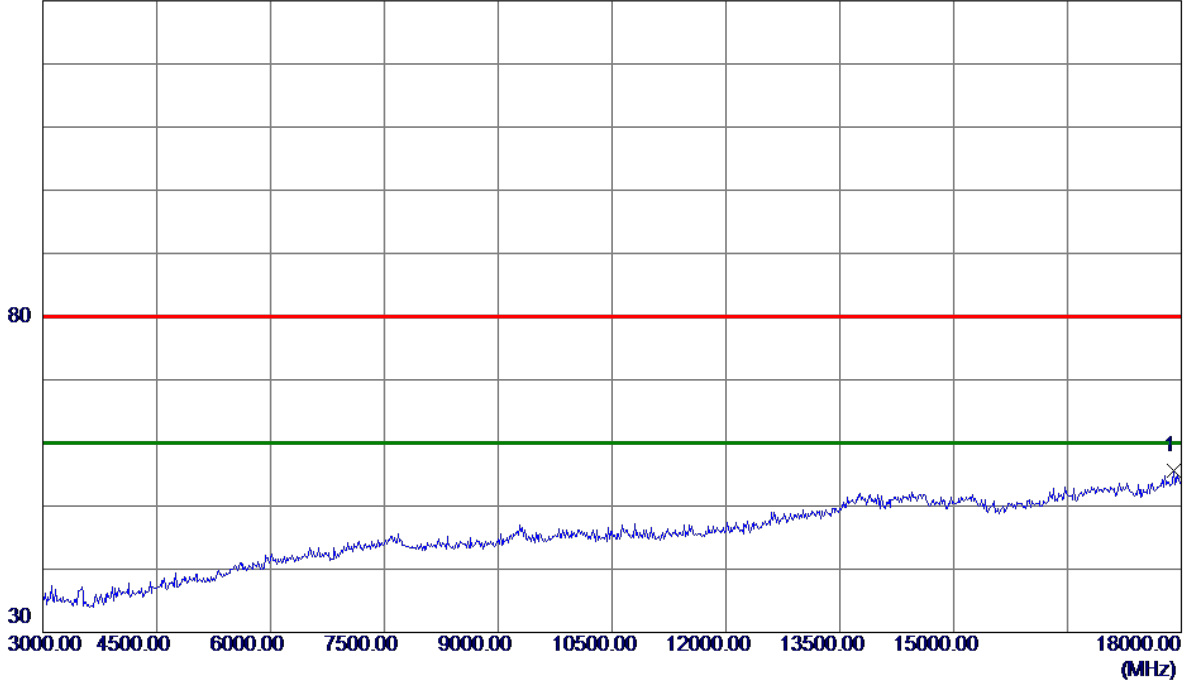

No.	Freq. MHz	Reading Level dBuV/m	Correct Factor dB	Measure ment dBuV/m	Limit dBuV/m	Margin dB	Detector	Comment
1 *	17895.0000	26.84	28.82	55.66	80.00	-24.34	Peak	

Orthogonal Axis :	X
Test Mode :	TX G MODE 2437MHz

**Horizontal**

130 dBuV/m

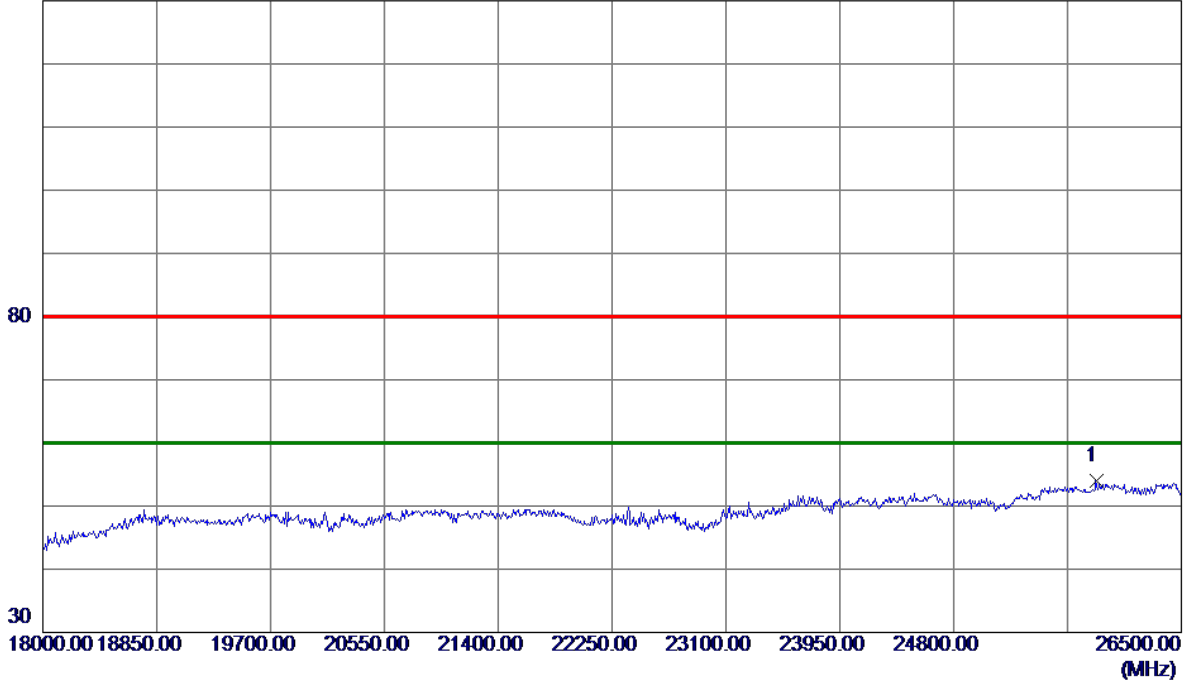

No.	Freq. MHz	Reading Level dBuV/m	Correct Factor dB	Measure ment dBuV/m	Limit dBuV/m	Margin dB	Detector	Comment
1 *	25862.5000	87.06	-33.10	53.96	80.00	-26.04	Peak	

Orthogonal Axis :	X
Test Mode :	TX G MODE 2462MHz

**Vertical**

130 dBuV/m

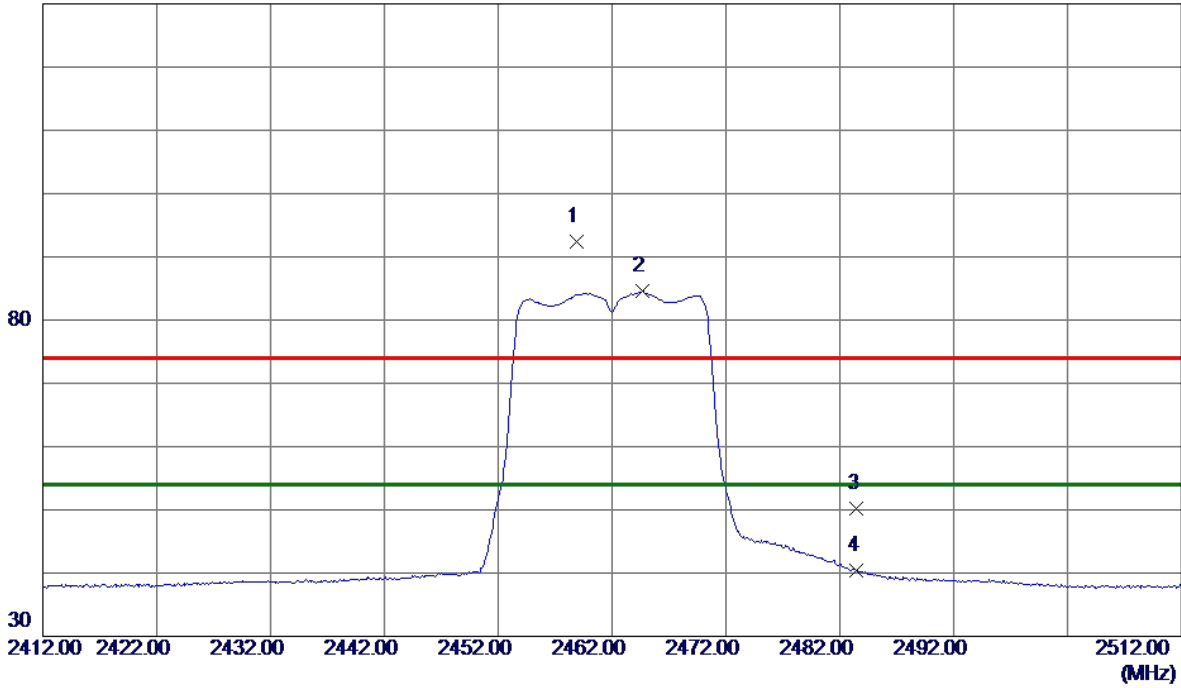

No.	Freq. MHz	Reading Level dBuV/m	Correct Factor dB	Measure ment dBuV/m	Limit dBuV/m	Margin dB	Detector	Comment
1	2458.9000	80.99	11.34	92.33	74.00	18.33	Peak	No Limit
2 *	2464.7000	73.18	11.34	84.52	54.00	30.52	AVG	No Limit
3	2483.5000	38.94	11.35	50.29	74.00	-23.71	Peak	
4	2483.5000	29.08	11.35	40.43	54.00	-13.57	AVG	

Orthogonal Axis :	X
Test Mode :	TX G MODE 2462MHz

**Vertical**

130 dBuV/m

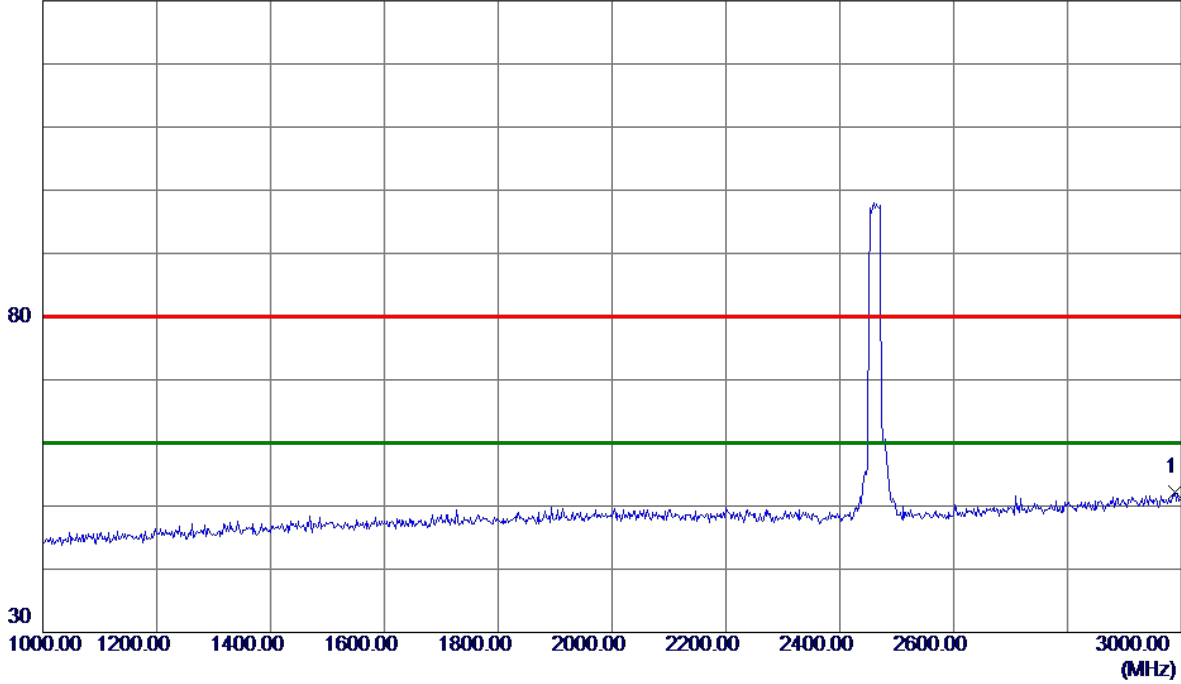

No.	Freq. MHz	Reading Level dBuV/m	Correct Factor dB	Measure ment dBuV/m	Limit dBuV/m	Margin dB	Detector	Comment
1 *	2988.0000	37.20	14.91	52.11	80.00	-27.89	Peak	

Orthogonal Axis :	X
Test Mode :	TX G MODE 2462MHz

**Vertical**

130 dBuV/m

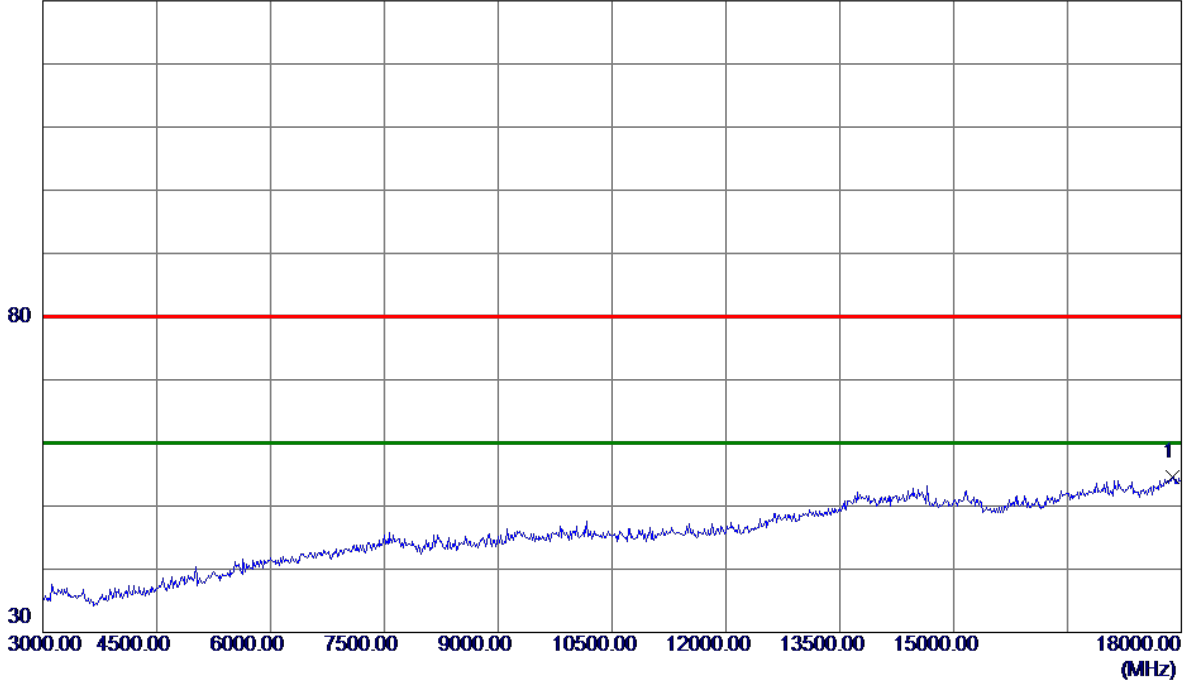

No.	Freq. MHz	Reading Level dBuV/m	Correct Factor dB	Measure ment dBuV/m	Limit dBuV/m	Margin dB	Detector	Comment
1 *	17880.0000	25.90	28.77	54.67	80.00	-25.33	Peak	

Orthogonal Axis :	X
Test Mode :	TX G MODE 2462MHz

**Vertical**

130 dBuV/m

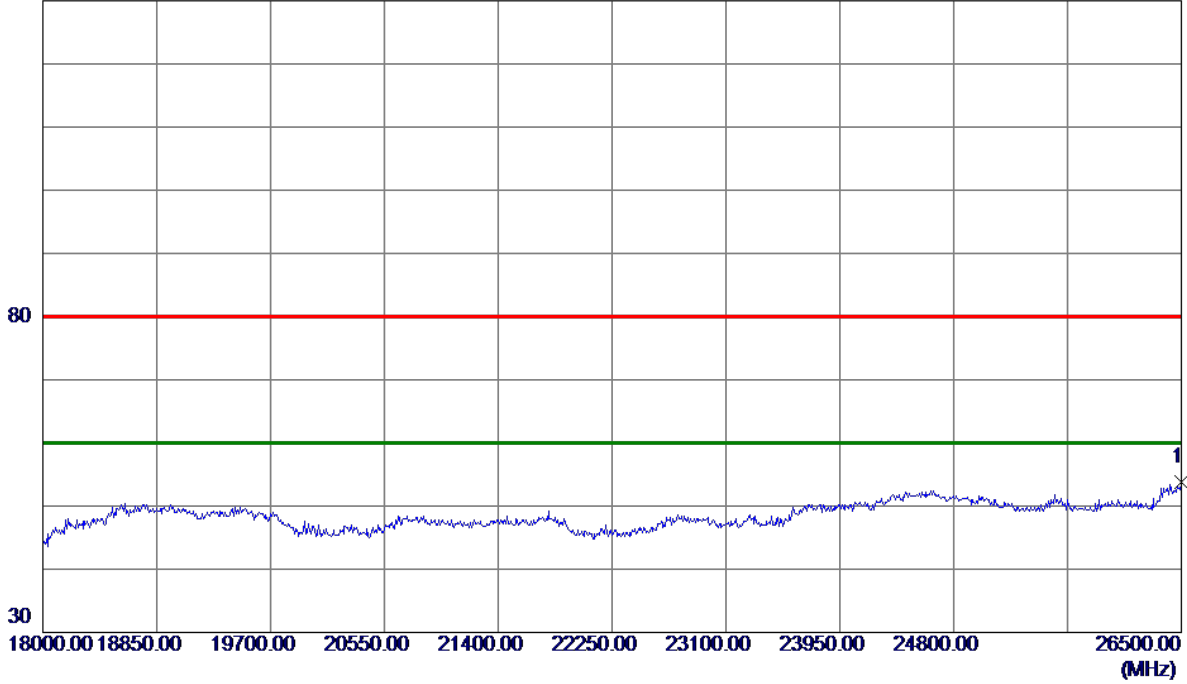

No.	Freq. MHz	Reading Level dBuV/m	Correct Factor dB	Measure ment dBuV/m	Limit dBuV/m	Margin dB	Detector	Comment
1 *	26500.0000	53.82	0.00	53.82	80.00	-26.18	Peak	

Orthogonal Axis :	X
Test Mode :	TX G MODE 2462MHz

**Horizontal**

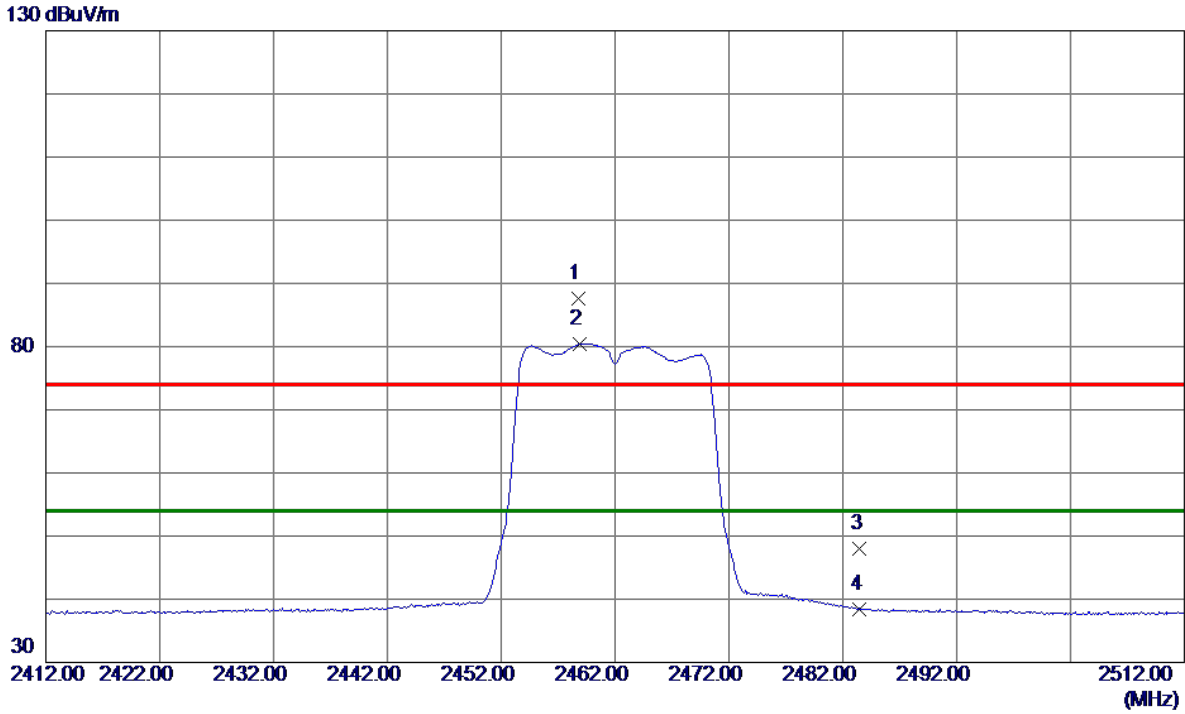

No.	Freq. MHz	Reading Level dBuV/m	Correct Factor dB	Measure ment dBuV/m	Limit dBuV/m	Margin dB	Detector	Comment
1	2458.8000	76.29	11.34	87.63	74.00	13.63	Peak	No Limit
2 *	2458.9000	69.14	11.34	80.48	54.00	26.48	AVG	No Limit
3	2483.5000	36.56	11.35	47.91	74.00	-26.09	Peak	
4	2483.5000	27.12	11.35	38.47	54.00	-15.53	AVG	

Orthogonal Axis :	X
Test Mode :	TX G MODE 2462MHz

**Horizontal**

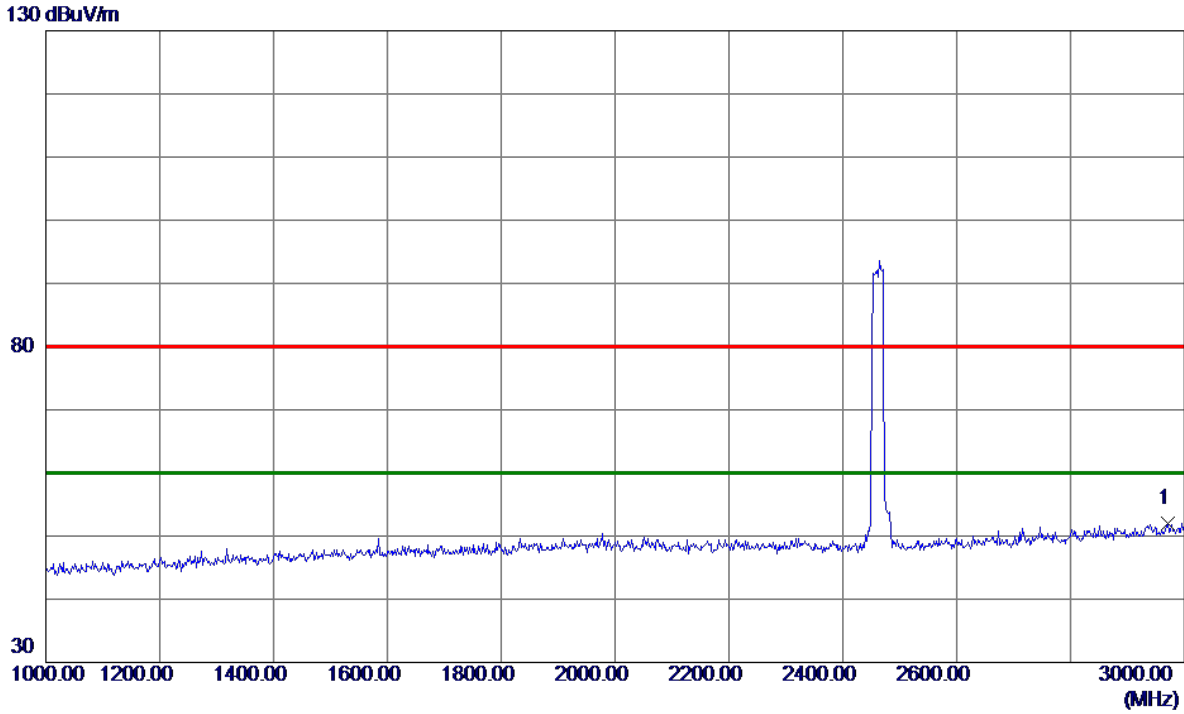

No.	Freq. MHz	Reading Level dBuV/m	Correct Factor dB	Measure ment dBuV/m	Limit dBuV/m	Margin dB	Detector	Comment
1 *	2972.0000	37.22	14.80	52.02	80.00	-27.98	Peak	



Orthogonal Axis :	X
Test Mode :	TX G MODE 2462MHz

**Horizontal**

130 dBuV/m

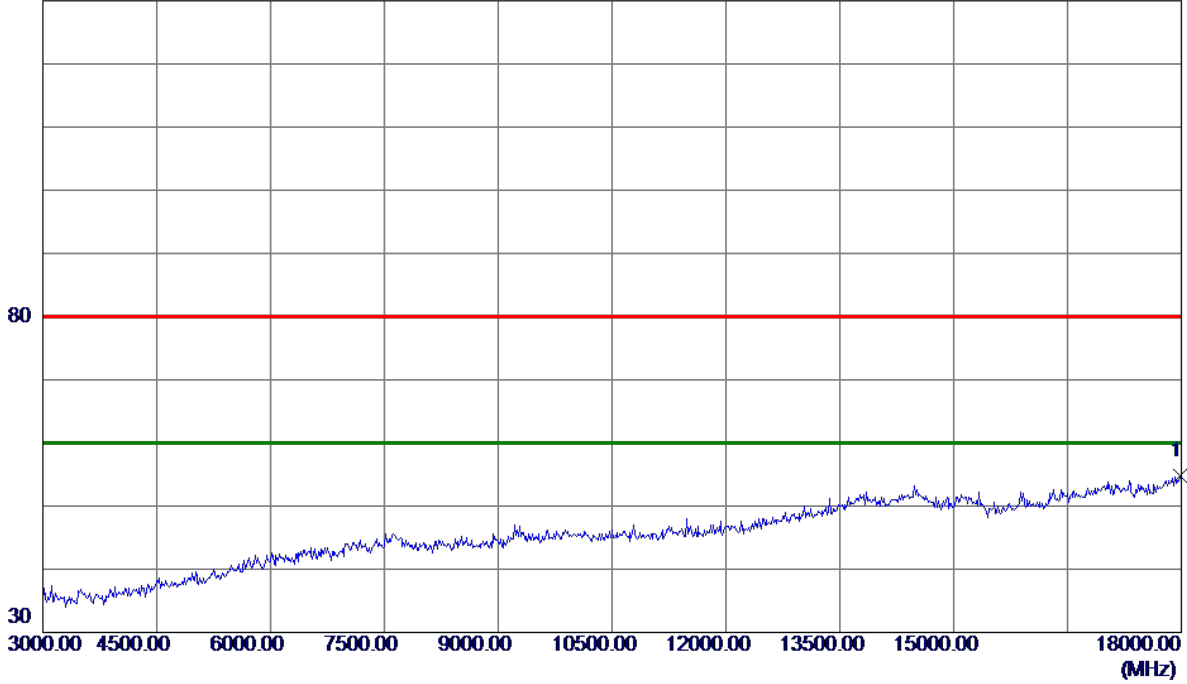

No.	Freq. MHz	Reading Level dBuV/m	Correct Factor dB	Measure ment dBuV/m	Limit dBuV/m	Margin dB	Detector	Comment
1 *	17985.0000	25.61	29.11	54.72	80.00	-25.28	Peak	

Orthogonal Axis :	X
Test Mode :	TX G MODE 2462MHz

**Horizontal**

130 dBuV/m



No.	Freq. MHz	Reading Level dBuV/m	Correct Factor dB	Measure ment dBuV/m	Limit dBuV/m	Margin dB	Detector	Comment
1 *	24672.5000	87.10	-33.10	54.00	80.00	-26.00	Peak	

Orthogonal Axis :	X
Test Mode :	TX N-20M MODE 2412MHz

**Vertical**

130 dBuV/m

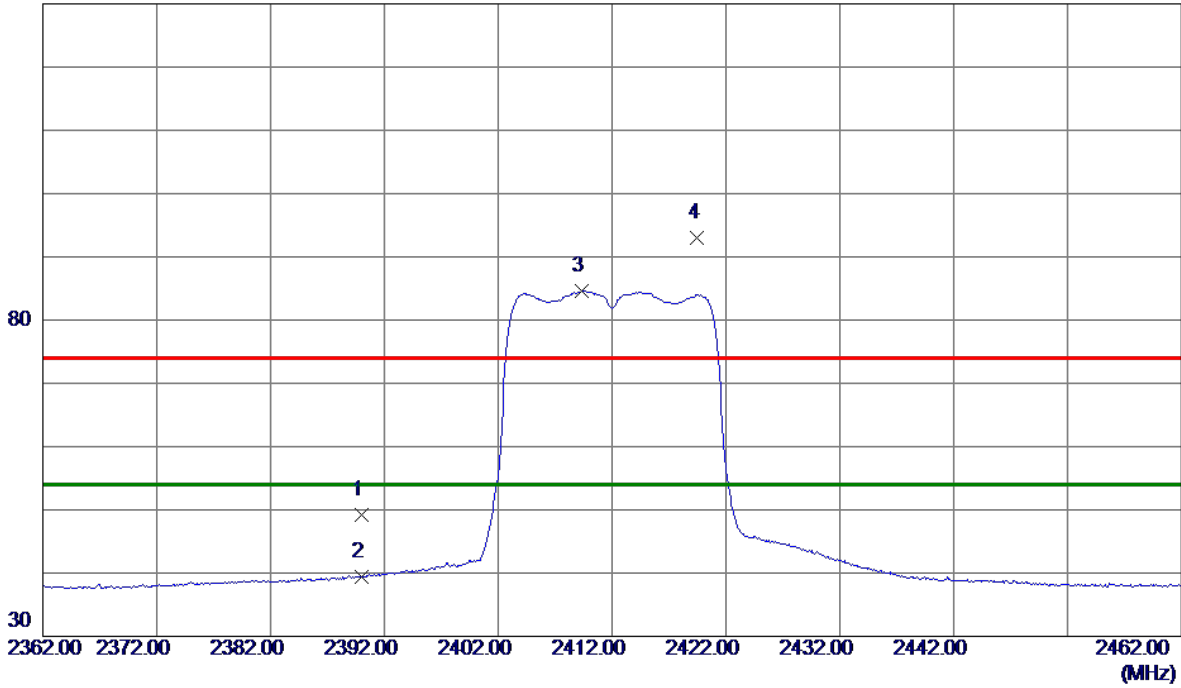

No.	Freq. MHz	Reading Level dBuV/m	Correct Factor dB	Measure ment dBuV/m	Limit dBuV/m	Margin dB	Detector	Comment
1	2390.0000	37.80	11.32	49.12	74.00	-24.88	Peak	
2	2390.0000	28.17	11.32	39.49	54.00	-14.51	AVG	
3 *	2409.3000	73.22	11.32	84.54	54.00	30.54	AVG	No Limit
4	2419.5000	81.61	11.33	92.94	74.00	18.94	Peak	No Limit

Orthogonal Axis :	X
Test Mode :	TX N-20M MODE 2412MHz

**Vertical**

130 dBuV/m

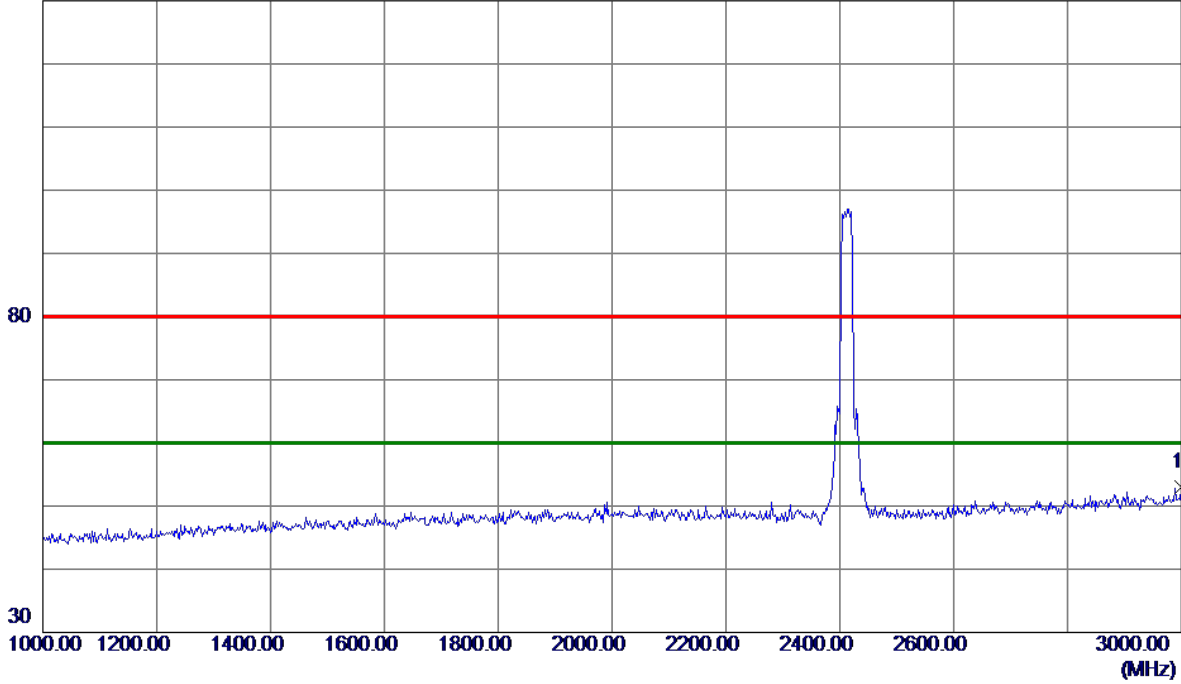

No.	Freq. MHz	Reading Level dBuV/m	Correct Factor dB	Measure ment dBuV/m	Limit dBuV/m	Margin dB	Detector	Comment
1 *	3000.0000	37.97	15.00	52.97	80.00	-27.03	Peak	

Orthogonal Axis :	X
Test Mode :	TX N-20M MODE 2412MHz

**Vertical**

130 dBuV/m

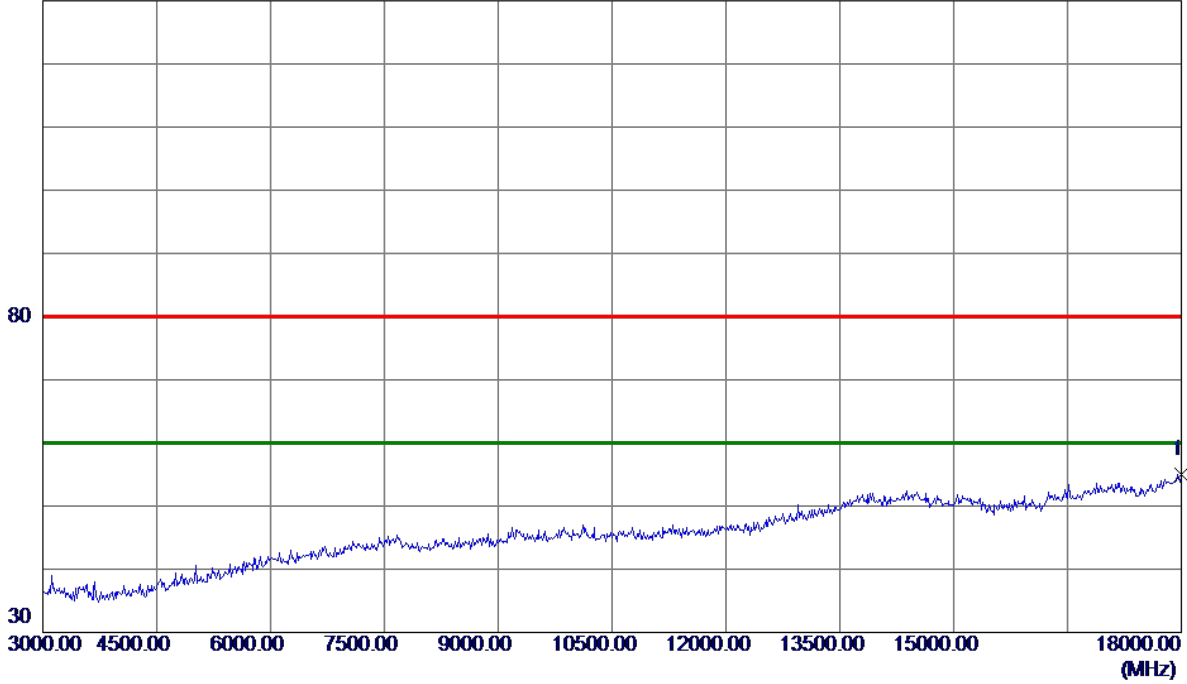

No.	Freq. MHz	Reading Level dBuV/m	Correct Factor dB	Measure ment dBuV/m	Limit dBuV/m	Margin dB	Detector	Comment
1 *	18000.0000	25.87	29.16	55.03	80.00	-24.97	Peak	

Orthogonal Axis :	X
Test Mode :	TX N-20M MODE 2412MHz

**Vertical**

130 dBuV/m

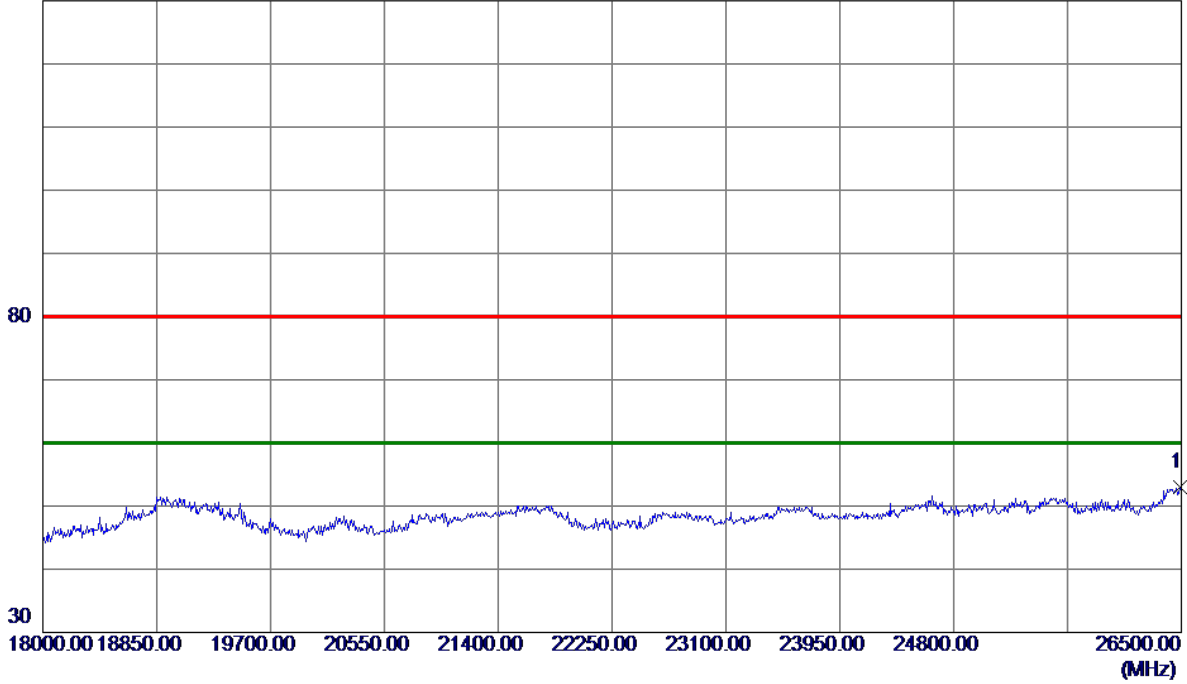

No.	Freq. MHz	Reading Level dBuV/m	Correct Factor dB	Measure ment dBuV/m	Limit dBuV/m	Margin dB	Detector	Comment
1 *	26491.5000	53.06	0.00	53.06	80.00	-26.94	Peak	

Orthogonal Axis :	X
Test Mode :	TX N-20M MODE 2412MHz

**Horizontal**

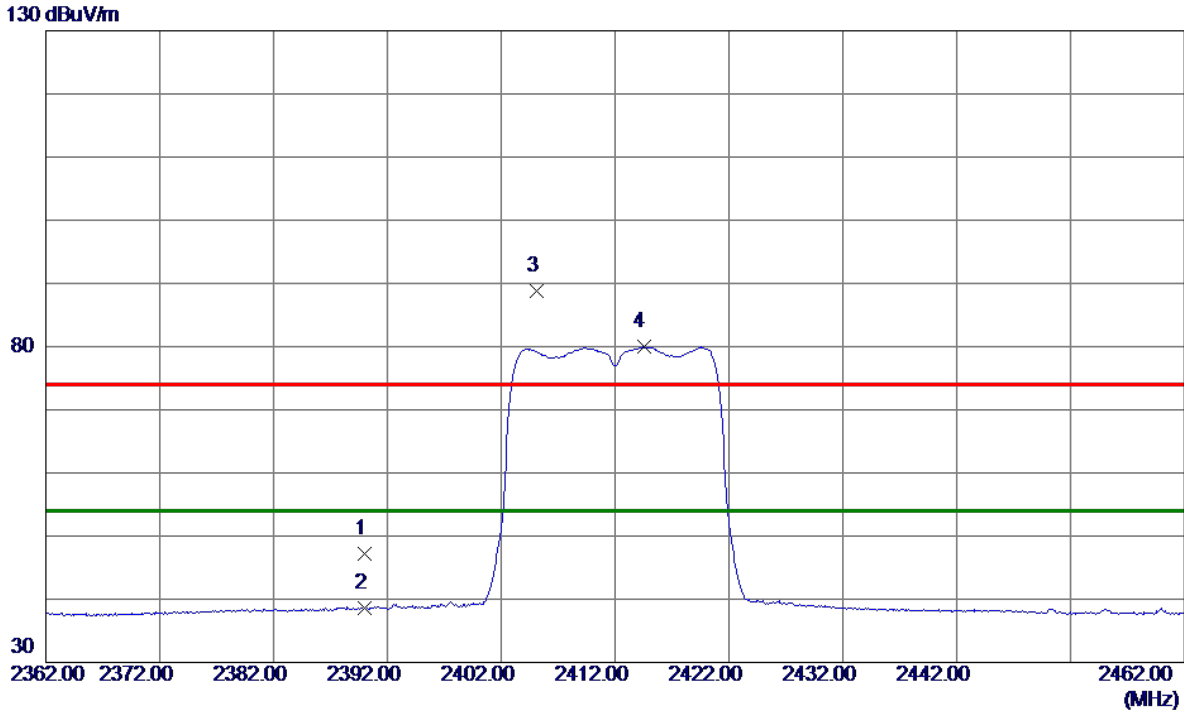

No.	Freq. MHz	Reading Level dBuV/m	Correct Factor dB	Measure ment dBuV/m	Limit dBuV/m	Margin dB	Detector	Comment
1	2390.0000	35.85	11.32	47.17	74.00	-26.83	Peak	
2	2390.0000	27.23	11.32	38.55	54.00	-15.45	AVG	
3	2405.1000	77.54	11.32	88.86	74.00	14.86	Peak	No Limit
4 *	2414.5000	68.60	11.33	79.93	54.00	25.93	AVG	No Limit

Orthogonal Axis :	X
Test Mode :	TX N-20M MODE 2412MHz

**Horizontal**

130 dBuV/m

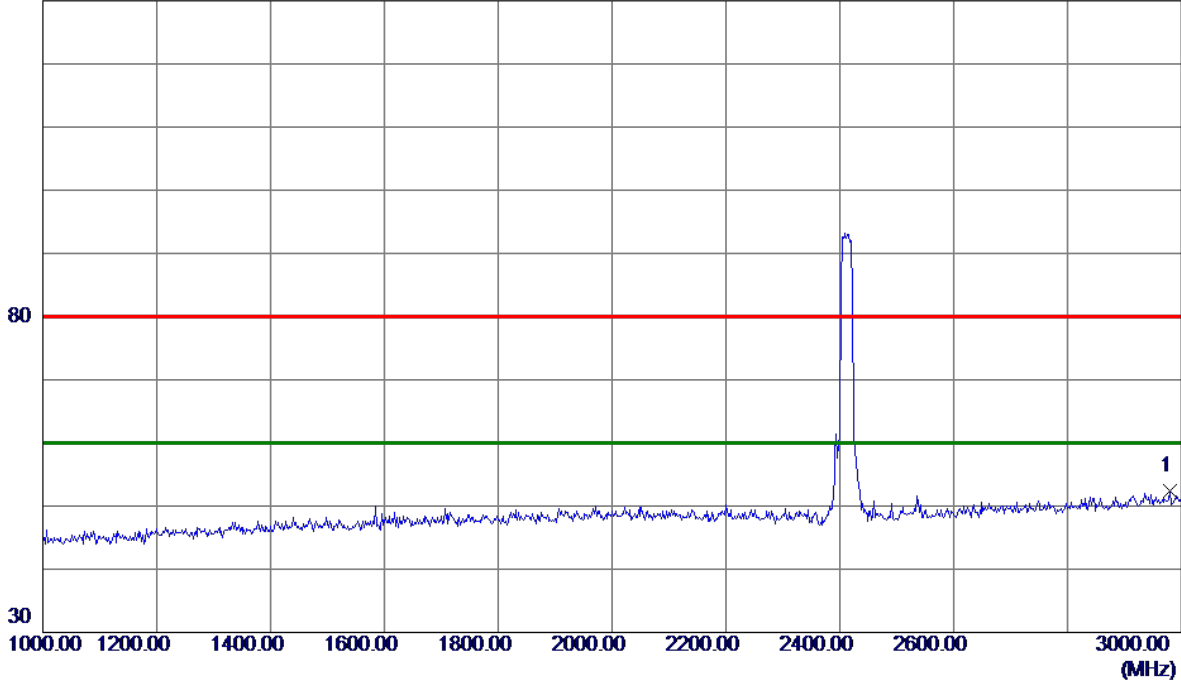

No.	Freq. MHz	Reading Level dBuV/m	Correct Factor dB	Measure ment dBuV/m	Limit dBuV/m	Margin dB	Detector	Comment
1 *	2980.0000	37.62	14.85	52.47	80.00	-27.53	Peak	



Orthogonal Axis :	X
Test Mode :	TX N-20M MODE 2412MHz

**Horizontal**

130 dBuV/m

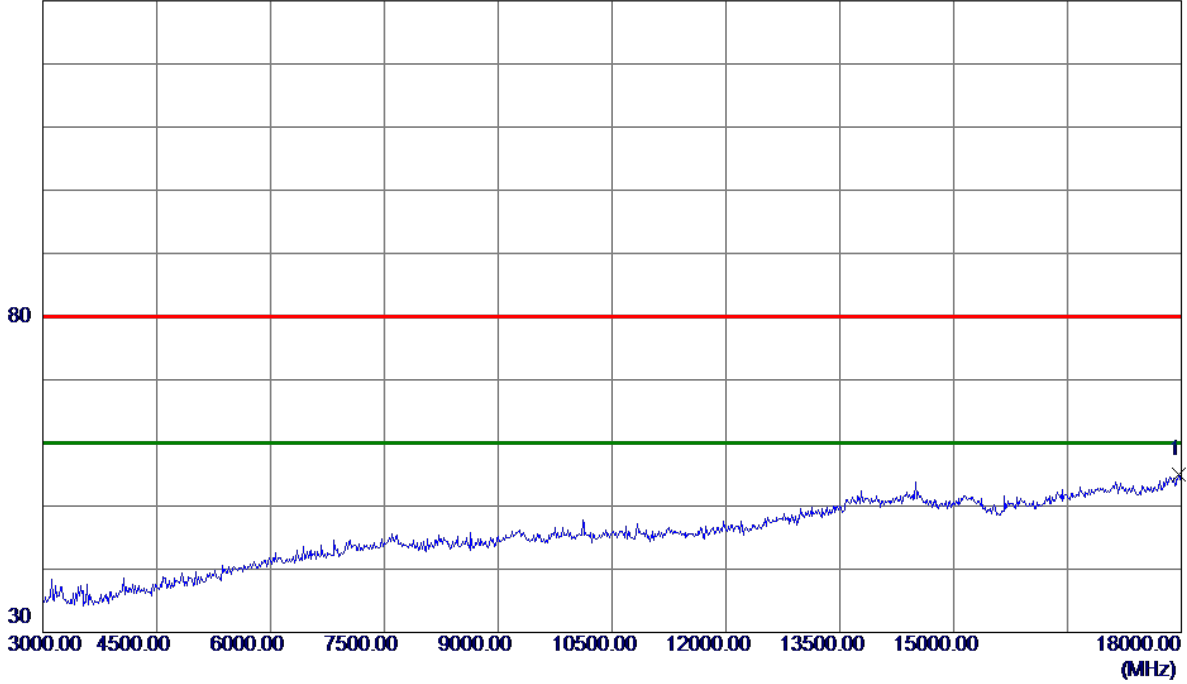

No.	Freq. MHz	Reading Level dBuV/m	Correct Factor dB	Measure ment dBuV/m	Limit dBuV/m	Margin dB	Detector	Comment
1 *	17970.0000	25.92	29.06	54.98	80.00	-25.02	Peak	

Orthogonal Axis :	X
Test Mode :	TX N-20M MODE 2412MHz

**Horizontal**

130 dBuV/m

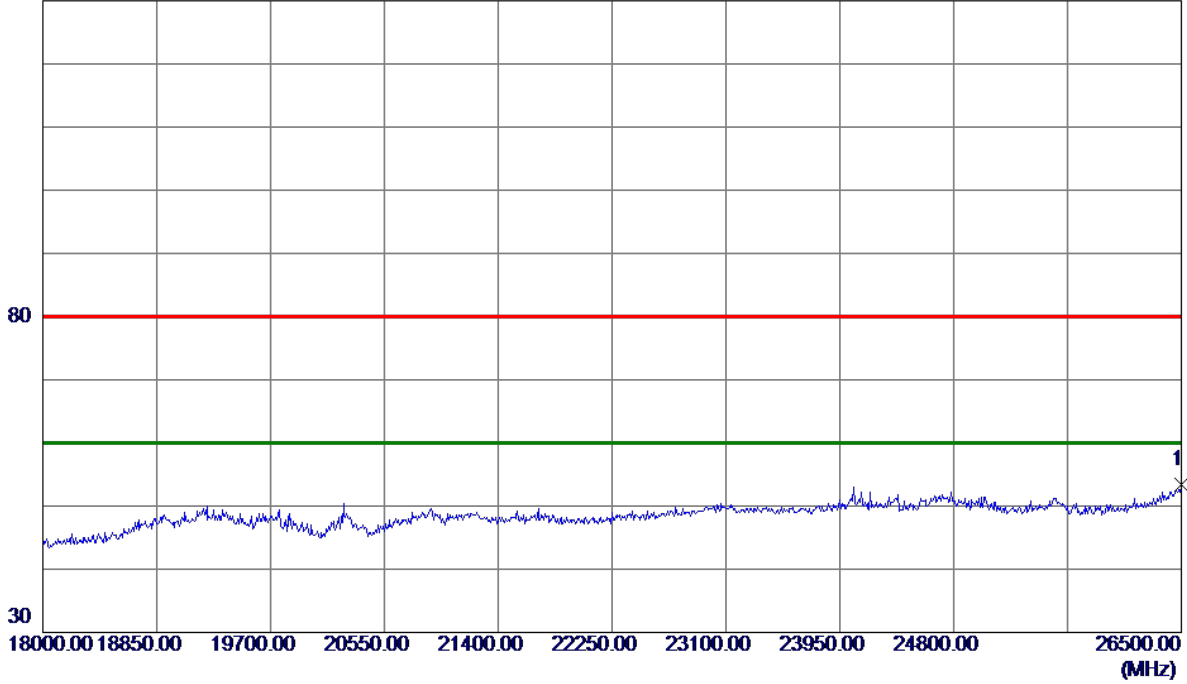

No.	Freq. MHz	Reading Level dBuV/m	Correct Factor dB	Measure ment dBuV/m	Limit dBuV/m	Margin dB	Detector	Comment
1 *	26500.0000	53.32	0.00	53.32	80.00	-26.68	Peak	

Orthogonal Axis :	X
Test Mode :	TX N-20M MODE 2437MHz

**Vertical**

130 dBuV/m

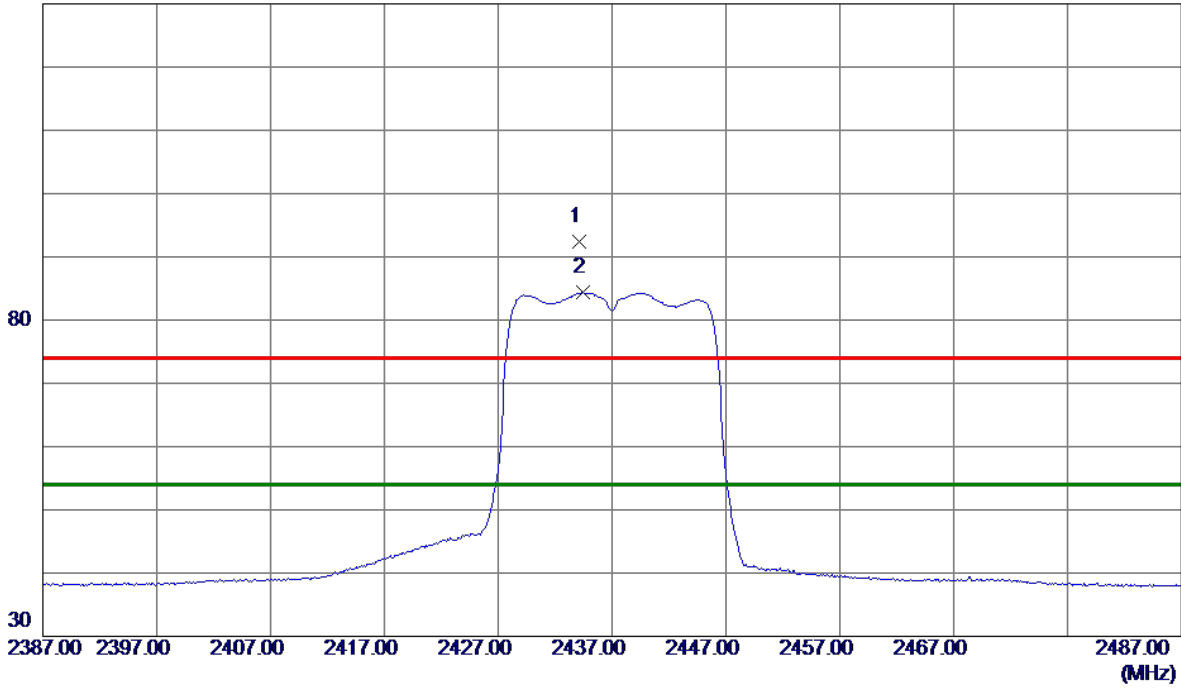

No.	Freq. MHz	Reading Level dBuV/m	Correct Factor dB	Measure ment dBuV/m	Limit dBuV/m	Margin dB	Detector	Comment
1	2434.1000	80.99	11.33	92.32	74.00	18.32	Peak	No Limit
2 *	2434.4000	73.06	11.33	84.39	54.00	30.39	AVG	No Limit

Orthogonal Axis :	X
Test Mode :	TX N-20M MODE 2437MHz

**Vertical**

130 dBuV/m

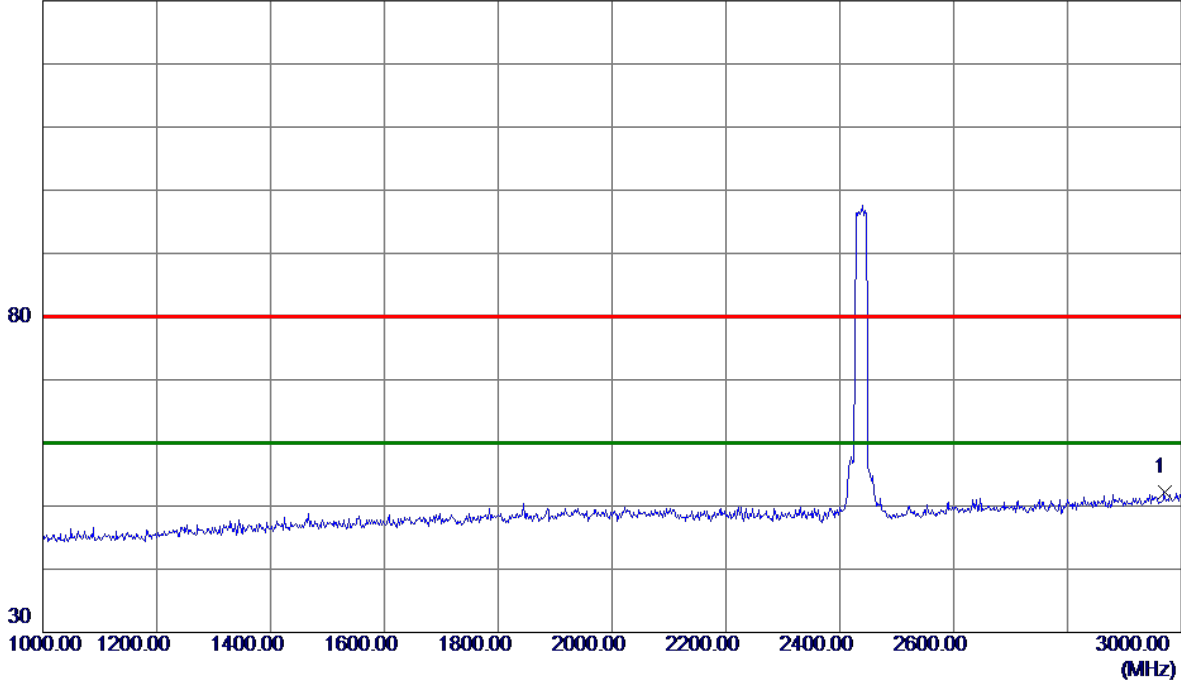

No.	Freq. MHz	Reading Level dBuV/m	Correct Factor dB	Measure ment dBuV/m	Limit dBuV/m	Margin dB	Detector	Comment
1 *	2970.0000	37.34	14.78	52.12	80.00	-27.88	Peak	