

FCC Radio Test Report

FCC ID: YBN-AIVIL42P0

This report concerns (check one): Original Grant Class I Change Class II Change

Project No. : 1807C078
Equipment : Car Radio with navigation, BT and WLAN
Test Model : AIVIL42P0
Series Model : N/A
Applicant : Bosch Car Multimedia GmbH
Address : Robert-Bosch-Straße 200; 31139 Hildesheim

Date of Receipt : Jul. 11, 2018
Date of Test : Jul. 11, 2018 ~ Jul. 17, 2018
Issued Date : Jul. 25, 2018
Tested by : BTL Inc.

Testing Engineer : Chay Cai
(Chay Cai)

Technical Manager : David Mao
(David Mao)

Authorized Signatory : Steven Lu
(Steven Lu)

B T L I N C .

No.3, Jinshagang 1st Road, Shixia, Dalang Town, Dongguan,
Guangdong, China.

TEL: +86-769-8318-3000 FAX: +86-769-8319-6000



Declaration

BTL represents to the client that testing is done in accordance with standard procedures as applicable and that test instruments used has been calibrated with standards traceable to international standard(s) and/or national standard(s).

BTL's reports apply only to the specific samples tested under conditions. It is manufacture's responsibility to ensure that additional production units of this model are manufactured with the identical electrical and mechanical components. **BTL** shall have no liability for any declarations, inferences or generalizations drawn by the client or others from **BTL** issued reports.

The report must not be used by the client to claim product certification, approval, or endorsement by NVLAP, NIST, or any agency of the U.S. Government.

This report is the confidential property of the client. As a mutual protection to the clients, the public and ourselves, the test report shall not be reproduced, except in full, without our written approval.

BTL's laboratory quality assurance procedures are in compliance with the **ISO Guide 17025** requirements, and accredited by the conformity assessment authorities listed in this test report.

BTL is not responsible for the sampling stage, so the results only apply to the sample as received.

The information, data and test plan are provided by manufacturer, so it is manufacturer's responsibility to ensure that the apparatus meets the essential requirements in all the possible configurations as representative of its intended use.

Limitation

For the use of the authority's logo is limited unless the Test Standard(s)/Scope(s)/Item(s) mentioned in this test report is (are) included in the conformity assessment authorities acceptance respective.

Table of Contents**Page**

1 . CERTIFICATION	6
2 . SUMMARY OF TEST RESULTS	7
2.1 TEST FACILITY	8
2.2 MEASUREMENT UNCERTAINTY	8
3 . GENERAL INFORMATION	9
3.1 GENERAL DESCRIPTION OF EUT	9
3.2 DESCRIPTION OF TEST MODES	12
3.3 TABLE OF PARAMETERS OF TEST SOFTWARE SETTING	14
3.4 BLOCK DIAGRAM SHOWING THE CONFIGURATION OF SYSTEM TESTED	16
3.5 DESCRIPTION OF SUPPORT UNITS	16
4 . EMC EMISSION TEST	17
4.1 RADIATED EMISSION MEASUREMENT	17
4.1.1 RADIATED EMISSION LIMITS	17
4.1.2 TEST PROCEDURE	18
4.1.3 DEVIATION FROM TEST STANDARD	18
4.1.4 TEST SETUP	18
4.1.5 EUT OPERATING CONDITIONS	20
4.1.6 EUT TEST CONDITIONS	20
4.1.7 TEST RESULTS (9K TO 30MHz)	21
4.1.8 TEST RESULTS (BETWEEN 30 TO 1000 MHz)	21
4.1.9 TEST RESULTS (ABOVE 1000 MHz)	21
5 . 26dB SPECTRUM BANDWIDTH	22
5.1 APPLIED PROCEDURES / LIMIT	22
5.1.1 TEST PROCEDURE	22
5.1.2 DEVIATION FROM STANDARD	22
5.1.3 TEST SETUP	22
5.1.4 EUT OPERATION CONDITIONS	23
5.1.5 EUT TEST CONDITIONS	23
5.1.6 TEST RESULTS	23
6 . MAXIMUM AVERAGE OUTPUT POWER	24
6.1 APPLIED PROCEDURES / LIMIT	24
6.1.1 TEST PROCEDURE	24
6.1.2 DEVIATION FROM STANDARD	24
6.1.3 TEST SETUP	24
6.1.4 EUT OPERATION CONDITIONS	24
6.1.5 EUT TEST CONDITIONS	24
6.1.6 TEST RESULTS	24

Table of Contents	Page
7 . POWER SPECTRAL DENSITY TEST	25
7.1 APPLIED PROCEDURES / LIMIT	25
8.1.1 TEST PROCEDURE	25
7.1.1 DEVIATION FROM STANDARD	26
7.1.2 TEST SETUP	26
7.1.3 EUT OPERATION CONDITIONS	26
7.1.4 EUT TEST CONDITIONS	26
7.1.5 TEST RESULTS	26
8 . FREQUENCY STABILITY MEASUREMENT	27
8.1 APPLIED PROCEDURES / LIMIT	27
8.1.1 TEST PROCEDURE	27
8.1.2 DEVIATION FROM STANDARD	27
8.1.3 TEST SETUP	28
8.1.4 EUT OPERATION CONDITIONS	28
8.1.5 EUT TEST CONDITIONS	28
8.1.6 TEST RESULTS	28
9 . MEASUREMENT INSTRUMENTS LIST	29
10 . EUT TEST PHOTOS	31
APPENDIX A - RADIATED EMISSION (9KHZ TO 30MHZ)	36
APPENDIX B - RADIATED EMISSION (30MHZ TO 1000MHZ)	41
APPENDIX C - RADIATED EMISSION (ABOVE 1000MHZ)	66
APPENDIX D - BANDWIDTH	443
APPENDIX E - MAXIMUM AVG OUTPUT POWER	473
APPENDIX F - POWER SPECTRAL DENSITY	490
APPENDIX G - FREQUENCY STABILITY	520

REPORT ISSUED HISTORY

Issued No.	Description	Issued Date
BTL-FCCP-3-1807C078	Original Issue.	Jul. 25, 2018

1. CERTIFICATION

Equipment : Car Radio with navigation, BT and WLAN
Brand Name : Bosch
Test Model : AIVIL42P0
Series Model : N/A
Applicant : Bosch Car Multimedia GmbH
Manufacturer : #1 Bosch Car Multimedia GmbH
 #2 Bosch Car Multimedia Portugal, S.A.
Address : #1 Robert-Bosch-Straße 200; 31139 Hildesheim
 #2 Rua Max Grundig, 35-Lomar, 4705-820 Braga
Factory : Robert Bosch (Malaysia)
Address : Free Trade Zone 11900, Bayan Lepas, Penang
Date of Test : Jul. 11, 2018 ~ Jul. 17, 2018
Test Sample : Engineering Sample No.: D180705792 for conducted, D180705794 for
 radiated
Standard(s) : FCC Part15, Subpart E(15.407) / ANSI C63.10-2013

The above equipment has been tested and found compliance with the requirement of the relative standards by BTL Inc.

The test data, data evaluation, and equipment configuration contained in our test report (Ref No. BTL-FCCP-3-1807C078) were obtained utilizing the test procedures, test instruments, test sites that has been accredited by the Authority of NVLAP according to the ISO-17025 quality assessment standard and technical standard(s).

Test results included in this report is only for the RLAN UNII-1, UNII-2A, UNII-2C, UNII-3 part.

2. SUMMARY OF TEST RESULTS

Test procedures according to the technical standard(s):

FCC Part15, Subpart E(15.407)			
Standard(s) Section	Test Item	Judgment	Remark
15.407(a)	26dB Spectrum Bandwidth	PASS	
15.407(a)	Maximum Average Output Power	PASS	
15.407(a)	Power Spectral Density	PASS	
15.407(a)	Radiated Emissions	PASS	
15.407(b)	Band Edge Emissions	PASS	
15.407(g)	Frequency Stability	PASS	
15.203	Antenna Requirements	PASS	

NOTE:

(1) "N/A" denotes test is not applicable in this test report.

2.1 TEST FACILITY

The test facilities used to collect the test data in this report is at the location of No.3,Jinshagang 1st Road, Shixia, Dalang Town, Dongguan, Guangdong, China.

BTL's test firm number for FCC: 854385

BTL's designation number for FCC: CN5020

2.2 MEASUREMENT UNCERTAINTY

The measurement uncertainty figures shall be calculated according the methods described in the ETSI TR 100 028 and shall correspond to an expansion factor (coverage factor) $k=1.96$ or $k=2$ (which provide confidence levels of respectively 90% and 95.45% in the case where the distributions characterizing the actual measurement uncertainties are normal (Gaussian)). Measurement Uncertainty for a Level of Confidence of 95 %, $U=2 \times U_c(y)$.

The BTL measurement uncertainty as below table:

A. Radiated Measurement:

Test Site	Method	Measurement Frequency Range	Ant. H / V	U, (dB)
DG-CB03	CISPR	9kHz~30MHz	V	3.79
		9kHz~30MHz	H	3.57
		30MHz ~ 200MHz	V	3.82
		30MHz ~ 200MHz	H	3.60
		200MHz ~ 1,000MHz	V	3.86
		200MHz ~ 1,000MHz	H	3.94
		1GHz~18GHz	V	3.12
		1GHz~18GHz	H	3.68
		18GHz~40GHz	V	4.15
18GHz~40GHz	H	4.14		

Note: Unless specifically mentioned, the uncertainty of measurement has not been taken into account to declare the compliance or non-compliance to the specification.

3. GENERAL INFORMATION

3.1 GENERAL DESCRIPTION OF EUT

Equipment	Car Radio with navigation, BT and WLAN	
Brand Name	Bosch	
Test Model	AIVIL42P0	
Series Model	N/A	
Model Difference	N/A	
Product Description	Operation Frequency	UNII-1: 5150 ~ 5250 MHz UNII-2A: 5250 ~ 5350 MHz UNII-2C: 5470 ~ 5600 MHz 5650 ~ 5725 MHz UNII-3: 5725 ~ 5850 MHz
	Modulation Type	OFDM
	Bit Rate of Transmitter	433.3Mbps
	AVG Output Power (Max.)for UNII-1	802.11a: 2.63 dBm 802.11n (20M): 2.68 dBm 802.11n (40M): 1.72 dBm 802.11ac (20M): -1.14 dBm 802.11ac (40M): -1.76 dBm 802.11ac (80M): 1.92 dBm
	AVG Output Power (Max.)for UNII-2A	802.11a: 2.66 dBm 802.11n (20M): 2.67 dBm 802.11n (40M): 1.70 dBm 802.11ac (20M): -1.26 dBm 802.11ac (40M): -1.80 dBm 802.11ac (80M): 1.93 dBm
	AVG Output Power (Max.)for UNII-2C	802.11a: 6.18 dBm 802.11n (20M): 6.60 dBm 802.11n (40M): 5.60 dBm 802.11ac (20M): -1.04 dBm 802.11ac (40M): 0.87 dBm 802.11ac (80M): 2.60 dBm
	AVG Output Power (Max.)for UNII-3	802.11a: 7.36 dBm 802.11n (20M): 7.73 dBm 802.11n (40M): 6.92 dBm 802.11ac (20M): 4.13 dBm 802.11ac (40M): 4.00 dBm 802.11ac (80M): 7.49 dBm
Power Source	DC voltage supplied from external power supply.	
Power Rating	DC 13.5V	

Note:

1. For a more detailed features description, please refer to the manufacturer's specifications or the User's Manual.

2. Channel List:

802.11a 802.11n 20MHz 802.11ac 20MHz		802.11n 40MHz 802.11ac 40MHz		802.11ac 80MHz	
UNII-1		UNII-1		UNII-1	
Channel	Frequency (MHz)	Channel	Frequency (MHz)	Channel	Frequency (MHz)
36	5180	38	5190	42	5210
40	5200	46	5230		
44	5220				
48	5240				

802.11a 802.11n 20MHz 802.11ac 20MHz		802.11n 40MHz 802.11ac 40MHz		802.11ac 80MHz	
UNII-2A		UNII-2A		UNII-2A	
Channel	Frequency (MHz)	Channel	Frequency (MHz)	Channel	Frequency (MHz)
52	5260	54	5270	58	5290
56	5280	62	5310		
60	5300				
64	5320				

802.11a 802.11n 20MHz 802.11ac 20MHz		802.11n 40MHz 802.11ac 40MHz		802.11ac 80MHz	
UNII-2C		UNII-2C		UNII-2C	
Channel	Frequency (MHz)	Channel	Frequency (MHz)	Channel	Frequency (MHz)
100	5500	102	5510	106	5530
104	5520	110	5550		
108	5540	134	5670		
112	5560				
116	5580				
132	5660				
136	5680				
140	5700				

802.11a 802.11n 20MHz 802.11ac 20MHz		802.11n 40MHz 802.11ac 40MHz		802.11ac 80MHz	
UNII-3		UNII-3		UNII-3	
Channel	Frequency (MHz)	Channel	Frequency (MHz)	Channel	Frequency (MHz)
149	5745	151	5755	155	5775
153	5765	159	5795		
157	5785				
161	5805				
165	5825				

3. Antenna Specification:

Ant.	Brand	Model Name	Antenna Type	Connector	Gain(dBi)	Note
1	N/A	N/A	Internal	N/A	8.1	UNII-1
1	N/A	N/A	Internal	N/A	7.5	UNII-2A
1	N/A	N/A	Internal	N/A	5.1	UNII-2C
1	N/A	N/A	Internal	N/A	2.4	UNII-3

Note:

The EUT incorporates a SISO function. Physically, the EUT provides completed transmitters and receivers. Then,

1. Antenna Gain=8.1 dBi. So, the UNII-1 out power limit is $24-8.1+6=21.90$, power density limit is $11-8.1+6=8.9$
2. Antenna Gain=7.5 dBi. So, the UNII-2A out power limit is $24-7.5+6=22.50$, power density limit is $11-7.5+6=9.5$

3.2 DESCRIPTION OF TEST MODES

To investigate the maximum EMI emission characteristics generates from EUT, the test system was pre-scanning tested base on the consideration of following EUT operation mode or test configuration mode which possible have effect on EMI emission level. Each of these EUT operation mode(s) or test configuration mode(s) mentioned above was evaluated respectively.

Pretest Mode	Description
Mode 1	TX A Mode / CH36, CH40, CH48 (UNII-1)
Mode 2	TX N20 Mode / CH36, CH40, CH48 (UNII-1)
Mode 3	TX N40 Mode / CH38, CH46 (UNII-1)
Mode 4	TX AC80 Mode / CH42 (UNII-1)
Mode 5	TX A Mode / CH52, CH56, CH64 (UNII-2A)
Mode 6	TX N20 Mode / CH52, CH56, CH64 (UNII-2A)
Mode 7	TX N40 Mode / CH54, CH62 (UNII-2A)
Mode 8	TX AC80 Mode / CH58 (UNII-2A)
Mode 9	TX A Mode / CH100, CH116, CH140 (UNII-2C)
Mode 10	TX N20 Mode / CH100, CH116, CH140 (UNII-2C)
Mode 11	TX N40 Mode / CH102, CH110, CH134 (UNII-2C)
Mode 12	TX AC80 Mode / CH106 (UNII-2C)
Mode 13	TX A Mode / CH149,CH157,CH165 (UNII-3)
Mode 14	TX N20 Mode / CH149,CH157,CH165 (UNII-3)
Mode 15	TX N40 Mode / CH151,CH159 (UNII-3)
Mode 16	TX AC80 Mode / CH155 (UNII-3)

The EUT system operated these modes were found to be the worst case during the pre-scanning test as following:

For Radiated Test	
Final Test Mode	Description
Mode 1	TX A Mode / CH36, CH40, CH48 (UNII-1)
Mode 2	TX N20 Mode / CH36, CH40, CH48 (UNII-1)
Mode 3	TX N40 Mode / CH38, CH46 (UNII-1)
Mode 4	TX AC80 Mode / CH42 (UNII-1)
Mode 5	TX A Mode / CH52, CH56, CH64 (UNII-2A)
Mode 6	TX N20 Mode / CH52, CH56, CH64 (UNII-2A)
Mode 7	TX N40 Mode / CH54, CH62 (UNII-2A)
Mode 8	TX AC80 Mode / CH58 (UNII-2A)
Mode 9	TX A Mode / CH100, CH116, CH140 (UNII-2C)
Mode 10	TX N20 Mode / CH100, CH116, CH140 (UNII-2C)
Mode 11	TX N40 Mode / CH102, CH110, CH134 (UNII-2C)
Mode 12	TX AC80 Mode / CH106 (UNII-2C)
Mode 13	TX A Mode / CH149,CH157,CH165 (UNII-3)
Mode 14	TX N20 Mode / CH149,CH157,CH165 (UNII-3)
Mode 15	TX N40 Mode / CH151,CH159 (UNII-3)
Mode 16	TX AC80 Mode / CH155 (UNII-3)

Note:

- (1) For radiated below 1GHz test, the 802.11a mode is found to be the worst case and recorded.
- (2) The measurements for Maximum Conducted Output Power are tested, the worst case are A Mode, N20 Mode, N40 Mode and AC80 Mode, only worst case was documented for other test items.

3.3 TABLE OF PARAMETERS OF TEST SOFTWARE SETTING

During testing channel & power controlling software provided by the customer was used to control the operating channel as well as the output power level. The RF output power selection is for the setting of RF output power expected by the customer and is going to be fixed on the firmware of the final end product

UNII-1			
Test Software Version	DutApi_w8887_BrdigeEth		
Frequency (MHz)	5180	5200	5240
A Mode	10	10	10
N20 Mode	10	10	10
AC20 Mode	6	6	6
Frequency (MHz)	5190	5230	
N40 Mode	10	10	
AC40 Mode	6	6	
Frequency (MHz)	5210		
AC80 Mode	6		

UNII-2A			
Test Software Version	DutApi_w8887_BrdigeEth		
Frequency (MHz)	5260	5280	5320
A Mode	10	10	10
N20 Mode	10	10	10
AC20 Mode	6	6	6
Frequency (MHz)	5270	5310	
N40 Mode	10	10	
AC40 Mode	6	6	
Frequency (MHz)	5290		
AC80 Mode	6		

UNII-2C			
Test Software Version	DutApi_w8887_BrdigeEth		
Frequency (MHz)	5500	5580	5700
A Mode	10	10	10
N20 Mode	10	10	10
AC20 Mode	6	6	6
Frequency (MHz)	5510	5550	5670
N40 Mode	10	10	10
AC40 Mode	6	6	6
Frequency (MHz)	5530		
AC80 Mod	6		

UNII-3			
Test Software Version	DutApi_w8887_BrdigeEth		
Frequency (MHz)	5745	5785	5825
A Mode	10	10	10
N20 Mode	10	10	10
AC20 Mode	6	6	6
Frequency (MHz)	5755	5795	
N40 Mode	10	10	
AC40 Mode	6	6	
Frequency (MHz)	5775		
AC80 Mode	6		

3.4 BLOCK DIAGRAM SHOWING THE CONFIGURATION OF SYSTEM TESTED

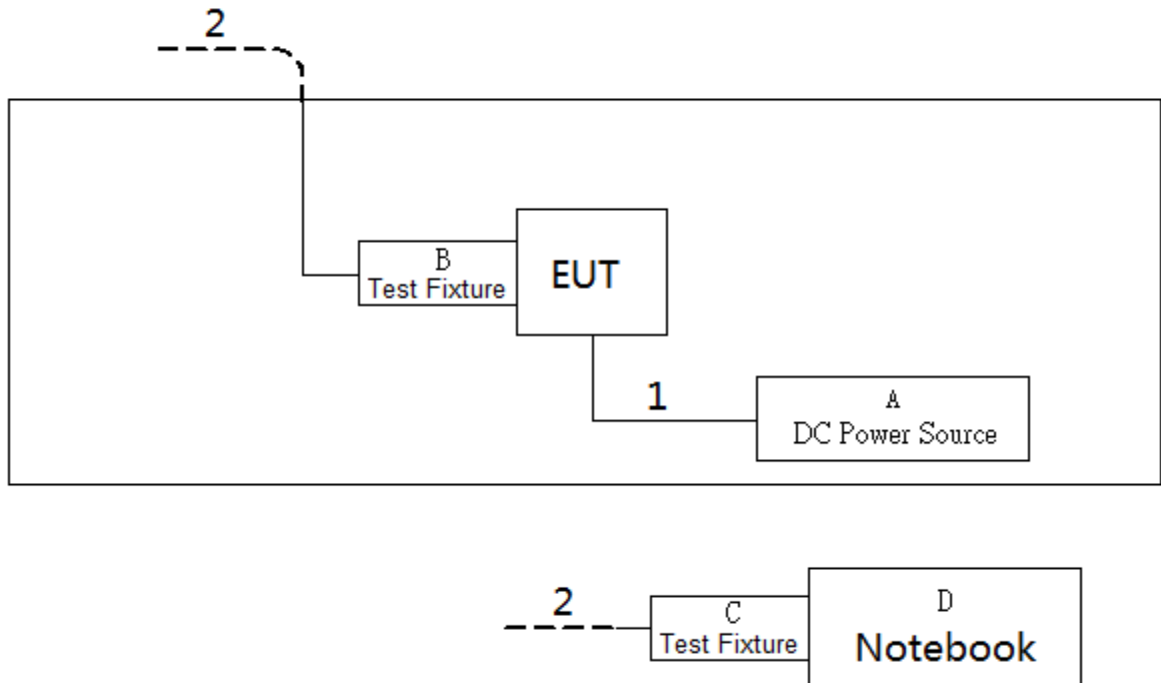

3.5 DESCRIPTION OF SUPPORT UNITS

The EUT has been tested as an independent unit together with other necessary accessories or support units. The following support units or accessories were used to form a representative test configuration during the tests.

Item	Equipment	Mfr/Brand	Model/Type No.	FCC ID	Series No.
A	DC Power Source	TRUE-POWER	GPC30300N	N/A	N/A
B	Test Fixture	N/A	N/A	N/A	N/A
C	Test Fixture	N/A	N/A	N/A	N/A
D	Notebook	DELL	DCSM	DOC	G7K832X

Item	Shielded Type	Ferrite Core	Length	Note
1	NO	NO	1m	DC Cable
2	NO	NO	10m	RJ45 Cable

4. EMC EMISSION TEST

4.1 RADIATED EMISSION MEASUREMENT

4.1.1 RADIATED EMISSION LIMITS

In case the emission fall within the restricted band specified on 15.205(a), then the 15.209(a) limit in the table below has to be followed.

Frequencies (MHz)	Field Strength (microrvolts/meter)	Measurement Distance (meters)
0.009~0.490	2400/F(kHz)	300
0.490~1.705	24000/F(kHz)	30
1.705~30.0	30	30
30~88	100	3
88~216	150	3
216~960	200	3
Above 960	500	3

Frequencies (MHz)	EIRP Limit (dBm)	Band edge at 3m (dBμV/m)	Harmonic at 1.5m (dBμV/m)
5150-5250	-27	68.3	74.3 (Note 3)
5250-5350	-27	68.3	74.3 (Note 3)
5470-5600 5650-5725	-27	68.3	74.3 (Note 3)
5725-5850	-27(Note 2)	68.3	74.3 (Note 3)
	10(Note 2)	105.3	111.3(Note 3)
	15.6(Note 2)	110.9	116.9(Note 3)
	27(Note 2)	122.3	128.3(Note 3)

Note:

- The following formula is used to convert the equipment isotropic radiated power (eirp) to field strength:

$$E = \frac{1000000\sqrt{30P}}{3} \mu\text{V/m, where P is the eirp (Watts)}$$

- According to FCC 16-24, All emissions shall be limited to a level of -27 dBm/MHz at 75 MHz or more above or below the band edge increasing linearly to 10 dBm/MHz at 25 MHz above or below the band edge, and from 25MHz above or below the band edge increasing linearly to a level of 15.6 dBm/MHz at 5 MHz above or below the band edge, and from 5 MHz above or below the band edge increasing linearly to a level of 27dBm/MHz at the band edge.

$$FS_{\text{limit}} = FS_{\text{max}} - 20\log\left(\frac{d_{\text{limit}}}{d_{\text{measure}}}\right)$$

3. $20\log d_{\text{limit}}/d_{\text{measure}}=20\log 3/1.5=6\text{dB.}$

4.1.2 TEST PROCEDURE

- a. The measuring distance of 3 m shall be used for measurements. The EUT was placed on the top of a rotating table 0.8 meter above the ground at a 3 meter semi-anechoic chamber. The table was rotated 360 degrees to determine the position of the highest radiation.(below 1GHz)
- b. The measuring distance of 3 m or 1.5m shall be used for measurements. The EUT was placed on the top of a rotating table 1.5 meter above the ground at a 3 meter semi-anechoic chamber. The table was rotated 360 degrees to determine the position of the highest radiation.(above 1GHz)
- c. The height of the equipment or of the substitution antenna shall be 0.8m or 1.5m; the height of the test antenna shall vary between 1 m to 4 m. Both horizontal and vertical polarizations of the antenna are set to make the measurement.
- d. For each suspected emission, the EUT was arranged to its worst case and then the antenna was tuned to heights find the maximum reading (used Bore sight function).
- e. The receiver system was set to peak and average detect function and specified bandwidth with maximum hold mode when the test frequency is above 1GHz.
- f. The initial step in collecting radiated emission data is a receiver peak detector mode pre-scanning the measurement frequency range. Significant peaks are then marked and then Quasi Peak detector mode re-measured.
- g. All readings are Peak unless otherwise stated QP in column of Note. Peak denotes that the Peak reading compliance with the QP Limits and then QP Mode measurement didn't perform. (below 1GHz)
- h. All readings are Peak Mode value unless otherwise stated AVG in column of Note. If the Peak Mode Measured value compliance with the Peak Limits and lower than AVG Limits, the EUT shall be deemed to meet both Peak & AVG Limits and then only Peak Mode was measured, but AVG Mode didn't perform. (above 1GHz)
- i. For the actual test configuration, please refer to the related Item –EUT Test Photos.

4.1.3 DEVIATION FROM TEST STANDARD

No deviation

4.1.4 TEST SETUP

(A)Radiated Emission Test Set-Up Frequency Below 1GHz

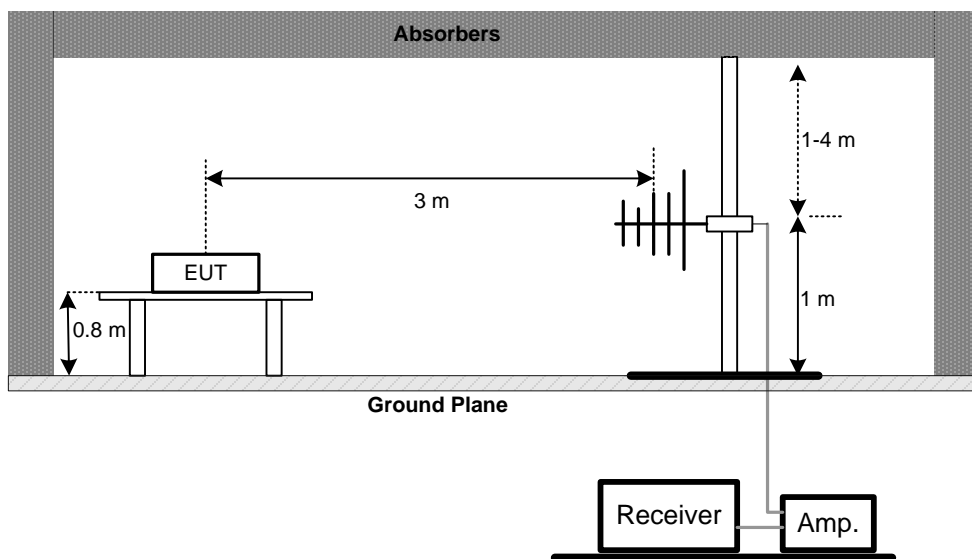

(B) Radiated Emission Test Set-Up Frequency Above 1 GHz

Band edge

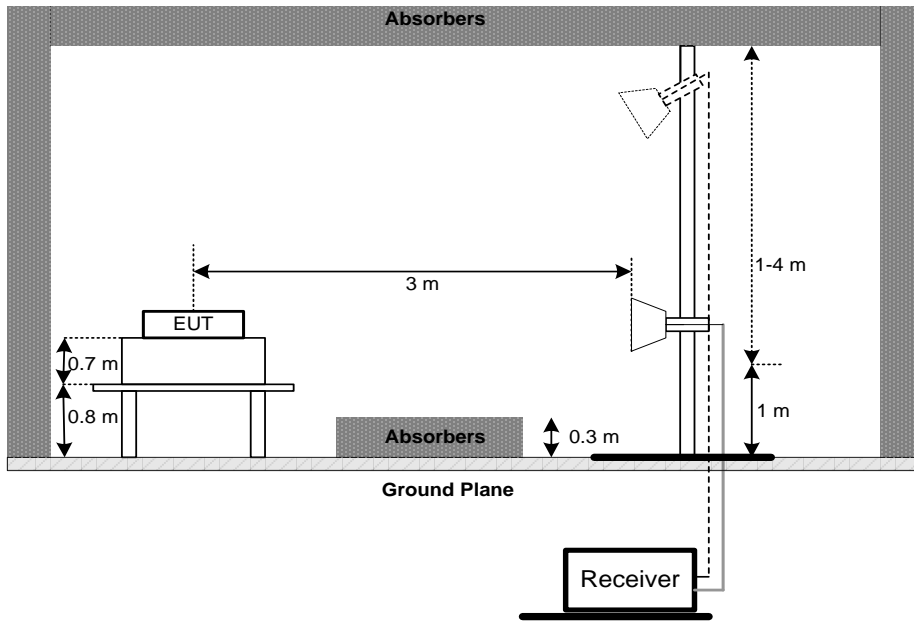

Harmonic

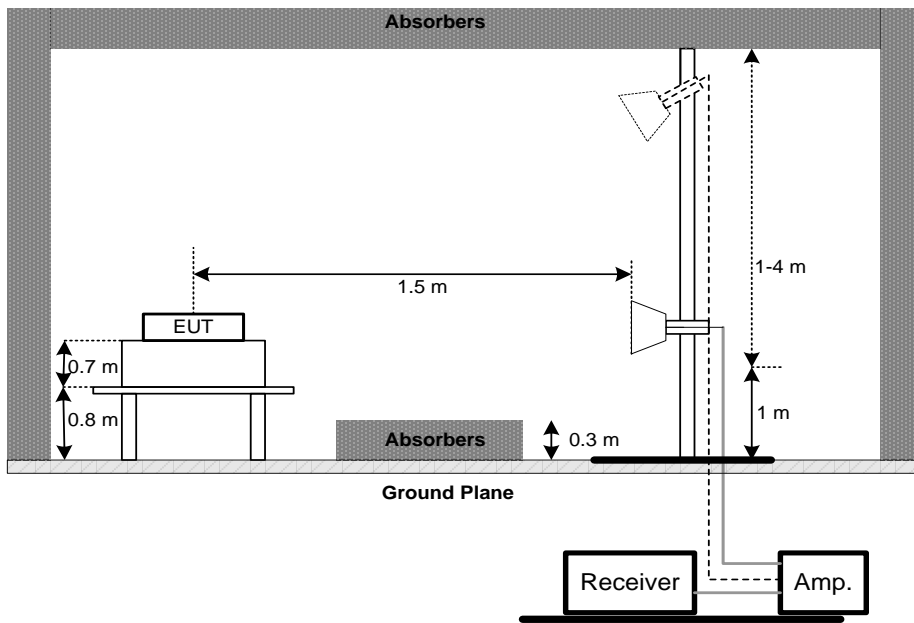

(C) Radiated emissions below 30MHz

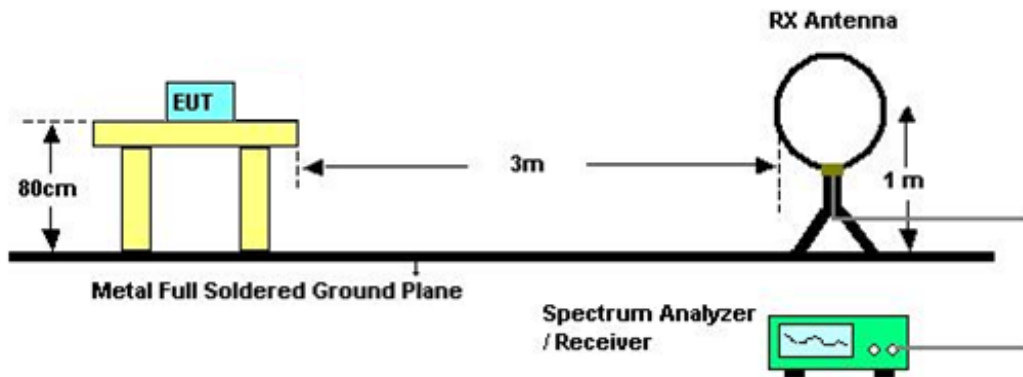

4.1.5 EUT OPERATING CONDITIONS

The EUT tested system was configured as the statements of 4.1.5 unless otherwise a special operating condition is specified in the follows during the testing.

4.1.6 EUT TEST CONDITIONS

Temperature: 25°C Relative Humidity: 60% Test Voltage: DC 13.5V

4.1.7 TEST RESULTS (9K TO 30MHz)

Please refer to the Appendix A

Remark:

- (1) The amplitude of spurious emissions which are attenuated by more than 20 dB below the permissible value has no need to be reported.
- (2) Distance extrapolation factor = $40 \log(\text{specific distance} / \text{test distance})$ (dB);
- (3) Limit line = specific limits (dBuV) + distance extrapolation factor.

4.1.8 TEST RESULTS (BETWEEN 30 TO 1000 MHz)

Please refer to the Appendix B.

4.1.9 TEST RESULTS (ABOVE 1000 MHz)

Please refer to the Appendix C.

Remark:

- (1) No limit: This is fundamental signal, the judgment is not applicable.
For fundamental signal judgment was referred to Peak output test.

5. 26dB SPECTRUM BANDWIDTH

5.1 APPLIED PROCEDURES / LIMIT

FCC Part15, Subpart E			
Test Item	Limit	Frequency Range (MHz)	Result
Bandwidth	26 dB Bandwidth	5150-5250	PASS
	26 dB Bandwidth	5250-5350	PASS
	26 dB Bandwidth	5470-5600 5650-5725	PASS
	Minimum 500kHz 6dB Bandwidth	5725-5850	PASS

5.1.1 TEST PROCEDURE

a. The EUT was directly connected to the spectrum analyzer and antenna output port as show in the block diagram below,

b.

Spectrum Parameters	Setting
Attenuation	Auto
Span Frequency	> 26dB Bandwidth
RBW	300 kHz(Bandwidth 20MHz) 1MHz(Bandwidth 40MHz and 80MHz)
VBW	1MHz(Bandwidth 20MHz) 3MHz(Bandwidth 40MHz and 80MHz)
Detector	Peak
Trace	Max Hold
Sweep Time	Auto

c. Measured the spectrum width with power higher than 26dB below carrier

5.1.2 DEVIATION FROM STANDARD

No deviation.

5.1.3 TEST SETUP



5.1.4 EUT OPERATION CONDITIONS

The EUT tested system was configured as the statements of 4.1.5 unless otherwise a special operating condition is specified in the follows during the testing.

5.1.5 EUT TEST CONDITIONS

Temperature: 25°C Relative Humidity: 60% Test Voltage: DC 13.5V

5.1.6 TEST RESULTS

Please refer to the Appendix D.

6. MAXIMUM AVERAGE OUTPUT POWER

6.1 APPLIED PROCEDURES / LIMIT

FCC Part15, Subpart E			
Test Item	Limit	Frequency Range (MHz)	Result
Average Output Power	Fixed:1 Watt (30dBm) Mobile and portable: 250mW (24dBm)	5150-5250	PASS
	250mW (24dBm)	5250-5350	PASS
	250mW (24dBm)	5470-5600 5650-5725	PASS
	1 Watt (30dBm)	5725-5850	PASS
	Note: The maximum e.i.r.p at anyelevation angle above 30 degrees as measured from the horizon must not exceed 125mW(21dBm)		

6.1.1 TEST PROCEDURE

- a. The EUT was directly connected to the spectrum analyzer and antenna output port as show in the block diagram below,
- b. Test was performed in accordance with method of KDB 789033 D02.

6.1.2 DEVIATION FROM STANDARD

No deviation.

6.1.3 TEST SETUP

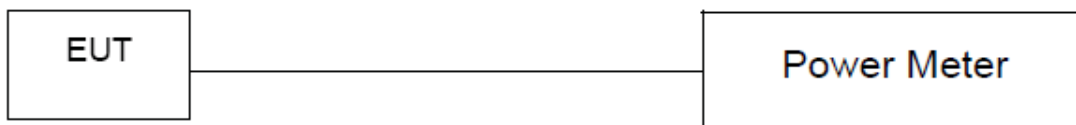

6.1.4 EUT OPERATION CONDITIONS

The EUT tested system was configured as the statements of 4.1.5 unless otherwise a special operating condition is specified in the follows during the testing.

6.1.5 EUT TEST CONDITIONS

Temperature: 25°C Relative Humidity: 60% Test Voltage: DC 13.5V

6.1.6 TEST RESULTS

Please refer to the Appendix E.

7. POWER SPECTRAL DENSITY TEST

7.1 APPLIED PROCEDURES / LIMIT

FCC Part15, Subpart E			
Test Item	Limit	Frequency Range (MHz)	Result
Power Spectral Density	Other than Mobile and portable:17dBm/MHz Mobile and portable:11dBm/MHz	5150-5250	PASS
	11dBm/MHz	5250-5350	PASS
	11dBm/MHz	5470-5600 5650-5725	PASS
	30dBm/500kHz	5725-5850	PASS

8.1.1 TEST PROCEDURE

a. The EUT was directly connected to the spectrum analyzer and antenna output port as show in the block diagram below,

b.

Spectrum Parameter	Setting
Attenuation	Auto
Span Frequency	Encompass the entire emissions bandwidth (EBW) of the signal
RBW	= 1MHz.
VBW	≥ 3MHz.
Detector	RMS
Trace average	100 trace
Sweep Time	Auto

Note:

1. For UNII-3, according to KDB publication 789033 D02 General UNII Test Procedures New Rules v01r02, section II.F.5., it is acceptable to set RBW at 1MHz and VBW at 3MHz if the spectrum analyzer does not have 500kHz RBW.
2. The value measured with RBW=1MHz is to be added with $10\log(500\text{kHz}/1\text{MHz})$ which is -3dB. For example, if the measured value is +10dBm using RBW=1MHz (that is +10dBm/MHz), then the converted value will be +7dBm/500kHz.

7.1.1 DEVIATION FROM STANDARD

No deviation.

7.1.2 TEST SETUP



7.1.3 EUT OPERATION CONDITIONS

The EUT tested system was configured as the statements of 4.1.5 unless otherwise a special operating condition is specified in the follows during the testing.

7.1.4 EUT TEST CONDITIONS

Temperature: 25°C Relative Humidity: 60% Test Voltage: DC 13.5V

7.1.5 TEST RESULTS

Please refer to the Appendix F.

8. FREQUENCY STABILITY MEASUREMENT

8.1 APPLIED PROCEDURES / LIMIT

FCC Part15, Subpart E			
Test Item	Limit	Frequency Range (MHz)	Result
Frequency Stability	Specified in the user's manual	5150-5250	PASS
		5250-5350	PASS
		5470-5600	PASS
		5650-5725	PASS
		5725-5850	PASS

8.1.1 TEST PROCEDURE

a. The EUT was directly connected to the spectrum analyzer and antenna output port as show in the block diagram below,

b.

Spectrum Parameter	Setting
Attenuation	Auto
Span Frequency	Entire absence of modulation emissions bandwidth
RBW	10 kHz
VBW	10 kHz
Sweep Time	Auto

c. For the test extreme voltage , the lowest is 9V and the highest is 16V.
d. User manual temperature is -30°C~70°C.

8.1.2 DEVIATION FROM STANDARD

No deviation.

8.1.3 TEST SETUP

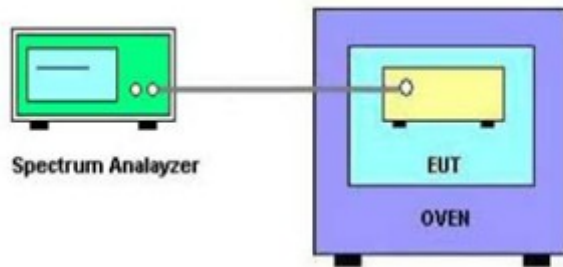

8.1.4 EUT OPERATION CONDITIONS

The EUT tested system was configured as the statements of 4.1.5 unless otherwise a special operating condition is specified in the follows during the testing.

8.1.5 EUT TEST CONDITIONS

Temperature: 25°C Relative Humidity: 55% Test Voltage: DC 13.5V

8.1.6 TEST RESULTS

Please refer to the Appendix G.

9. MEASUREMENT INSTRUMENTS LIST

Radiated Emission Measurement - Below 1GHz					
Item	Kind of Equipment	Manufacturer	Type No.	Serial No.	Calibrated until
1	Antenna	Schwarzbeck	VULB9160	9160-3232	Mar. 11, 2019
2	Amplifier	HP	8447D	2944A09673	Oct. 19, 2018
3	Receiver	Agilent	N9038A	MY52130039	Aug. 20, 2018
4	Cable	emci	LMR-400(30MHz-1GHz)(8m+5m)	N/A	May. 25, 2019
5	Controller	CT	SC100	N/A	N/A
6	Controller	MF	MF-7802	MF780208416	N/A
7	Measurement Software	Farad	EZ-EMC Ver.NB-03A1-01	N/A	N/A
8	Antenna	EM	EM-6876-1	230	Feb. 07, 2019

Radiated Emission Measurement - Above 1GHz					
Item	Kind of Equipment	Manufacturer	Type No.	Serial No.	Calibrated until
1	Double Ridged Guide Antenna	ETS	3115	75789	Mar. 11, 2019
2	Broad-Band Horn Antenna	Schwarzbeck	BBHA 9170	9170319	Jun. 30, 2019
3	Amplifier	Agilent	8449B	3008A02274	Mar. 11, 2019
4	Microwave Preampifier With Adaptor	EMC INSTRUMENT	EMC2654045	980039 & HA01	Mar. 11, 2019
5	Receiver	Agilent	N9038A	MY52130039	Aug. 20, 2018
6	Controller	CT	SC100	N/A	N/A
7	Controller	MF	MF-7802	MF780208416	N/A
8	Cable	N/A	CA500-SMSM-12M (1-26.5GHz)	N/A	Sep. 29, 2018
9	Measurement Software	Farad	EZ-EMC Ver.NB-03A1-01	N/A	N/A

Spectrum Bandwidth Measurement					
Item	Kind of Equipment	Manufacturer	Type No.	Serial No.	Calibrated until
1	Spectrum Analyzer	R&S	FSP40	100185	Aug. 20, 2018

Maximum Average Output Power Measurement					
Item	Kind of Equipment	Manufacturer	Type No.	Serial No.	Calibrated until
1	Cable	emci	EMC104-SM-SM-900 0(0.01GHz – 26.5GHz)	N/A	N/A
2	Power Sensor	Agilent	U2021XA	MY53020007	Mar. 11, 2019
3	Measurement Software	Keysight	EN301893V2.1.1(V2.1 51229)	N/A	N/A

Power Spectral Density Measurement					
Item	Kind of Equipment	Manufacturer	Type No.	Serial No.	Calibrated until
1	Spectrum Analyzer	R&S	FSP40	100185	Aug. 20, 2018

Frequency Stability Measurement					
Item	Kind of Equipment	Manufacturer	Type No.	Serial No.	Calibrated until
1	Spectrum Analyzer	R&S	FSP40	100185	Aug. 20, 2018
2	Precision Oven Tester	Bell	BTH-50C	20170306001	Mar. 11, 2019

Remark: "N/A" denotes no model name, serial no. or calibration specified.
All calibration period of equipment list is one year.

10. EUT TEST PHOTOS

Radiated Measurement Photos

9kHz to 30MHz



Radiated Measurement Photos

30MHz to 1000MHz

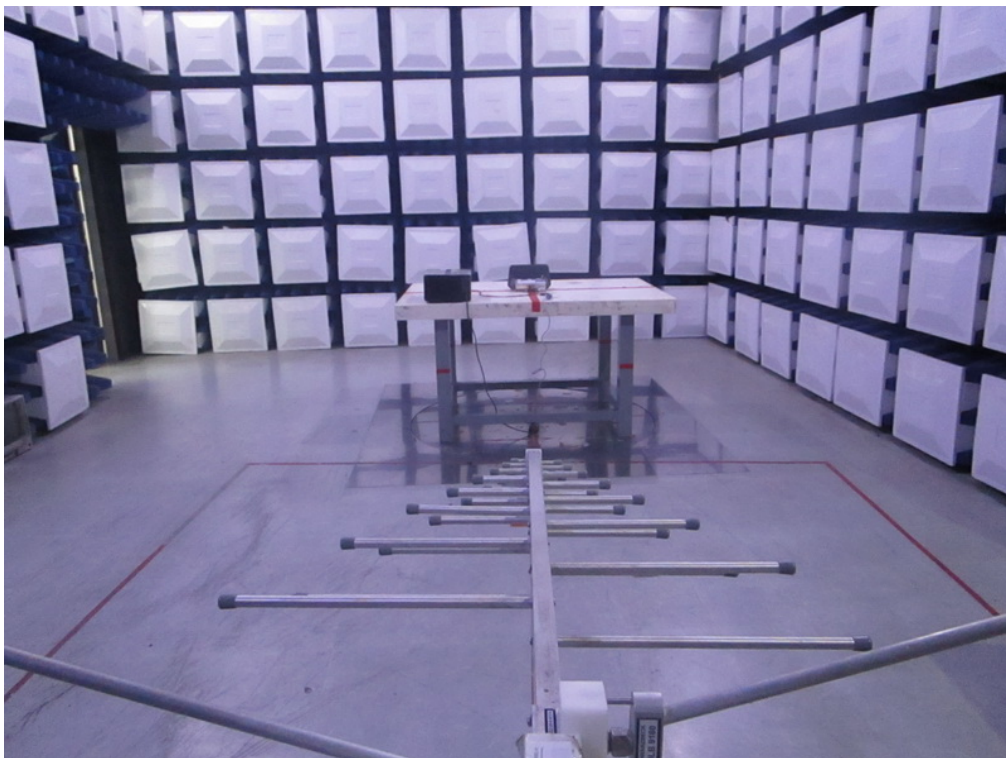
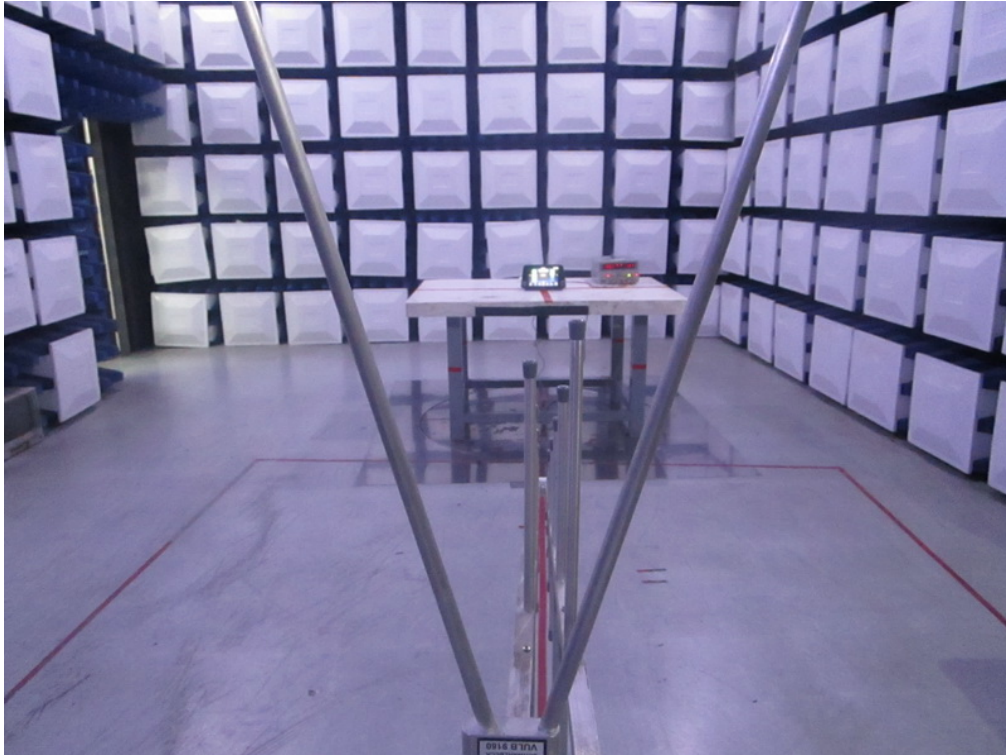

Radiated Measurement Photos

1GHz to 18GHz

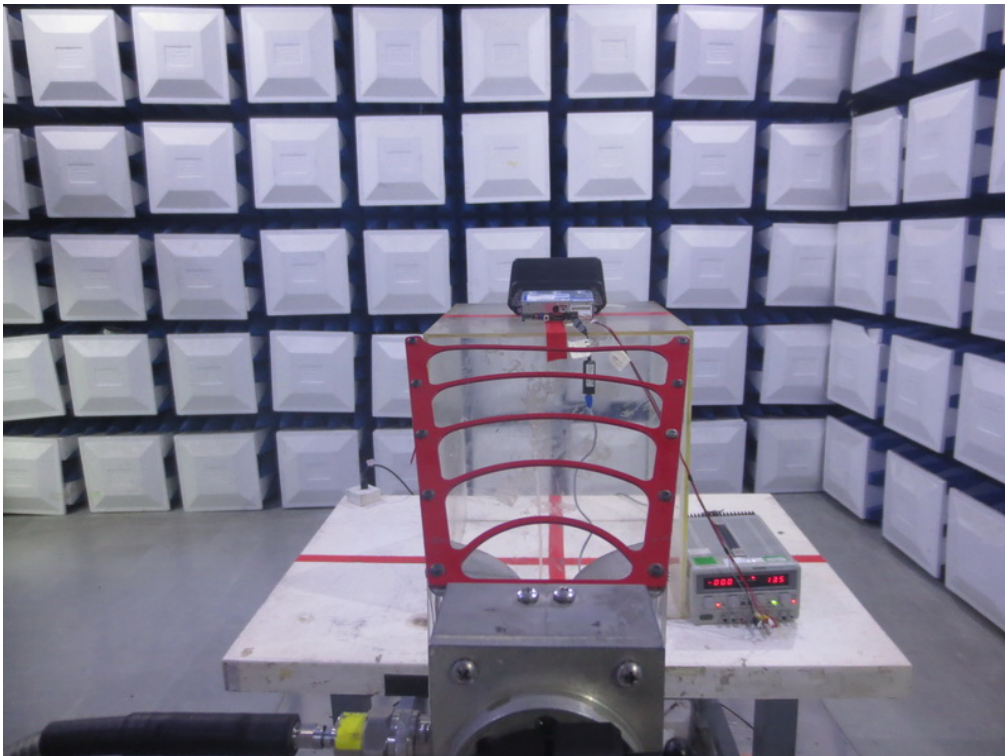
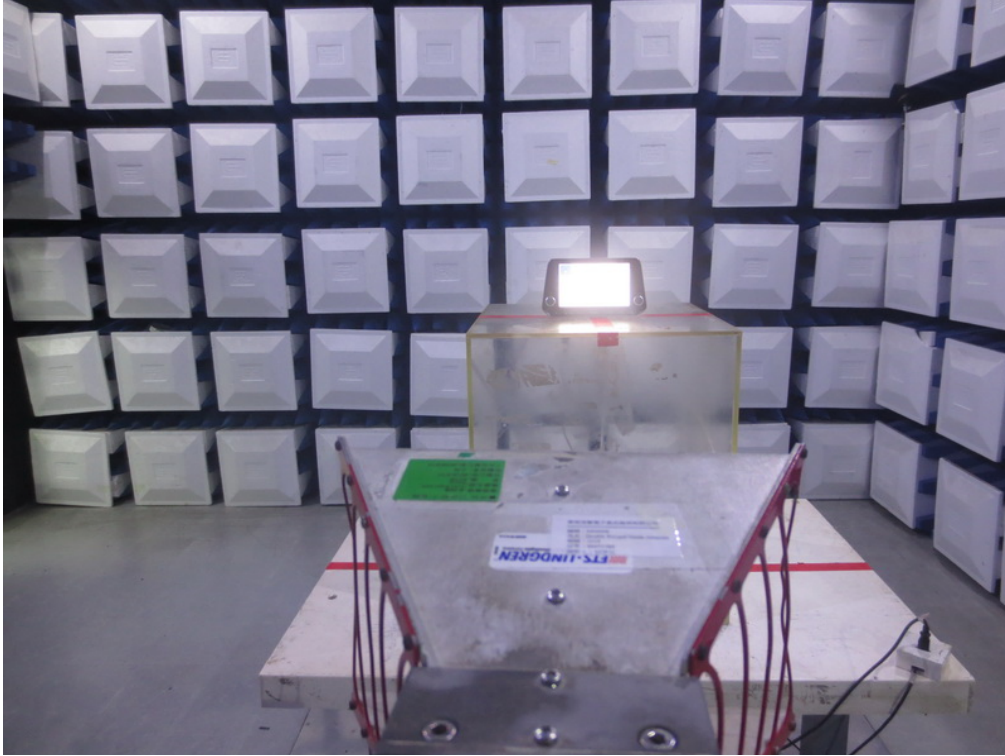

Radiated Measurement Photos

18GHz to 40GHz

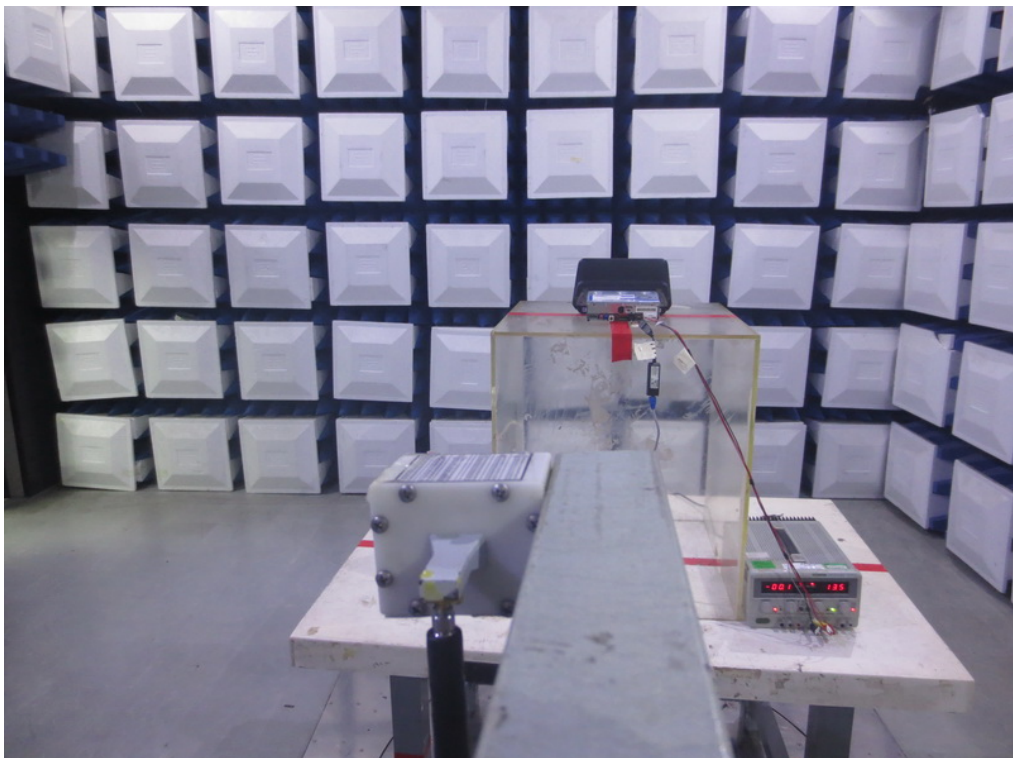
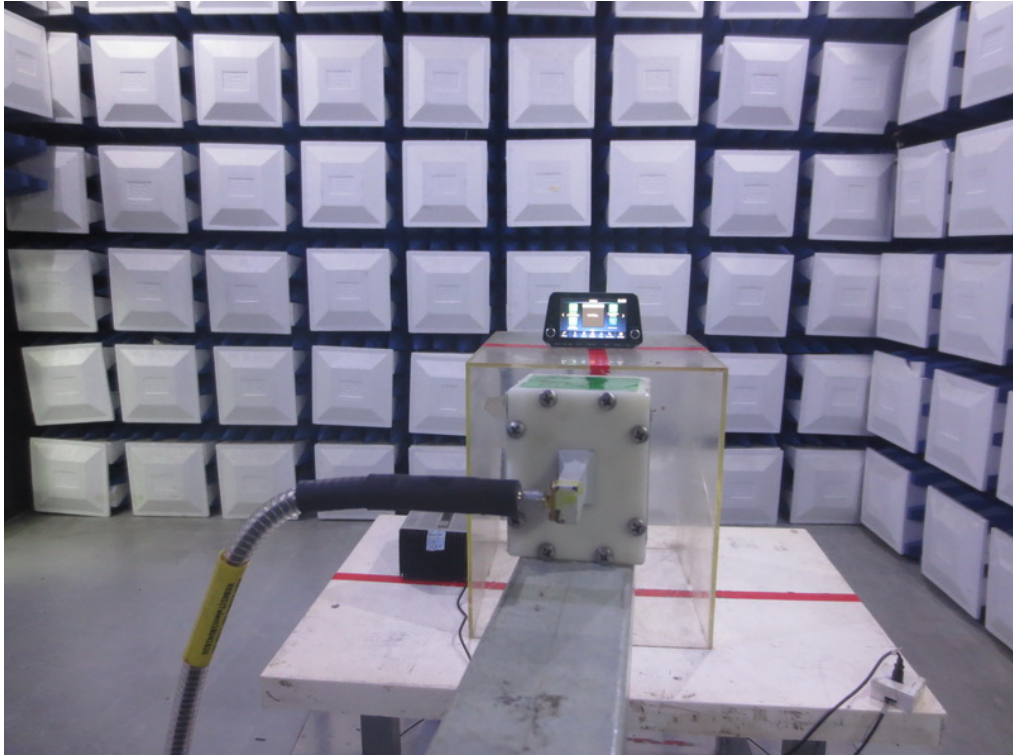

Band Edge Measurement Photos

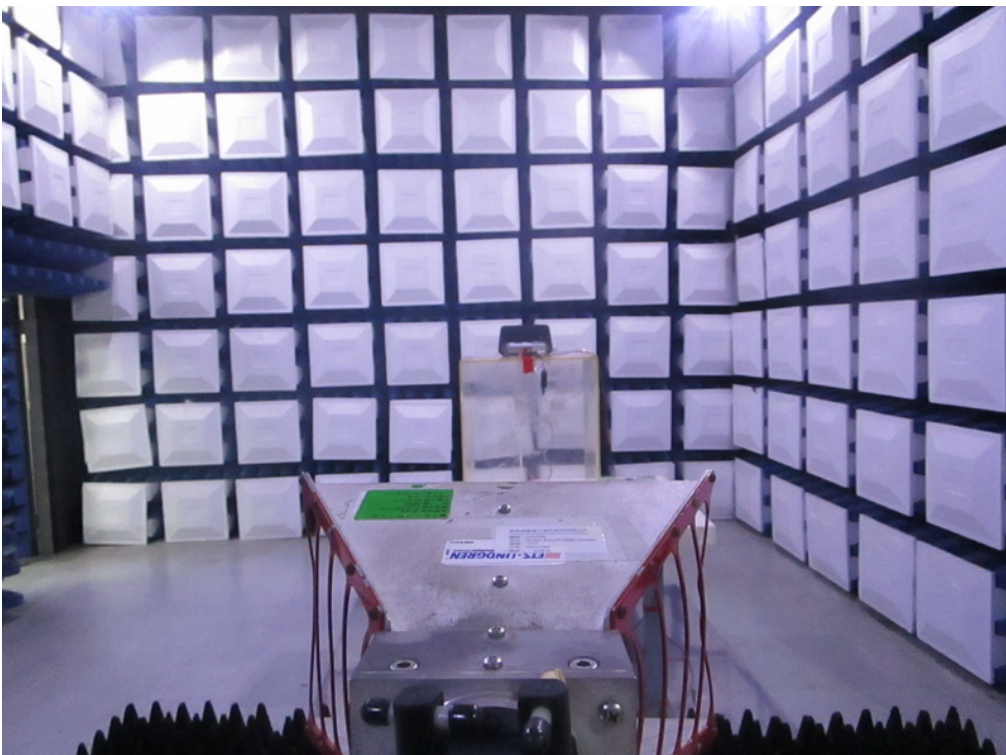

APPENDIX A - RADIATED EMISSION (9KHZ TO 30MHZ)

Test Mode: TX MODE

Ant 0°

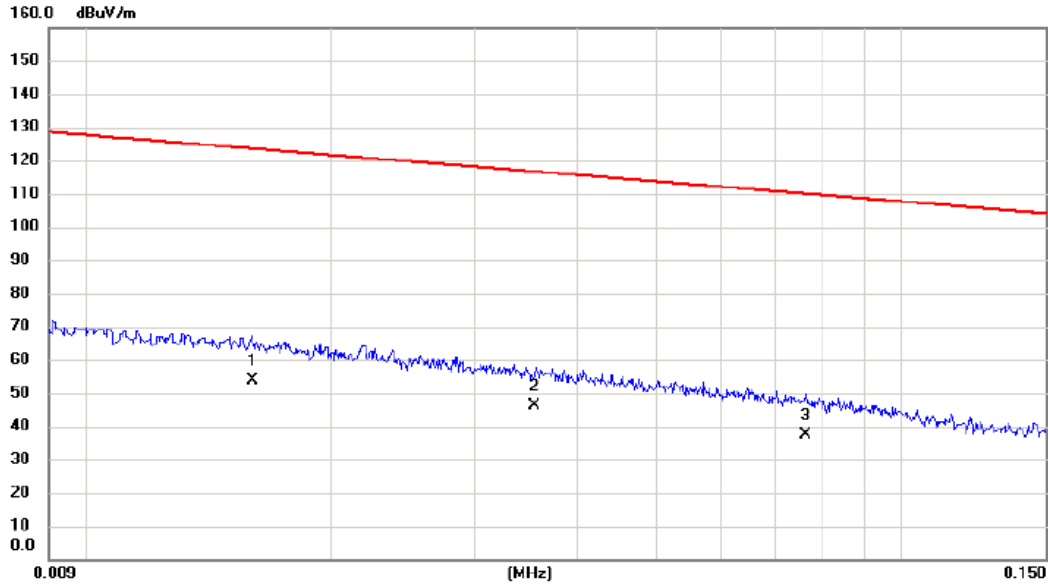

No.	Mk.	Freq. MHz	Reading Level dBuV	Correct Factor dB	Measure- ment dBuV/m	Limit dBuV/m	Margin dB	Detector	Comment
1	*	0.0160	33.21	20.58	53.79	123.52	-69.73	AVG	
2		0.0355	26.50	19.76	46.26	116.60	-70.34	AVG	
3		0.0761	18.60	19.00	37.60	109.98	-72.38	AVG	

Test Mode: TX MODE

Ant 0°

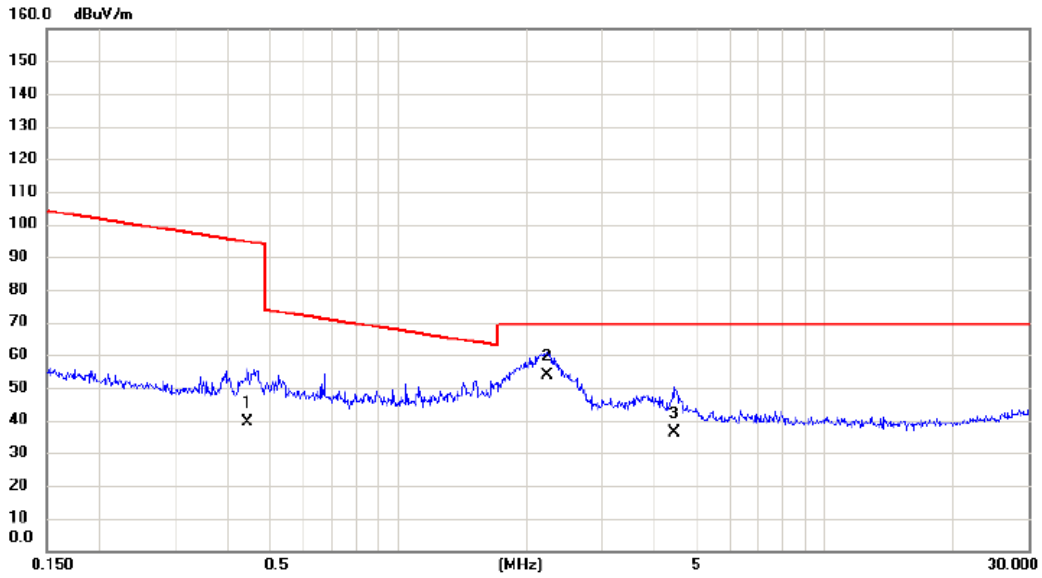

No.	Mk.	Freq. MHz	Reading Level dBuV	Correct Factor dB	Measure- ment dBuV/m	Limit dBuV/m	Margin dB	Detector	Comment
1		0.4444	22.50	16.99	39.49	94.65	-55.16	AVG	
2	*	2.2367	36.80	16.97	53.77	69.54	-15.77	QP	
3		4.4305	20.60	15.50	36.10	69.54	-33.44	QP	

Test Mode: TX MODE

Ant 90°

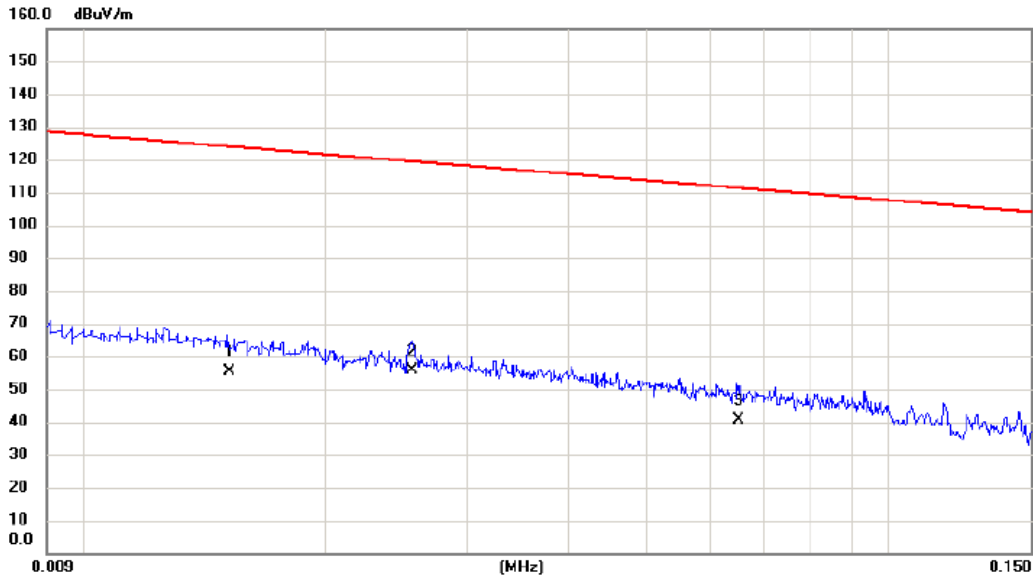

No.	Mk.	Freq. MHz	Reading Level dBuV	Correct Factor dB	Measure- ment dBuV/m	Limit dBuV/m	Margin dB	Detector	Comment
1		0.0152	34.80	20.69	55.49	123.97	-68.48	AVG	
2	*	0.0256	35.70	19.93	55.63	119.44	-63.81	AVG	
3		0.0650	21.40	19.23	40.63	111.35	-70.72	AVG	

Test Mode: TX MODE

Ant 90°

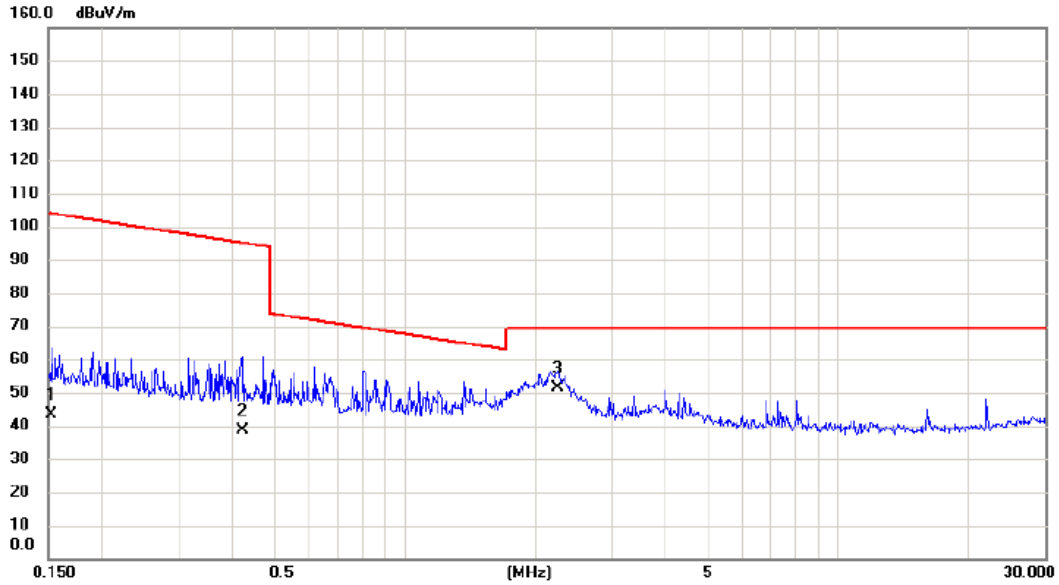

No.	Mk.	Freq. MHz	Reading Level dBuV	Correct Factor dB	Measure- ment dBuV/m	Limit dBuV/m	Margin dB	Detector	Comment
1		0.1532	26.30	17.24	43.54	103.90	-60.36	AVG	
2		0.4214	21.80	17.00	38.80	95.11	-56.31	AVG	
3	*	2.2486	34.60	16.96	51.56	69.54	-17.98	QP	

APPENDIX B - RADIATED EMISSION (30MHZ TO 1000MHZ)

Test Mode: UNII-1/TX A Mode 5180MHz

Vertical

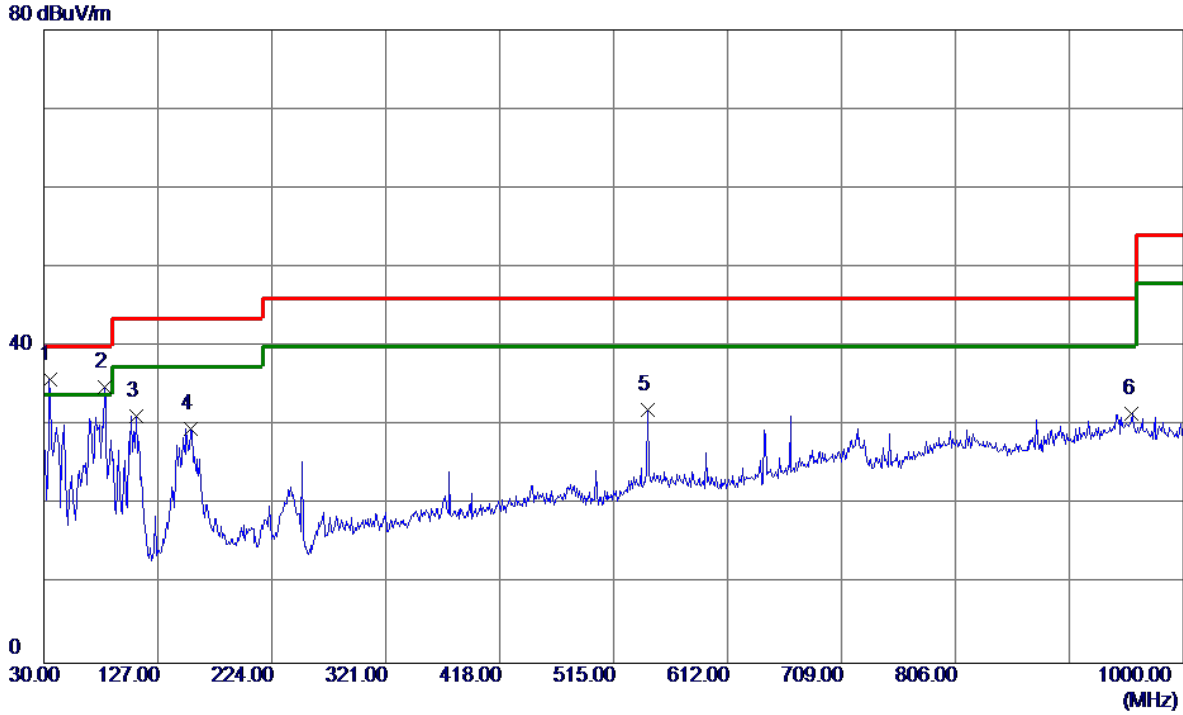

No.	Freq. MHz	Reading Level dBuV/m	Correct Factor dB	Measure ment dBuV/m	Limit dBuV/m	Margin dB	Detector	Comment
1 *	34.8500	50.66	-14.89	35.77	40.00	-4.23	Peak	
2	81.4100	53.62	-18.73	34.89	40.00	-5.11	Peak	
3	108.5700	47.83	-16.57	31.26	43.50	-12.24	Peak	
4	155.1300	40.58	-11.03	29.55	43.50	-13.95	Peak	
5	544.1000	37.89	-5.82	32.07	46.00	-13.93	Peak	
6	956.3500	30.26	1.26	31.52	46.00	-14.48	Peak	

Test Mode: UNII-1/TX A Mode 5180MHz

Horizontal

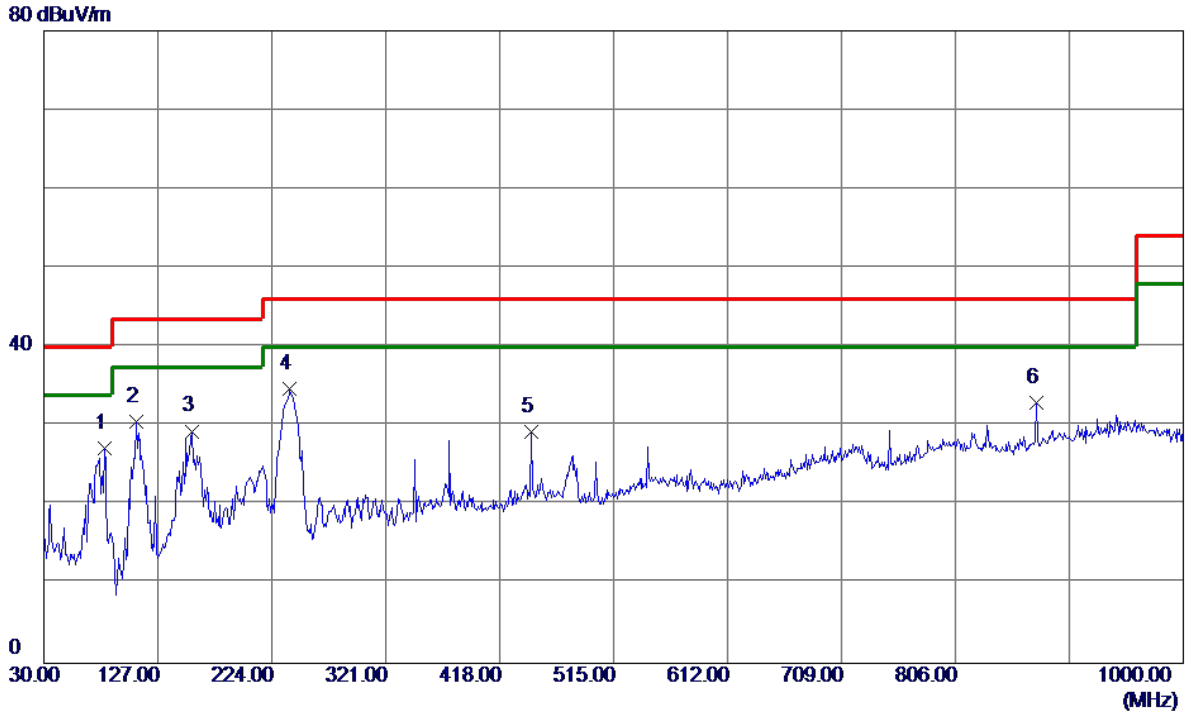

No.	Freq. MHz	Reading Level dBuV/m	Correct Factor dB	Measure ment dBuV/m	Limit dBuV/m	Margin dB	Detector	Comment
1	81.4100	45.99	-18.73	27.26	40.00	-12.74	Peak	
2	108.5700	47.13	-16.57	30.56	43.50	-12.94	Peak	
3	156.1000	40.31	-10.95	29.36	43.50	-14.14	Peak	
4 *	239.5200	49.40	-14.69	34.71	46.00	-11.29	Peak	
5	445.1600	36.83	-7.60	29.23	46.00	-16.77	Peak	
6	874.8700	34.17	-1.21	32.96	46.00	-13.04	Peak	

Test Mode: UNII-1/TX A Mode 5200MHz

Vertical

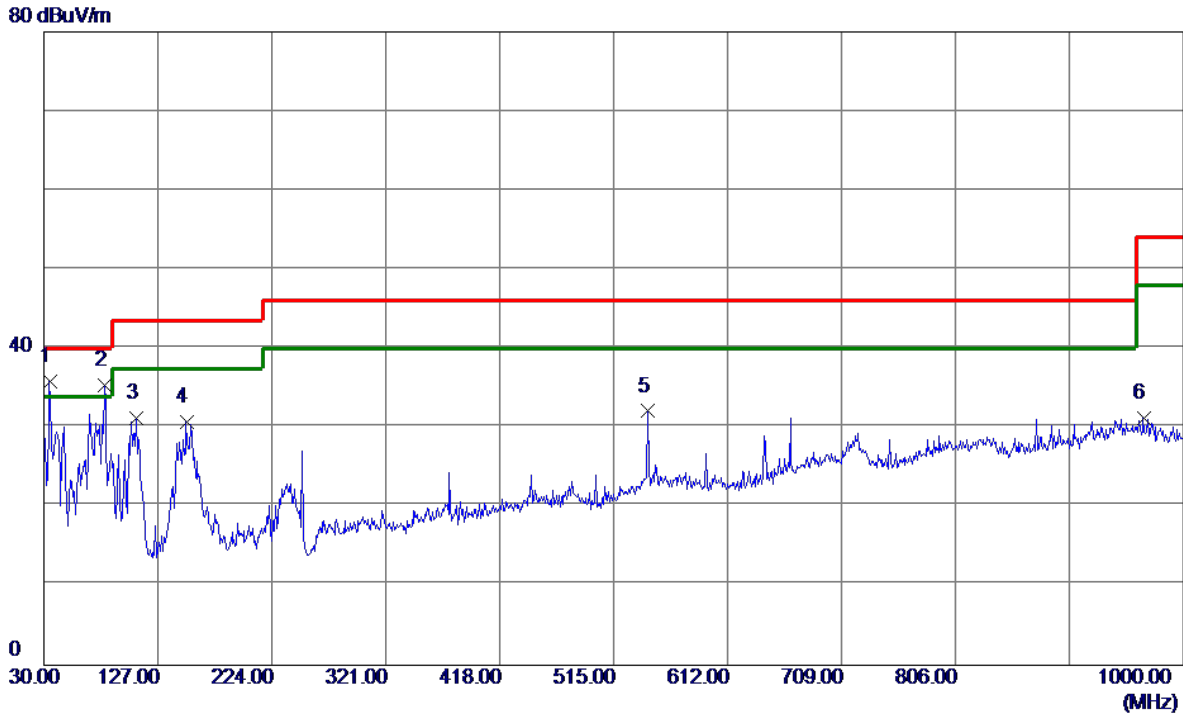

No.	Freq. MHz	Reading Level dBuV/m	Correct Factor dB	Measure ment dBuV/m	Limit dBuV/m	Margin dB	Detector	Comment
1 *	34.8500	50.78	-14.89	35.89	40.00	-4.11	Peak	
2	81.4100	54.10	-18.73	35.37	40.00	-4.63	Peak	
3	108.5700	47.75	-16.57	31.18	43.50	-12.32	Peak	
4	151.2500	42.04	-11.38	30.66	43.50	-12.84	Peak	
5	544.1000	37.90	-5.82	32.08	46.00	-13.92	Peak	
6	966.0500	30.18	1.03	31.21	54.00	-22.79	Peak	

Test Mode: UNII-1/TX A Mode 5200MHz

Horizontal

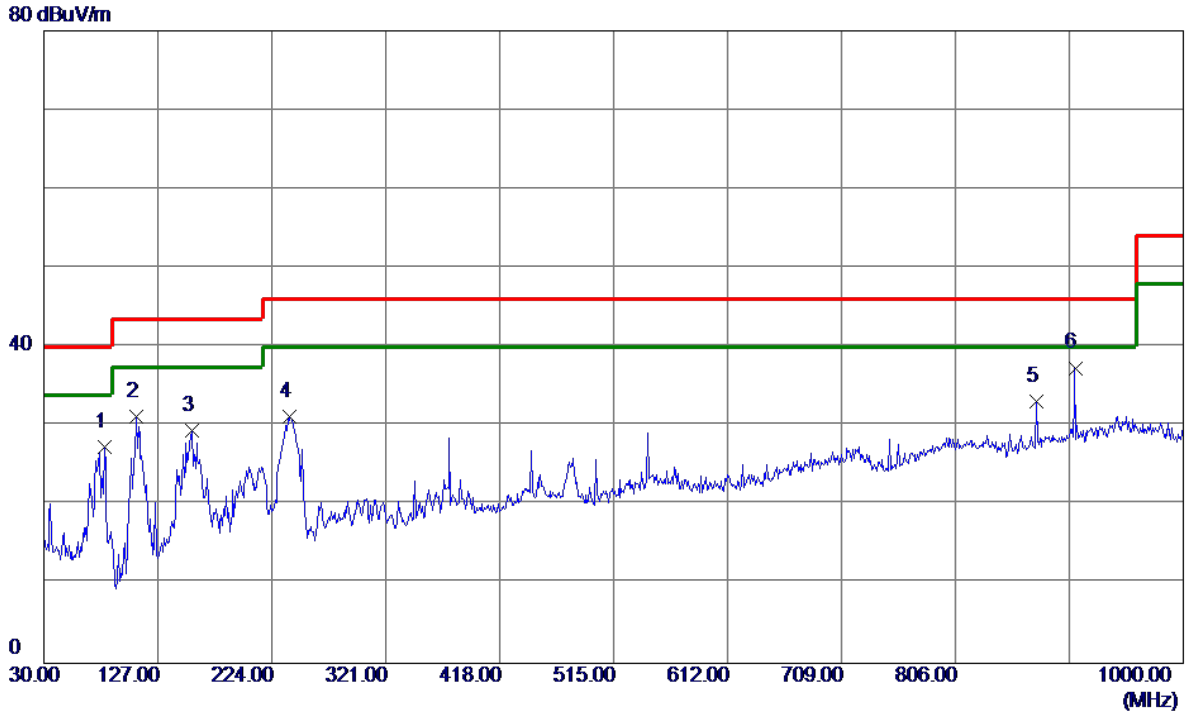

No.	Freq. MHz	Reading Level dBuV/m	Correct Factor dB	Measure ment dBuV/m	Limit dBuV/m	Margin dB	Detector	Comment
1	81.4100	46.14	-18.73	27.41	40.00	-12.59	Peak	
2	108.5700	47.78	-16.57	31.21	43.50	-12.29	Peak	
3	156.1000	40.32	-10.95	29.37	43.50	-14.13	Peak	
4	239.5200	45.86	-14.69	31.17	46.00	-14.83	Peak	
5	874.8700	34.29	-1.21	33.08	46.00	-12.92	Peak	
6 *	907.8500	37.64	-0.28	37.36	46.00	-8.64	Peak	

Test Mode: UNII-1/TX A Mode 5240MHz

Vertical

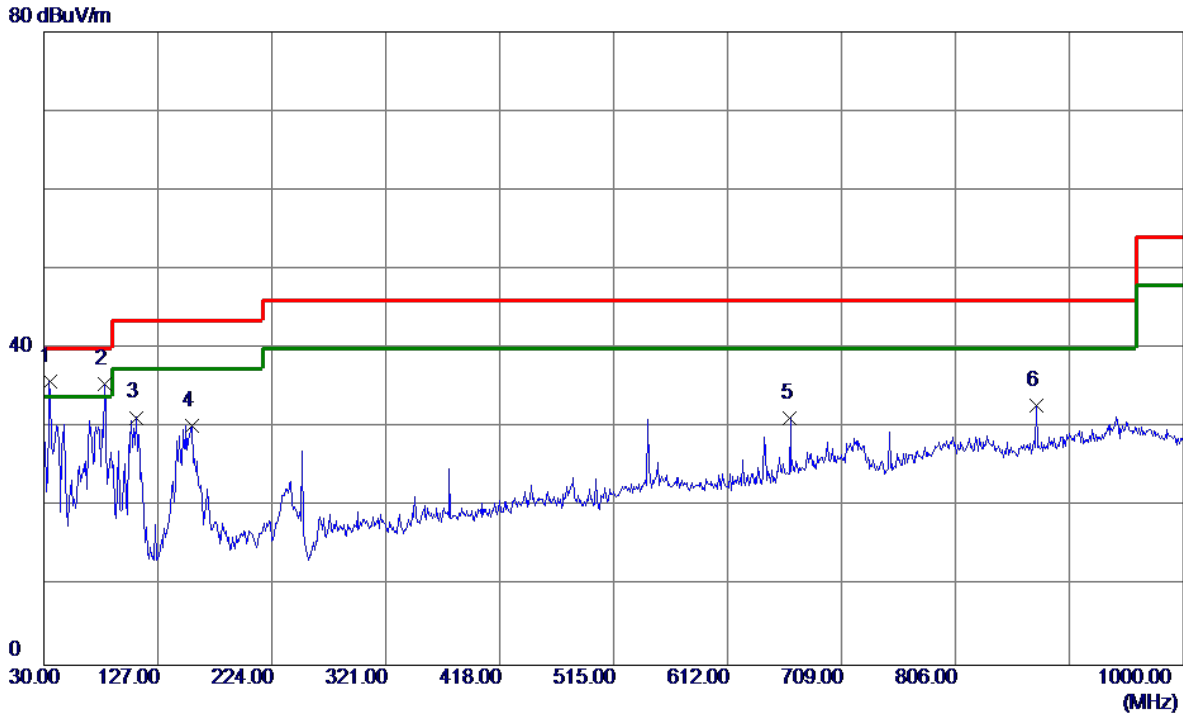

No.	Freq. MHz	Reading Level dBuV/m	Correct Factor dB	Measure ment dBuV/m	Limit dBuV/m	Margin dB	Detector	Comment
1 *	34.8500	50.72	-14.89	35.83	40.00	-4.17	Peak	
2	81.4100	54.25	-18.73	35.52	40.00	-4.48	Peak	
3	108.5700	47.85	-16.57	31.28	43.50	-12.22	Peak	
4	156.1000	41.20	-10.95	30.25	43.50	-13.25	Peak	
5	665.3500	35.64	-4.43	31.21	46.00	-14.79	Peak	
6	874.8700	33.95	-1.21	32.74	46.00	-13.26	Peak	

Test Mode: UNII-1/TX A Mode 5240MHz

Horizontal

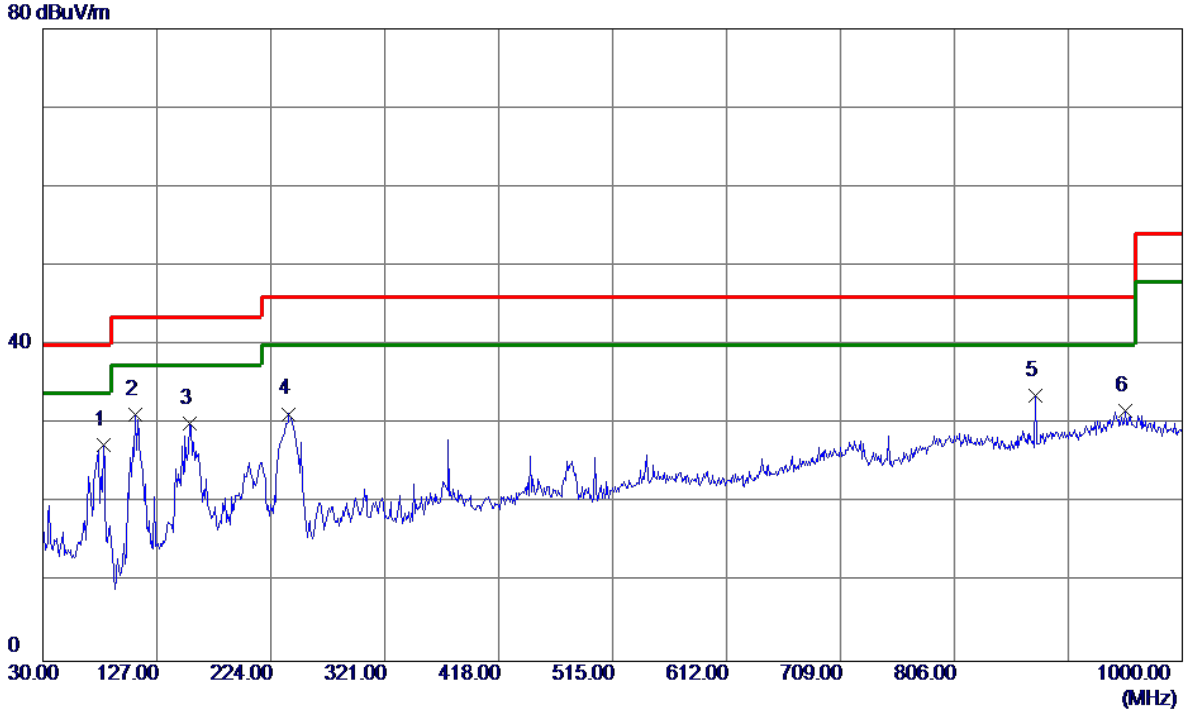

No.	Freq. MHz	Reading Level dBuV/m	Correct Factor dB	Measure ment dBuV/m	Limit dBuV/m	Margin dB	Detector	Comment
1	81.4100	46.08	-18.73	27.35	40.00	-12.65	Peak	
2 *	108.5700	47.79	-16.57	31.22	43.50	-12.28	Peak	
3	155.1300	41.17	-11.03	30.14	43.50	-13.36	Peak	
4	239.5200	45.97	-14.69	31.28	46.00	-14.72	Peak	
5	874.8700	34.80	-1.21	33.59	46.00	-12.41	Peak	
6	951.5000	30.25	1.37	31.62	46.00	-14.38	Peak	

Test Mode: UNII-2A/TX A Mode 5260MHz

Vertical

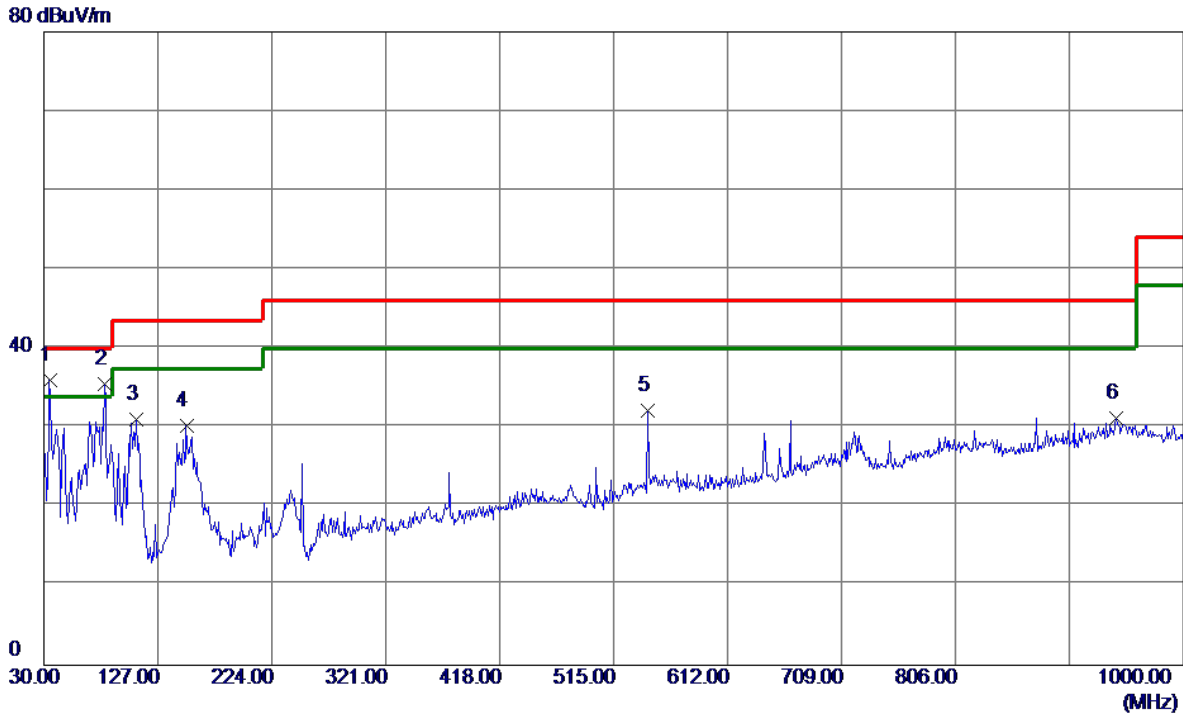

No.	Freq. MHz	Reading Level dBuV/m	Correct Factor dB	Measure ment dBuV/m	Limit dBuV/m	Margin dB	Detector	Comment
1 *	34.8500	50.91	-14.89	36.02	40.00	-3.98	Peak	
2	81.4100	54.26	-18.73	35.53	40.00	-4.47	Peak	
3	108.5700	47.58	-16.57	31.01	43.50	-12.49	Peak	
4	151.2500	41.61	-11.38	30.23	43.50	-13.27	Peak	
5	544.1000	37.94	-5.82	32.12	46.00	-13.88	Peak	
6	942.7700	30.13	1.12	31.25	46.00	-14.75	Peak	

Test Mode: UNII-2A/TX A Mode 5260MHz

Horizontal

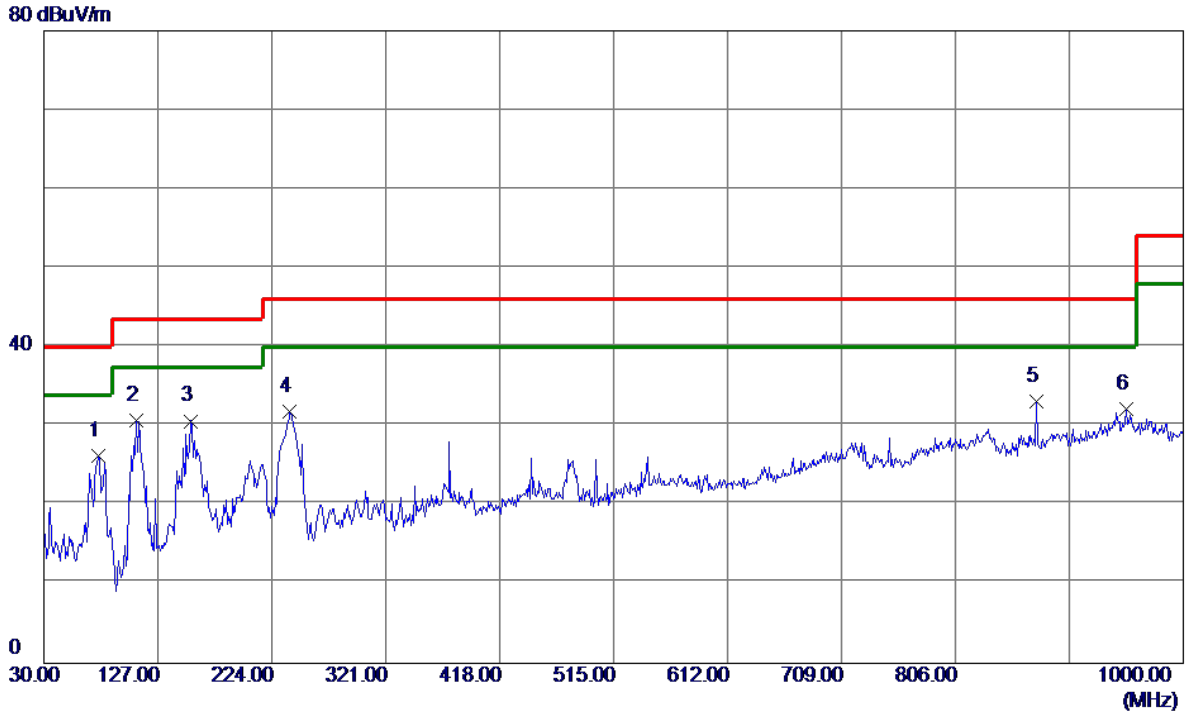

No.	Freq. MHz	Reading Level dBuV/m	Correct Factor dB	Measure ment dBuV/m	Limit dBuV/m	Margin dB	Detector	Comment
1	76.5600	44.69	-18.47	26.22	40.00	-13.78	Peak	
2 *	108.5700	47.30	-16.57	30.73	43.50	-12.77	Peak	
3	155.1300	41.67	-11.03	30.64	43.50	-12.86	Peak	
4	239.5200	46.47	-14.69	31.78	46.00	-14.22	Peak	
5	874.8700	34.30	-1.21	33.09	46.00	-12.91	Peak	
6	951.5000	30.75	1.37	32.12	46.00	-13.88	Peak	

Test Mode: UNII-2A/TX A Mode 5280MHz

Vertical

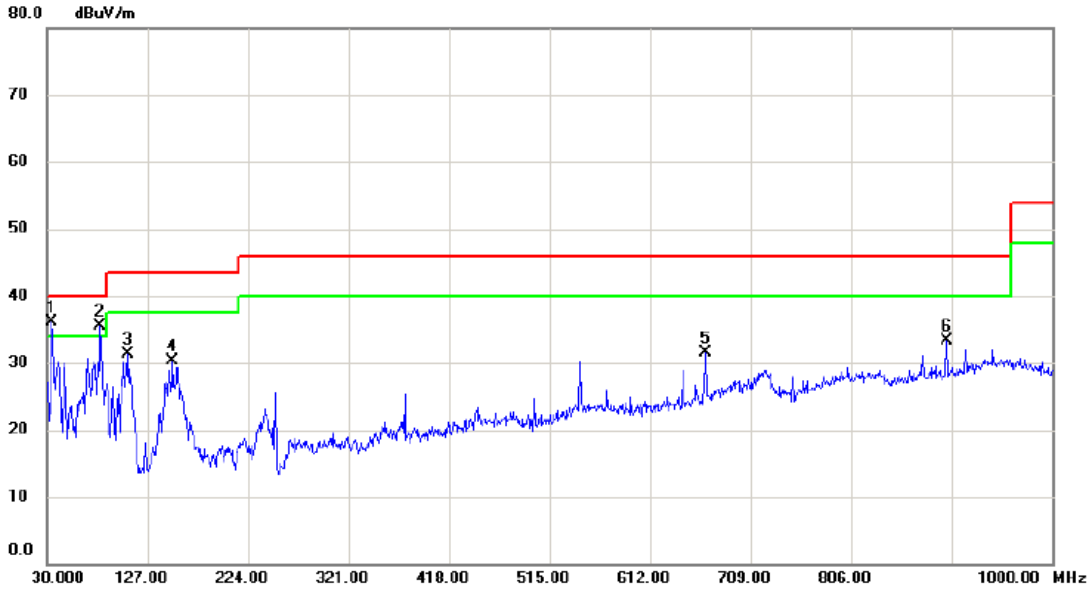

No.	Mk.	Freq. MHz	Reading Level dBuV	Correct Factor dB	Measure- ment dBuV/m	Limit dBuV/m	Margin dB	Detector	Comment
1	*	34.850	50.89	-14.88	36.01	40.00	-3.99	peak	
2	!	81.410	54.16	-18.73	35.43	40.00	-4.57	peak	
3		108.570	47.89	-16.56	31.33	43.50	-12.17	peak	
4		151.250	41.77	-11.39	30.38	43.50	-13.12	peak	
5		665.350	35.92	-4.43	31.49	46.00	-14.51	peak	
6		898.150	34.03	-0.64	33.39	46.00	-12.61	peak	

Test Mode: UNII-2A/TX A Mode 5280MHz

Horizontal

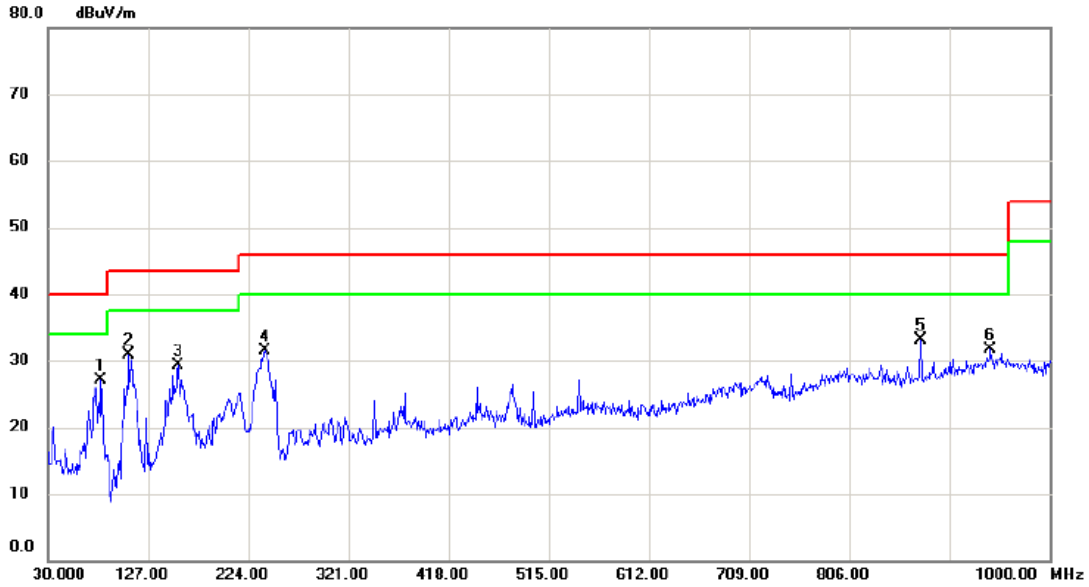

No.	Mk.	Freq. MHz	Reading Level dBuV	Correct Factor dB	Measure- ment dBuV/m	Limit dBuV/m	Margin dB	Detector	Comment
1		81.410	45.76	-18.73	27.03	40.00	-12.97	peak	
2	*	108.570	47.41	-16.56	30.85	43.50	-12.65	peak	
3		156.100	40.17	-10.94	29.23	43.50	-14.27	peak	
4		239.520	46.18	-14.69	31.49	46.00	-14.51	peak	
5		874.870	34.39	-1.21	33.18	46.00	-12.82	peak	
6		942.770	30.61	1.12	31.73	46.00	-14.27	peak	

Test Mode: UNII-2A/TX A Mode 5320MHz

Vertical

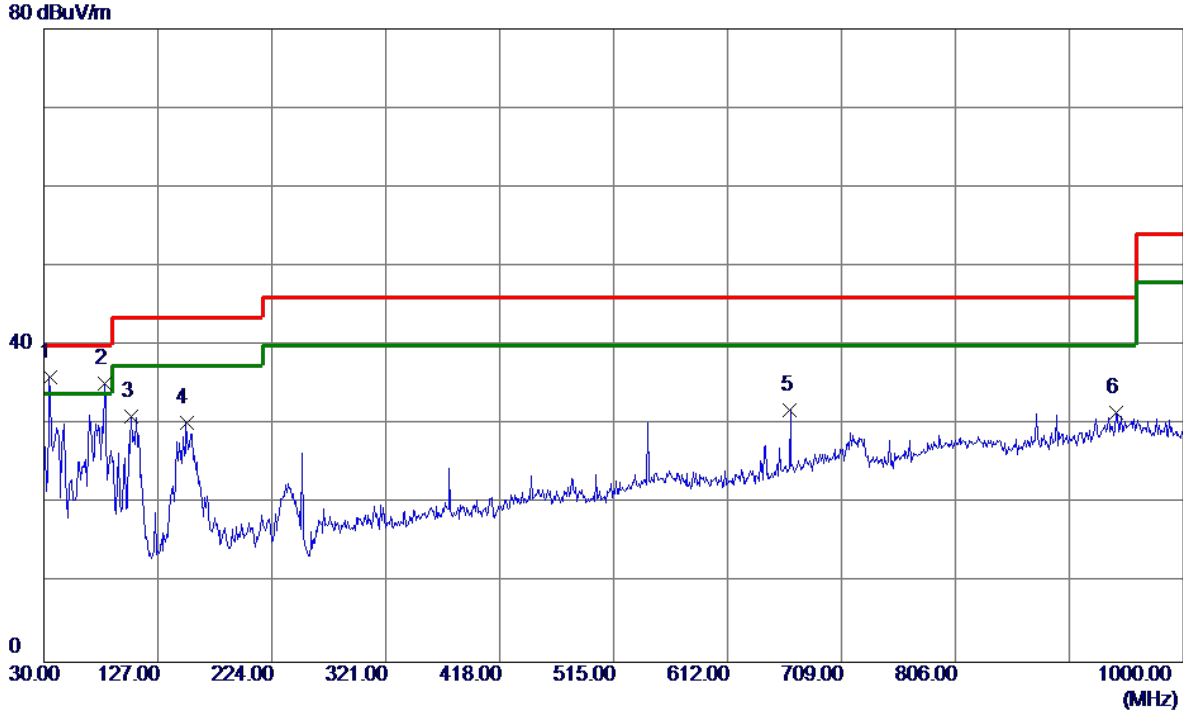

No.	Freq. MHz	Reading Level dBuV/m	Correct Factor dB	Measure ment dBuV/m	Limit dBuV/m	Margin dB	Detector	Comment
1 *	34.8500	50.93	-14.89	36.04	40.00	-3.96	Peak	
2	81.4100	53.86	-18.73	35.13	40.00	-4.87	Peak	
3	104.6900	48.37	-17.34	31.03	43.50	-12.47	Peak	
4	151.2500	41.68	-11.38	30.30	43.50	-13.20	Peak	
5	665.3500	36.21	-4.43	31.78	46.00	-14.22	Peak	
6	942.7700	30.44	1.12	31.56	46.00	-14.44	Peak	

Test Mode: UNII-2A/TX A Mode 5320MHz

Horizontal

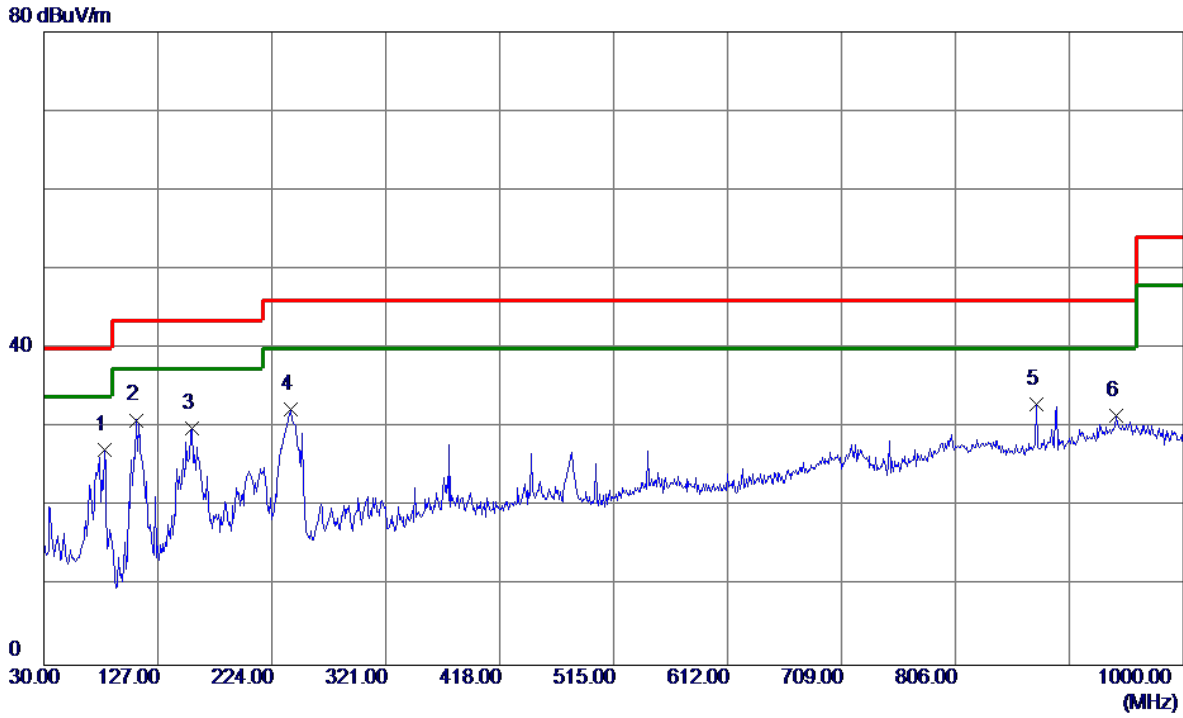

No.	Freq. MHz	Reading Level dBuV/m	Correct Factor dB	Measure ment dBuV/m	Limit dBuV/m	Margin dB	Detector	Comment
1	81.4100	45.89	-18.73	27.16	40.00	-12.84	Peak	
2 *	108.5700	47.53	-16.57	30.96	43.50	-12.54	Peak	
3	156.1000	40.83	-10.95	29.88	43.50	-13.62	Peak	
4	240.4900	46.91	-14.66	32.25	46.00	-13.75	Peak	
5	874.8700	34.19	-1.21	32.98	46.00	-13.02	Peak	
6	942.7700	30.35	1.12	31.47	46.00	-14.53	Peak	

Test Mode: UNII-2C/TX A Mode 5500MHz

Vertical

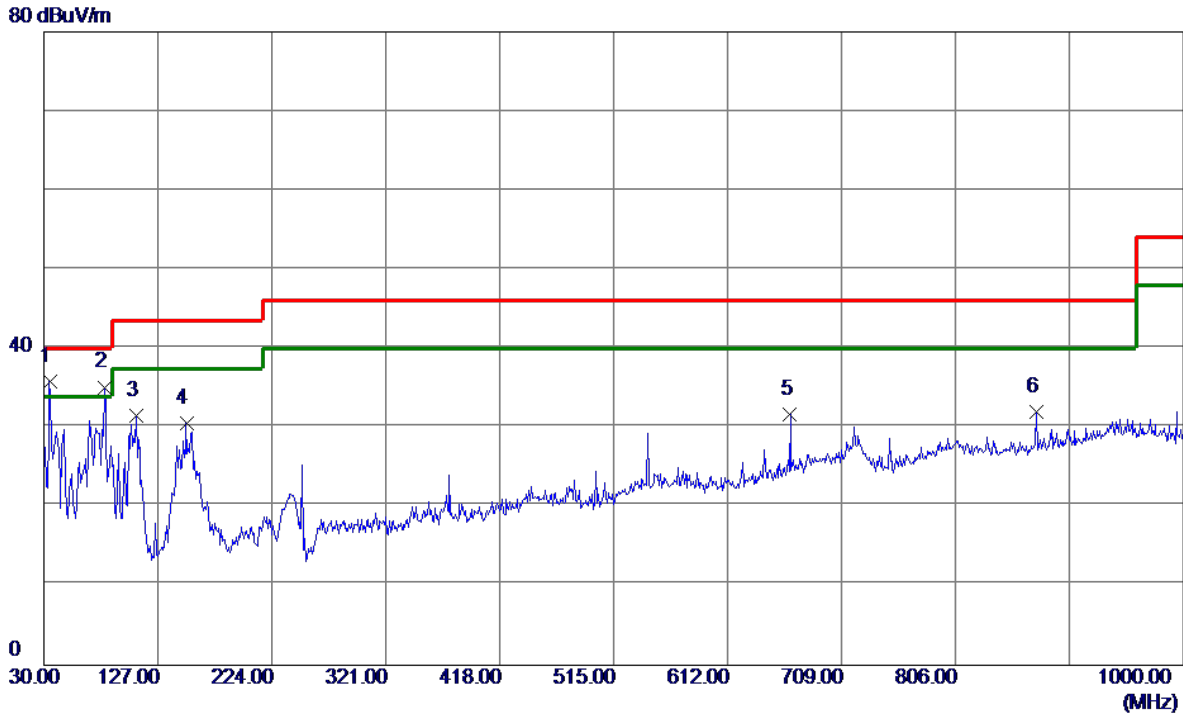

No.	Freq. MHz	Reading Level dBuV/m	Correct Factor dB	Measure ment dBuV/m	Limit dBuV/m	Margin dB	Detector	Comment
1 *	34.8500	50.74	-14.89	35.85	40.00	-4.15	Peak	
2	81.4100	53.85	-18.73	35.12	40.00	-4.88	Peak	
3	108.5700	48.09	-16.57	31.52	43.50	-11.98	Peak	
4	151.2500	41.92	-11.38	30.54	43.50	-12.96	Peak	
5	665.3500	36.11	-4.43	31.68	46.00	-14.32	Peak	
6	874.8700	33.22	-1.21	32.01	46.00	-13.99	Peak	

Test Mode: UNII-2C/TX A Mode 5500MHz

Horizontal

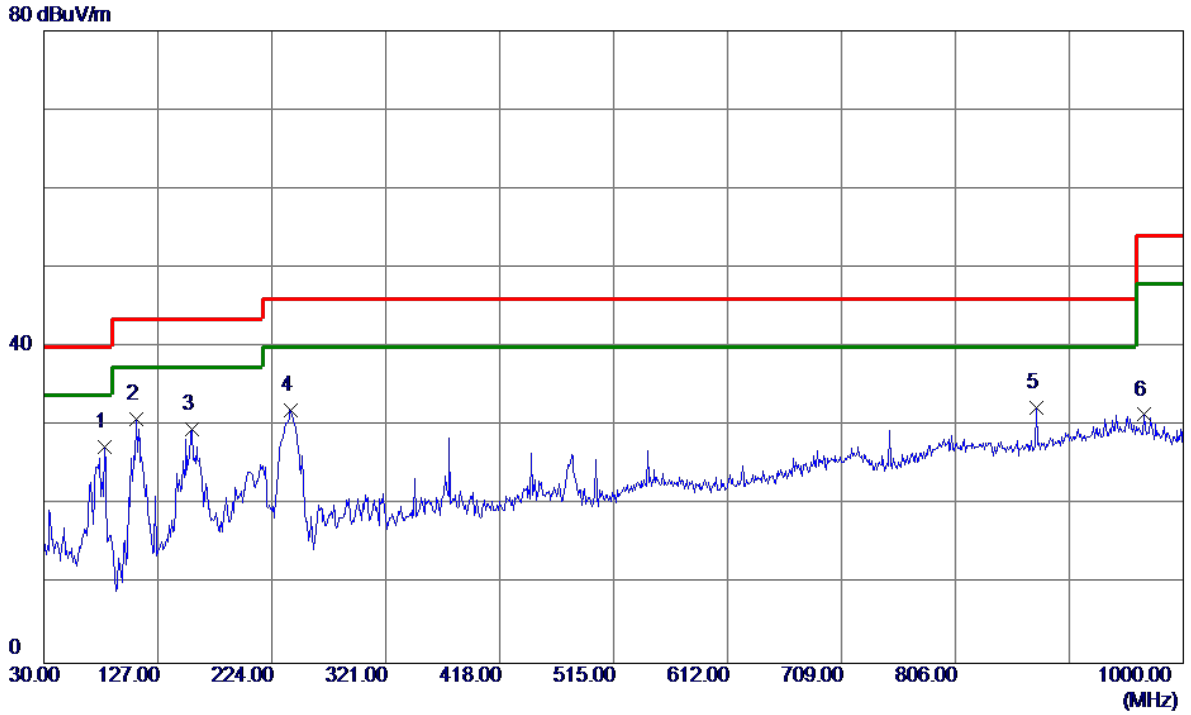

No.	Freq. MHz	Reading Level dBuV/m	Correct Factor dB	Measure ment dBuV/m	Limit dBuV/m	Margin dB	Detector	Comment
1	81.4100	46.04	-18.73	27.31	40.00	-12.69	Peak	
2 *	108.5700	47.43	-16.57	30.86	43.50	-12.64	Peak	
3	156.1000	40.57	-10.95	29.62	43.50	-13.88	Peak	
4	240.4900	46.62	-14.66	31.96	46.00	-14.04	Peak	
5	874.8700	33.51	-1.21	32.30	46.00	-13.70	Peak	
6	967.0200	30.44	1.00	31.44	54.00	-22.56	Peak	

Test Mode: UNII-2C/TX A Mode 5580MHz

Vertical

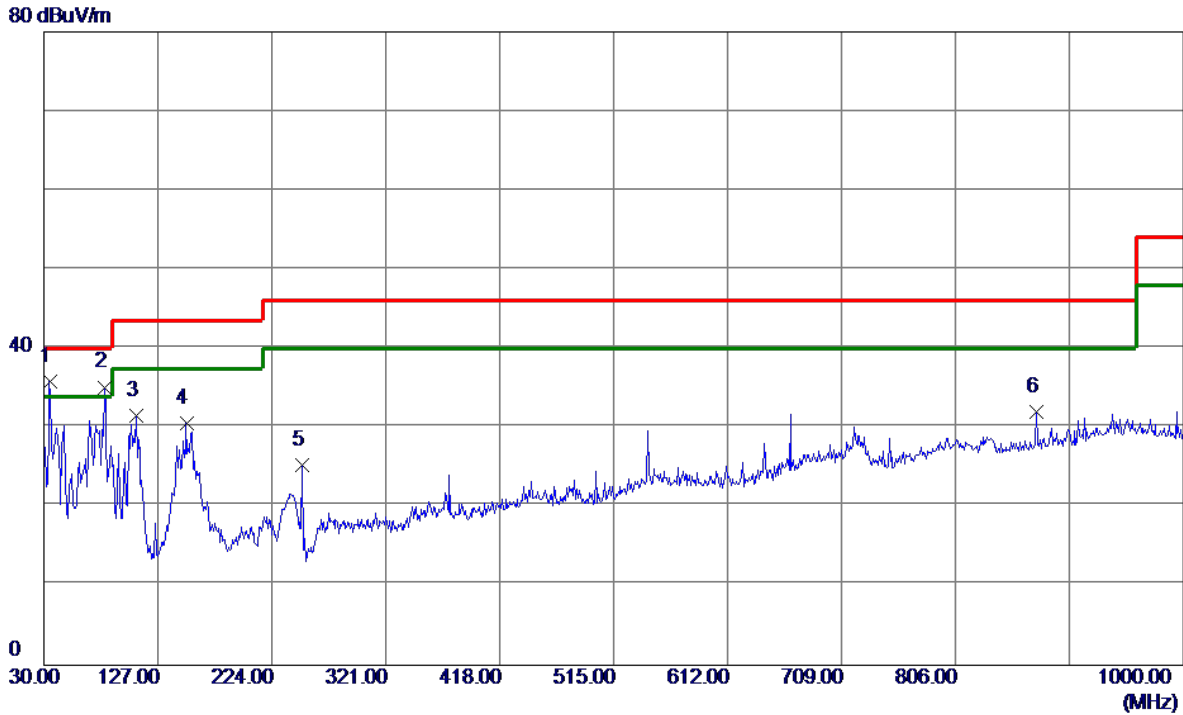

No.	Freq. MHz	Reading Level dBuV/m	Correct Factor dB	Measure ment dBuV/m	Limit dBuV/m	Margin dB	Detector	Comment
1 *	34.8500	50.74	-14.89	35.85	40.00	-4.15	Peak	
2	81.4100	53.85	-18.73	35.12	40.00	-4.88	Peak	
3	108.5700	48.09	-16.57	31.52	43.50	-11.98	Peak	
4	151.2500	41.92	-11.38	30.54	43.50	-12.96	Peak	
5	250.1900	39.52	-14.28	25.24	46.00	-20.76	Peak	
6	874.8700	33.22	-1.21	32.01	46.00	-13.99	Peak	

Test Mode: UNII-2C/TX A Mode 5580MHz

Horizontal

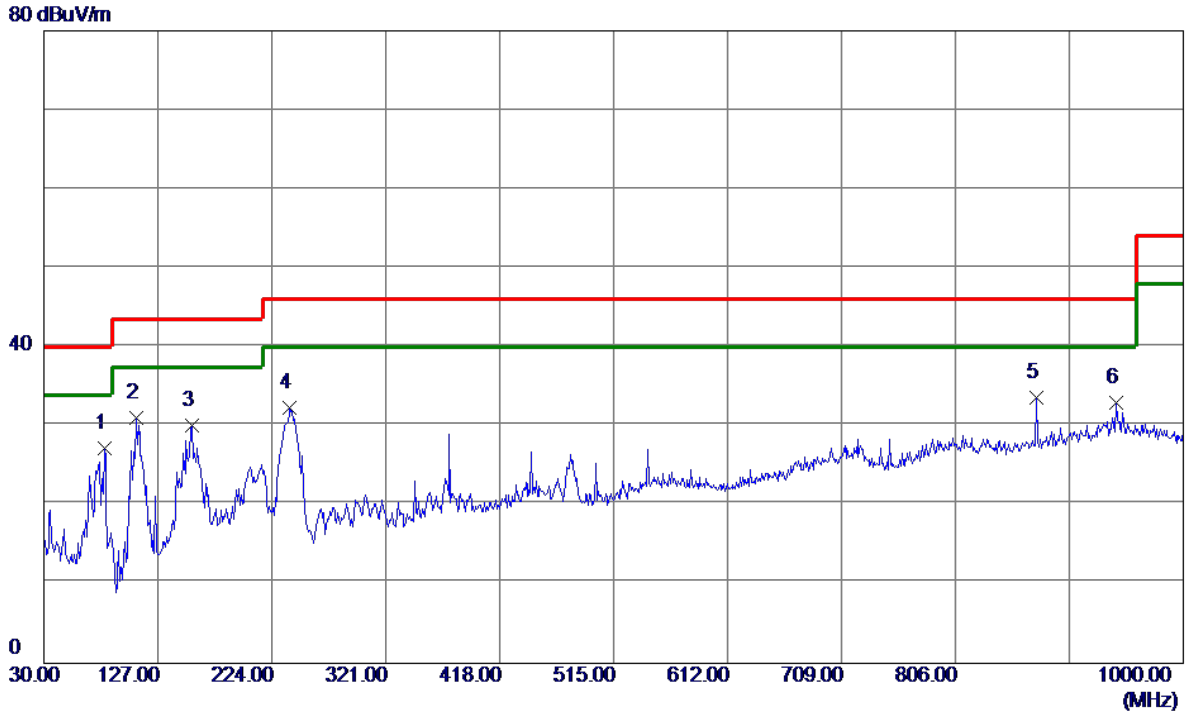

No.	Freq. MHz	Reading Level dBuV/m	Correct Factor dB	Measure ment dBuV/m	Limit dBuV/m	Margin dB	Detector	Comment
1	81.4100	45.90	-18.73	27.17	40.00	-12.83	Peak	
2	108.5700	47.60	-16.57	31.03	43.50	-12.47	Peak	
3	156.1000	40.96	-10.95	30.01	43.50	-13.49	Peak	
4	239.5200	47.04	-14.69	32.35	46.00	-13.65	Peak	
5 *	874.8700	34.75	-1.21	33.54	46.00	-12.46	Peak	
6	942.7700	31.82	1.12	32.94	46.00	-13.06	Peak	

Test Mode: UNII-2C/TX A Mode 5700MHz

Vertical

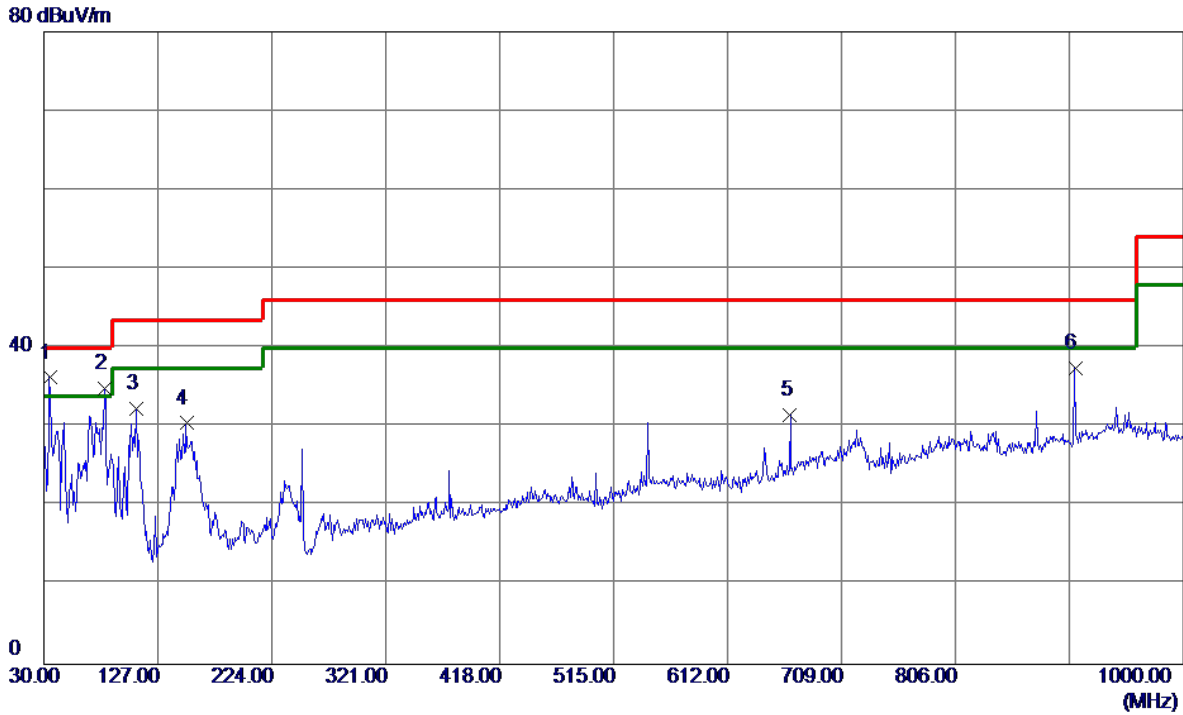

No.	Freq. MHz	Reading Level dBuV/m	Correct Factor dB	Measure ment dBuV/m	Limit dBuV/m	Margin dB	Detector	Comment
1 *	34.8500	51.13	-14.89	36.24	40.00	-3.76	Peak	
2	81.4100	53.61	-18.73	34.88	40.00	-5.12	Peak	
3	108.5700	48.86	-16.57	32.29	43.50	-11.21	Peak	
4	151.2500	41.86	-11.38	30.48	43.50	-13.02	Peak	
5	665.3500	36.00	-4.43	31.57	46.00	-14.43	Peak	
6	907.8500	37.77	-0.28	37.49	46.00	-8.51	Peak	

Test Mode: UNII-2C/TX A Mode 5700MHz

Horizontal

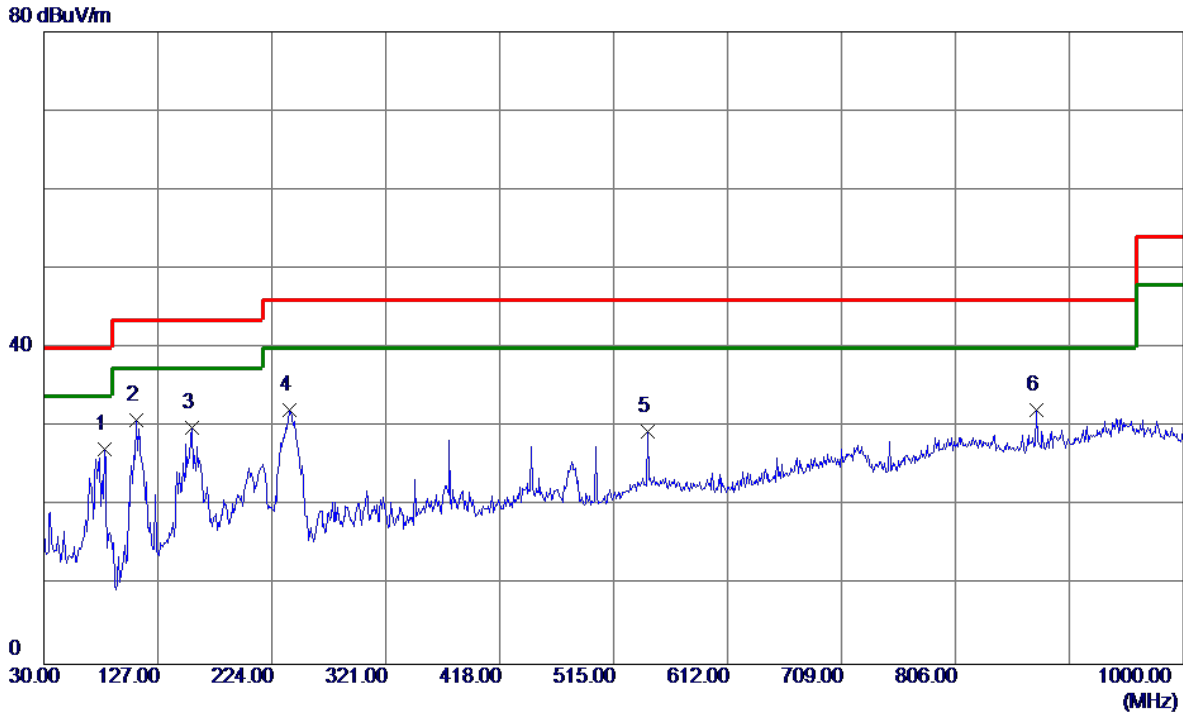

No.	Freq. MHz	Reading Level dBuV/m	Correct Factor dB	Measure ment dBuV/m	Limit dBuV/m	Margin dB	Detector	Comment
1	81.4100	45.98	-18.73	27.25	40.00	-12.75	Peak	
2 *	108.5700	47.46	-16.57	30.89	43.50	-12.61	Peak	
3	156.1000	40.85	-10.95	29.90	43.50	-13.60	Peak	
4	239.5200	46.85	-14.69	32.16	46.00	-13.84	Peak	
5	544.1000	35.19	-5.82	29.37	46.00	-16.63	Peak	
6	874.8700	33.40	-1.21	32.19	46.00	-13.81	Peak	

Test Mode: UNII-3/TX A Mode 5745MHz

Vertical

80 dBuV/m

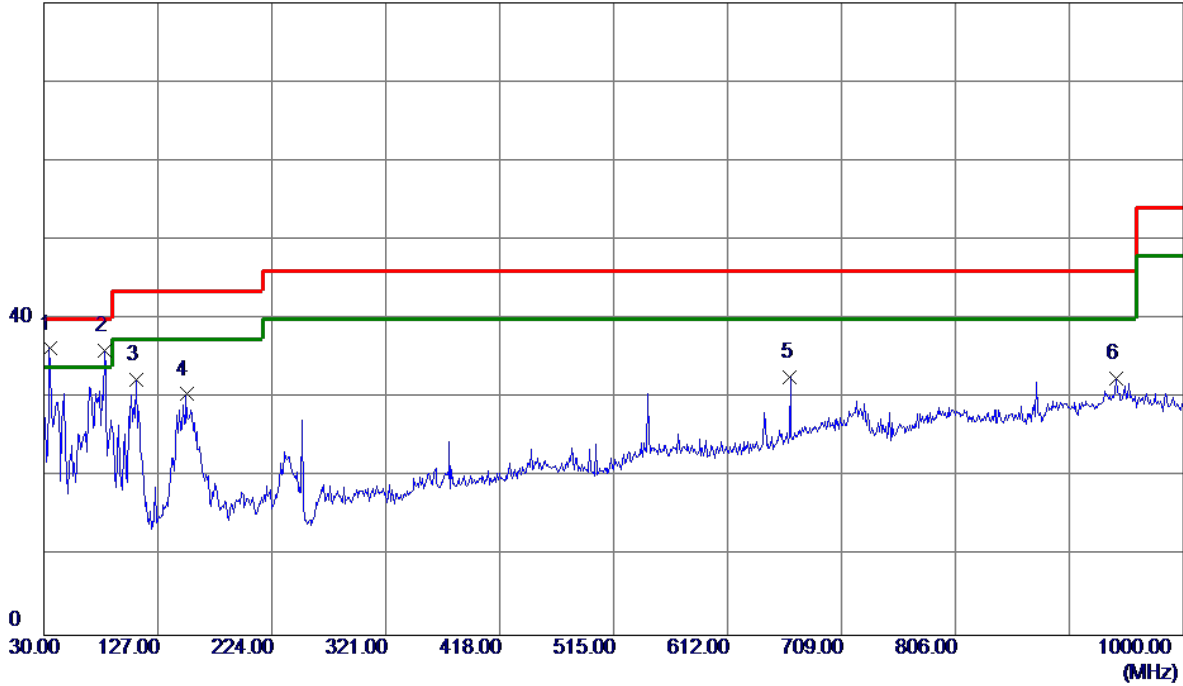

No.	Freq. MHz	Reading Level dBuV/m	Correct Factor dB	Measure ment dBuV/m	Limit dBuV/m	Margin dB	Detector	Comment
1 *	34.8500	51.13	-14.89	36.24	40.00	-3.76	Peak	
2	81.4100	54.66	-18.73	35.93	40.00	-4.07	Peak	
3	108.5700	48.86	-16.57	32.29	43.50	-11.21	Peak	
4	151.2500	41.86	-11.38	30.48	43.50	-13.02	Peak	
5	665.3500	37.10	-4.43	32.67	46.00	-13.33	Peak	
6	942.7700	31.38	1.12	32.50	46.00	-13.50	Peak	

Test Mode: UNII-3/TX A Mode 5745MHz

Horizontal

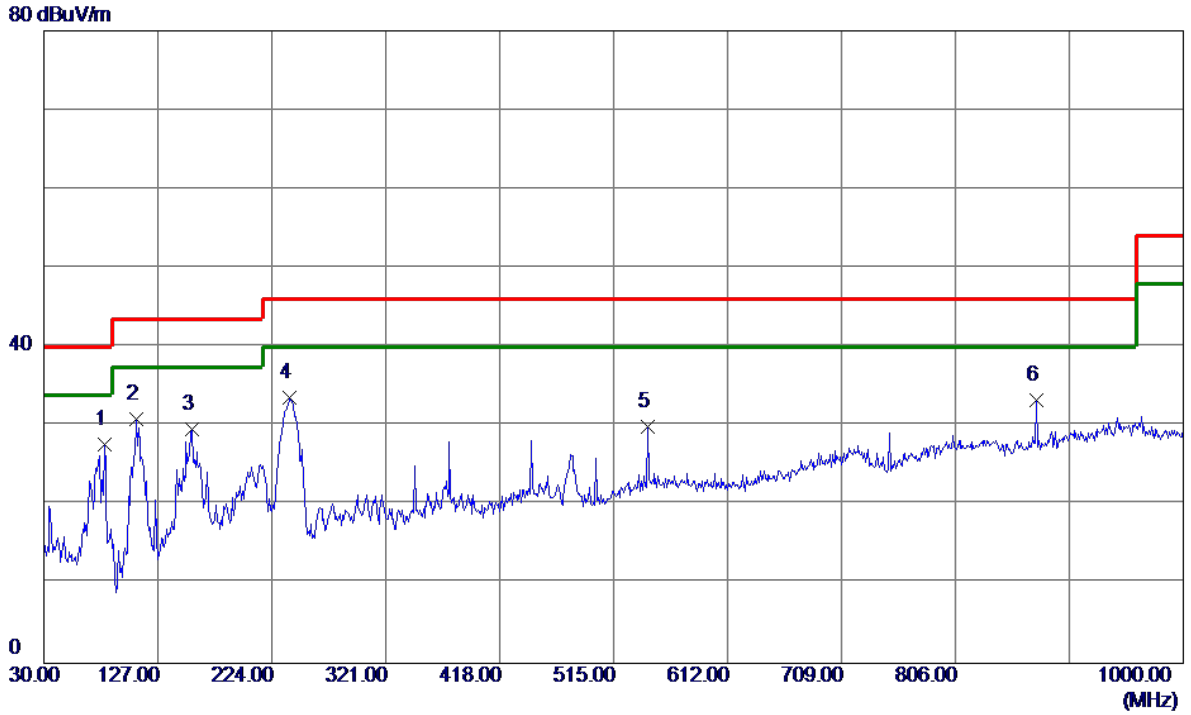

No.	Freq. MHz	Reading Level dBuV/m	Correct Factor dB	Measure ment dBuV/m	Limit dBuV/m	Margin dB	Detector	Comment
1	81.4100	46.35	-18.73	27.62	40.00	-12.38	Peak	
2	108.5700	47.39	-16.57	30.82	43.50	-12.68	Peak	
3	156.1000	40.49	-10.95	29.54	43.50	-13.96	Peak	
4 *	239.5200	48.32	-14.69	33.63	46.00	-12.37	Peak	
5	544.1000	35.80	-5.82	29.98	46.00	-16.02	Peak	
6	874.8700	34.42	-1.21	33.21	46.00	-12.79	Peak	

Test Mode: UNII-3/TX A Mode 5785MHz

Vertical

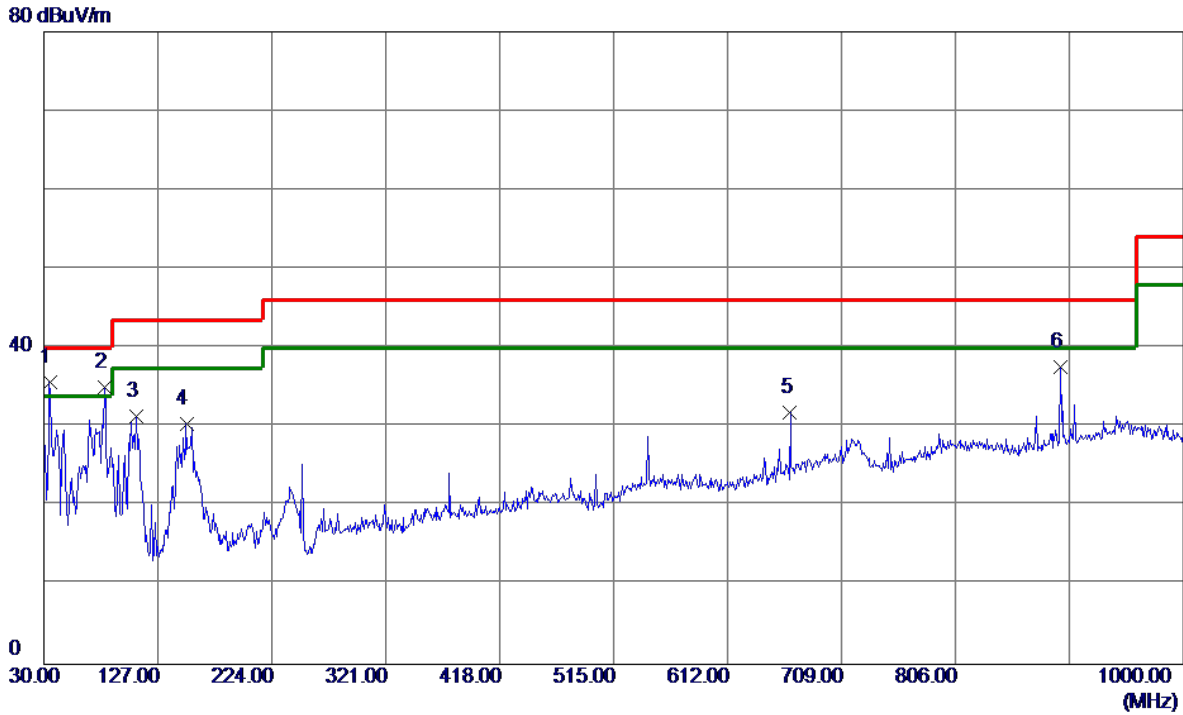

No.	Freq. MHz	Reading Level dBuV/m	Correct Factor dB	Measure ment dBuV/m	Limit dBuV/m	Margin dB	Detector	Comment
1 *	34.8500	50.59	-14.89	35.70	40.00	-4.30	Peak	
2	81.4100	53.76	-18.73	35.03	40.00	-4.97	Peak	
3	108.5700	47.87	-16.57	31.30	43.50	-12.20	Peak	
4	151.2500	41.71	-11.38	30.33	43.50	-13.17	Peak	
5	665.3500	36.27	-4.43	31.84	46.00	-14.16	Peak	
6	895.2400	38.36	-0.72	37.64	46.00	-8.36	Peak	

Test Mode: UNII-3/TX A Mode 5785MHz

Horizontal

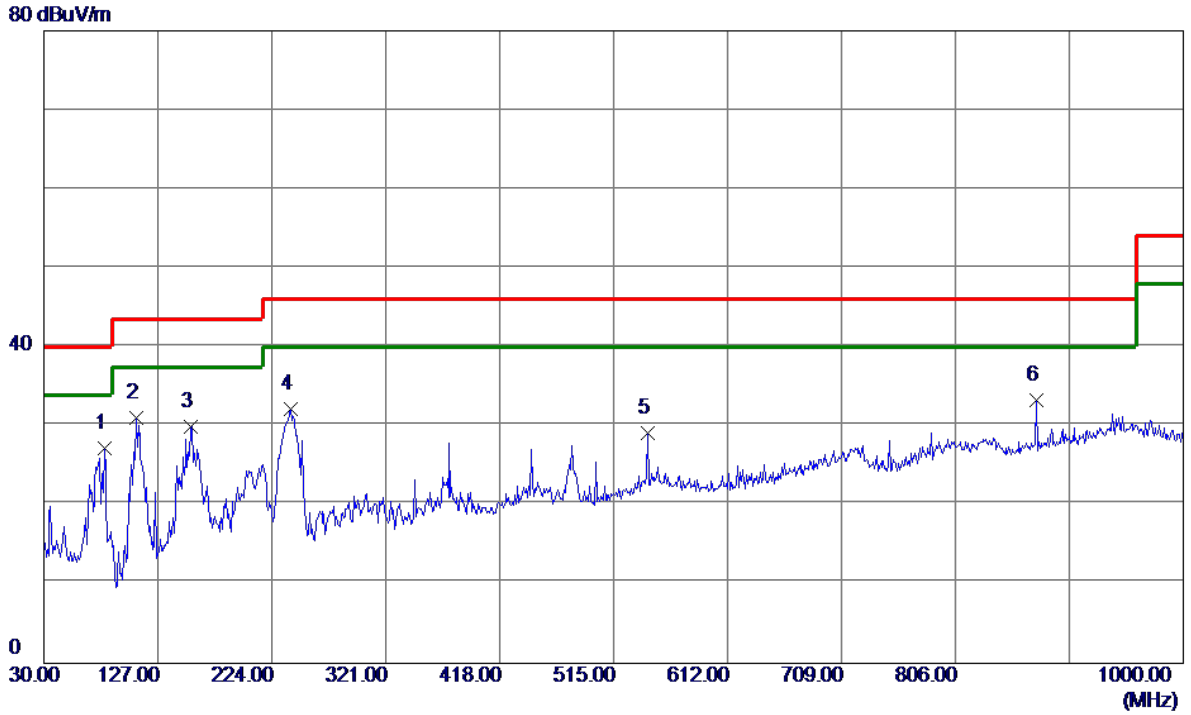

No.	Freq. MHz	Reading Level dBuV/m	Correct Factor dB	Measure ment dBuV/m	Limit dBuV/m	Margin dB	Detector	Comment
1	81.4100	45.88	-18.73	27.15	40.00	-12.85	Peak	
2 *	108.5700	47.55	-16.57	30.98	43.50	-12.52	Peak	
3	155.1300	41.02	-11.03	29.99	43.50	-13.51	Peak	
4	240.4900	46.78	-14.66	32.12	46.00	-13.88	Peak	
5	544.1000	34.92	-5.82	29.10	46.00	-16.90	Peak	
6	874.8700	34.54	-1.21	33.33	46.00	-12.67	Peak	

Test Mode: UNII-3/TX A Mode 5825MHz

Vertical

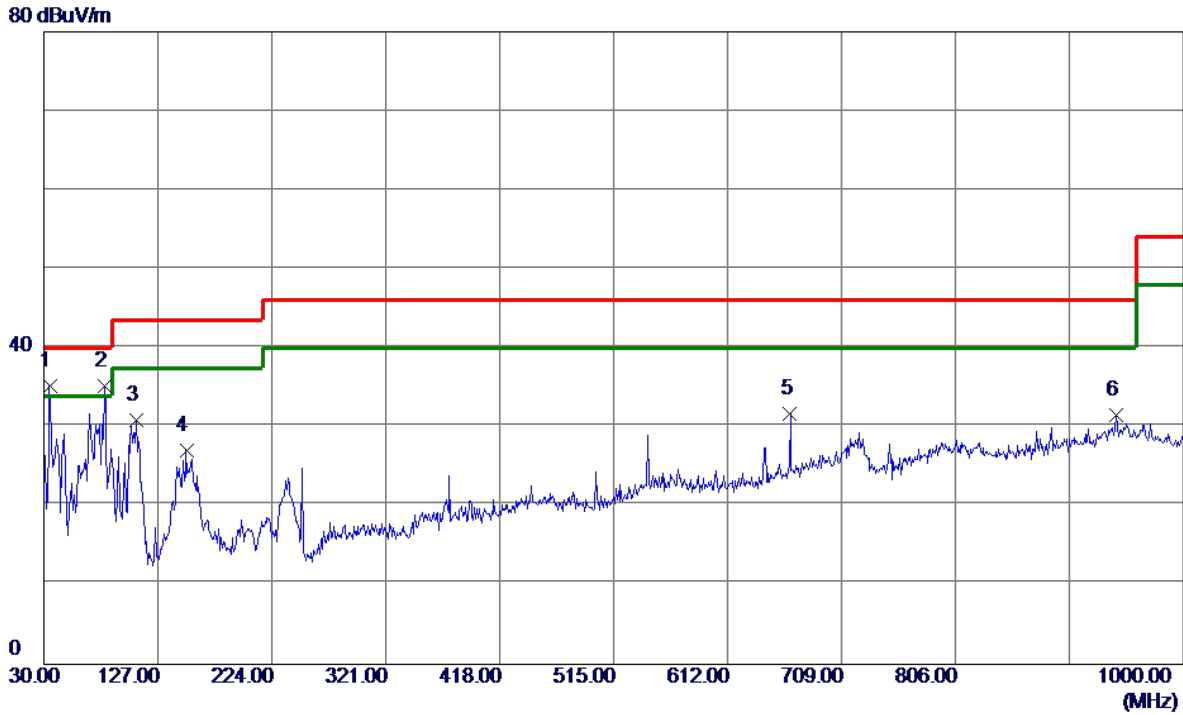

No.	Freq. MHz	Reading Level dBuV/m	Correct Factor dB	Measure ment dBuV/m	Limit dBuV/m	Margin dB	Detector	Comment
1	34.8500	50.06	-14.89	35.17	40.00	-4.83	Peak	
2 *	81.4100	53.96	-18.73	35.23	40.00	-4.77	Peak	
3	108.5700	47.48	-16.57	30.91	43.50	-12.59	Peak	
4	151.2500	38.45	-11.38	27.07	43.50	-16.43	Peak	
5	665.3500	36.06	-4.43	31.63	46.00	-14.37	Peak	
6	942.7700	30.33	1.12	31.45	46.00	-14.55	Peak	

Test Mode: UNII-3/TX A Mode 5825MHz

Horizontal

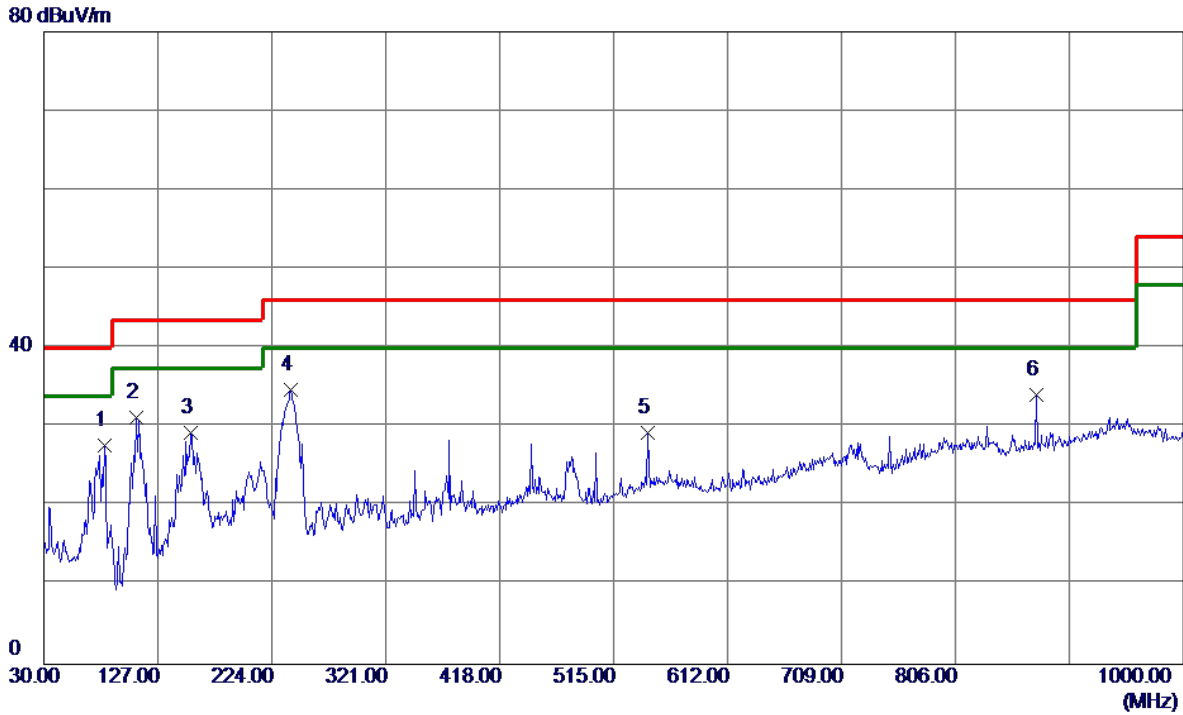

No.	Freq. MHz	Reading Level dBuV/m	Correct Factor dB	Measure ment dBuV/m	Limit dBuV/m	Margin dB	Detector	Comment
1	81.4100	46.44	-18.73	27.71	40.00	-12.29	Peak	
2	108.5700	47.70	-16.57	31.13	43.50	-12.37	Peak	
3	155.1300	40.33	-11.03	29.30	43.50	-14.20	Peak	
4 *	240.4900	49.35	-14.66	34.69	46.00	-11.31	Peak	
5	544.1000	35.07	-5.82	29.25	46.00	-16.75	Peak	
6	874.8700	35.30	-1.21	34.09	46.00	-11.91	Peak	

APPENDIX C - RADIATED EMISSION (ABOVE 1000MHZ)

Orthogonal Axis:	X
Test Mode:	UNII-1/ TX A Mode 5180MHz

Vertical

130 dBuV/m

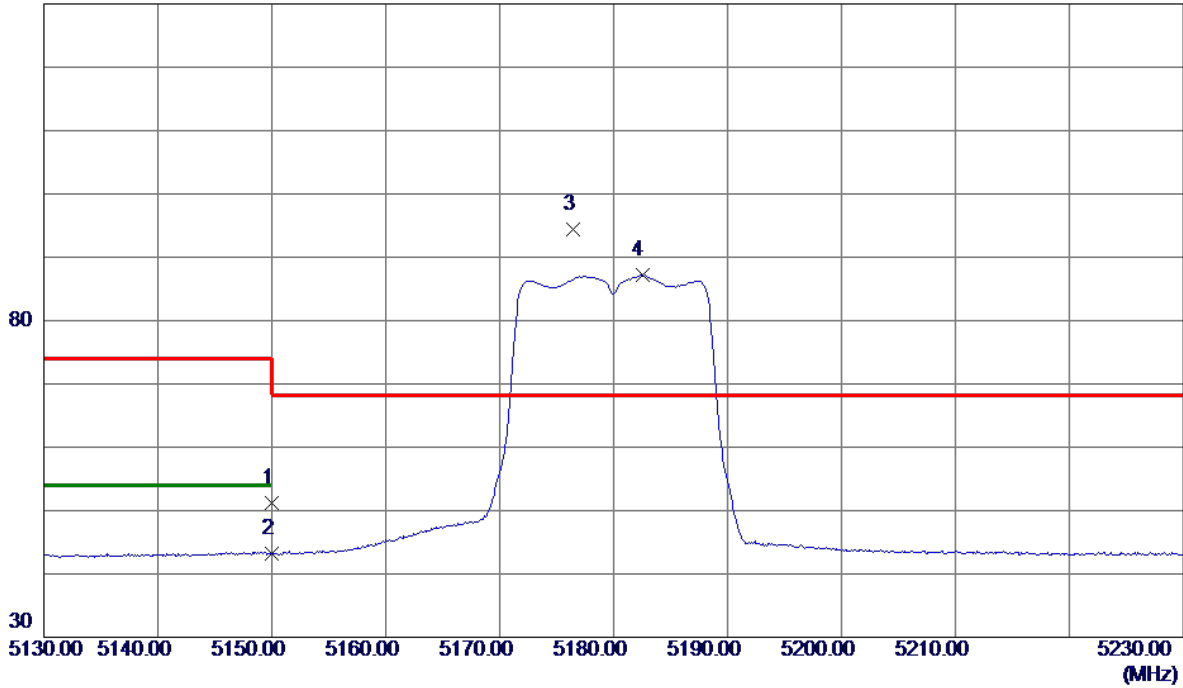

No.	Freq. MHz	Reading Level dBuV/m	Correct Factor dB	Measure ment dBuV/m	Limit dBuV/m	Margin dB	Detector	Comment
1	5150.0000	30.22	21.03	51.25	74.00	-22.75	Peak	
2	5150.0000	22.14	21.03	43.17	54.00	-10.83	AVG	
3 *	5176.4000	73.31	21.13	94.44	68.30	26.14	Peak	No Limit
4	5182.5000	66.03	21.15	87.18	999.00	-911.82	AVG	No Limit

Orthogonal Axis:	X
Test Mode:	UNII-1/ TX A Mode 5180MHz

Vertical

130 dBuV/m

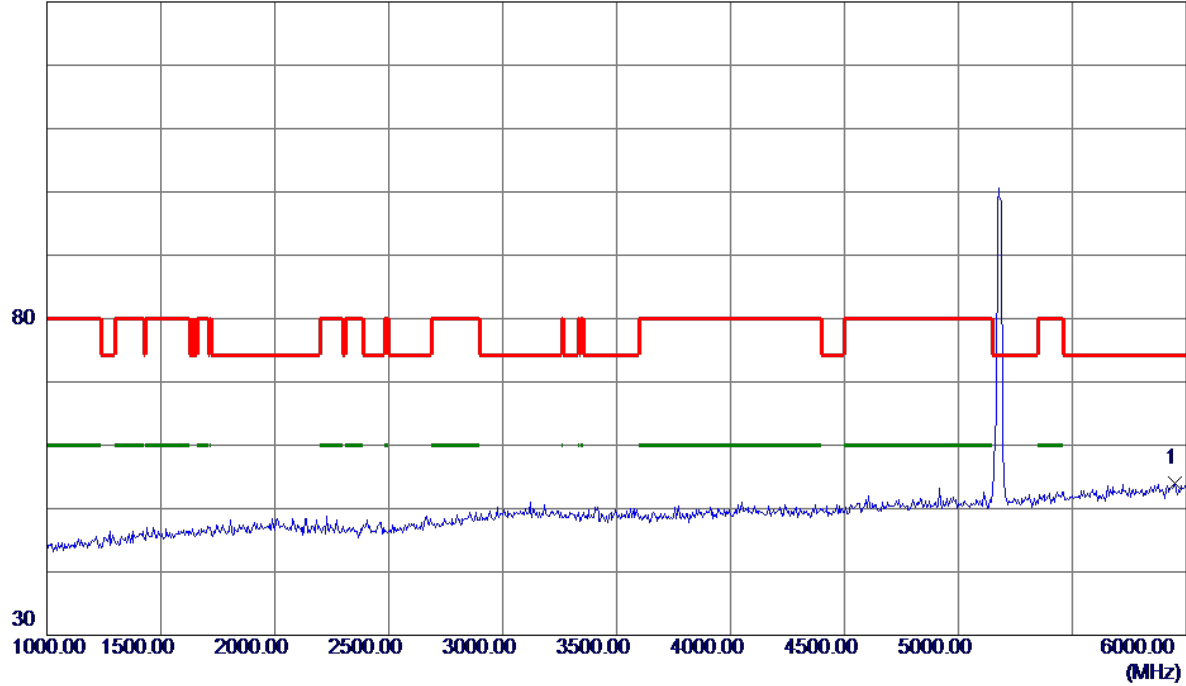

No.	Freq. MHz	Reading Level dBuV/m	Correct Factor dB	Measure ment dBuV/m	Limit dBuV/m	Margin dB	Detector	Comment
1 *	5950.0000	34.84	19.23	54.07	74.30	-20.23	Peak	

Orthogonal Axis:	X
Test Mode:	UNII-1/ TX A Mode 5180MHz

Vertical

130 dBuV/m

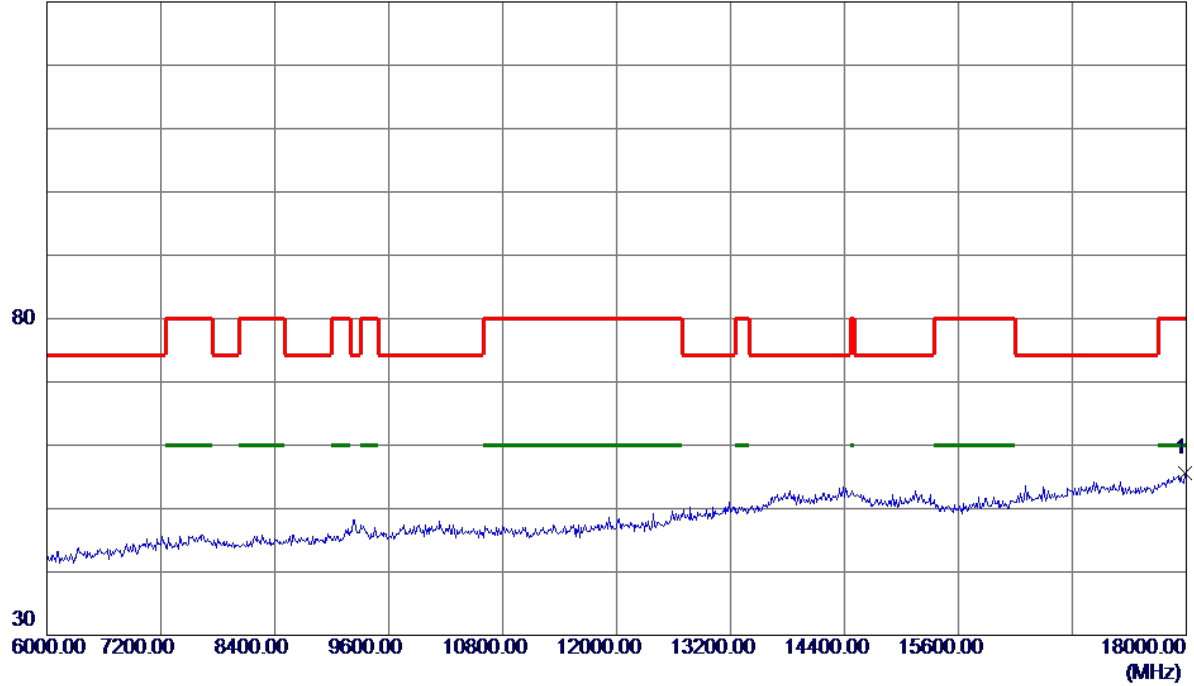

No.	Freq. MHz	Reading Level dBuV/m	Correct Factor dB	Measure ment dBuV/m	Limit dBuV/m	Margin dB	Detector	Comment
1 *	17988.0000	26.49	29.12	55.61	80.00	-24.39	Peak	

Orthogonal Axis:	X
Test Mode:	UNII-1/ TX A Mode 5180MHz

Vertical

100 dBuV/m

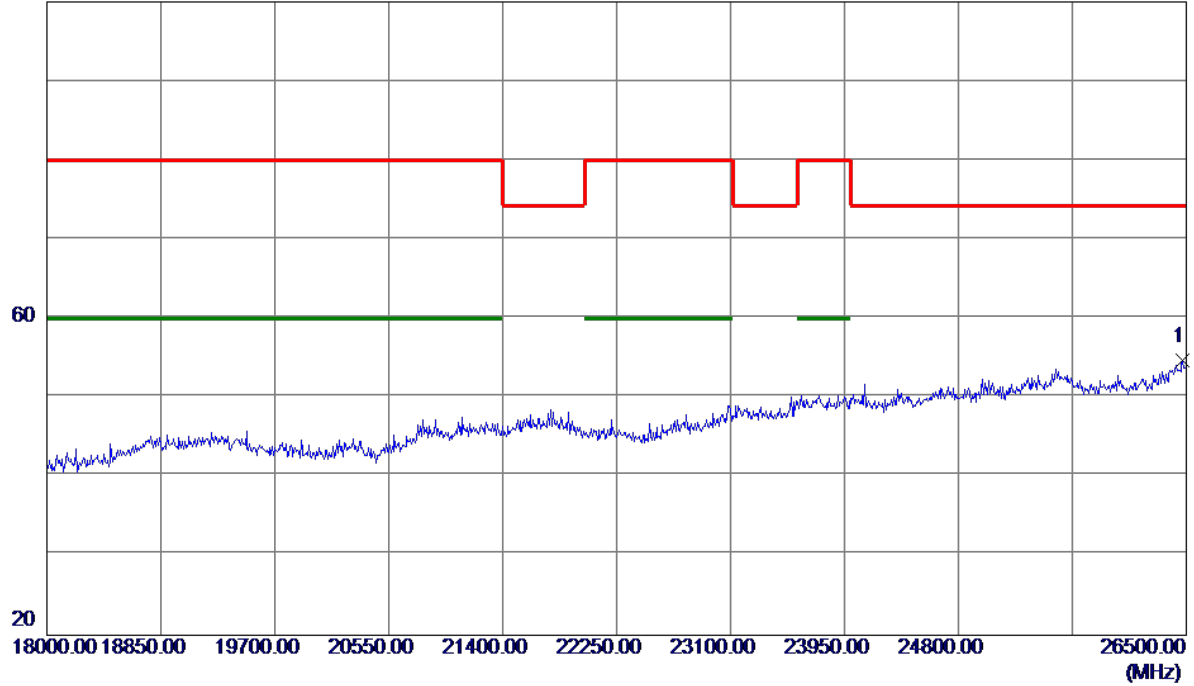

No.	Freq. MHz	Reading Level dBuV/m	Correct Factor dB	Measure ment dBuV/m	Limit dBuV/m	Margin dB	Detector	Comment
1 *	26474.5000	28.65	25.99	54.64	74.30	-19.66	Peak	

Orthogonal Axis:	X
Test Mode:	UNII-1/ TX A Mode 5180MHz

Vertical

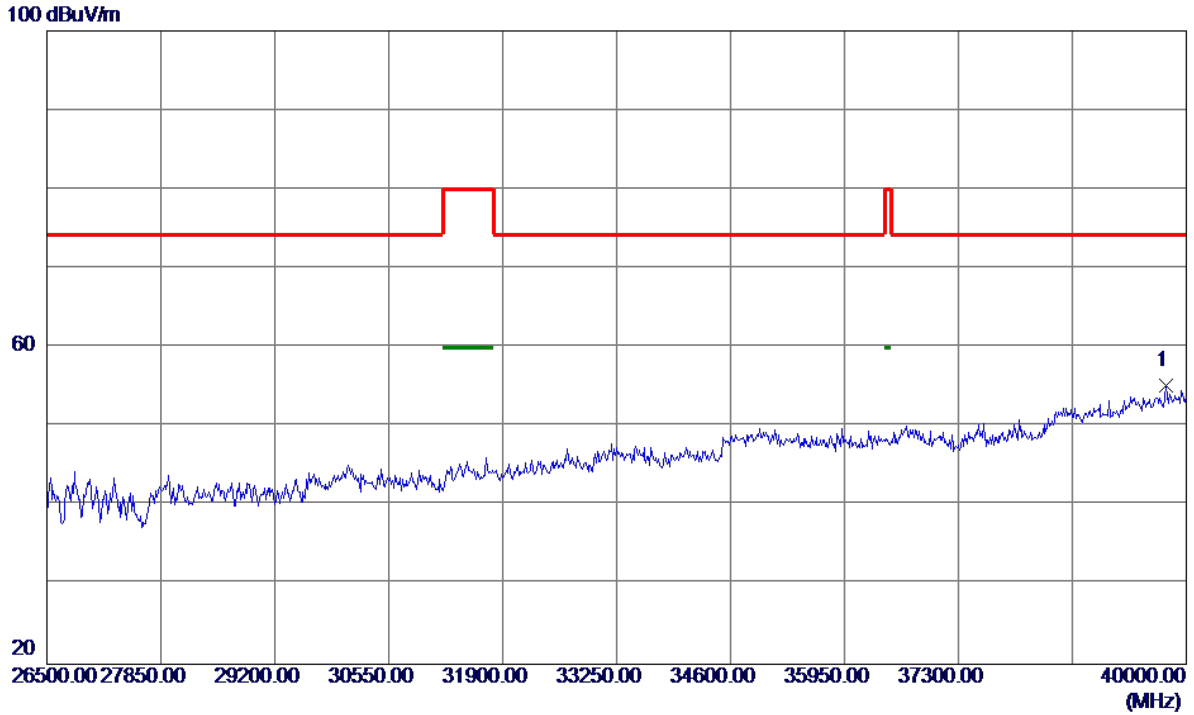

No.	Freq. MHz	Reading Level dBuV/m	Correct Factor dB	Measure ment dBuV/m	Limit dBuV/m	Margin dB	Detector	Comment
1 *	39757.0000	39.68	15.50	55.18	74.30	-19.12	Peak	

Orthogonal Axis:	X
Test Mode:	UNII-1/ TX A Mode 5180MHz

Horizontal

130 dBuV/m

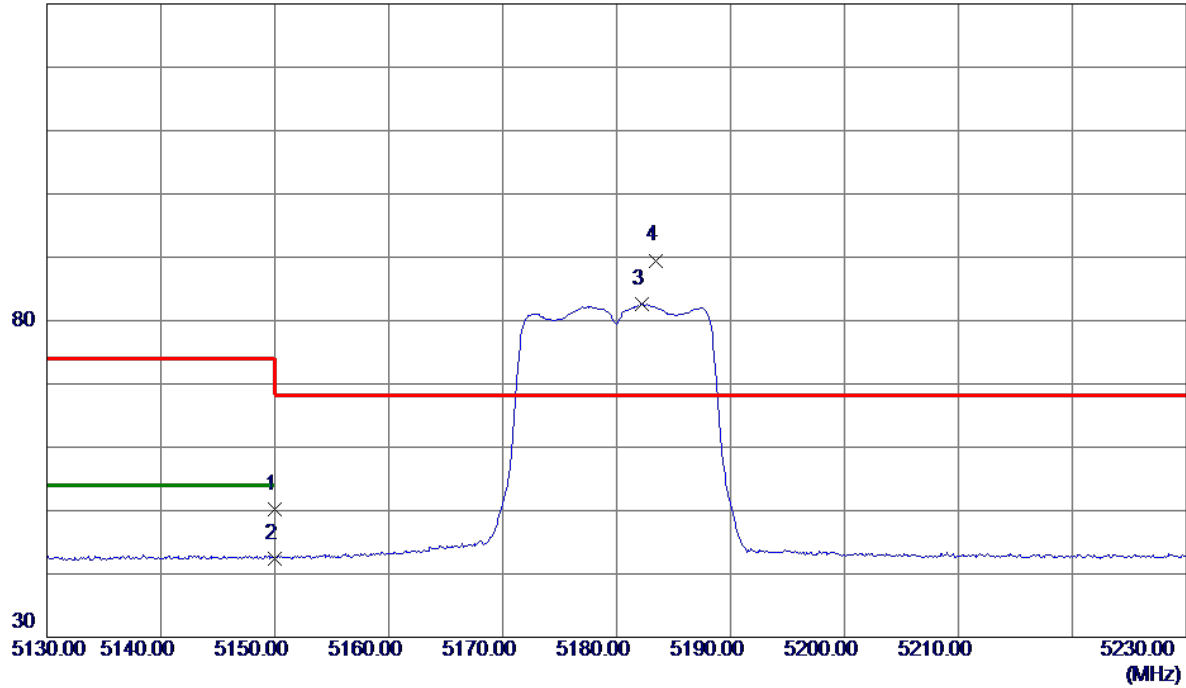

No.	Freq. MHz	Reading Level dBuV/m	Correct Factor dB	Measure ment dBuV/m	Limit dBuV/m	Margin dB	Detector	Comment
1	5150.0000	29.22	21.03	50.25	74.00	-23.75	Peak	
2	5150.0000	21.45	21.03	42.48	54.00	-11.52	AVG	
3	5182.2000	61.42	21.15	82.57	999.00	-916.43	AVG	No Limit
4 *	5183.4000	68.35	21.15	89.50	68.30	21.20	Peak	No Limit

Orthogonal Axis:	X
Test Mode:	UNII-1/ TX A Mode 5180MHz

Horizontal

130 dBuV/m

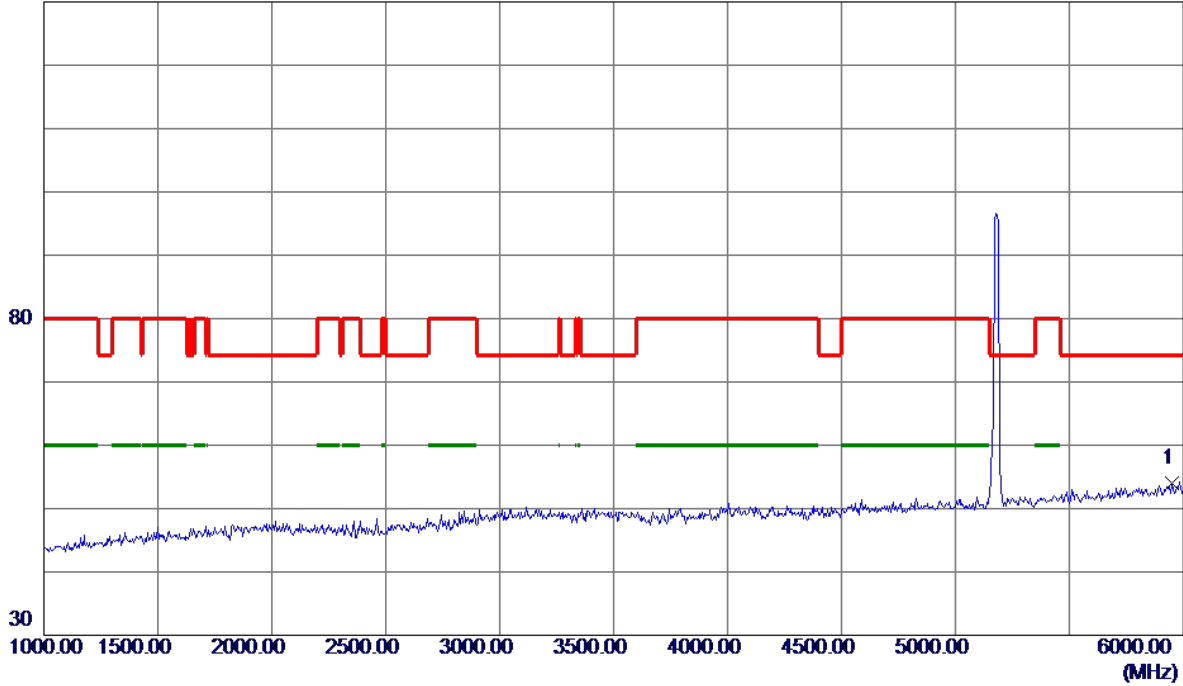

No.	Freq. MHz	Reading Level dBuV/m	Correct Factor dB	Measure ment dBuV/m	Limit dBuV/m	Margin dB	Detector	Comment
1 *	5950.0000	34.74	19.23	53.97	74.30	-20.33	Peak	

Orthogonal Axis:	X
Test Mode:	UNII-1/ TX A Mode 5180MHz

Horizontal

130 dBuV/m

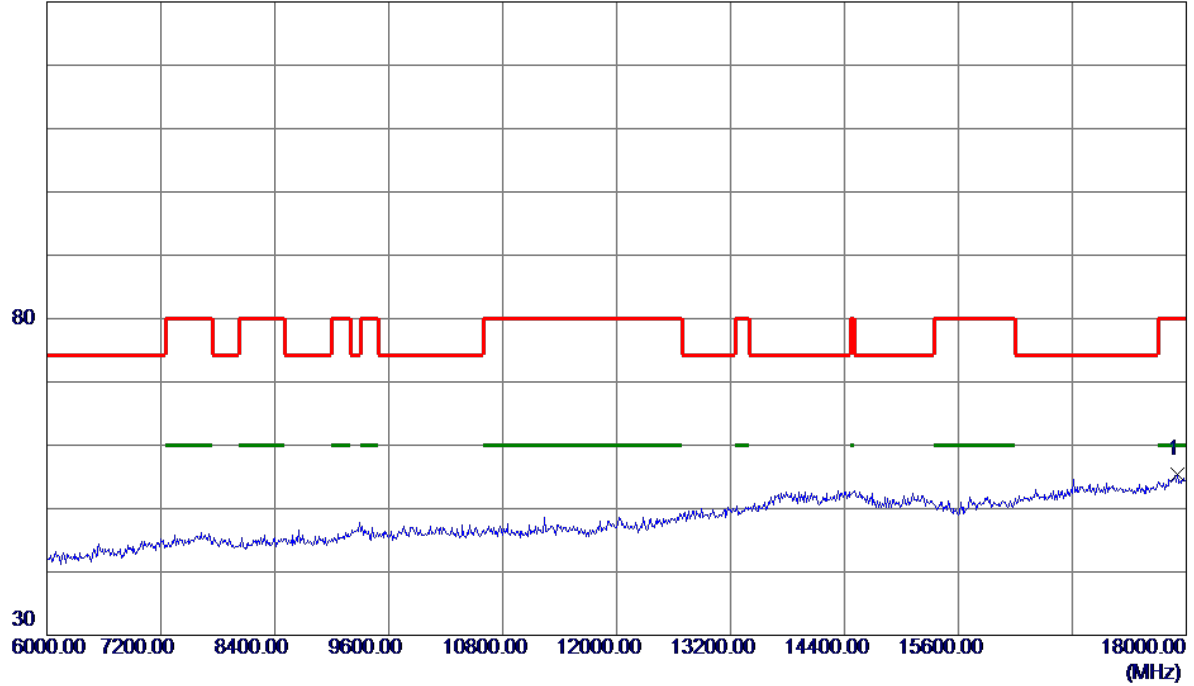

No.	Freq. MHz	Reading Level dBuV/m	Correct Factor dB	Measure ment dBuV/m	Limit dBuV/m	Margin dB	Detector	Comment
1 *	17904.0000	26.62	28.85	55.47	80.00	-24.53	Peak	

Orthogonal Axis:	X
Test Mode:	UNII-1/ TX A Mode 5180MHz

Horizontal

100 dBuV/m

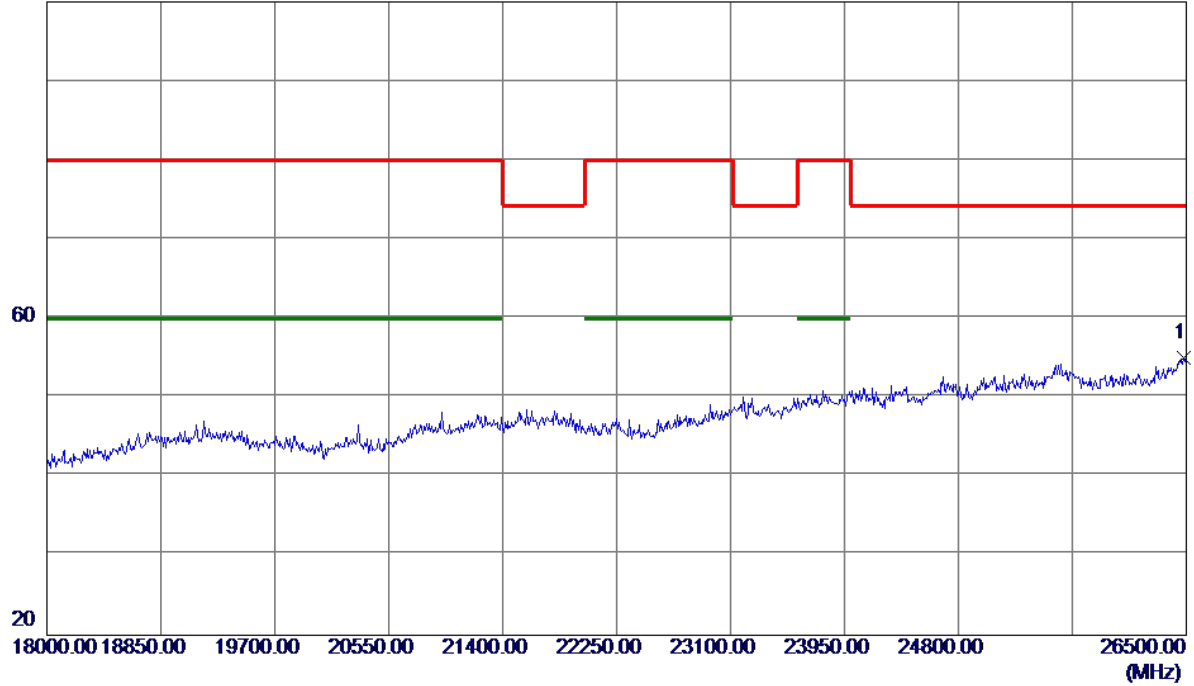

No.	Freq. MHz	Reading Level dBuV/m	Correct Factor dB	Measure ment dBuV/m	Limit dBuV/m	Margin dB	Detector	Comment
1 *	26483.0000	29.03	26.03	55.06	74.30	-19.24	Peak	

Orthogonal Axis:	X
Test Mode:	UNII-1/ TX A Mode 5180MHz

Horizontal

100 dBuV/m

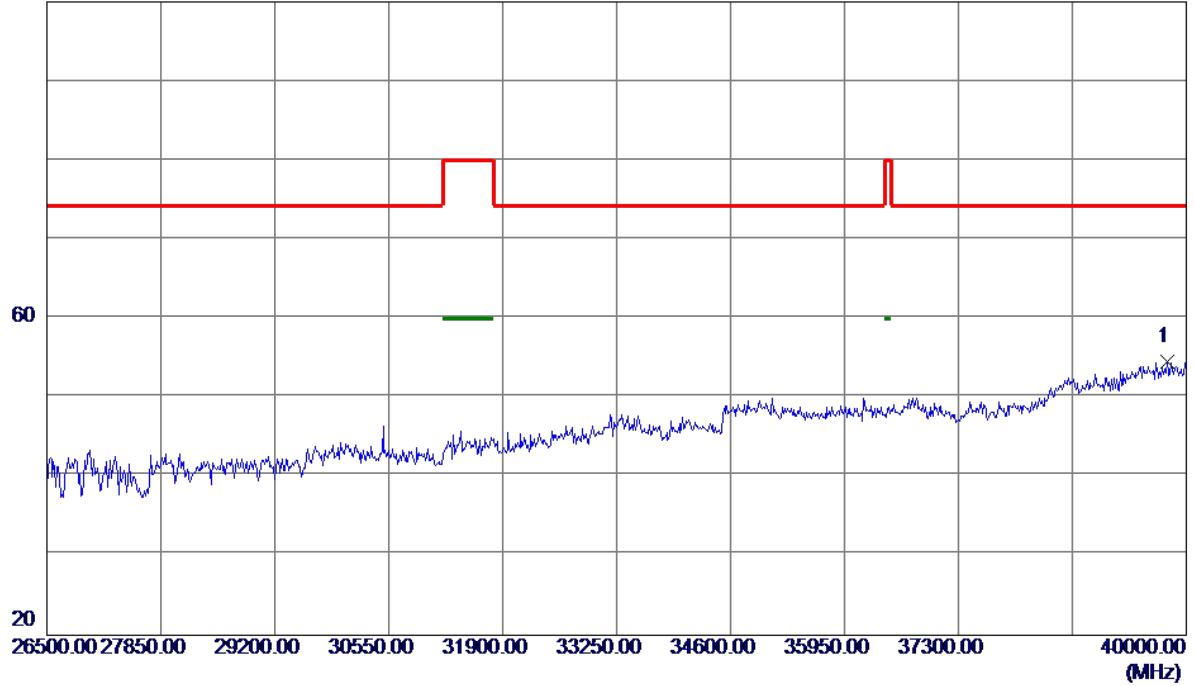

No.	Freq. MHz	Reading Level dBuV/m	Correct Factor dB	Measure ment dBuV/m	Limit dBuV/m	Margin dB	Detector	Comment
1 *	39770.5000	39.11	15.52	54.63	74.30	-19.67	Peak	

Orthogonal Axis:	X
Test Mode:	UNII-1/ TX A Mode 5200MHz

Vertical

130 dBuV/m

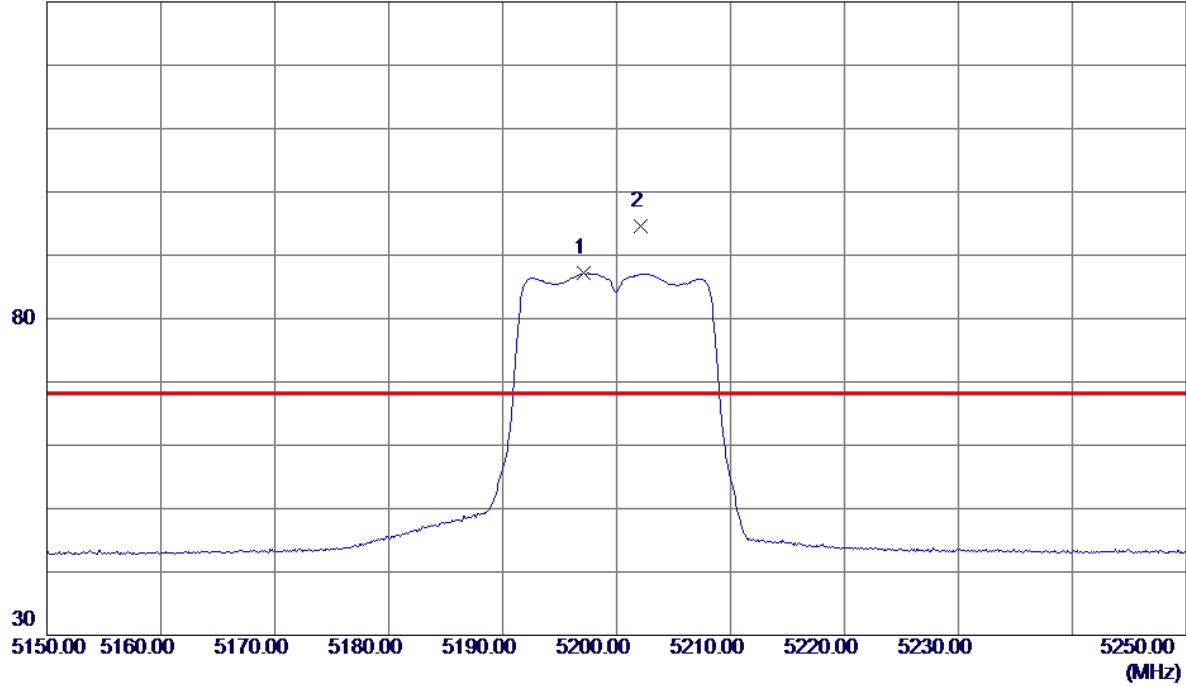

No.	Freq. MHz	Reading Level dBuV/m	Correct Factor dB	Measure ment dBuV/m	Limit dBuV/m	Margin dB	Detector	Comment
1	5197.1000	65.98	21.20	87.18	999.00	-911.82	AVG	No Limit
2 *	5202.1000	73.37	21.22	94.59	68.30	26.29	Peak	No Limit

Orthogonal Axis:	X
Test Mode:	UNII-1/ TX A Mode 5200MHz

Vertical

130 dBuV/m

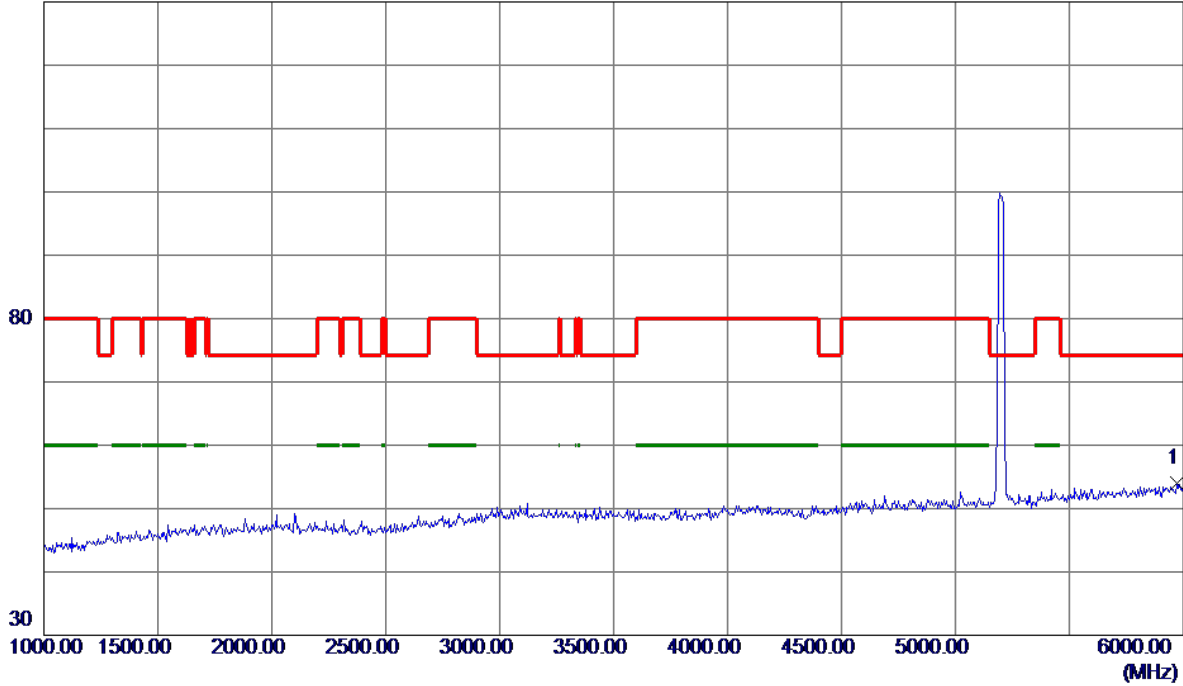

No.	Freq. MHz	Reading Level dBuV/m	Correct Factor dB	Measure ment dBuV/m	Limit dBuV/m	Margin dB	Detector	Comment
1 *	5970.0000	34.61	19.30	53.91	74.30	-20.39	Peak	

Orthogonal Axis:	X
Test Mode:	UNII-1/ TX A Mode 5200MHz

Vertical

130 dBuV/m

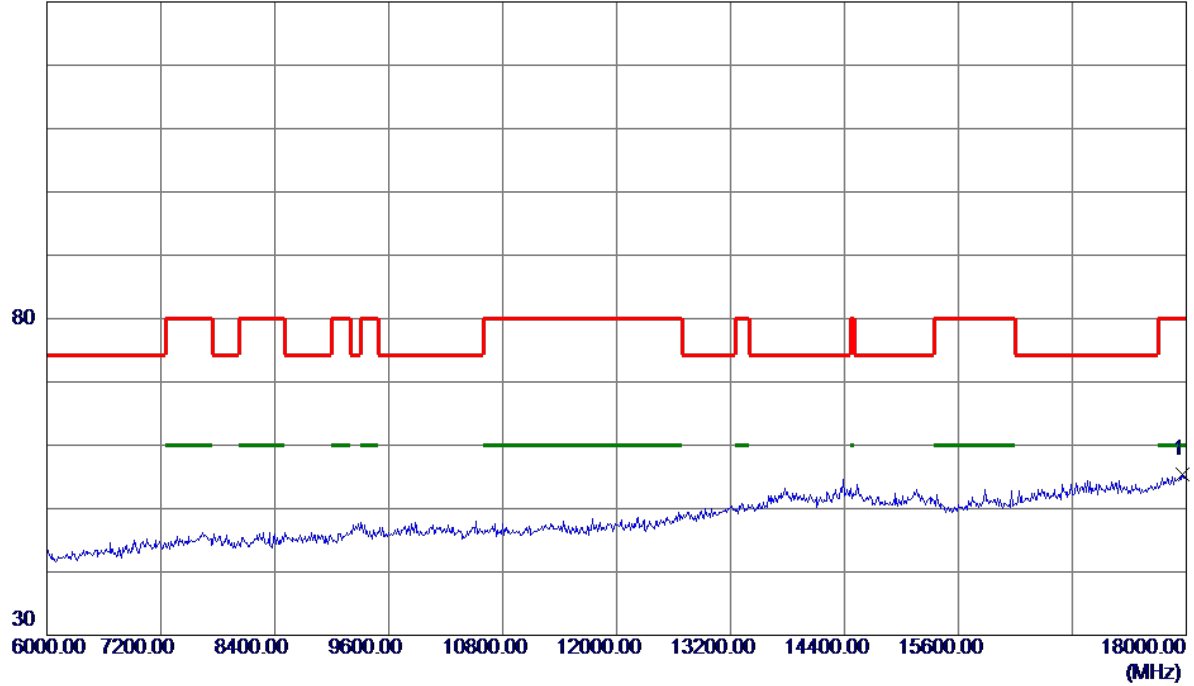

No.	Freq. MHz	Reading Level dBuV/m	Correct Factor dB	Measure ment dBuV/m	Limit dBuV/m	Margin dB	Detector	Comment
1 *	17964.0000	26.28	29.04	55.32	80.00	-24.68	Peak	

Orthogonal Axis:	X
Test Mode:	UNII-1/ TX A Mode 5200MHz

Vertical

100 dBuV/m

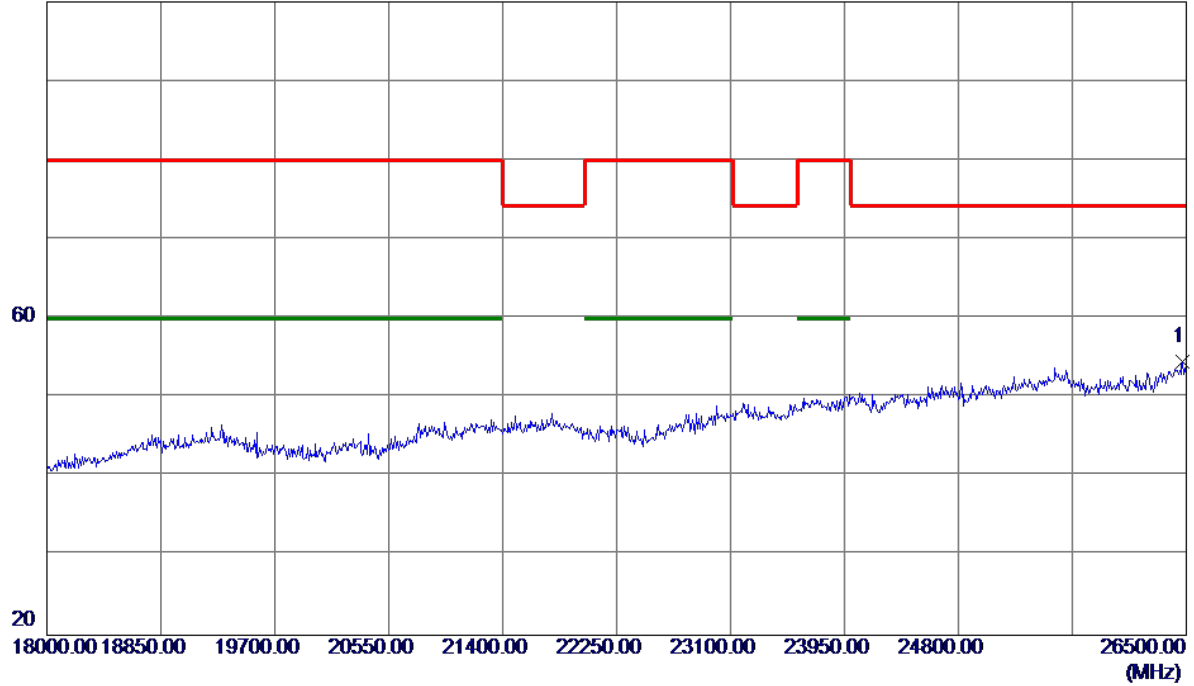

No.	Freq. MHz	Reading Level dBuV/m	Correct Factor dB	Measure ment dBuV/m	Limit dBuV/m	Margin dB	Detector	Comment
1 *	26474.5000	28.57	25.99	54.56	74.30	-19.74	Peak	

Orthogonal Axis:	X
Test Mode:	UNII-1/ TX A Mode 5200MHz

Vertical

100 dBuV/m

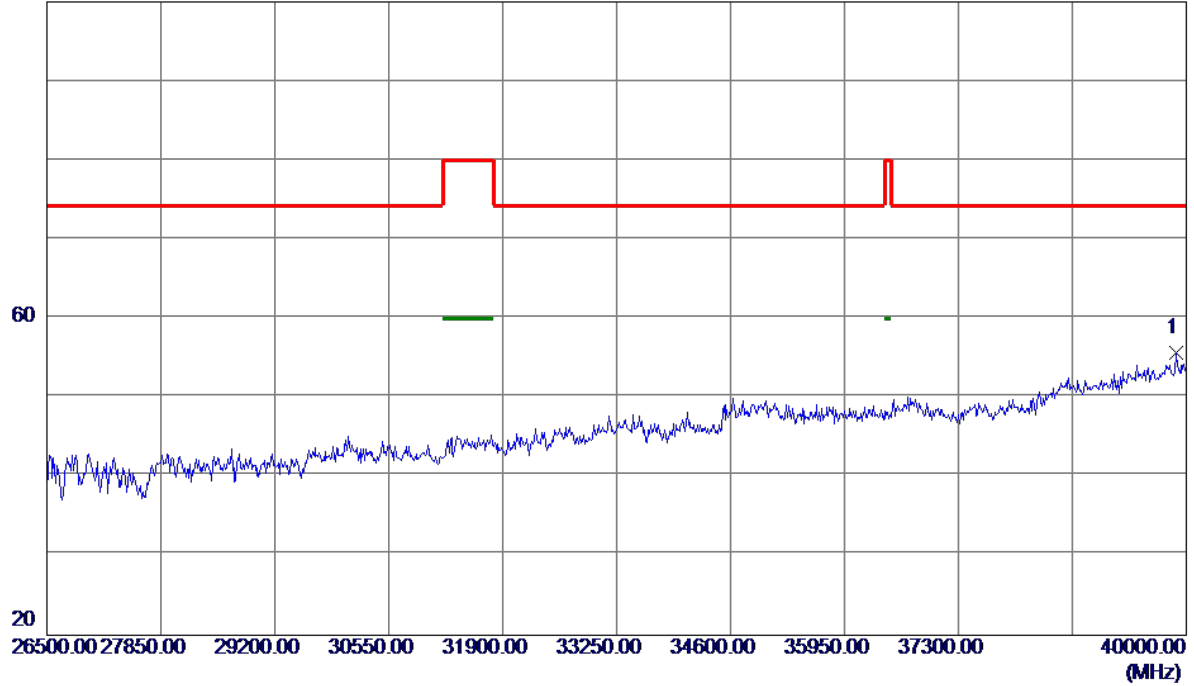

No.	Freq. MHz	Reading Level dBuV/m	Correct Factor dB	Measure ment dBuV/m	Limit dBuV/m	Margin dB	Detector	Comment
1 *	39878.5000	39.93	15.69	55.62	74.30	-18.68	Peak	

Orthogonal Axis:	X
Test Mode:	UNII-1/ TX A Mode 5200MHz

Horizontal

130 dBuV/m

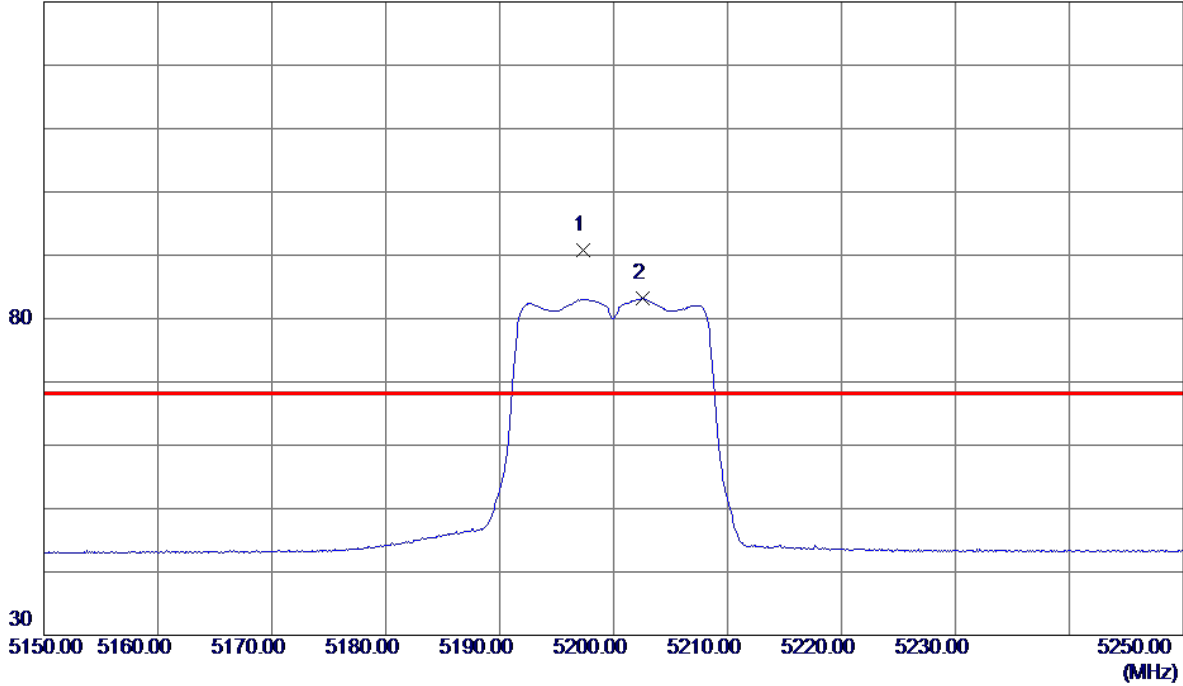

No.	Freq. MHz	Reading Level dBuV/m	Correct Factor dB	Measure ment dBuV/m	Limit dBuV/m	Margin dB	Detector	Comment
1 *	5197.3000	69.59	21.20	90.79	68.30	22.49	Peak	No Limit
2	5202.6000	61.91	21.22	83.13	999.00	-915.87	AVG	No Limit

Orthogonal Axis:	X
Test Mode:	UNII-1/ TX A Mode 5200MHz

Horizontal

130 dBuV/m

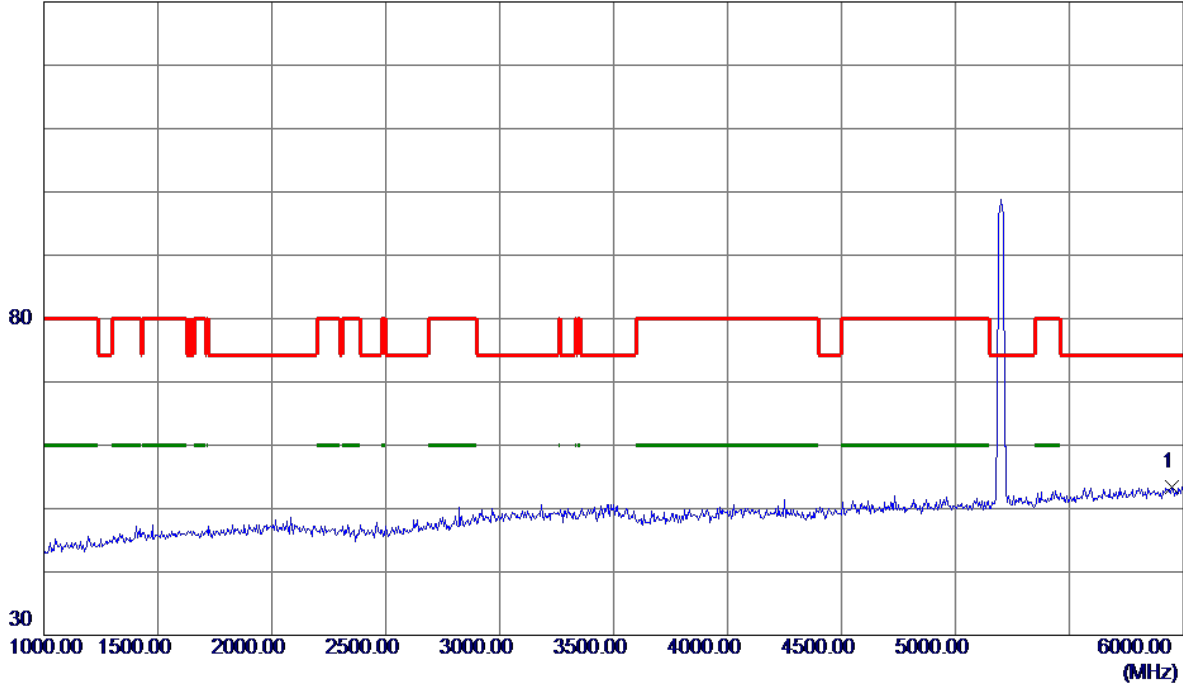

No.	Freq. MHz	Reading Level dBuV/m	Correct Factor dB	Measure ment dBuV/m	Limit dBuV/m	Margin dB	Detector	Comment
1 *	5950.0000	34.09	19.23	53.32	74.30	-20.98	Peak	

Orthogonal Axis:	X
Test Mode:	UNII-1/ TX A Mode 5200MHz

Horizontal

130 dBuV/m

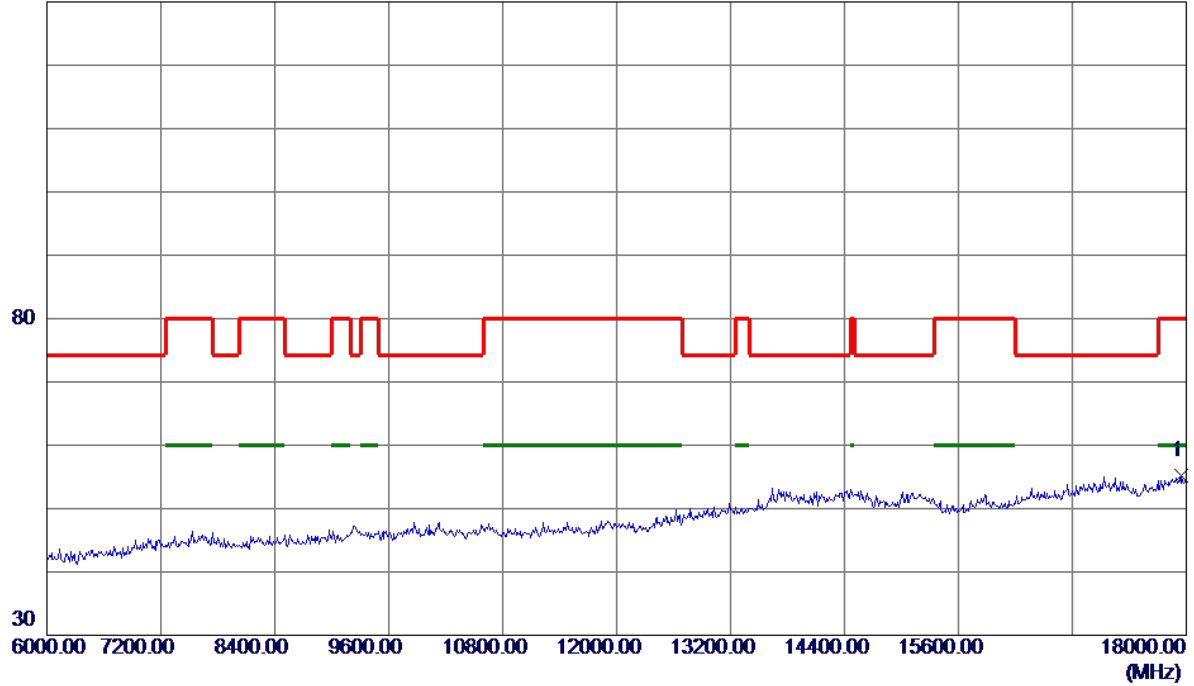

No.	Freq. MHz	Reading Level dBuV/m	Correct Factor dB	Measure ment dBuV/m	Limit dBuV/m	Margin dB	Detector	Comment
1 *	17952.0000	26.10	29.01	55.11	80.00	-24.89	Peak	

Orthogonal Axis:	X
Test Mode:	UNII-1/ TX A Mode 5200MHz

Horizontal

100 dBuV/m

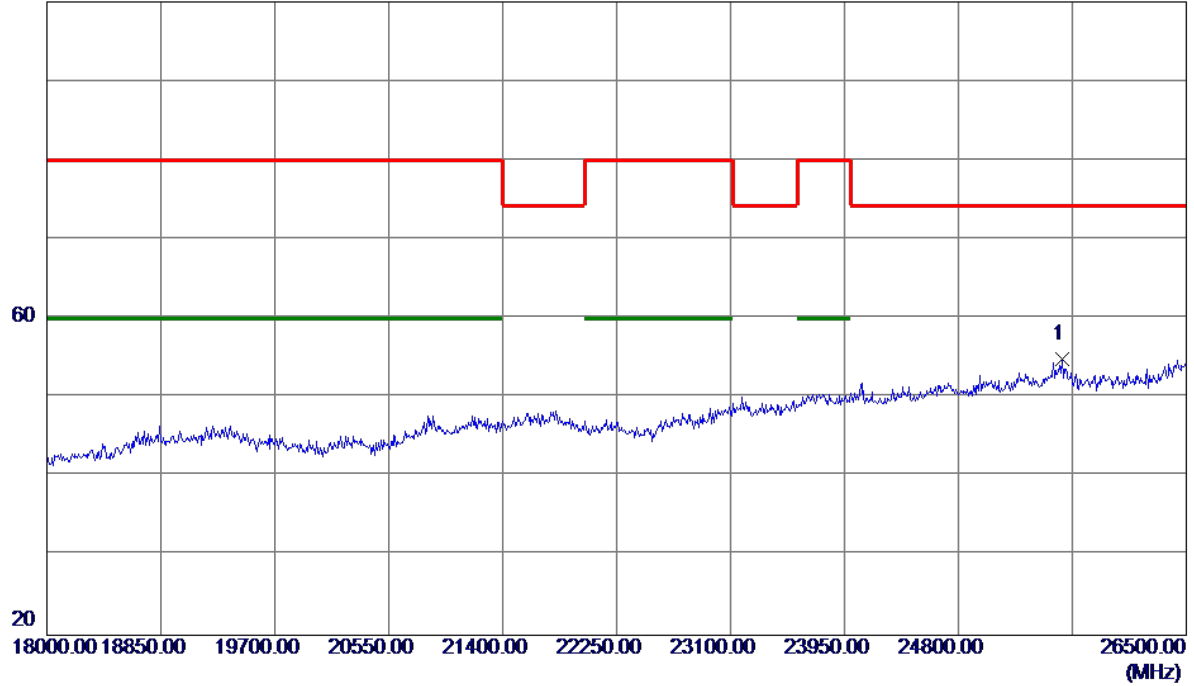

No.	Freq. MHz	Reading Level dBuV/m	Correct Factor dB	Measure ment dBuV/m	Limit dBuV/m	Margin dB	Detector	Comment
1 *	25573.5000	30.98	23.89	54.87	74.30	-19.43	Peak	

Orthogonal Axis:	X
Test Mode:	UNII-1/ TX A Mode 5200MHz

Horizontal

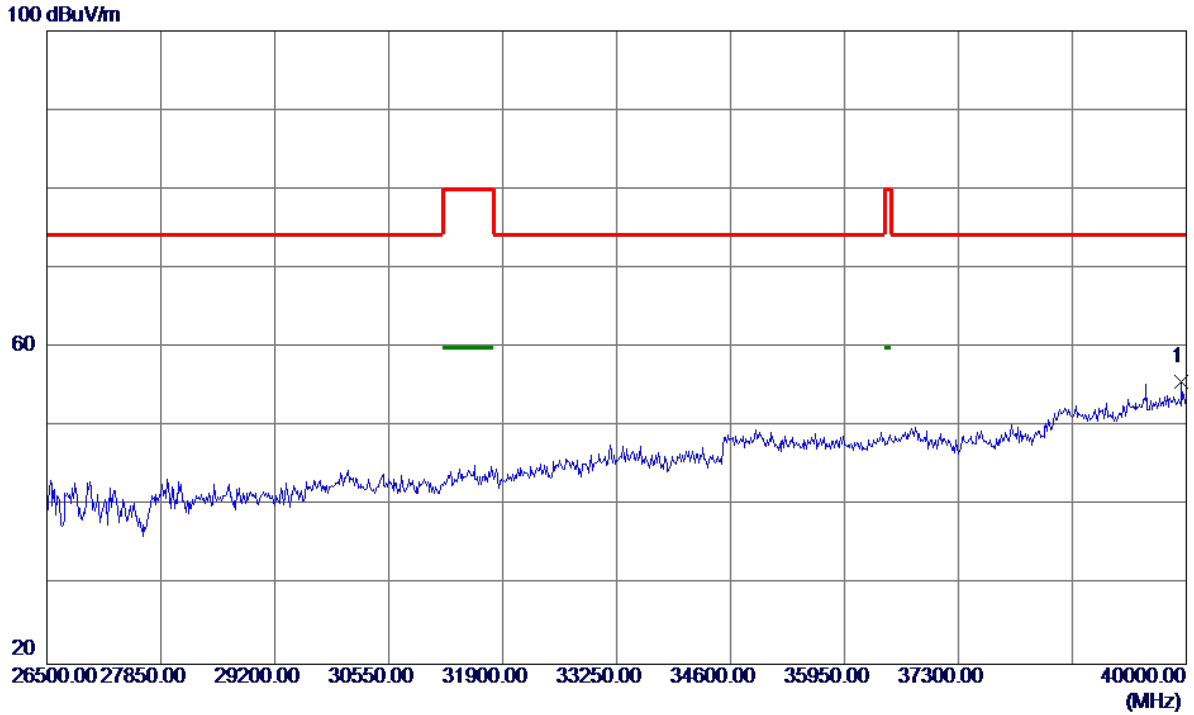

No.	Freq. MHz	Reading Level dBuV/m	Correct Factor dB	Measure ment dBuV/m	Limit dBuV/m	Margin dB	Detector	Comment
1 *	39946.0000	39.95	15.80	55.75	74.30	-18.55	Peak	

Orthogonal Axis:	X
Test Mode:	UNII-1/ TX A Mode 5240MHz

Vertical

130 dBuV/m

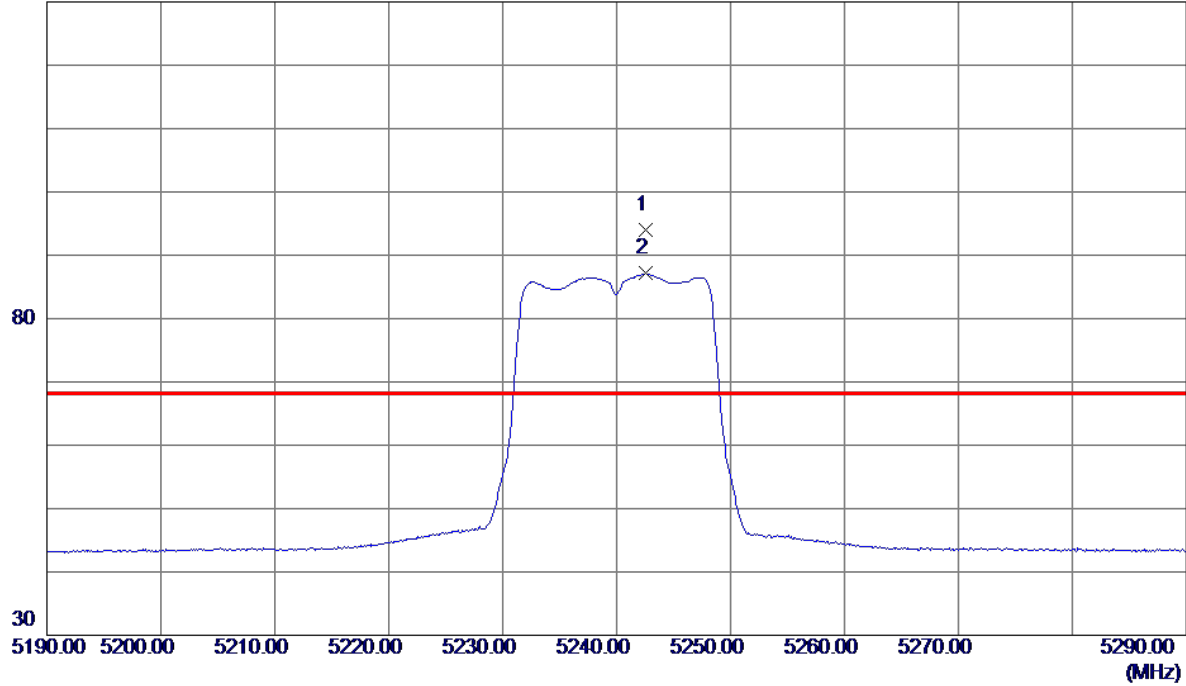

No.	Freq. MHz	Reading Level dBuV/m	Correct Factor dB	Measure ment dBuV/m	Limit dBuV/m	Margin dB	Detector	Comment
1 *	5242.6000	72.60	21.37	93.97	68.30	25.67	Peak	No Limit
2	5242.6000	65.75	21.37	87.12	999.00	-911.88	AVG	No Limit

Orthogonal Axis:	X
Test Mode:	UNII-1/ TX A Mode 5240MHz

Vertical

130 dBuV/m

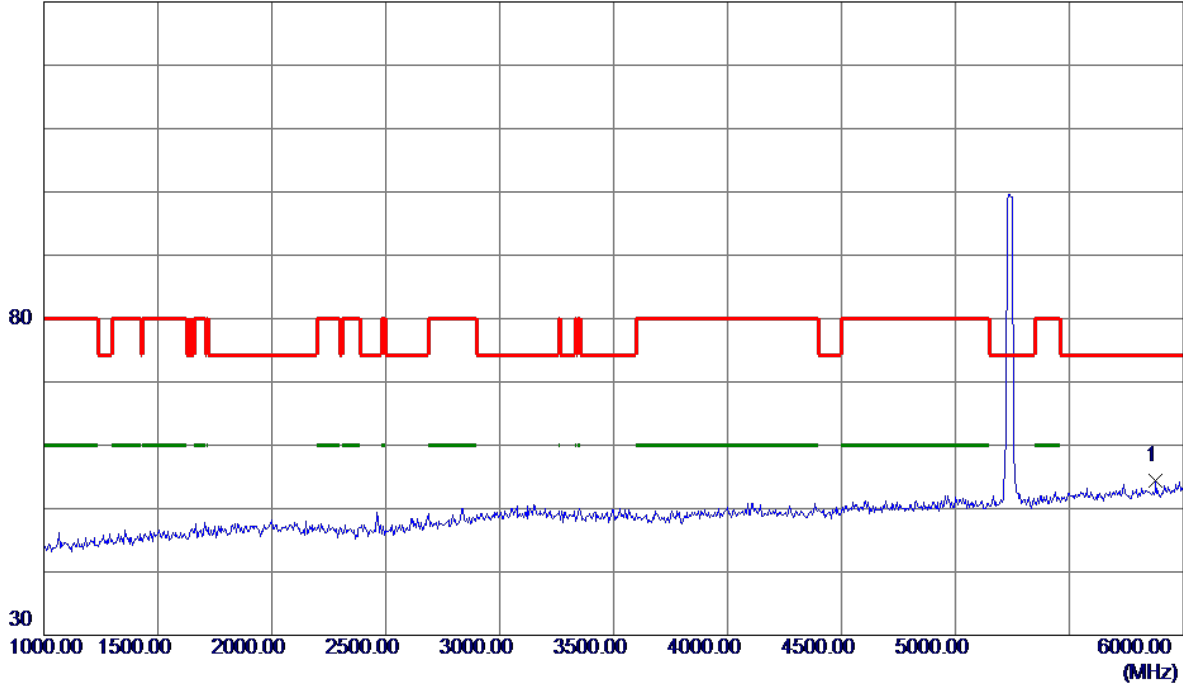

No.	Freq. MHz	Reading Level dBuV/m	Correct Factor dB	Measure ment dBuV/m	Limit dBuV/m	Margin dB	Detector	Comment
1 *	5880.0000	35.38	18.99	54.37	74.30	-19.93	Peak	

Orthogonal Axis:	X
Test Mode:	UNII-1/ TX A Mode 5240MHz

Vertical

130 dBuV/m

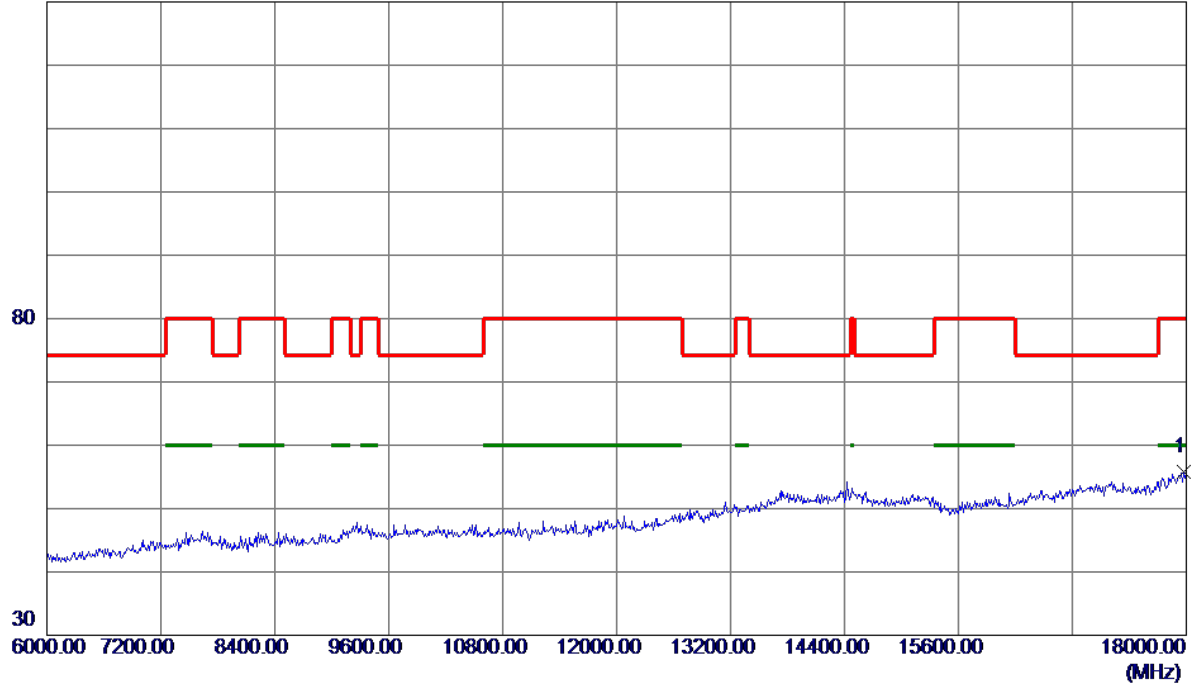

No.	Freq. MHz	Reading Level dBuV/m	Correct Factor dB	Measure ment dBuV/m	Limit dBuV/m	Margin dB	Detector	Comment
1 *	17976.0000	26.64	29.08	55.72	80.00	-24.28	Peak	

Orthogonal Axis:	X
Test Mode:	UNII-1/ TX A Mode 5240MHz

Vertical

100 dBuV/m

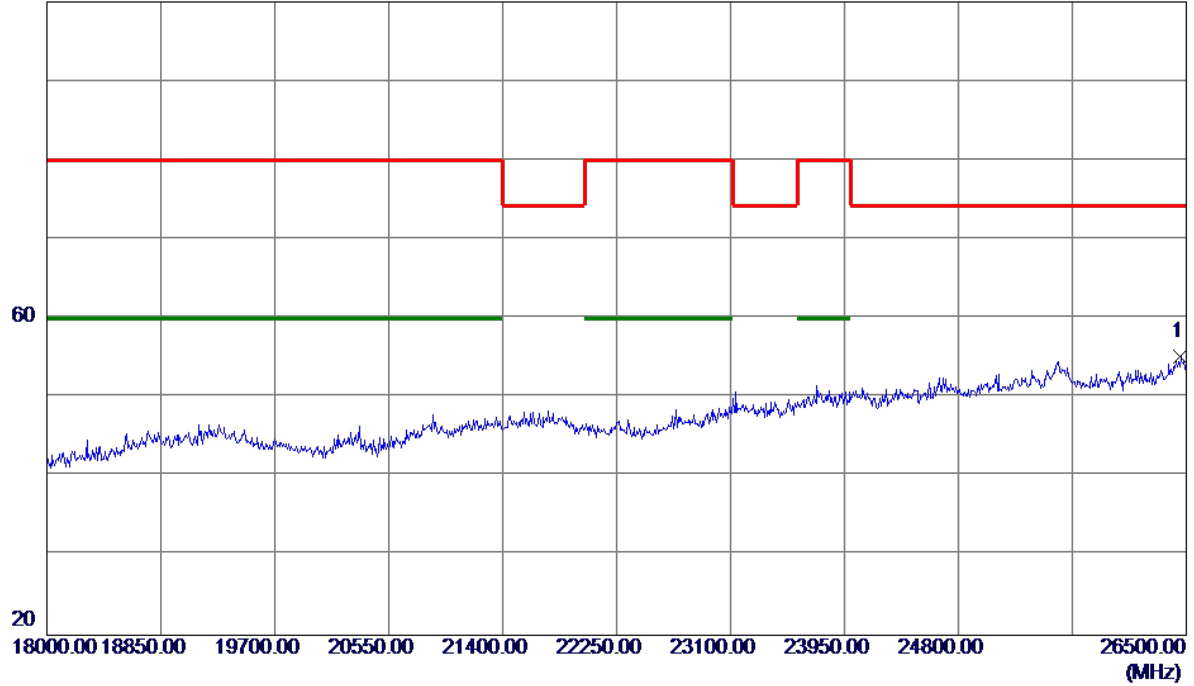

No.	Freq. MHz	Reading Level dBuV/m	Correct Factor dB	Measure ment dBuV/m	Limit dBuV/m	Margin dB	Detector	Comment
1 *	26457.5000	29.24	25.90	55.14	74.30	-19.16	Peak	

Orthogonal Axis:	X
Test Mode:	UNII-1/ TX A Mode 5240MHz

Vertical

100 dBuV/m

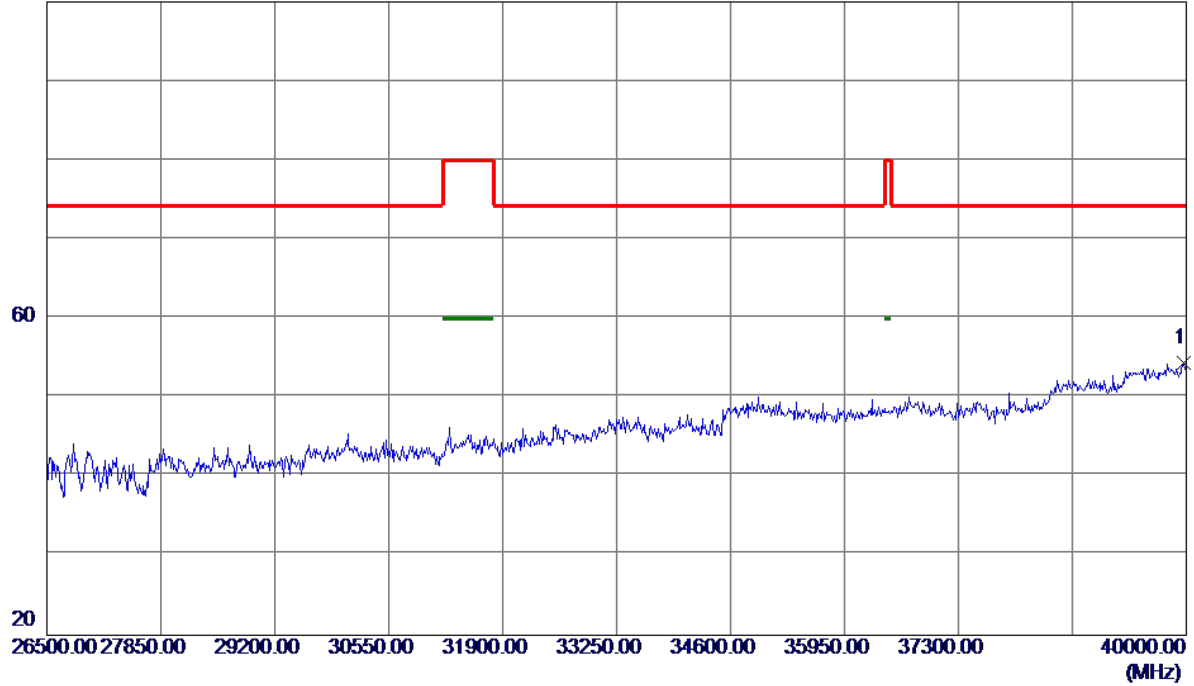

No.	Freq. MHz	Reading Level dBuV/m	Correct Factor dB	Measure ment dBuV/m	Limit dBuV/m	Margin dB	Detector	Comment
1 *	39973.0000	38.50	15.85	54.35	74.30	-19.95	Peak	

Orthogonal Axis:	X
Test Mode:	UNII-1/ TX A Mode 5240MHz

Horizontal

130 dBuV/m

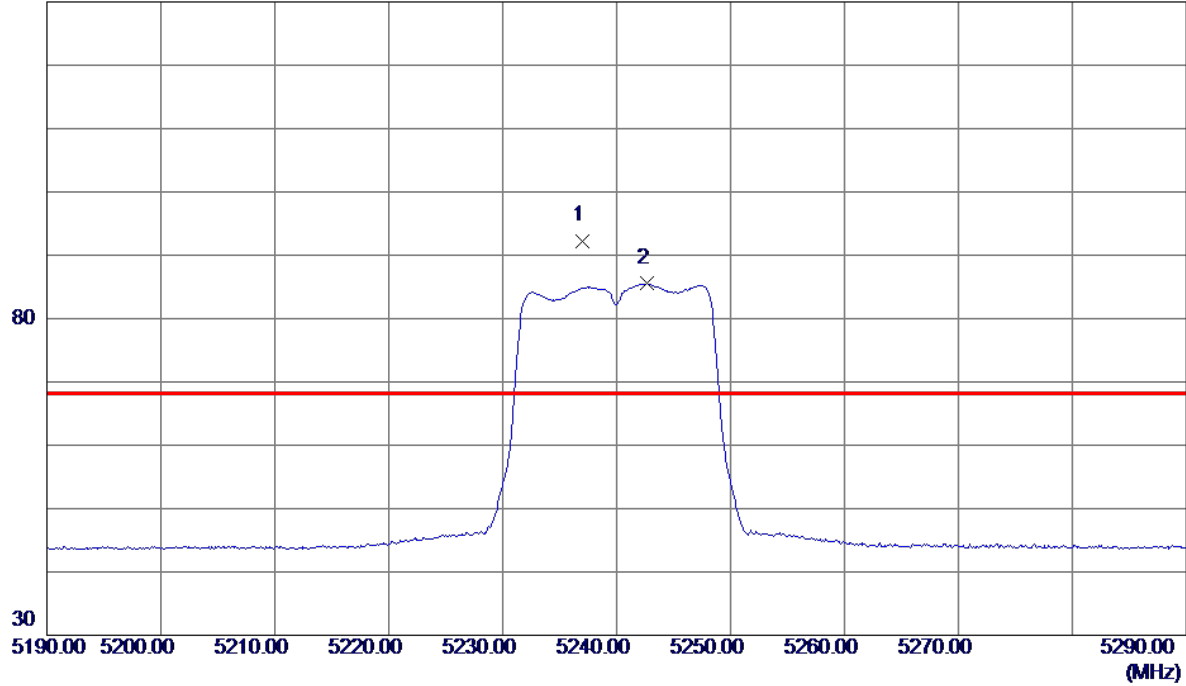

No.	Freq. MHz	Reading Level dBuV/m	Correct Factor dB	Measure ment dBuV/m	Limit dBuV/m	Margin dB	Detector	Comment
1 *	5237.0000	70.95	21.35	92.30	68.30	24.00	Peak	No Limit
2	5242.7000	64.22	21.37	85.59	999.00	-913.41	AVG	No Limit

Orthogonal Axis:	X
Test Mode:	UNII-1/ TX A Mode 5240MHz

Horizontal

130 dBuV/m

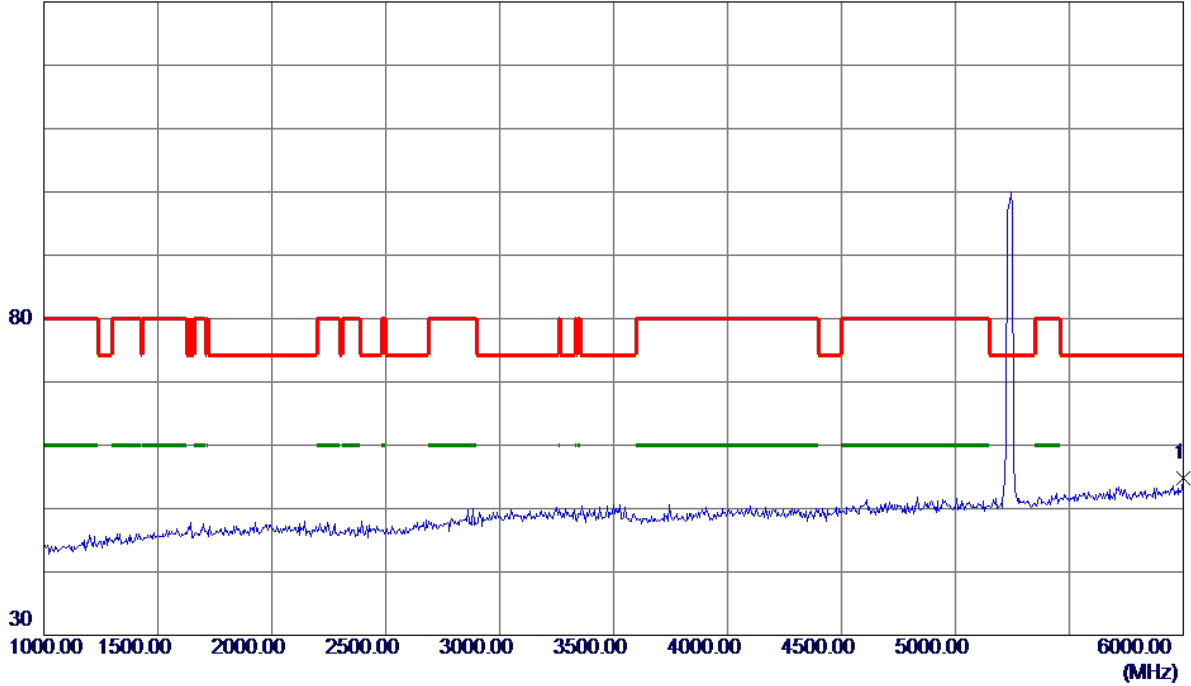

No.	Freq. MHz	Reading Level dBuV/m	Correct Factor dB	Measure ment dBuV/m	Limit dBuV/m	Margin dB	Detector	Comment
1 *	6000.0000	35.44	19.41	54.85	74.30	-19.45	Peak	

Orthogonal Axis:	X
Test Mode:	UNII-1/ TX A Mode 5240MHz

Horizontal

130 dBuV/m

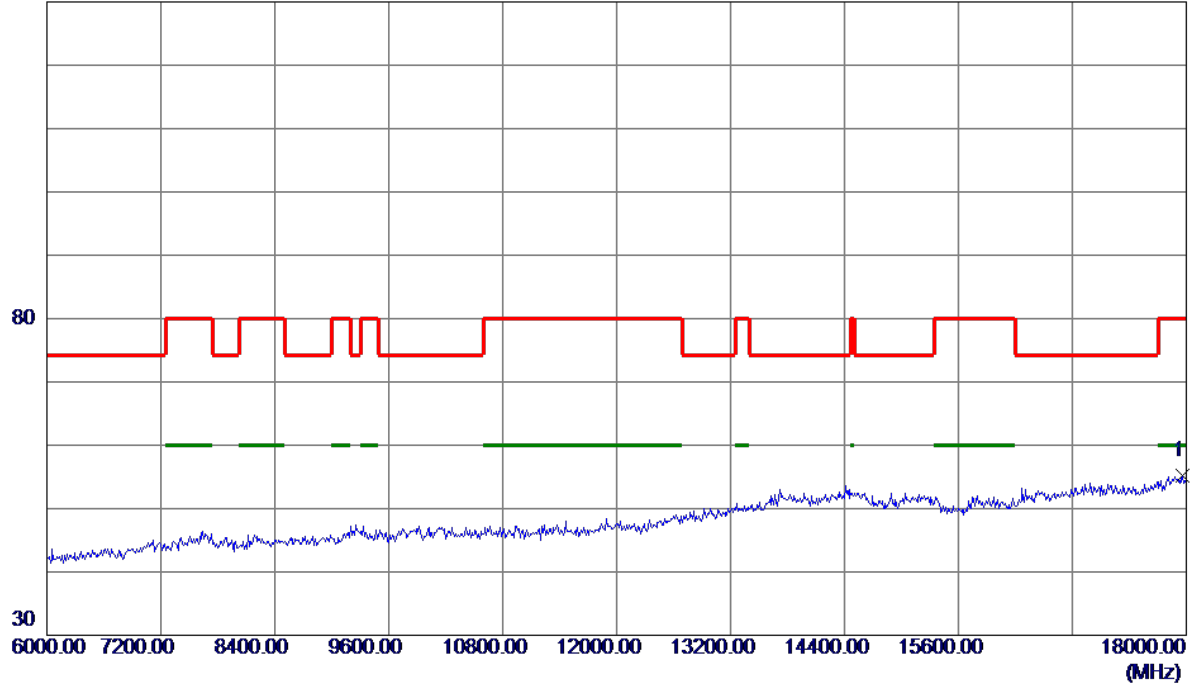

No.	Freq. MHz	Reading Level dBuV/m	Correct Factor dB	Measure ment dBuV/m	Limit dBuV/m	Margin dB	Detector	Comment
1 *	17964.0000	26.08	29.04	55.12	80.00	-24.88	Peak	

Orthogonal Axis:	X
Test Mode:	UNII-1/ TX A Mode 5240MHz

Horizontal

100 dBuV/m

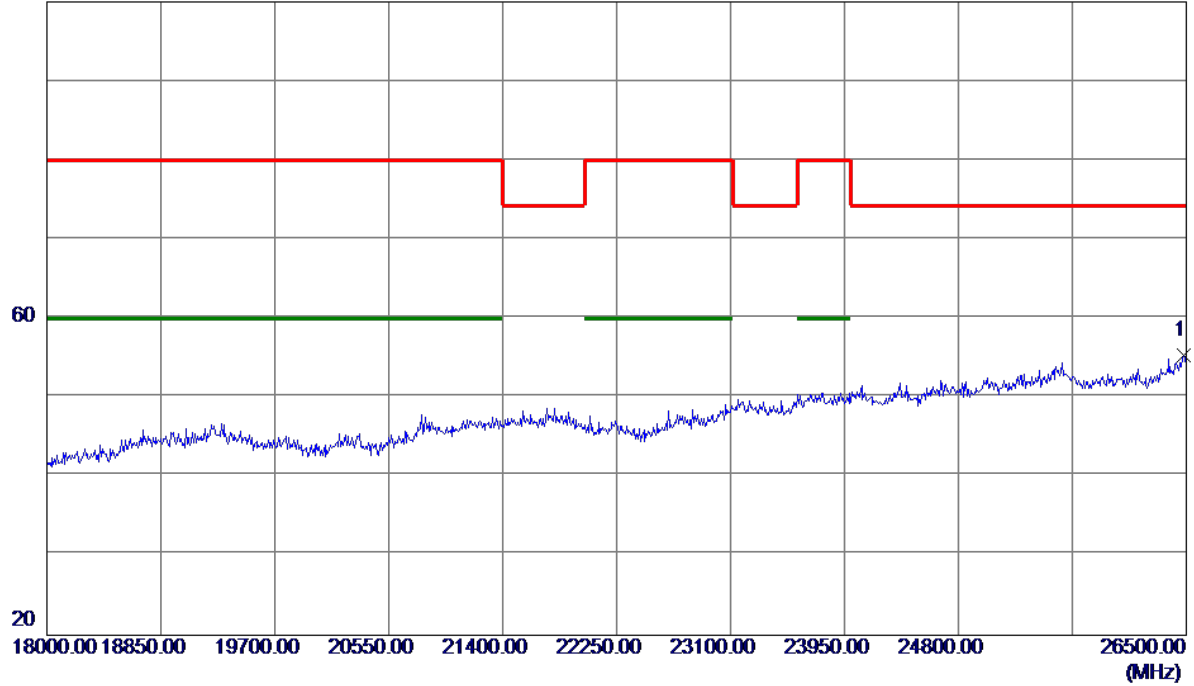

No.	Freq. MHz	Reading Level dBuV/m	Correct Factor dB	Measure ment dBuV/m	Limit dBuV/m	Margin dB	Detector	Comment
1 *	26483.0000	29.28	26.03	55.31	74.30	-18.99	Peak	

Orthogonal Axis:	X
Test Mode:	UNII-1/ TX A Mode 5240MHz

Horizontal

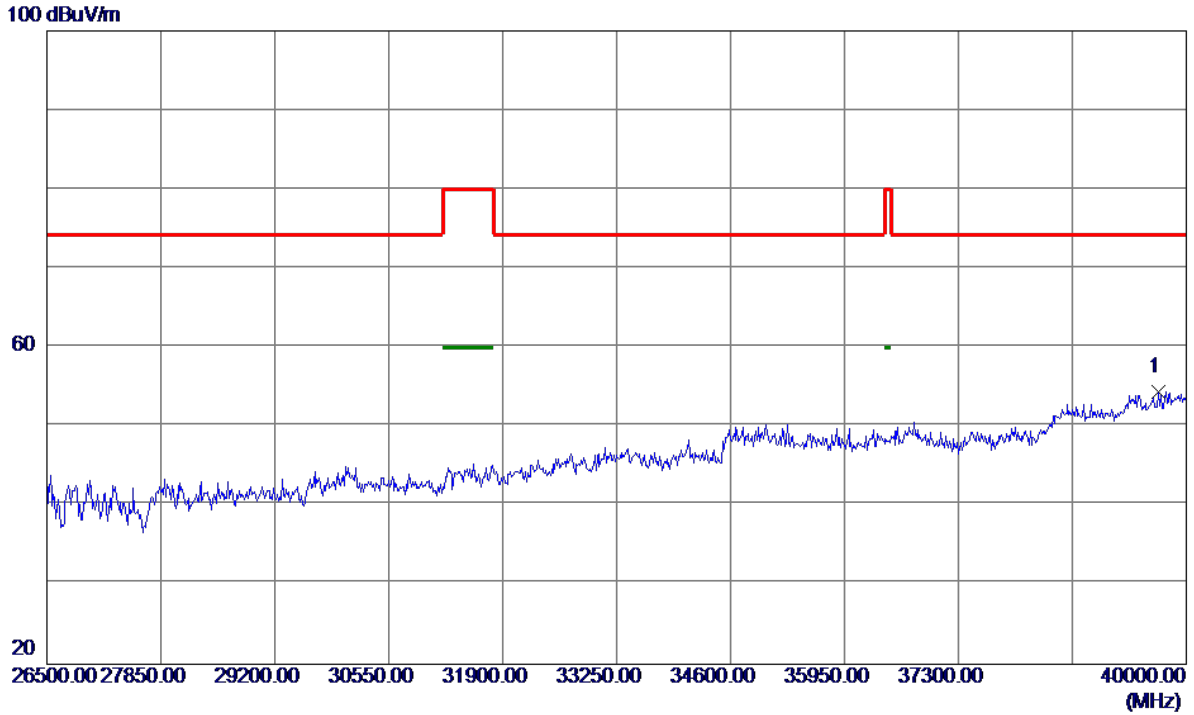

No.	Freq. MHz	Reading Level dBuV/m	Correct Factor dB	Measure ment dBuV/m	Limit dBuV/m	Margin dB	Detector	Comment
1 *	39676.0000	39.05	15.37	54.42	74.30	-19.88	Peak	

Orthogonal Axis:	X
Test Mode:	UNII-1/ TX N20 Mode 5180MHz

Vertical

130 dBuV/m

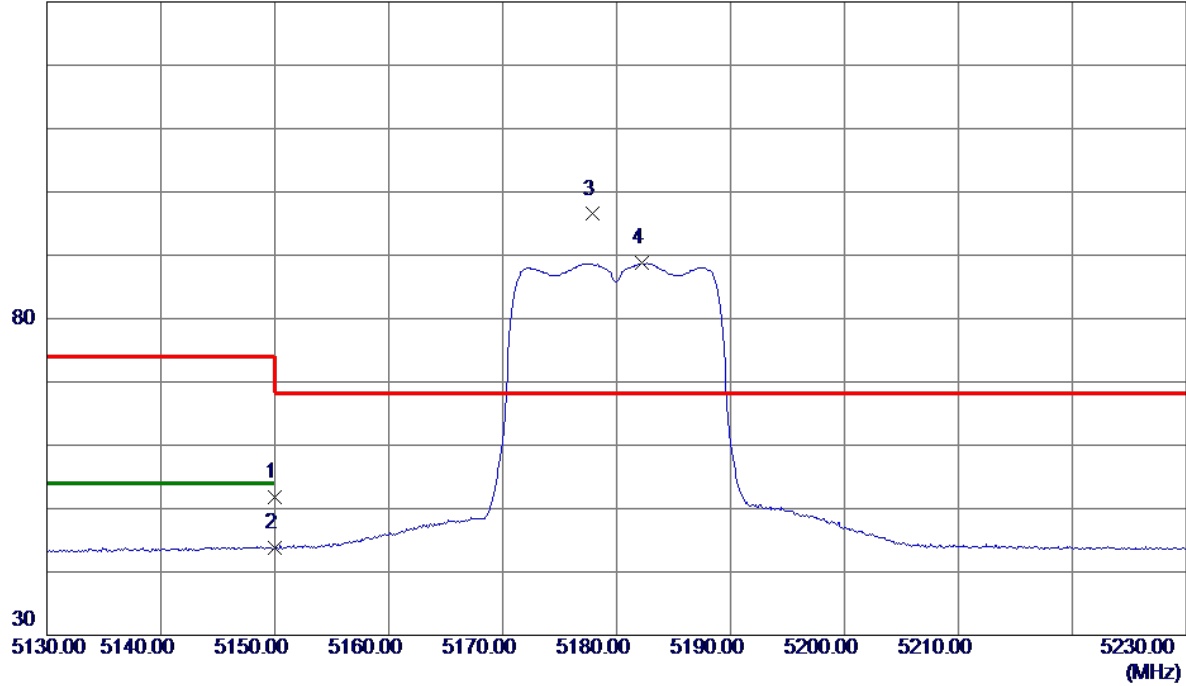

No.	Freq. MHz	Reading Level dBuV/m	Correct Factor dB	Measure ment dBuV/m	Limit dBuV/m	Margin dB	Detector	Comment
1	5150.0000	30.82	21.03	51.85	74.00	-22.15	Peak	
2	5150.0000	22.86	21.03	43.89	54.00	-10.11	AVG	
3 *	5177.9000	75.37	21.13	96.50	68.30	28.20	Peak	No Limit
4	5182.2000	67.58	21.15	88.73	999.00	-910.27	AVG	No Limit

Orthogonal Axis:	X
Test Mode:	UNII-1/ TX N20 Mode 5180MHz

Vertical

130 dBuV/m

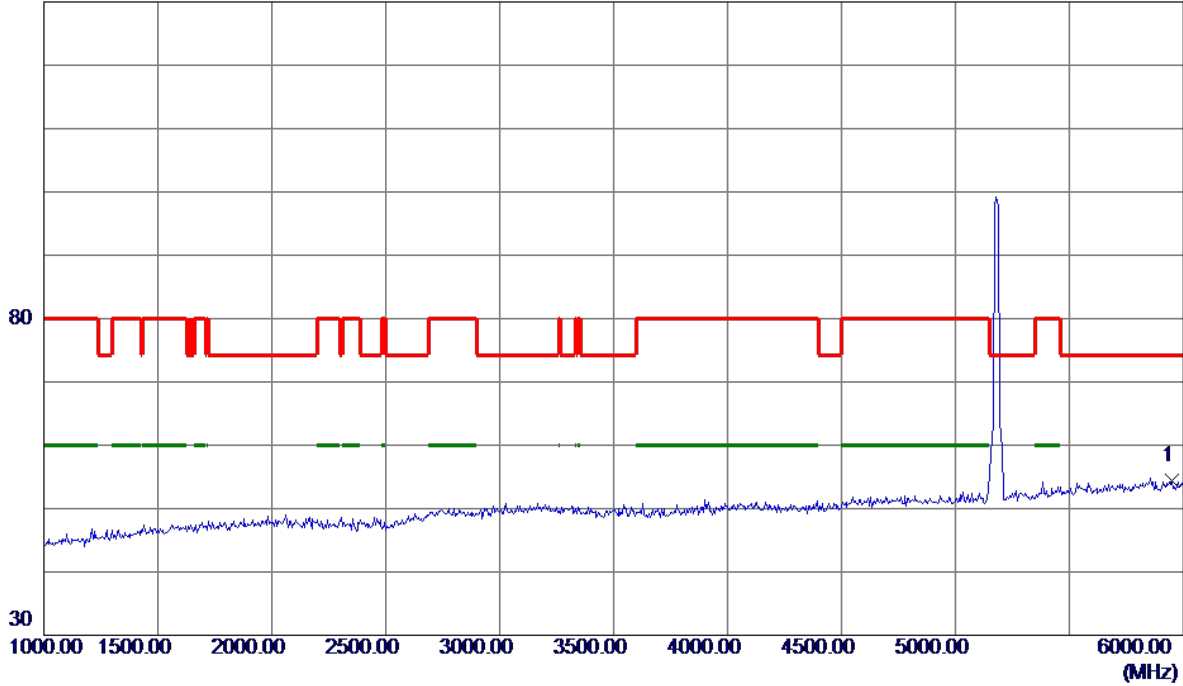

No.	Freq. MHz	Reading Level dBuV/m	Correct Factor dB	Measure ment dBuV/m	Limit dBuV/m	Margin dB	Detector	Comment
1 *	5950.0000	35.24	19.23	54.47	74.30	-19.83	Peak	

Orthogonal Axis:	X
Test Mode:	UNII-1/ TX N20 Mode 5180MHz

Vertical

130 dBuV/m

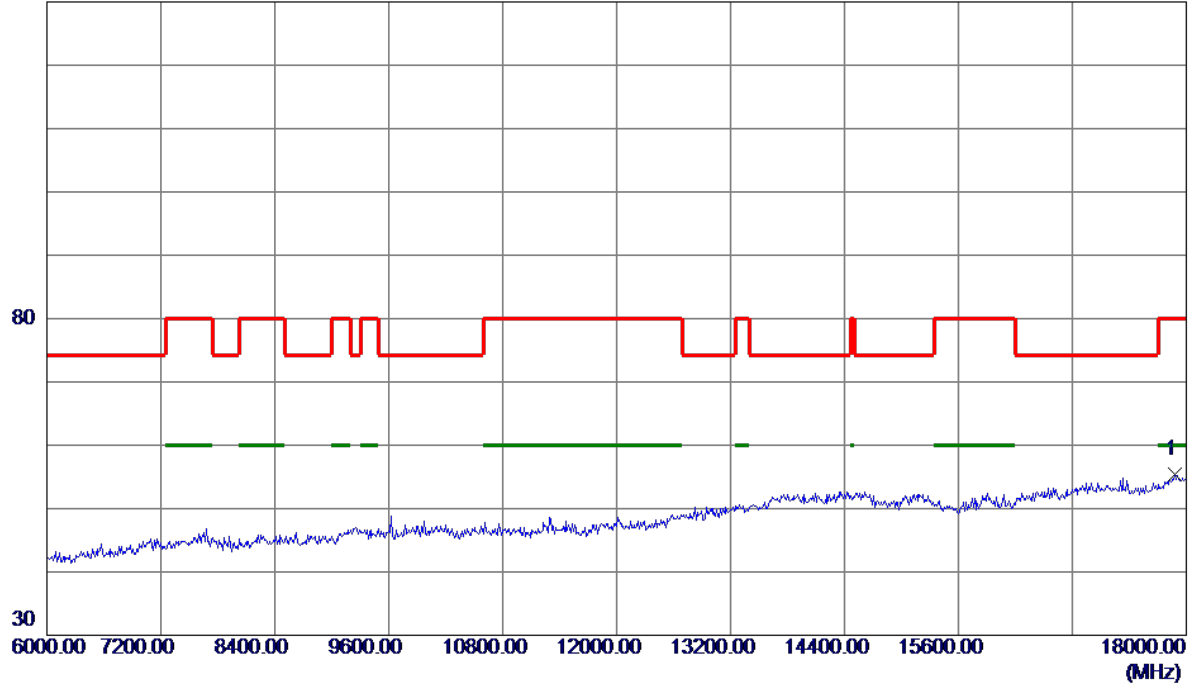

No.	Freq. MHz	Reading Level dBuV/m	Correct Factor dB	Measure ment dBuV/m	Limit dBuV/m	Margin dB	Detector	Comment
1 *	17880.0000	26.57	28.77	55.34	80.00	-24.66	Peak	

Orthogonal Axis:	X
Test Mode:	UNII-1/ TX N20 Mode 5180MHz

Vertical

100 dBuV/m

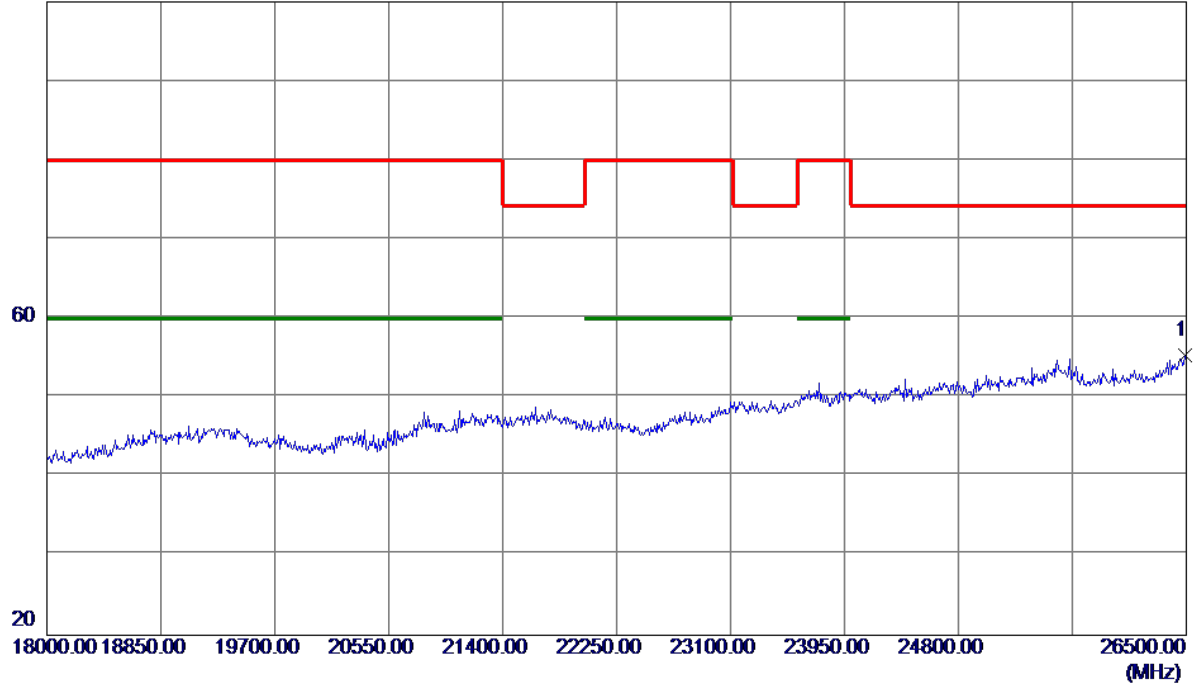

No.	Freq. MHz	Reading Level dBuV/m	Correct Factor dB	Measure ment dBuV/m	Limit dBuV/m	Margin dB	Detector	Comment
1 *	26491.5000	29.28	26.07	55.35	74.30	-18.95	Peak	

Orthogonal Axis:	X
Test Mode:	UNII-1/ TX N20 Mode 5180MHz

Vertical

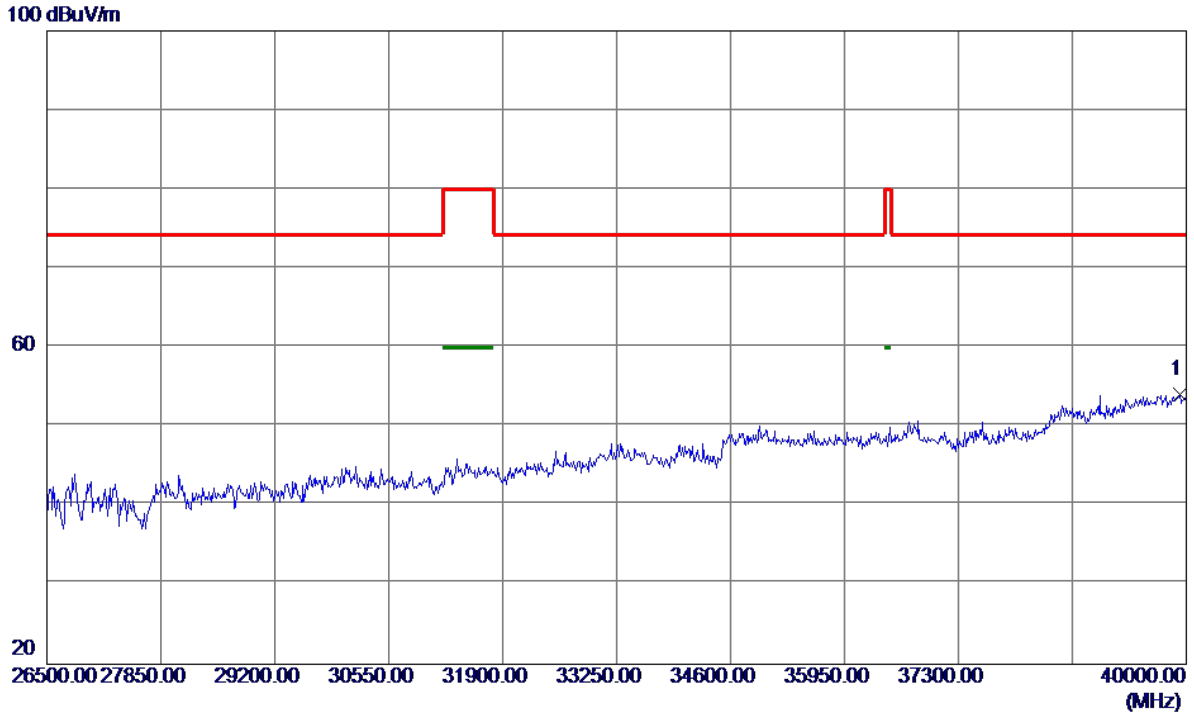

No.	Freq. MHz	Reading Level dBuV/m	Correct Factor dB	Measure ment dBuV/m	Limit dBuV/m	Margin dB	Detector	Comment
1 *	39919.0000	38.37	15.76	54.13	74.30	-20.17	Peak	

Orthogonal Axis:	X
Test Mode:	UNII-1/ TX N20 Mode 5180MHz

Horizontal

130 dBuV/m

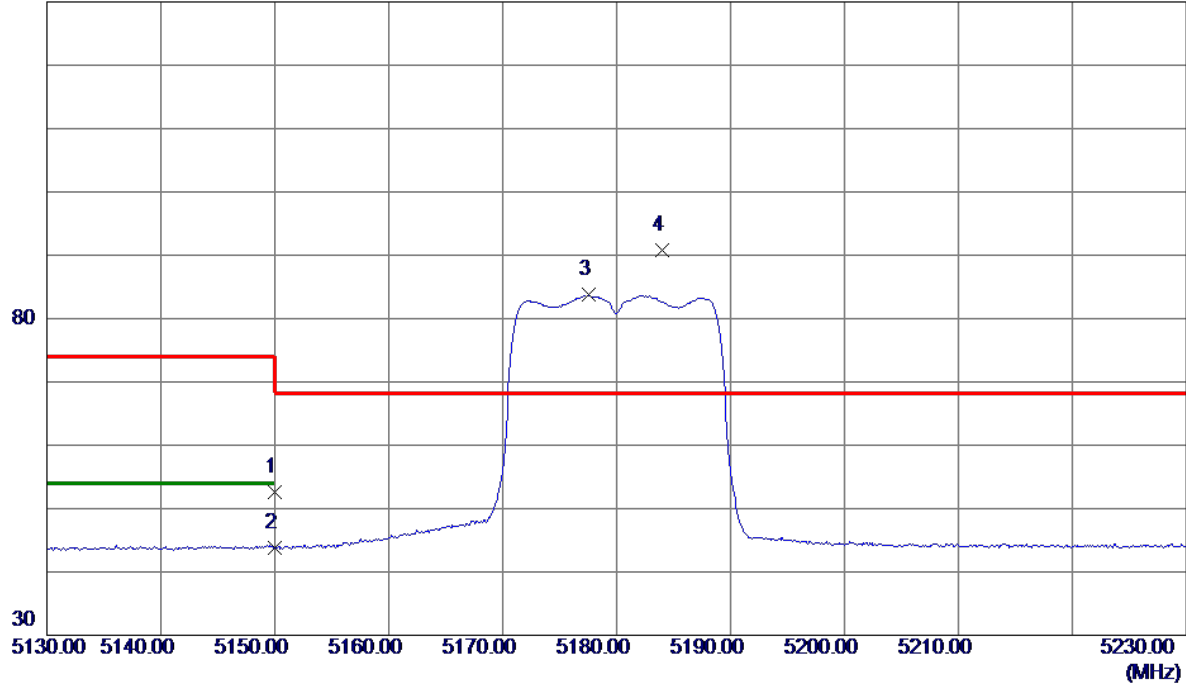

No.	Freq. MHz	Reading Level dBuV/m	Correct Factor dB	Measure ment dBuV/m	Limit dBuV/m	Margin dB	Detector	Comment
1	5150.0000	31.61	21.03	52.64	74.00	-21.36	Peak	
2	5150.0000	22.73	21.03	43.76	54.00	-10.24	AVG	
3	5177.6000	62.62	21.13	83.75	999.00	-915.25	AVG	No Limit
4 *	5184.0000	69.72	21.16	90.88	68.30	22.58	Peak	No Limit

Orthogonal Axis:	X
Test Mode:	UNII-1/ TX N20 Mode 5180MHz

Horizontal

130 dBuV/m

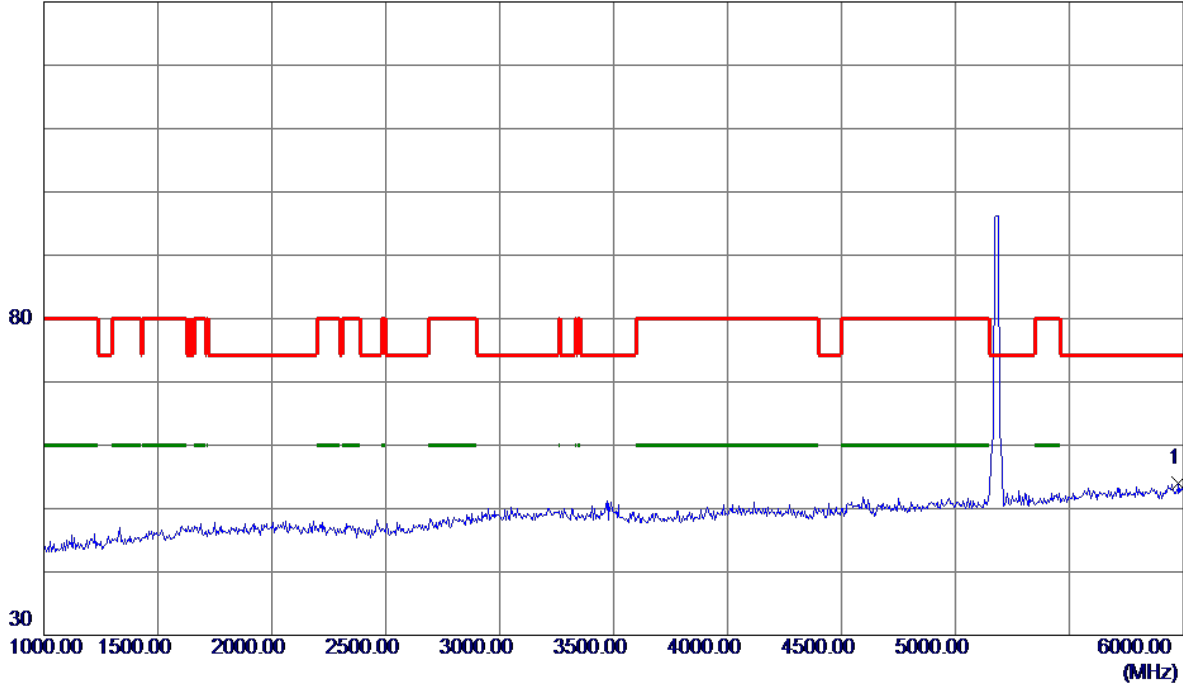

No.	Freq. MHz	Reading Level dBuV/m	Correct Factor dB	Measure ment dBuV/m	Limit dBuV/m	Margin dB	Detector	Comment
1 *	5980.0000	34.64	19.34	53.98	74.30	-20.32	Peak	

Orthogonal Axis:	X
Test Mode:	UNII-1/ TX N20 Mode 5180MHz

Horizontal

130 dBuV/m

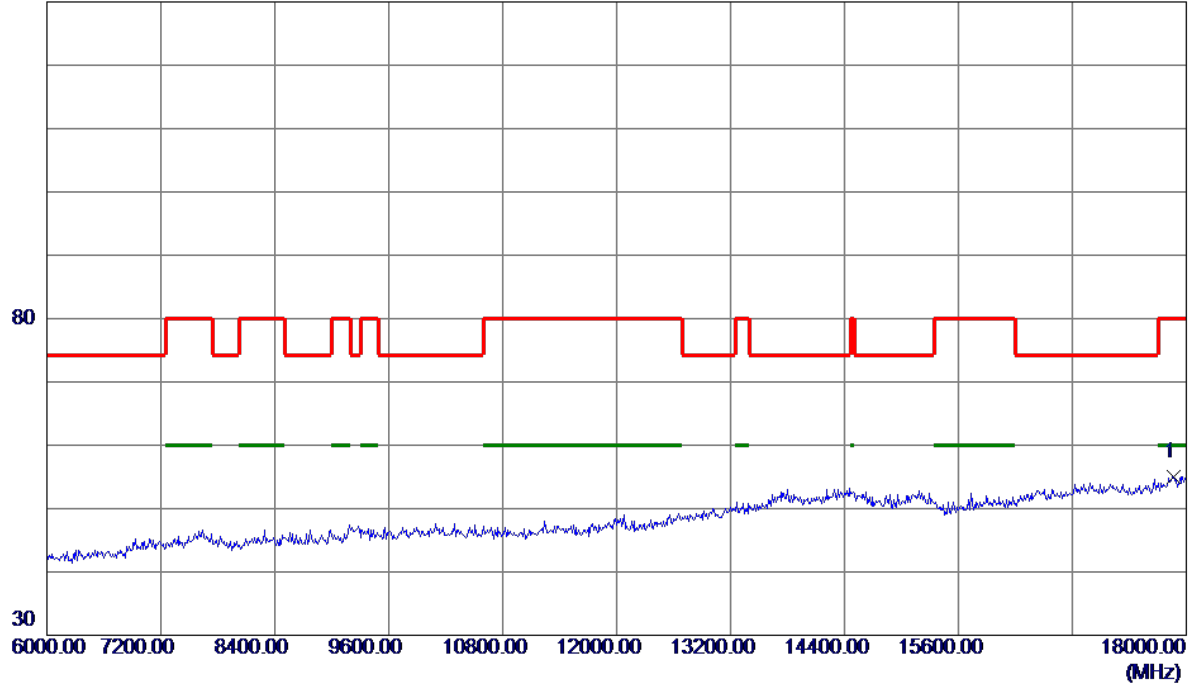

No.	Freq. MHz	Reading Level dBuV/m	Correct Factor dB	Measure ment dBuV/m	Limit dBuV/m	Margin dB	Detector	Comment
1 *	17868.0000	26.27	28.74	55.01	80.00	-24.99	Peak	

Orthogonal Axis:	X
Test Mode:	UNII-1/ TX N20 Mode 5180MHz

Horizontal

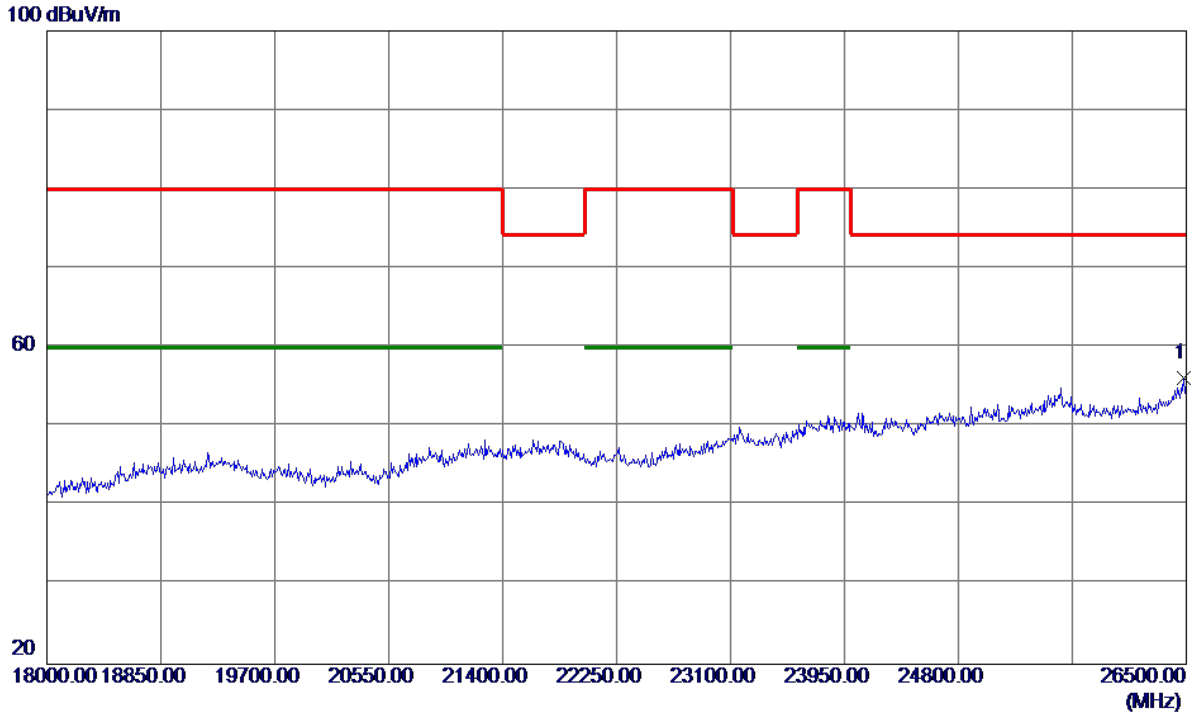

No.	Freq. MHz	Reading Level dBuV/m	Correct Factor dB	Measure ment dBuV/m	Limit dBuV/m	Margin dB	Detector	Comment
1 *	26483.0000	30.16	26.03	56.19	74.30	-18.11	Peak	

Orthogonal Axis:	X
Test Mode:	UNII-1/ TX N20 Mode 5180MHz

Horizontal

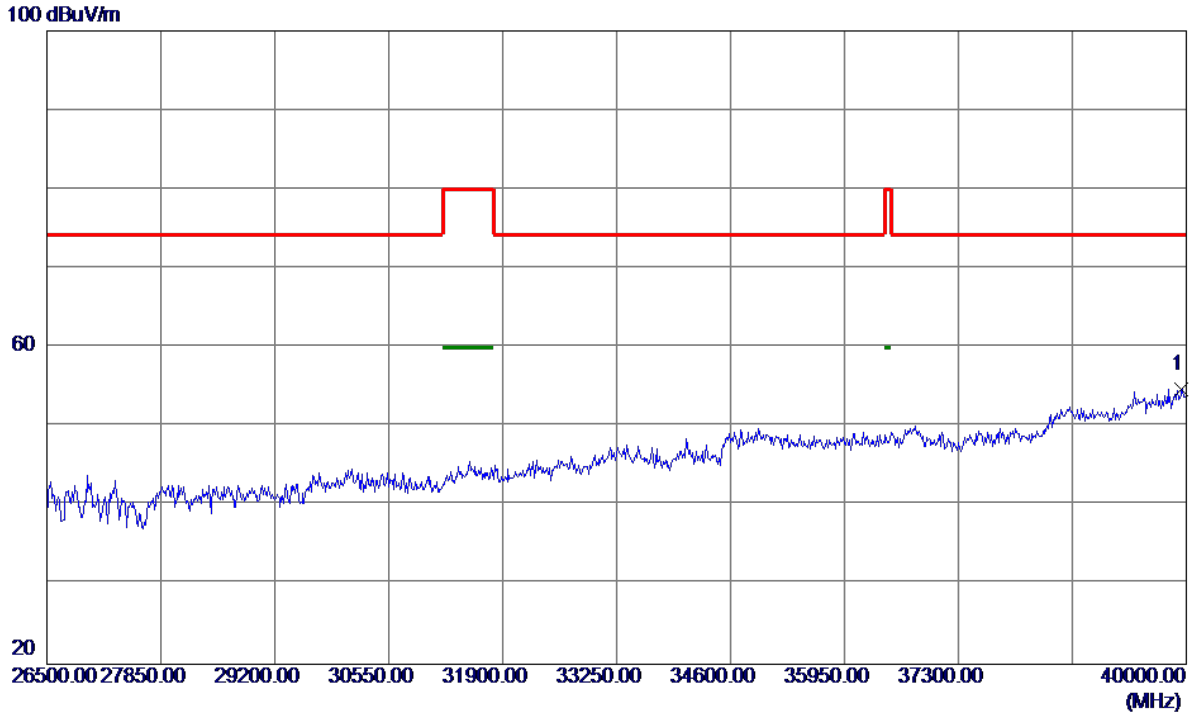

No.	Freq. MHz	Reading Level dBuV/m	Correct Factor dB	Measure ment dBuV/m	Limit dBuV/m	Margin dB	Detector	Comment
1 *	39946.0000	38.98	15.80	54.78	74.30	-19.52	Peak	

Orthogonal Axis:	X
Test Mode:	UNII-1/ TX N20 Mode 5200MHz

Vertical

130 dBuV/m

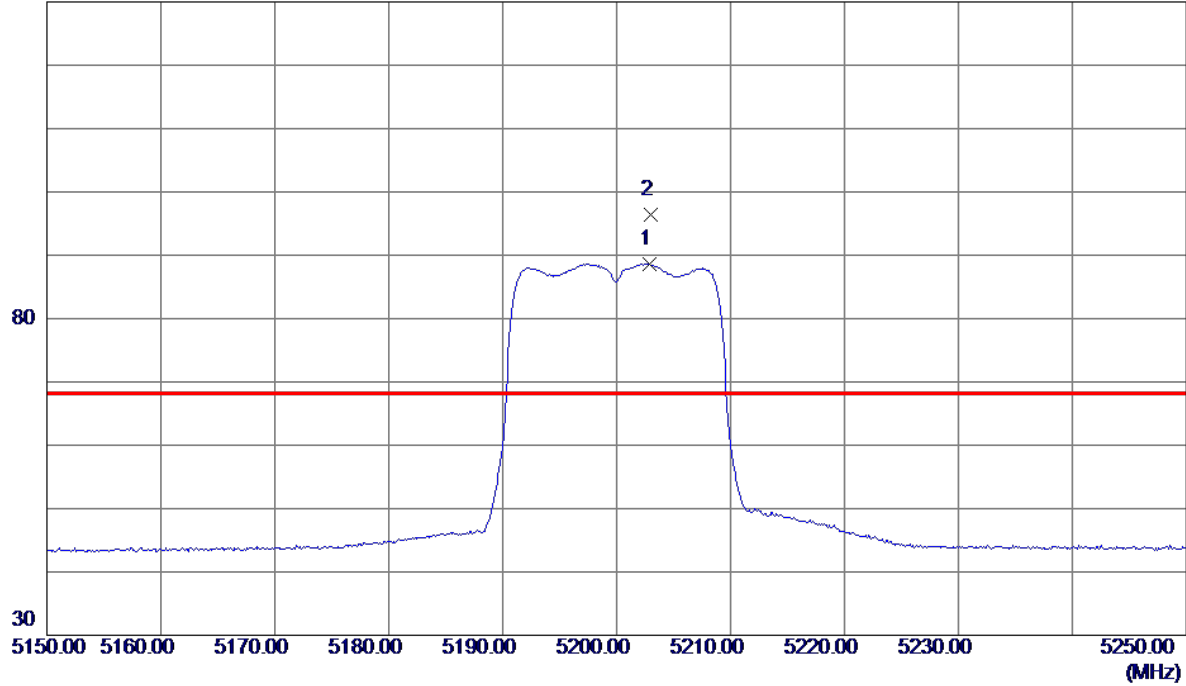

No.	Freq. MHz	Reading Level dBuV/m	Correct Factor dB	Measure ment dBuV/m	Limit dBuV/m	Margin dB	Detector	Comment
1	5202.9000	67.45	21.22	88.67	999.00	-910.33	AVG	No Limit
2 *	5203.0000	75.22	21.22	96.44	68.30	28.14	Peak	No Limit

Orthogonal Axis:	X
Test Mode:	UNII-1/ TX N20 Mode 5200MHz

Vertical

130 dBuV/m

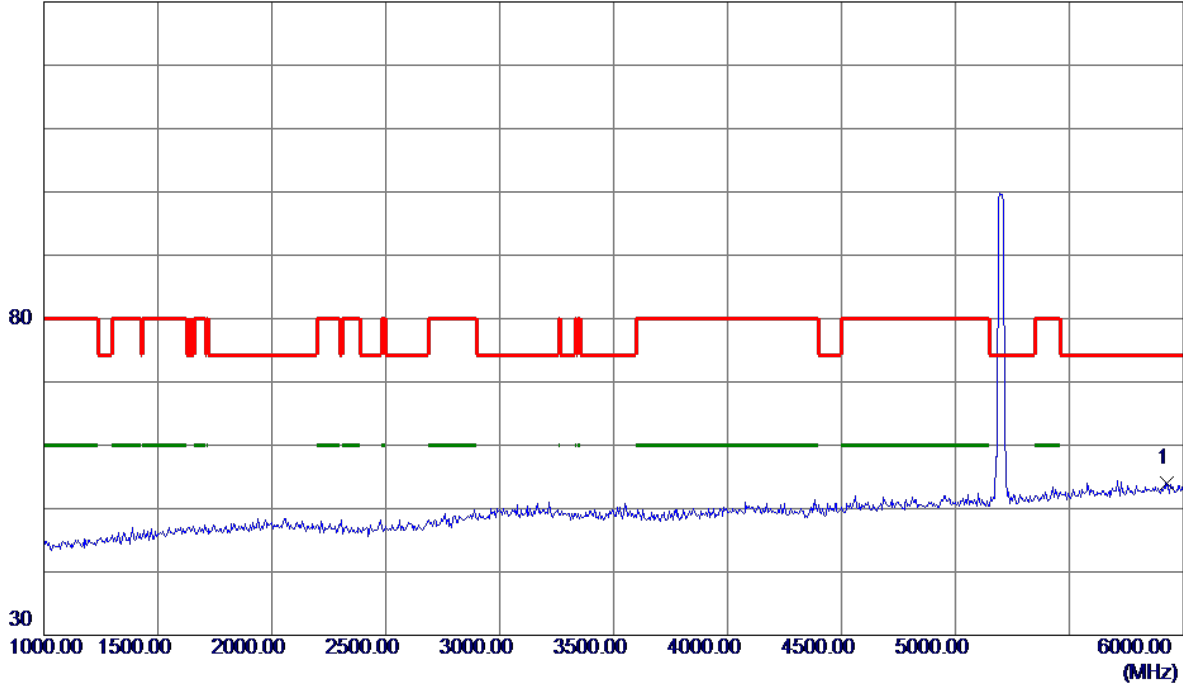

No.	Freq. MHz	Reading Level dBuV/m	Correct Factor dB	Measure ment dBuV/m	Limit dBuV/m	Margin dB	Detector	Comment
1 *	5930.0000	34.91	19.16	54.07	74.30	-20.23	Peak	

Orthogonal Axis:	X
Test Mode:	UNII-1/ TX N20 Mode 5200MHz

Vertical

130 dBuV/m

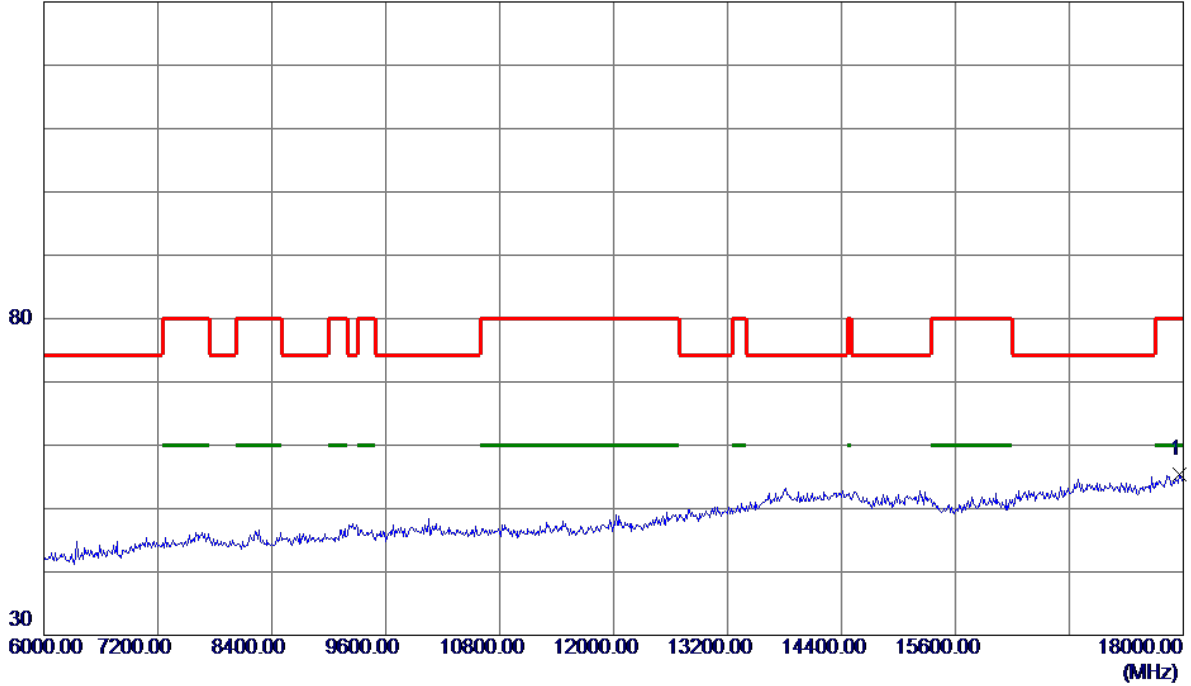

No.	Freq. MHz	Reading Level dBuV/m	Correct Factor dB	Measure ment dBuV/m	Limit dBuV/m	Margin dB	Detector	Comment
1 *	17964.0000	26.34	29.04	55.38	80.00	-24.62	Peak	

Orthogonal Axis:	X
Test Mode:	UNII-1/ TX N20 Mode 5200MHz

Vertical

100 dBuV/m

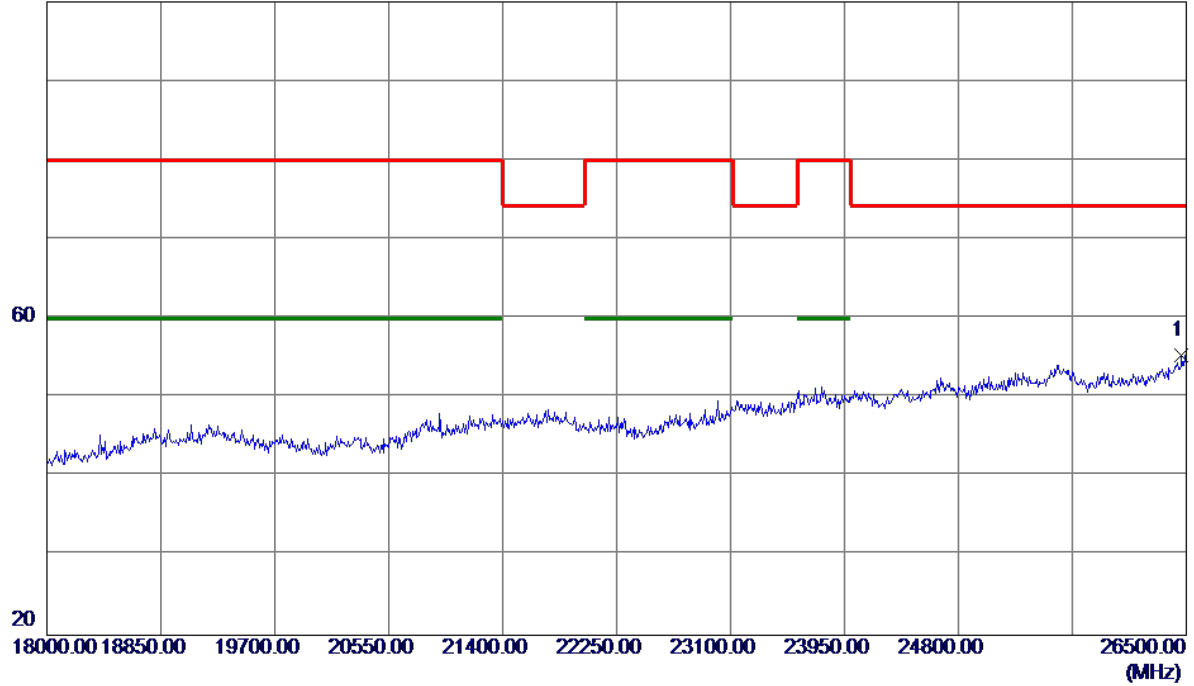

No.	Freq. MHz	Reading Level dBuV/m	Correct Factor dB	Measure ment dBuV/m	Limit dBuV/m	Margin dB	Detector	Comment
1 *	26466.0000	29.44	25.94	55.38	74.30	-18.92	Peak	

Orthogonal Axis:	X
Test Mode:	UNII-1/ TX N20 Mode 5200MHz

Vertical

100 dBuV/m

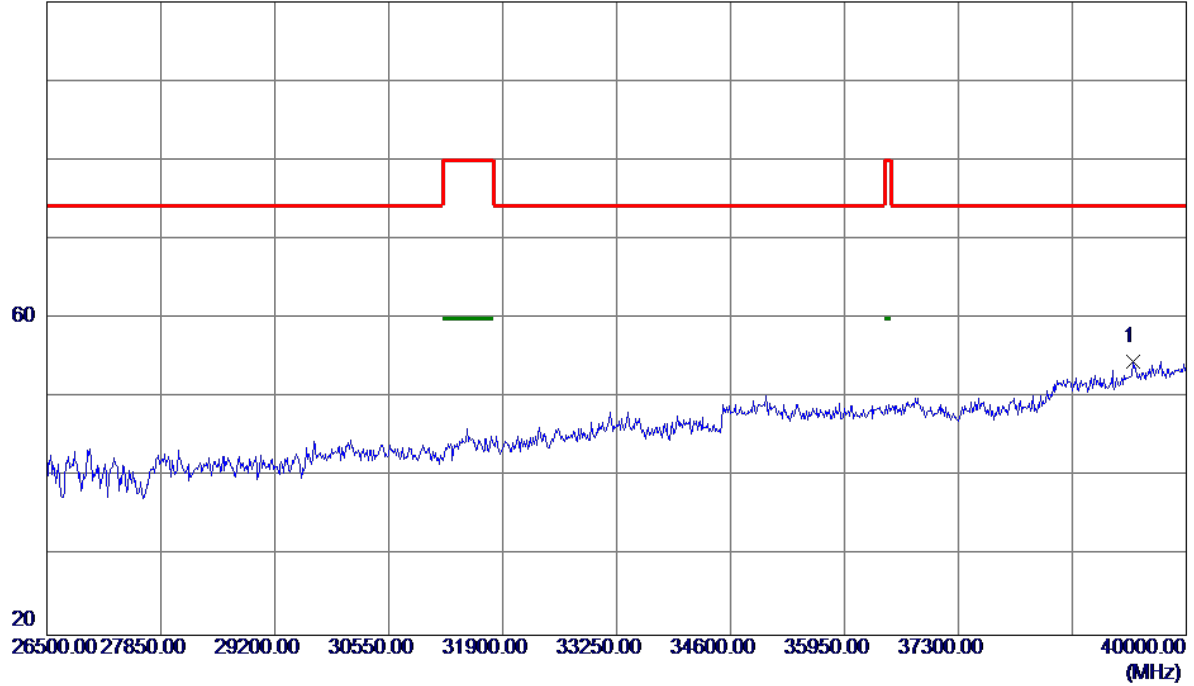

No.	Freq. MHz	Reading Level dBuV/m	Correct Factor dB	Measure ment dBuV/m	Limit dBuV/m	Margin dB	Detector	Comment
1 *	39365.5000	39.93	14.70	54.63	74.30	-19.67	Peak	

Orthogonal Axis:	X
Test Mode:	UNII-1/ TX N20 Mode 5200MHz

Horizontal

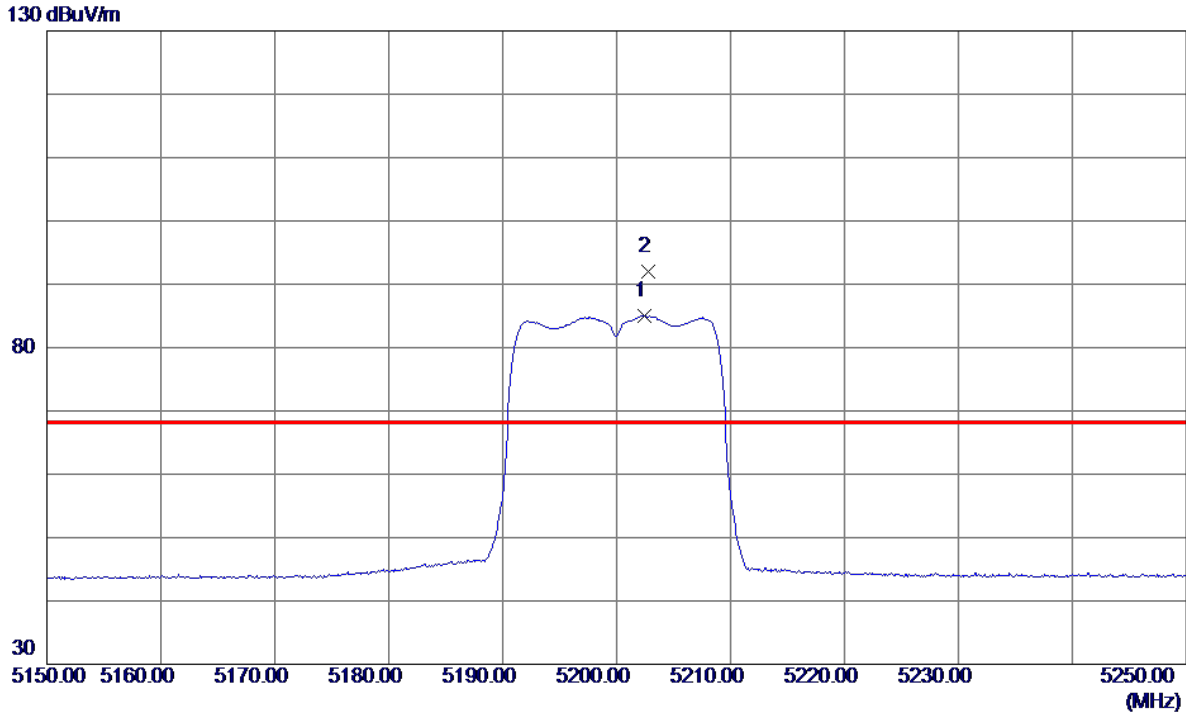

No.	Freq. MHz	Reading Level dBuV/m	Correct Factor dB	Measure ment dBuV/m	Limit dBuV/m	Margin dB	Detector	Comment
1	5202.4000	63.81	21.22	85.03	999.00	-913.97	AVG	No Limit
2 *	5202.8000	70.74	21.22	91.96	68.30	23.66	Peak	No Limit

Orthogonal Axis:	X
Test Mode:	UNII-1/ TX N20 Mode 5200MHz

Horizontal

130 dBuV/m

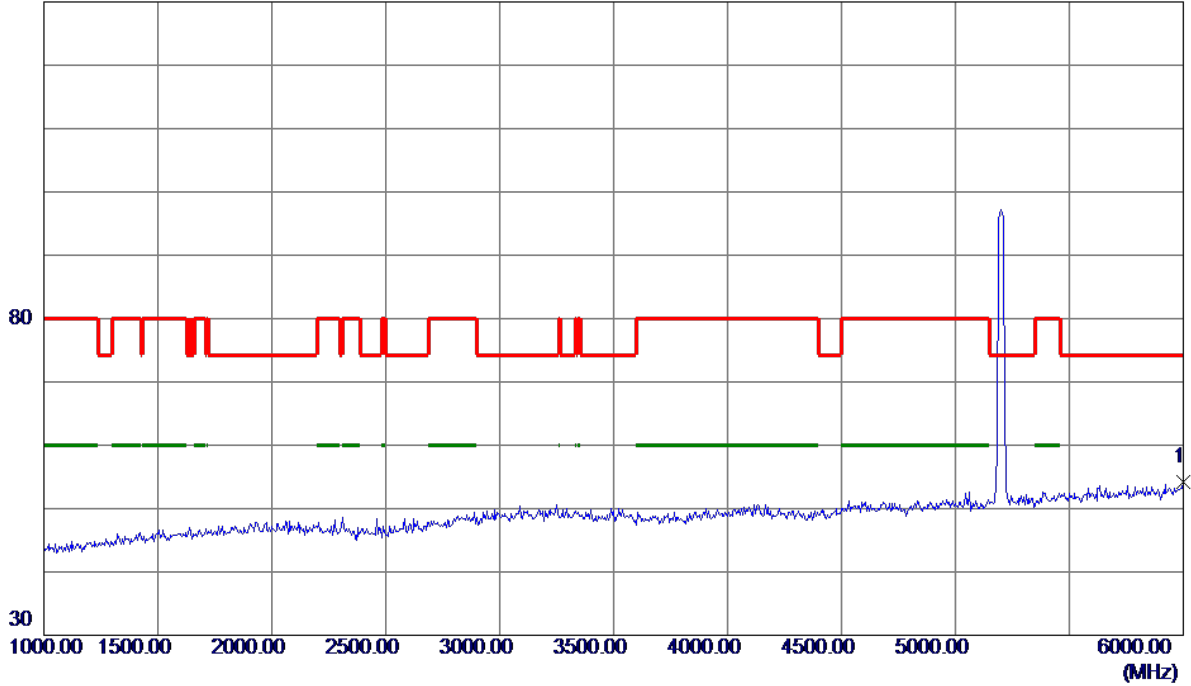

No.	Freq. MHz	Reading Level dBuV/m	Correct Factor dB	Measure ment dBuV/m	Limit dBuV/m	Margin dB	Detector	Comment
1 *	6000.0000	34.81	19.41	54.22	74.30	-20.08	Peak	

Orthogonal Axis:	X
Test Mode:	UNII-1/ TX N20 Mode 5200MHz

Horizontal

130 dBuV/m

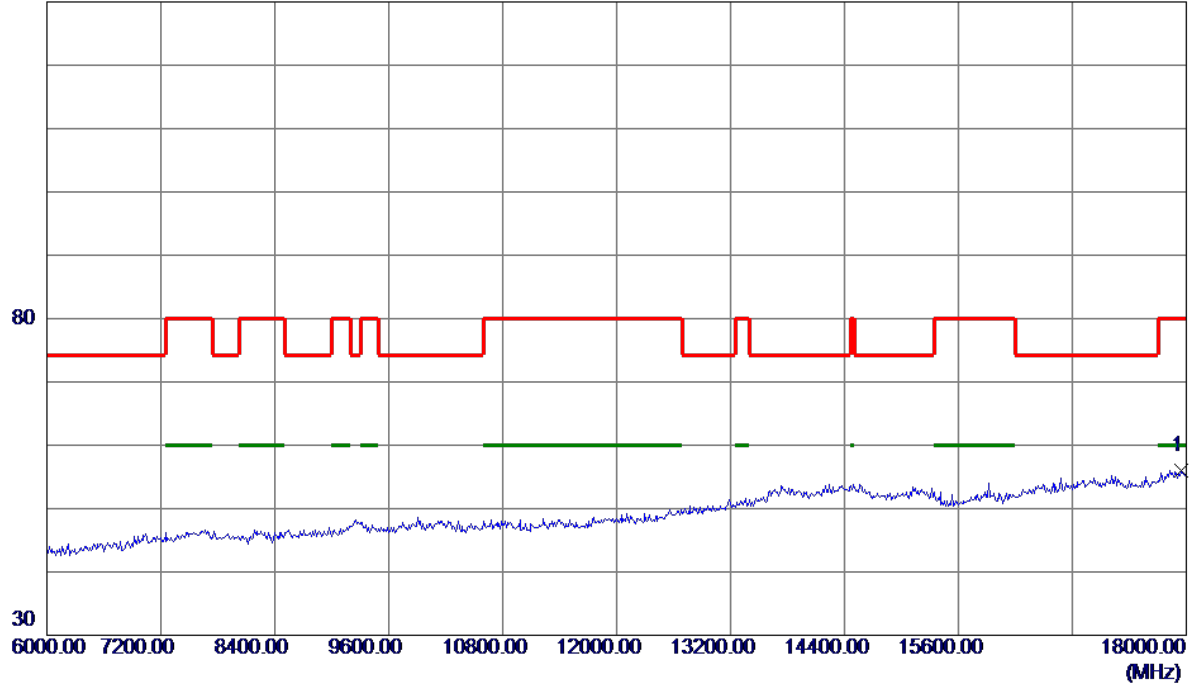

No.	Freq. MHz	Reading Level dBuV/m	Correct Factor dB	Measure ment dBuV/m	Limit dBuV/m	Margin dB	Detector	Comment
1 *	17952.0000	27.08	29.01	56.09	80.00	-23.91	Peak	

Orthogonal Axis:	X
Test Mode:	UNII-1/ TX N20 Mode 5200MHz

Horizontal

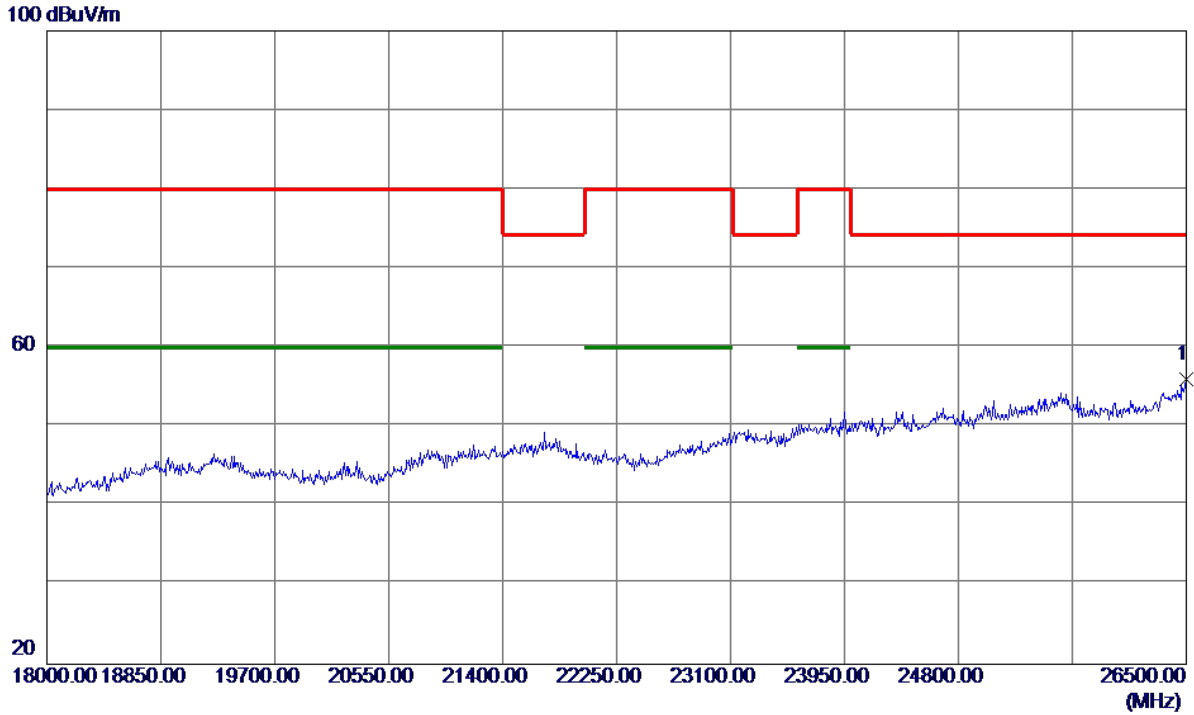

No.	Freq. MHz	Reading Level dBuV/m	Correct Factor dB	Measure ment dBuV/m	Limit dBuV/m	Margin dB	Detector	Comment
1 *	26500.0000	29.84	26.12	55.96	74.30	-18.34	Peak	

Orthogonal Axis:	X
Test Mode:	UNII-1/ TX N20 Mode 5200MHz

Horizontal

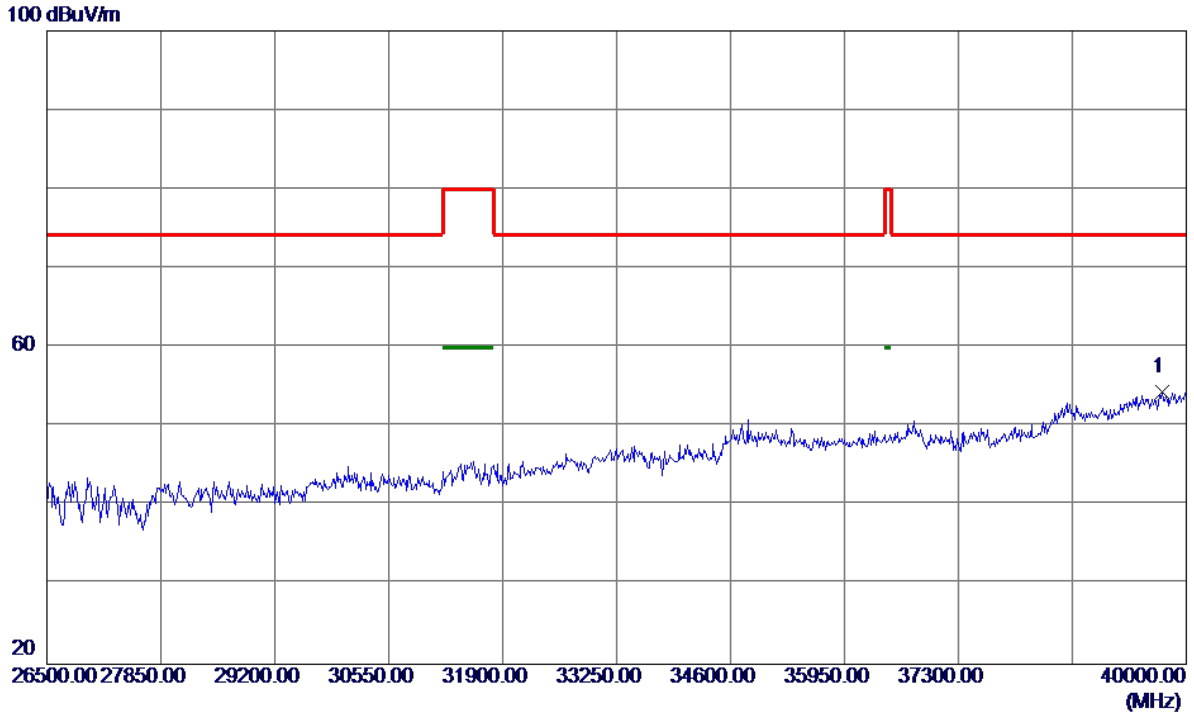

No.	Freq. MHz	Reading Level dBuV/m	Correct Factor dB	Measure ment dBuV/m	Limit dBuV/m	Margin dB	Detector	Comment
1 *	39716.5000	38.99	15.43	54.42	74.30	-19.88	Peak	

Orthogonal Axis:	X
Test Mode:	UNII-1/ TX N20 Mode 5240MHz

Vertical

130 dBuV/m

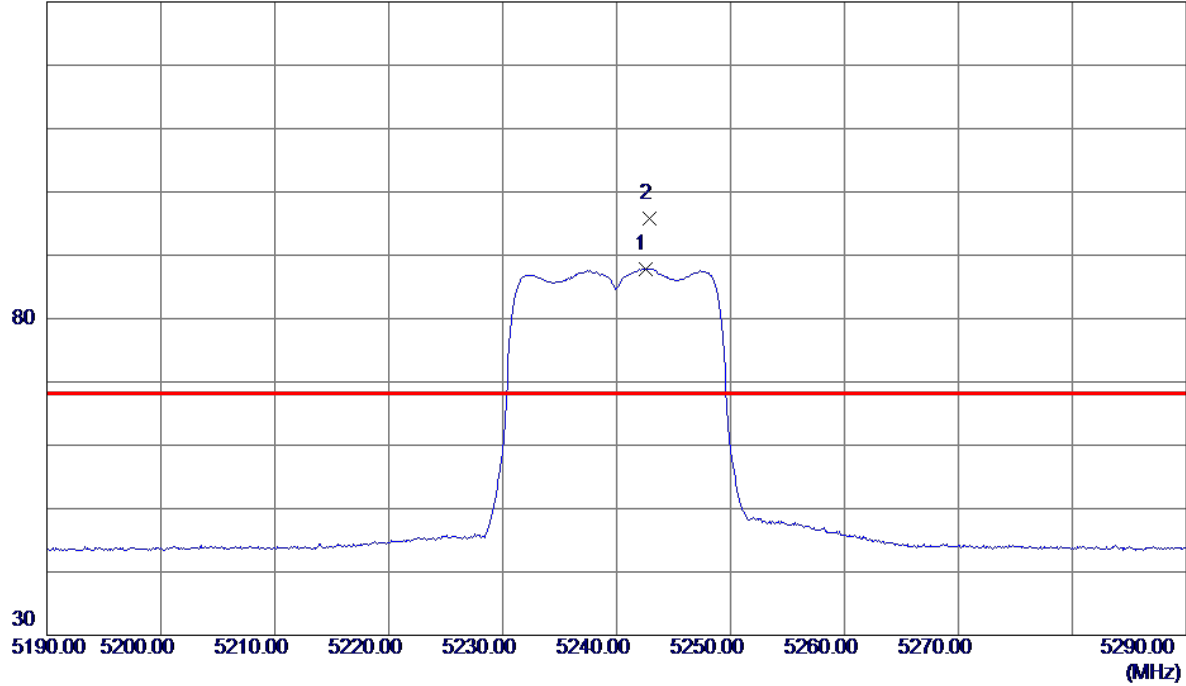

No.	Freq. MHz	Reading Level dBuV/m	Correct Factor dB	Measure ment dBuV/m	Limit dBuV/m	Margin dB	Detector	Comment
1	5242.5000	66.49	21.37	87.86	999.00	-911.14	AVG	No Limit
2 *	5242.9000	74.46	21.37	95.83	68.30	27.53	Peak	No Limit

Orthogonal Axis:	X
Test Mode:	UNII-1/ TX N20 Mode 5240MHz

Vertical

130 dBuV/m

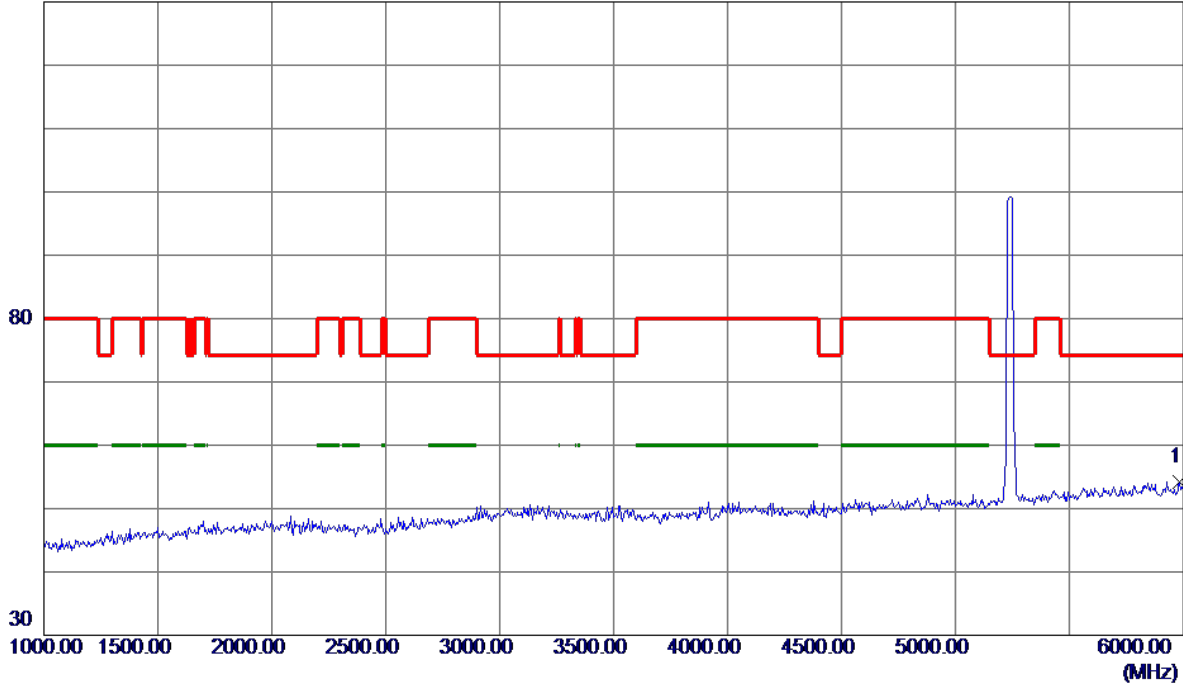

No.	Freq. MHz	Reading Level dBuV/m	Correct Factor dB	Measure ment dBuV/m	Limit dBuV/m	Margin dB	Detector	Comment
1 *	5985.0000	34.88	19.36	54.24	74.30	-20.06	Peak	

Orthogonal Axis:	X
Test Mode:	UNII-1/ TX N20 Mode 5240MHz

Vertical

130 dBuV/m

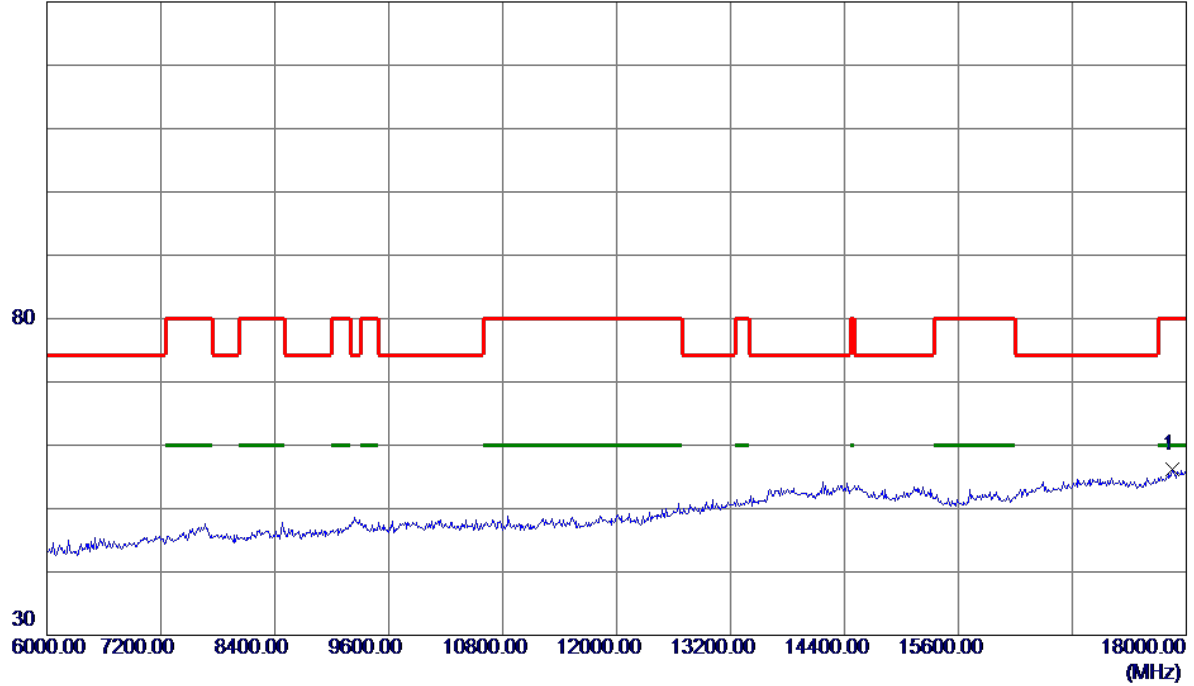

No.	Freq. MHz	Reading Level dBuV/m	Correct Factor dB	Measure ment dBuV/m	Limit dBuV/m	Margin dB	Detector	Comment
1 *	17856.0000	27.55	28.70	56.25	80.00	-23.75	Peak	

Orthogonal Axis:	X
Test Mode:	UNII-1/ TX N20 Mode 5240MHz

Vertical

100 dBuV/m

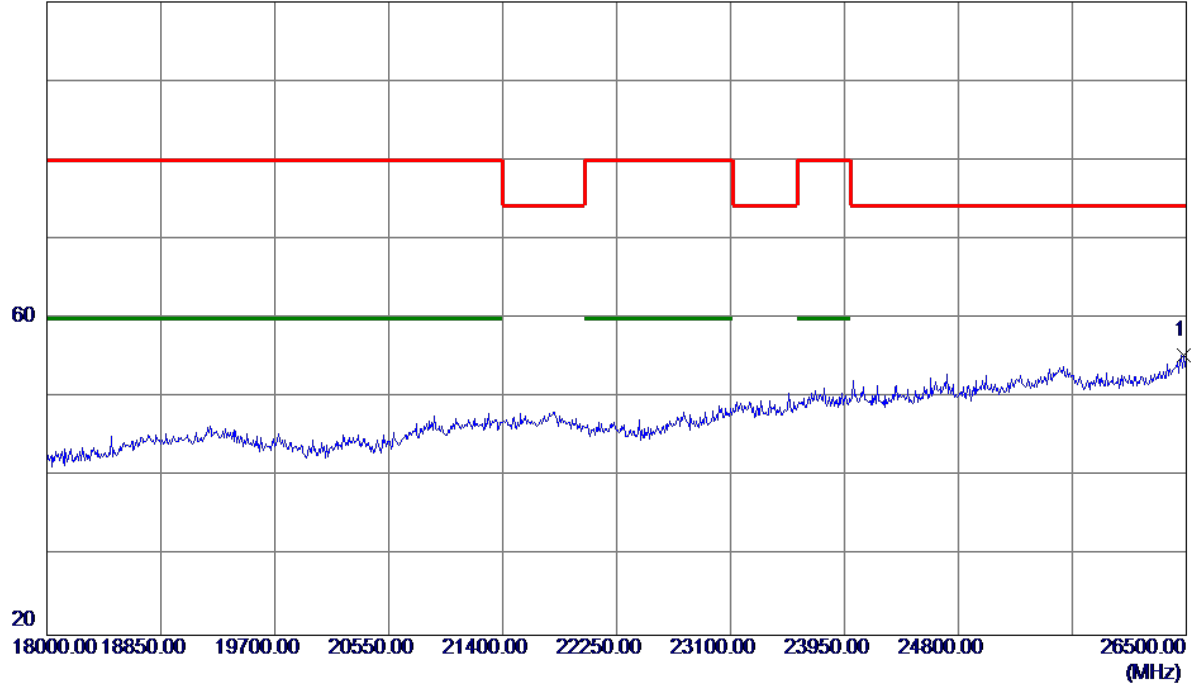

No.	Freq. MHz	Reading Level dBuV/m	Correct Factor dB	Measure ment dBuV/m	Limit dBuV/m	Margin dB	Detector	Comment
1 *	26483.0000	29.34	26.03	55.37	74.30	-18.93	Peak	

Orthogonal Axis:	X
Test Mode:	UNII-1/ TX N20 Mode 5240MHz

Vertical

100 dBuV/m



No.	Freq. MHz	Reading Level dBuV/m	Correct Factor dB	Measure ment dBuV/m	Limit dBuV/m	Margin dB	Detector	Comment
1 *	39865.0000	39.14	15.67	54.81	74.30	-19.49	Peak	

Orthogonal Axis:	X
Test Mode:	UNII-1/ TX N20 Mode 5240MHz

Horizontal

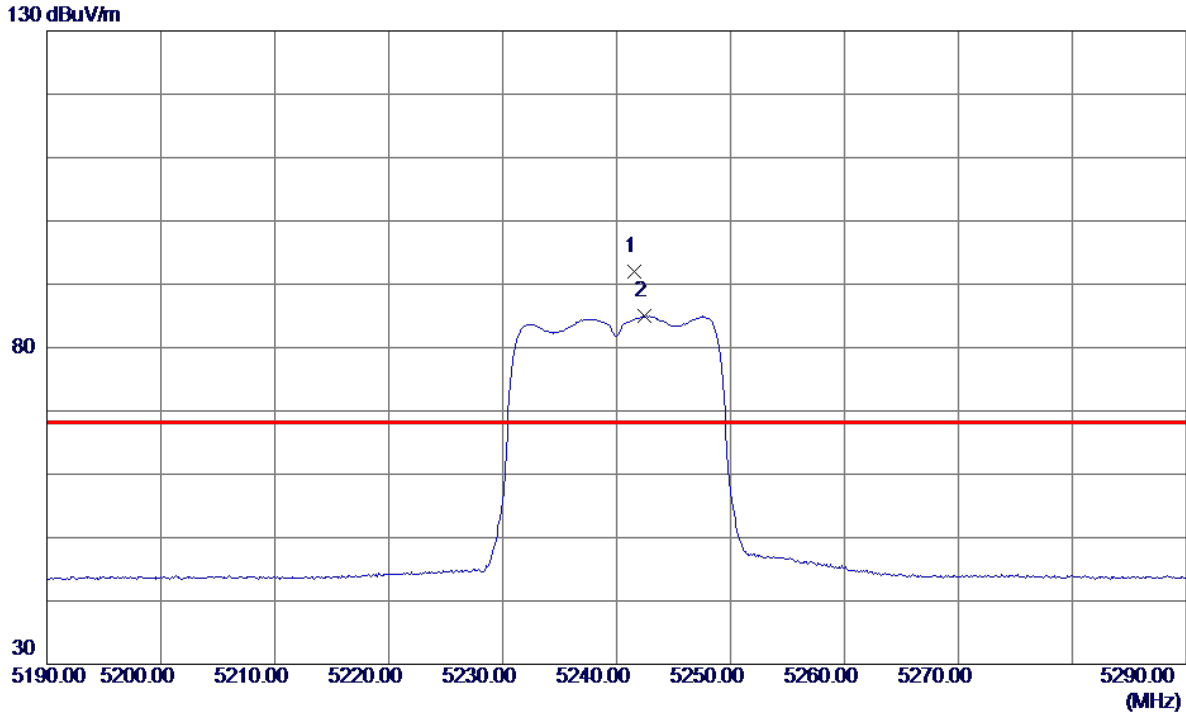

No.	Freq. MHz	Reading Level dBuV/m	Correct Factor dB	Measure ment dBuV/m	Limit dBuV/m	Margin dB	Detector	Comment
1 *	5241.6000	70.66	21.36	92.02	68.30	23.72	Peak	No Limit
2	5242.4000	63.56	21.37	84.93	999.00	-914.07	AVG	No Limit

Orthogonal Axis:	X
Test Mode:	UNII-1/ TX N20 Mode 5240MHz

Horizontal

130 dBuV/m

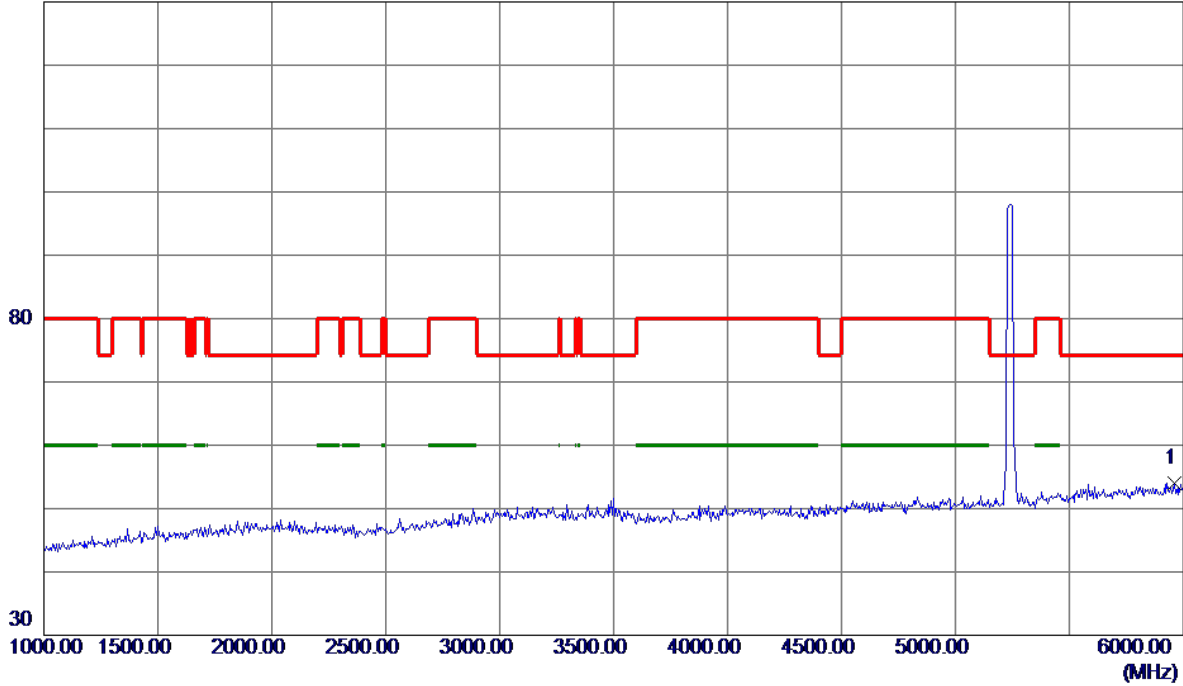

No.	Freq. MHz	Reading Level dBuV/m	Correct Factor dB	Measure ment dBuV/m	Limit dBuV/m	Margin dB	Detector	Comment
1 *	5960.0000	34.78	19.27	54.05	74.30	-20.25	Peak	

Orthogonal Axis:	X
Test Mode:	UNII-1/ TX N20 Mode 5240MHz

Horizontal

130 dBuV/m

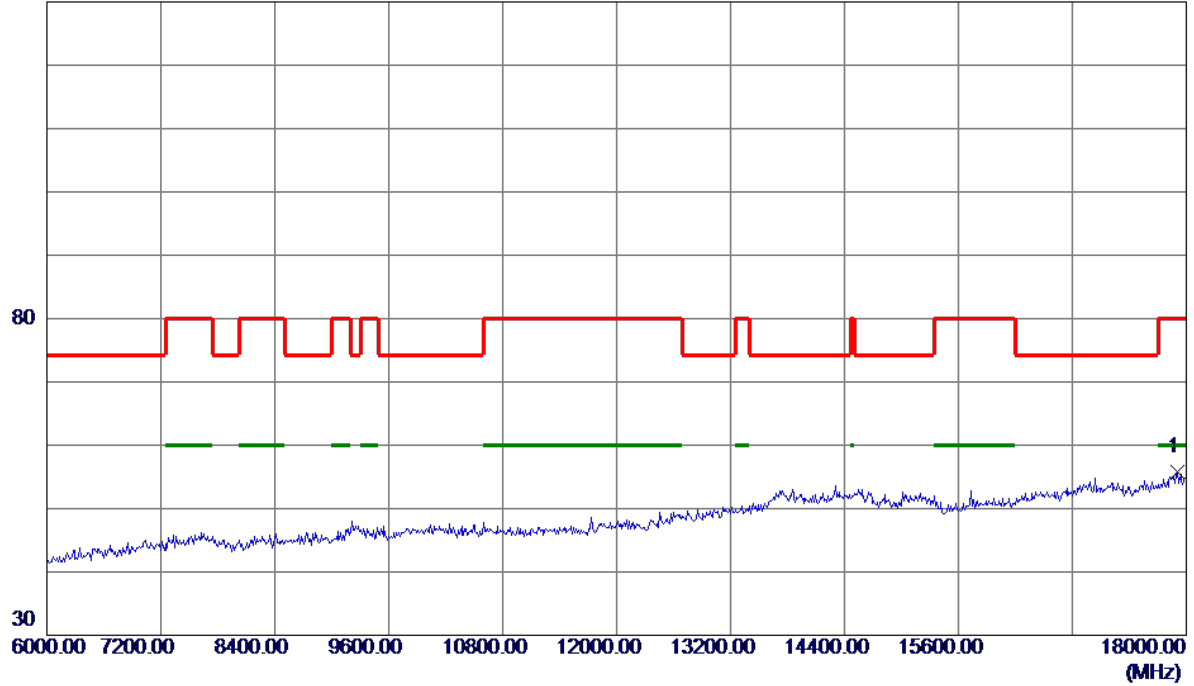

No.	Freq. MHz	Reading Level dBuV/m	Correct Factor dB	Measure ment dBuV/m	Limit dBuV/m	Margin dB	Detector	Comment
1 *	17904.0000	26.89	28.85	55.74	80.00	-24.26	Peak	

Orthogonal Axis:	X
Test Mode:	UNII-1/ TX N20 Mode 5240MHz

Horizontal

100 dBuV/m

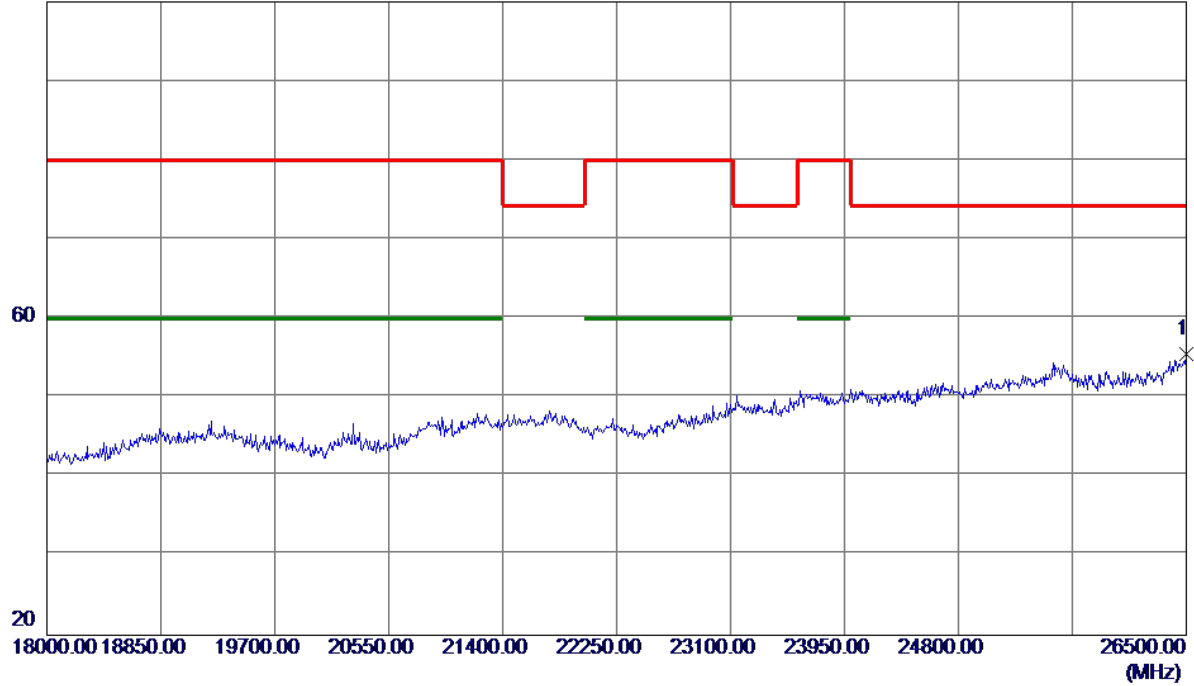

No.	Freq. MHz	Reading Level dBuV/m	Correct Factor dB	Measure ment dBuV/m	Limit dBuV/m	Margin dB	Detector	Comment
1 *	26500.0000	29.36	26.12	55.48	74.30	-18.82	Peak	

Orthogonal Axis:	X
Test Mode:	UNII-1/ TX N20 Mode 5240MHz

Horizontal

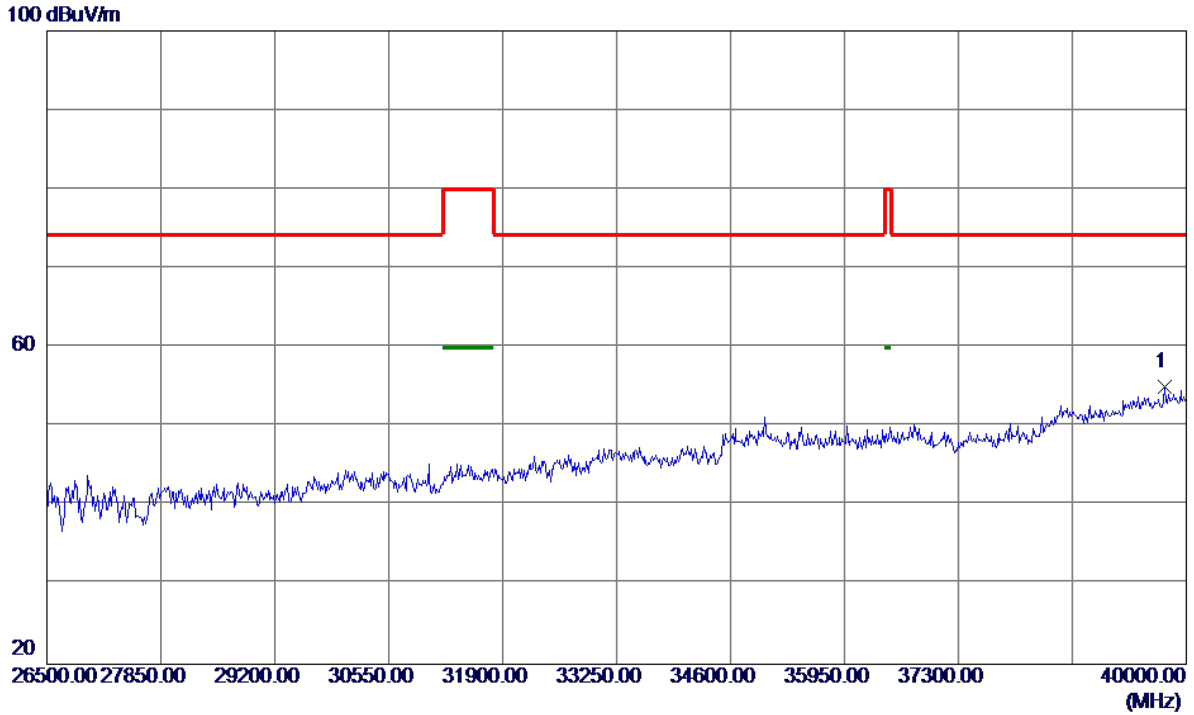

No.	Freq. MHz	Reading Level dBuV/m	Correct Factor dB	Measure ment dBuV/m	Limit dBuV/m	Margin dB	Detector	Comment
1 *	39743.5000	39.55	15.47	55.02	74.30	-19.28	Peak	

Orthogonal Axis:	X
Test Mode:	UNII-1/ TX N40 Mode 5190MHz

Vertical

130 dBuV/m

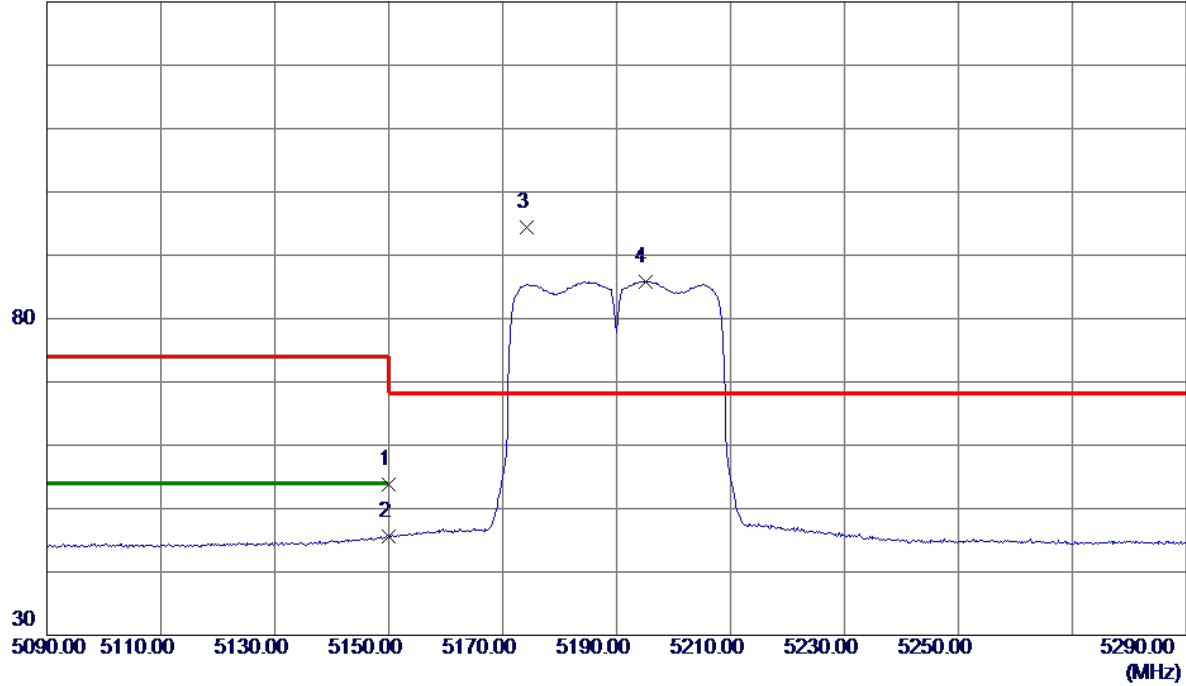

No.	Freq. MHz	Reading Level dBuV/m	Correct Factor dB	Measure ment dBuV/m	Limit dBuV/m	Margin dB	Detector	Comment
1	5150.0000	32.77	21.03	53.80	74.00	-20.20	Peak	
2	5150.0000	24.64	21.03	45.67	54.00	-8.33	AVG	
3 *	5174.2000	73.35	21.12	94.47	68.30	26.17	Peak	No Limit
4	5195.0000	64.68	21.20	85.88	999.00	-913.12	AVG	No Limit

Orthogonal Axis:	X
Test Mode:	UNII-1/ TX N40 Mode 5190MHz

Vertical

130 dBuV/m

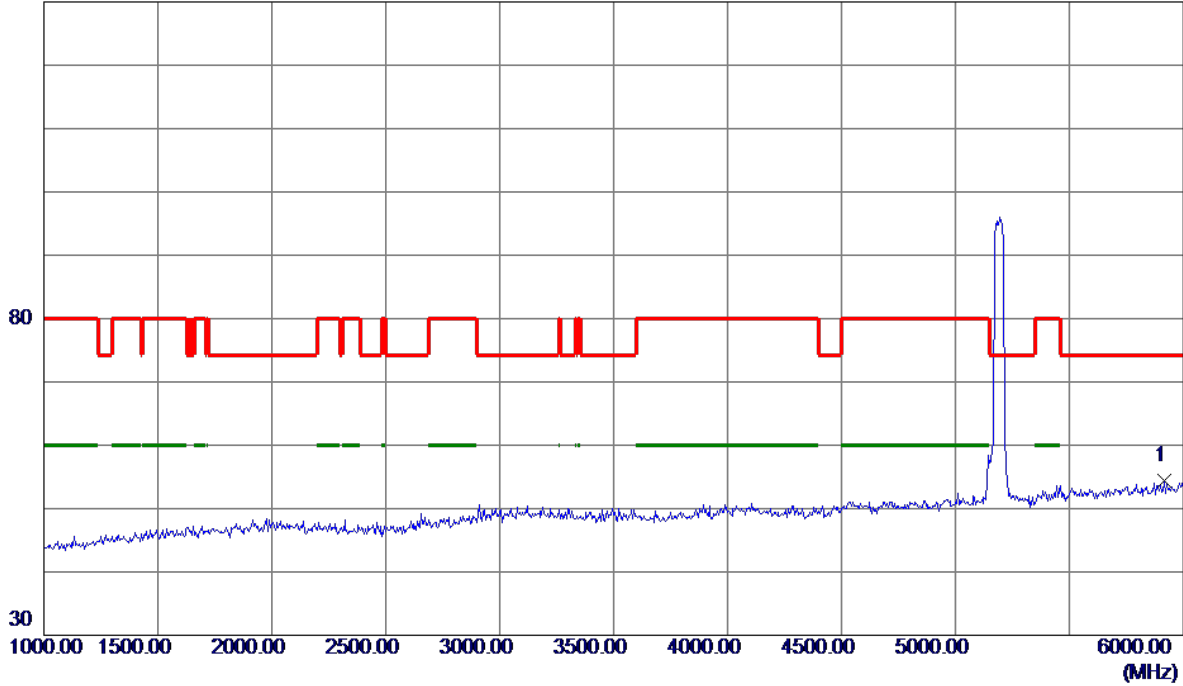

No.	Freq. MHz	Reading Level dBuV/m	Correct Factor dB	Measure ment dBuV/m	Limit dBuV/m	Margin dB	Detector	Comment
1 *	5915.0000	35.21	19.11	54.32	74.30	-19.98	Peak	

Orthogonal Axis:	X
Test Mode:	UNII-1/ TX N40 Mode 5190MHz

Vertical

130 dBuV/m

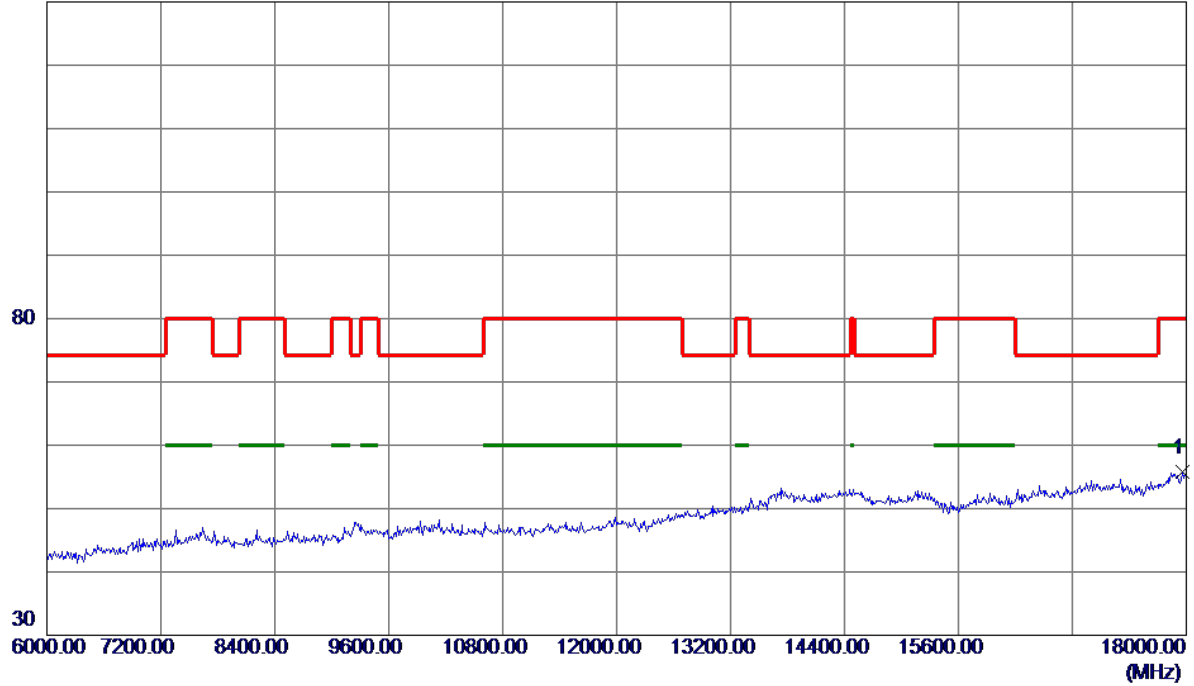

No.	Freq. MHz	Reading Level dBuV/m	Correct Factor dB	Measure ment dBuV/m	Limit dBuV/m	Margin dB	Detector	Comment
1 *	17964.0000	26.66	29.04	55.70	80.00	-24.30	Peak	

Orthogonal Axis:	X
Test Mode:	UNII-1/ TX N40 Mode 5190MHz

Vertical

100 dBuV/m

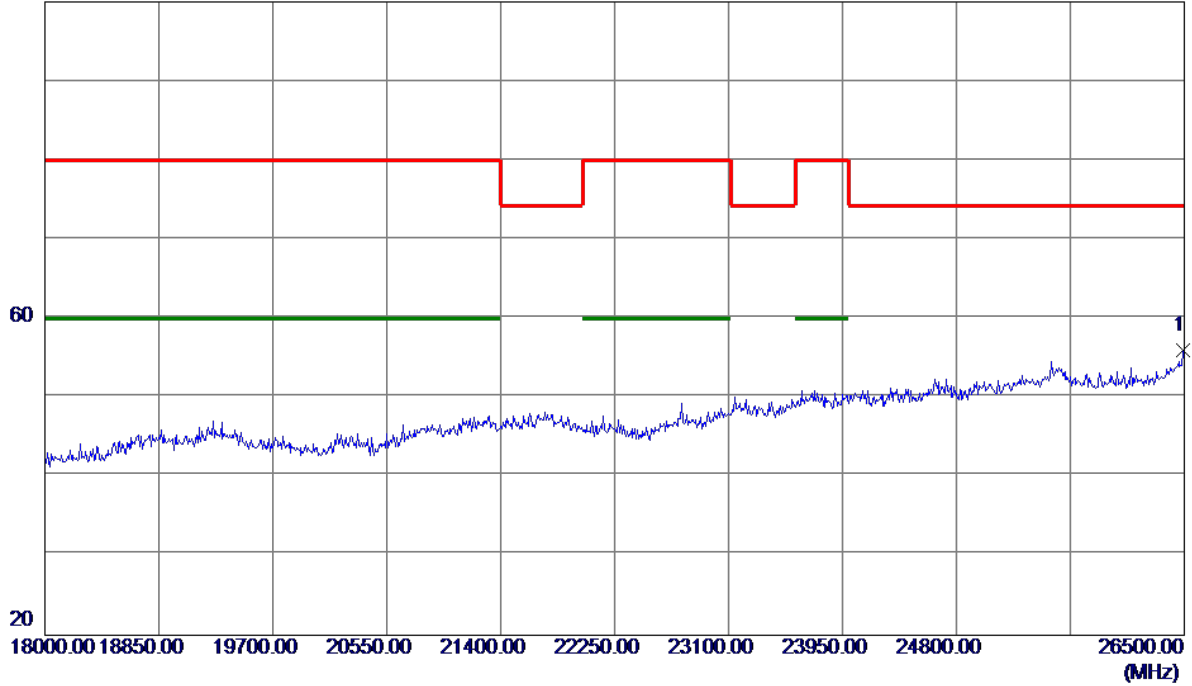

No.	Freq. MHz	Reading Level dBuV/m	Correct Factor dB	Measure ment dBuV/m	Limit dBuV/m	Margin dB	Detector	Comment
1 *	26491.5000	29.90	26.07	55.97	74.30	-18.33	Peak	

Orthogonal Axis:	X
Test Mode:	UNII-1/ TX N40 Mode 5190MHz

Vertical

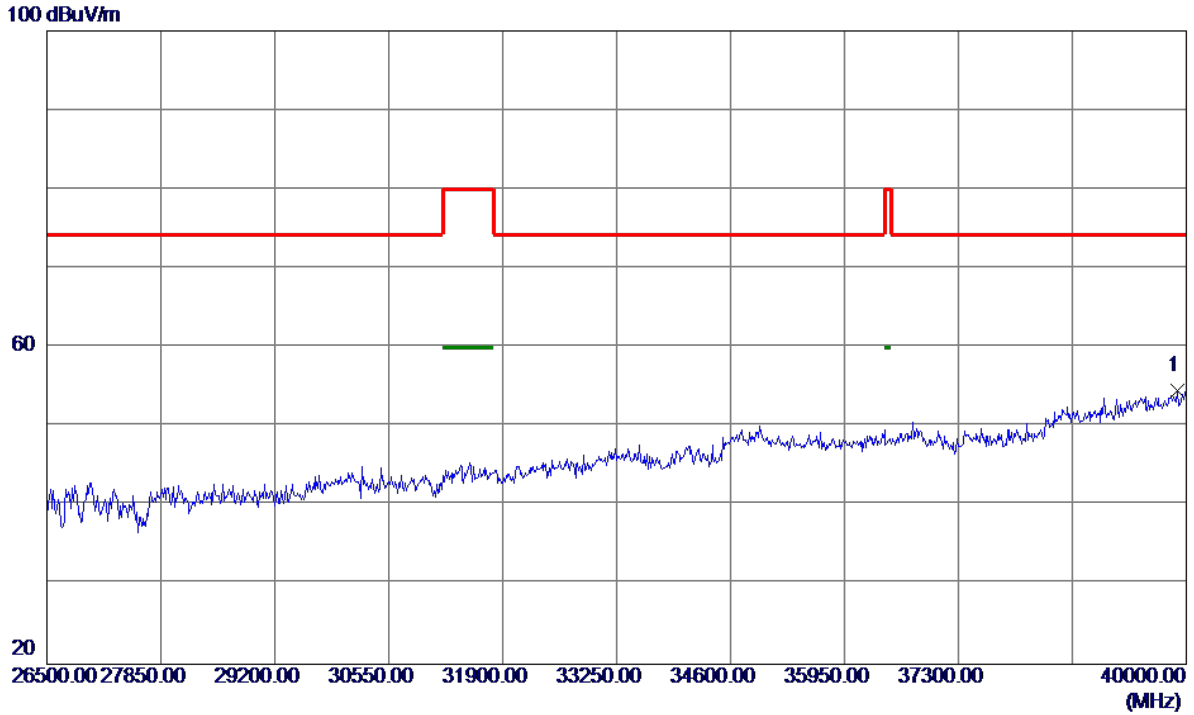

No.	Freq. MHz	Reading Level dBuV/m	Correct Factor dB	Measure ment dBuV/m	Limit dBuV/m	Margin dB	Detector	Comment
1 *	39892.0000	38.85	15.71	54.56	74.30	-19.74	Peak	

Orthogonal Axis:	X
Test Mode:	UNII-1/ TX N40 Mode 5190MHz

Horizontal

130 dBuV/m

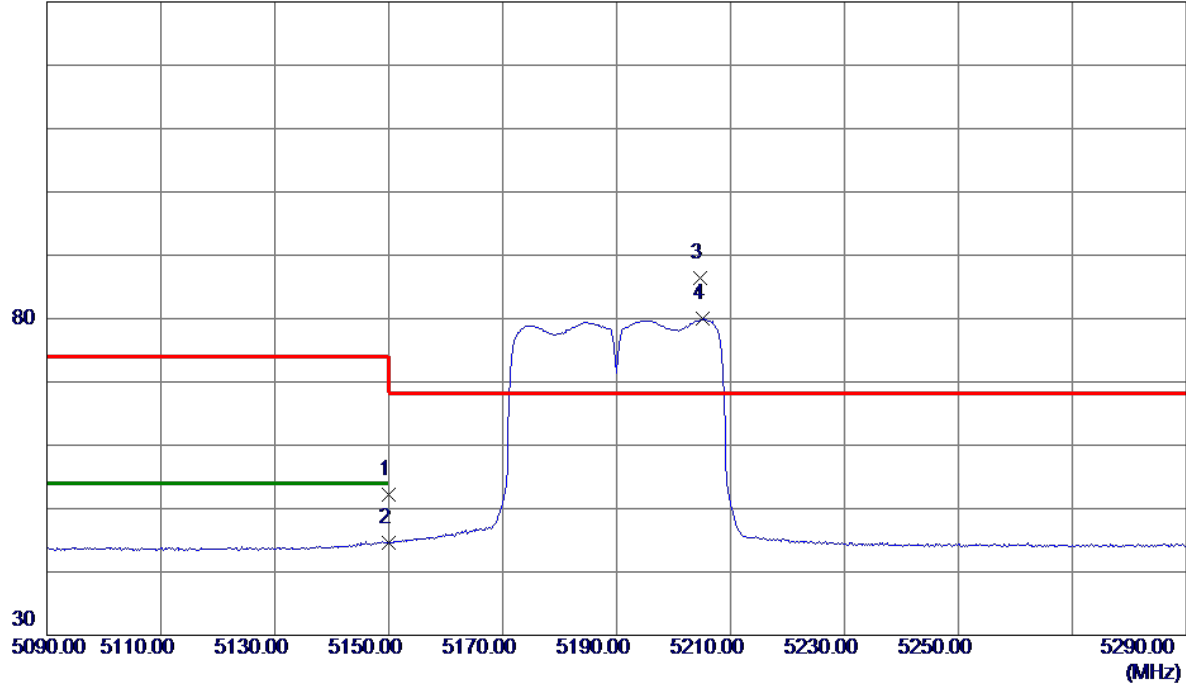

No.	Freq. MHz	Reading Level dBuV/m	Correct Factor dB	Measure ment dBuV/m	Limit dBuV/m	Margin dB	Detector	Comment
1	5150.0000	31.20	21.03	52.23	74.00	-21.77	Peak	
2	5150.0000	23.57	21.03	44.60	54.00	-9.40	AVG	
3 *	5204.6000	65.25	21.23	86.48	68.30	18.18	Peak	No Limit
4	5205.2000	58.75	21.23	79.98	999.00	-919.02	AVG	No Limit

Orthogonal Axis:	X
Test Mode:	UNII-1/ TX N40 Mode 5190MHz

Horizontal

130 dBuV/m

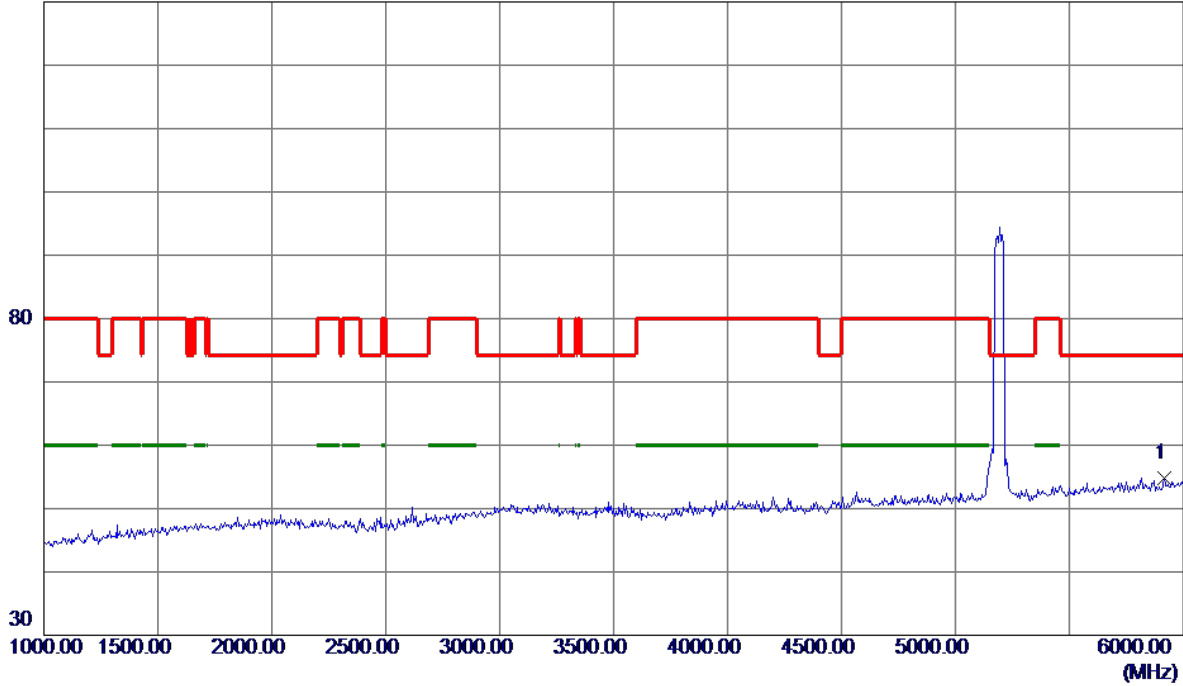

No.	Freq. MHz	Reading Level dBuV/m	Correct Factor dB	Measure ment dBuV/m	Limit dBuV/m	Margin dB	Detector	Comment
1 *	5915.0000	35.69	19.11	54.80	74.30	-19.50	Peak	

Orthogonal Axis:	X
Test Mode:	UNII-1/ TX N40 Mode 5190MHz

Horizontal

130 dBuV/m

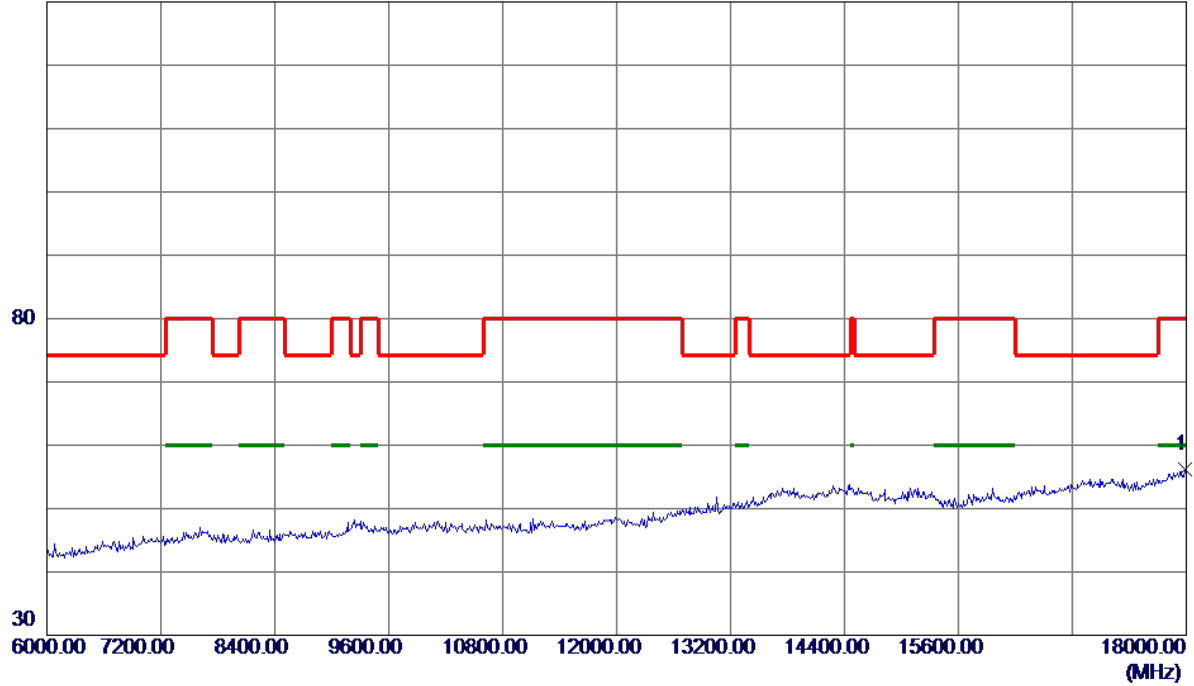

No.	Freq. MHz	Reading Level dBuV/m	Correct Factor dB	Measure ment dBuV/m	Limit dBuV/m	Margin dB	Detector	Comment
1 *	17988.0000	27.10	29.12	56.22	80.00	-23.78	Peak	

Orthogonal Axis:	X
Test Mode:	UNII-1/ TX N40 Mode 5190MHz

Horizontal

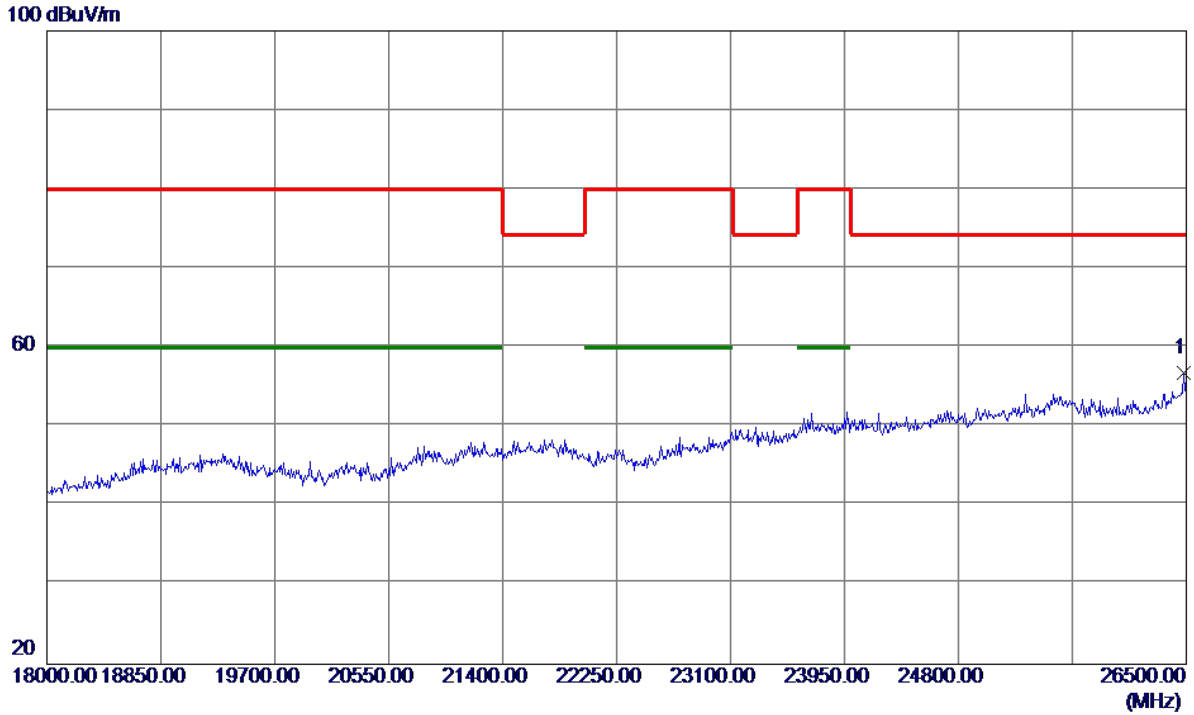

No.	Freq. MHz	Reading Level dBuV/m	Correct Factor dB	Measure ment dBuV/m	Limit dBuV/m	Margin dB	Detector	Comment
1 *	26483.0000	30.72	26.03	56.75	74.30	-17.55	Peak	

Orthogonal Axis:	X
Test Mode:	UNII-1/ TX N40 Mode 5190MHz

Horizontal

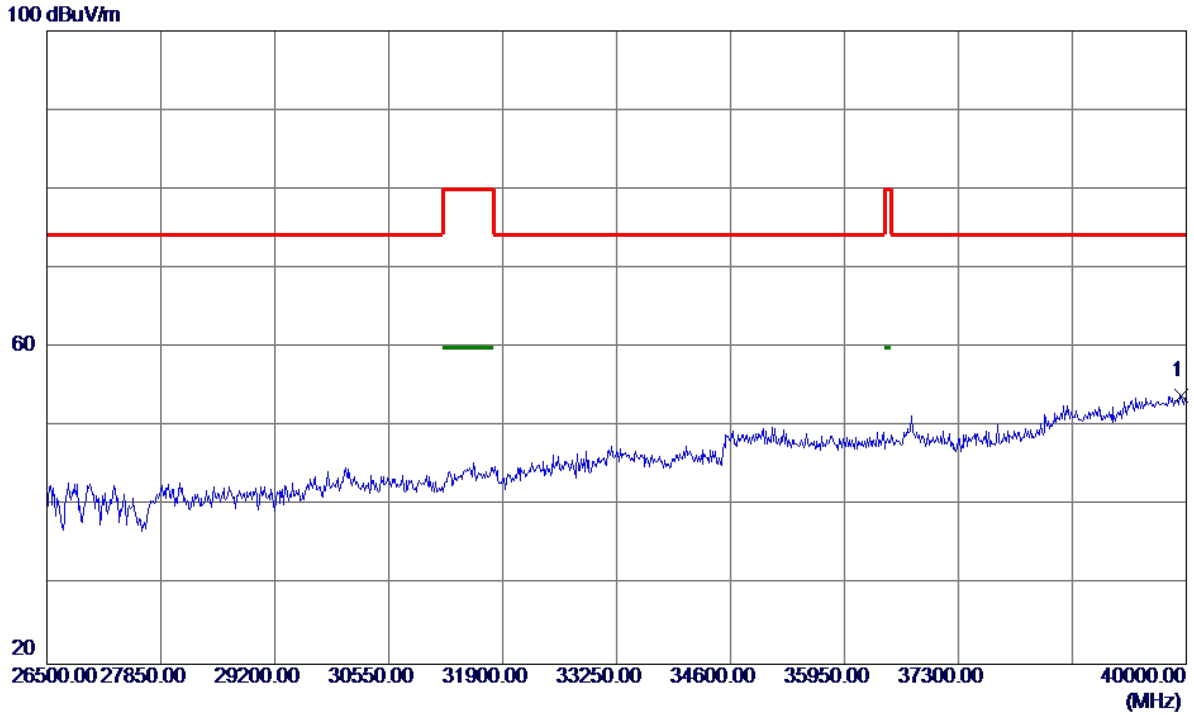

No.	Freq. MHz	Reading Level dBuV/m	Correct Factor dB	Measure ment dBuV/m	Limit dBuV/m	Margin dB	Detector	Comment
1 *	39946.0000	38.07	15.80	53.87	74.30	-20.43	Peak	

Orthogonal Axis:	X
Test Mode:	UNII-1/ TX N40 Mode 5230MHz

Vertical

130 dBuV/m

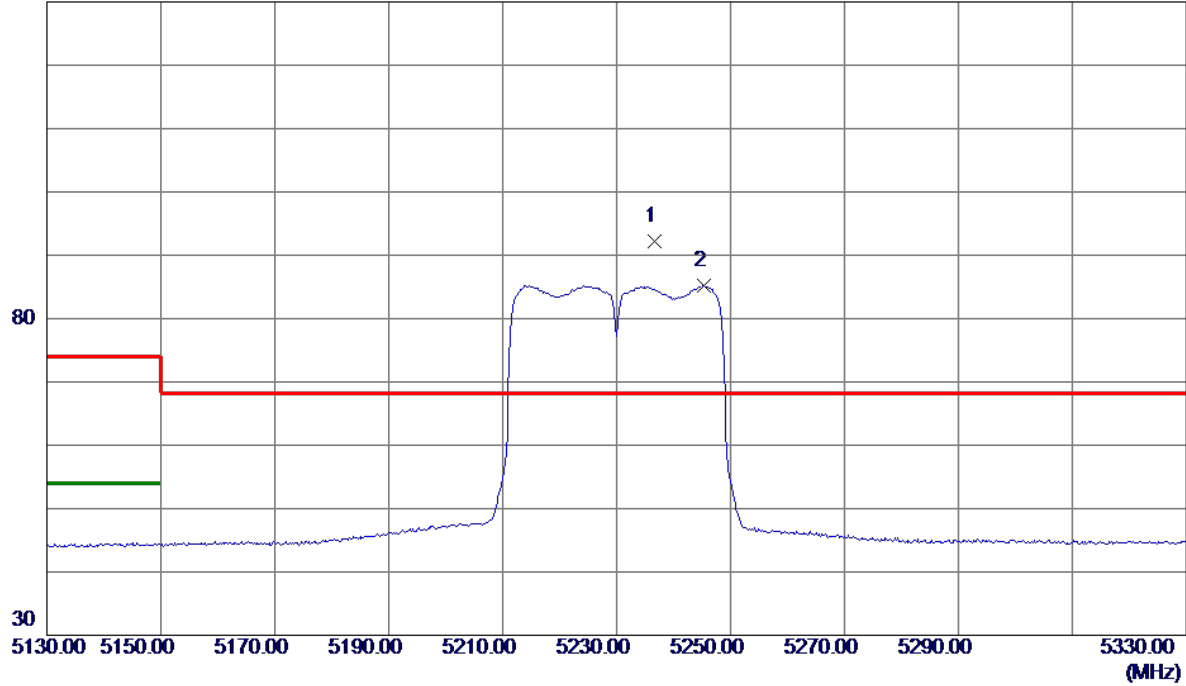

No.	Freq. MHz	Reading Level dBuV/m	Correct Factor dB	Measure ment dBuV/m	Limit dBuV/m	Margin dB	Detector	Comment
1 *	5236.6000	70.87	21.35	92.22	68.30	23.92	Peak	No Limit
2	5245.4000	63.81	21.38	85.19	999.00	-913.81	AVG	No Limit

Orthogonal Axis:	X
Test Mode:	UNII-1/ TX N40 Mode 5230MHz

Vertical

130 dBuV/m

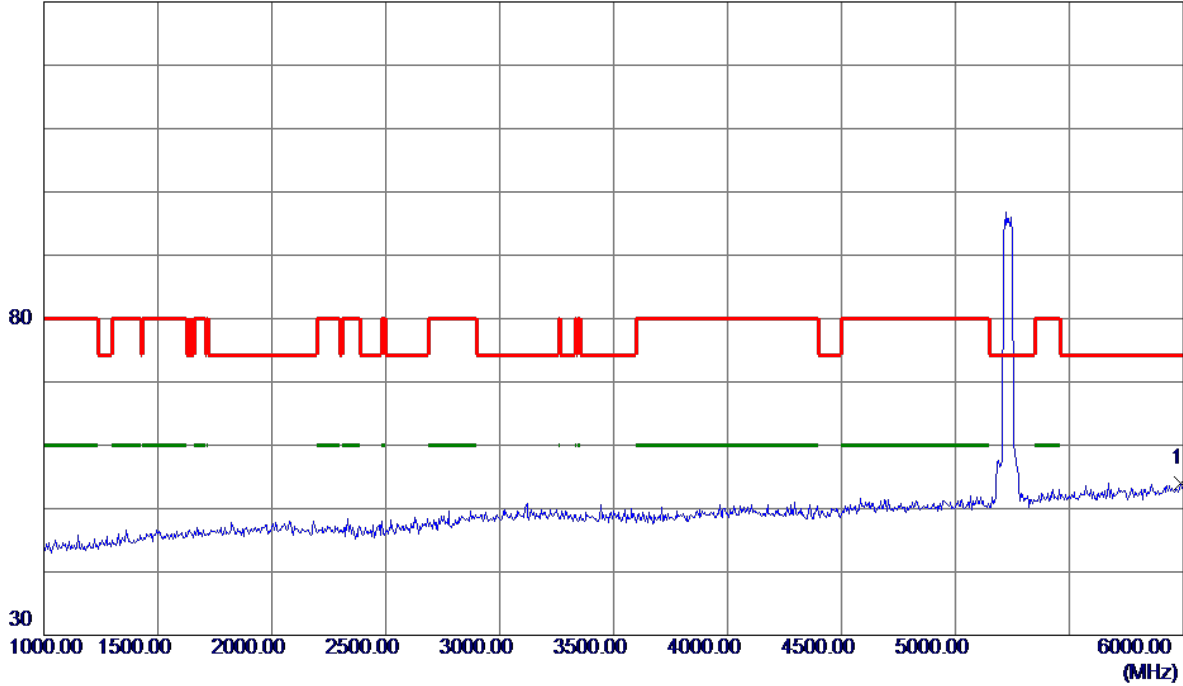

No.	Freq. MHz	Reading Level dBuV/m	Correct Factor dB	Measure ment dBuV/m	Limit dBuV/m	Margin dB	Detector	Comment
1 *	5990.0000	34.63	19.37	54.00	74.30	-20.30	Peak	

Orthogonal Axis:	X
Test Mode:	UNII-1/ TX N40 Mode 5230MHz

Vertical

130 dBuV/m

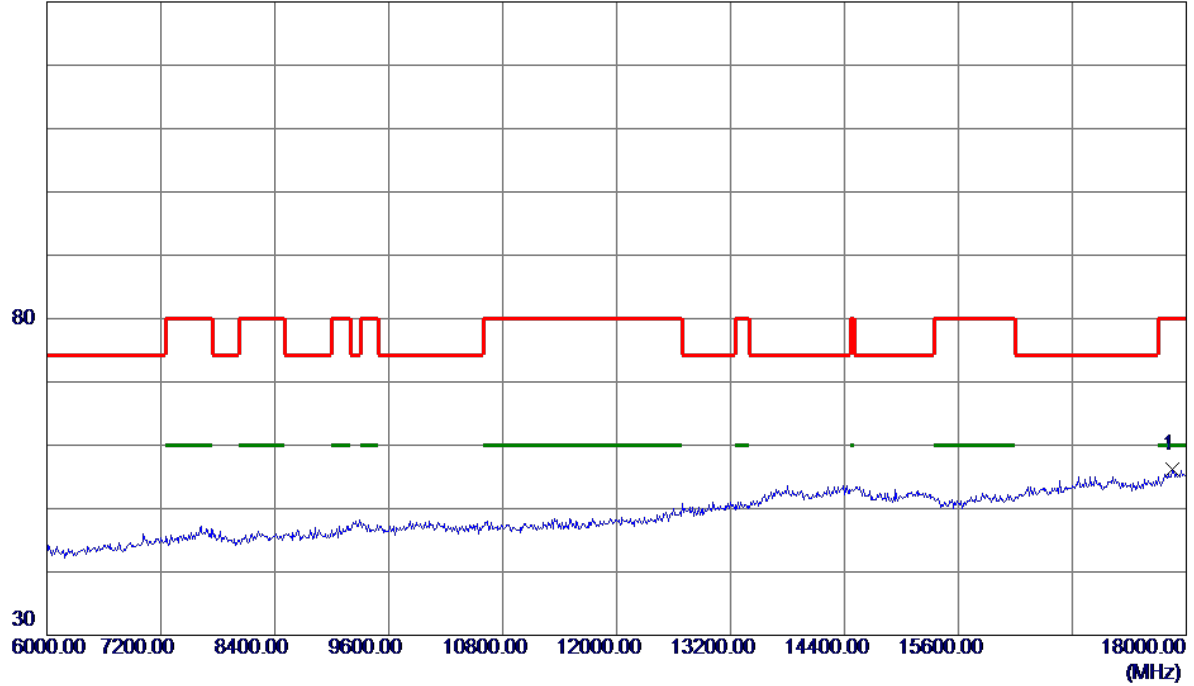

No.	Freq. MHz	Reading Level dBuV/m	Correct Factor dB	Measure ment dBuV/m	Limit dBuV/m	Margin dB	Detector	Comment
1 *	17856.0000	27.57	28.70	56.27	80.00	-23.73	Peak	

Orthogonal Axis:	X
Test Mode:	UNII-1/ TX N40 Mode 5230MHz

Vertical

100 dBuV/m

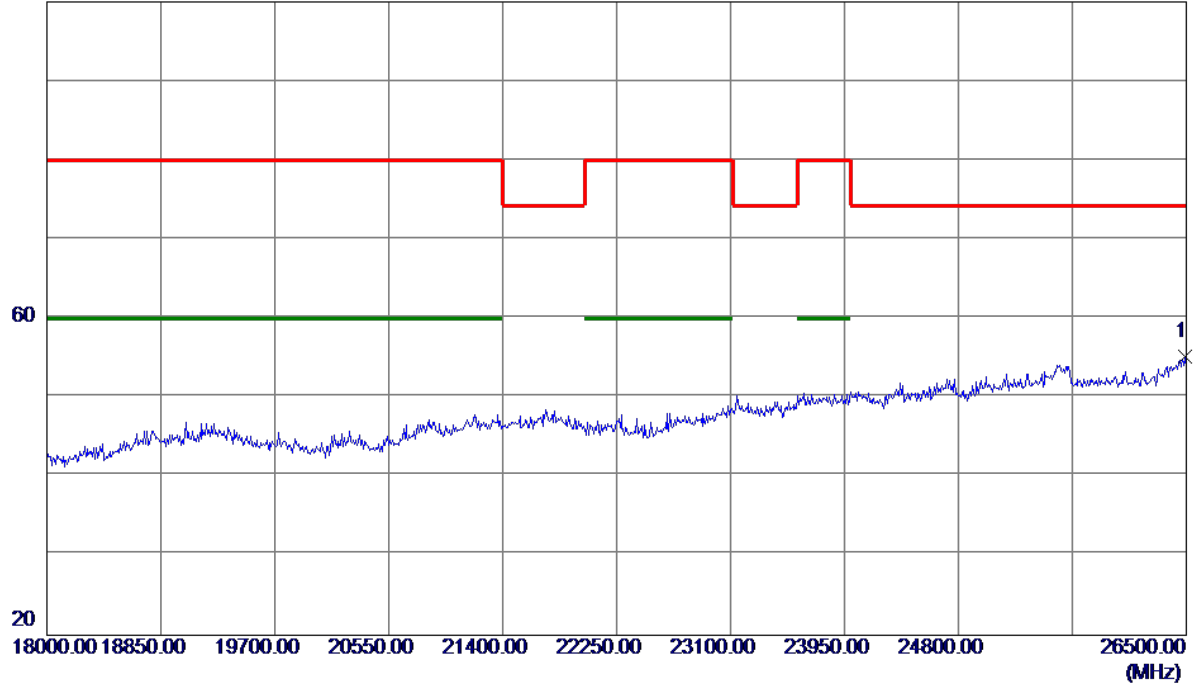

No.	Freq. MHz	Reading Level dBuV/m	Correct Factor dB	Measure ment dBuV/m	Limit dBuV/m	Margin dB	Detector	Comment
1 *	26491.5000	29.13	26.07	55.20	74.30	-19.10	Peak	

Orthogonal Axis:	X
Test Mode:	UNII-1/ TX N40 Mode 5230MHz

Vertical

100 dBuV/m

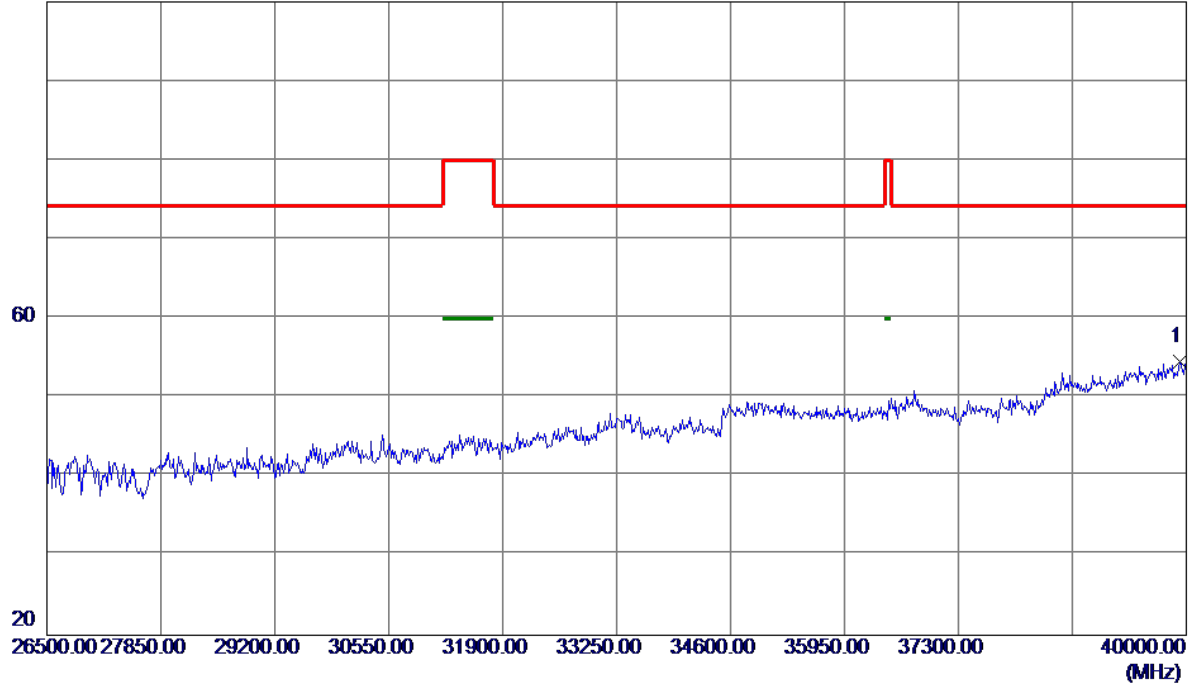

No.	Freq. MHz	Reading Level dBuV/m	Correct Factor dB	Measure ment dBuV/m	Limit dBuV/m	Margin dB	Detector	Comment
1 *	39919.0000	38.78	15.76	54.54	74.30	-19.76	Peak	

Orthogonal Axis:	X
Test Mode:	UNII-1/ TX N40 Mode 5230MHz

Horizontal

130 dBuV/m

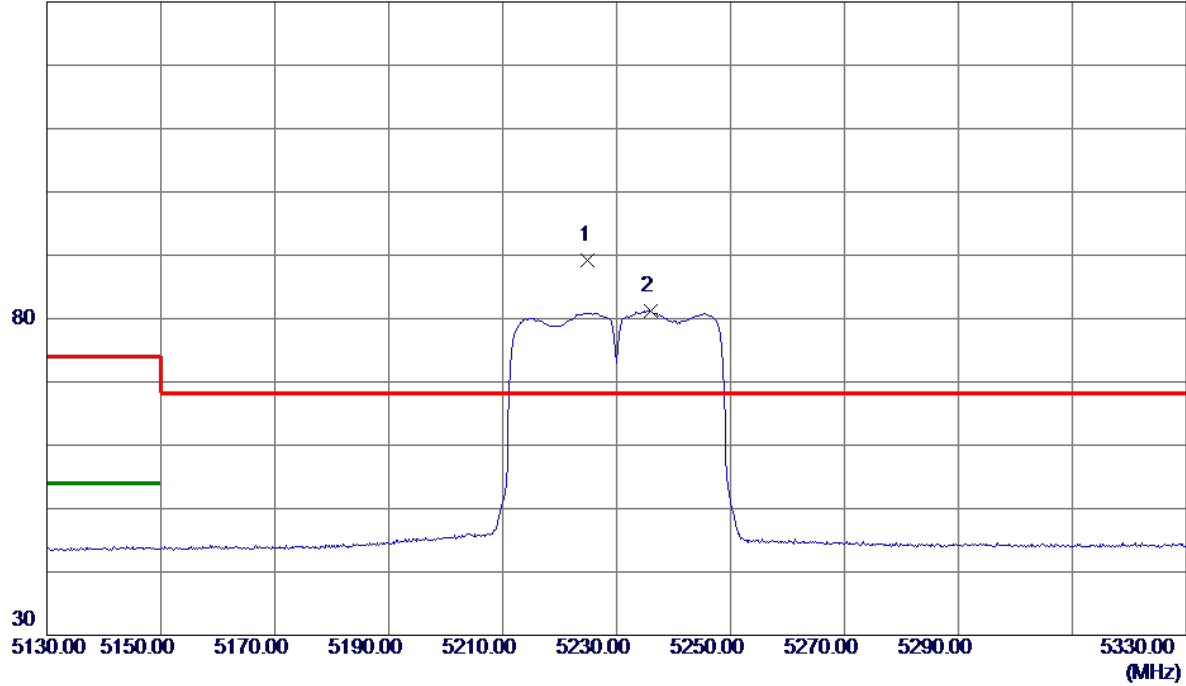

No.	Freq. MHz	Reading Level dBuV/m	Correct Factor dB	Measure ment dBuV/m	Limit dBuV/m	Margin dB	Detector	Comment
1 *	5225.0000	67.85	21.30	89.15	68.30	20.85	Peak	No Limit
2	5236.0000	59.85	21.34	81.19	999.00	-917.81	AVG	No Limit

Orthogonal Axis:	X
Test Mode:	UNII-1/ TX N40 Mode 5230MHz

Horizontal

130 dBuV/m

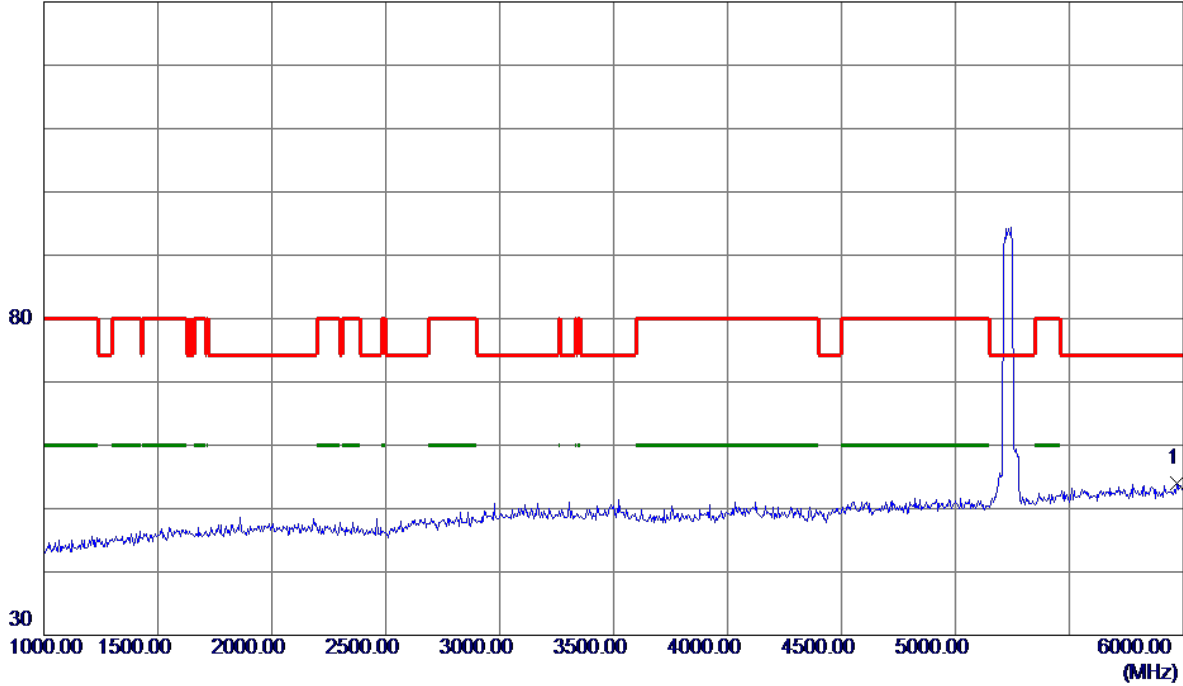

No.	Freq. MHz	Reading Level dBuV/m	Correct Factor dB	Measure ment dBuV/m	Limit dBuV/m	Margin dB	Detector	Comment
1 *	5970.0000	34.70	19.30	54.00	74.30	-20.30	Peak	

Orthogonal Axis:	X
Test Mode:	UNII-1/ TX N40 Mode 5230MHz

Horizontal

130 dBuV/m

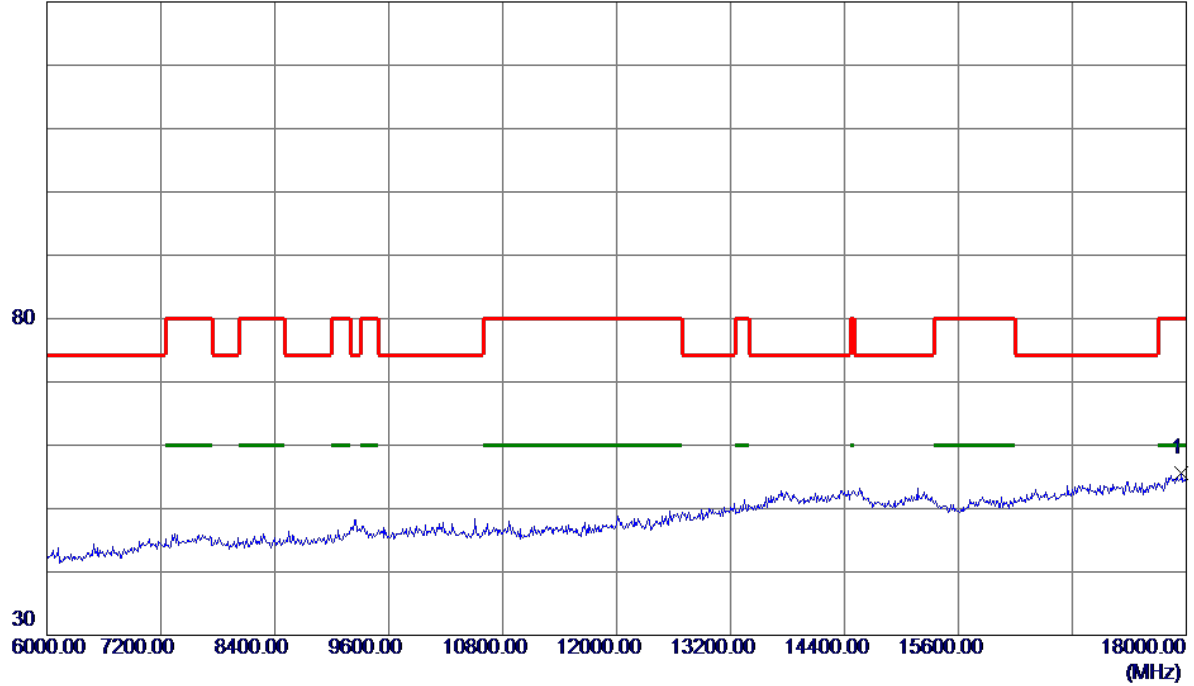

No.	Freq. MHz	Reading Level dBuV/m	Correct Factor dB	Measure ment dBuV/m	Limit dBuV/m	Margin dB	Detector	Comment
1 *	17952.0000	26.51	29.01	55.52	80.00	-24.48	Peak	

Orthogonal Axis:	X
Test Mode:	UNII-1/ TX N40 Mode 5230MHz

Horizontal

100 dBuV/m

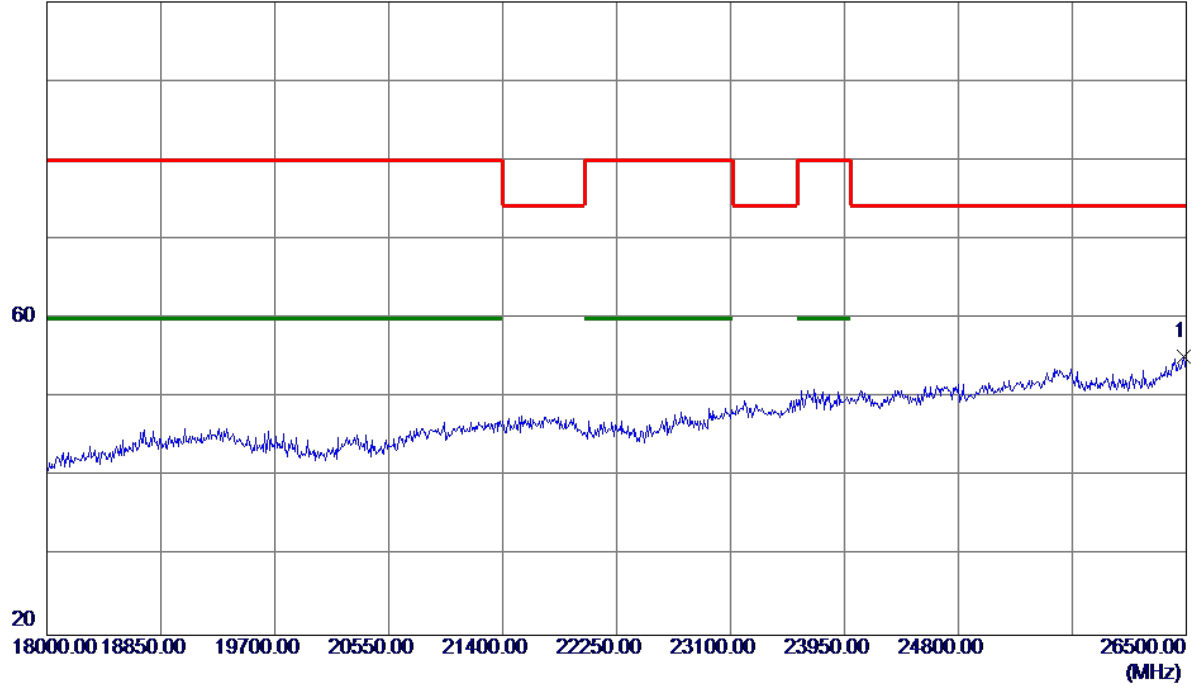

No.	Freq. MHz	Reading Level dBuV/m	Correct Factor dB	Measure ment dBuV/m	Limit dBuV/m	Margin dB	Detector	Comment
1 *	26483.0000	29.19	26.03	55.22	74.30	-19.08	Peak	

Orthogonal Axis:	X
Test Mode:	UNII-1/ TX N40 Mode 5230MHz

Horizontal

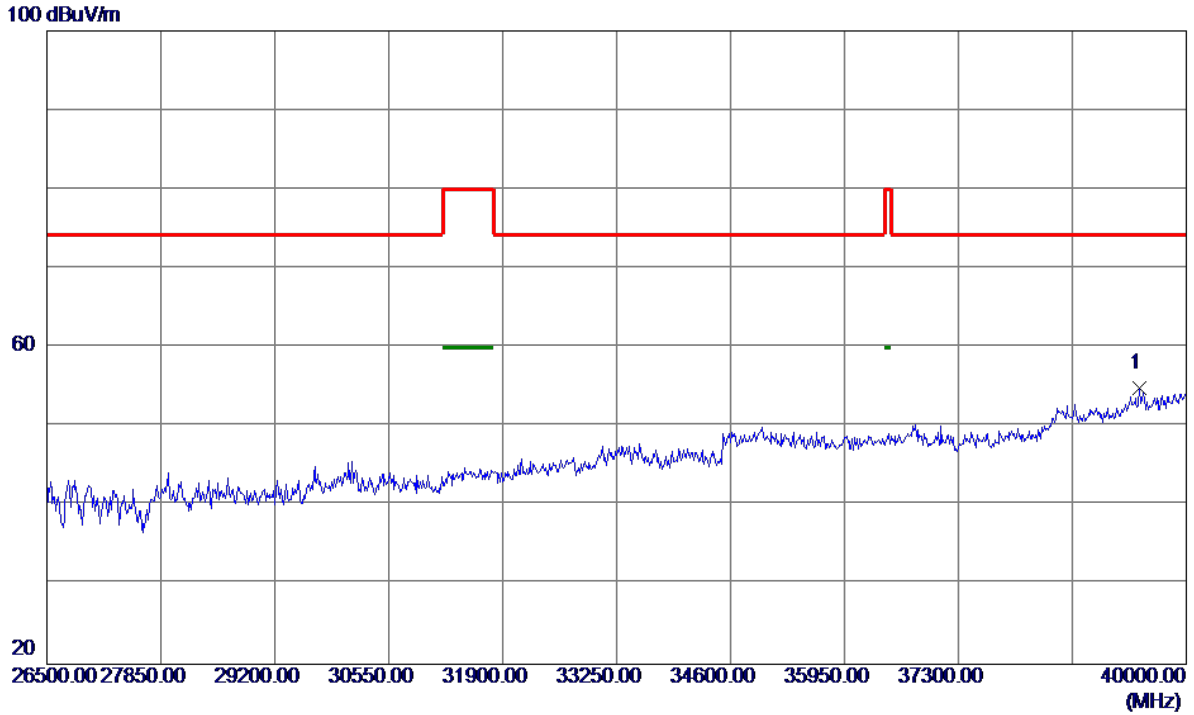

No.	Freq. MHz	Reading Level dBuV/m	Correct Factor dB	Measure ment dBuV/m	Limit dBuV/m	Margin dB	Detector	Comment
1 *	39446.5000	40.00	14.93	54.93	74.30	-19.37	Peak	

Orthogonal Axis :	X
Test Mode :	UNII-2A/ TX A Mode 5260MHz

Vertical

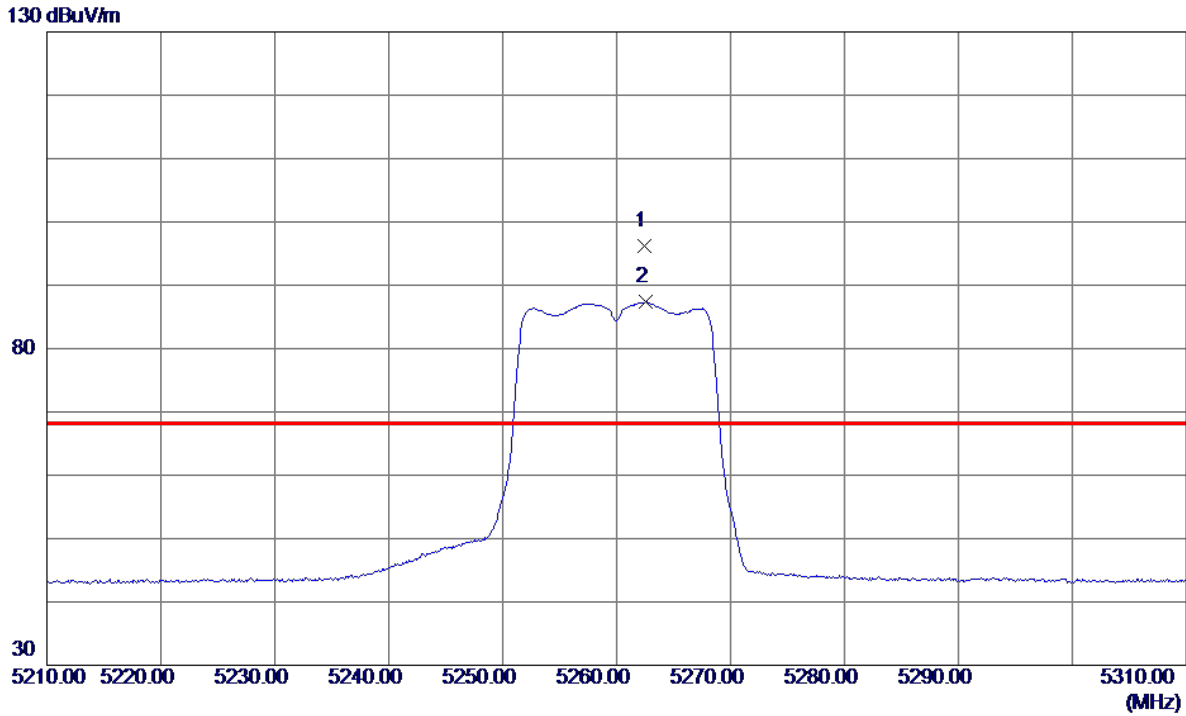

No.	Freq. MHz	Reading Level dBuV/m	Correct Factor dB	Measure ment dBuV/m	Limit dBuV/m	Margin dB	Detector	Comment
1 *	5262.4000	74.73	21.44	96.17	68.30	27.87	Peak	No Limit
2	5262.6000	65.95	21.44	87.39	999.00	-911.61	AVG	No Limit

Orthogonal Axis :	X
Test Mode :	UNII-2A/ TX A Mode 5260MHz

Vertical

130 dBuV/m

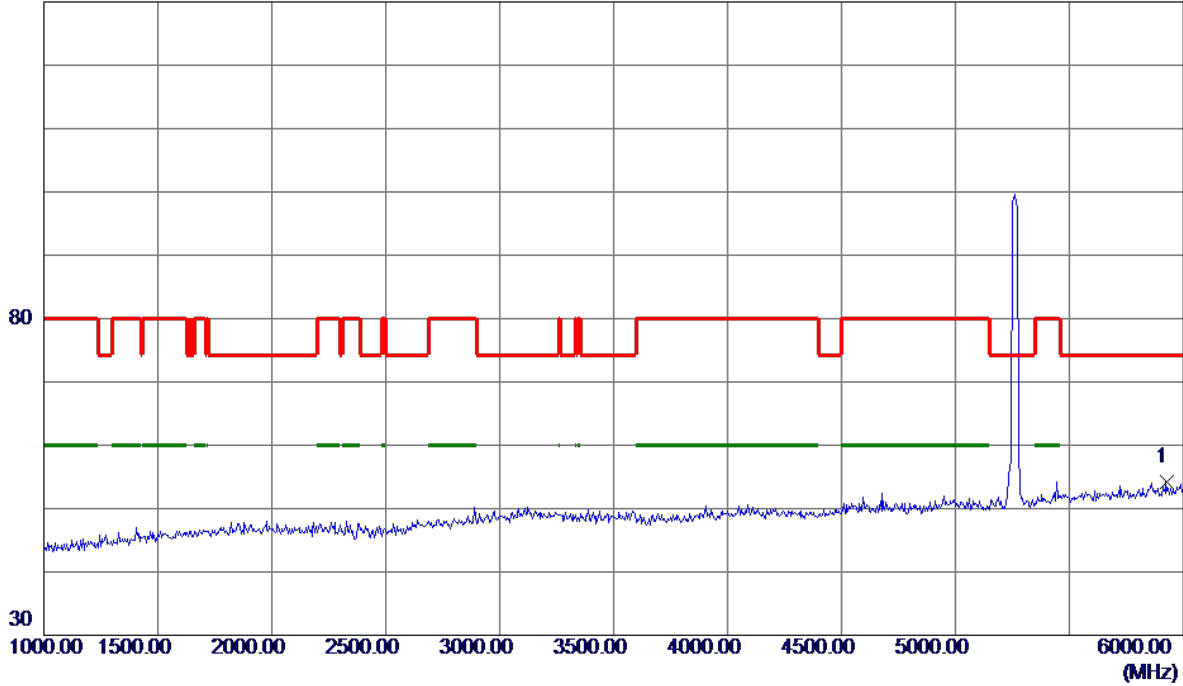

No.	Freq. MHz	Reading Level dBuV/m	Correct Factor dB	Measure ment dBuV/m	Limit dBuV/m	Margin dB	Detector	Comment
1 *	5925.0000	35.10	19.14	54.24	74.30	-20.06	Peak	

Orthogonal Axis :	X
Test Mode :	UNII-2A/ TX A Mode 5260MHz

Vertical

130 dBuV/m

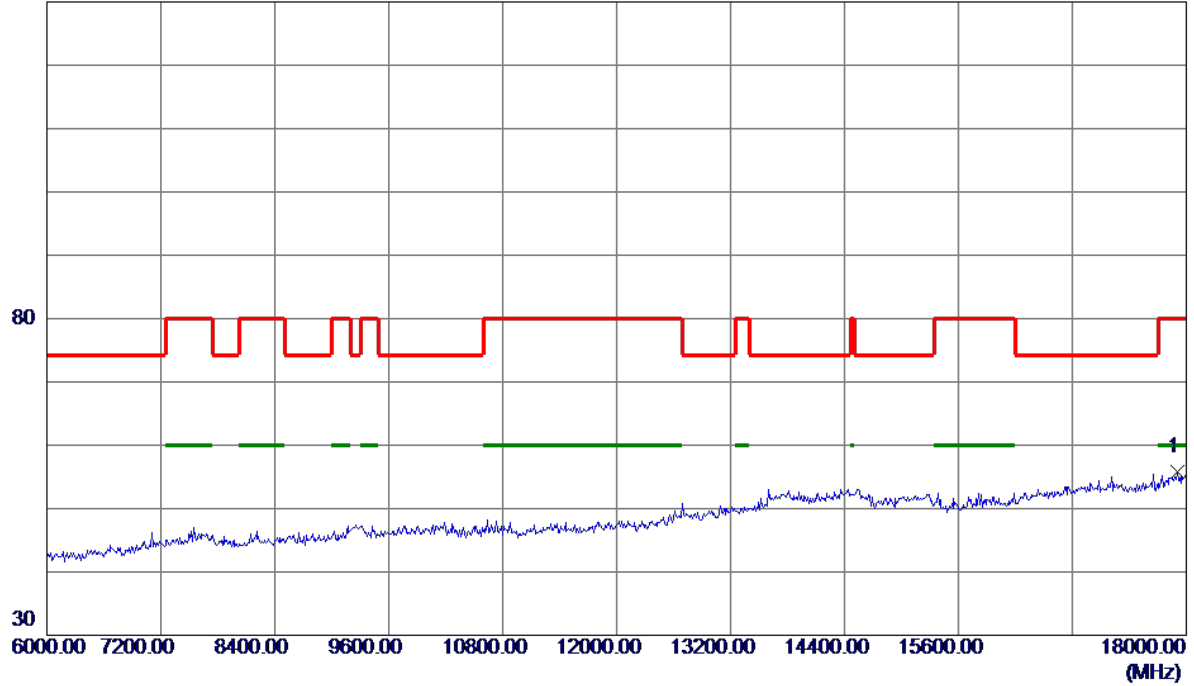

No.	Freq. MHz	Reading Level dBuV/m	Correct Factor dB	Measure ment dBuV/m	Limit dBuV/m	Margin dB	Detector	Comment
1 *	17904.0000	26.88	28.85	55.73	80.00	-24.27	Peak	

Orthogonal Axis :	X
Test Mode :	UNII-2A/ TX A Mode 5260MHz

Vertical

100 dBuV/m

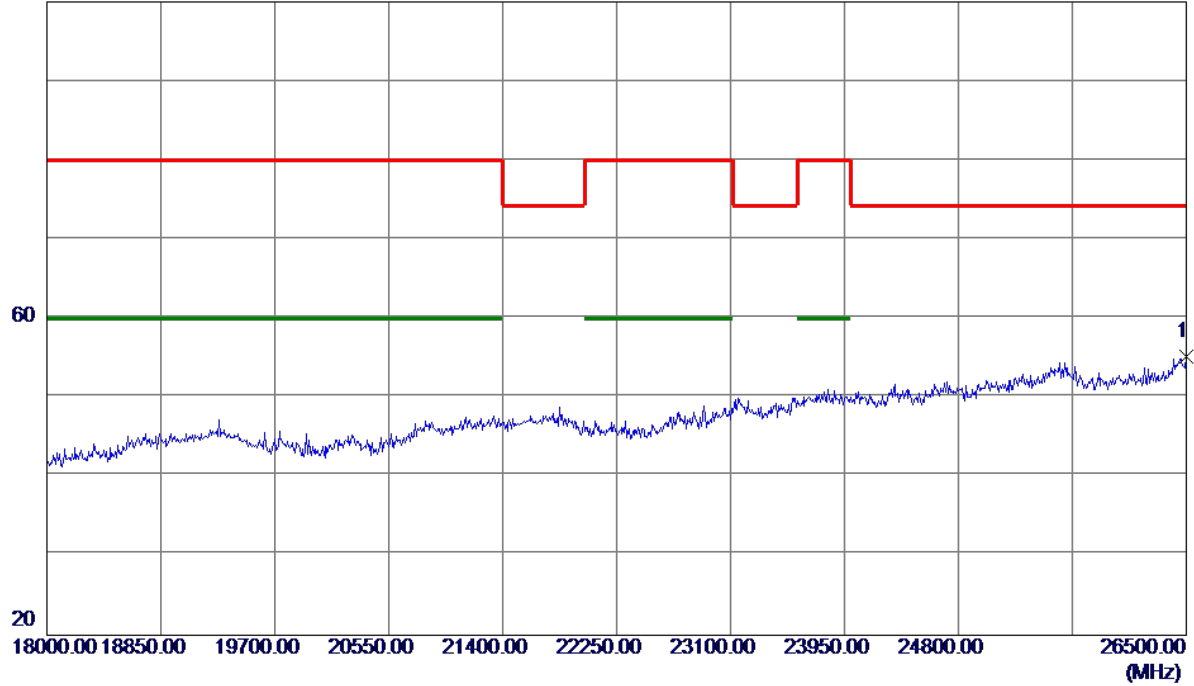

No.	Freq. MHz	Reading Level dBuV/m	Correct Factor dB	Measure ment dBuV/m	Limit dBuV/m	Margin dB	Detector	Comment
1 *	26500.0000	29.11	26.12	55.23	74.30	-19.07	Peak	

Orthogonal Axis :	X
Test Mode :	UNII-2A/ TX A Mode 5260MHz

Vertical

100 dBuV/m

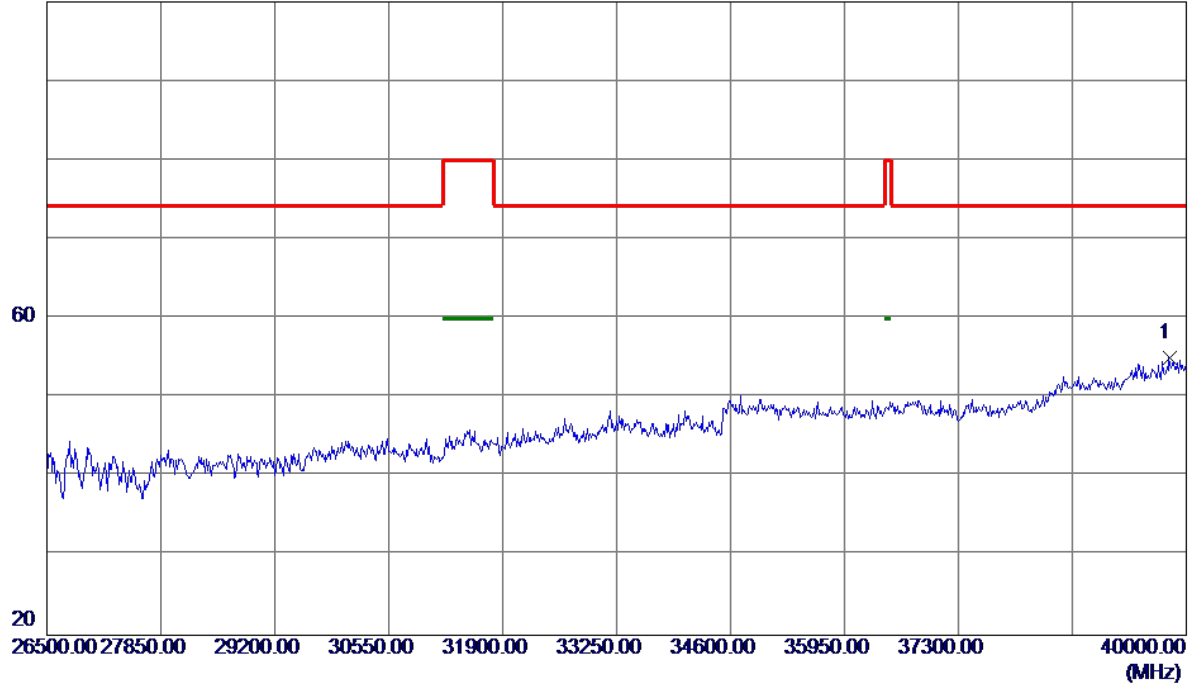

No.	Freq. MHz	Reading Level dBuV/m	Correct Factor dB	Measure ment dBuV/m	Limit dBuV/m	Margin dB	Detector	Comment
1 *	39797.5000	39.42	15.56	54.98	74.30	-19.32	Peak	

Orthogonal Axis :	X
Test Mode :	UNII-2A/ TX A Mode 5260MHz

Horizontal

130 dBuV/m

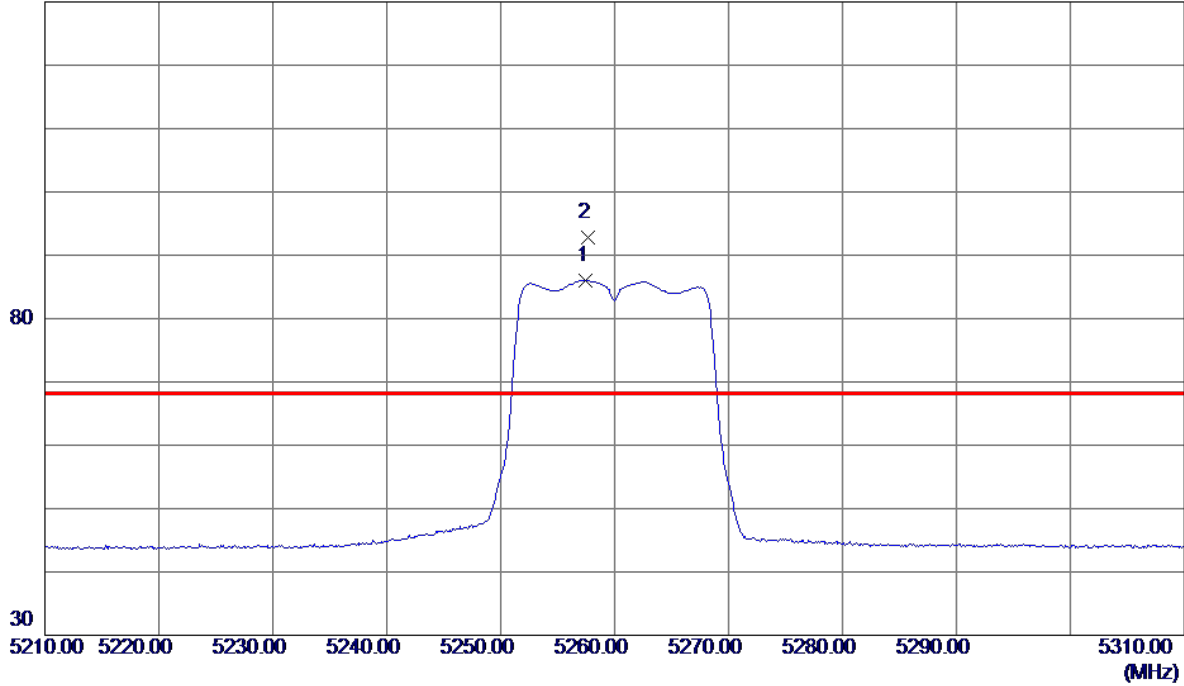

No.	Freq. MHz	Reading Level dBuV/m	Correct Factor dB	Measure ment dBuV/m	Limit dBuV/m	Margin dB	Detector	Comment
1	5257.5000	64.63	21.42	86.05	999.00	-912.95	AVG	No Limit
2 *	5257.7000	71.29	21.42	92.71	68.30	24.41	Peak	No Limit

Orthogonal Axis :	X
Test Mode :	UNII-2A/ TX A Mode 5260MHz

Horizontal

130 dBuV/m

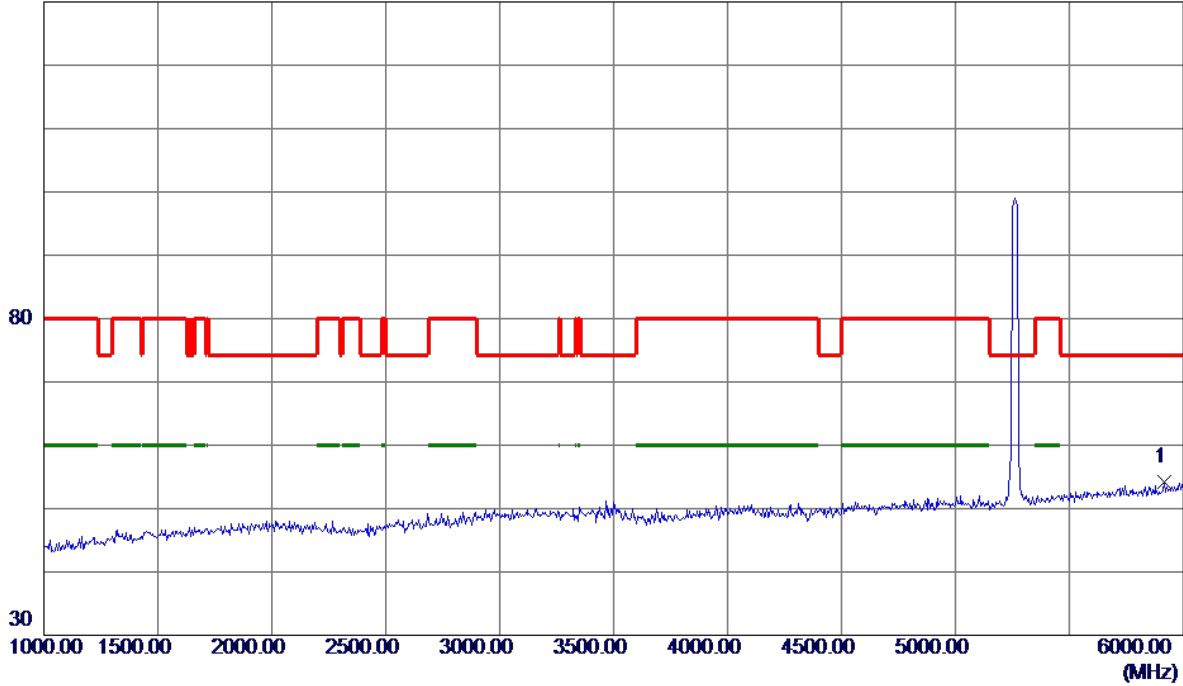

No.	Freq. MHz	Reading Level dBuV/m	Correct Factor dB	Measure ment dBuV/m	Limit dBuV/m	Margin dB	Detector	Comment
1 *	5915.0000	35.18	19.11	54.29	74.30	-20.01	Peak	

Orthogonal Axis :	X
Test Mode :	UNII-2A/ TX A Mode 5260MHz

Horizontal

130 dBuV/m

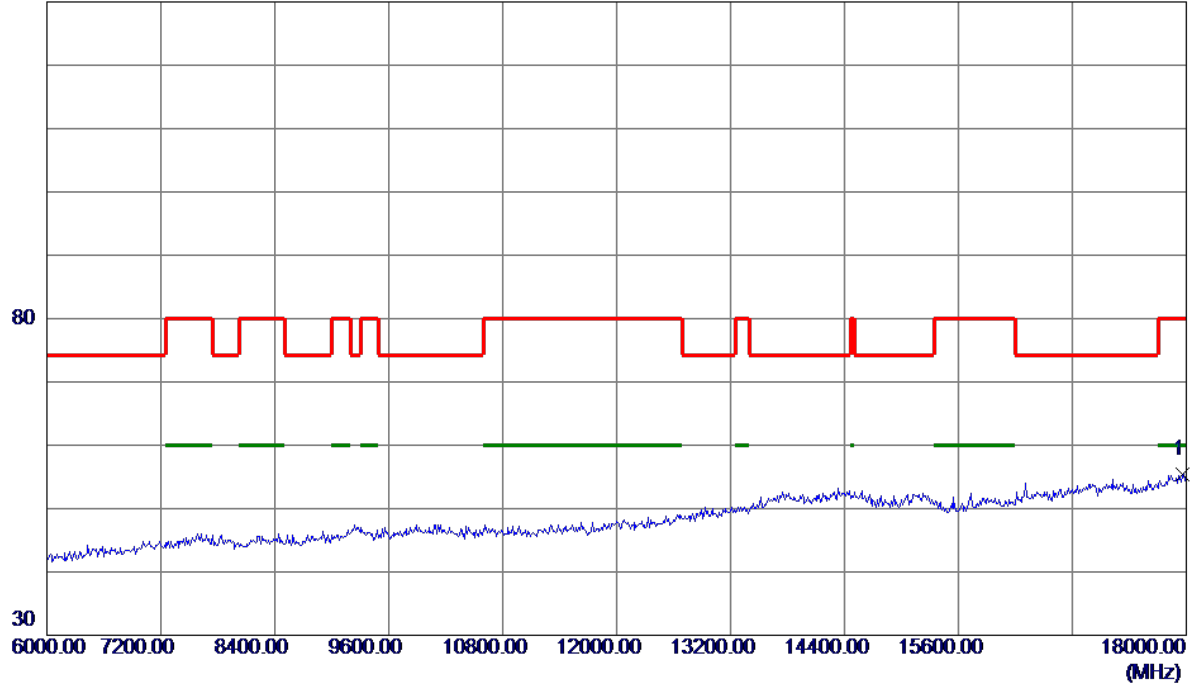

No.	Freq. MHz	Reading Level dBuV/m	Correct Factor dB	Measure ment dBuV/m	Limit dBuV/m	Margin dB	Detector	Comment
1 *	17964.0000	26.37	29.04	55.41	80.00	-24.59	Peak	

Orthogonal Axis :	X
Test Mode :	UNII-2A/ TX A Mode 5260MHz

Horizontal

100 dBuV/m

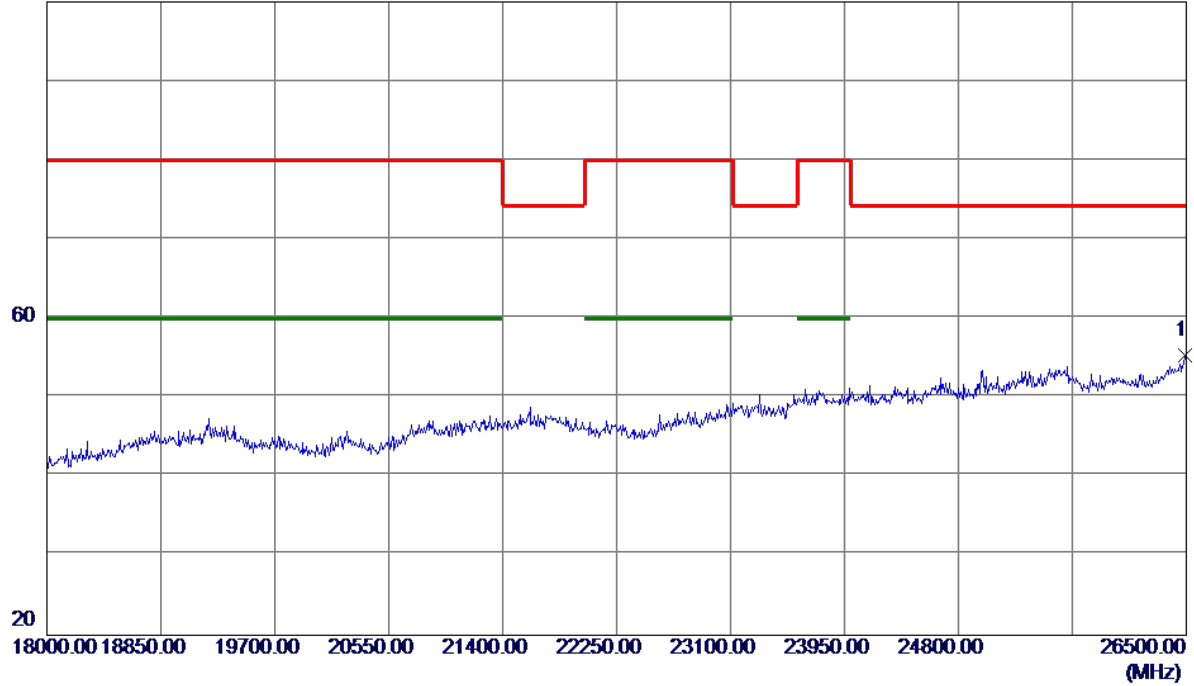

No.	Freq. MHz	Reading Level dBuV/m	Correct Factor dB	Measure ment dBuV/m	Limit dBuV/m	Margin dB	Detector	Comment
1 *	26491.5000	29.35	26.07	55.42	74.30	-18.88	Peak	

Orthogonal Axis :	X
Test Mode :	UNII-2A/ TX A Mode 5260MHz

Horizontal

100 dBuV/m

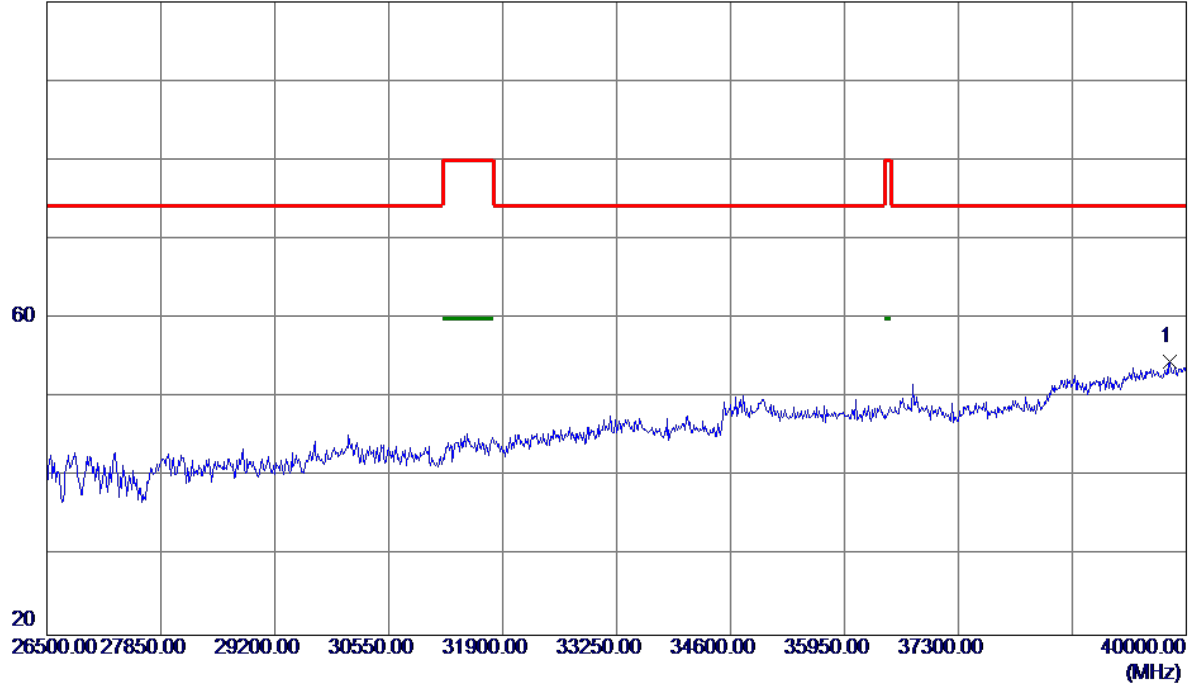

No.	Freq. MHz	Reading Level dBuV/m	Correct Factor dB	Measure ment dBuV/m	Limit dBuV/m	Margin dB	Detector	Comment
1 *	39811.0000	38.92	15.58	54.50	74.30	-19.80	Peak	

Orthogonal Axis :	X
Test Mode :	UNII-2A/ TX A Mode 5280MHz

Vertical

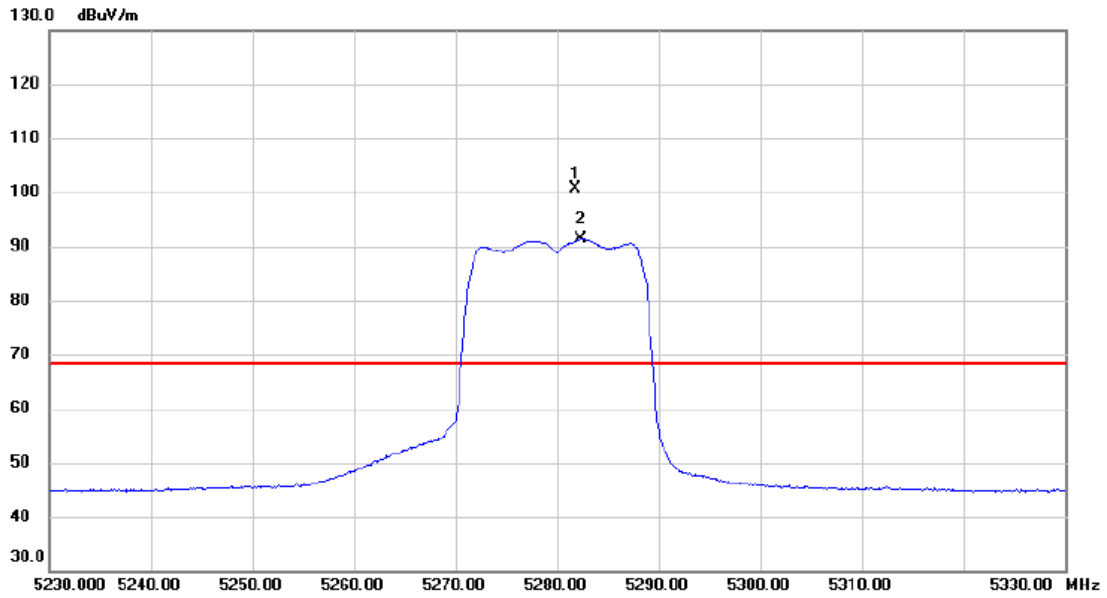

No.	Mk.	Freq.	Reading Level	Correct Factor	Measurement	Limit	Margin	Detector	Comment
		MHz	dBuV	dB	dBuV/m	dBuV/m	dB		
1	*	5281.800	79.01	21.51	100.52	68.30	32.22	peak	No Limit
2	X	5282.400	69.94	21.51	91.45	68.30	23.15	AVG	No Limit

Orthogonal Axis :	X
Test Mode :	UNII-2A/ TX A Mode 5280MHz

Vertical

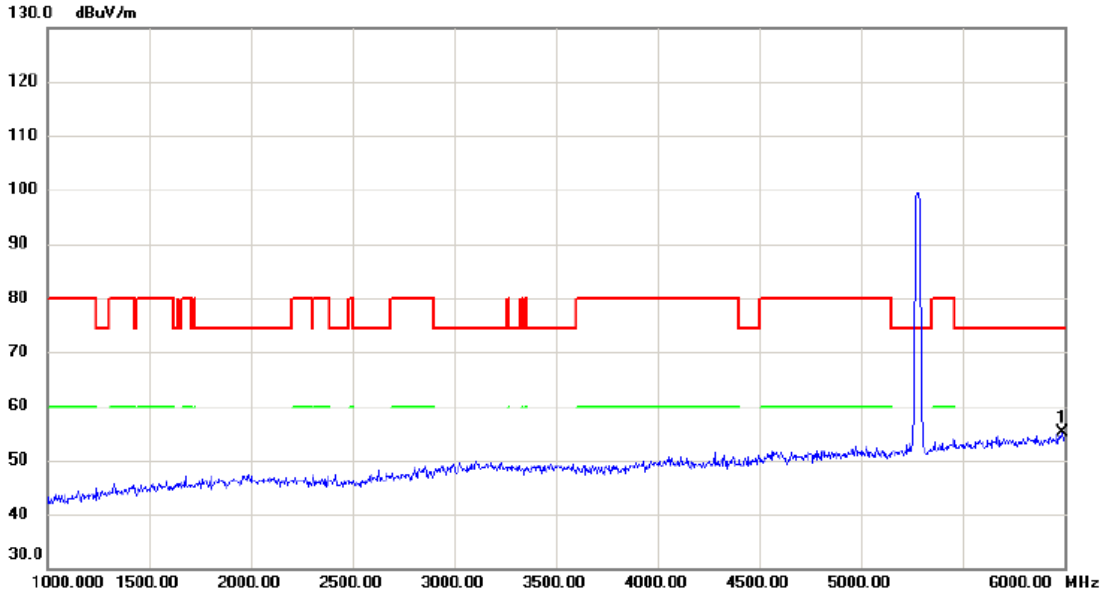

No.	Mk.	Freq.	Reading Level	Correct Factor	Measurement	Limit	Margin	Detector	Comment
		MHz	dBuV	dB	dBuV/m	dBuV/m	dB		
1	*	5990.000	30.82	24.25	55.07	74.30	-19.23	peak	

Orthogonal Axis :	X
Test Mode :	UNII-2A/ TX A Mode 5280MHz

Vertical

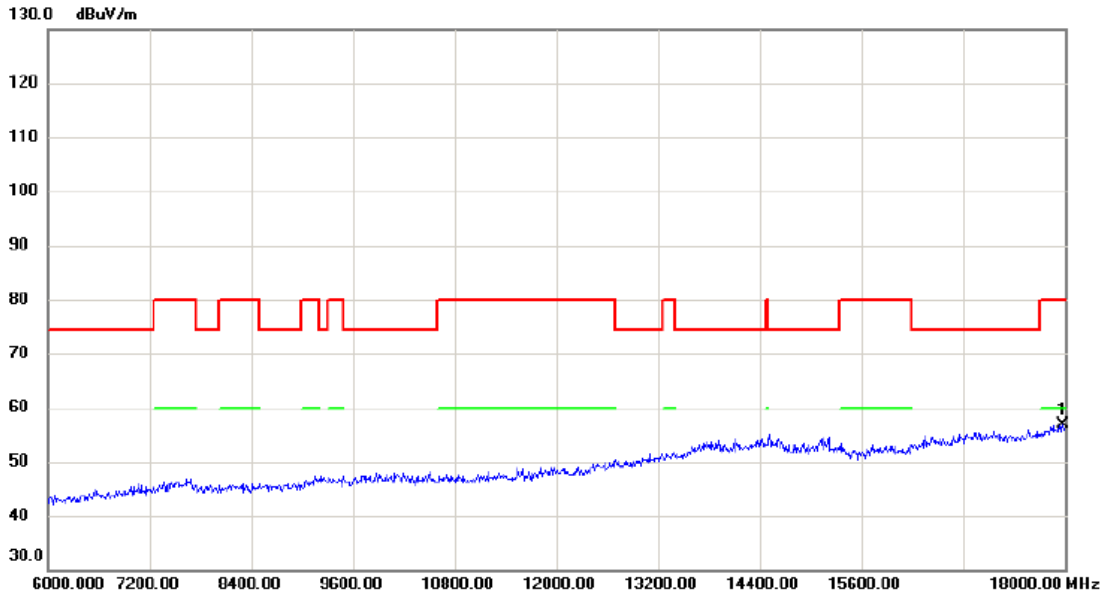

No.	Mk.	Freq. MHz	Reading Level dBuV	Correct Factor dB	Measure- ment dBuV/m	Limit dBuV/m	Margin dB	Detector	Comment
1	*	17976.00	27.74	29.09	56.83	80.00	-23.17	peak	

Orthogonal Axis :	X
Test Mode :	UNII-2A/ TX A Mode 5280MHz

Vertical

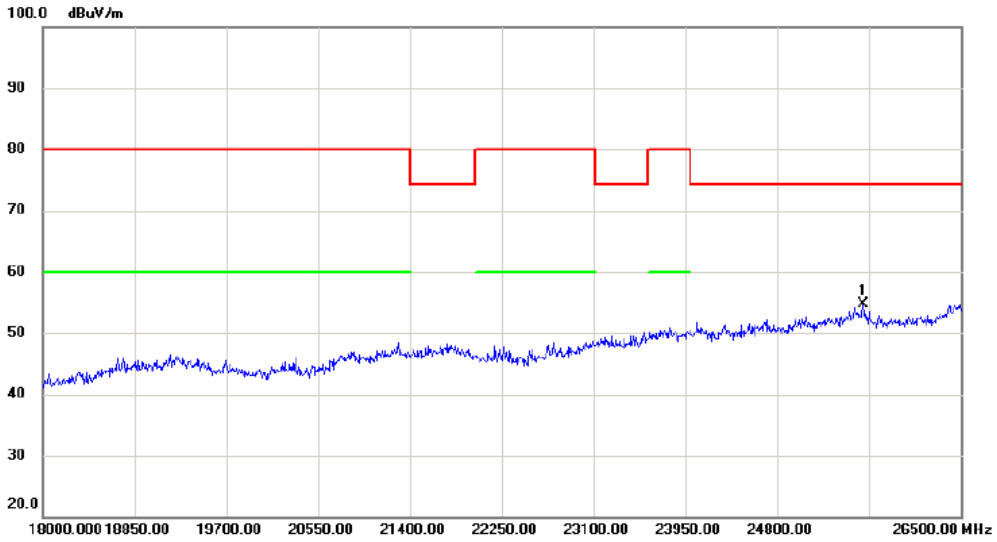

No.	Mk.	Freq.	Reading Level	Correct Factor	Measurement	Limit	Margin	Detector	Comment
		MHz	dBuV	dB	dBuV/m	dBuV/m	dB		
1	*	25599.00	30.86	23.87	54.73	74.30	-19.57	peak	

Orthogonal Axis :	X
Test Mode :	UNII-2A/ TX A Mode 5280MHz

Vertical

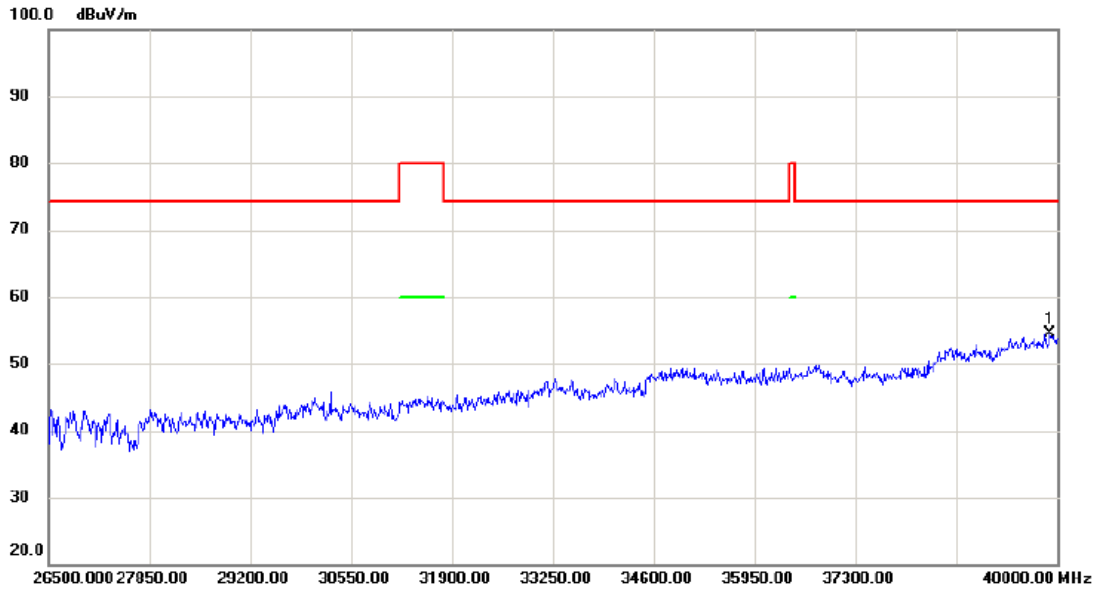

No.	Mk.	Freq. MHz	Reading Level dBuV	Correct Factor dB	Measure- ment dBuV/m	Limit dBuV/m	Margin dB	Detector	Comment
1	*	39905.50	38.80	15.73	54.53	74.30	-19.77	peak	

Orthogonal Axis :	X
Test Mode :	UNII-2A/ TX A Mode 5280MHz

Horizontal

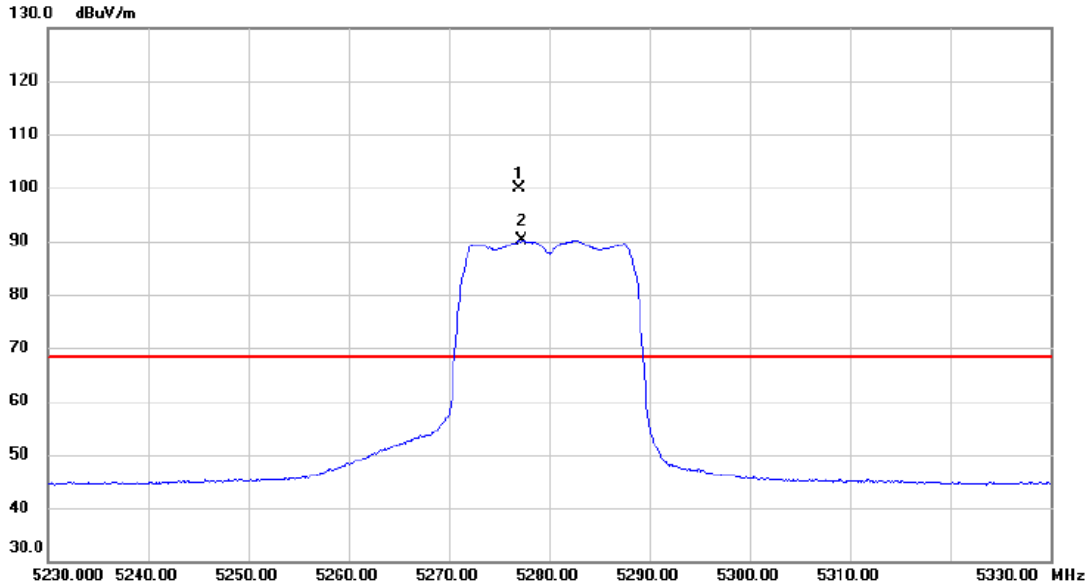

No.	Mk.	Freq. MHz	Reading Level dBuV	Correct Factor dB	Measure- ment dBuV/m	Limit dBuV/m	Margin dB	Detector	Comment
1	*	5277.000	78.51	21.49	100.00	68.30	31.70	peak	No Limit
2	X	5277.300	68.60	21.49	90.09	68.30	21.79	AVG	No Limit

Orthogonal Axis :	X
Test Mode :	UNII-2A/ TX A Mode 5280MHz

Horizontal

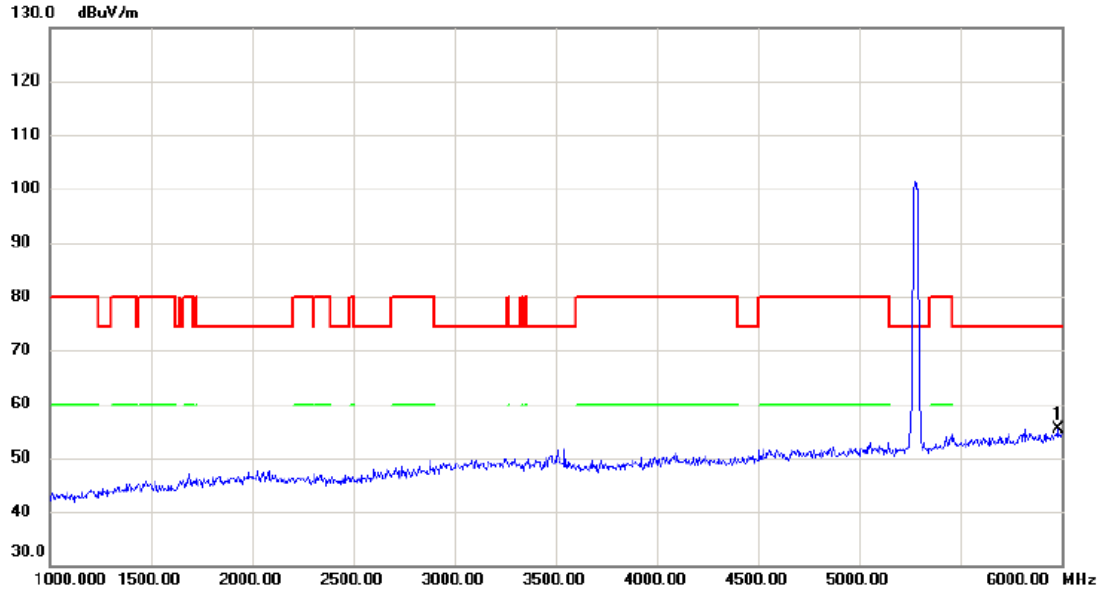

No.	Mk.	Freq. MHz	Reading Level dBuV	Correct Factor dB	Measure- ment dBuV/m	Limit dBuV/m	Margin dB	Detector	Comment
1	*	5980.000	31.19	24.21	55.40	74.30	-18.90	peak	

Orthogonal Axis :	X
Test Mode :	UNII-2A/ TX A Mode 5280MHz

Horizontal

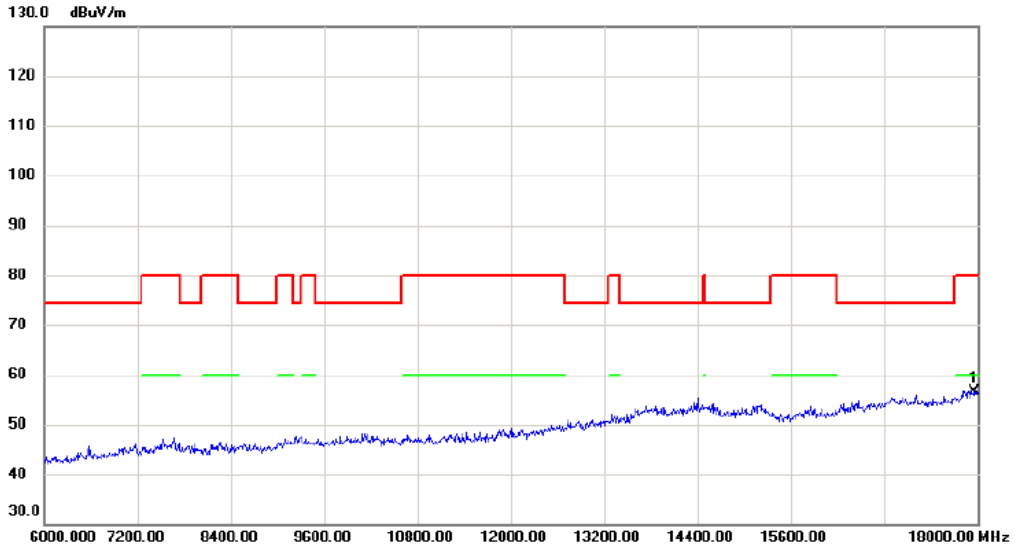

No.	Mk.	Freq.	Reading Level	Correct Factor	Measurement	Limit	Margin	Detector	Comment
		MHz	dBuV	dB	dBuV/m	dBuV/m	dB		
1	*	17964.00	27.71	29.04	56.75	80.00	-23.25	peak	

Orthogonal Axis :	X
Test Mode :	UNII-2A/ TX A Mode 5280MHz

Horizontal

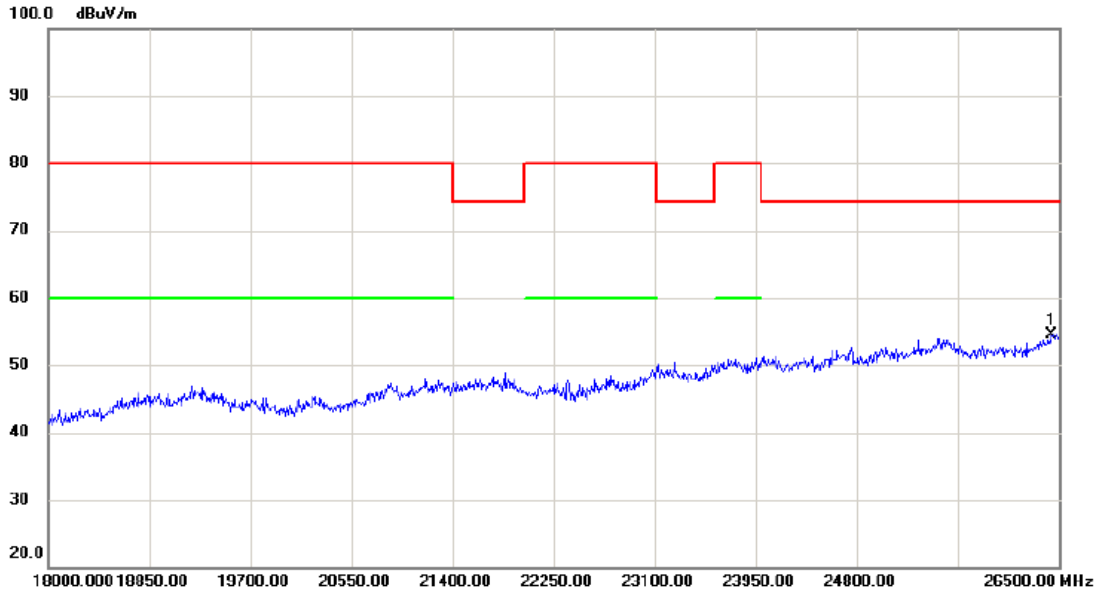

No.	Mk.	Freq. MHz	Reading Level dBuV	Correct Factor dB	Measure- ment dBuV/m	Limit dBuV/m	Margin dB	Detector	Comment
1	*	26440.50	28.72	25.81	54.53	74.30	-19.77	peak	

Orthogonal Axis :	X
Test Mode :	UNII-2A/ TX A Mode 5280MHz

Horizontal

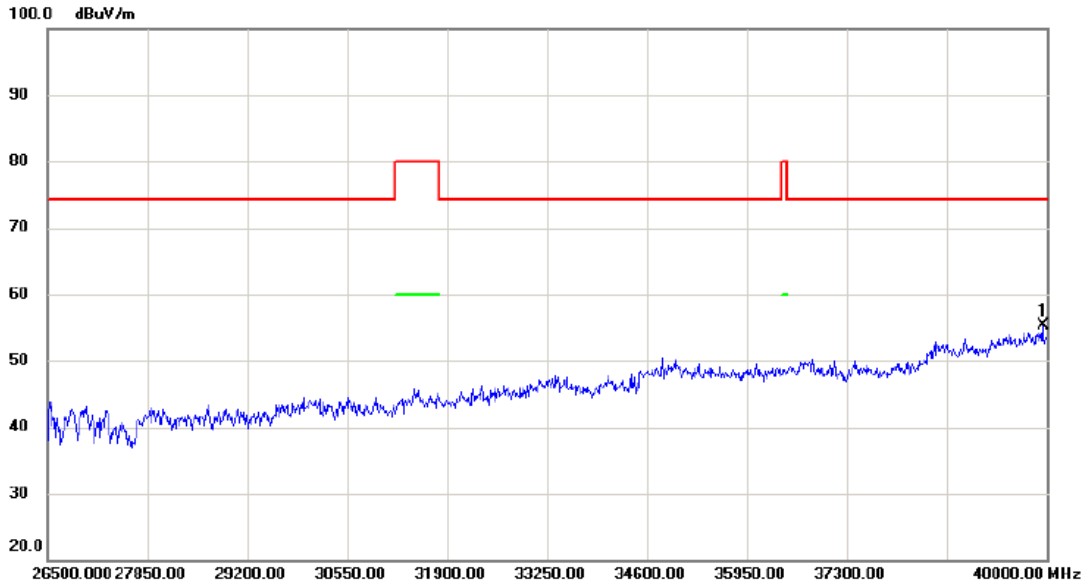

No.	Mk.	Freq. MHz	Reading Level dBuV	Correct Factor dB	Measure- ment dBuV/m	Limit dBuV/m	Margin dB	Detector	Comment
1	*	39946.00	39.46	15.81	55.27	74.30	-19.03	peak	

Orthogonal Axis :	X
Test Mode :	UNII-2A/ TX A Mode 5320MHz

Vertical

130 dBuV/m

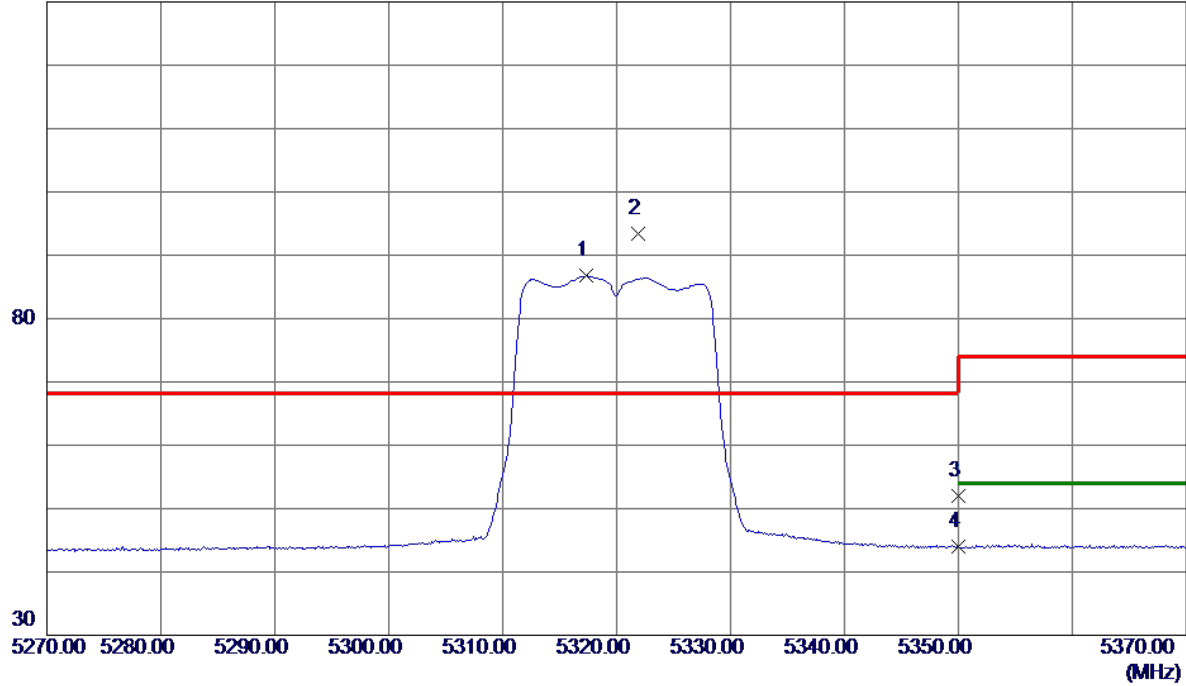

No.	Freq. MHz	Reading Level dBuV/m	Correct Factor dB	Measure ment dBuV/m	Limit dBuV/m	Margin dB	Detector	Comment
1	5317.3000	65.11	21.64	86.75	999.00	-912.25	AVG	No Limit
2 *	5321.9000	71.71	21.66	93.37	68.30	25.07	Peak	No Limit
3	5350.0000	30.22	21.76	51.98	74.00	-22.02	Peak	
4	5350.0000	22.26	21.76	44.02	999.00	-954.98	AVG	

Orthogonal Axis :	X
Test Mode :	UNII-2A/ TX A Mode 5320MHz

Vertical

130 dBuV/m

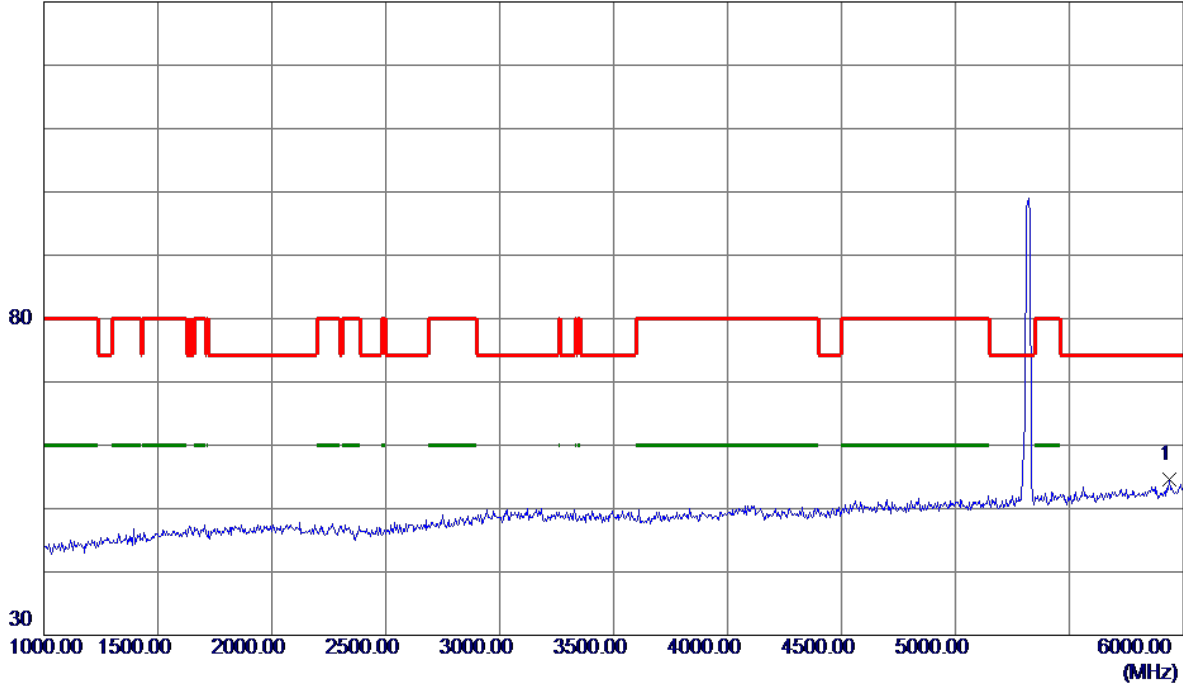

No.	Freq. MHz	Reading Level dBuV/m	Correct Factor dB	Measure ment dBuV/m	Limit dBuV/m	Margin dB	Detector	Comment
1 *	5940.0000	35.40	19.20	54.60	74.30	-19.70	Peak	

Orthogonal Axis :	X
Test Mode :	UNII-2A/ TX A Mode 5320MHz

Vertical

130 dBuV/m

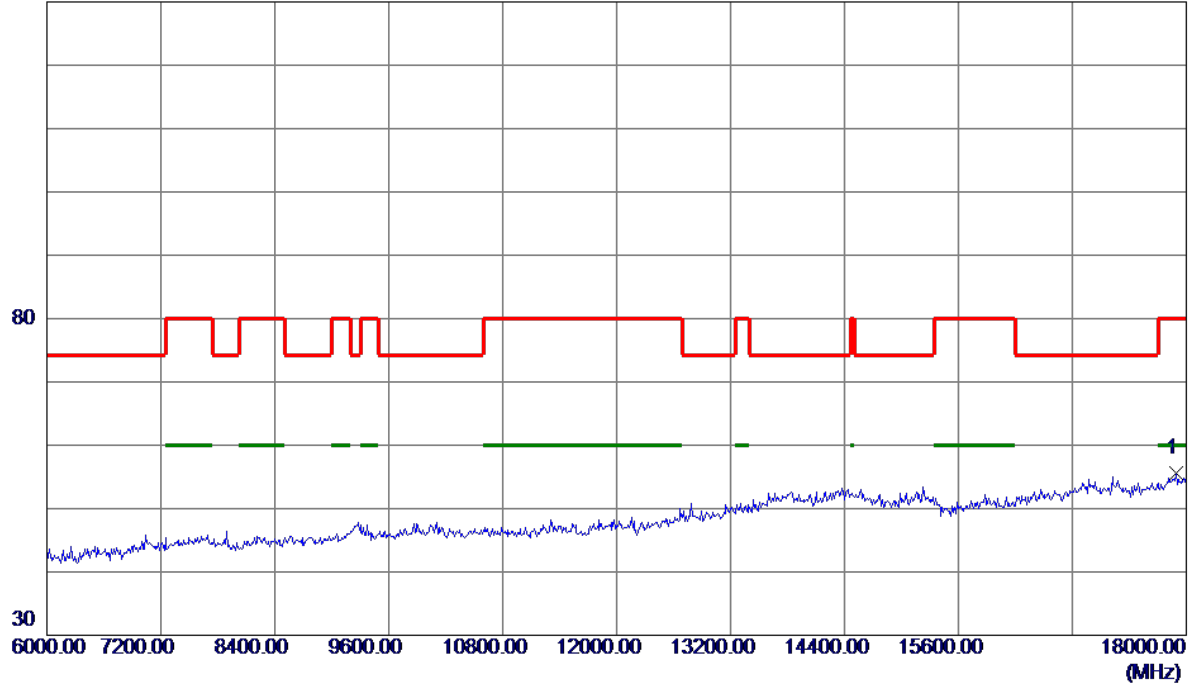

No.	Freq. MHz	Reading Level dBuV/m	Correct Factor dB	Measure ment dBuV/m	Limit dBuV/m	Margin dB	Detector	Comment
1 *	17892.0000	26.85	28.81	55.66	80.00	-24.34	Peak	

Orthogonal Axis :	X
Test Mode :	UNII-2A/ TX A Mode 5320MHz

Vertical

100 dBuV/m

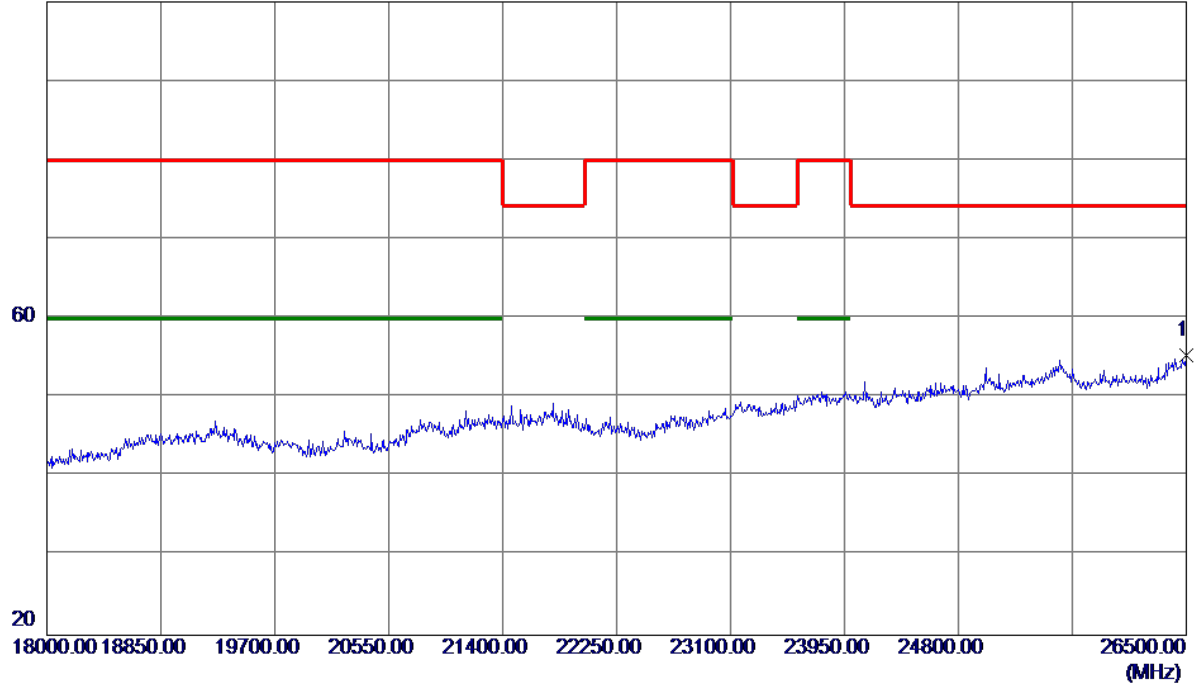

No.	Freq. MHz	Reading Level dBuV/m	Correct Factor dB	Measure ment dBuV/m	Limit dBuV/m	Margin dB	Detector	Comment
1 *	26500.0000	29.20	26.12	55.32	74.30	-18.98	Peak	

Orthogonal Axis :	X
Test Mode :	UNII-2A/ TX A Mode 5320MHz

Vertical

100 dBuV/m

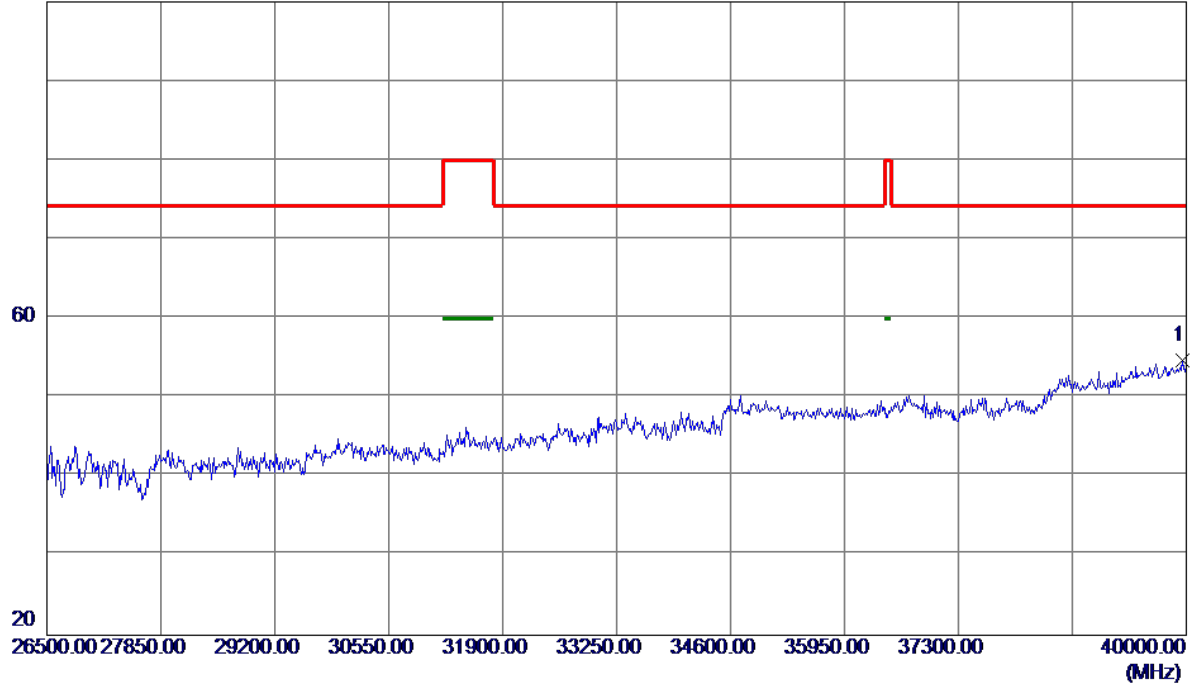

No.	Freq. MHz	Reading Level dBuV/m	Correct Factor dB	Measure ment dBuV/m	Limit dBuV/m	Margin dB	Detector	Comment
1 *	39959.5000	38.96	15.82	54.78	74.30	-19.52	Peak	

Orthogonal Axis :	X
Test Mode :	UNII-2A/ TX A Mode 5320MHz

Horizontal

130 dBuV/m

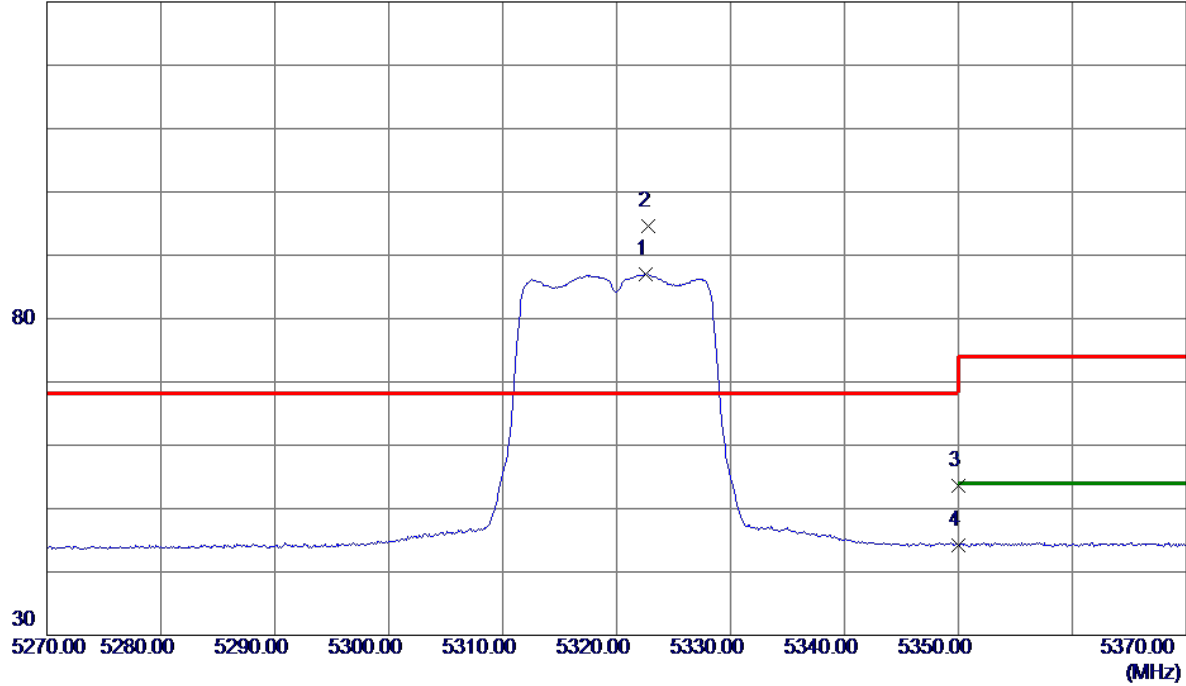

No.	Freq. MHz	Reading Level dBuV/m	Correct Factor dB	Measure ment dBuV/m	Limit dBuV/m	Margin dB	Detector	Comment
1	5322.6000	65.40	21.66	87.06	999.00	-911.94	AVG	No Limit
2 *	5322.8000	72.87	21.66	94.53	68.30	26.23	Peak	No Limit
3	5350.0000	31.76	21.76	53.52	74.00	-20.48	Peak	
4	5350.0000	22.43	21.76	44.19	999.00	-954.81	AVG	

Orthogonal Axis :	X
Test Mode :	UNII-2A/ TX A Mode 5320MHz

Horizontal

130 dBuV/m

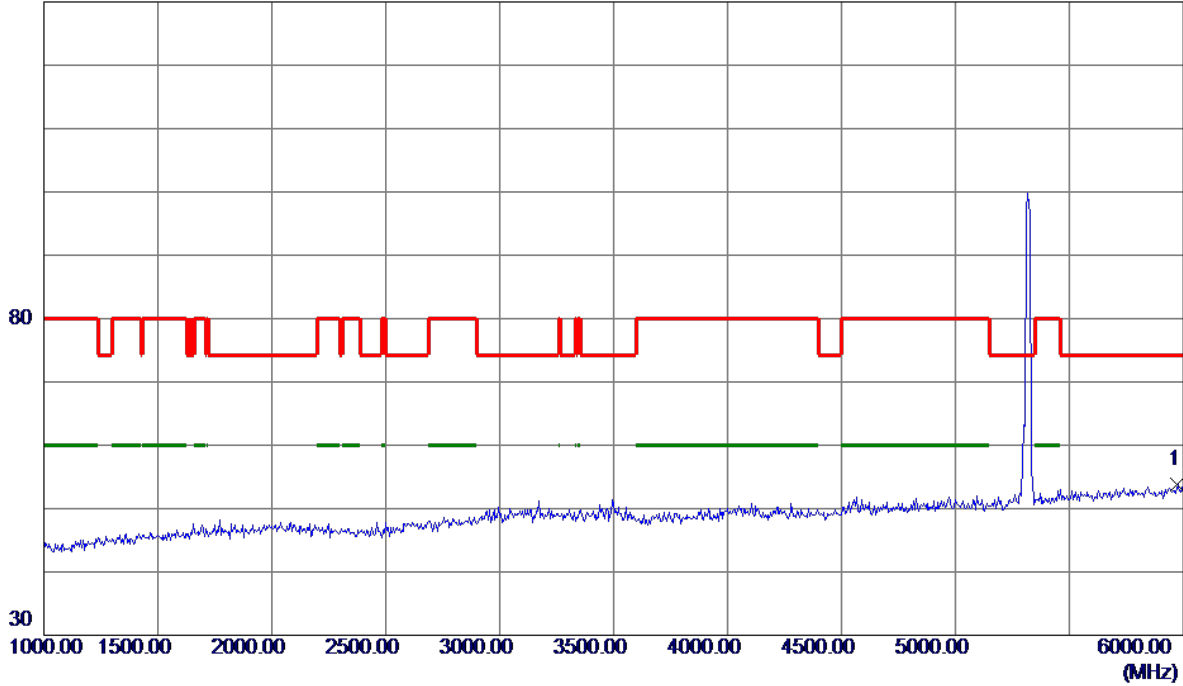

No.	Freq. MHz	Reading Level dBuV/m	Correct Factor dB	Measure ment dBuV/m	Limit dBuV/m	Margin dB	Detector	Comment
1 *	5975.0000	34.41	19.32	53.73	74.30	-20.57	Peak	

Orthogonal Axis :	X
Test Mode :	UNII-2A/ TX A Mode 5320MHz

Horizontal

130 dBuV/m

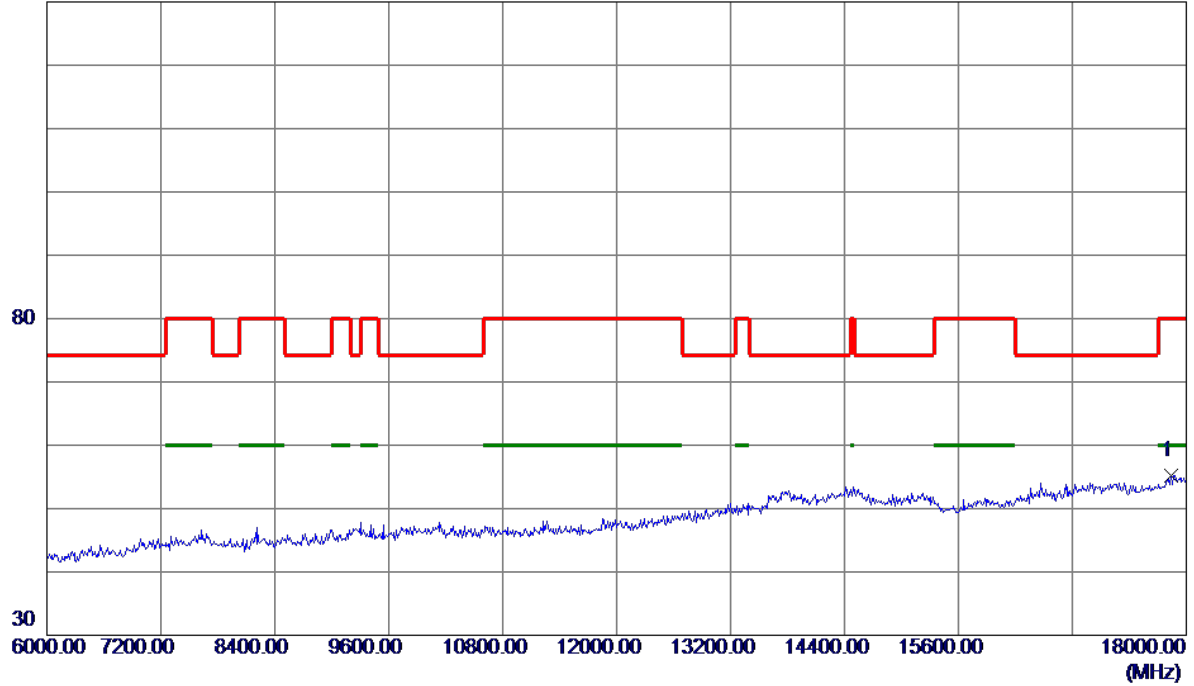

No.	Freq. MHz	Reading Level dBuV/m	Correct Factor dB	Measure ment dBuV/m	Limit dBuV/m	Margin dB	Detector	Comment
1 *	17844.0000	26.59	28.66	55.25	80.00	-24.75	Peak	

Orthogonal Axis :	X
Test Mode :	UNII-2A/ TX A Mode 5320MHz

Horizontal

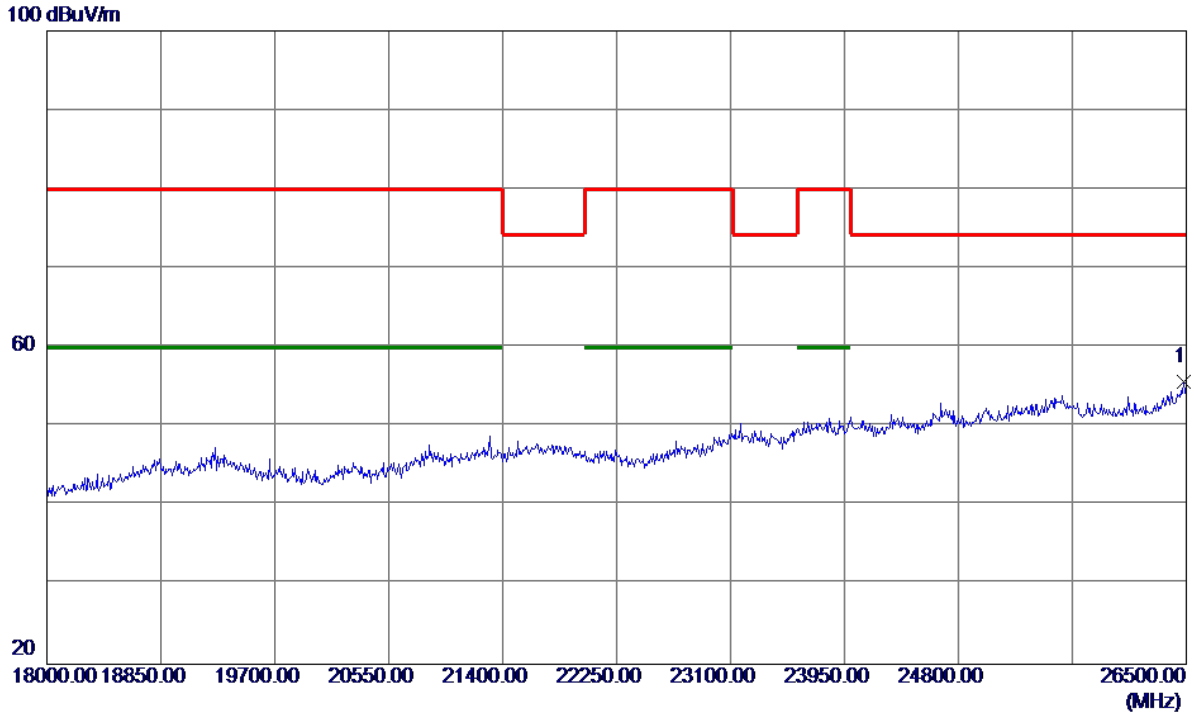

No.	Freq. MHz	Reading Level dBuV/m	Correct Factor dB	Measure ment dBuV/m	Limit dBuV/m	Margin dB	Detector	Comment
1 *	26483.0000	29.63	26.03	55.66	74.30	-18.64	Peak	

Orthogonal Axis :	X
Test Mode :	UNII-2A/ TX A Mode 5320MHz

Horizontal

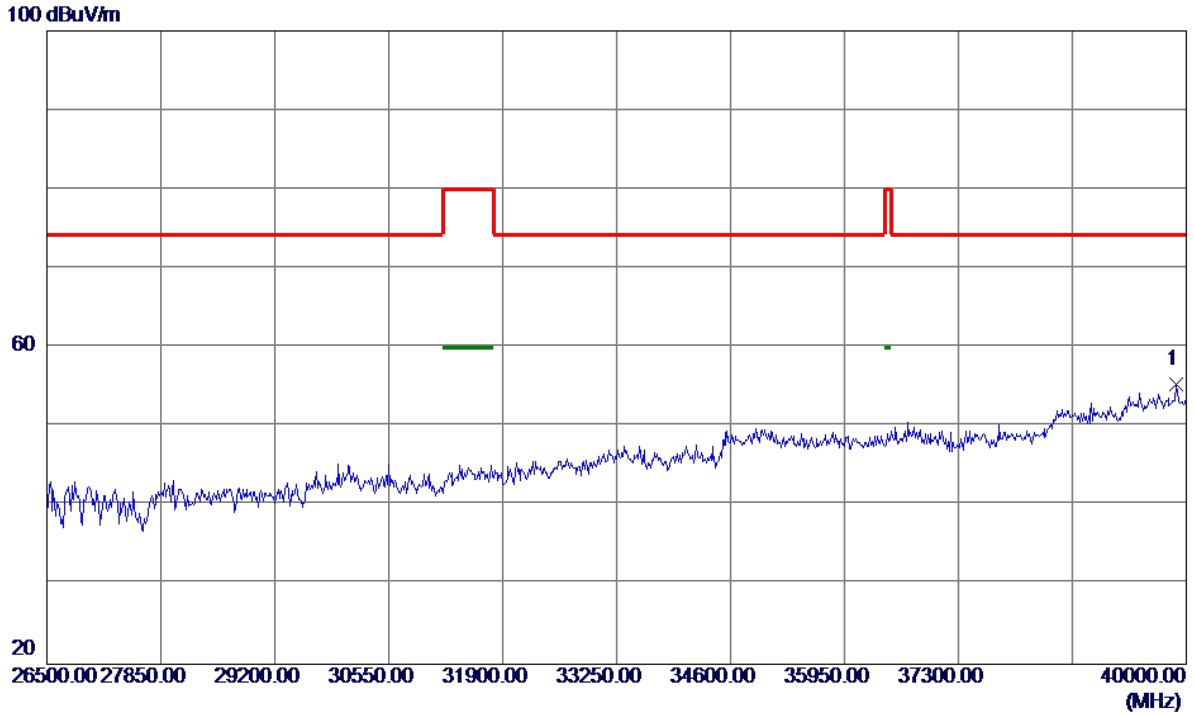

No.	Freq. MHz	Reading Level dBuV/m	Correct Factor dB	Measure ment dBuV/m	Limit dBuV/m	Margin dB	Detector	Comment
1 *	39878.5000	39.69	15.69	55.38	74.30	-18.92	Peak	

Orthogonal Axis :	X
Test Mode :	UNII-2A/ TX N20 Mode 5260MHz

Vertical

130 dBuV/m

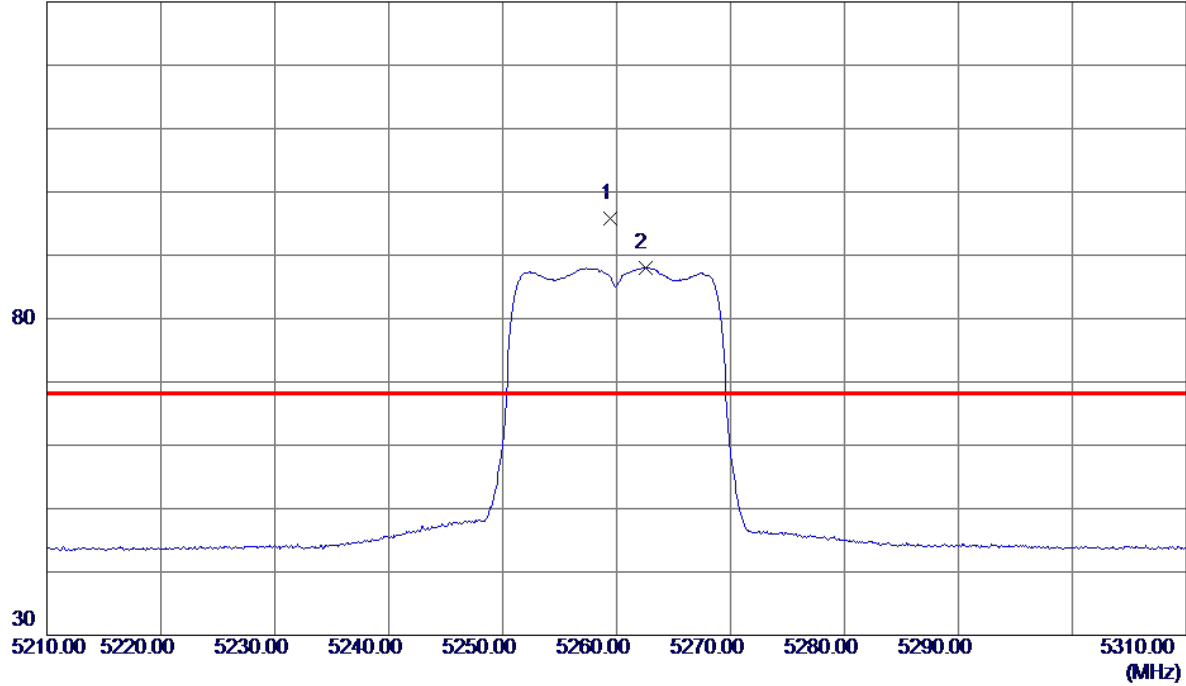

No.	Freq. MHz	Reading Level dBuV/m	Correct Factor dB	Measure ment dBuV/m	Limit dBuV/m	Margin dB	Detector	Comment
1 *	5259.4000	74.36	21.43	95.79	68.30	27.49	Peak	No Limit
2	5262.5000	66.58	21.44	88.02	999.00	-910.98	AVG	No Limit

Orthogonal Axis :	X
Test Mode :	UNII-2A/ TX N20 Mode 5260MHz

Vertical

130 dBuV/m

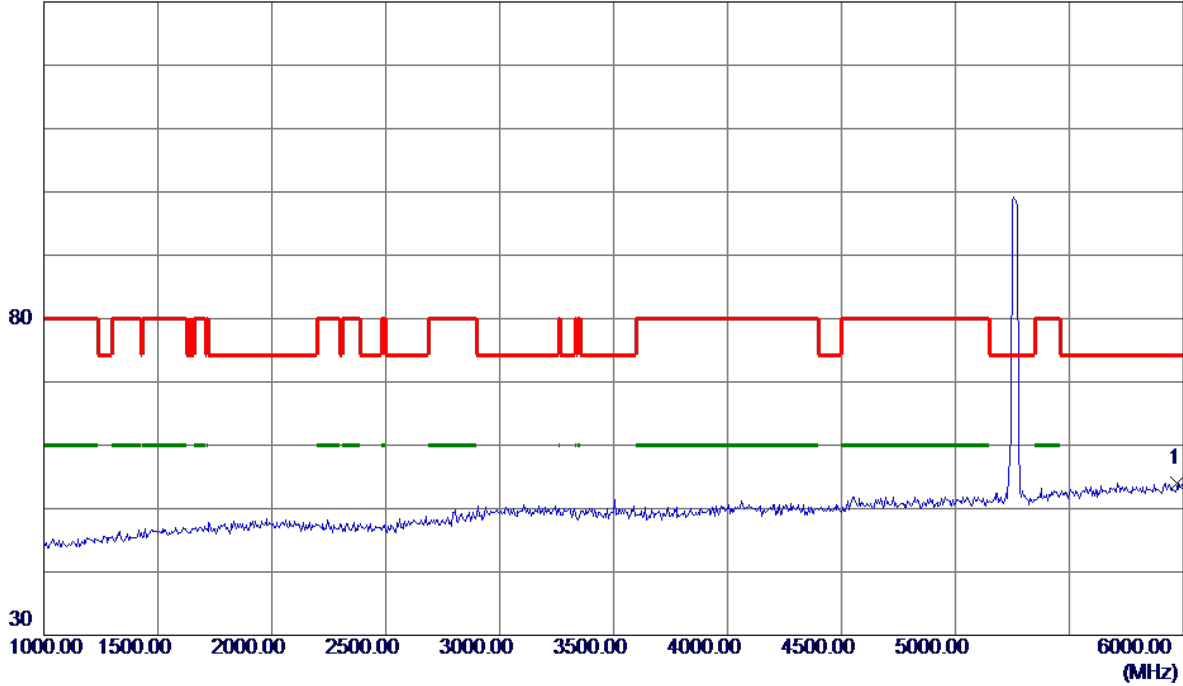

No.	Freq. MHz	Reading Level dBuV/m	Correct Factor dB	Measure ment dBuV/m	Limit dBuV/m	Margin dB	Detector	Comment
1 *	5975.0000	34.71	19.32	54.03	74.30	-20.27	Peak	

Orthogonal Axis :	X
Test Mode :	UNII-2A/ TX N20 Mode 5260MHz

Vertical

130 dBuV/m

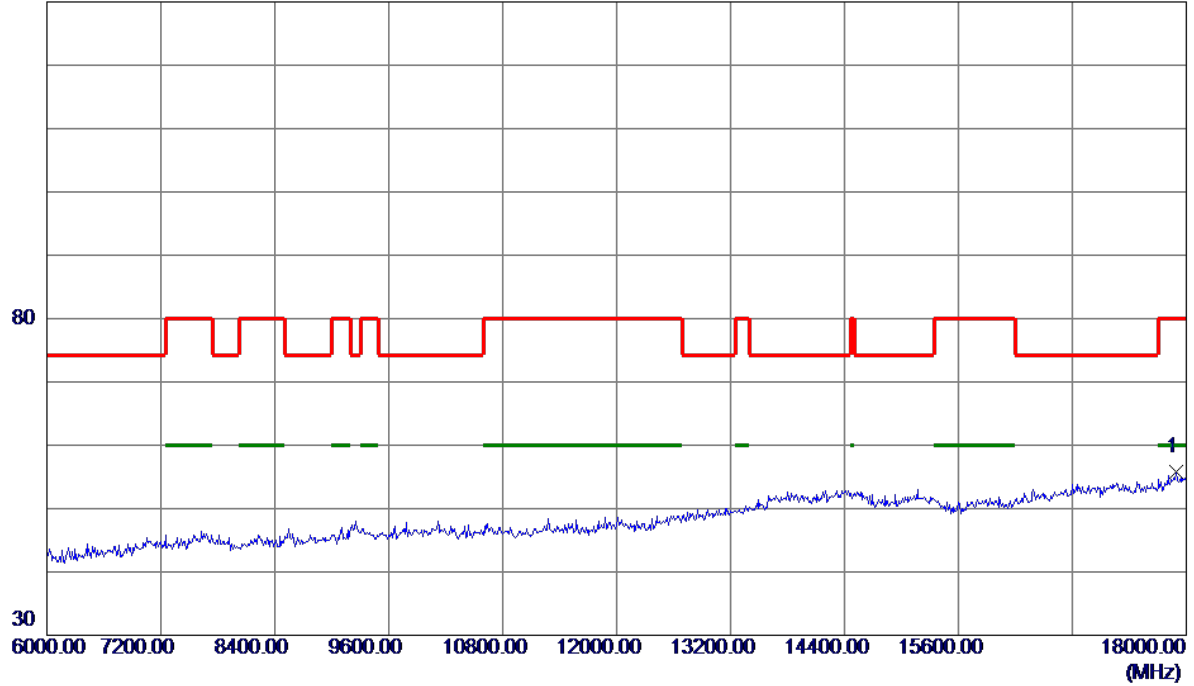

No.	Freq. MHz	Reading Level dBuV/m	Correct Factor dB	Measure ment dBuV/m	Limit dBuV/m	Margin dB	Detector	Comment
1 *	17892.0000	26.92	28.81	55.73	80.00	-24.27	Peak	

Orthogonal Axis :	X
Test Mode :	UNII-2A/ TX N20 Mode 5260MHz

Vertical

100 dBuV/m

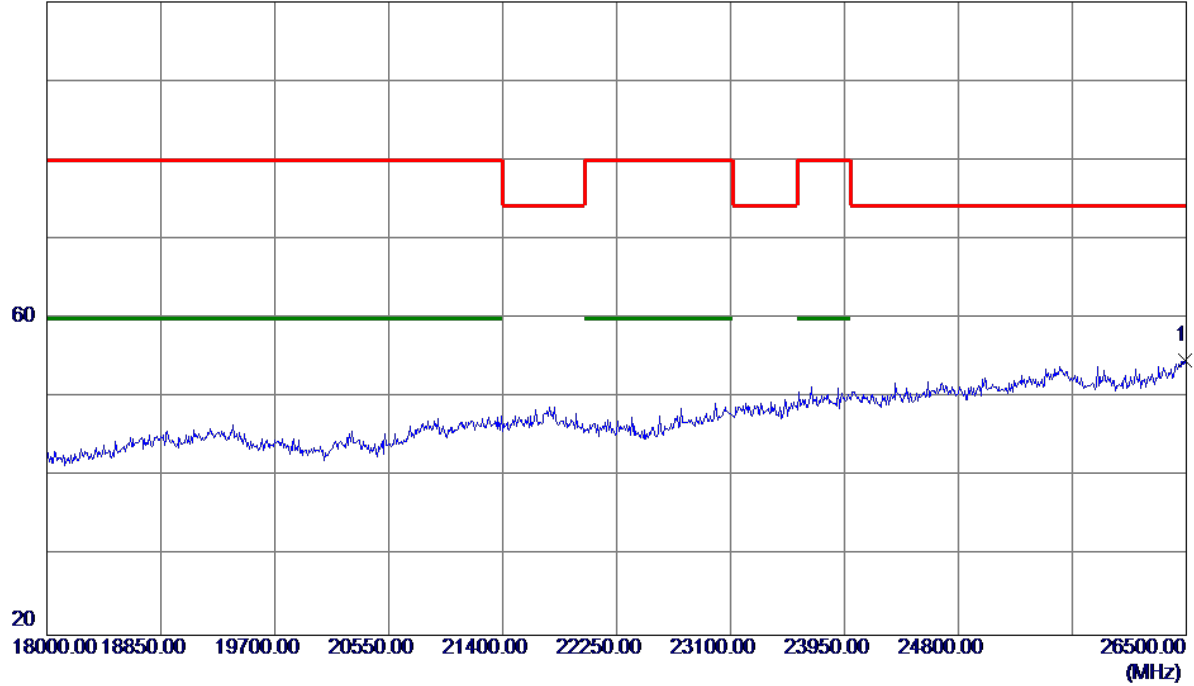

No.	Freq. MHz	Reading Level dBuV/m	Correct Factor dB	Measure ment dBuV/m	Limit dBuV/m	Margin dB	Detector	Comment
1 *	26491.5000	28.61	26.07	54.68	74.30	-19.62	Peak	

Orthogonal Axis :	X
Test Mode :	UNII-2A/ TX N20 Mode 5260MHz

Vertical

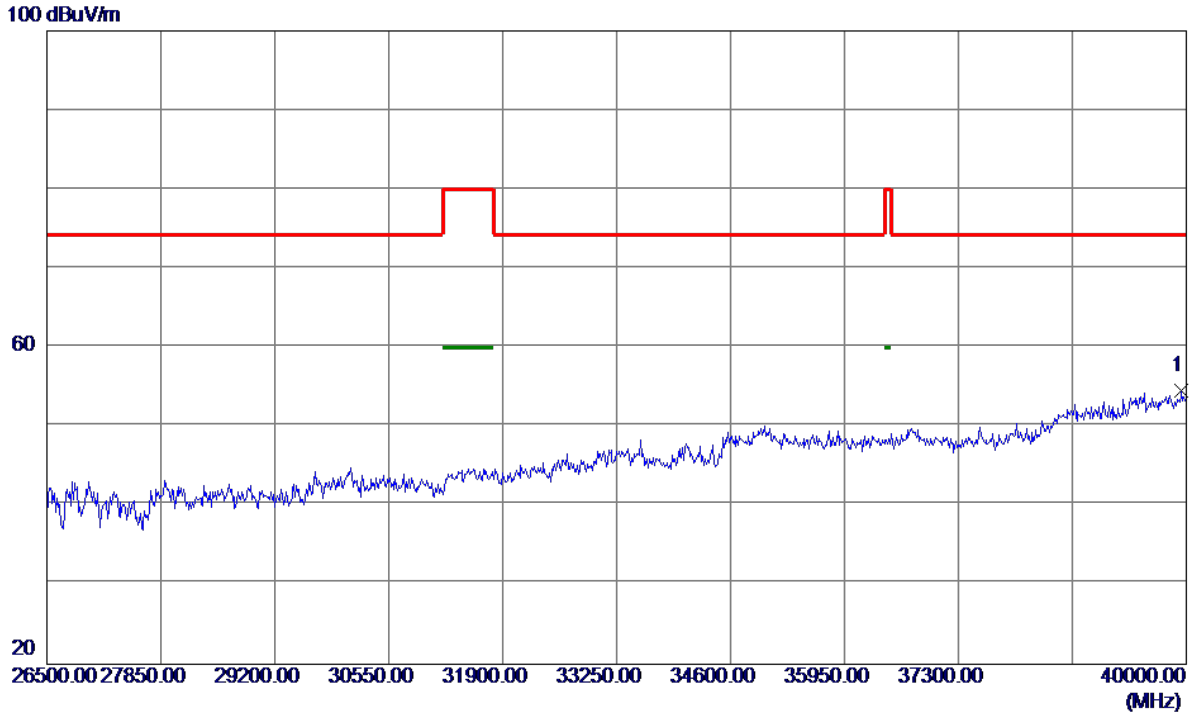

No.	Freq. MHz	Reading Level dBuV/m	Correct Factor dB	Measure ment dBuV/m	Limit dBuV/m	Margin dB	Detector	Comment
1 *	39946.0000	38.69	15.80	54.49	74.30	-19.81	Peak	

Orthogonal Axis :	X
Test Mode :	UNII-2A/ TX N20 Mode 5260MHz

Horizontal

130 dBuV/m

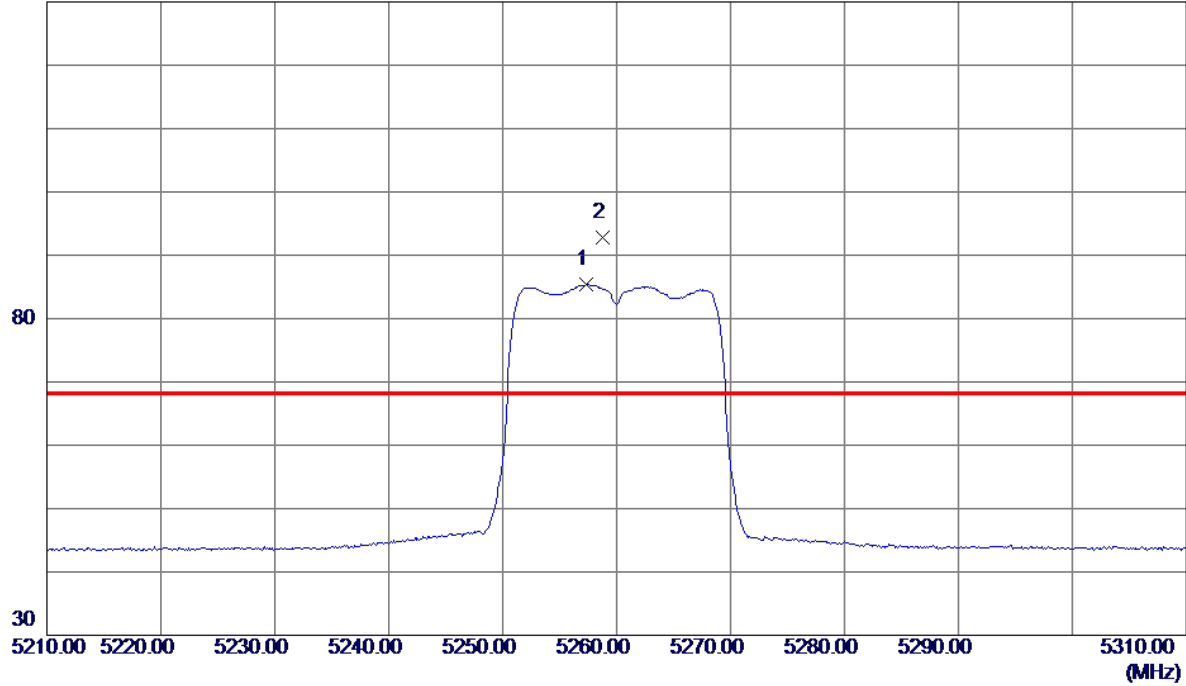

No.	Freq. MHz	Reading Level dBuV/m	Correct Factor dB	Measure ment dBuV/m	Limit dBuV/m	Margin dB	Detector	Comment
1	5257.3000	63.97	21.42	85.39	999.00	-913.61	AVG	No Limit
2 *	5258.8000	71.39	21.43	92.82	68.30	24.52	Peak	No Limit

Orthogonal Axis :	X
Test Mode :	UNII-2A/ TX N20 Mode 5260MHz

Horizontal

130 dBuV/m

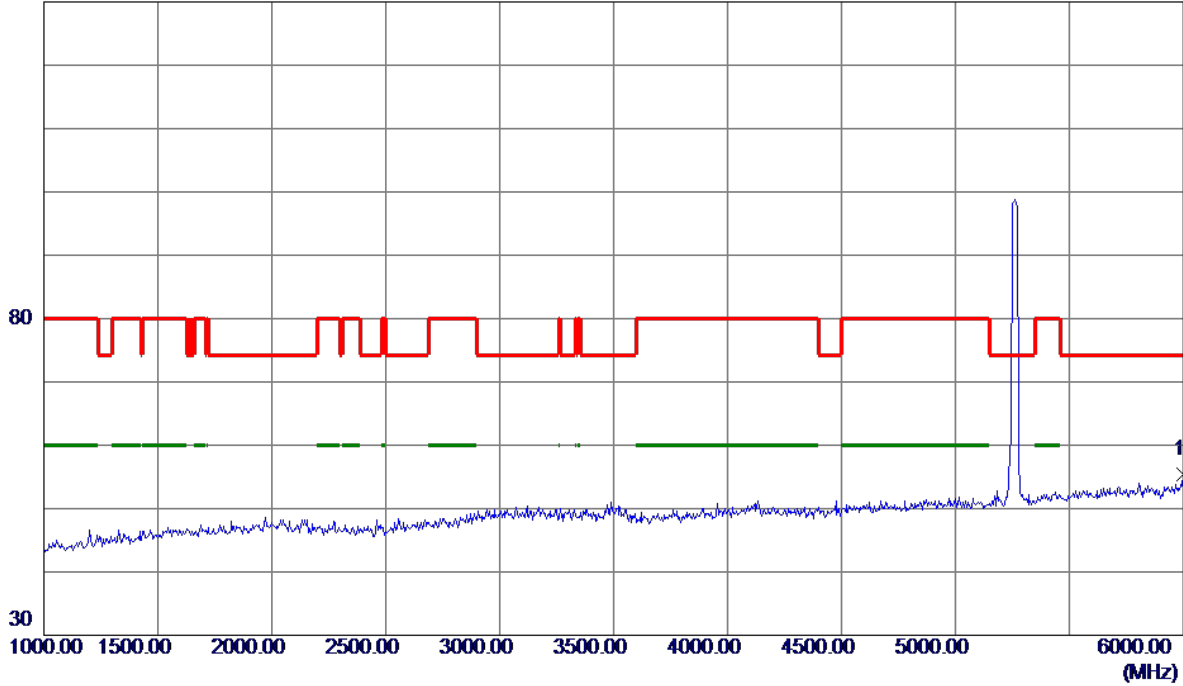

No.	Freq. MHz	Reading Level dBuV/m	Correct Factor dB	Measure ment dBuV/m	Limit dBuV/m	Margin dB	Detector	Comment
1 *	6000.0000	36.08	19.41	55.49	74.30	-18.81	Peak	

Orthogonal Axis :	X
Test Mode :	UNII-2A/ TX N20 Mode 5260MHz

Horizontal

130 dBuV/m

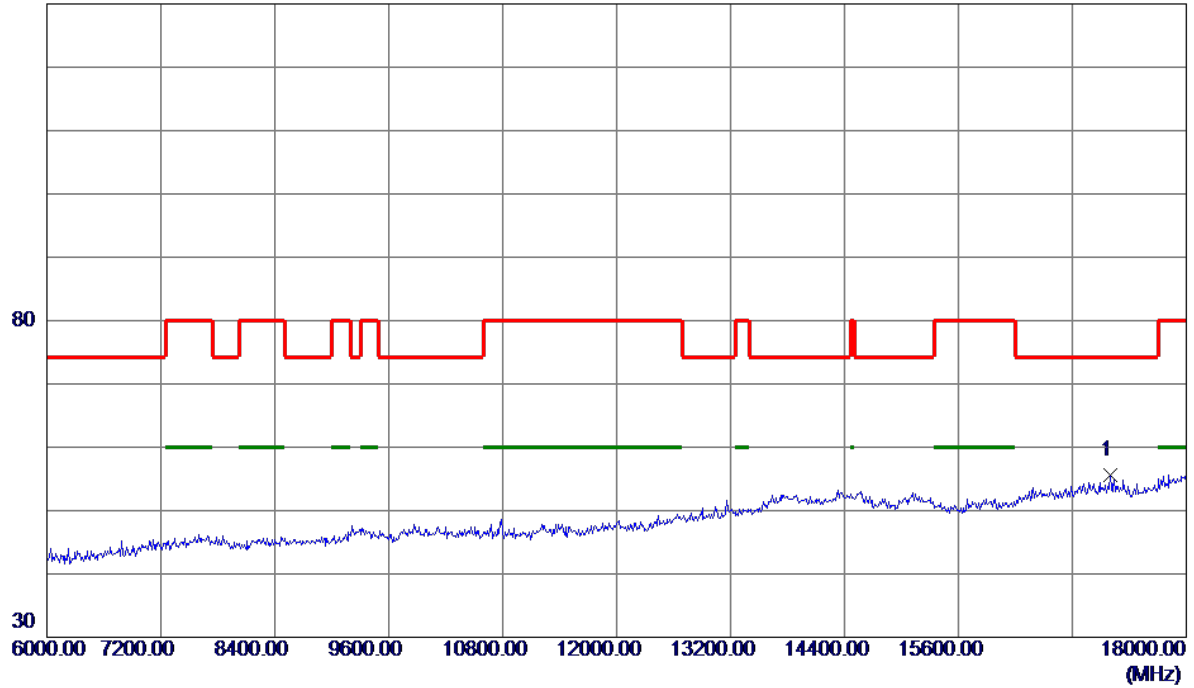

No.	Freq. MHz	Reading Level dBuV/m	Correct Factor dB	Measure ment dBuV/m	Limit dBuV/m	Margin dB	Detector	Comment
1 *	17196.0000	28.44	27.22	55.66	74.30	-18.64	Peak	

Orthogonal Axis :	X
Test Mode :	UNII-2A/ TX N20 Mode 5260MHz

Horizontal

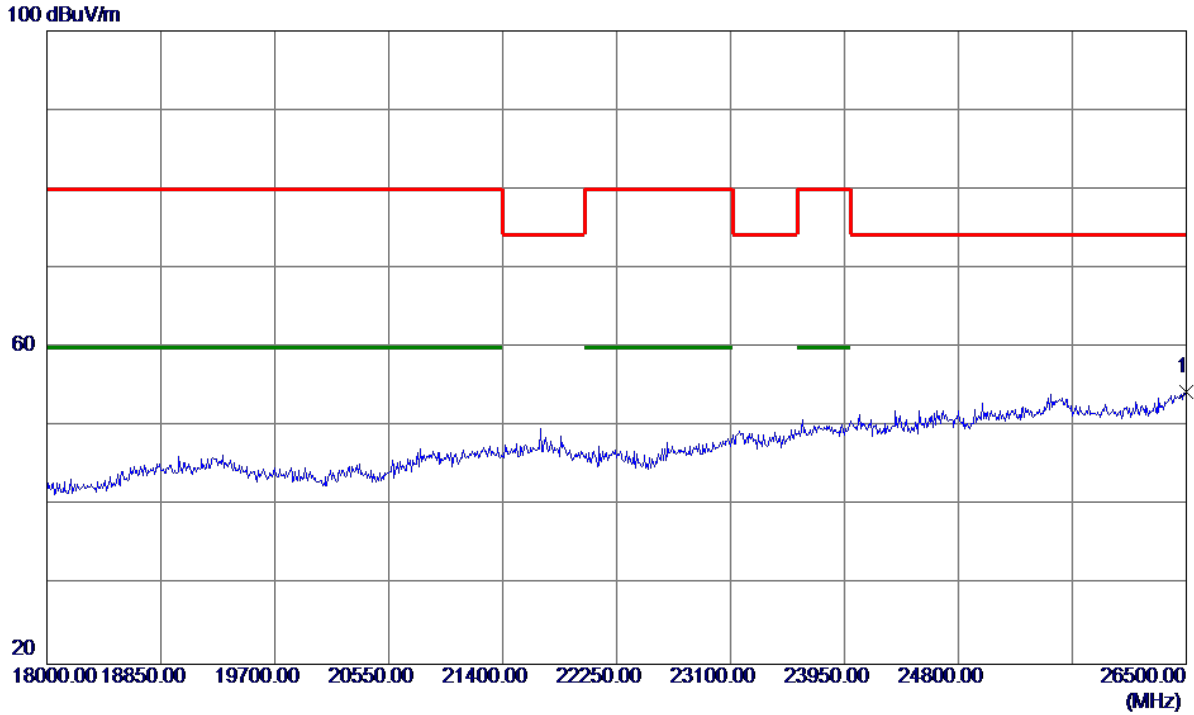

No.	Freq. MHz	Reading Level dBuV/m	Correct Factor dB	Measure ment dBuV/m	Limit dBuV/m	Margin dB	Detector	Comment
1 *	26500.0000	28.23	26.12	54.35	74.30	-19.95	Peak	

Orthogonal Axis :	X
Test Mode :	UNII-2A/ TX N20 Mode 5260MHz

Horizontal

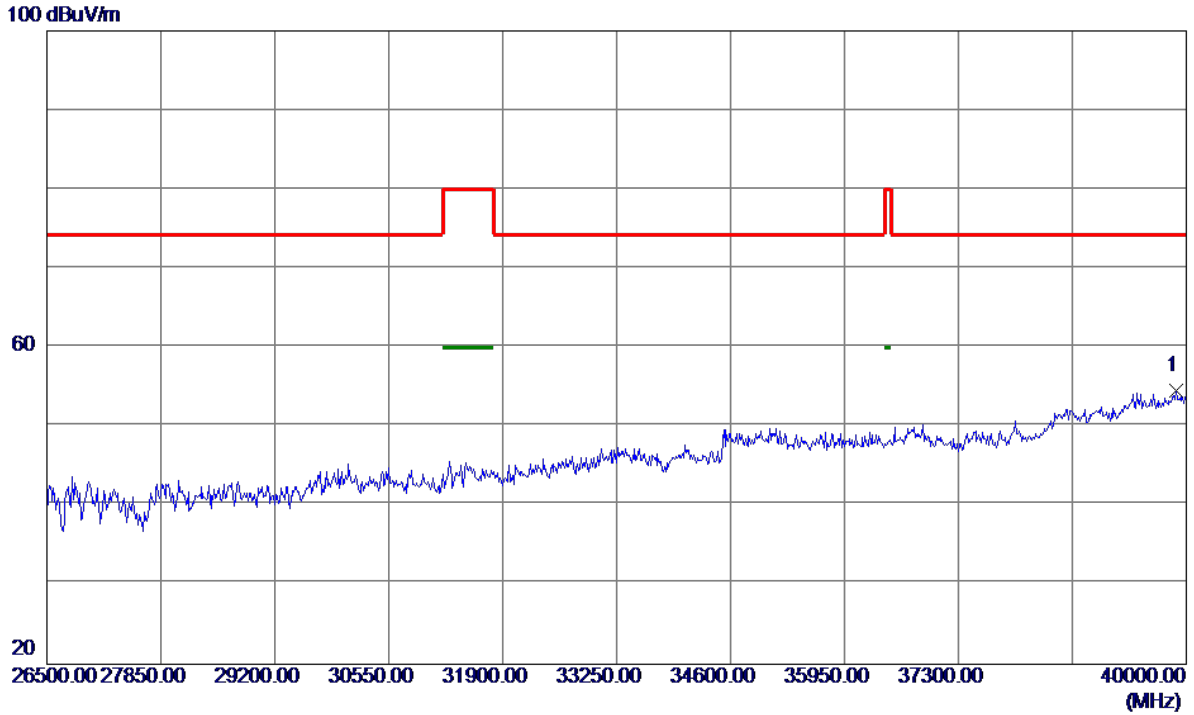

No.	Freq. MHz	Reading Level dBuV/m	Correct Factor dB	Measure ment dBuV/m	Limit dBuV/m	Margin dB	Detector	Comment
1 *	39878.5000	38.84	15.69	54.53	74.30	-19.77	Peak	

Orthogonal Axis :	X
Test Mode :	UNII-2A/ TX N20 Mode 5280MHz

Vertical

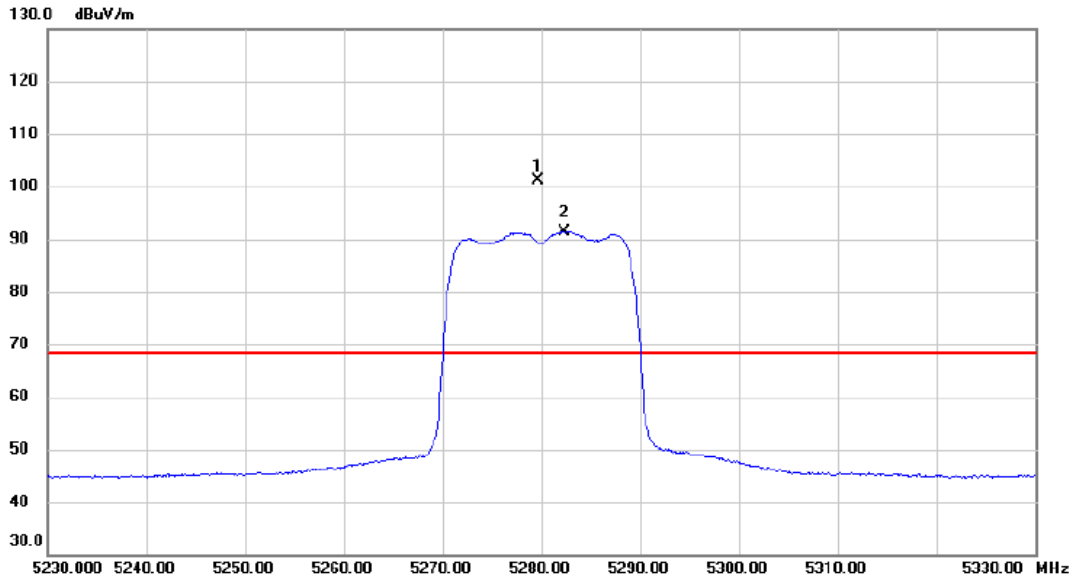

No.	Mk.	Freq. MHz	Reading Level dBuV	Correct Factor dB	Measure- ment dBuV/m	Limit dBuV/m	Margin dB	Detector	Comment
1	*	5279.700	79.73	21.51	101.24	68.30	32.94	peak	No Limit
2	X	5282.300	69.95	21.51	91.46	68.30	23.16	AVG	No Limit

Orthogonal Axis :	X
Test Mode :	UNII-2A/ TX N20 Mode 5280MHz

Vertical

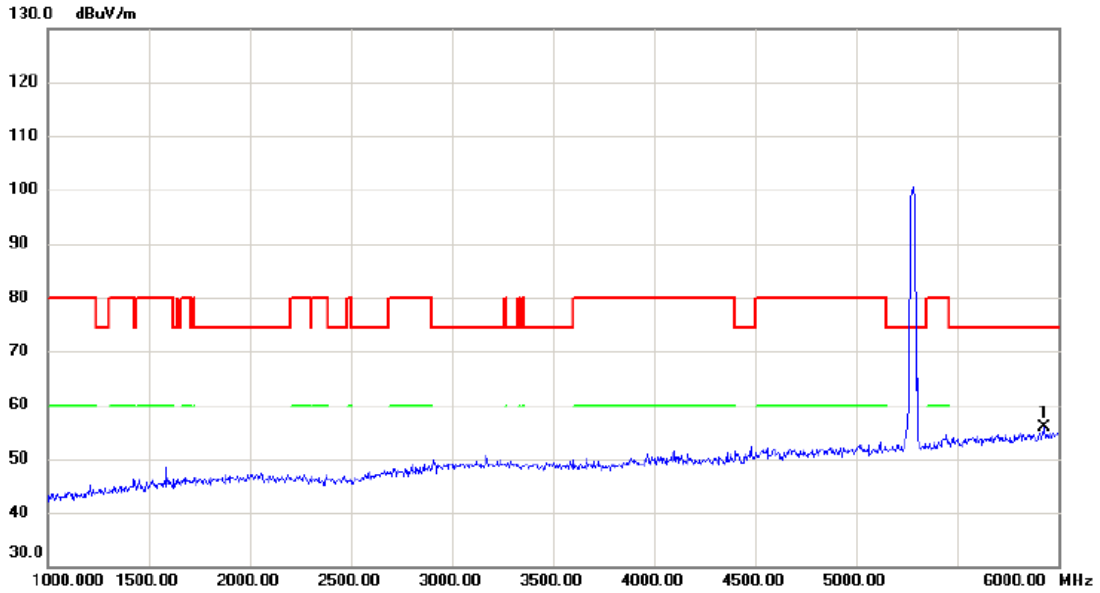

No.	Mk.	Freq.	Reading Level	Correct Factor	Measurement	Limit	Margin	Detector	Comment
		MHz	dBuV	dB	dBuV/m	dBuV/m	dB		
1	*	5930.000	31.88	24.00	55.88	74.30	-18.42	peak	

Orthogonal Axis :	X
Test Mode :	UNII-2A/ TX N20 Mode 5280MHz

Vertical

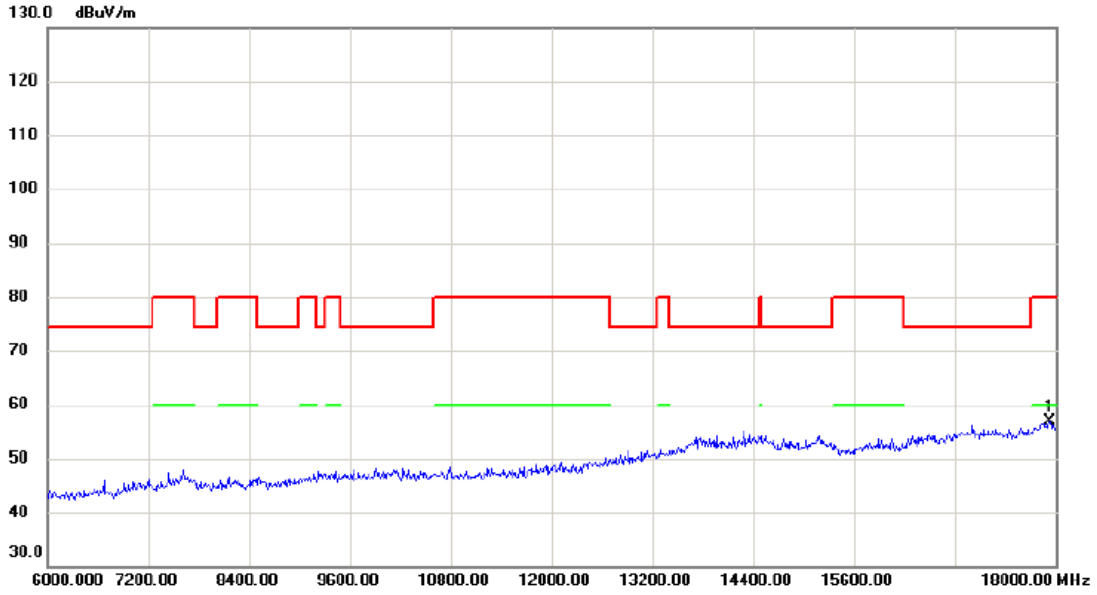

No.	Mk.	Freq. MHz	Reading Level dBuV	Correct Factor dB	Measure- ment dBuV/m	Limit dBuV/m	Margin dB	Detector	Comment
1	*	17928.00	28.01	28.93	56.94	80.00	-23.06	peak	

Orthogonal Axis :	X
Test Mode :	UNII-2A/ TX N20 Mode 5280MHz

Vertical

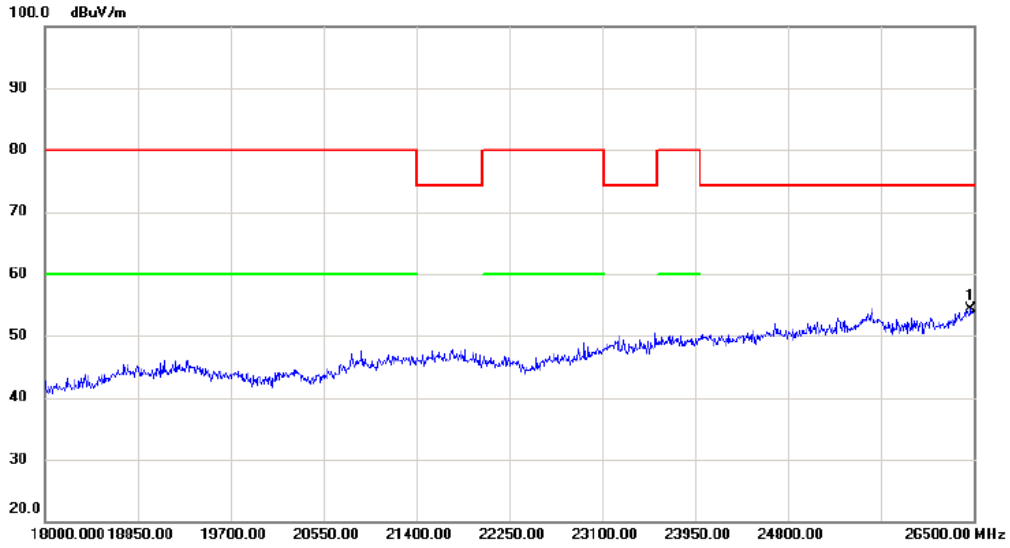

No.	Mk.	Freq.	Reading Level	Correct Factor	Measurement	Limit	Margin	Detector	Comment
		MHz	dBuV	dB	dBuV/m	dBuV/m	dB		
1	*	26474.50	28.34	25.99	54.33	74.30	-19.97	peak	

Orthogonal Axis :	X
Test Mode :	UNII-2A/ TX N20 Mode 5280MHz

Vertical

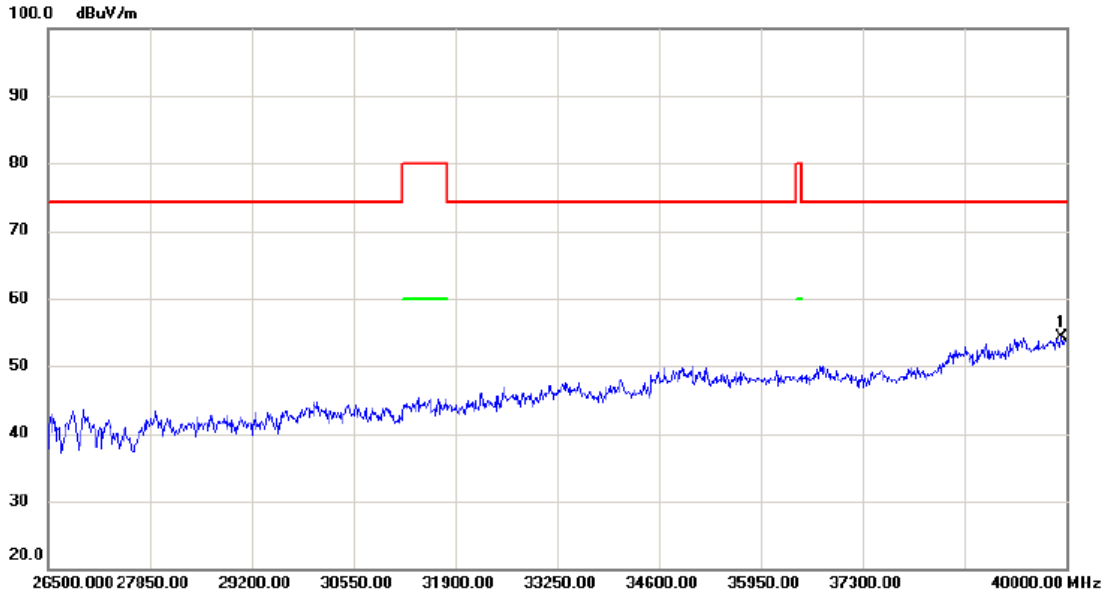

No.	Mk.	Freq. MHz	Reading Level dBuV	Correct Factor dB	Measure- ment dBuV/m	Limit dBuV/m	Margin dB	Detector	Comment
1	*	39932.50	38.44	15.78	54.22	74.30	-20.08	peak	

Orthogonal Axis :	X
Test Mode :	UNII-2A/ TX N20 Mode 5280MHz

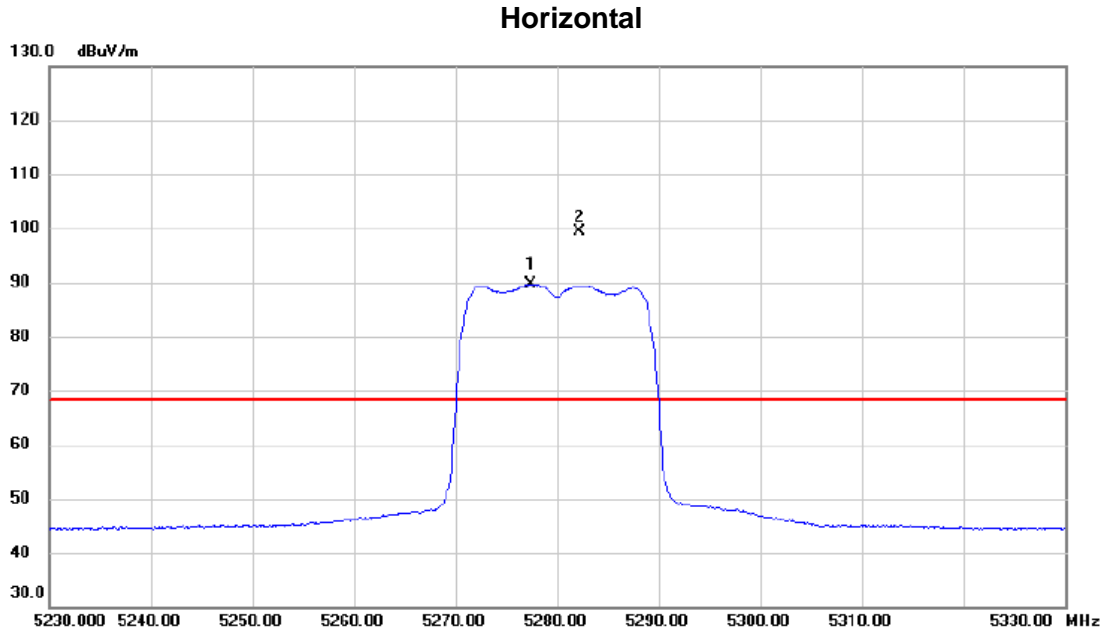

No.	Mk.	Freq. MHz	Reading Level dBuV	Correct Factor dB	Measure- ment dBuV/m	Limit dBuV/m	Margin dB	Detector	Comment
1	X	5277.400	68.22	21.49	89.71	68.30	21.41	AVG	No Limit
2	*	5282.200	77.83	21.51	99.34	68.30	31.04	peak	No Limit

Orthogonal Axis :	X
Test Mode :	UNII-2A/ TX N20 Mode 5280MHz

Horizontal

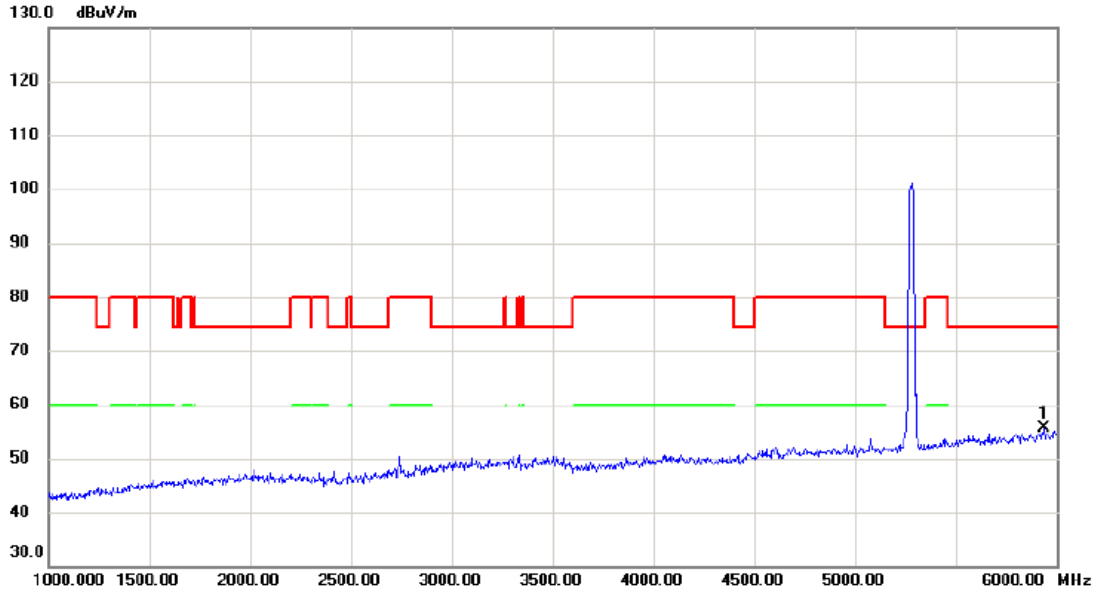

No.	Mk.	Freq.	Reading Level	Correct Factor	Measurement	Limit	Margin	Detector	Comment
		MHz	dBuV	dB	dBuV/m	dBuV/m	dB		
1	*	5935.000	31.49	24.03	55.52	74.30	-18.78	peak	

Orthogonal Axis :	X
Test Mode :	UNII-2A/ TX N20 Mode 5280MHz

Horizontal

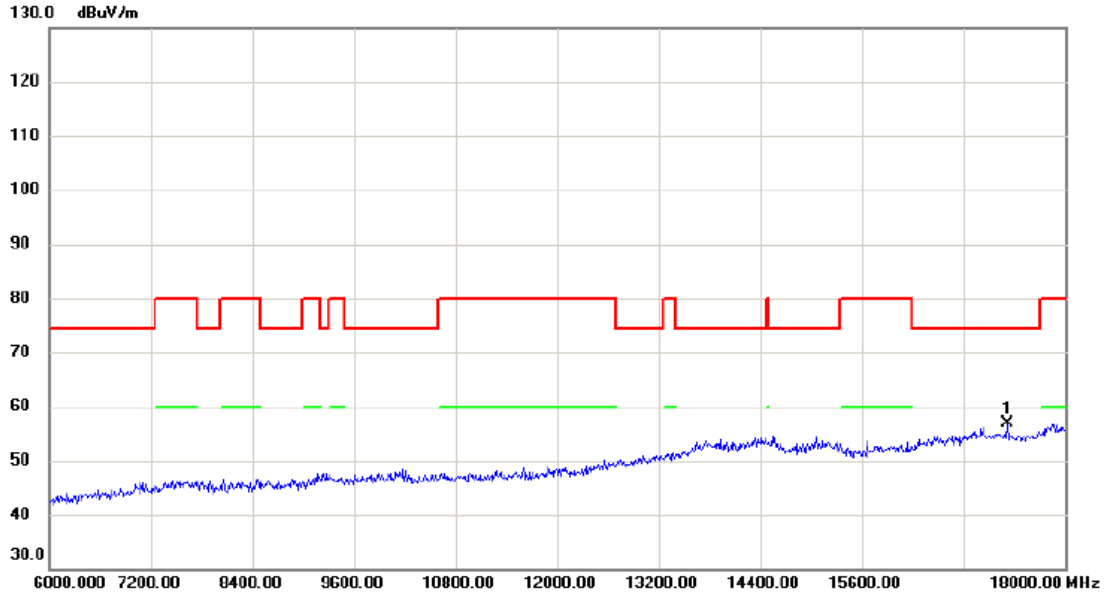

No.	Mk.	Freq. MHz	Reading Level dBuV	Correct Factor dB	Measure- ment dBuV/m	Limit dBuV/m	Margin dB	Detector	Comment
1	*	17316.00	29.41	27.35	56.76	74.30	-17.54	peak	

Orthogonal Axis :	X
Test Mode :	UNII-2A/ TX N20 Mode 5280MHz

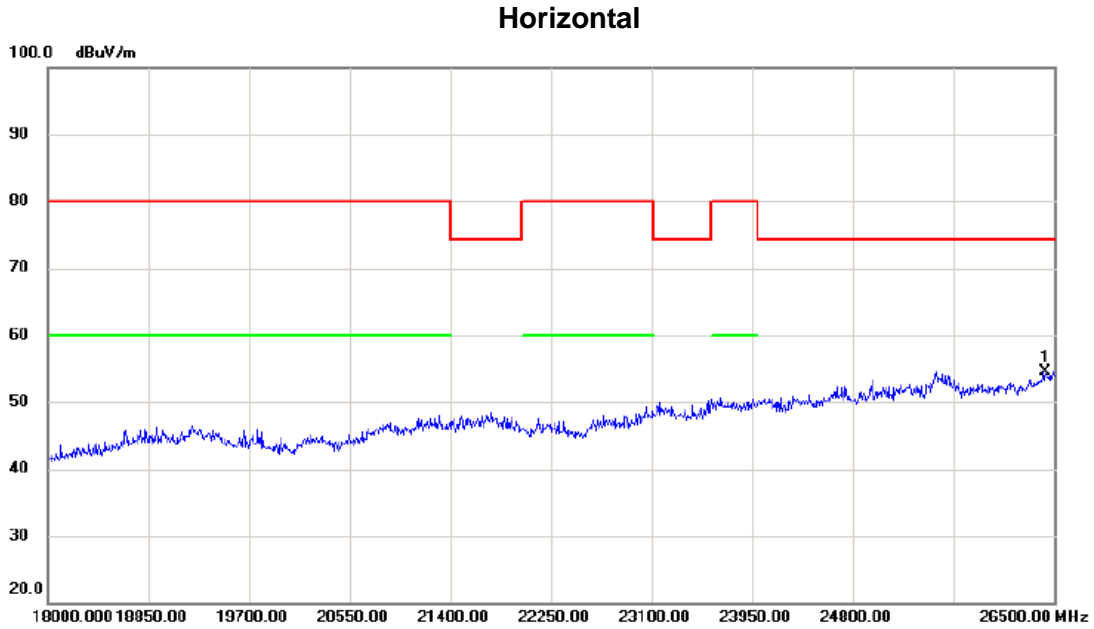

No.	Mk.	Freq. MHz	Reading Level dBuV	Correct Factor dB	Measure- ment dBuV/m	Limit dBuV/m	Margin dB	Detector	Comment
1	*	26423.50	28.87	25.72	54.59	74.30	-19.71	peak	

Orthogonal Axis :	X
Test Mode :	UNII-2A/ TX N20 Mode 5280MHz

Horizontal

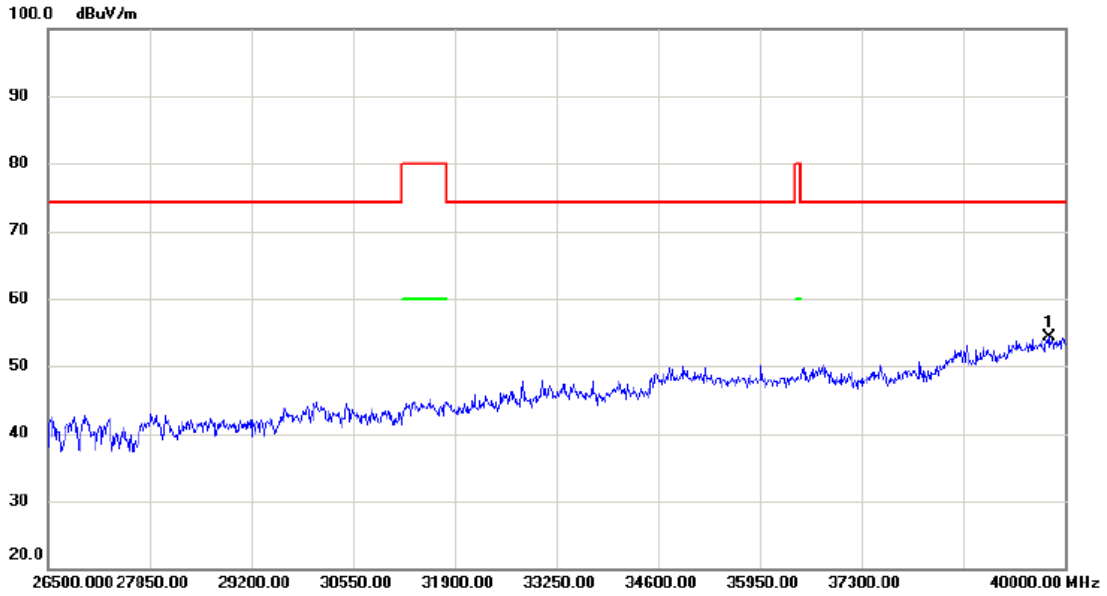

No.	Mk.	Freq.	Reading Level	Correct Factor	Measurement	Limit	Margin	Detector	Comment
		MHz	dBuV	dB	dBuV/m	dBuV/m	dB		
1	*	39784.00	38.85	15.54	54.39	74.30	-19.91	peak	

Orthogonal Axis :	X
Test Mode :	UNII-2A/ TX N20 Mode 5320MHz

Vertical

130 dBuV/m

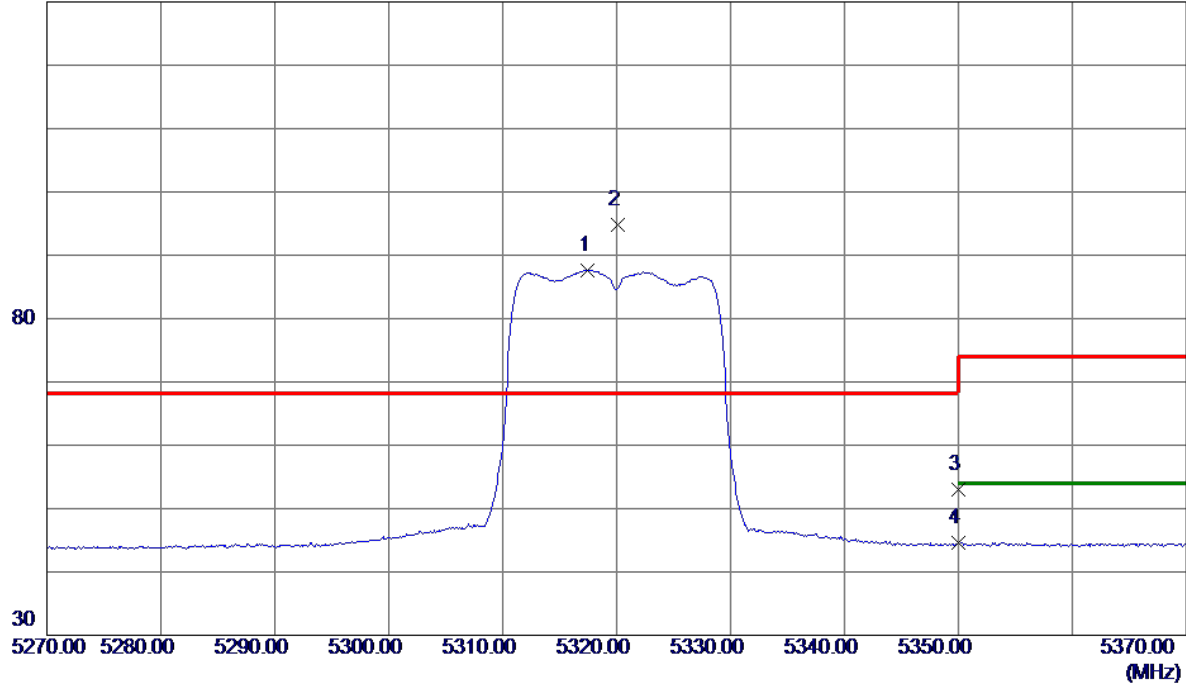

No.	Freq. MHz	Reading Level dBuV/m	Correct Factor dB	Measure ment dBuV/m	Limit dBuV/m	Margin dB	Detector	Comment
1	5317.5000	65.99	21.64	87.63	999.00	-911.37	AVG	No Limit
2 *	5320.1000	73.17	21.65	94.82	68.30	26.52	Peak	No Limit
3	5350.0000	31.30	21.76	53.06	74.00	-20.94	Peak	
4	5350.0000	22.79	21.76	44.55	999.00	-954.45	AVG	

Orthogonal Axis :	X
Test Mode :	UNII-2A/ TX N20 Mode 5320MHz

Vertical

130 dBuV/m

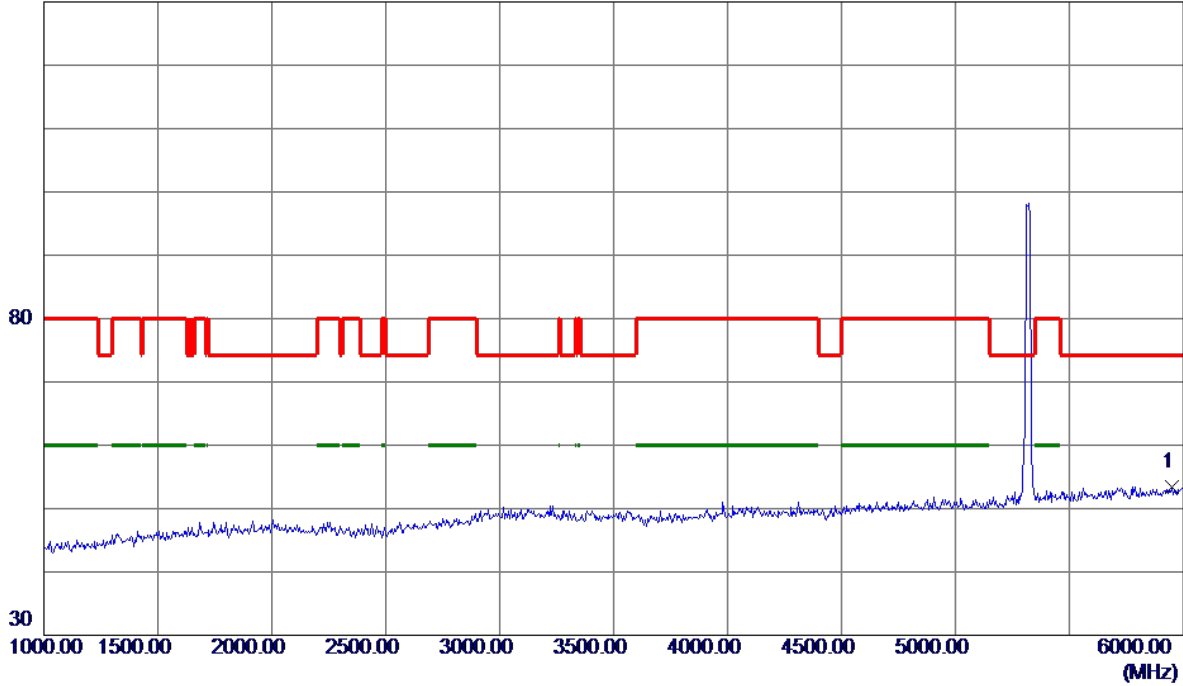

No.	Freq. MHz	Reading Level dBuV/m	Correct Factor dB	Measure ment dBuV/m	Limit dBuV/m	Margin dB	Detector	Comment
1 *	5950.0000	34.15	19.23	53.38	74.30	-20.92	Peak	

Orthogonal Axis :	X
Test Mode :	UNII-2A/ TX N20 Mode 5320MHz

Vertical

130 dBuV/m

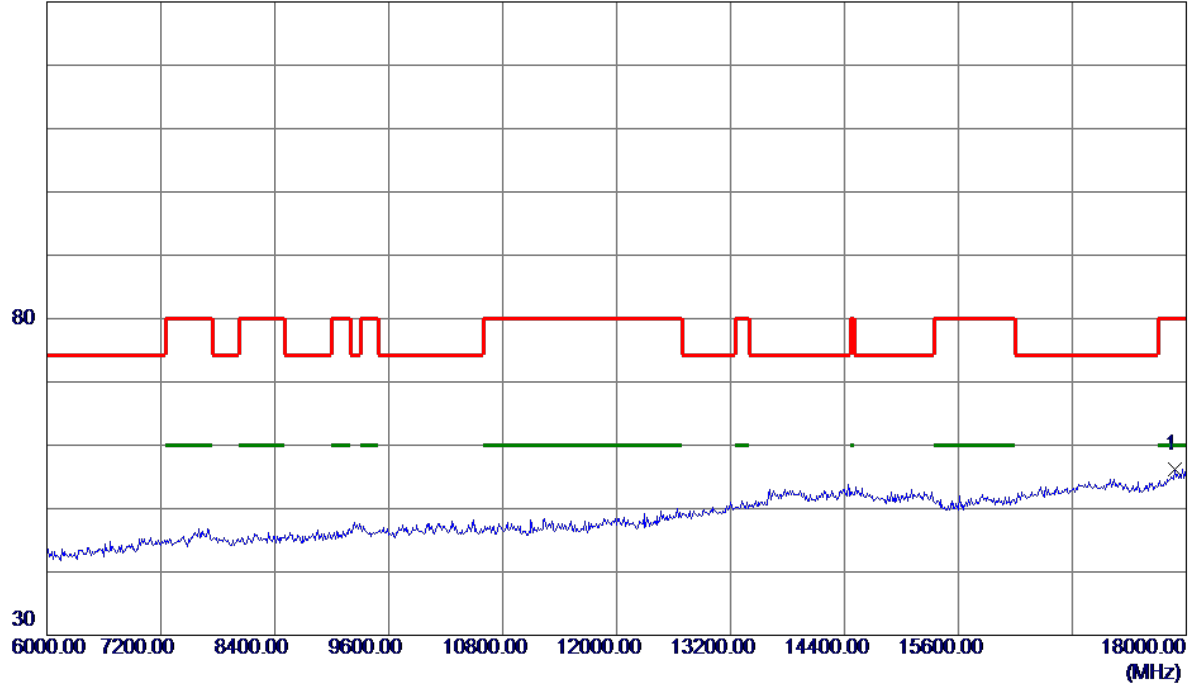

No.	Freq. MHz	Reading Level dBuV/m	Correct Factor dB	Measure ment dBuV/m	Limit dBuV/m	Margin dB	Detector	Comment
1 *	17880.0000	27.39	28.77	56.16	80.00	-23.84	Peak	

Orthogonal Axis :	X
Test Mode :	UNII-2A/ TX N20 Mode 5320MHz

Vertical

100 dBuV/m

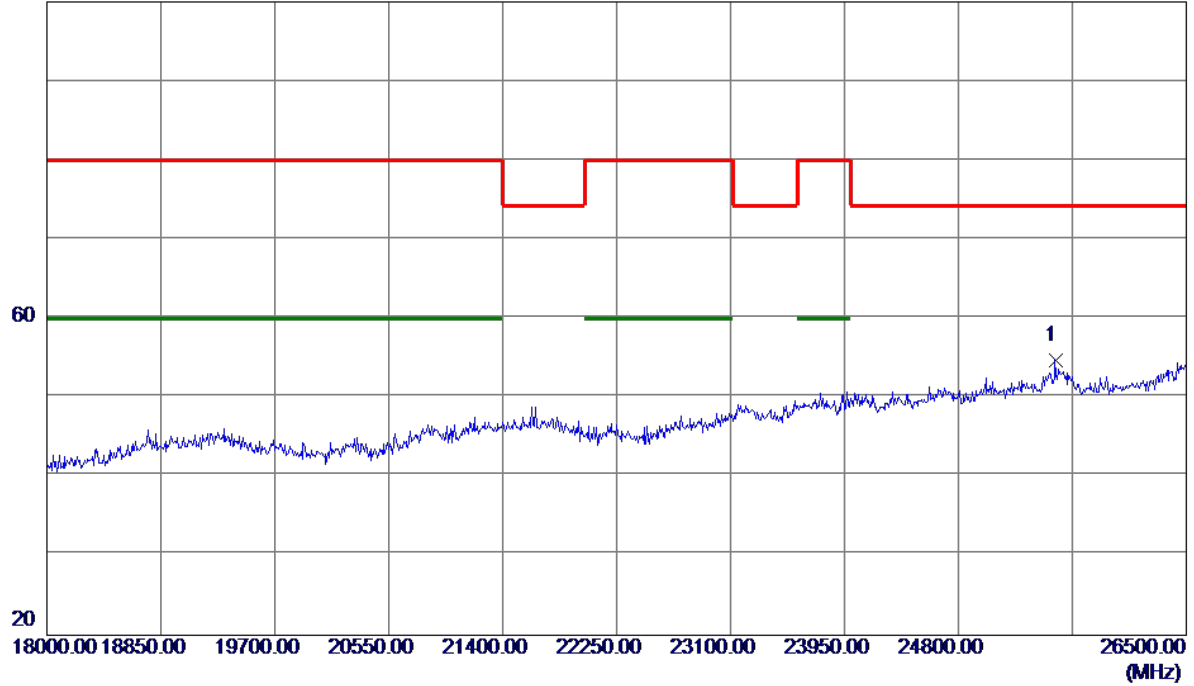

No.	Freq. MHz	Reading Level dBuV/m	Correct Factor dB	Measure ment dBuV/m	Limit dBuV/m	Margin dB	Detector	Comment
1 *	25522.5000	30.74	23.94	54.68	74.30	-19.62	Peak	