

# FCC Radio Test Report

## FCC ID: YBN-AIVIL42P0

This report concerns (check one): Original Grant Class I Change Class II Change

**Project No.** : 1807C078  
**Equipment** : Car Radio with navigation, BT and WLAN  
**Test Model** : AIVIL42P0  
**Series Model** : N/A  
**Applicant** : Bosch Car Multimedia GmbH  
**Address** : Robert-Bosch-Straße 200; 31139 Hildesheim

**Date of Receipt** : Jul. 11, 2018  
**Date of Test** : Jul. 11, 2018 ~ Jul. 17, 2018  
**Issued Date** : Jul. 25, 2018  
**Tested by** : BTL Inc.

**Testing Engineer** : Chay Cai  
(Chay Cai)

**Technical Manager** : David Mao  
(David Mao)

**Authorized Signatory** : Steven Lu  
(Steven Lu)

# **B T L I N C .**

No.3, Jinshagang 1st Road, Shixia, Dalang Town, Dongguan,  
Guangdong, China.

TEL: +86-769-8318-3000 FAX: +86-769-8319-6000



### **Declaration**

**BTL** represents to the client that testing is done in accordance with standard procedures as applicable and that test instruments used has been calibrated with standards traceable to international standard(s) and/or national standard(s).

**BTL's** reports apply only to the specific samples tested under conditions. It is manufacture's responsibility to ensure that additional production units of this model are manufactured with the identical electrical and mechanical components. **BTL** shall have no liability for any declarations, inferences or generalizations drawn by the client or others from **BTL** issued reports.

The report must not be used by the client to claim product certification, approval, or endorsement by NVLAP, NIST, or any agency of the U.S. Government.

This report is the confidential property of the client. As a mutual protection to the clients, the public and ourselves, the test report shall not be reproduced, except in full, without our written approval.

**BTL's** laboratory quality assurance procedures are in compliance with the **ISO Guide 17025** requirements, and accredited by the conformity assessment authorities listed in this test report.

**BTL** is not responsible for the sampling stage, so the results only apply to the sample as received.

The information, data and test plan are provided by manufacturer, so it is manufacturer's responsibility to ensure that the apparatus meets the essential requirements in all the possible configurations as representative of its intended use.

### **Limitation**

For the use of the authority's logo is limited unless the Test Standard(s)/Scope(s)/Item(s) mentioned in this test report is (are) included in the conformity assessment authorities acceptance respective.

**Table of Contents****Page**

<b>1 . CERTIFICATION</b>	<b>7</b>
<b>2 . SUMMARY OF TEST RESULTS</b>	<b>8</b>
2.1 TEST FACILITY	9
2.2 MEASUREMENT UNCERTAINTY	9
<b>3 . GENERAL INFORMATION</b>	<b>10</b>
3.1 GENERAL DESCRIPTION OF EUT	10
3.2 DESCRIPTION OF TEST MODES	12
3.3 TABLE OF PARAMETERS OF TEXT SOFTWARE SETTING	12
3.4 BLOCK DIAGRAM SHOWING THE CONFIGURATION OF SYSTEM TESTED	13
3.5 DESCRIPTION OF SUPPORT UNITS	13
<b>4 . EMC EMISSION TEST</b>	<b>14</b>
4.1 RADIATED EMISSION MEASUREMENT	14
4.1.1 RADIATED EMISSION LIMITS	14
4.1.2 TEST PROCEDURE	15
4.1.3 DEVIATION FROM TEST STANDARD	15
4.1.4 TEST SETUP	16
4.1.5 EUT OPERATING CONDITIONS	18
4.1.6 EUT TEST CONDITIONS	18
4.1.7 TEST RESULTS (9KHZ TO 30MHZ)	18
4.1.8 TEST RESULTS (30MHZ TO 1000MHZ)	18
4.1.9 TEST RESULTS (ABOVE 1000MHZ)	18
<b>5 . NUMBER OF HOPPING CHANNEL</b>	<b>19</b>
5.1 APPLIED PROCEDURES	19
5.1.1 TEST PROCEDURE	19
5.1.2 DEVIATION FROM STANDARD	19
5.1.3 TEST SETUP	19
5.1.4 EUT OPERATION CONDITIONS	19
5.1.5 EUT TEST CONDITIONS	19
5.1.6 TEST RESULTS	19
<b>6 . AVERAGE TIME OF OCCUPANCY</b>	<b>20</b>
6.1 APPLIED PROCEDURES / LIMIT	20
6.1.1 TEST PROCEDURE	20
6.1.2 DEVIATION FROM STANDARD	20
6.1.3 TEST SETUP	20
6.1.4 EUT OPERATION CONDITIONS	21
6.1.5 EUT TEST CONDITIONS	21
6.1.6 TEST RESULTS	21

<b>Table of Contents</b>	<b>Page</b>
<b>7 . HOPPING CHANNEL SEPARATION MEASUREMENT</b>	<b>22</b>
<b>7.1 APPLIED PROCEDURES / LIMIT</b>	<b>22</b>
7.1.1 TEST PROCEDURE	22
7.1.2 DEVIATION FROM STANDARD	22
7.1.3 TEST SETUP	22
7.1.4 EUT TEST CONDITIONS	22
7.1.5 TEST RESULTS	22
<b>8 . BANDWIDTH TEST</b>	<b>23</b>
<b>8.1 APPLIED PROCEDURES</b>	<b>23</b>
8.1.1 TEST PROCEDURE	23
8.1.2 DEVIATION FROM STANDARD	23
8.1.3 TEST SETUP	23
8.1.4 EUT OPERATION CONDITIONS	23
8.1.5 EUT TEST CONDITIONS	23
8.1.6 TEST RESULTS	23
<b>9 . PEAK OUTPUT POWER TEST</b>	<b>24</b>
<b>9.1 APPLIED PROCEDURES / LIMIT</b>	<b>24</b>
9.1.1 TEST PROCEDURE	24
9.1.2 DEVIATION FROM STANDARD	24
9.1.3 TEST SETUP	24
9.1.4 EUT OPERATION CONDITIONS	24
9.1.5 EUT TEST CONDITIONS	24
9.1.6 TEST RESULTS	24
<b>10 . ANTENNA CONDUCTED SPURIOUS EMISSION</b>	<b>25</b>
<b>10.1 APPLIED PROCEDURES / LIMIT</b>	<b>25</b>
10.1.1 TEST PROCEDURE	25
10.1.2 DEVIATION FROM STANDARD	25
10.1.3 TEST SETUP	25
10.1.4 EUT OPERATION CONDITIONS	25
10.1.5 EUT TEST CONDITIONS	25
10.1.6 TEST RESULTS	25
<b>11 . MEASUREMENT INSTRUMENTS LIST</b>	<b>26</b>
<b>12 . EUT TEST PHOTO</b>	<b>28</b>
<b>APPENDIX A - RADIATED EMISSION (9KHZ-30MHZ)</b>	<b>33</b>
<b>APPENDIX B - RADIATED EMISSION (30MHZ TO 1000MHZ)</b>	<b>38</b>
<b>APPENDIX C - RADIATED EMISSION (ABOVE 1000MHZ)</b>	<b>45</b>
<b>APPENDIX D - NUMBER OF HOPPING CHANNEL</b>	<b>94</b>

**Table of Contents**

**Page**

<b>APPENDIX E - AVERAGE TIME OF OCCUPANCY</b>	<b>96</b>
<b>APPENDIX F - HOPPING CHANNEL SEPARATION MEASUREMENT</b>	<b>109</b>
<b>APPENDIX G - BANDWIDTH</b>	<b>114</b>
<b>APPENDIX H - PEAK OUTPUT POWER</b>	<b>119</b>
<b>APPENDIX I - ANTENNA CONDUCTED SPURIOUS EMISSION</b>	<b>126</b>

### REPORT ISSUED HISTORY

Issued No.	Description	Issued Date
BTL-FCCP-1-1807C078	Original Issue.	Jul. 25, 2018

## 1. CERTIFICATION

Equipment : Car Radio with navigation, BT and WLAN  
Brand Name : Bosch  
Test Model : AIVIL42P0  
Series Model : N/A  
Applicant : Bosch Car Multimedia GmbH  
Manufacturer : #1 Bosch Car Multimedia GmbH  
                  #2 Bosch Car Multimedia Portugal, S.A.  
Address : #1 Robert-Bosch-Straße 200; 31139 Hildesheim  
              #2 Rua Max Grundig, 35-Lomar, 4705-820 Braga  
Factory : Robert Bosch (Malaysia)  
Address : Free Trade Zone 11900, Bayan Lepas, Penang  
Date of Test : Jul. 11, 2018 ~ Jul. 17, 2018  
Test Sample : Engineering Sample No.: D180705792 for conducted, D180705794 for  
                  radiated  
Standard(s) : FCC Part15, Subpart C (15.247)/ ANSI C63.10-2013

The above equipment has been tested and found compliance with the requirement of the relative standards by BTL Inc.

The test data, data evaluation, and equipment configuration contained in our test report (Ref No. BTL-FCCP-1-1807C078) were obtained utilizing the test procedures, test instruments, test sites that has been accredited by the Authority of NVLAP according to the ISO-17025 quality assessment standard and technical standard(s).

**Test results included in this report is only for the Bluetooth EDR part.**

## 2. SUMMARY OF TEST RESULTS

Test procedures according to the technical standard(s):

<b>Applied Standard(s): FCC Part15, Subpart C (15.247)</b>			
Standard(s) Section	Test Item	Judgment	Remark
15.247(d)	Antenna conducted Spurious Emission	PASS	
15.247(a)(1)	Hopping Channel Separation	PASS	
15.247(a)(2)	Bandwidth	PASS	
15.247(a)(1)	Peak Output Power	PASS	
15.247(d) 15.209	Radiated Spurious Emission	PASS	
15.247(a)(1)(iii)	Number of Hopping Frequency	PASS	
15.247(a)(1)(iii)	Dwell Time	PASS	
15.205	Restricted Bands	PASS	
15.203	Antenna Requirement	PASS	

Note:

(1) "N/A" denotes test is not applicable in this test report



## 2.1 TEST FACILITY

The test facilities used to collect the test data in this report is at the location of No.3, Jinshagang 1st Road, Shixia, Dalang Town, Dongguan, Guangdong, China.

BTL's test firm number for FCC: 854385

BTL's designation number for FCC: CN5020

## 2.2 MEASUREMENT UNCERTAINTY

The measurement uncertainty figures shall be calculated according the methods described in the ETSI TR 100 028 and shall correspond to an expansion factor (coverage factor)  $k=1.96$  or  $k=2$ (which provide confidence levels of respectively 90% and 95.45% in the case where the distributions characterizing the actual measurement uncertainties are normal (Gaussian)). Measurement Uncertainty for a Level of Confidence of 95 %,  $U=2xUc(y)$ .

The BTL measurement uncertainty as below table:

### A. Radiated Measurement :

Test Site	Method	Measurement Frequency Range	Ant. H / V	U, (dB)
DG-CB03	CISPR	9KHz~30MHz	V	3.79
		9KHz~30MHz	H	3.57
		30MHz ~ 200MHz	V	3.82
		30MHz ~ 200MHz	H	3.78
		200MHz ~ 1,000MHz	V	4.10
		200MHz ~ 1,000MHz	H	4.06
		1GHz~18GHz	V	3.12
		1GHz~18GHz	H	3.68
		18GHz~40GHz	V	4.15
		18GHz~40GHz	H	4.14

### B. Other Measurement:

Test Item	Uncertainty
Conducted Spurious Emission	2.67dB
Hopping Channel Separation	53.46MHz
Peak Output Power	0.95dB
Number of Hopping Frequency	53.46MHz
Temperature	0.08°C
Humidity	1.5%

Note: Unless specifically mentioned, the uncertainty of measurement has not been taken into account to declare the compliance or non-compliance to the specification.

### 3. GENERAL INFORMATION

#### 3.1 GENERAL DESCRIPTION OF EUT

Equipment	Car Radio with navigation, BT and WLAN	
Brand Name	Bosch	
Test Model	AIVIL42P0	
Series Model	N/A	
Model Difference	N/A	
Output Power (Max.)	Operation Frequency	2402 ~ 2480 MHz
	Modulation Technology	GFSK(1Mbps) $\pi$ /4-DQPSK(2Mbps)
	Bit Rate of Transmitter	8-DPSK(3Mbps)
	Output Power Max.	-4.17 dBm (1Mbps) -4.35 dBm (2Mbps) -3.81 dBm (3Mbps)
Power Source	DC voltage supplied from external power supply.	
Power Rating	DC 13.5V	

Note:

1. For a more detailed features description, please refer to the manufacturer's specifications or the user's manual.

2. Channel List:

Channel	Frequency (MHz)	Channel	Frequency (MHz)	Channel	Frequency (MHz)
00	2402	27	2429	54	2456
01	2403	28	2430	55	2457
02	2404	29	2431	56	2458
03	2405	30	2432	57	2459
04	2406	31	2433	58	2460
05	2407	32	2434	59	2461
06	2408	33	2435	60	2462
07	2409	34	2436	61	2463
08	2410	35	2437	62	2464
09	2411	36	2438	63	2465
10	2412	37	2439	64	2466
11	2413	38	2440	65	2467
12	2414	39	2441	66	2468
13	2415	40	2442	67	2469
14	2416	41	2443	68	2470
15	2417	42	2444	69	2471
16	2418	43	2445	70	2472
17	2419	44	2446	71	2473
18	2420	45	2447	72	2474
19	2421	46	2448	73	2475
20	2422	47	2449	74	2476
21	2423	48	2450	75	2477
22	2424	49	2451	76	2478
23	2425	50	2452	77	2479
24	2426	51	2453	78	2480
25	2427	52	2454		
26	2428	53	2455		

3 Table for Filed Antenna:

Ant.	Brand	Model Name	Antenna Type	Connector	Gain (dBi)
1	N/A	N/A	Internal	N/A	4.13

### 3.2 DESCRIPTION OF TEST MODES

To investigate the maximum EMI emission characteristics generates from EUT, the test system was pre-scanning tested base on the consideration of following EUT operation mode or test configuration mode which possible have effect on EMI emission level. Each of these EUT operation mode(s) or test configuration mode(s) mentioned above was evaluated respectively.

Pretest Mode	Description
Mode 1	TX Mode <b>Note (1)</b>

The EUT system operated these modes were found to be the worst case during the pre-scanning test as following:

For Conducted Emission	
Final Test Mode	Description
Mode 1	TX Mode

For Radiated Emission	
Final Test Mode	Description
Mode 1	TX Mode <b>Note (1)</b>

**Note:**

- (1) The measurements are performed at the high, middle, low available channels.
- (2) The measurements for Hopping Channel Separation, Bandwidth and Peak Output Power were tested during 1Mbps, 2Mbps and 3Mbps, the worst case are 1Mbps and 3Mbps, only worst case was documented.

### 3.3 TABLE OF PARAMETERS OF TEXT SOFTWARE SETTING

During testing, channel & power controlling software provided by the customer was used to control the operating channel as well as the output power level. The RF output power selection is for the setting of RF output power expected by the customer and is going to be fixed on the firmware of the final end product power parameters of FHSS

Test Software Version	DutApi_w8887_BrdigeEth		
	2402 MHz	2441 MHz	2480 MHz
Frequency			
Parameters(1Mbps)	0	0	0
Parameters(2Mbps)	0	0	0
Parameters(3Mbps)	0	0	0

### 3.4 BLOCK DIAGRAM SHOWING THE CONFIGURATION OF SYSTEM TESTED

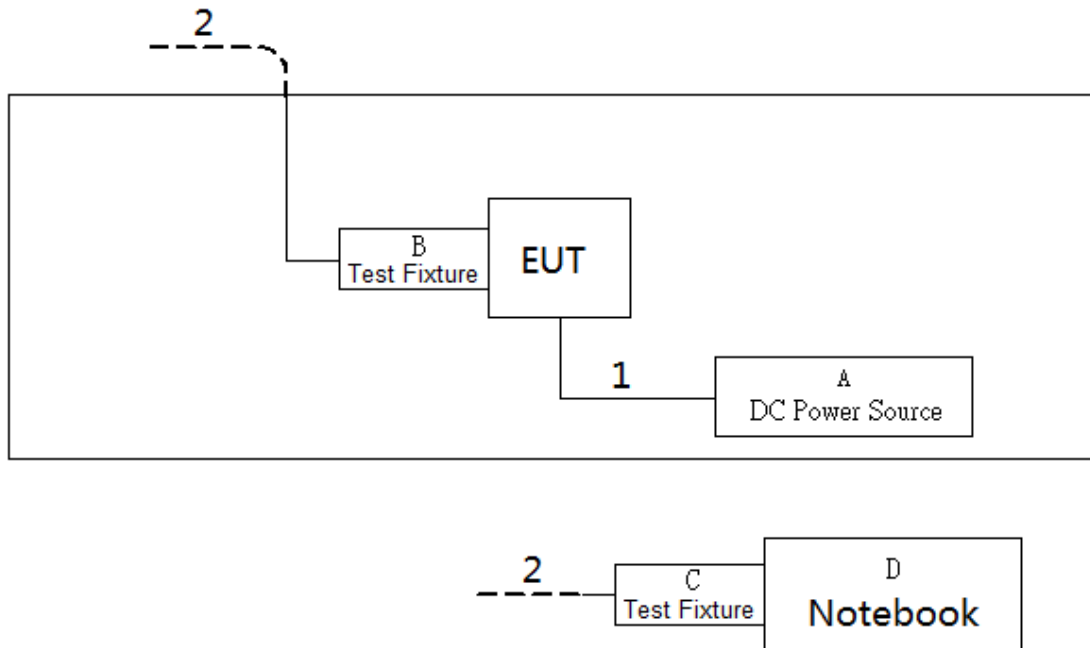

### 3.5 DESCRIPTION OF SUPPORT UNITS

The EUT has been tested as an independent unit together with other necessary accessories or support units. The following support units or accessories were used to form a representative test configuration during the tests.

Item	Equipment	Mfr/Brand	Model/Type No.	FCC ID	Series No.
A	DC Power Source	TRUE-POWER	GPC30300N	N/A	N/A
B	Test Fixture	N/A	N/A	N/A	N/A
C	Test Fixture	N/A	N/A	N/A	N/A
D	Notebook	DELL	DCSM	DOC	G7K832X

Item	Shielded Type	Ferrite Core	Length	Note
1	NO	NO	1m	DC Cable
2	NO	NO	10m	RJ45 Cable

## 4. EMC EMISSION TEST

### 4.1 RADIATED EMISSION MEASUREMENT

#### 4.1.1 RADIATED EMISSION LIMITS

In case the emission fall within the restricted band specified on 15.205(a), then the 15.209(a) limit in the table below has to be followed.

#### LIMITS OF RADIATED EMISSION MEASUREMENT(9KHz-1000MHz)

Frequency (MHz)	Field Strength (microvolts/meter)	Measurement Distance (meters)
0.009~0.490	2400/F(KHz)	300
0.490~1.705	24000/F(KHz)	30
1.705~30.0	30	30
30~88	100	3
88~216	150	3
216~960	200	3
960~1000	500	3

#### LIMITS OF RADIATED EMISSION MEASUREMENT (Above 1000MHz)

Frequency (MHz)	Band edge at 3m (dBμV/m)		Harmonic at 1.5m (dBμV/m)	
	Peak	Average	Peak	Average
Above 1000	74	54	80 (Note 5)	60(Note 5)

Notes:

- (1) The limit for radiated test was performed according to FCC PART 15C.
- (2) The tighter limit applies at the band edges.
- (3) Emission level (dBuV/m)=20log Emission level (uV/m).
- (4) The test result calculated as following:  
 Measurement Value = Reading Level + Correct Factor  
 Correct Factor = Antenna Factor + Cable Loss - Amplifier Gain(if use)  
 Margin Level = Measurement Value - Limit Value

(5)

$$FS_{\text{limit}} = FS_{\text{max}} - 20 \log \left( \frac{d_{\text{limit}}}{d_{\text{measure}}} \right)$$

$$20 \log d_{\text{limit}}/d_{\text{measure}} = 20 \log 3/1.5 = 6 \text{dB.}$$

Spectrum Parameter	Setting
Attenuation	Auto
Start Frequency	1000 MHz
Stop Frequency	10th carrier harmonic
RBW / VBW (emission in restricted band)	1 MHz / 1 MHz for Peak, 1 MHz / 10Hz for Average

Spectrum Receiver Parameter	Setting
Attenuation	Auto
Start ~ Stop Frequency	9KHz ~90KHz for PK/AVG detector
Start ~ Stop Frequency	90KHz ~110KHz for QP detector
Start ~ Stop Frequency	110KHz ~490KHz for PK/AVG detector
Start ~ Stop Frequency	490KHz ~30MHz for QP detector
Start ~ Stop Frequency	30MHz~1000MHz for QP detector

#### 4.1.2 TEST PROCEDURE

- a. The measuring distance of 3 m shall be used for measurements. The EUT was placed on the top of a rotating table 0.8 meter above the ground at a 3 meter semi-anechoic chamber. The table was rotated 360 degrees to determine the position of the highest radiation.(below 1GHz)
- b. The measuring distance of 3 m or 1.5m shall be used for measurements. The EUT was placed on the top of a rotating table 1.5 meter above the ground at a 3 meter semi-anechoic chamber. The table was rotated 360 degrees to determine the position of the highest radiation.(above 1GHz)
- c. The height of the equipment or of the substitution antenna shall be 0.8m or 1.5m; the height of the test antenna shall vary between 1 m to 4 m. Both horizontal and vertical polarizations of the antenna are set to make the measurement.
- d. For each suspected emission, the EUT was arranged to its worst case and then the antenna was tuned to heights find the maximum reading (used Bore sight function).
- e. The receiver system was set to peak and average detect function and specified bandwidth with maximum hold mode when the test frequency is above 1GHz.
- f. The initial step in collecting radiated emission data is a receiver peak detector mode pre-scanning the measurement frequency range. Significant peaks are then marked and then Quasi Peak detector mode re-measured.
- g. All readings are Peak unless otherwise stated QP in column of Note. Peak denotes that the Peak reading compliance with the QP Limits and then QP Mode measurement didn't perform. (below 1GHz)
- h. All readings are Peak Mode value unless otherwise stated AVG in column of Note. If the Peak Mode Measured value compliance with the Peak Limits and lower than AVG Limits, the EUT shall be deemed to meet both Peak & AVG Limits and then only Peak Mode was measured, but AVG Mode didn't perform. (above 1GHz)
- i. For the actual test configuration, please refer to the related Item –EUT Test Photos.

#### 4.1.3 DEVIATION FROM TEST STANDARD

No deviation

#### 4.1.4 TEST SETUP

(A) Radiated Emission Test Set-Up Frequency Below 1 GHz

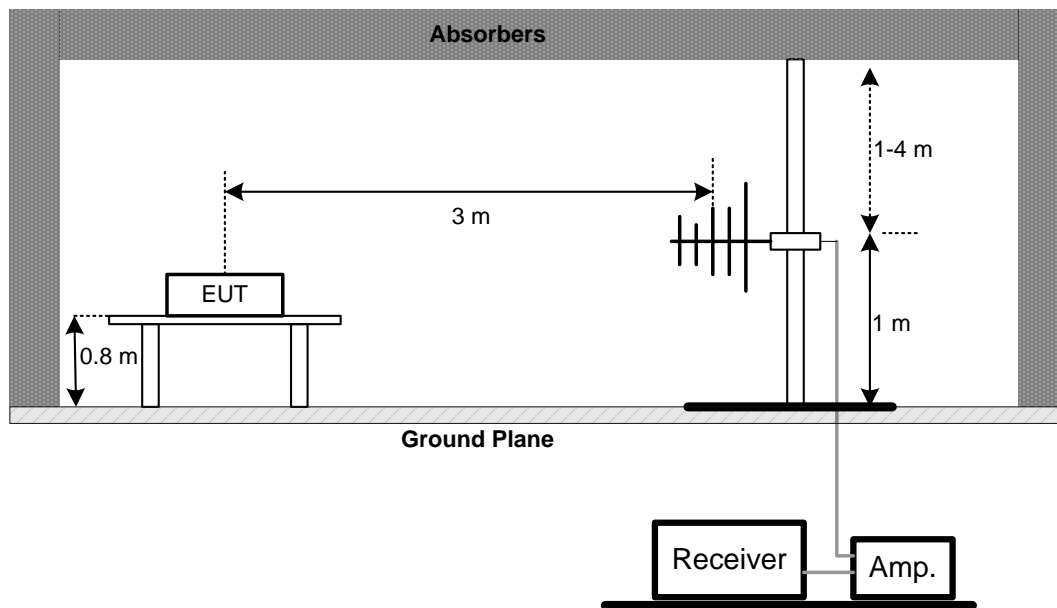



(B) Radiated Emission Test Set-Up Frequency Above 1 GHz  
Band edge

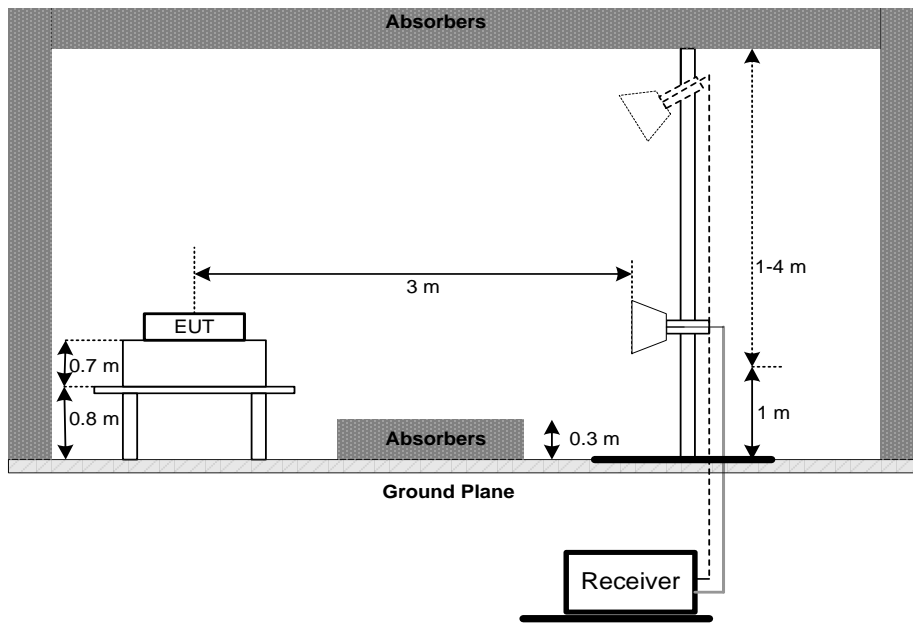

Harmonic

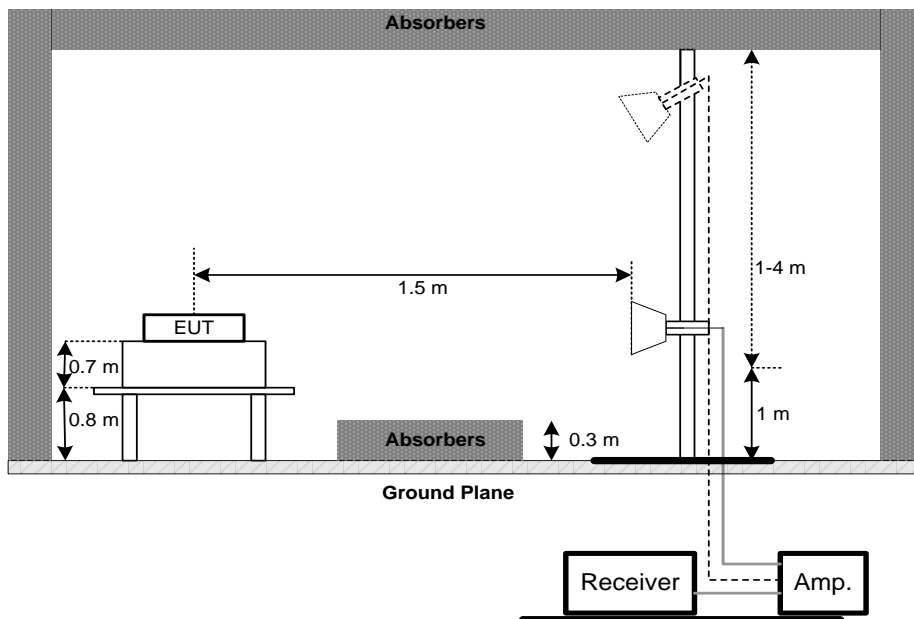

(C) For Radiated Emissions Below 30MHz

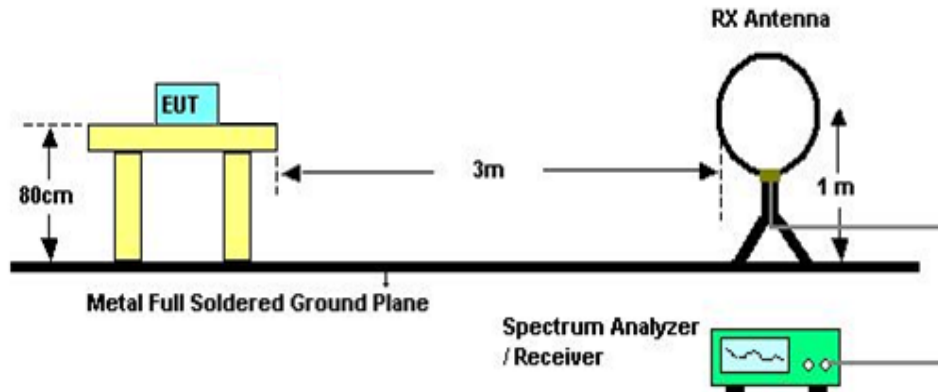

#### 4.1.5 EUT OPERATING CONDITIONS

The EUT was programmed to be in continuously transmitting mode.

#### 4.1.6 EUT TEST CONDITIONS

Temperature: 25°C  
 Relative Humidity: 55%  
 Test Voltage: DC 13.5V

#### 4.1.7 TEST RESULTS (9KHZ TO 30MHZ)

Please refer to the Appendix A.

Remark:

- (1) The amplitude of spurious emissions which are attenuated by more than 20 dB below the permissible value has no need to be reported.
- (2) Distance extrapolation factor =  $40 \log (\text{specific distance} / \text{test distance})$  (dB).
- (3) Limit line = specific limits (dBuV) + distance extrapolation factor.

#### 4.1.8 TEST RESULTS (30MHZ TO 1000MHZ)

Please refer to the Appendix B.

#### 4.1.9 TEST RESULTS (ABOVE 1000MHZ)

Please refer to the Appendix C.

Remark:

- (1) No limit: This is fundamental signal, the judgment is not applicable.  
 For fundamental signal judgment was referred to Peak output test.

## 5. NUMBER OF HOPPING CHANNEL

### 5.1 APPLIED PROCEDURES

FCC Part15 (15.247) , Subpart C			
Section	Test Item	Frequency Range (MHz)	Result
15.247(a)(1)(iii)	Number of Hopping Channel	2400-2483.5	PASS

Spectrum Parameters	Setting
Attenuation	Auto
Span Frequency	> Operating Frequency Range
RBW	100 KHz
VBW	100 KHz
Detector	Peak
Trace	Max Hold
Sweep Time	Auto

#### 5.1.1 TEST PROCEDURE

- a. The EUT was directly connected to the spectrum analyzer and antenna output port as show in the block diagram below,
- b. Spectrum Setting: RBW=100KHz, VBW=100KHz, Sweep time = Auto.

#### 5.1.2 DEVIATION FROM STANDARD

No deviation.

#### 5.1.3 TEST SETUP



#### 5.1.4 EUT OPERATION CONDITIONS

The EUT tested system was configured as the statements of 4.1.5 unless otherwise a special operating condition is specified in the follows during the testing.

#### 5.1.5 EUT TEST CONDITIONS

Temperature: 25°C  
 Relative Humidity: 55%  
 Test Voltage: DC 13.5V

#### 5.1.6 TEST RESULTS

Please refer to the Appendix D.

## 6. AVERAGE TIME OF OCCUPANCY

### 6.1 APPLIED PROCEDURES / LIMIT

FCC Part15 (15.247) , Subpart C				
Section	Test Item	Limit	Frequency Range (MHz)	Result
15.247(a)(1)(iii)	Average Time of Occupancy	0.4sec	2400-2483.5	PASS

#### 6.1.1 TEST PROCEDURE

- a. The transmitter output (antenna port) was connected to the spectrum analyzer
- b. Set RBW of spectrum analyzer to 1MHz and VBW to 1MHz.
- c. Use a video trigger with the trigger level set to enable triggering only on full pulses.
- d. Sweep Time is more than once pulse time.
- e. Set the center frequency on any frequency would be measure and set the frequency span to zero span.
- f. Measure the maximum time duration of one single pulse.
- g. Set the EUT for DH5, DH3 and DH1 packet transmitting.
- h. Measure the maximum time duration of one single pulse.
  - i. DH5 Packet permit maximum  $1600 / 79 / 6 = 3.37$  hops per second in each channel (5 time slots TX, 1 time slot RX). So, the dwell time is the time duration of the pulse times  $3.37 \times 31.6 = 106.6$  within 31.6 seconds.
  - j. DH3 Packet permit maximum  $1600 / 79 / 4 = 5.06$  hops per second in each channel (3 time slots TX, 1 time slot RX). So, the dwell time is the time duration of the pulse times  $5.06 \times 31.6 = 160$  within 31.6 seconds.
  - k. DH1 Packet permit maximum  $1600 / 79 / 2 = 10.12$  hops per second in each channel (1 time slot TX, 1 time slot RX). So, the dwell time is the time duration of the pulse times  $10.12 \times 31.6 = 320$  within 31.6 seconds.

#### 6.1.2 DEVIATION FROM STANDARD

No deviation.

#### 6.1.3 TEST SETUP



#### **6.1.4 EUT OPERATION CONDITIONS**

The EUT tested system was configured as the statements of 4.1.5 unless otherwise a special operating condition is specified in the follows during the testing.

#### **6.1.5 EUT TEST CONDITIONS**

Temperature: 25°C  
Relative Humidity: 55%  
Test Voltage: DC 13.5V

#### **6.1.6 TEST RESULTS**

Please refer to the Appendix E.

## 7. HOPPING CHANNEL SEPARATION MEASUREMENT

### 7.1 APPLIED PROCEDURES / LIMIT

Frequency hopping systems operating in the 2400-2483.5 MHz band may have hopping channel carrier frequencies that are separated by 25 KHz or two-thirds of the 20 dB bandwidth of the hopping channel, whichever is greater.

Spectrum Parameter	Setting
Attenuation	Auto
Span Frequency	> Measurement Bandwidth or Channel Separation
RBW	30 KHz
VBW	100 KHz
Detector	Peak
Trace	Max Hold
Sweep Time	Auto

#### 7.1.1 TEST PROCEDURE

- a. The EUT must have its hopping function enabled
- b. Span = wide enough to capture the peaks of two adjacent channels
  - Resolution (or IF) Bandwidth (RBW)  $\geq$  1% of the span
  - Video (or Average) Bandwidth (VBW)  $\geq$  RBW
  - Sweep = Auto
  - Detector function = Peak
  - Trace = Max Hold

#### 7.1.2 DEVIATION FROM STANDARD

No deviation.

#### 7.1.3 TEST SETUP

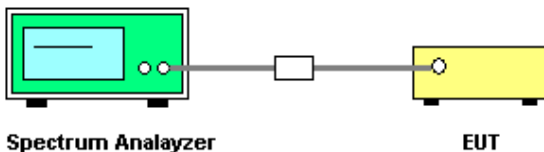

#### 7.1.4 EUT TEST CONDITIONS

Temperature: 25°C  
 Relative Humidity: 55%  
 Test Voltage: DC 13.5V

#### 7.1.5 TEST RESULTS

Please refer to the Appendix F.

## 8. BANDWIDTH TEST

### 8.1 APPLIED PROCEDURES

FCC Part15 (15.247) , Subpart C		
Section	Test Item	Frequency Range (MHz)
15.247(a)(2)	Bandwidth	2400-2483.5

Spectrum Parameter	Setting
Attenuation	Auto
Span Frequency	> Measurement Bandwidth or Channel Separation
RBW	30 KHz (20dB Bandwidth) / 30 KHz (Channel Separation)
VBW	100 KHz (20dB Bandwidth) / 100 KHz (Channel Separation)
Detector	Peak
Trace	Max Hold
Sweep Time	Auto

#### 8.1.1 TEST PROCEDURE

- a. The EUT was directly connected to the spectrum analyzer and antenna output port as show in the block diagram below,
- b. Spectrum Setting: RBW= 30KHz, VBW=100KHz, Sweep Time = Auto.

#### 8.1.2 DEVIATION FROM STANDARD

No deviation.

#### 8.1.3 TEST SETUP

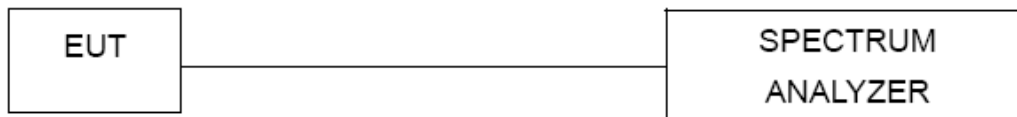

#### 8.1.4 EUT OPERATION CONDITIONS

The EUT tested system was configured as the statements of 4.1.5 unless otherwise a special operating condition is specified in the follows during the testing.

#### 8.1.5 EUT TEST CONDITIONS

Temperature: 25°C  
 Relative Humidity: 55%  
 Test Voltage: DC 13.5V

#### 8.1.6 TEST RESULTS

Please refer to the Appendix G.

## 9. PEAK OUTPUT POWER TEST

### 9.1 APPLIED PROCEDURES / LIMIT

FCC Part15 (15.247) , Subpart C				
Section	Test Item	Limit	Frequency Range (MHz)	Result
15.247(a)(1)	Peak Output Power	0.125Watt or 21dBm	2400-2483.5	PASS

Note: Frequency hopping systems shall have hopping channel carrier frequencies separated by a minimum of 25 kHz or the 20 dB bandwidth of the hopping channel, whichever is greater. Alternatively, frequency hopping systems operating in the 2400-2483.5 MHz band may have hopping channel carrier frequencies that are separated by 25 kHz or two-thirds of the 20 dB bandwidth of the hopping channel, whichever is greater, provided the systems operate with an output power no greater than 125 mW.

#### 9.1.1 TEST PROCEDURE

- a. The EUT was directly connected to the spectrum analyzer and antenna output port as show in the block diagram below,
- b. Spectrum Setting: RBW= 1MHz/3MHz, VBW= 1MHz/3MHz, Sweep time = Auto.

#### 9.1.2 DEVIATION FROM STANDARD

No deviation.

#### 9.1.3 TEST SETUP



#### 9.1.4 EUT OPERATION CONDITIONS

The EUT tested system was configured as the statements of 4.1.5 unless otherwise a special operating condition is specified in the follows during the testing.

#### 9.1.5 EUT TEST CONDITIONS

Temperature: 25°C  
 Relative Humidity: 55%  
 Test Voltage: DC 13.5V

#### 9.1.6 TEST RESULTS

Please refer to the Appendix H.



## 10. ANTENNA CONDUCTED SPURIOUS EMISSION

### 10.1 APPLIED PROCEDURES / LIMIT

In any 100 kHz bandwidth outside the frequency band in which the spread spectrum or digitally modulated device is operating, the RF power that is produced shall be at least 20 dB below that in the 100 kHz bandwidth within the band that contains the highest level of the desired power, based on either an RF conducted or a radiated measurement, provided that the transmitter demonstrates compliance with the peak conducted power limits.

#### 10.1.1 TEST PROCEDURE

- a. The EUT was directly connected to the spectrum analyzer and antenna output port as show in the block diagram below,
- b. Spectrum Setting: RBW= 100KHz, VBW=100KHz, Sweep time = Auto.
- c. Offset=antenna gain+cable loss

#### 10.1.2 DEVIATION FROM STANDARD

No deviation.

#### 10.1.3 TEST SETUP



#### 10.1.4 EUT OPERATION CONDITIONS

The EUT tested system was configured as the statements of 4.1.5 unless otherwise a special operating condition is specified in the follows during the testing.

#### 10.1.5 EUT TEST CONDITIONS

Temperature: 25°C  
 Relative Humidity: 55%  
 Test Voltage: DC 13.5V

#### 10.1.6 TEST RESULTS

Please refer to the Appendix I.

## 11. MEASUREMENT INSTRUMENTS LIST

Radiated Emission Measurement - Below 1GHz					
Item	Kind of Equipment	Manufacturer	Type No.	Serial No.	Calibrated until
1	Antenna	Schwarbeck	VULB9160	9160-3232	Mar. 11, 2019
2	Amplifier	HP	8447D	2944A09673	Oct. 19, 2018
3	Receiver	Agilent	N9038A	MY52130039	Aug. 20, 2018
4	Cable	emci	LMR-400(30MHz-1GHz)(8m+5m)	N/A	May. 25, 2019
5	Controller	CT	SC100	N/A	N/A
6	Controller	MF	MF-7802	MF780208416	N/A
7	Measurement Software	Farad	EZ-EMC Ver.NB-03A1-01	N/A	N/A
8	Antenna	EM	EM-6876-1	230	Feb. 07, 2019

Radiated Emission Measurement - Above 1GHz					
Item	Kind of Equipment	Manufacturer	Type No.	Serial No.	Calibrated until
1	Double Ridged Guide Antenna	ETS	3115	75789	Mar. 11, 2019
2	Broad-Band Horn Antenna	Schwarzbeck	BBHA 9170	9170319	Jun. 30, 2019
3	Amplifier	Agilent	8449B	3008A02274	Mar. 11, 2019
4	Microwave Preamplifier With Adaptor	EMC INSTRUMENT	EMC2654045	980039 & HA01	Mar. 11, 2019
5	Receiver	Agilent	N9038A	MY52130039	Aug. 20, 2018
6	Controller	CT	SC100	N/A	N/A
7	Controller	MF	MF-7802	MF780208416	N/A
8	Cable	N/A	CA500-SMSM-12M (1-26.5GHz)	N/A	Sep. 29, 2018
9	Measurement Software	Farad	EZ-EMC Ver.NB-03A1-01	N/A	N/A

**Number of Hopping Channel**

Item	Kind of Equipment	Manufacturer	Type No.	Serial No.	Calibrated until
1	Spectrum Analyzer	R&S	FSP40	100185	Aug. 20, 2018

**Average Time of Occupancy**

Item	Kind of Equipment	Manufacturer	Type No.	Serial No.	Calibrated until
1	Spectrum Analyzer	R&S	FSP40	100185	Aug. 20, 2018

**Hopping Channel Separation Measurement**

Item	Kind of Equipment	Manufacturer	Type No.	Serial No.	Calibrated until
1	Spectrum Analyzer	R&S	FSP40	100185	Aug. 20, 2018

**Bandwidth**

Item	Kind of Equipment	Manufacturer	Type No.	Serial No.	Calibrated until
1	Spectrum Analyzer	R&S	FSP40	100185	Aug. 20, 2018

**Peak Output Power**

Item	Kind of Equipment	Manufacturer	Type No.	Serial No.	Calibrated until
1	Spectrum Analyzer	R&S	FSP40	100185	Aug. 20, 2018

**Antenna Conducted Spurious Emission**

Item	Kind of Equipment	Manufacturer	Type No.	Serial No.	Calibrated until
1	Spectrum Analyzer	R&S	FSP40	100185	Aug. 20, 2018

Remark: "N/A" denotes no model name, serial no. or calibration specified.  
 All calibration period of equipment list is one year.

## 12. EUT TEST PHOTO

### Radiated Measurement Photos

9KHz to 30MHz



## Radiated Measurement Photos

30MHz to 1000MHz

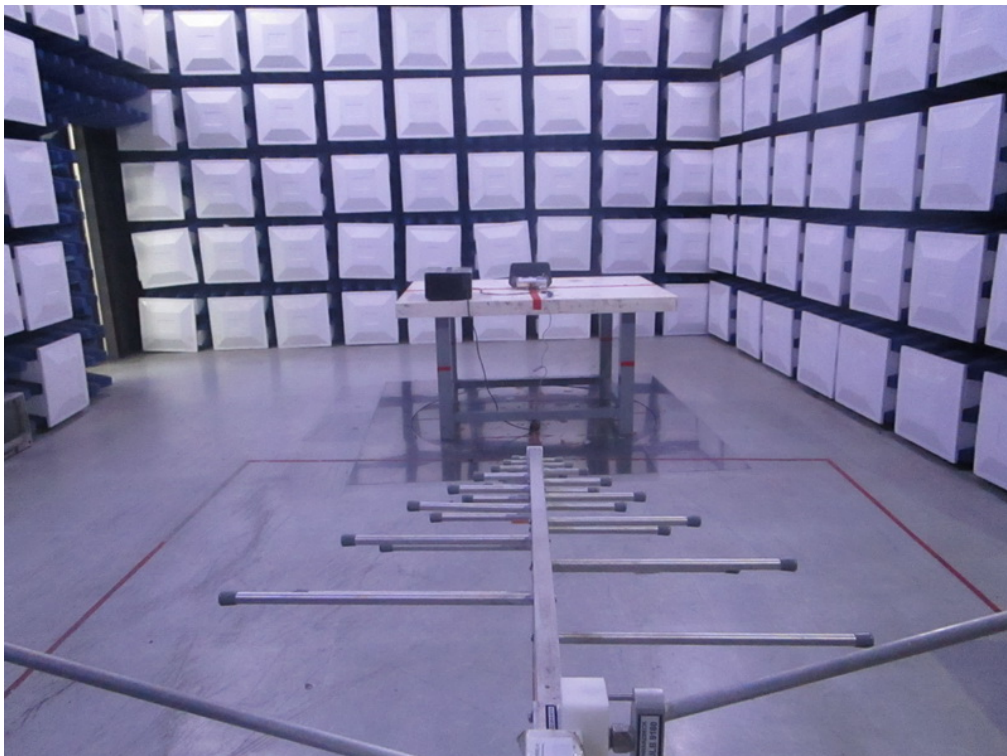

**Radiated Measurement Photos**

**1GHz to 18GHz**

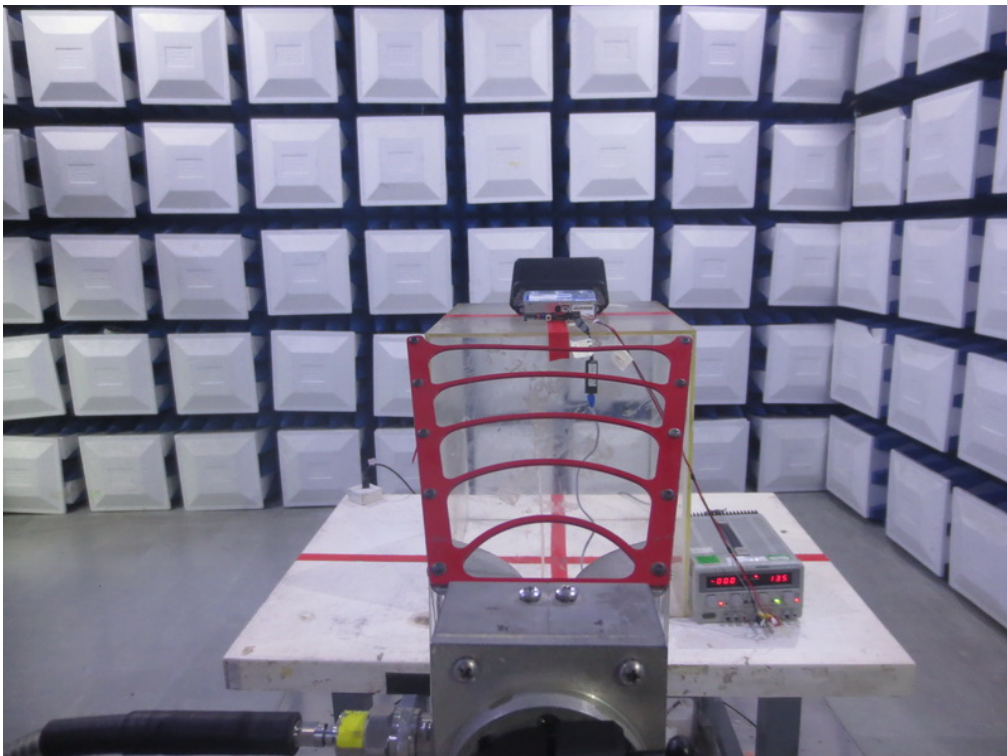
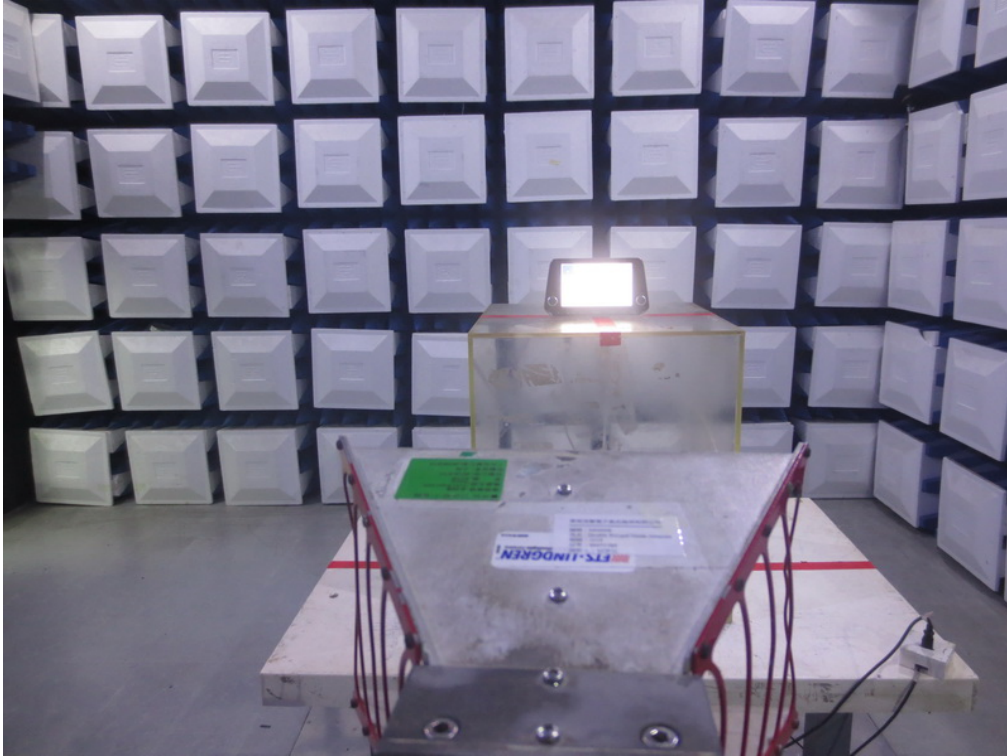

**Radiated Measurement Photos**

**18GHz to 26.5GHz**

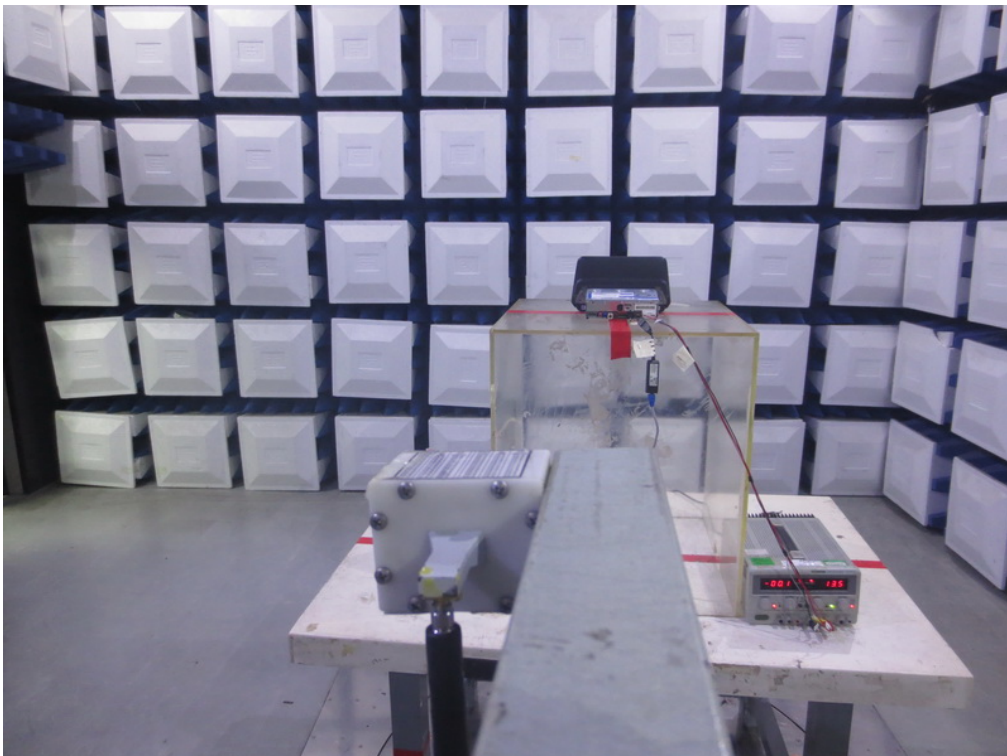
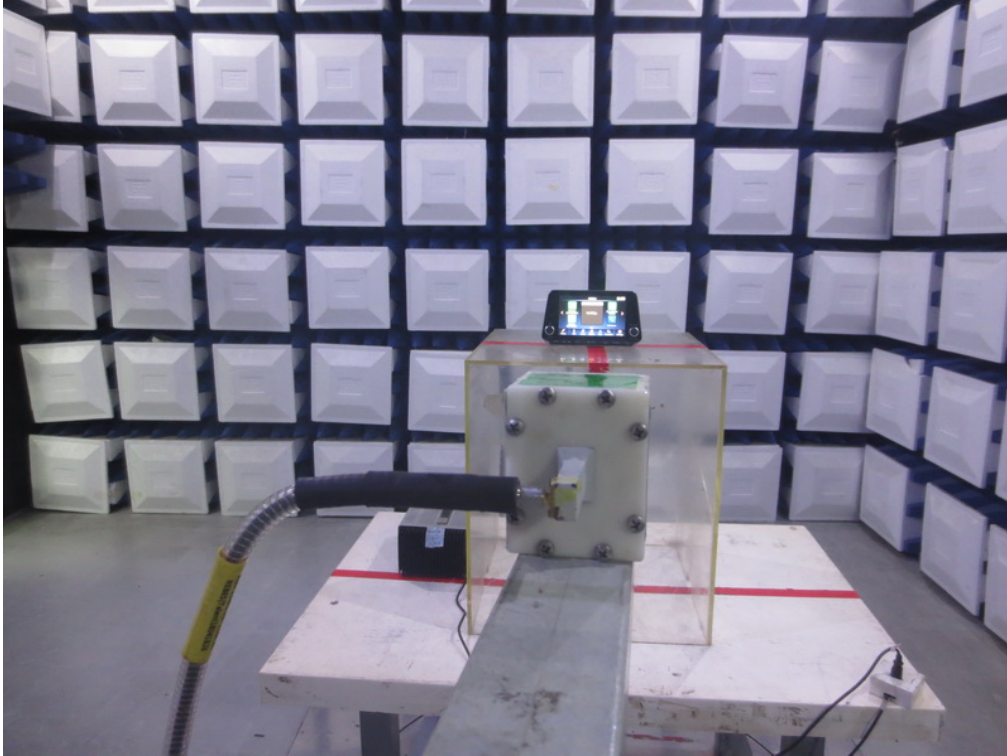

### Band Edge Measurement Photos

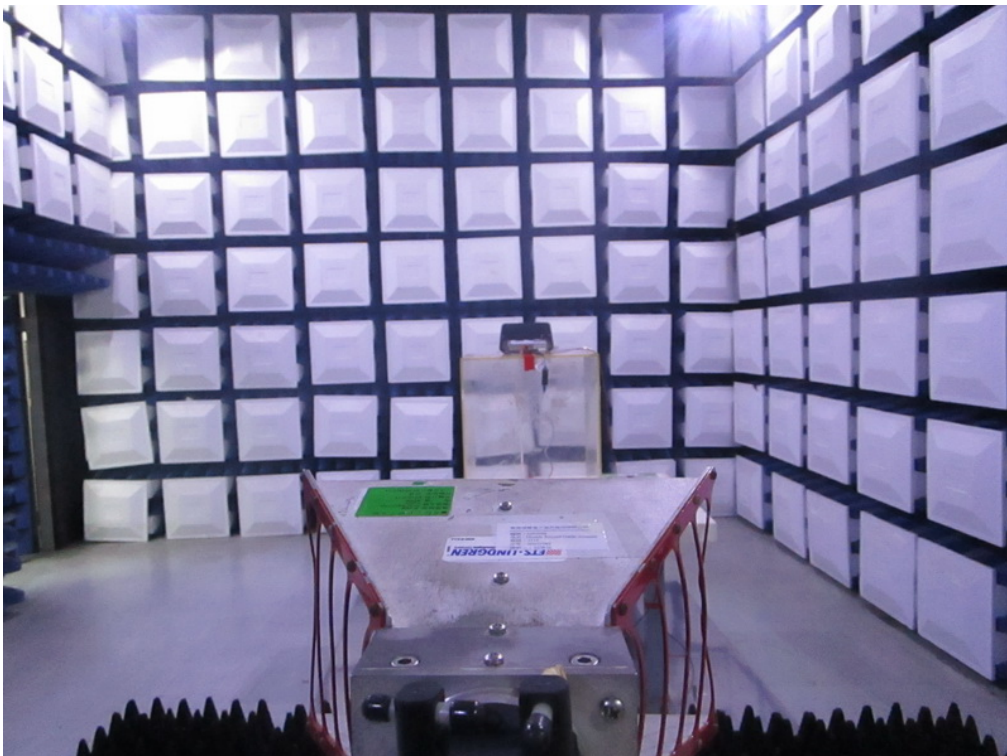



## APPENDIX A - RADIATED EMISSION (9KHZ-30MHZ)

Test Mode: TX Mode

Ant 0°

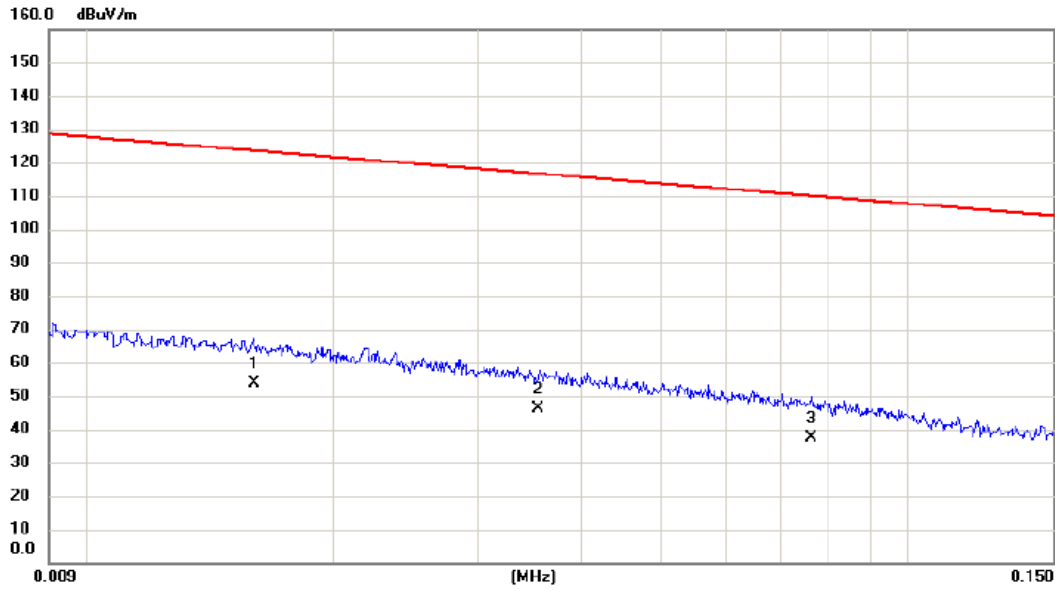

No.	Mk.	Freq. MHz	Reading Level dBuV	Correct Factor dB	Measure- ment dBuV/m	Limit dBuV/m	Margin dB	Detector	Comment
1	*	0.0160	33.21	20.58	53.79	123.52	-69.73	AVG	
2		0.0355	26.50	19.76	46.26	116.60	-70.34	AVG	
3		0.0761	18.60	19.00	37.60	109.98	-72.38	AVG	

Test Mode: TX Mode

Ant 0°

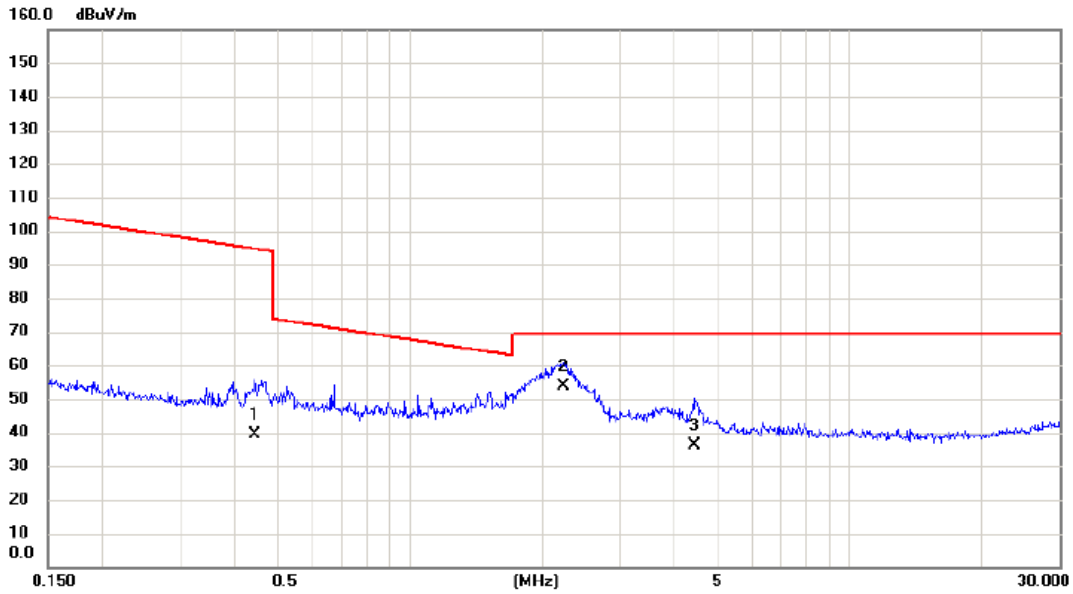

No.	Mk.	Freq. MHz	Reading Level dBuV	Correct Factor dB	Measure- ment dBuV/m	Limit dBuV/m	Margin dB	Detector	Comment
1		0.4444	22.50	16.99	39.49	94.65	-55.16	AVG	
2	*	2.2367	36.80	16.97	53.77	69.54	-15.77	QP	
3		4.4305	20.60	15.50	36.10	69.54	-33.44	QP	

Test Mode: TX Mode

Ant 90°

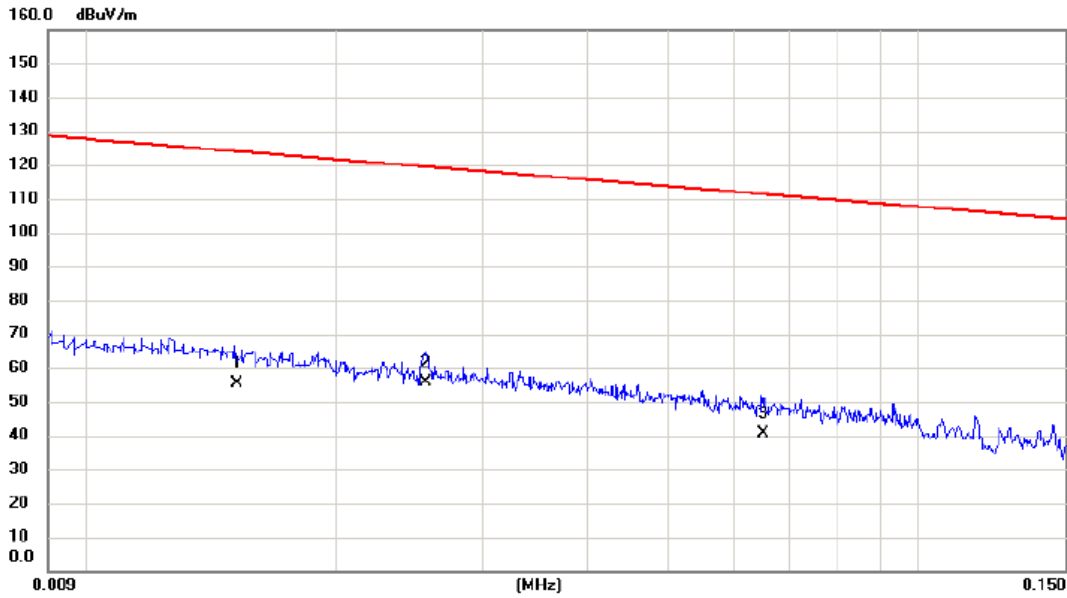

No.	Mk.	Freq. MHz	Reading Level dBuV	Correct Factor dB	Measure- ment dBuV/m	Limit dBuV/m	Margin dB	Detector	Comment
1		0.0152	34.80	20.69	55.49	123.97	-68.48	AVG	
2	*	0.0256	35.70	19.93	55.63	119.44	-63.81	AVG	
3		0.0650	21.40	19.23	40.63	111.35	-70.72	AVG	

Test Mode: TX Mode

Ant 90°

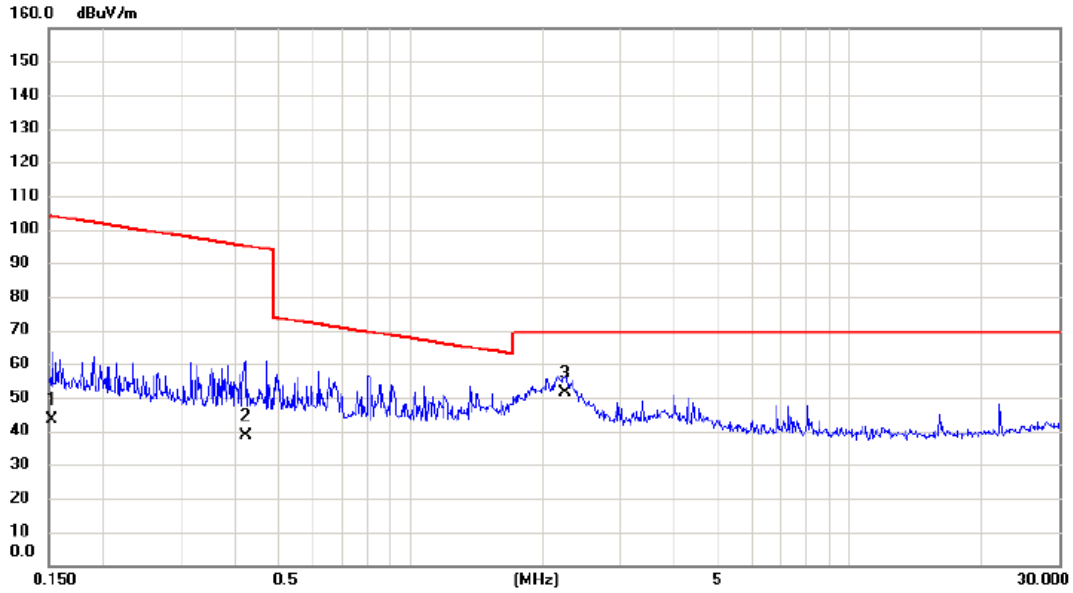

No.	Mk.	Freq. MHz	Reading Level dBuV	Correct Factor dB	Measure- ment dBuV/m	Limit dBuV/m	Margin dB	Detector	Comment
1		0.1532	26.30	17.24	43.54	103.90	-60.36	AVG	
2		0.4214	21.80	17.00	38.80	95.11	-56.31	AVG	
3	*	2.2486	34.60	16.96	51.56	69.54	-17.98	QP	

## APPENDIX B - RADIATED EMISSION (30MHZ TO 1000MHZ)

Test Mode: TX 2402MHz \_CH00\_1Mbps

### Vertical

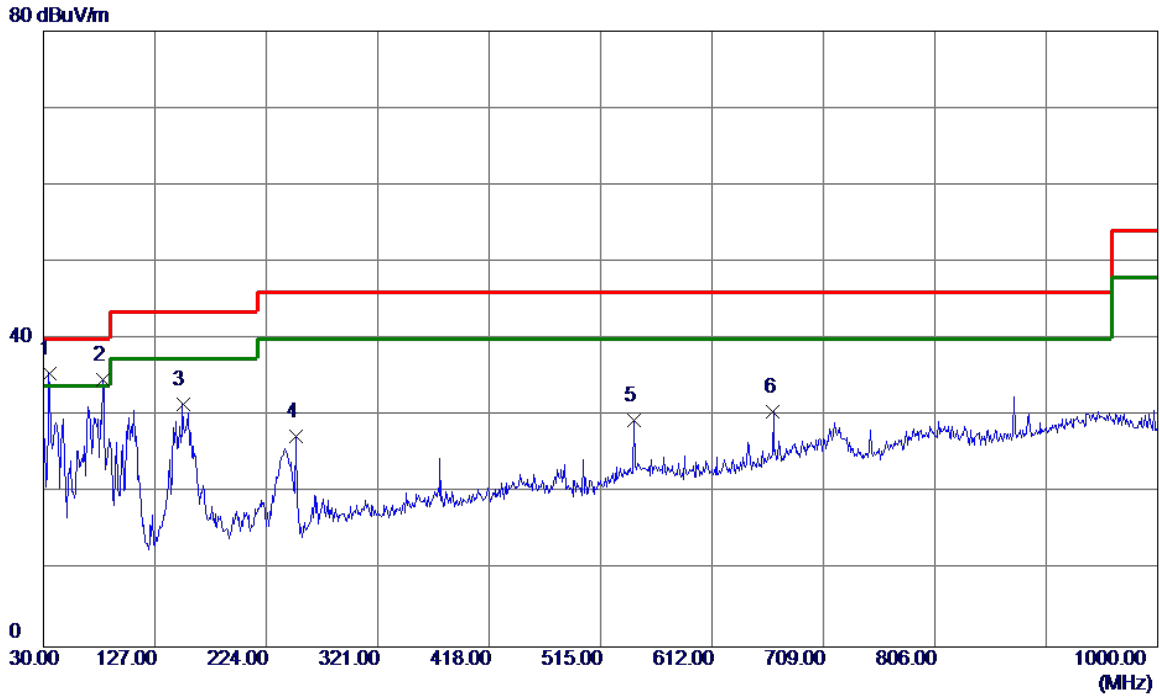

No.	Freq. MHz	Reading Level dBuV/m	Correct Factor dB	Measure ment dBuV/m	Limit dBuV/m	Margin dB	Detector	Comment
1 *	34.8500	50.43	-14.89	35.54	40.00	-4.46	Peak	
2	81.4100	53.49	-18.73	34.76	40.00	-5.24	Peak	
3	151.2500	42.95	-11.38	31.57	43.50	-11.93	Peak	
4	250.1900	41.68	-14.28	27.40	46.00	-18.60	Peak	
5	544.1000	35.24	-5.82	29.42	46.00	-16.58	Peak	
6	665.3500	35.00	-4.43	30.57	46.00	-15.43	Peak	

Test Mode: TX 2402MHz \_CH00\_1Mbps

### Horizontal

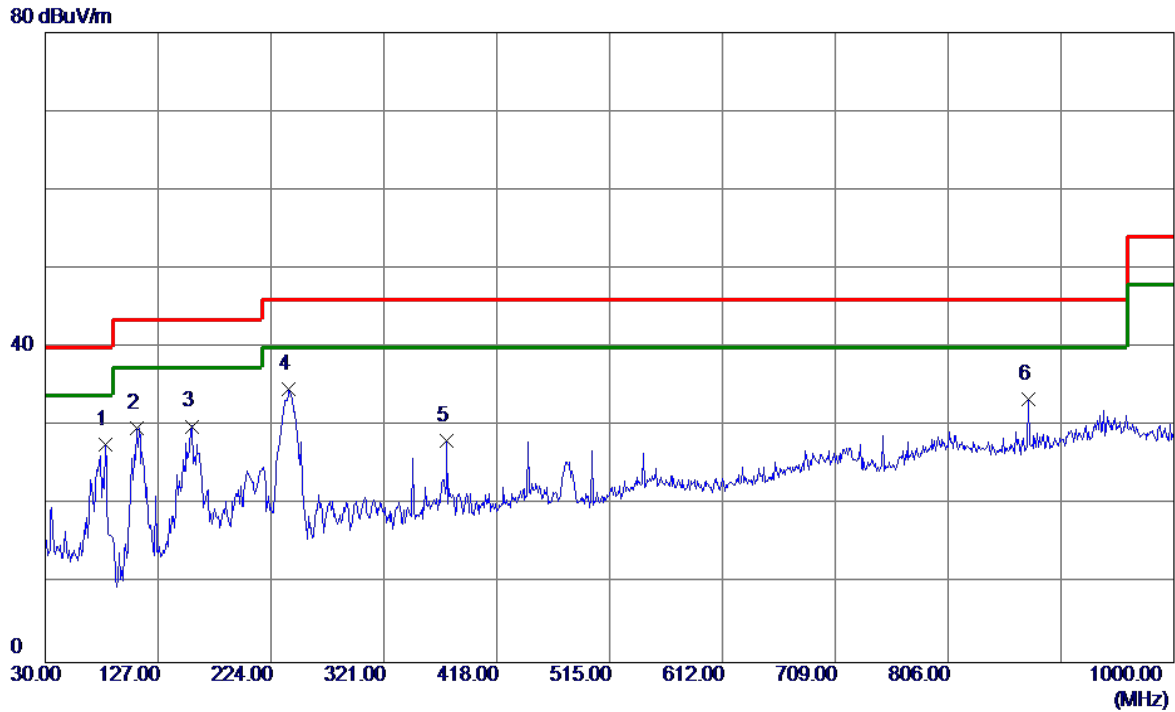

No.	Freq. MHz	Reading Level dBuV/m	Correct Factor dB	Measure ment dBuV/m	Limit dBuV/m	Margin dB	Detector	Comment
1	81.4100	46.45	-18.73	27.72	40.00	-12.28	Peak	
2	108.5700	46.39	-16.57	29.82	43.50	-13.68	Peak	
3	156.1000	40.95	-10.95	30.00	43.50	-13.50	Peak	
4 *	239.5200	49.48	-14.69	34.79	46.00	-11.21	Peak	
5	375.3200	38.38	-10.22	28.16	46.00	-17.84	Peak	
6	874.8700	34.59	-1.21	33.38	46.00	-12.62	Peak	



Test Mode: TX 2441MHz \_CH39\_1Mbps

**Vertical**

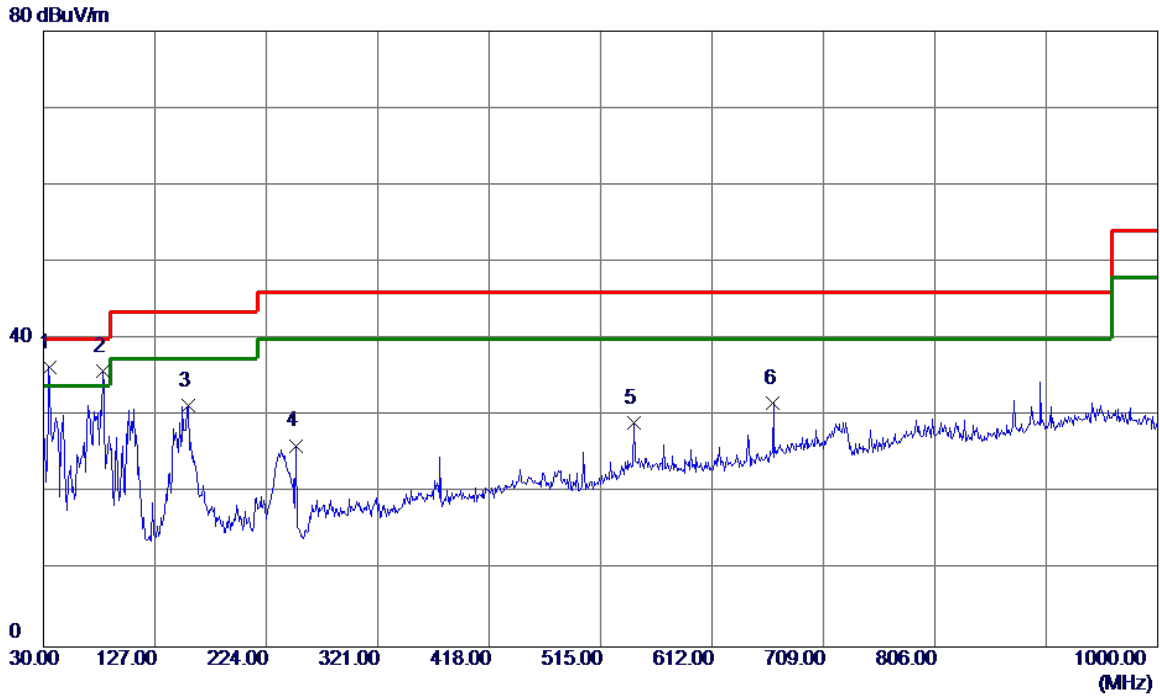

No.	Freq. MHz	Reading Level dBuV/m	Correct Factor dB	Measure ment dBuV/m	Limit dBuV/m	Margin dB	Detector	Comment
1 *	34.8500	51.14	-14.89	36.25	40.00	-3.75	Peak	
2	81.4100	54.55	-18.73	35.82	40.00	-4.18	Peak	
3	156.1000	42.24	-10.95	31.29	43.50	-12.21	Peak	
4	250.1900	40.44	-14.28	26.16	46.00	-19.84	Peak	
5	544.1000	34.89	-5.82	29.07	46.00	-16.93	Peak	
6	665.3500	36.11	-4.43	31.68	46.00	-14.32	Peak	

Test Mode: TX 2441MHz \_CH39\_1Mbps

**Horizontal**

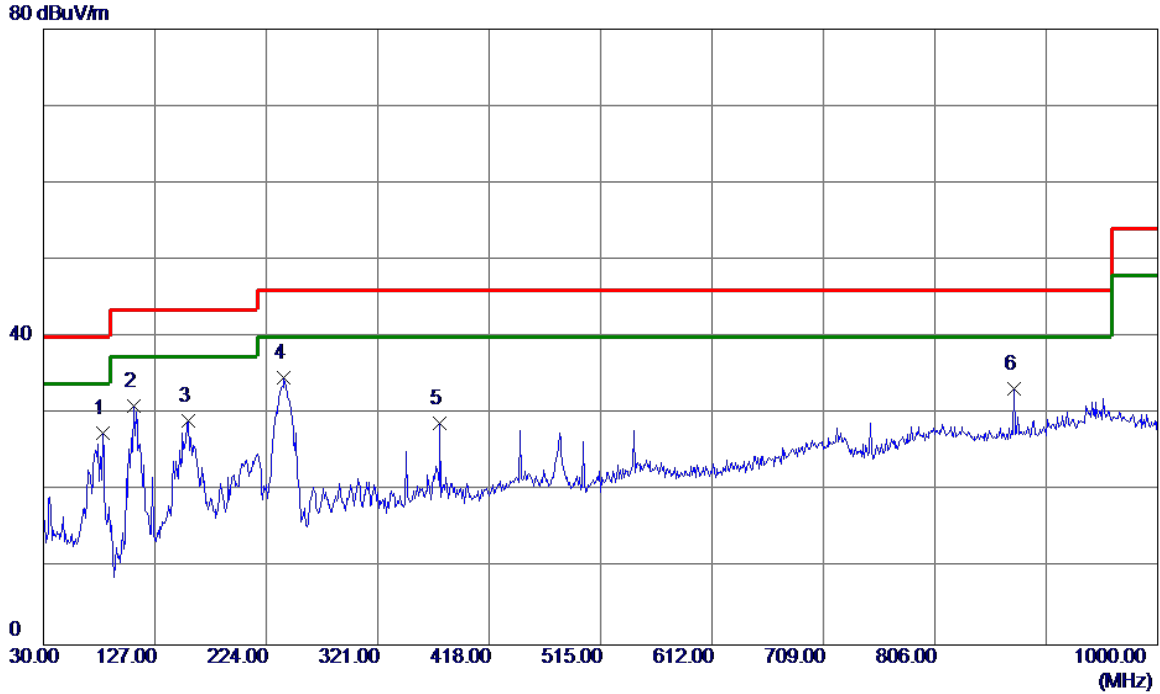

No.	Freq. MHz	Reading Level dBuV/m	Correct Factor dB	Measure ment dBuV/m	Limit dBuV/m	Margin dB	Detector	Comment
1	81.4100	46.26	-18.73	27.53	40.00	-12.47	Peak	
2	108.5700	47.61	-16.57	31.04	43.50	-12.46	Peak	
3	156.1000	40.08	-10.95	29.13	43.50	-14.37	Peak	
4 *	239.5200	49.36	-14.69	34.67	46.00	-11.33	Peak	
5	375.3200	39.01	-10.22	28.79	46.00	-17.21	Peak	
6	874.8700	34.53	-1.21	33.32	46.00	-12.68	Peak	

Test Mode: TX 2480MHz \_CH78\_1Mbps

**Vertical**

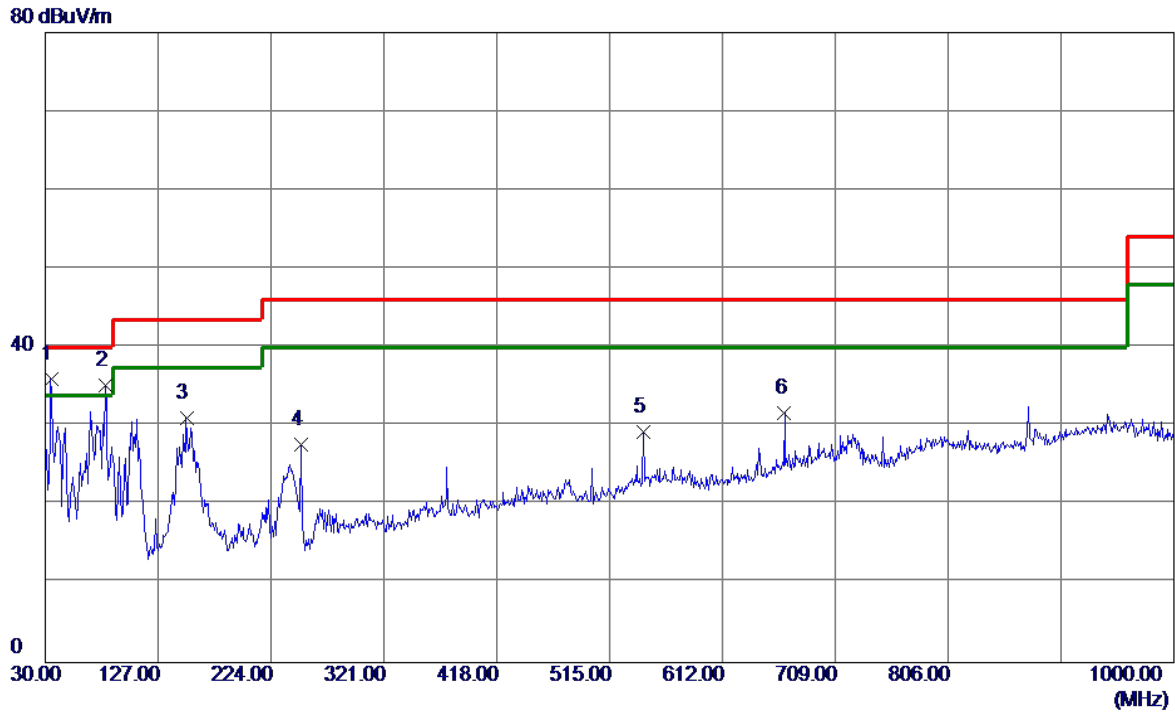

No.	Freq. MHz	Reading Level dBuV/m	Correct Factor dB	Measure ment dBuV/m	Limit dBuV/m	Margin dB	Detector	Comment
1 *	34.8500	50.82	-14.89	35.93	40.00	-4.07	Peak	
2	81.4100	53.86	-18.73	35.13	40.00	-4.87	Peak	
3	151.2500	42.43	-11.38	31.05	43.50	-12.45	Peak	
4	250.1900	41.91	-14.28	27.63	46.00	-18.37	Peak	
5	544.1000	35.15	-5.82	29.33	46.00	-16.67	Peak	
6	665.3500	36.04	-4.43	31.61	46.00	-14.39	Peak	

Test Mode: TX 2480MHz \_CH78\_1Mbps

### Horizontal

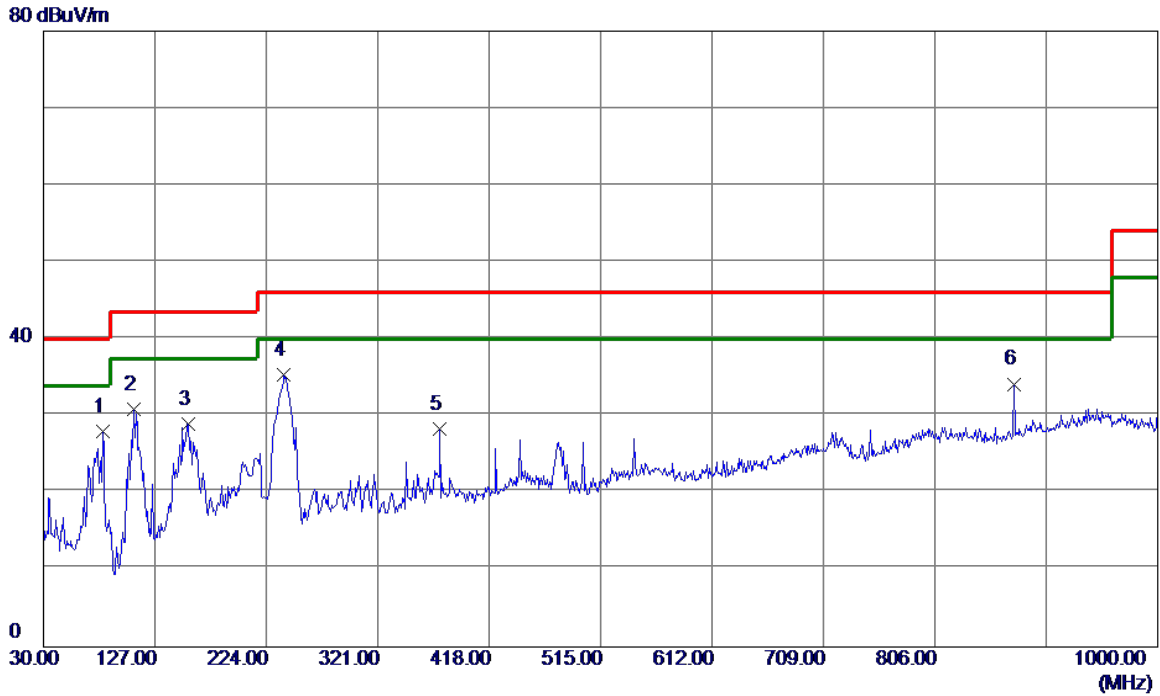

No.	Freq. MHz	Reading Level dBuV/m	Correct Factor dB	Measure ment dBuV/m	Limit dBuV/m	Margin dB	Detector	Comment
1	81.4100	46.73	-18.73	28.00	40.00	-12.00	Peak	
2	108.5700	47.50	-16.57	30.93	43.50	-12.57	Peak	
3	156.1000	39.92	-10.95	28.97	43.50	-14.53	Peak	
4 *	239.5200	50.08	-14.69	35.39	46.00	-10.61	Peak	
5	375.3200	38.56	-10.22	28.34	46.00	-17.66	Peak	
6	874.8700	35.37	-1.21	34.16	46.00	-11.84	Peak	

## APPENDIX C - RADIATED EMISSION (ABOVE 1000MHZ)

Test Mode : TX 2402MHz \_CH00\_1Mbps

Vertical

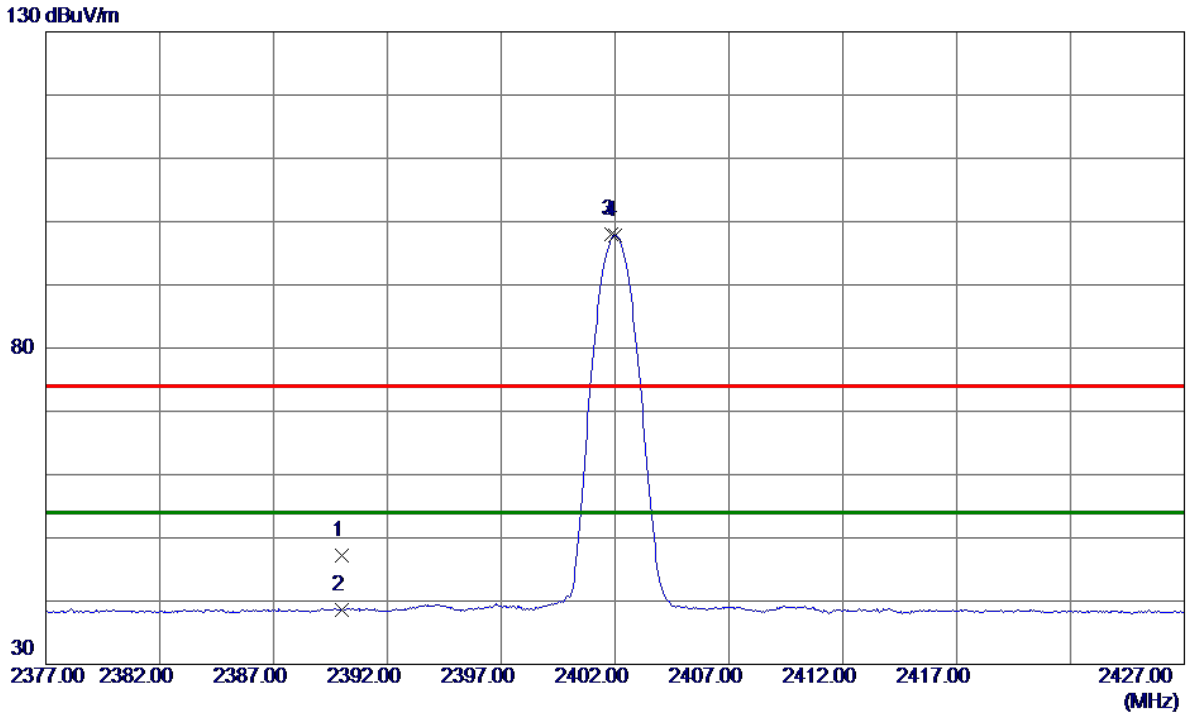

No.	Freq. MHz	Reading Level dBuV/m	Correct Factor dB	Measure ment dBuV/m	Limit dBuV/m	Margin dB	Detector	Comment
1	2390.0000	35.84	11.32	47.16	74.00	-26.84	Peak	
2	2390.0000	27.19	11.32	38.51	54.00	-15.49	AVG	
3	2401.8500	86.78	11.32	98.10	74.00	24.10	Peak	No Limit
4 *	2402.0000	86.50	11.32	97.82	54.00	43.82	AVG	No Limit

Test Mode : TX 2402MHz \_CH00\_1Mbps

Vertical

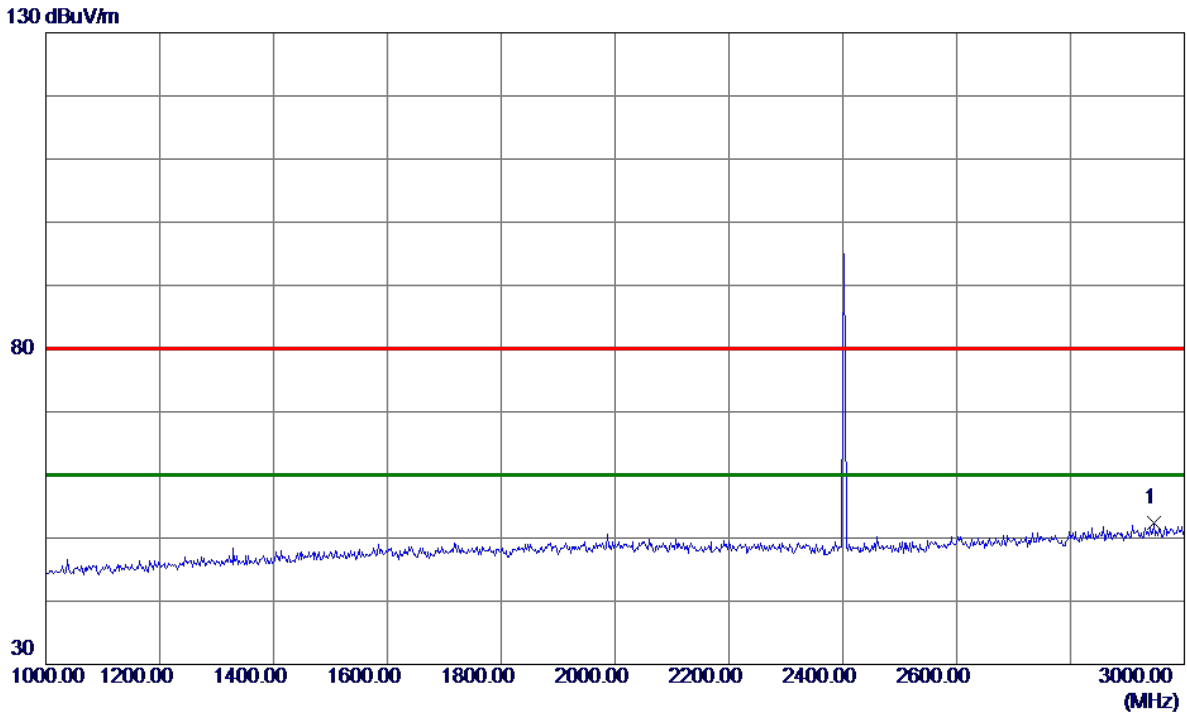

No.	Freq.	Reading Level	Correct Factor	Measurement	Limit	Margin	Detector	Comment
	MHz	dBuV/m	dB	dBuV/m	dBuV/m	dB		
1 *	2946.0000	37.87	14.61	52.48	80.00	-27.52	Peak	

Test Mode : TX 2402MHz \_CH00\_1Mbps

Vertical

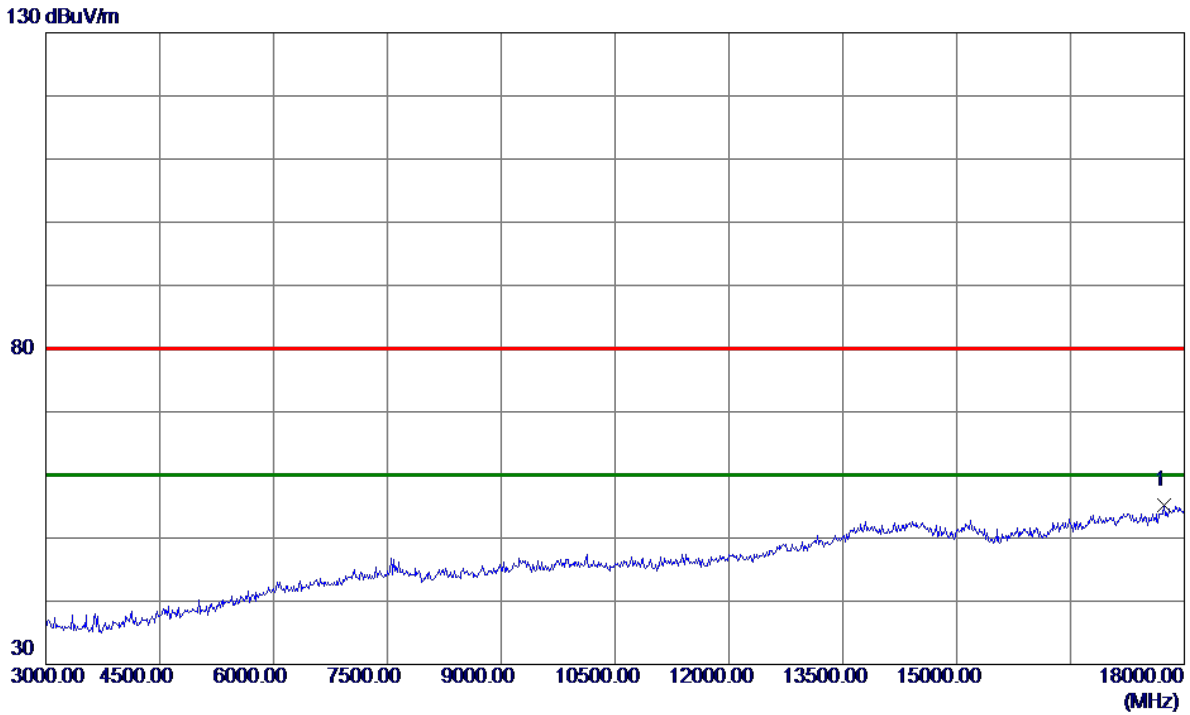

No.	Freq. MHz	Reading Level dBuV/m	Correct Factor dB	Measure ment dBuV/m	Limit dBuV/m	Margin dB	Detector	Comment
1 *	17730.0000	26.92	28.29	55.21	80.00	-24.79	Peak	



Test Mode : TX 2402MHz \_CH00\_1Mbps

Vertical

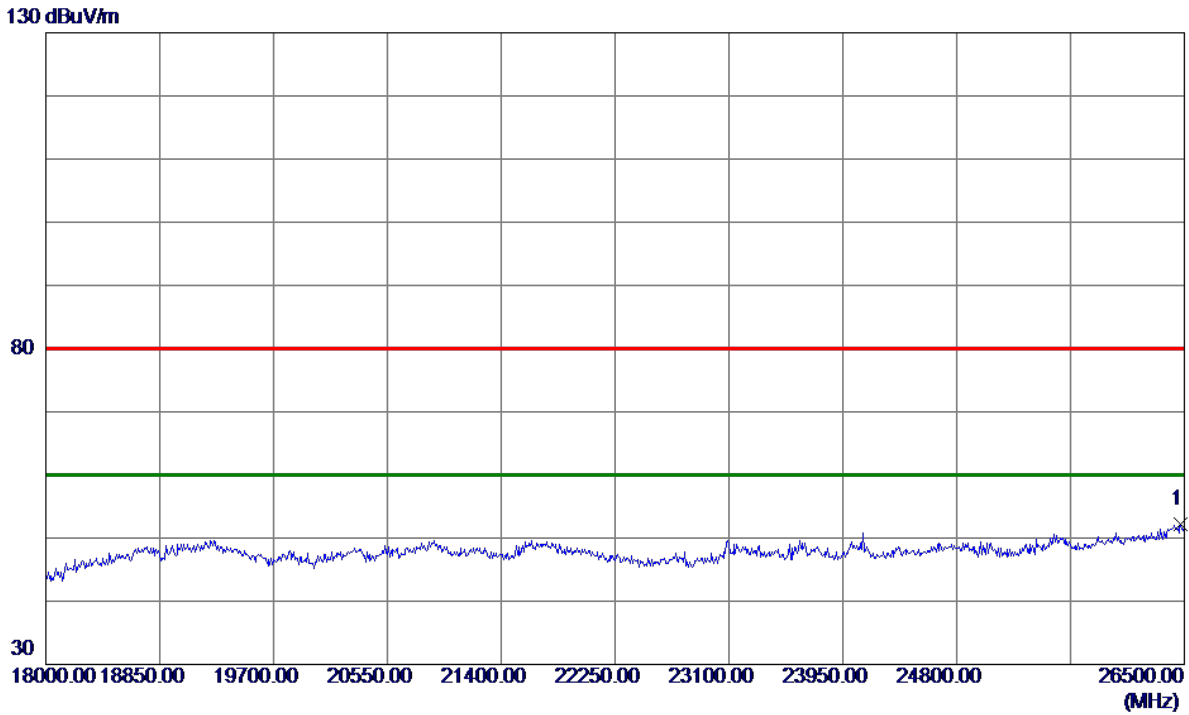

No.	Freq. MHz	Reading Level dBuV/m	Correct Factor dB	Measure ment dBuV/m	Limit dBuV/m	Margin dB	Detector	Comment
1 *	26474.5000	52.14	0.00	52.14	80.00	-27.86	Peak	

Test Mode : TX 2402MHz \_CH00\_1Mbps

Horizontal

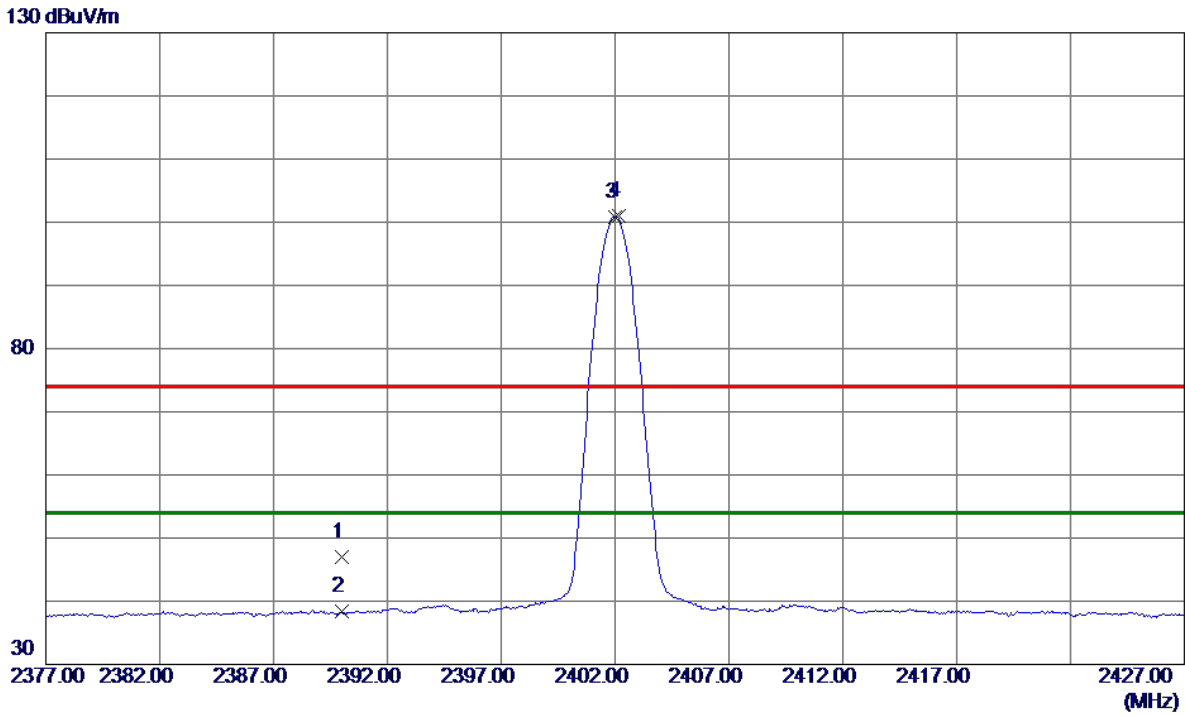

No.	Freq. MHz	Reading Level dBuV/m	Correct Factor dB	Measure ment dBuV/m	Limit dBuV/m	Margin dB	Detector	Comment
1	2390.0000	35.74	11.32	47.06	74.00	-26.94	Peak	
2	2390.0000	27.05	11.32	38.37	54.00	-15.63	AVG	
3 *	2402.0000	89.54	11.32	100.86	54.00	46.86	AVG	No Limit
4	2402.1500	89.78	11.32	101.10	74.00	27.10	Peak	No Limit

Test Mode : TX 2402MHz \_CH00\_1Mbps

**Horizontal**

130 dBuV/m

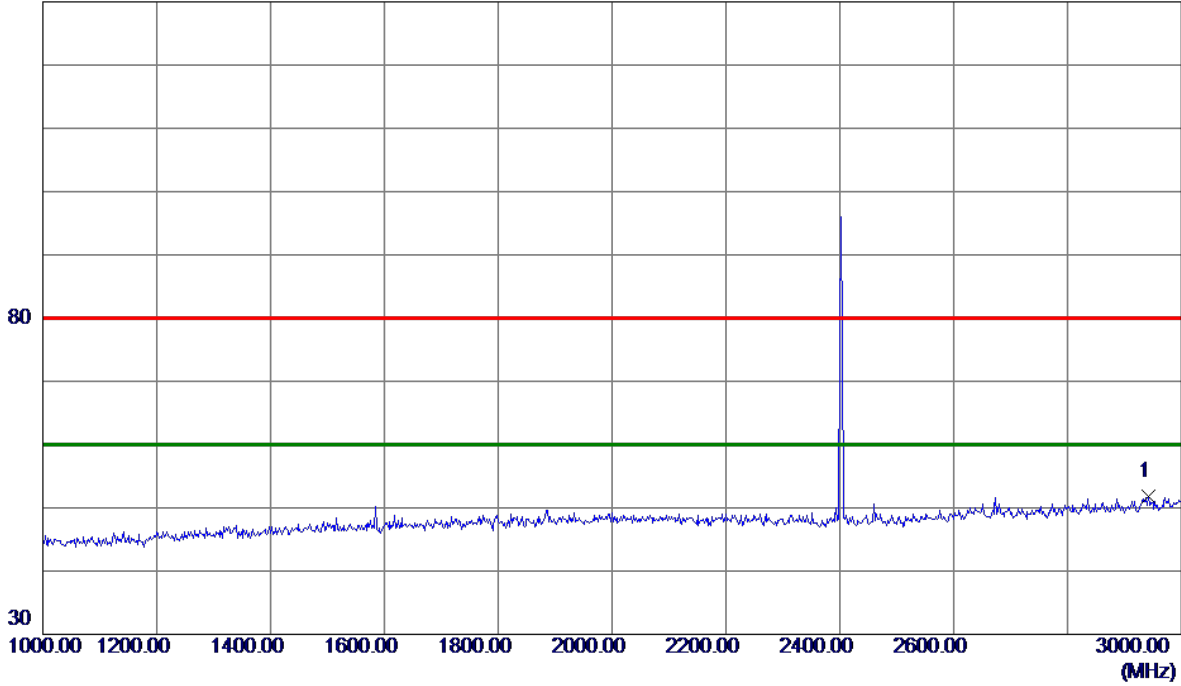

No.	Freq.	Reading Level	Correct Factor	Measurement	Limit	Margin	Detector	Comment
	MHz	dBuV/m	dB	dBuV/m	dBuV/m	dB		
1 *	2942.0000	37.18	14.58	51.76	80.00	-28.24	Peak	

Test Mode : TX 2402MHz \_CH00\_1Mbps

### Horizontal

130 dBuV/m

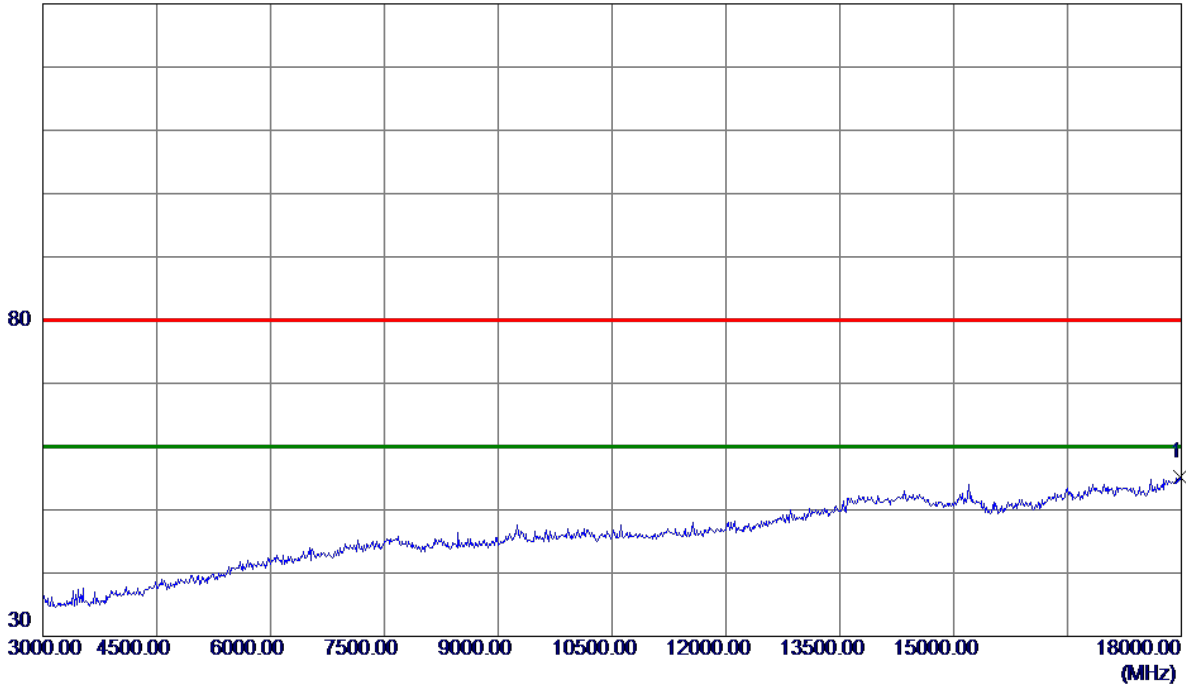

No.	Freq. MHz	Reading Level dBuV/m	Correct Factor dB	Measure ment dBuV/m	Limit dBuV/m	Margin dB	Detector	Comment
1 *	17985.0000	26.00	29.11	55.11	80.00	-24.89	Peak	

Test Mode : TX 2402MHz \_CH00\_1Mbps

**Horizontal**

130 dBuV/m

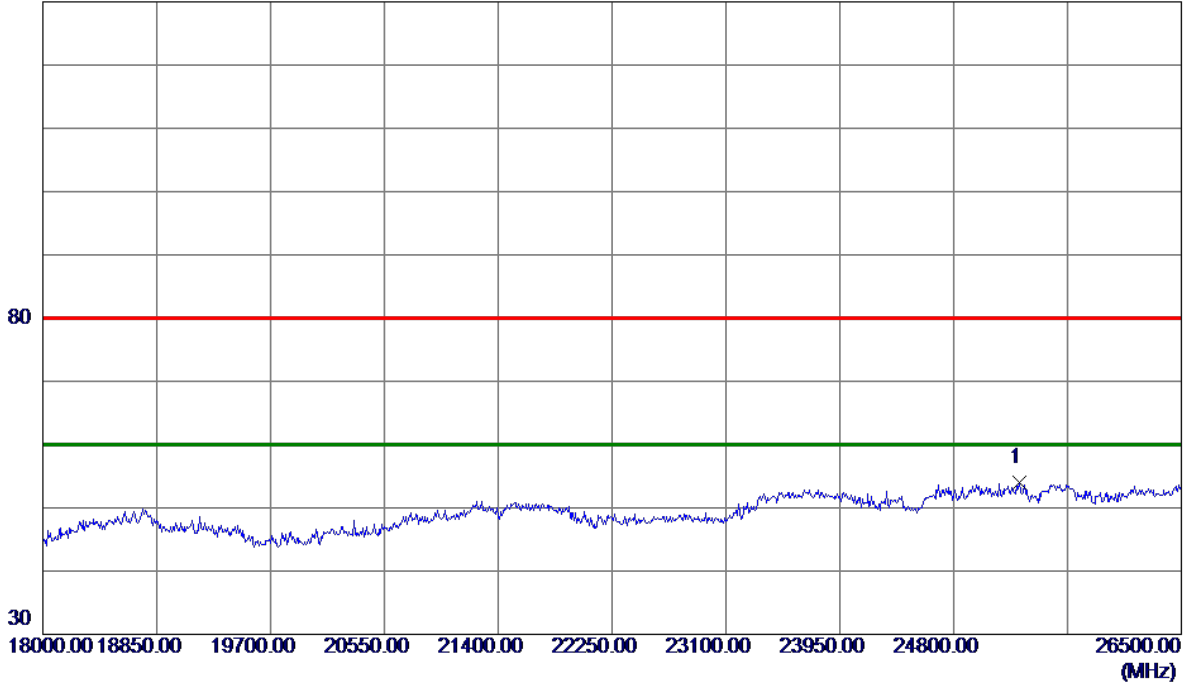

No.	Freq. MHz	Reading Level dBuV/m	Correct Factor dB	Measure ment dBuV/m	Limit dBuV/m	Margin dB	Detector	Comment
1 *	25293.0000	87.04	-33.10	53.94	80.00	-26.06	Peak	

Test Mode : TX 2441MHz \_CH39\_1Mbps

**Vertical**

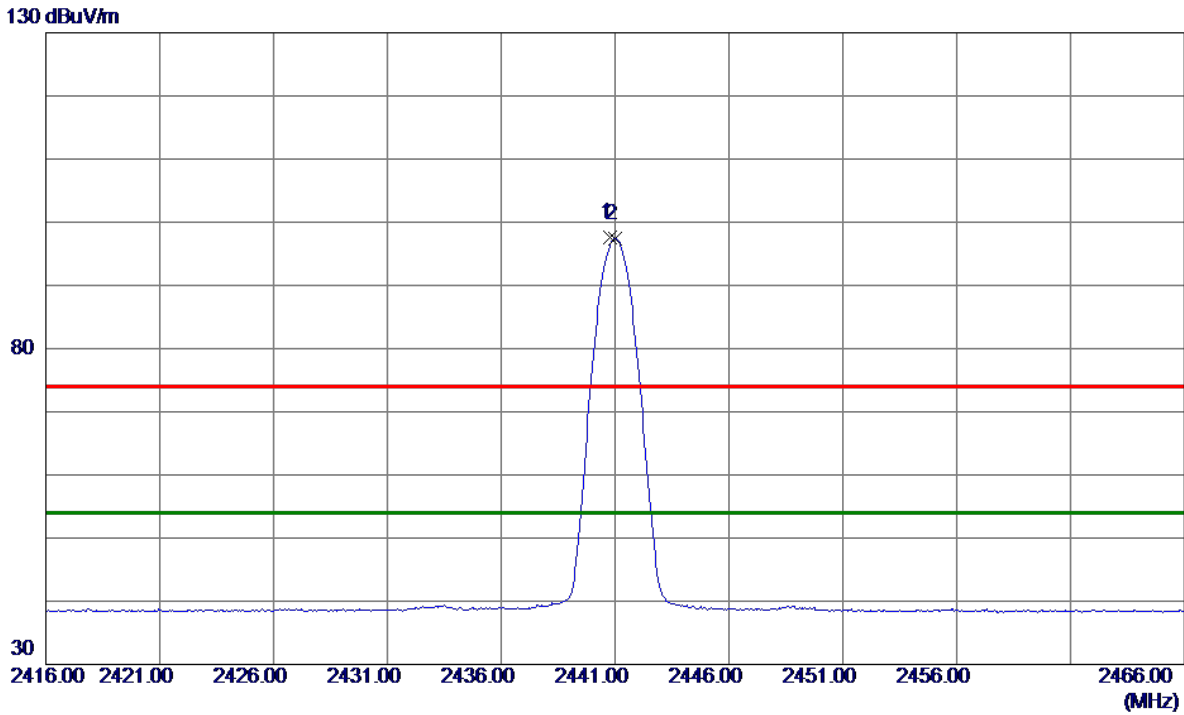

No.	Freq. MHz	Reading Level dBuV/m	Correct Factor dB	Measure ment dBuV/m	Limit dBuV/m	Margin dB	Detector	Comment
1	2440.8000	86.28	11.33	97.61	74.00	23.61	Peak	No Limit
2 *	2441.0000	86.00	11.33	97.33	54.00	43.33	AVG	No Limit

Test Mode : TX 2441MHz \_CH39\_1Mbps

Vertical

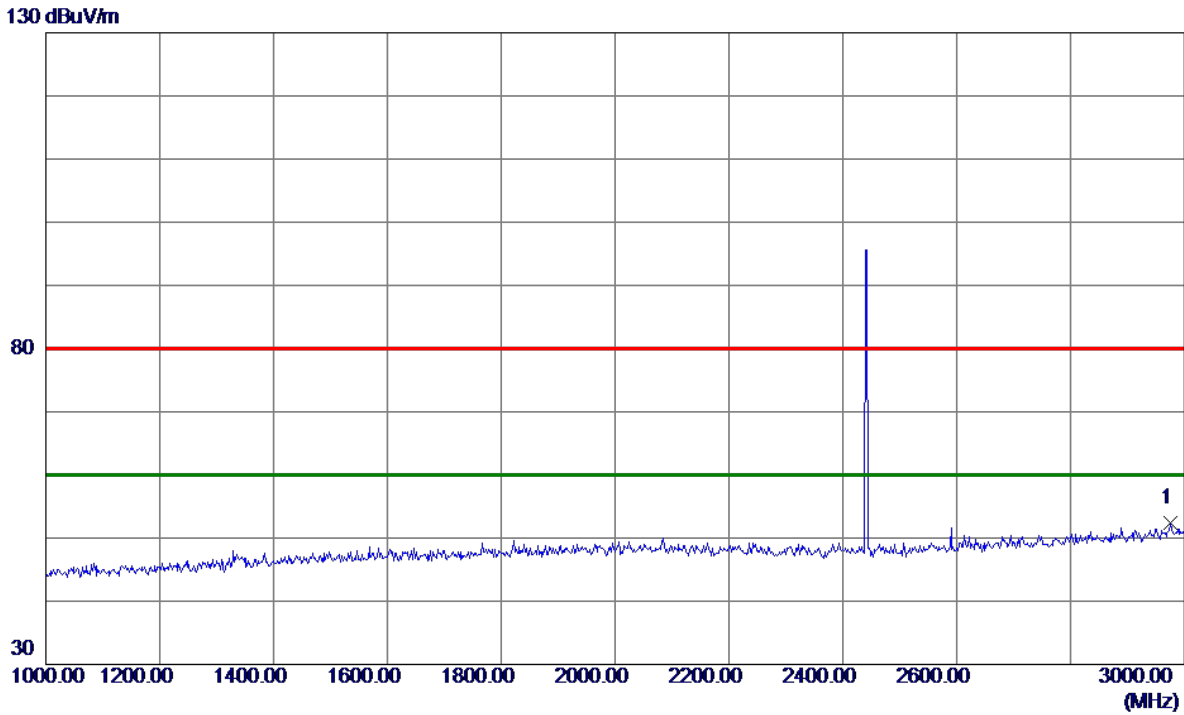

No.	Freq.	Reading Level	Correct Factor	Measurement	Limit	Margin	Detector	Comment
	MHz	dBuV/m	dB	dBuV/m	dBuV/m	dB		
1 *	2976.0000	37.51	14.82	52.33	80.00	-27.67	Peak	

Test Mode : TX 2441MHz \_CH39\_1Mbps

Vertical

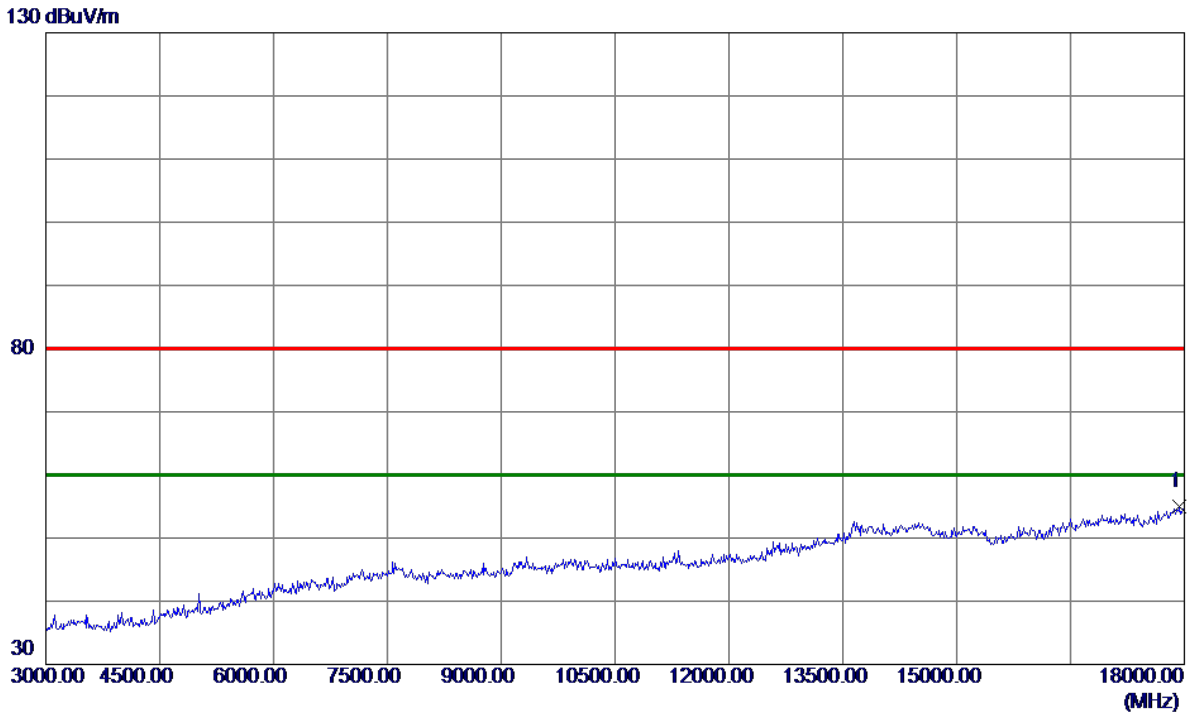

No.	Freq. MHz	Reading Level dBuV/m	Correct Factor dB	Measure ment dBuV/m	Limit dBuV/m	Margin dB	Detector	Comment
1 *	17940.0000	26.06	28.97	55.03	80.00	-24.97	Peak	



Test Mode : TX 2441MHz \_CH39\_1Mbps

Vertical

130 dBuV/m

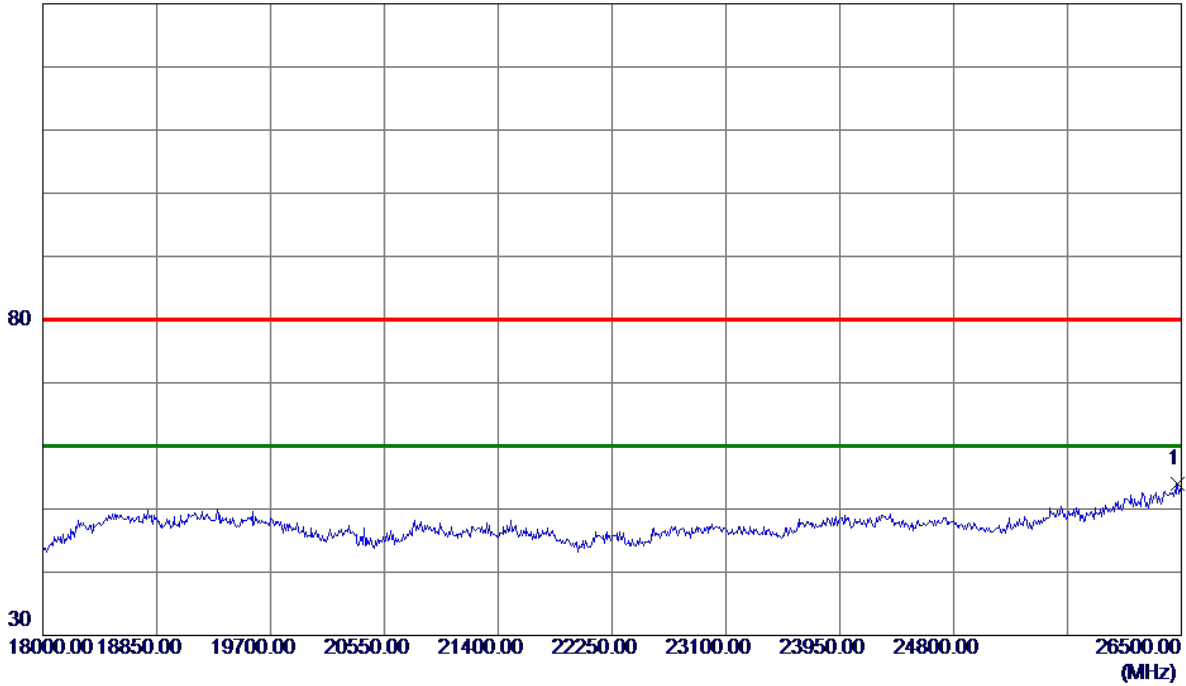

No.	Freq. MHz	Reading Level dBuV/m	Correct Factor dB	Measure ment dBuV/m	Limit dBuV/m	Margin dB	Detector	Comment
1 *	26474.5000	54.06	0.00	54.06	80.00	-25.94	Peak	

Test Mode : TX 2441MHz \_CH39\_1Mbps

**Horizontal**

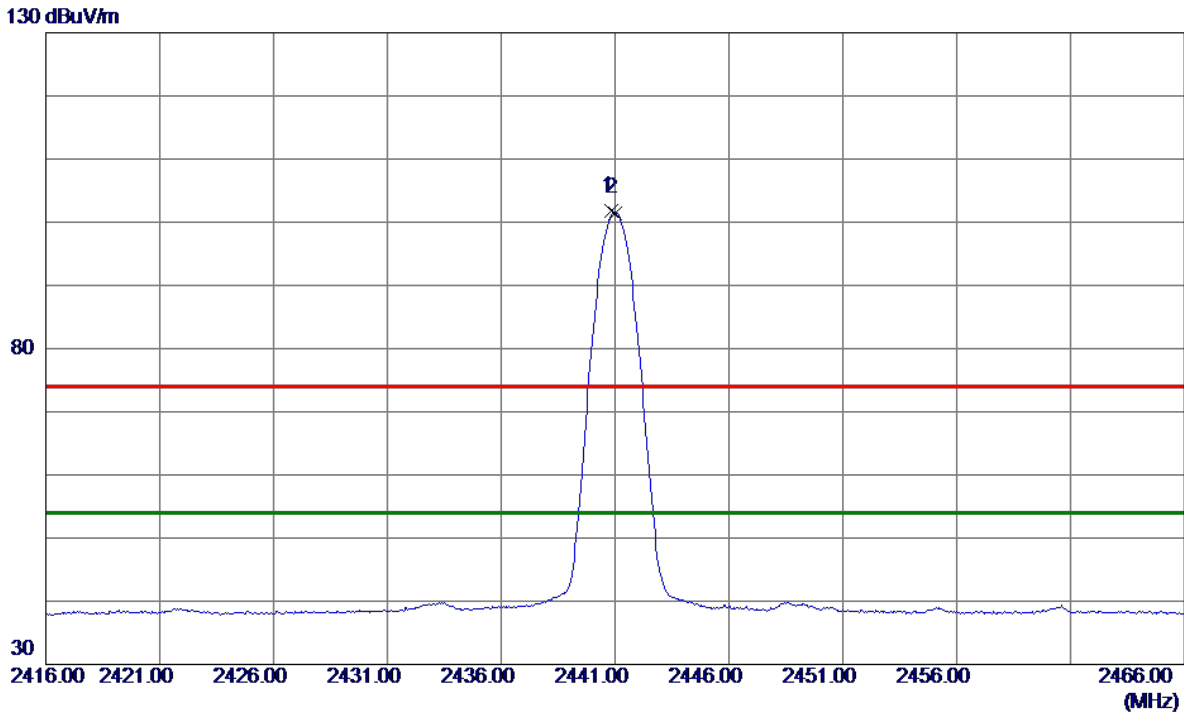

No.	Freq. MHz	Reading Level dBuV/m	Correct Factor dB	Measure ment dBuV/m	Limit dBuV/m	Margin dB	Detector	Comment
1	2440.8500	90.44	11.33	101.77	74.00	27.77	Peak	No Limit
2 *	2441.0000	90.17	11.33	101.50	54.00	47.50	AVG	No Limit

Test Mode : TX 2441MHz \_CH39\_1Mbps

Horizontal

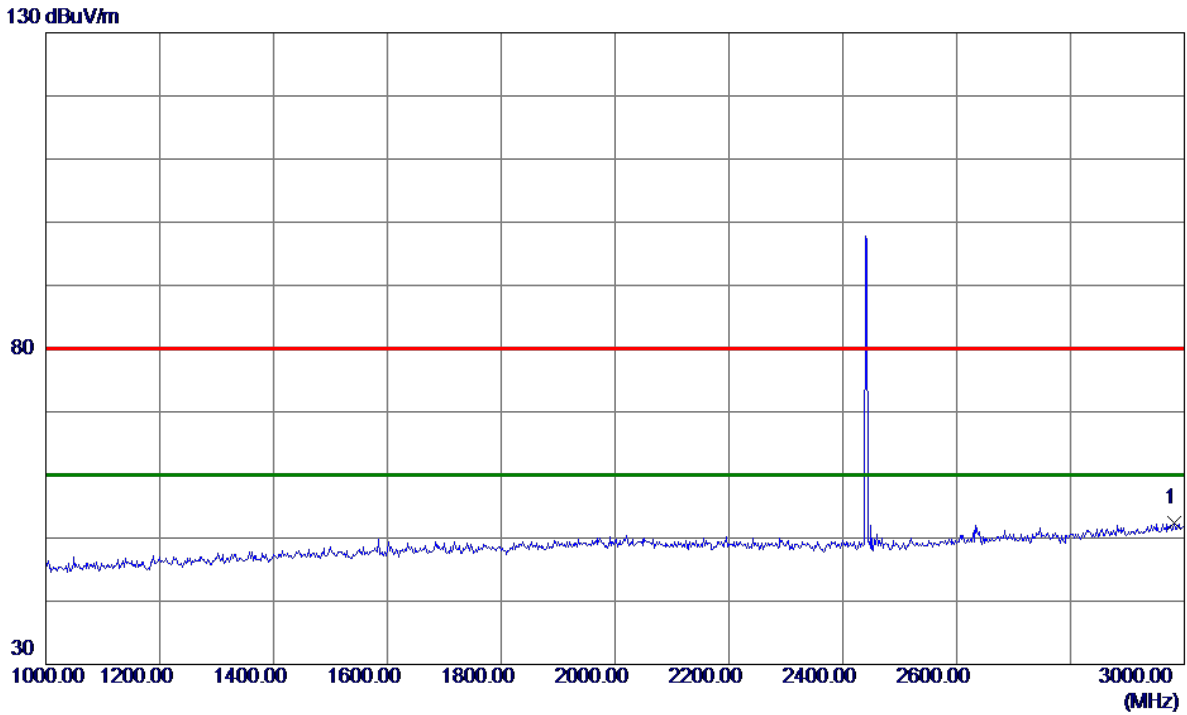

No.	Freq. MHz	Reading Level dBuV/m	Correct Factor dB	Measure ment dBuV/m	Limit dBuV/m	Margin dB	Detector	Comment
1 *	2982.0000	37.47	14.87	52.34	80.00	-27.66	Peak	

Test Mode : TX 2441MHz \_CH39\_1Mbps

**Horizontal**

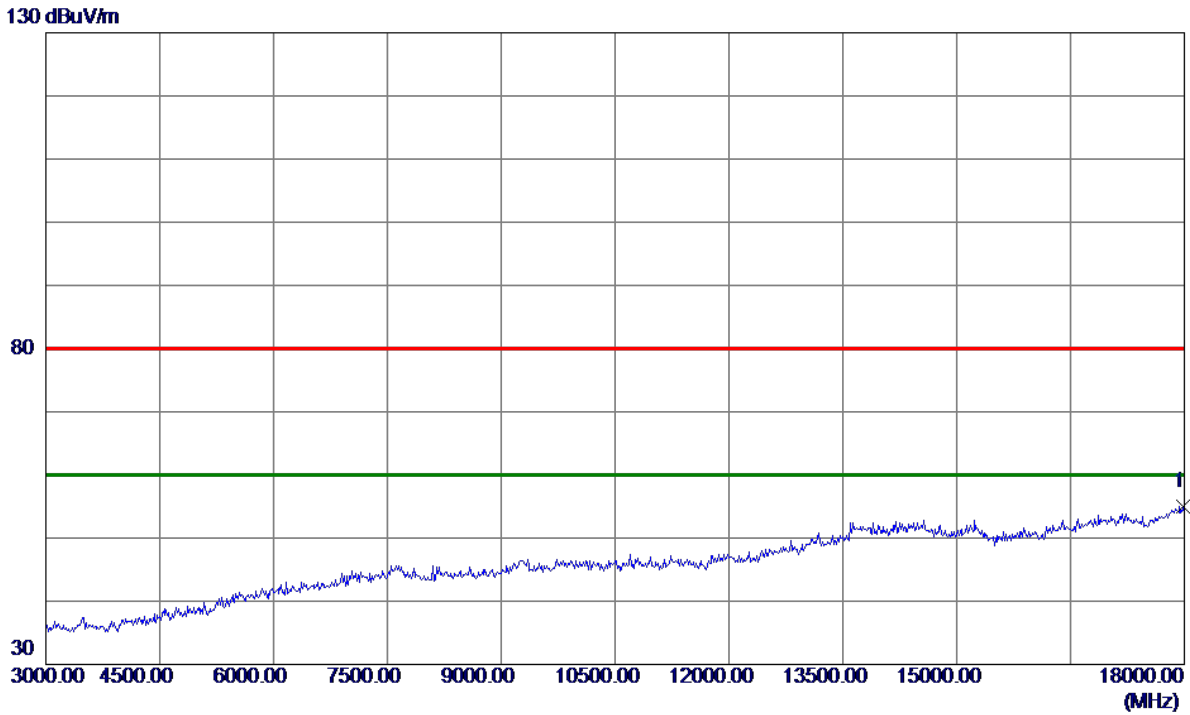

No.	Freq. MHz	Reading Level dBuV/m	Correct Factor dB	Measure ment dBuV/m	Limit dBuV/m	Margin dB	Detector	Comment
1 *	17985.0000	25.91	29.11	55.02	80.00	-24.98	Peak	

Test Mode : TX 2441MHz \_CH39\_1Mbps

Horizontal

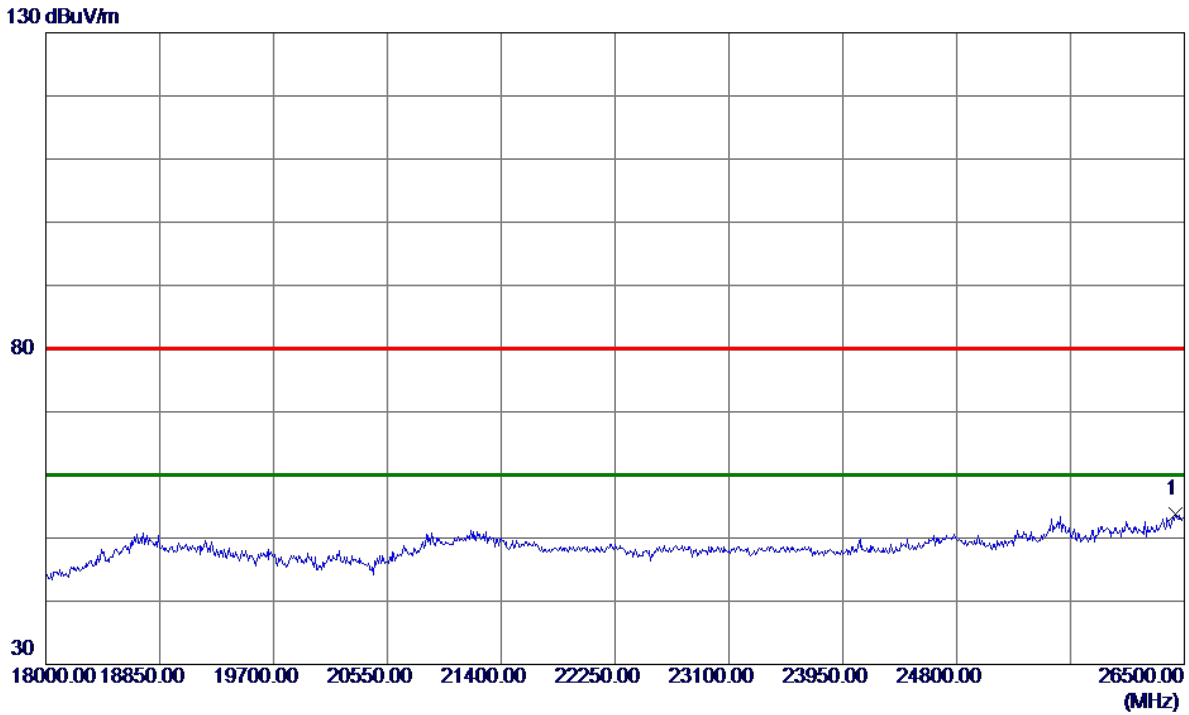

No.	Freq. MHz	Reading Level dBuV/m	Correct Factor dB	Measure ment dBuV/m	Limit dBuV/m	Margin dB	Detector	Comment
1 *	26432.0000	53.72	0.00	53.72	80.00	-26.28	Peak	

Test Mode : TX 2480MHz \_CH78\_1Mbps

Vertical

130 dBuV/m

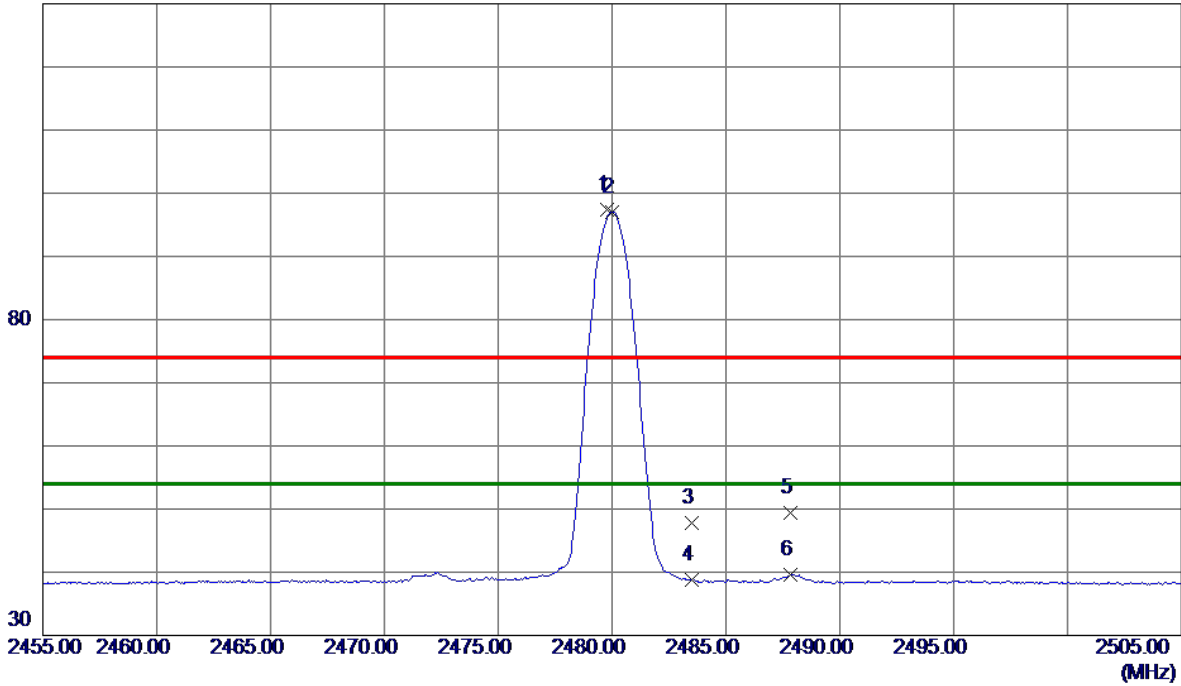

No.	Freq. MHz	Reading Level dBuV/m	Correct Factor dB	Measure ment dBuV/m	Limit dBuV/m	Margin dB	Detector	Comment
1	2479.8000	85.97	11.34	97.31	74.00	23.31	Peak	No Limit
2 *	2480.0000	85.68	11.34	97.02	54.00	43.02	AVG	No Limit
3	2483.5000	36.49	11.35	47.84	74.00	-26.16	Peak	
4	2483.5000	27.49	11.35	38.84	54.00	-15.16	AVG	
5	2487.8500	38.13	11.35	49.48	74.00	-24.52	Peak	
6	2487.8500	28.28	11.35	39.63	54.00	-14.37	AVG	

Test Mode : TX 2480MHz \_CH78\_1Mbps

**Vertical**

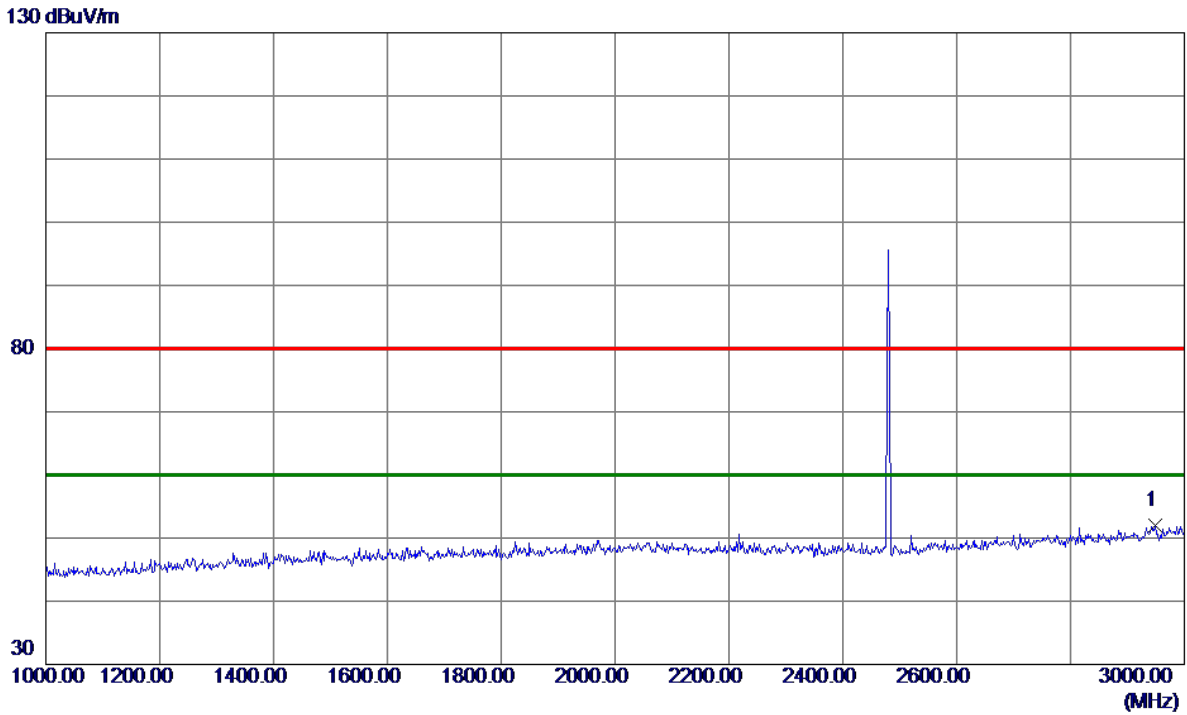

No.	Freq. MHz	Reading Level dBuV/m	Correct Factor dB	Measure ment dBuV/m	Limit dBuV/m	Margin dB	Detector	Comment
1 *	2948.0000	37.36	14.62	51.98	80.00	-28.02	Peak	

Test Mode : TX 2480MHz \_CH78\_1Mbps

Vertical

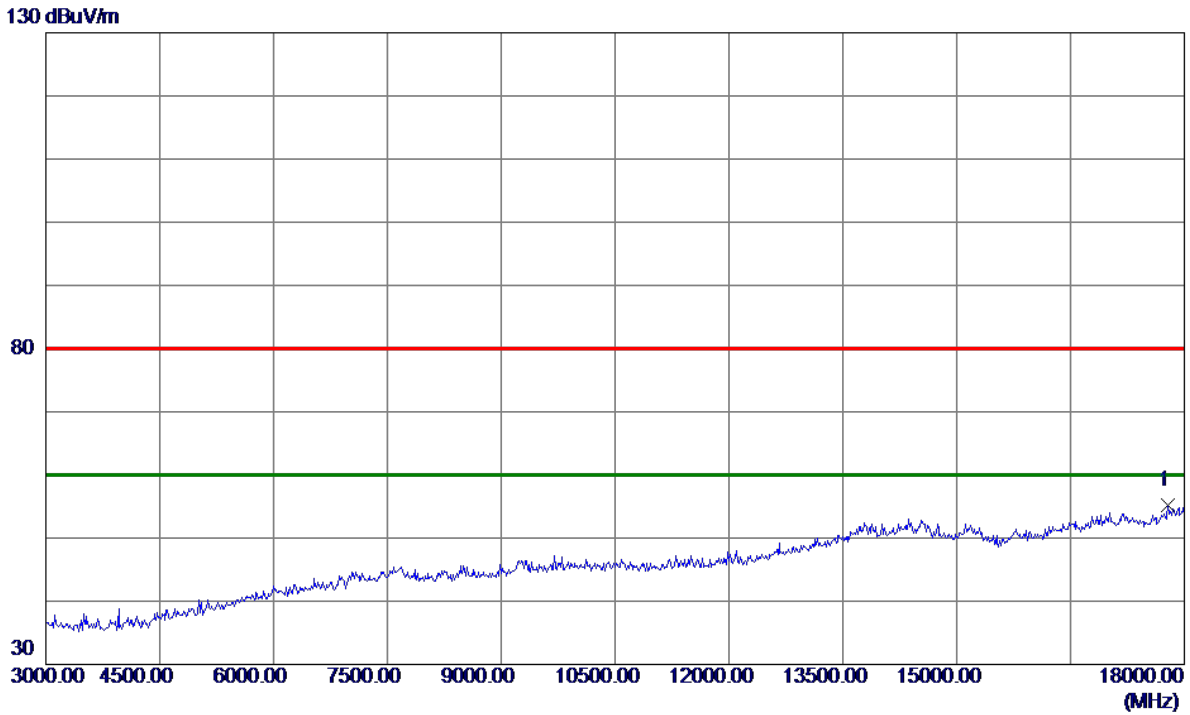

No.	Freq. MHz	Reading Level dBuV/m	Correct Factor dB	Measure ment dBuV/m	Limit dBuV/m	Margin dB	Detector	Comment
1 *	17790.0000	26.68	28.49	55.17	80.00	-24.83	Peak	



Test Mode : TX 2480MHz \_CH78\_1Mbps

Vertical

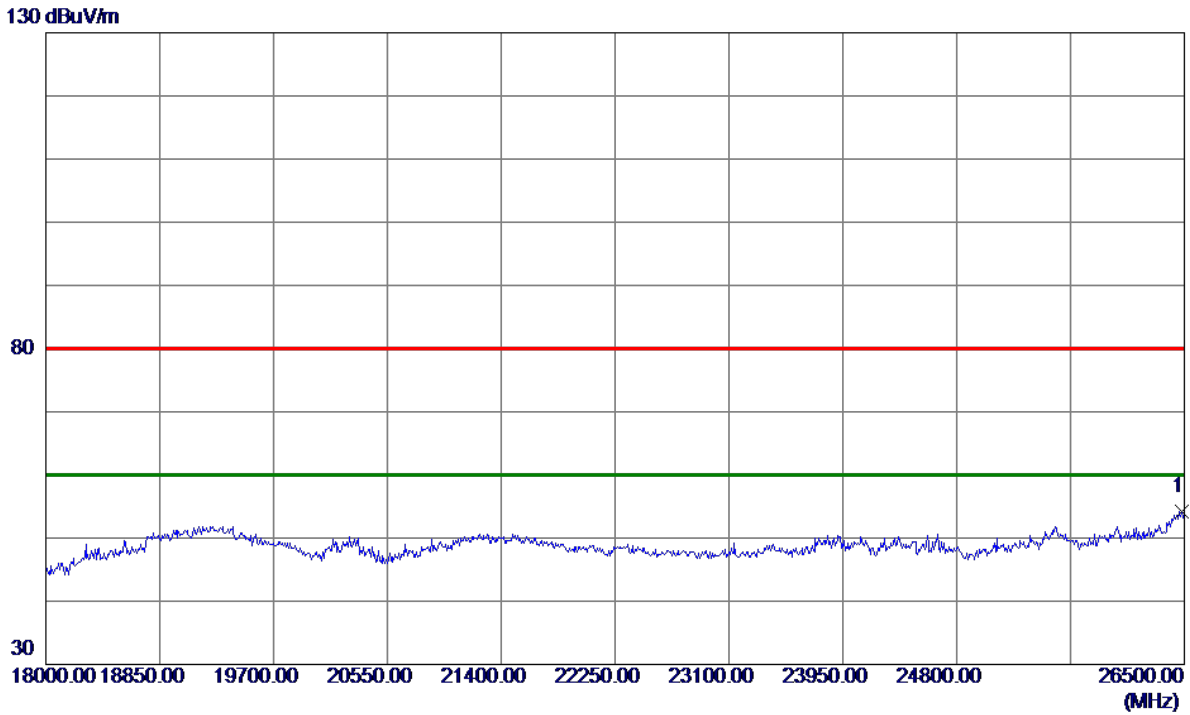

No.	Freq. MHz	Reading Level dBuV/m	Correct Factor dB	Measure ment dBuV/m	Limit dBuV/m	Margin dB	Detector	Comment
1 *	26483.0000	54.16	0.00	54.16	80.00	-25.84	Peak	

Test Mode : TX 2480MHz \_CH78\_1Mbps

Horizontal

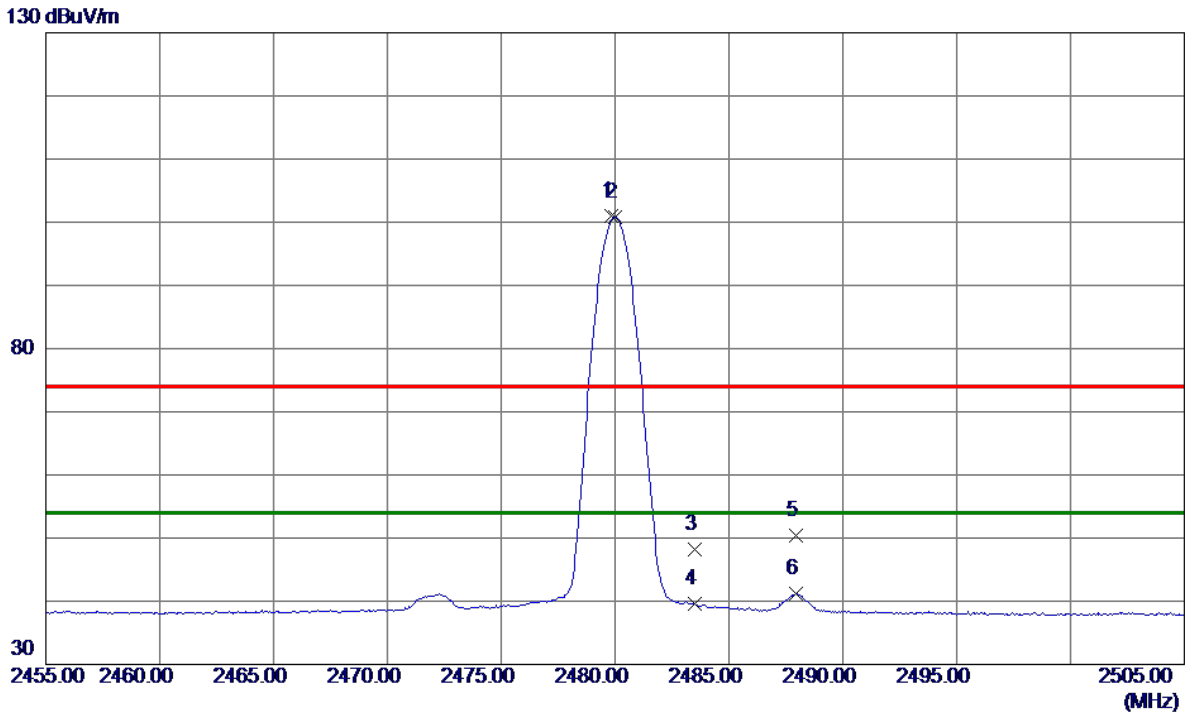

No.	Freq. MHz	Reading Level dBuV/m	Correct Factor dB	Measure ment dBuV/m	Limit dBuV/m	Margin dB	Detector	Comment
1	2479.8500	89.67	11.34	101.01	74.00	27.01	Peak	No Limit
2 *	2480.0000	89.40	11.34	100.74	54.00	46.74	AVG	No Limit
3	2483.5000	36.93	11.35	48.28	74.00	-25.72	Peak	
4	2483.5000	28.28	11.35	39.63	54.00	-14.37	AVG	
5	2487.9500	39.06	11.35	50.41	74.00	-23.59	Peak	
6	2487.9500	29.81	11.35	41.16	54.00	-12.84	AVG	

Test Mode : TX 2480MHz \_CH78\_1Mbps

Horizontal

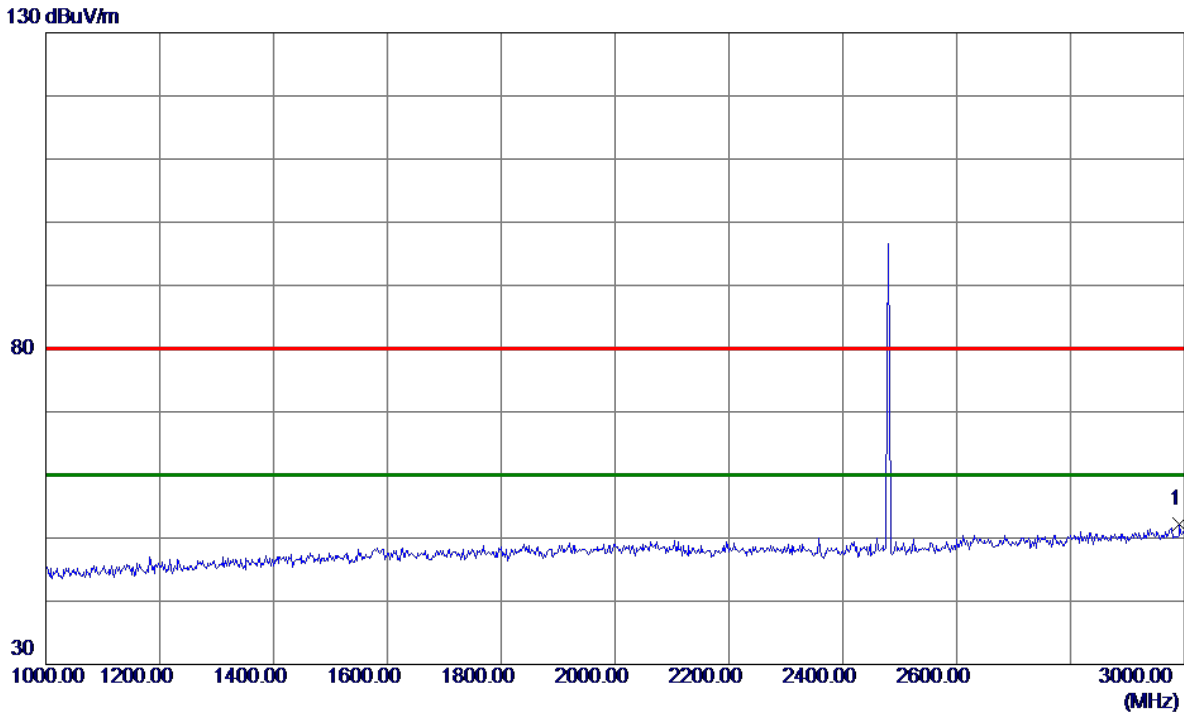

No.	Freq.	Reading Level	Correct Factor	Measurement	Limit	Margin	Detector	Comment
	MHz	dBuV/m	dB	dBuV/m	dBuV/m	dB		
1 *	2992.0000	37.19	14.94	52.13	80.00	-27.87	Peak	

Test Mode : TX 2480MHz \_CH78\_1Mbps

Horizontal

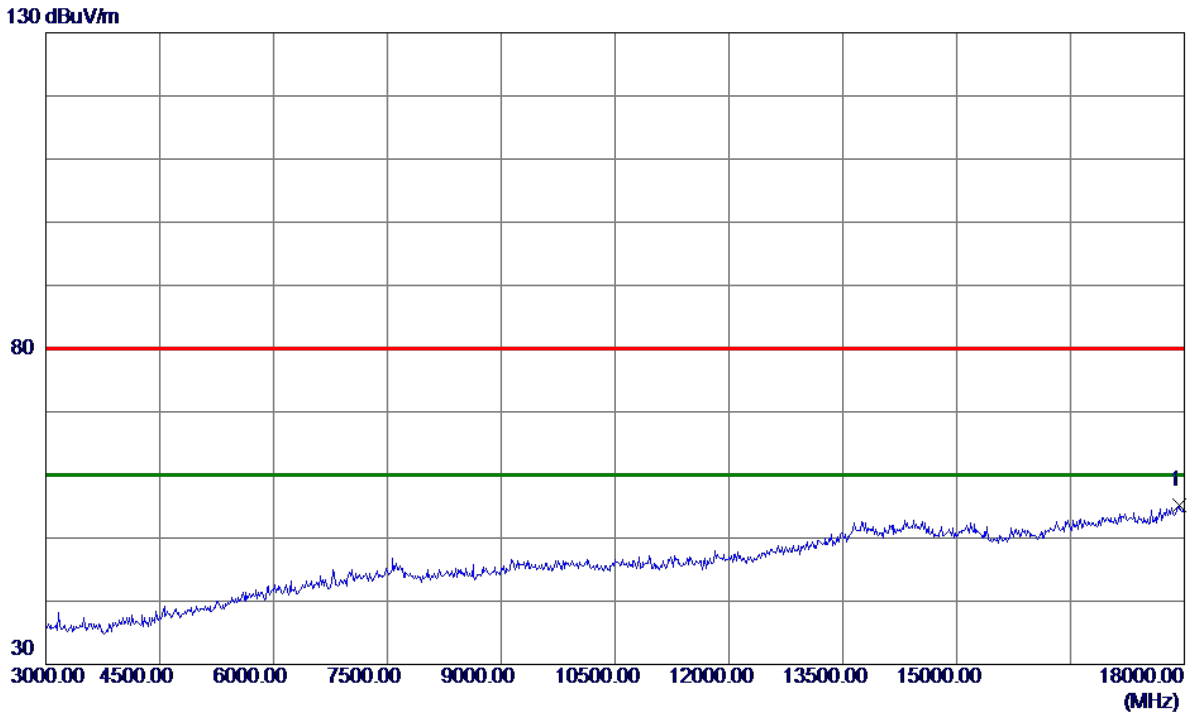

No.	Freq. MHz	Reading Level dBuV/m	Correct Factor dB	Measure ment dBuV/m	Limit dBuV/m	Margin dB	Detector	Comment
1 *	17940.0000	26.16	28.97	55.13	80.00	-24.87	Peak	

Test Mode : TX 2480MHz \_CH78\_1Mbps

Horizontal

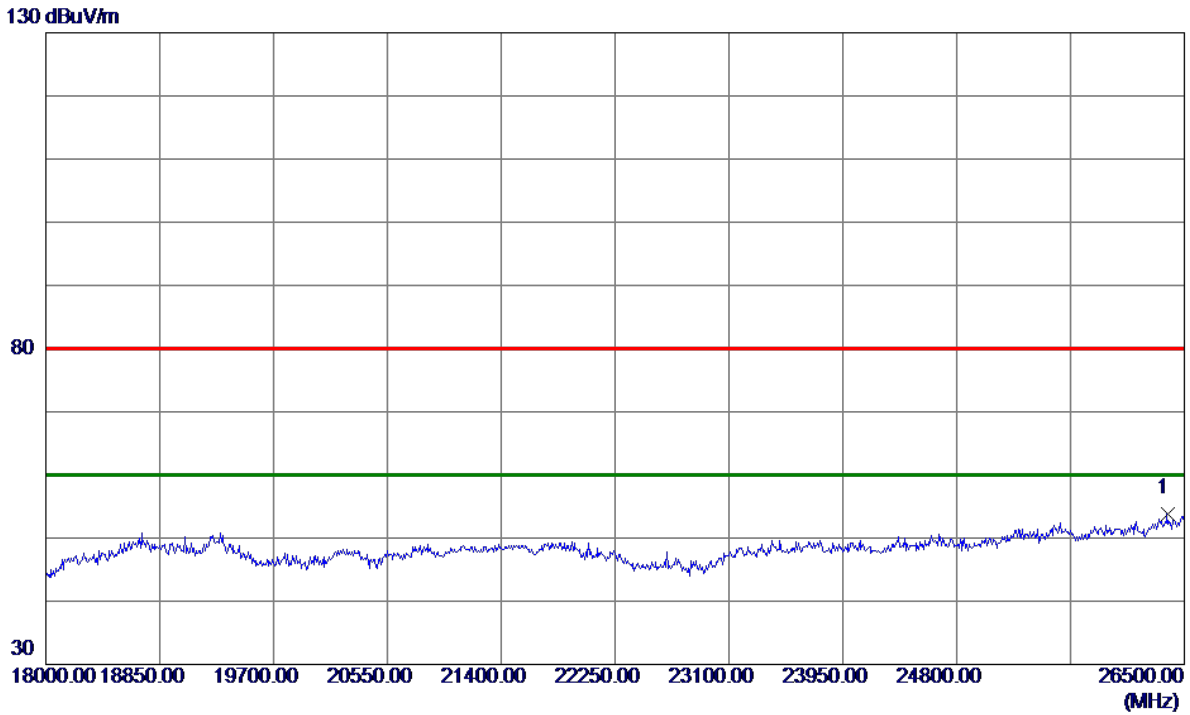

No.	Freq. MHz	Reading Level dBuV/m	Correct Factor dB	Measure ment dBuV/m	Limit dBuV/m	Margin dB	Detector	Comment
1 *	26372.5000	53.90	0.00	53.90	80.00	-26.10	Peak	

Test Mode : TX 2402MHz \_CH00\_3Mbps

Vertical

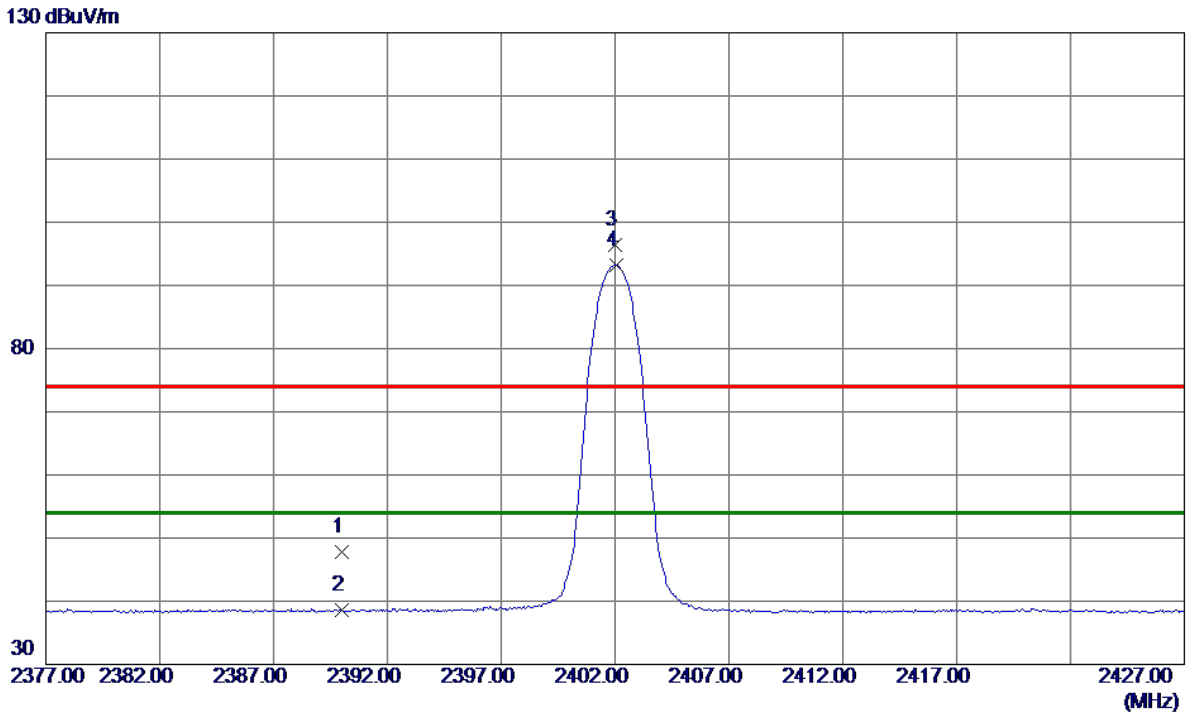

No.	Freq. MHz	Reading Level dBuV/m	Correct Factor dB	Measure ment dBuV/m	Limit dBuV/m	Margin dB	Detector	Comment
1	2390.0000	36.46	11.32	47.78	74.00	-26.22	Peak	
2	2390.0000	27.26	11.32	38.58	54.00	-15.42	AVG	
3	2402.0000	85.10	11.32	96.42	74.00	22.42	Peak	No Limit
4 *	2402.0500	81.84	11.32	93.16	54.00	39.16	AVG	No Limit

Test Mode : TX 2402MHz \_CH00\_3Mbps

Vertical

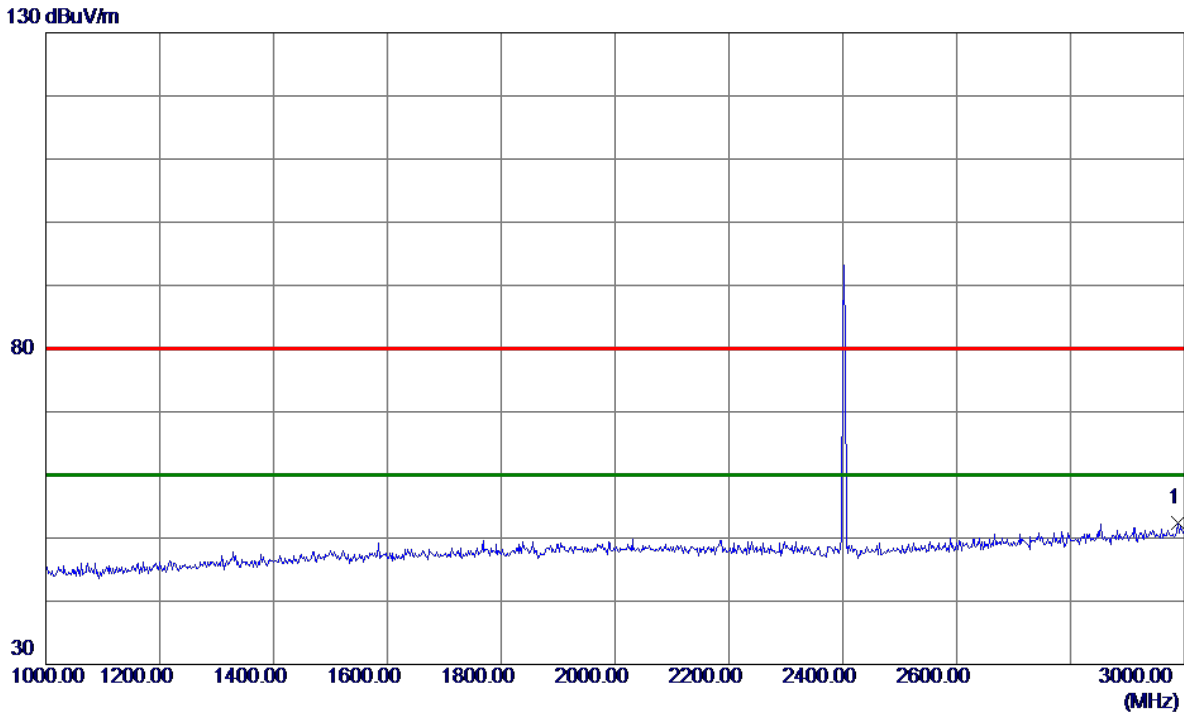

No.	Freq. MHz	Reading Level dBuV/m	Correct Factor dB	Measure ment dBuV/m	Limit dBuV/m	Margin dB	Detector	Comment
1 *	2988.0000	37.58	14.91	52.49	80.00	-27.51	Peak	

Test Mode : TX 2402MHz \_CH00\_3Mbps

Vertical

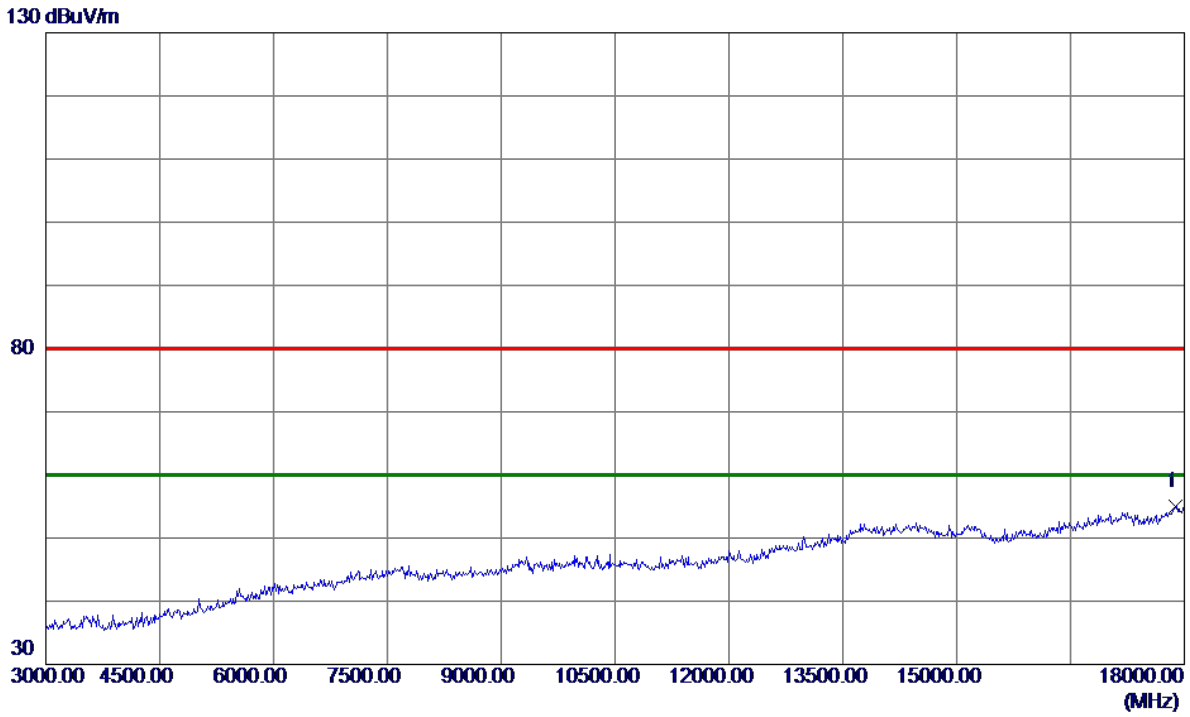

No.	Freq. MHz	Reading Level dBuV/m	Correct Factor dB	Measure ment dBuV/m	Limit dBuV/m	Margin dB	Detector	Comment
1 *	17880.0000	26.32	28.77	55.09	80.00	-24.91	Peak	



Test Mode : TX 2402MHz \_CH00\_3Mbps

Vertical

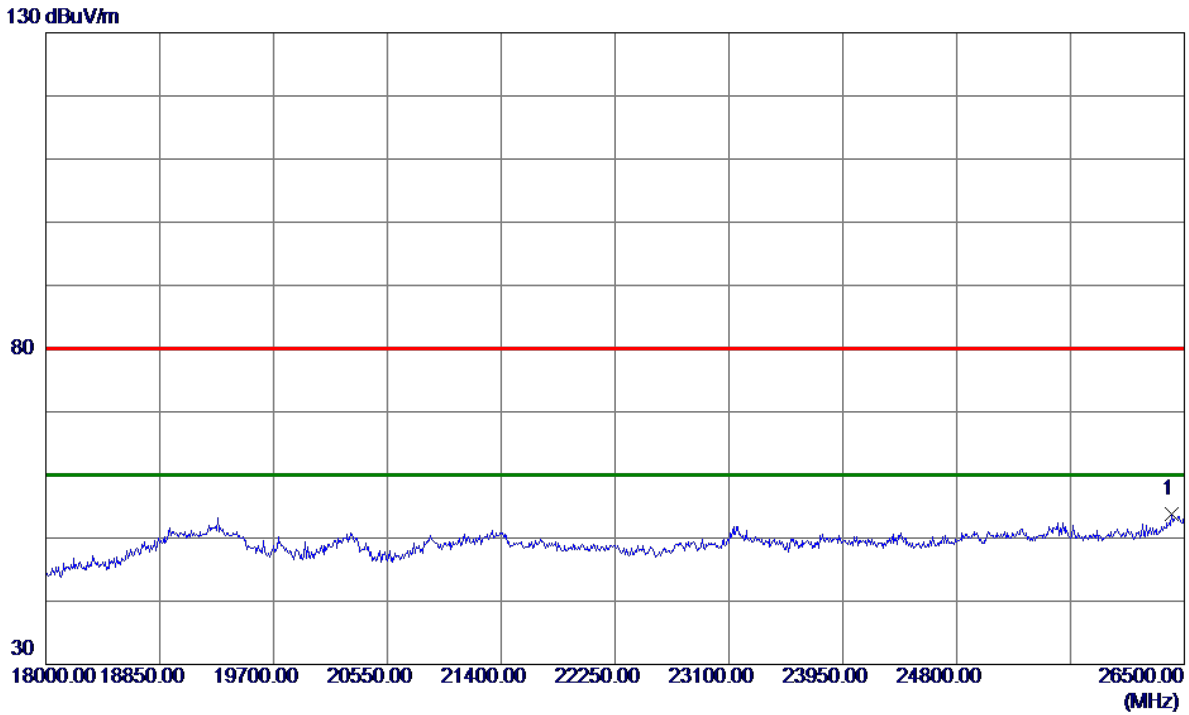

No.	Freq. MHz	Reading Level dBuV/m	Correct Factor dB	Measure ment dBuV/m	Limit dBuV/m	Margin dB	Detector	Comment
1 *	26406.5000	53.81	0.00	53.81	80.00	-26.19	Peak	

Test Mode : TX 2402MHz \_CH00\_3Mbps

Horizontal

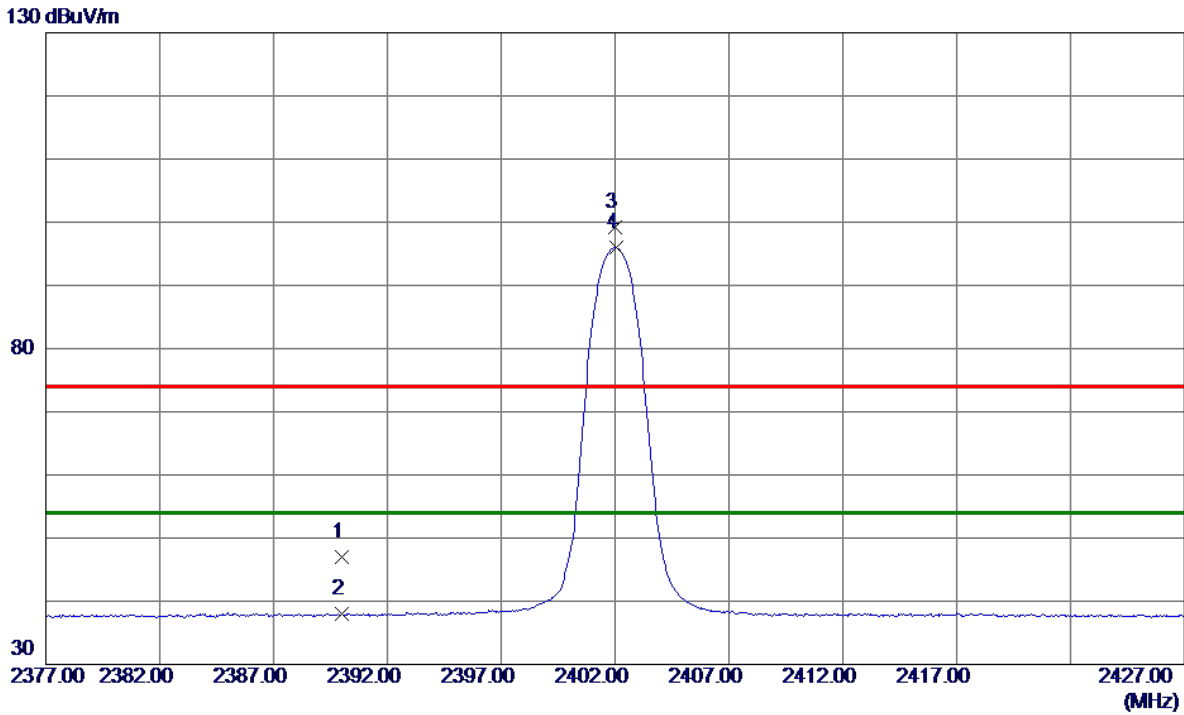

No.	Freq. MHz	Reading Level dBuV/m	Correct Factor dB	Measure ment dBuV/m	Limit dBuV/m	Margin dB	Detector	Comment
1	2390.0000	35.77	11.32	47.09	74.00	-26.91	Peak	
2	2390.0000	26.61	11.32	37.93	54.00	-16.07	AVG	
3	2402.0000	87.93	11.32	99.25	74.00	25.25	Peak	No Limit
4 *	2402.0500	84.60	11.32	95.92	54.00	41.92	AVG	No Limit

Test Mode : TX 2402MHz \_CH00\_3Mbps

**Horizontal**

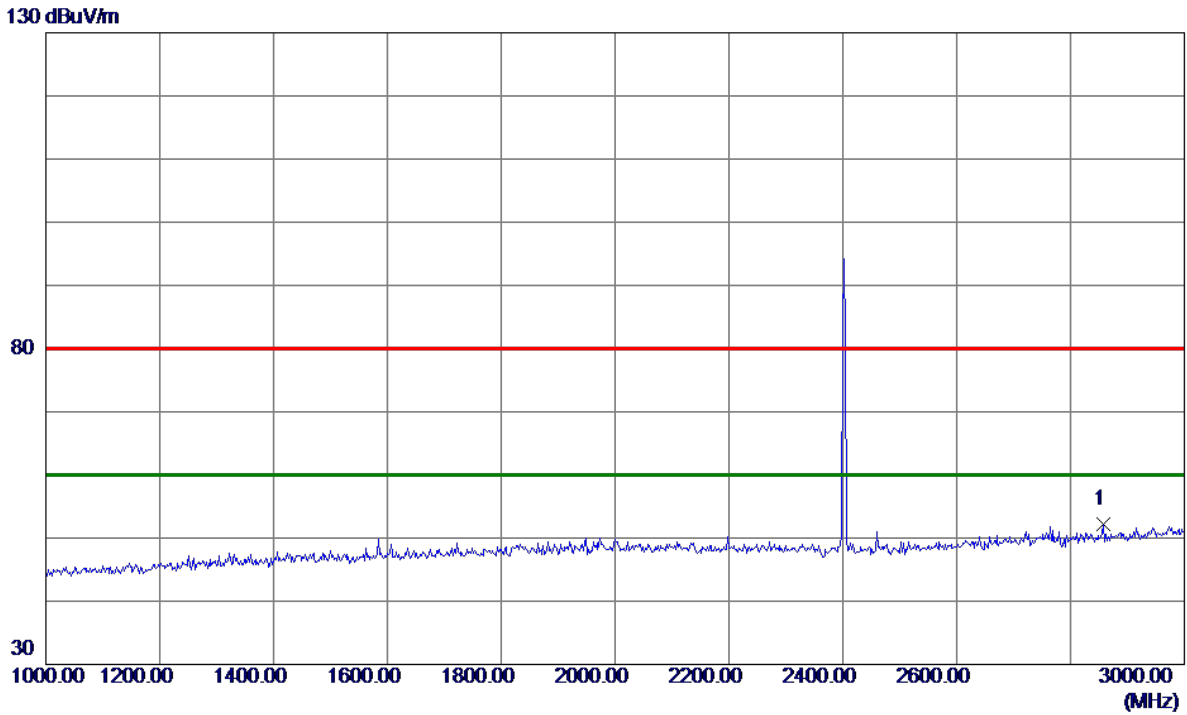

No.	Freq. MHz	Reading Level dBuV/m	Correct Factor dB	Measure ment dBuV/m	Limit dBuV/m	Margin dB	Detector	Comment
1 *	2858.0000	38.24	13.96	52.20	80.00	-27.80	Peak	

Test Mode : TX 2402MHz \_CH00\_3Mbps

Horizontal

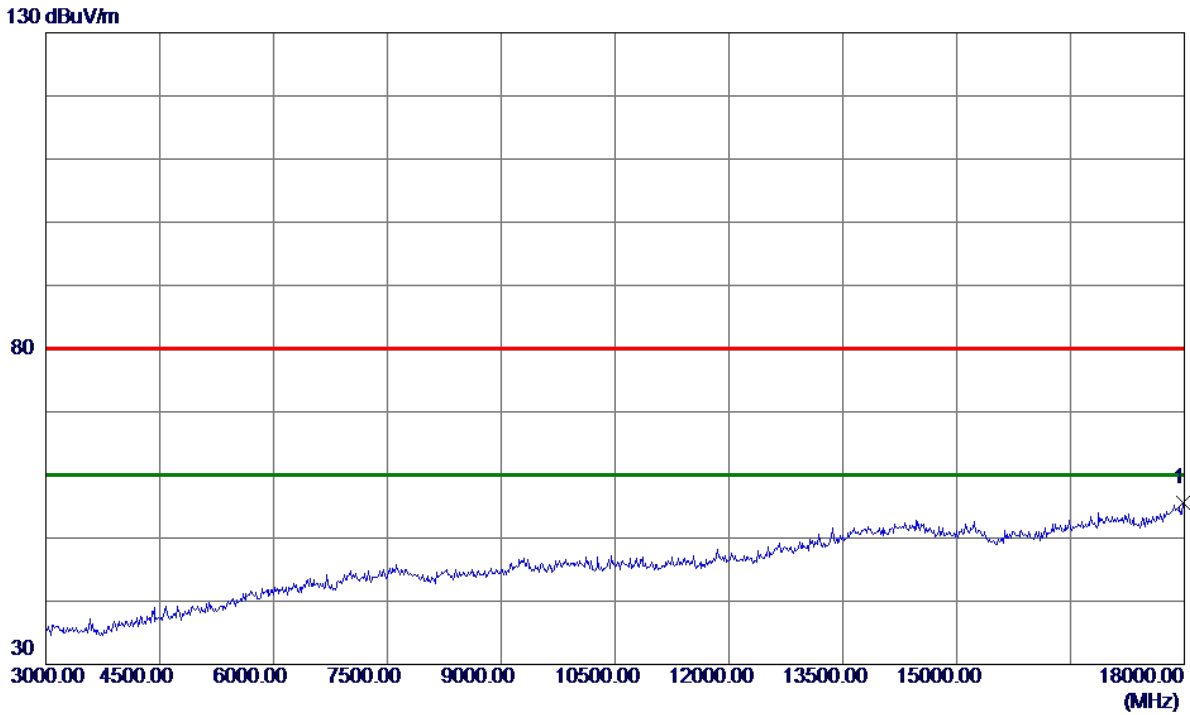

No.	Freq. MHz	Reading Level dBuV/m	Correct Factor dB	Measure ment dBuV/m	Limit dBuV/m	Margin dB	Detector	Comment
1 *	17985.0000	26.41	29.11	55.52	80.00	-24.48	Peak	

Test Mode : TX 2402MHz \_CH00\_3Mbps

Horizontal

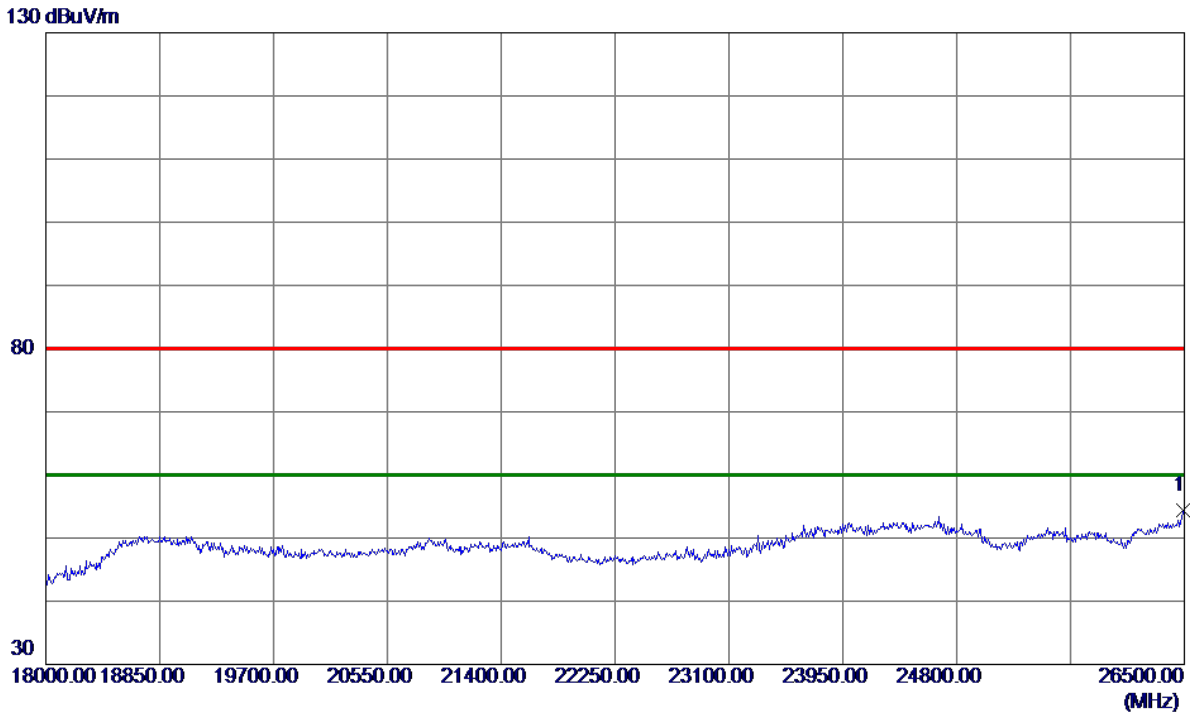

No.	Freq. MHz	Reading Level dBuV/m	Correct Factor dB	Measure ment dBuV/m	Limit dBuV/m	Margin dB	Detector	Comment
1 *	26491.5000	54.42	0.00	54.42	80.00	-25.58	Peak	

Test Mode : TX 2441MHz \_CH39\_3Mbps

**Vertical**

130 dBuV/m

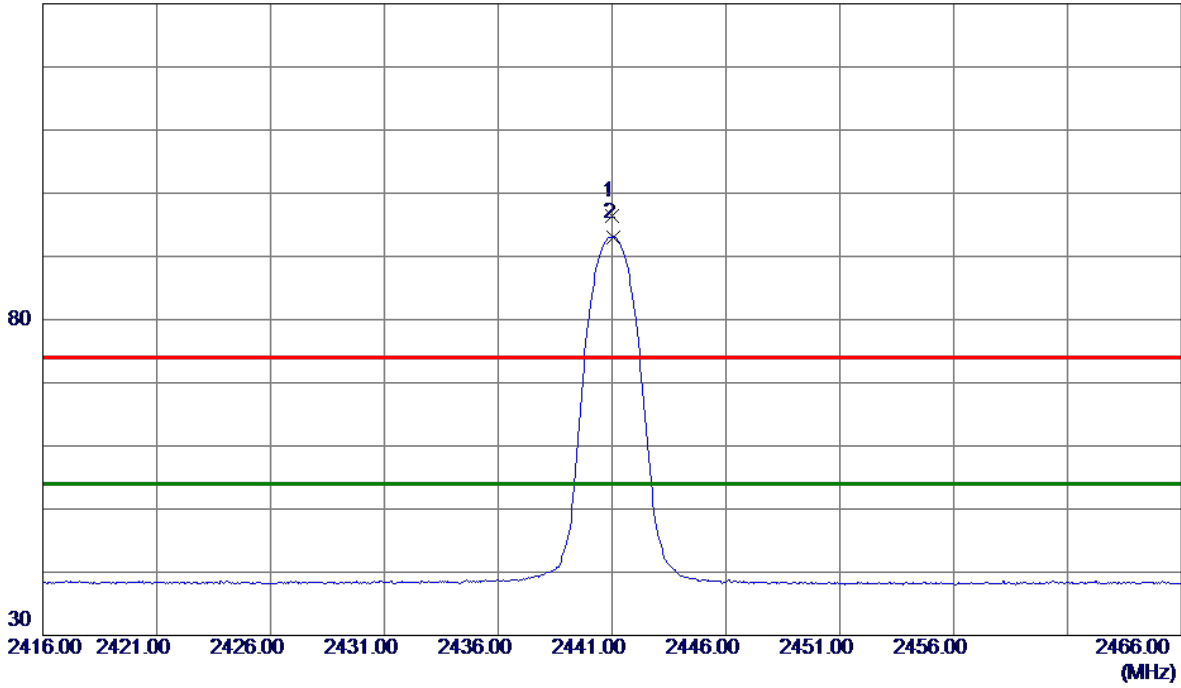

No.	Freq. MHz	Reading Level dBuV/m	Correct Factor dB	Measure ment dBuV/m	Limit dBuV/m	Margin dB	Detector	Comment
1	2441.0000	85.00	11.33	96.33	74.00	22.33	Peak	No Limit
2 *	2441.0500	81.77	11.33	93.10	54.00	39.10	AVG	No Limit

Test Mode : TX 2441MHz \_CH39\_3Mbps

**Vertical**

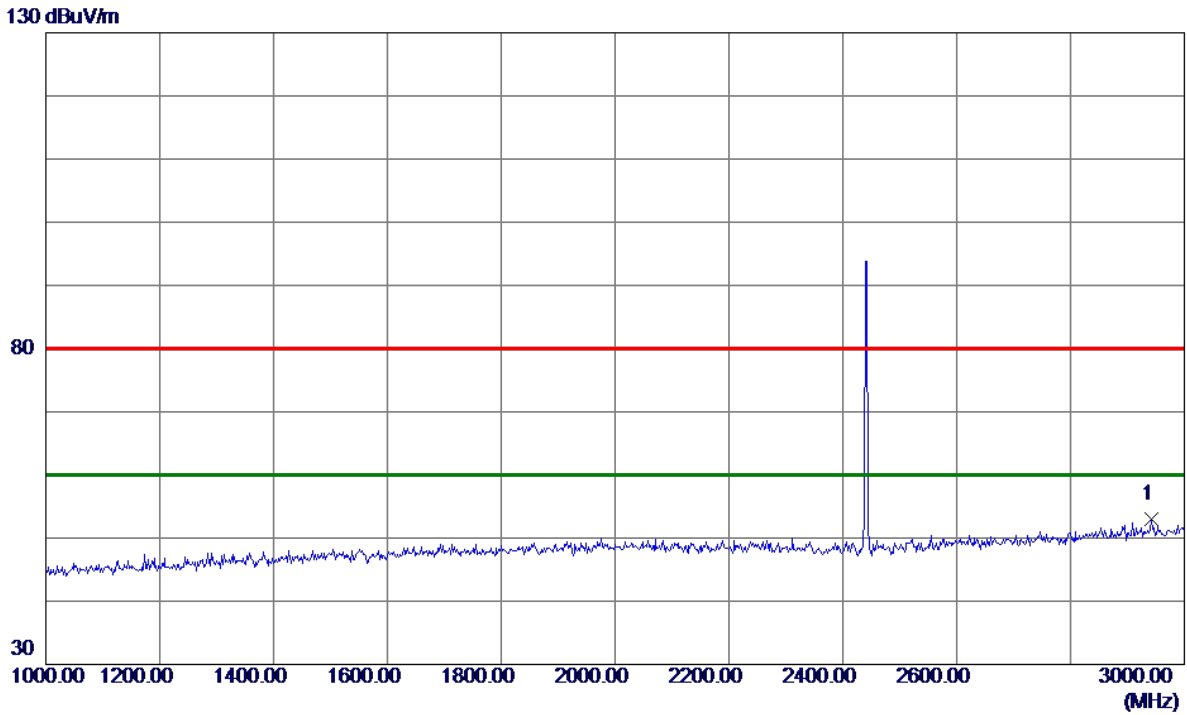

No.	Freq.	Reading Level	Correct Factor	Measurement	Limit	Margin	Detector	Comment
	MHz	dBuV/m	dB	dBuV/m	dBuV/m	dB		
1 *	2942.0000	38.33	14.58	52.91	80.00	-27.09	Peak	

Test Mode : TX 2441MHz \_CH39\_3Mbps

**Vertical**

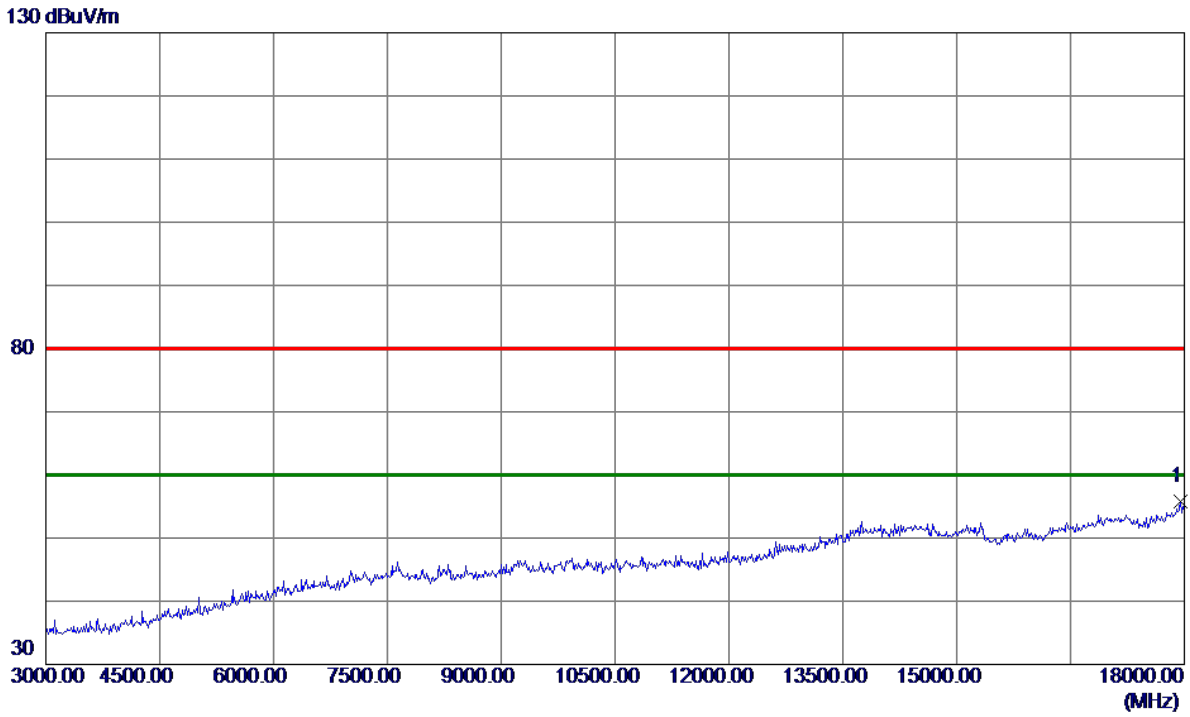

No.	Freq. MHz	Reading Level dBuV/m	Correct Factor dB	Measure ment dBuV/m	Limit dBuV/m	Margin dB	Detector	Comment
1 *	17955.0000	26.86	29.02	55.88	80.00	-24.12	Peak	



Test Mode : TX 2441MHz \_CH39\_3Mbps

**Vertical**

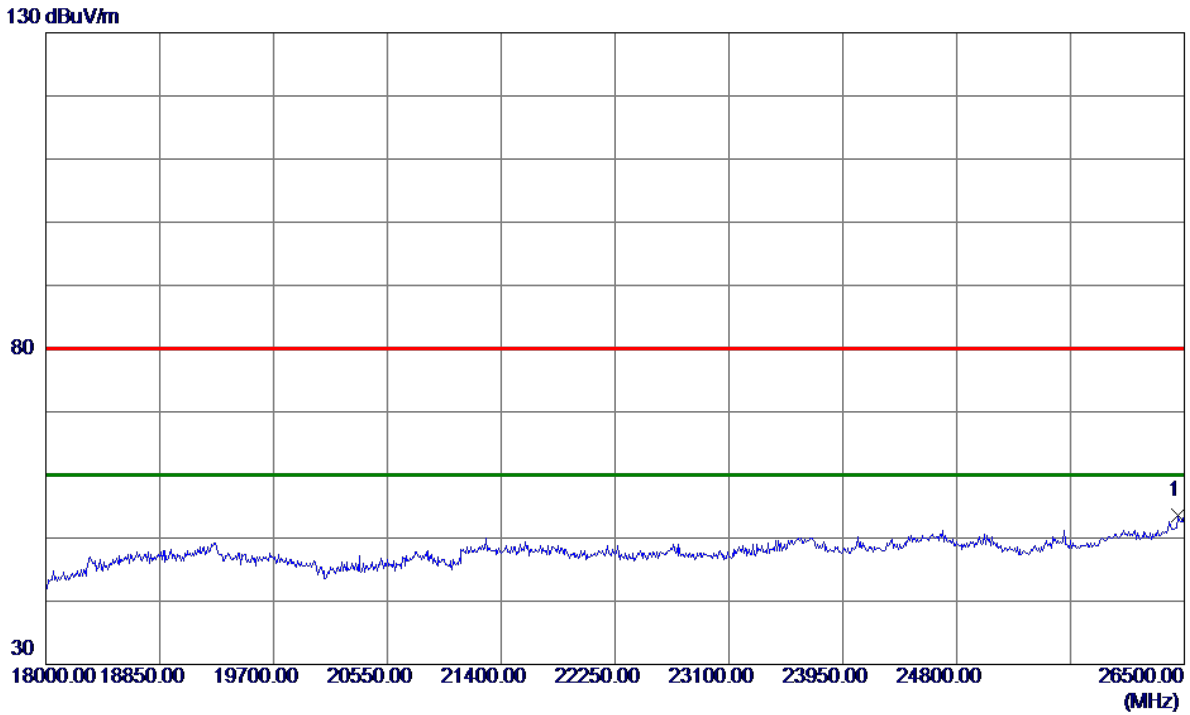

No.	Freq. MHz	Reading Level dBuV/m	Correct Factor dB	Measure ment dBuV/m	Limit dBuV/m	Margin dB	Detector	Comment
1 *	26449.0000	53.55	0.00	53.55	80.00	-26.45	Peak	

Test Mode : TX 2441MHz \_CH39\_3Mbps

Horizontal

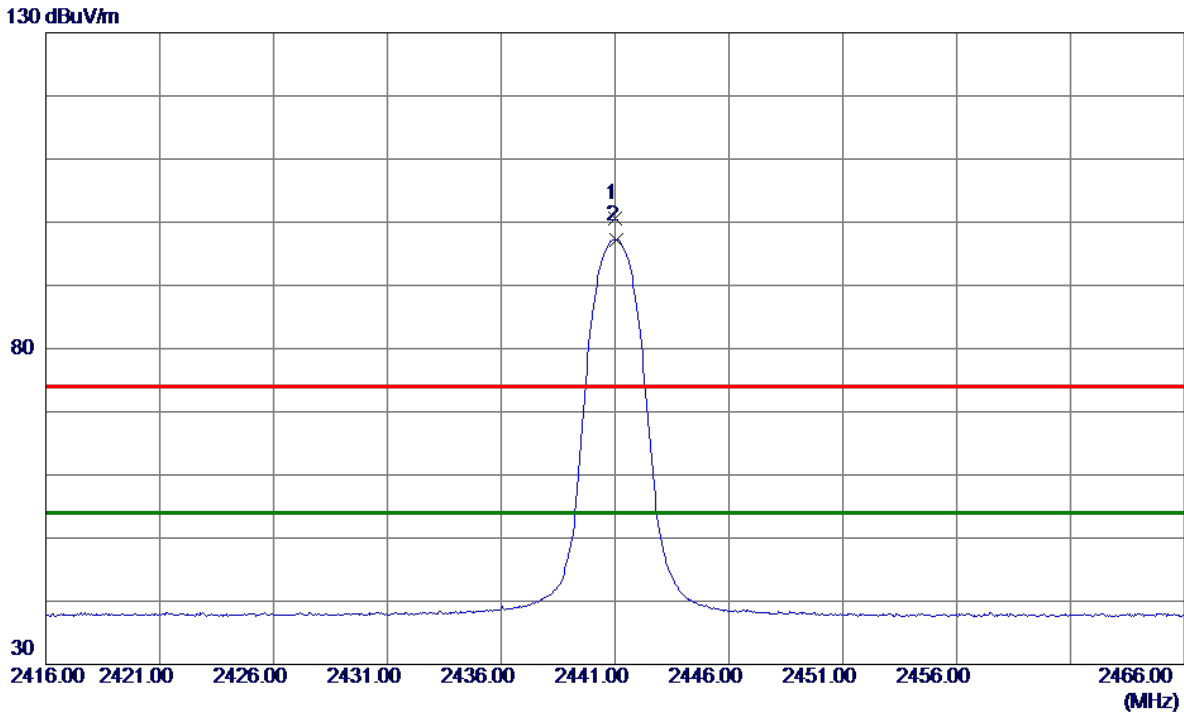

No.	Freq. MHz	Reading Level dBuV/m	Correct Factor dB	Measure ment dBuV/m	Limit dBuV/m	Margin dB	Detector	Comment
1	2441.0000	89.19	11.33	100.52	74.00	26.52	Peak	No Limit
2 *	2441.0500	85.91	11.33	97.24	54.00	43.24	AVG	No Limit

Test Mode : TX 2441MHz \_CH39\_3Mbps

Horizontal

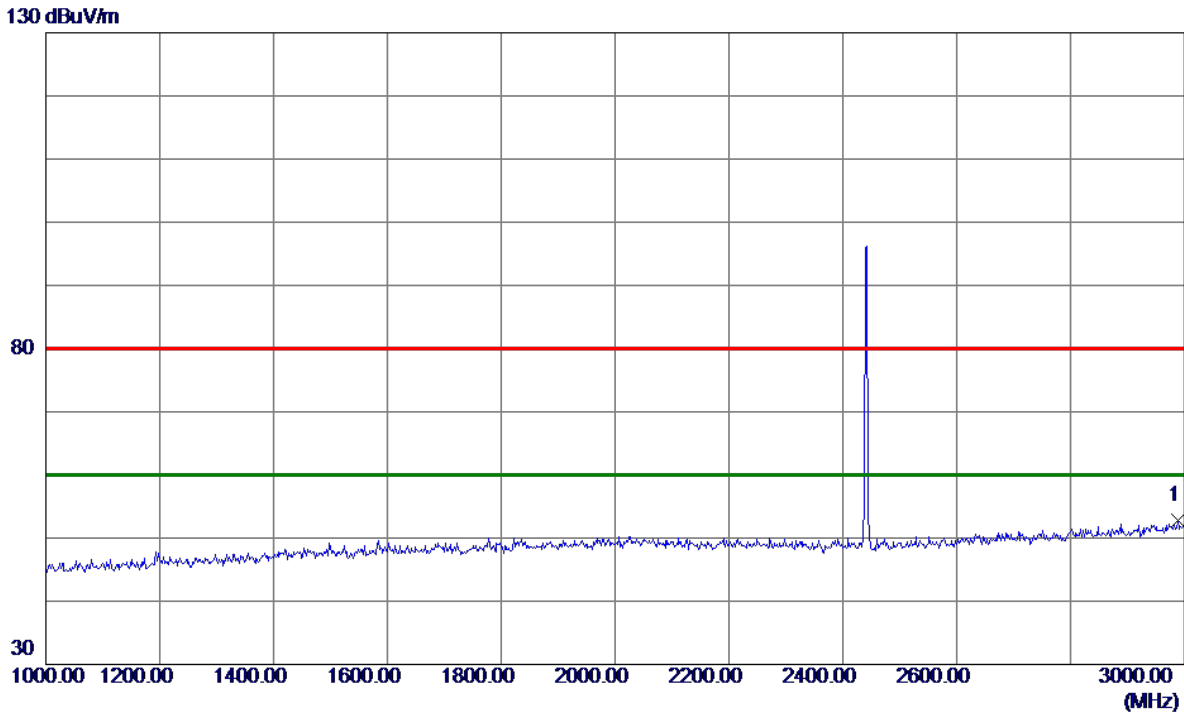

No.	Freq. MHz	Reading Level dBuV/m	Correct Factor dB	Measure ment dBuV/m	Limit dBuV/m	Margin dB	Detector	Comment
1 *	2988.0000	37.94	14.91	52.85	80.00	-27.15	Peak	

Test Mode : TX 2441MHz \_CH39\_3Mbps

Horizontal

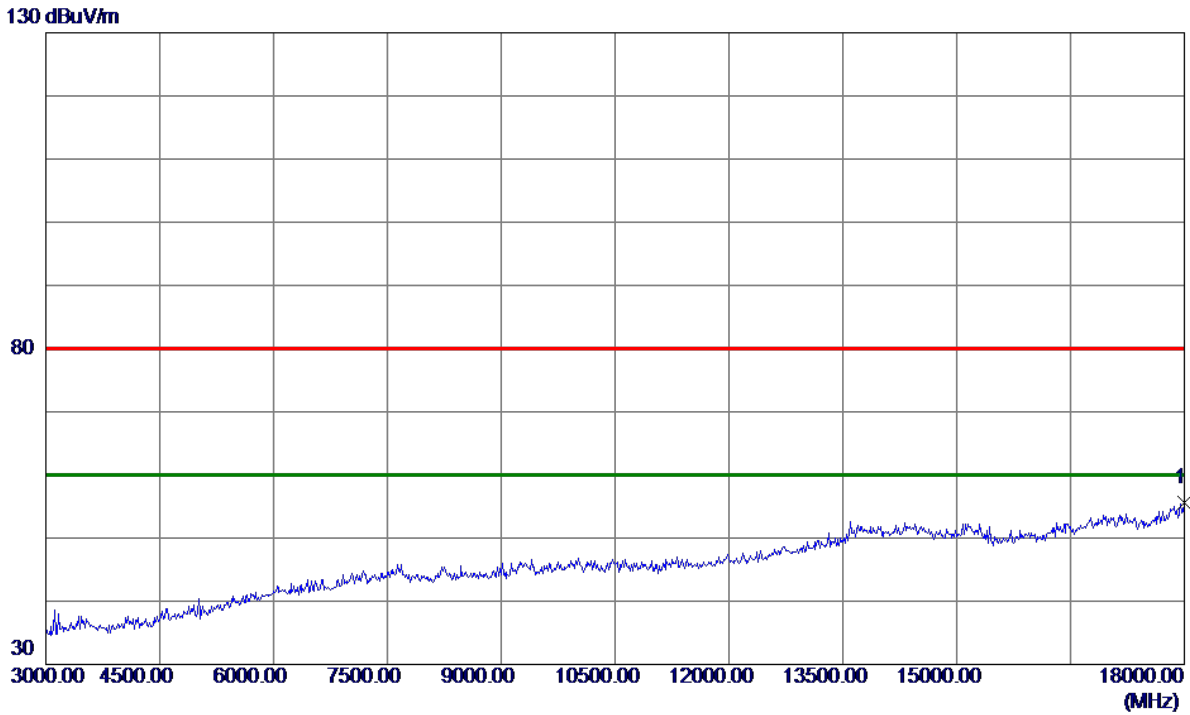

No.	Freq.	Reading Level	Correct Factor	Measurement	Limit	Margin	Detector	Comment
	MHz	dBuV/m	dB	dBuV/m	dBuV/m	dB		
1 *	18000.0000	26.36	29.16	55.52	80.00	-24.48	Peak	

Test Mode : TX 2441MHz \_CH39\_3Mbps

Horizontal

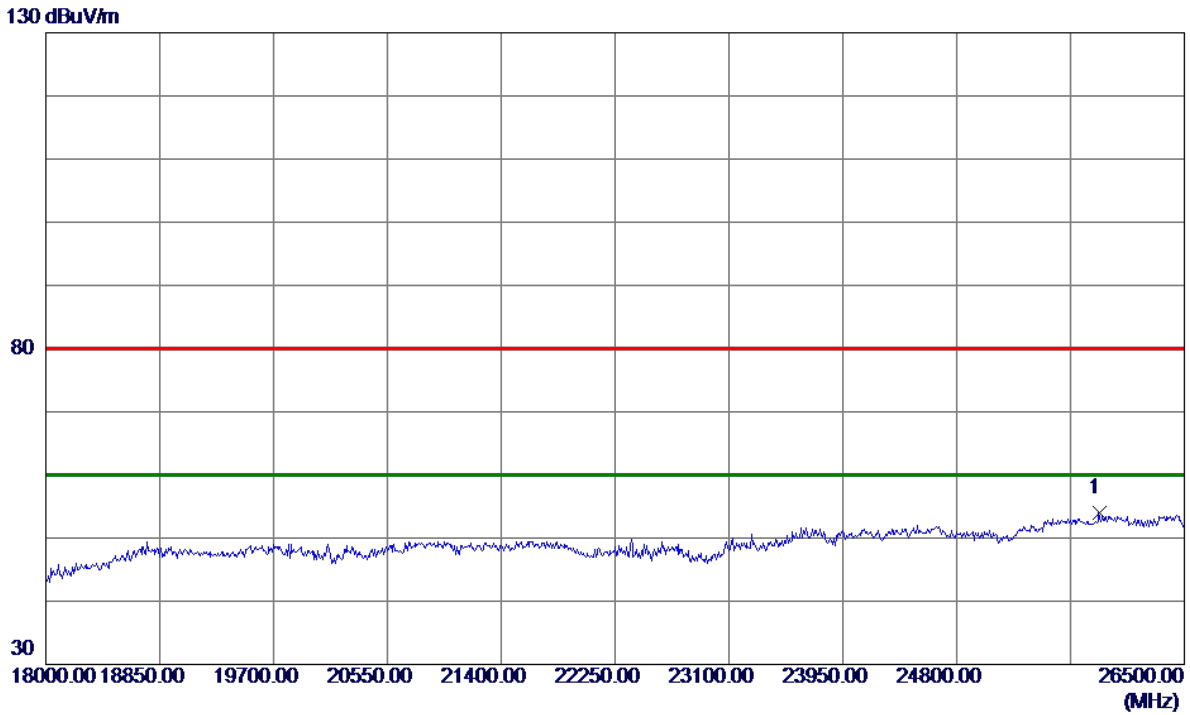

No.	Freq. MHz	Reading Level dBuV/m	Correct Factor dB	Measure ment dBuV/m	Limit dBuV/m	Margin dB	Detector	Comment
1 *	25862.5000	87.06	-33.10	53.96	80.00	-26.04	Peak	

Test Mode : TX 2480MHz \_CH78\_3Mbps

**Vertical**

130 dBuV/m

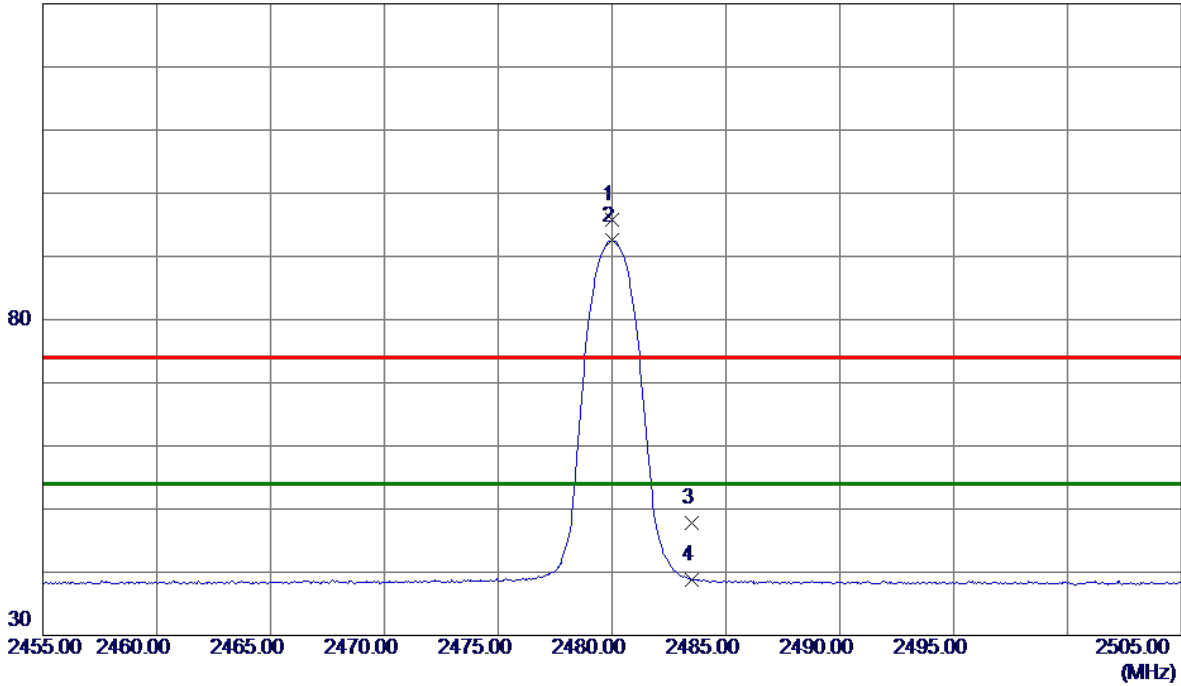

No.	Freq. MHz	Reading Level dBuV/m	Correct Factor dB	Measure ment dBuV/m	Limit dBuV/m	Margin dB	Detector	Comment
1	2480.0000	84.42	11.34	95.76	74.00	21.76	Peak	No Limit
2 *	2480.0000	81.16	11.34	92.50	54.00	38.50	AVG	No Limit
3	2483.5000	36.53	11.35	47.88	74.00	-26.12	Peak	
4	2483.5000	27.37	11.35	38.72	54.00	-15.28	AVG	

Test Mode : TX 2480MHz \_CH78\_3Mbps

Vertical

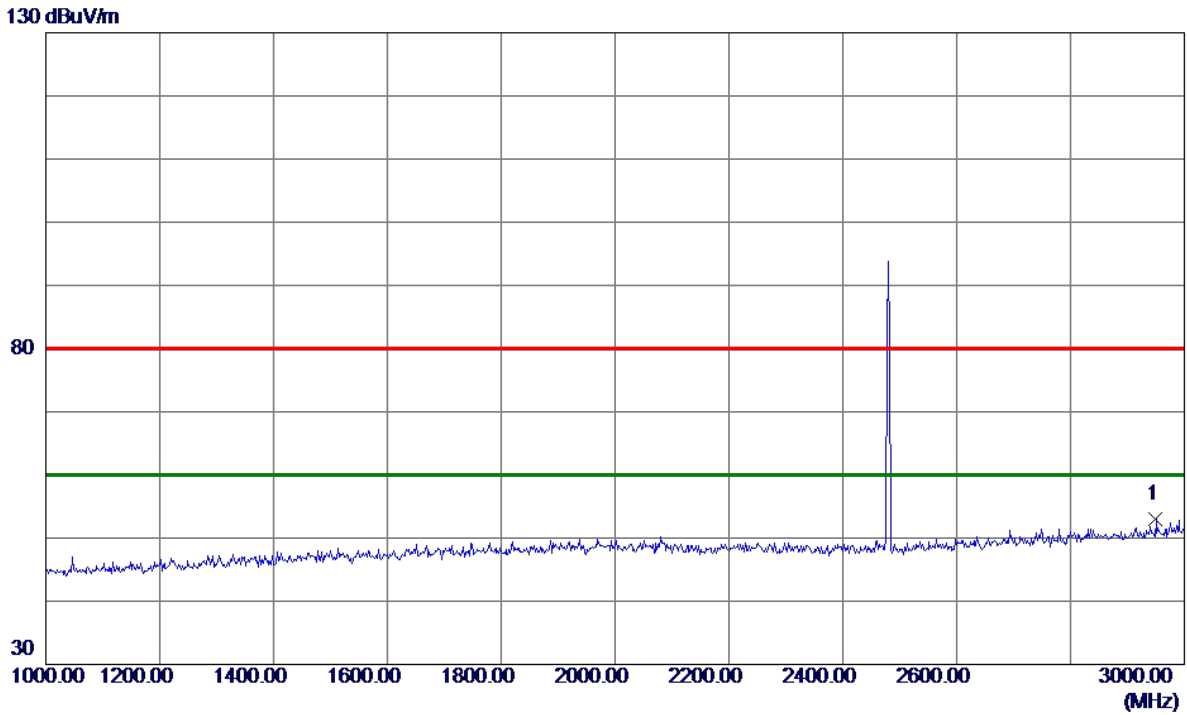

No.	Freq.	Reading Level	Correct Factor	Measurement	Limit	Margin	Detector	Comment
	MHz	dBuV/m	dB	dBuV/m	dBuV/m	dB		
1 *	2950.0000	38.43	14.64	53.07	80.00	-26.93	Peak	

Test Mode : TX 2480MHz \_CH78\_3Mbps

**Vertical**

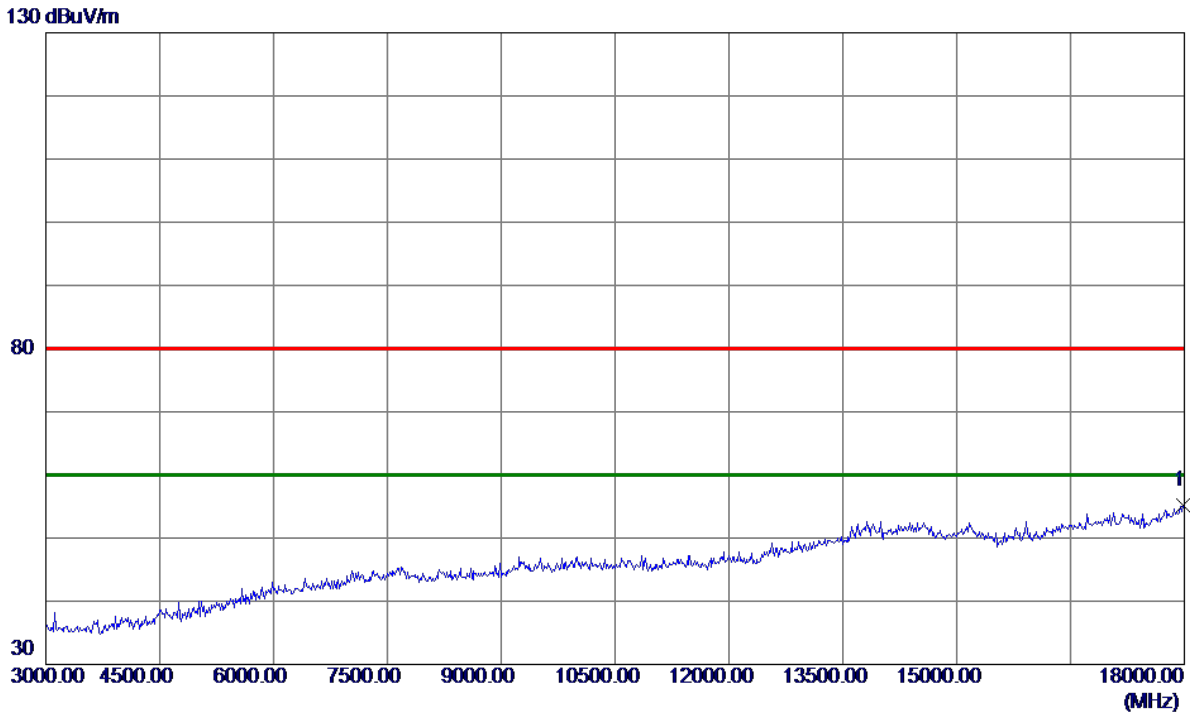

No.	Freq. MHz	Reading Level dBuV/m	Correct Factor dB	Measure ment dBuV/m	Limit dBuV/m	Margin dB	Detector	Comment
1 *	17985.0000	26.11	29.11	55.22	80.00	-24.78	Peak	



Test Mode : TX 2480MHz \_CH78\_3Mbps

Vertical

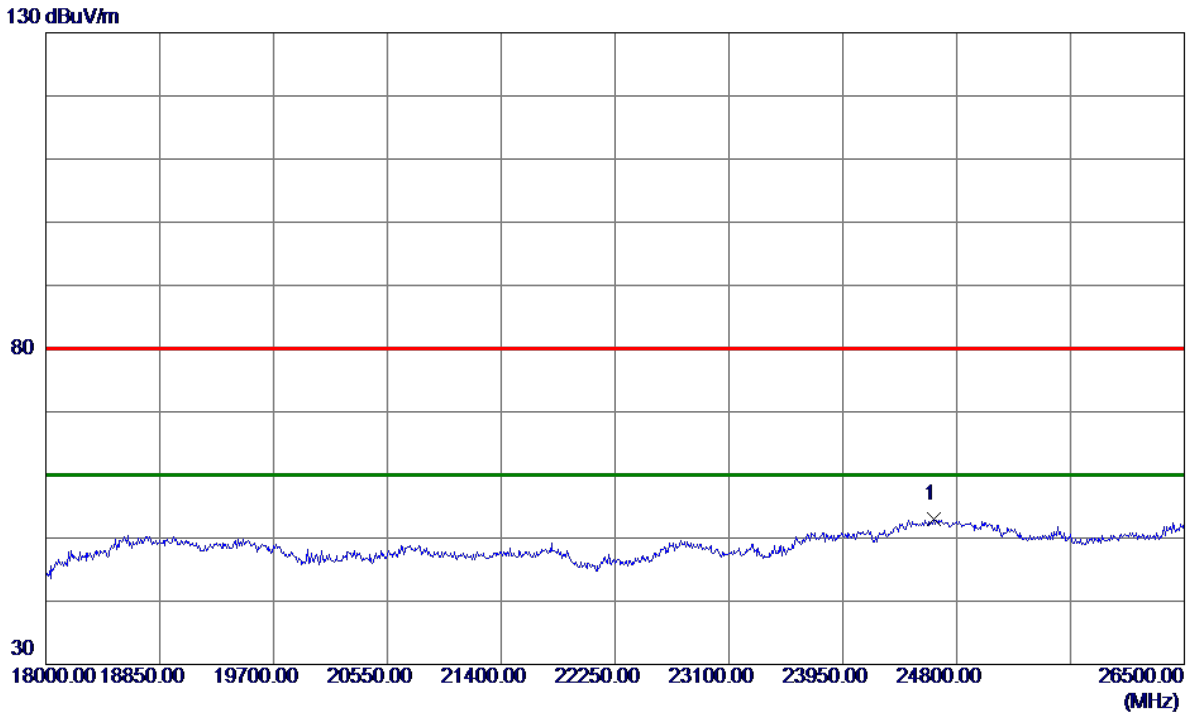

No.	Freq. MHz	Reading Level dBuV/m	Correct Factor dB	Measure ment dBuV/m	Limit dBuV/m	Margin dB	Detector	Comment
1 *	24630.0000	86.01	-33.10	52.91	80.00	-27.09	Peak	

Test Mode : TX 2480MHz \_CH78\_3Mbps

**Horizontal**

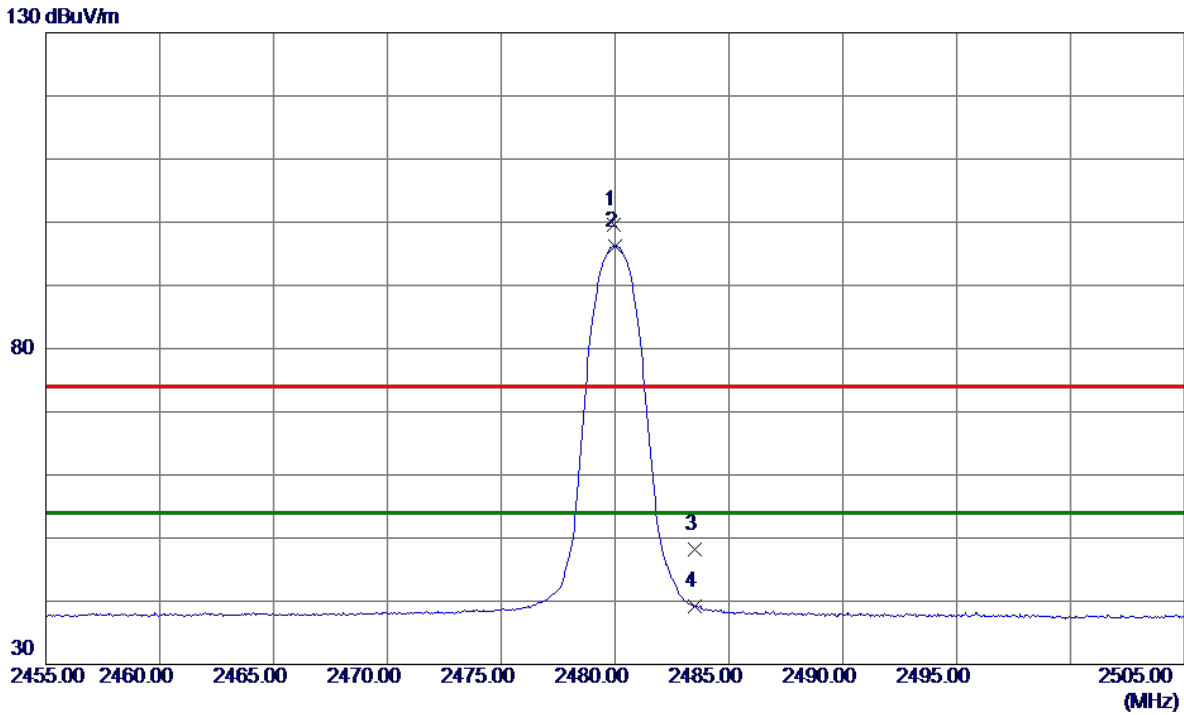

No.	Freq. MHz	Reading Level dBuV/m	Correct Factor dB	Measure ment dBuV/m	Limit dBuV/m	Margin dB	Detector	Comment
1	2479.9500	88.21	11.34	99.55	74.00	25.55	Peak	No Limit
2 *	2480.0000	84.88	11.34	96.22	54.00	42.22	AVG	No Limit
3	2483.5000	36.92	11.35	48.27	74.00	-25.73	Peak	
4	2483.5000	27.82	11.35	39.17	54.00	-14.83	AVG	

Test Mode : TX 2480MHz \_CH78\_3Mbps

Horizontal

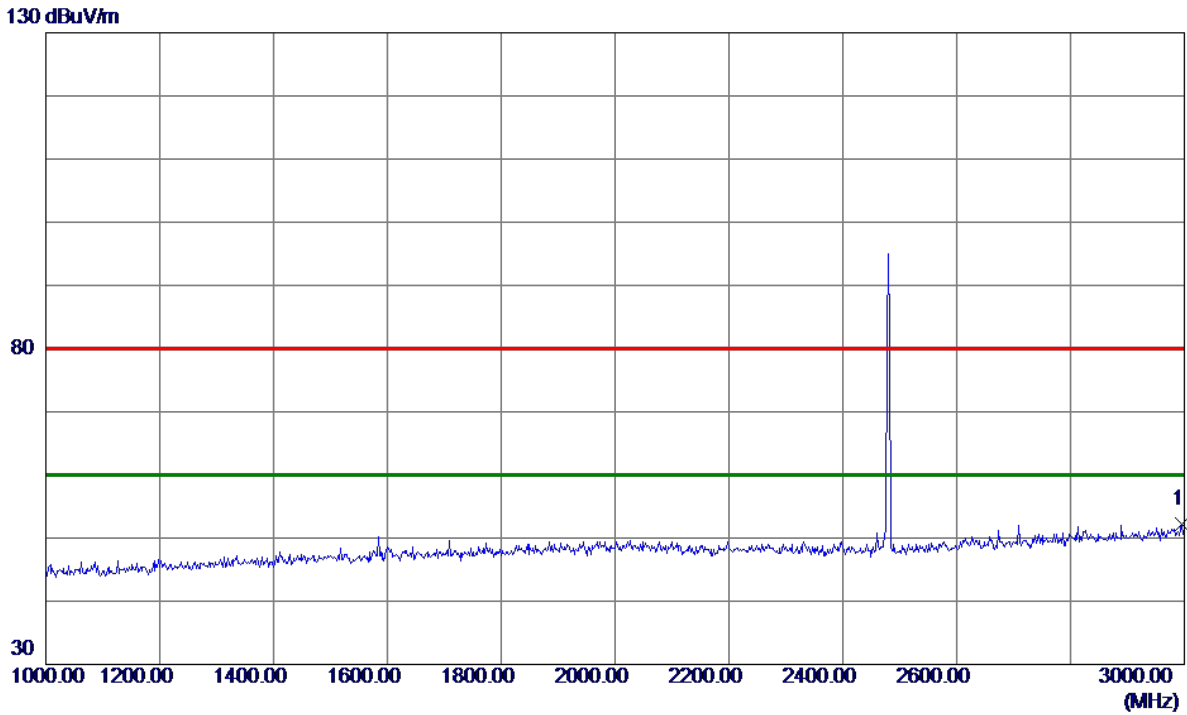

No.	Freq.	Reading Level	Correct Factor	Measurement	Limit	Margin	Detector	Comment
	MHz	dBuV/m	dB	dBuV/m	dBuV/m	dB		
1 *	2996.0000	37.31	14.97	52.28	80.00	-27.72	Peak	

Test Mode : TX 2480MHz \_CH78\_3Mbps

Horizontal

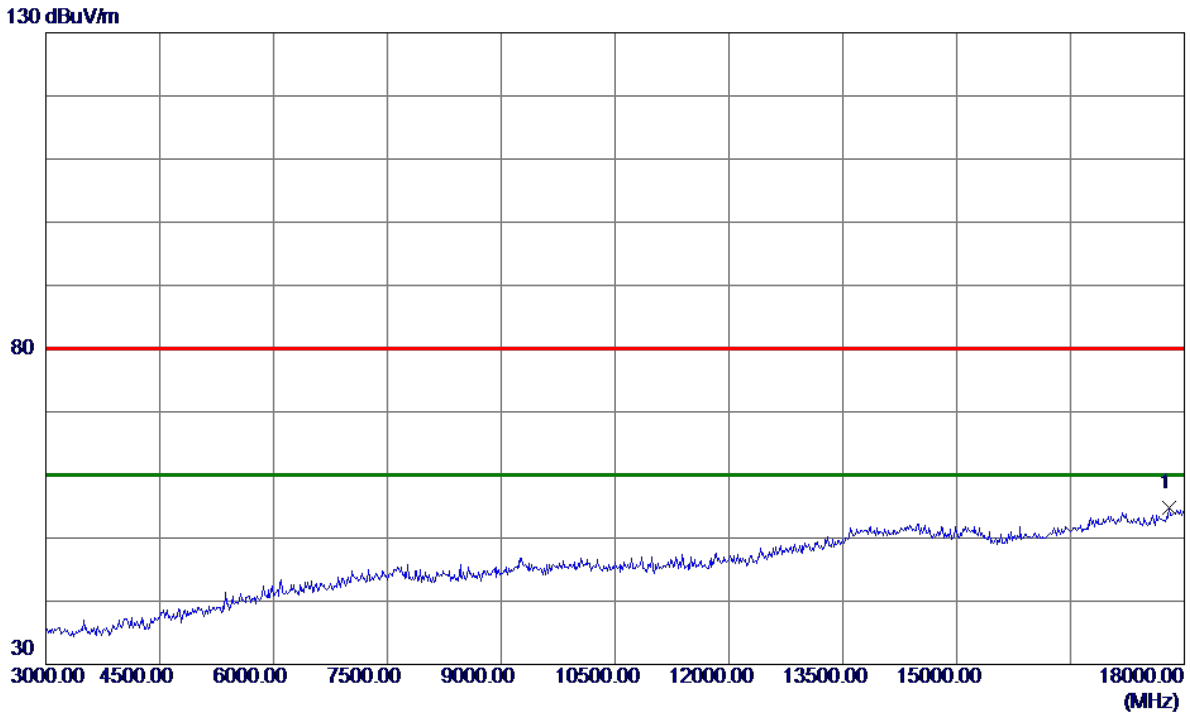

No.	Freq. MHz	Reading Level dBuV/m	Correct Factor dB	Measure ment dBuV/m	Limit dBuV/m	Margin dB	Detector	Comment
1 *	17805.0000	26.24	28.53	54.77	80.00	-25.23	Peak	

Test Mode : TX 2480MHz \_CH78\_3Mbps

Horizontal

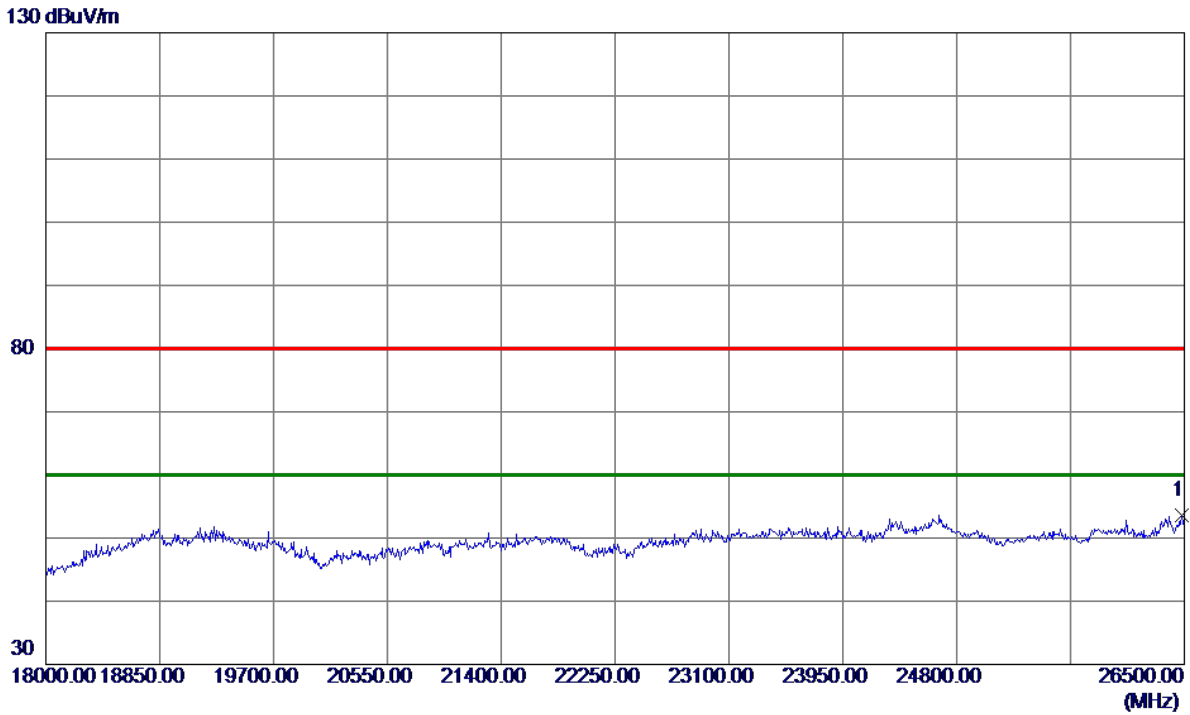

No.	Freq. MHz	Reading Level dBuV/m	Correct Factor dB	Measure ment dBuV/m	Limit dBuV/m	Margin dB	Detector	Comment
1 *	26483.0000	53.67	0.00	53.67	80.00	-26.33	Peak	

## APPENDIX D - NUMBER OF HOPPING CHANNEL

### Test Mode Hopping Mode\_1Mbps

Number of Hopping Channel 79

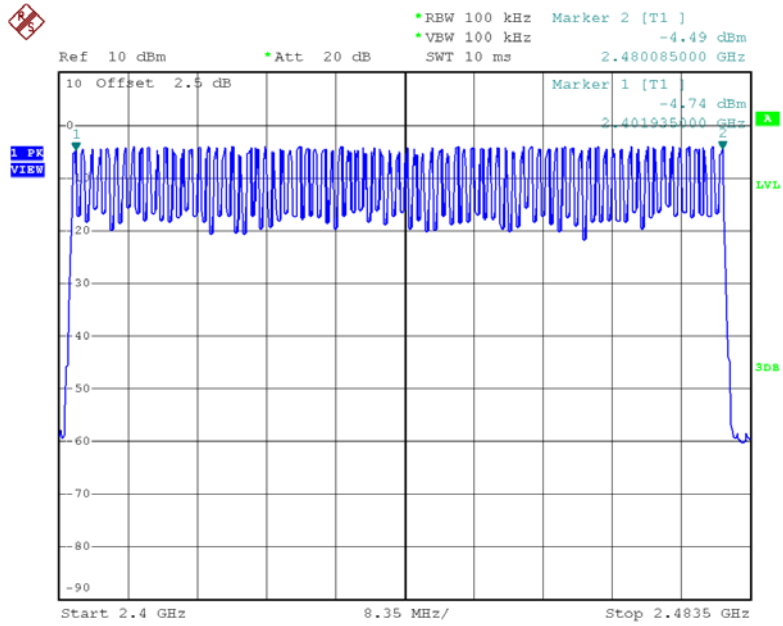

Date: 14.JUL.2018 10:25:17

### Test Mode Hopping Mode\_3Mbps

Number of Hopping Channel 79

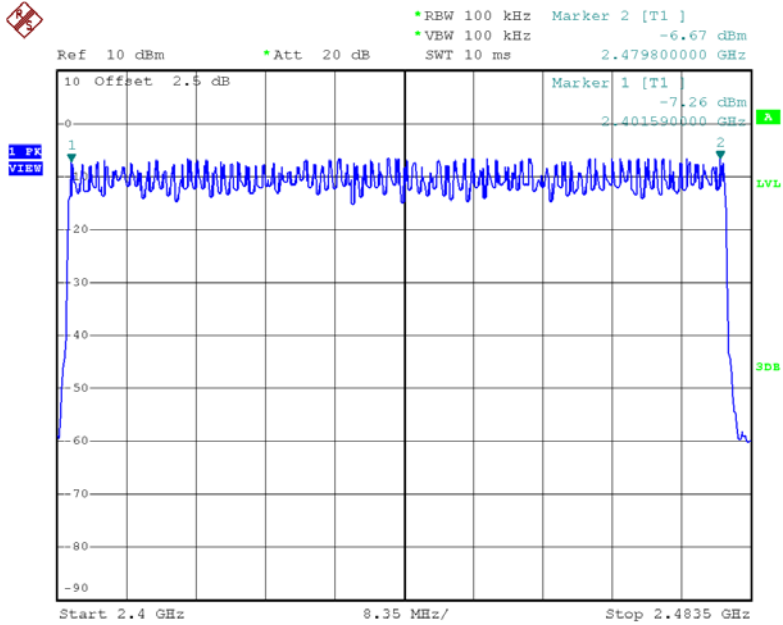

Date: 14.JUL.2018 11:09:16

## APPENDIX E - AVERAGE TIME OF OCCUPANCY



Test Mode :	TX Mode_1Mbps
-------------	---------------

Data Packet	Frequency (MHz)	Pulse Duration (ms)	Dwell Time (s)	Limits (s)	Test Result
DH5	2402	2.8800	0.3072	0.4000	Pass
DH3	2402	1.6600	0.2656	0.4000	Pass
DH1	2402	0.3850	0.1232	0.4000	Pass
DH5	2441	2.8800	0.3072	0.4000	Pass
DH3	2441	1.6600	0.2656	0.4000	Pass
DH1	2441	0.3850	0.1232	0.4000	Pass
DH5	2480	2.8800	0.3072	0.4000	Pass
DH3	2480	1.6600	0.2656	0.4000	Pass
DH1	2480	0.3850	0.1232	0.4000	Pass

**CH00-DH1**

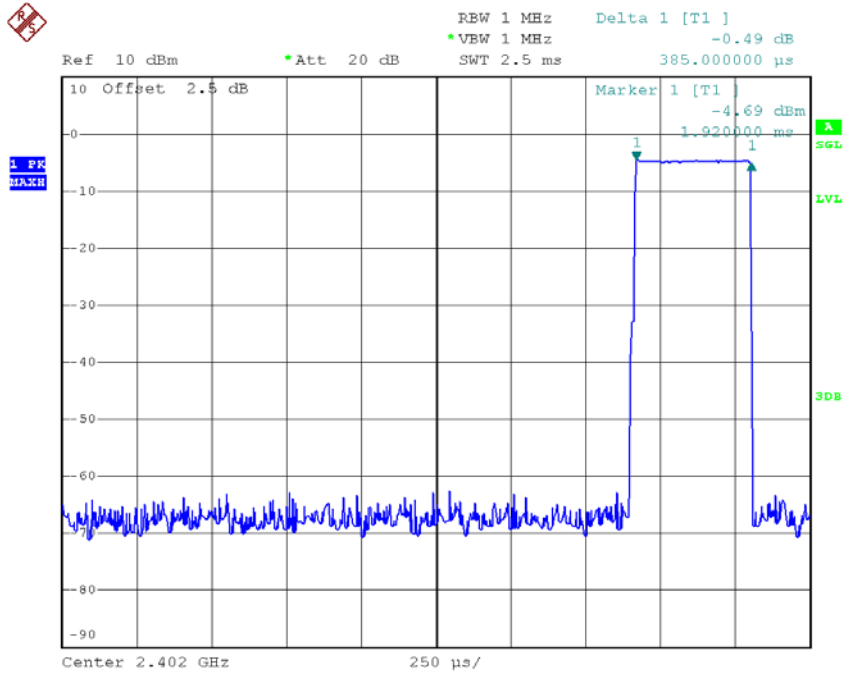

Date: 14.JUL.2018 10:19:45

**CH00-DH3**

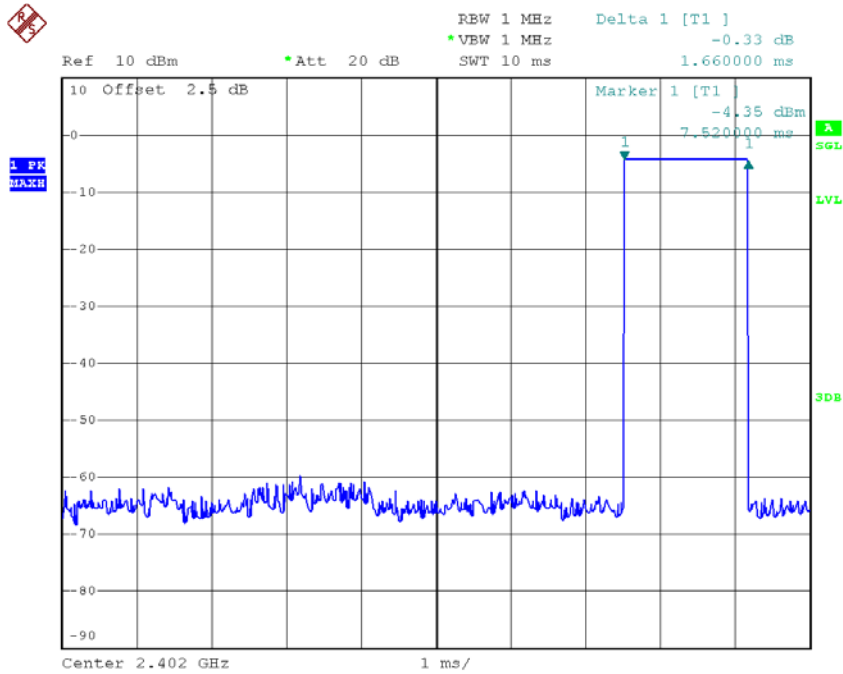

Date: 14.JUL.2018 10:30:56

### CH00-DH5

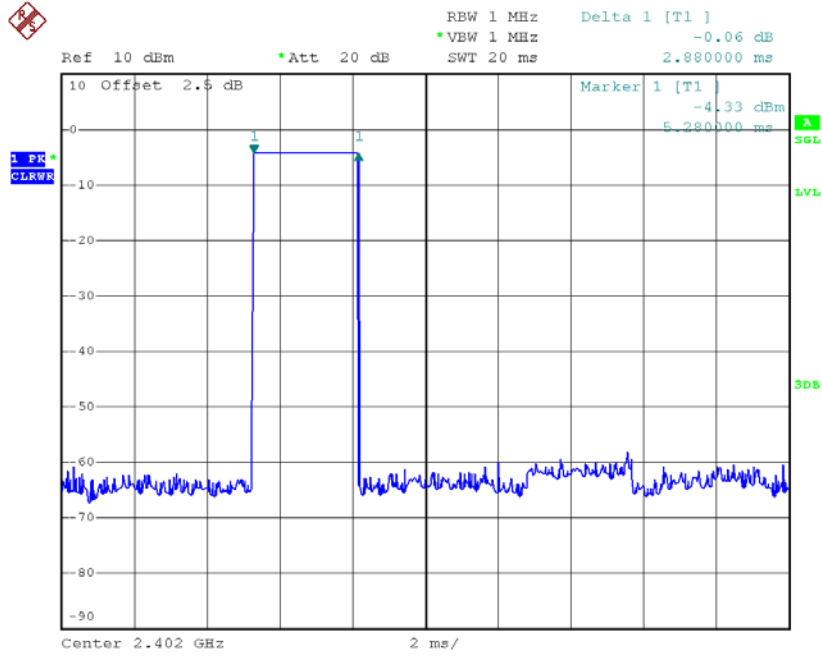

Date: 14.JUL.2018 10:32:50

### CH39-DH1

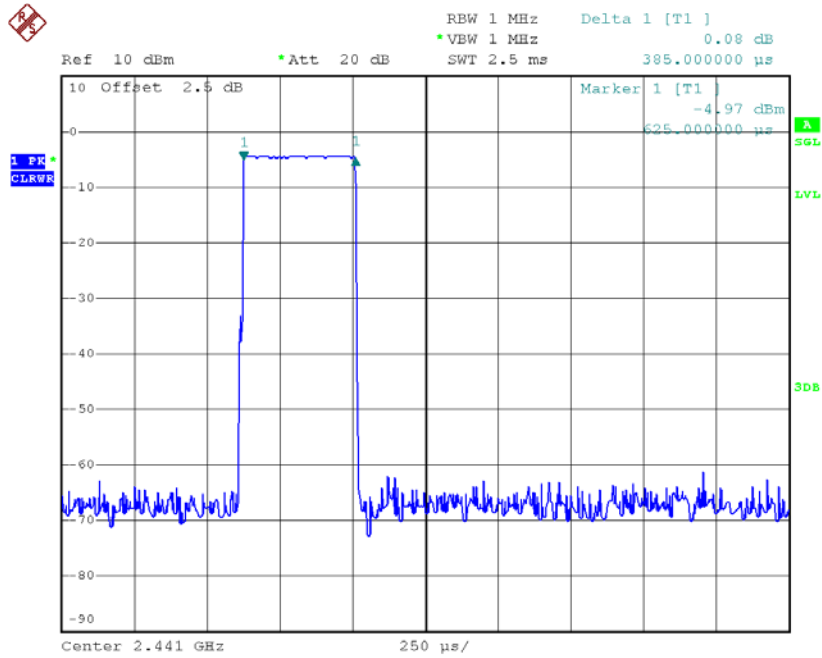

Date: 14.JUL.2018 10:19:50

### CH39-DH3

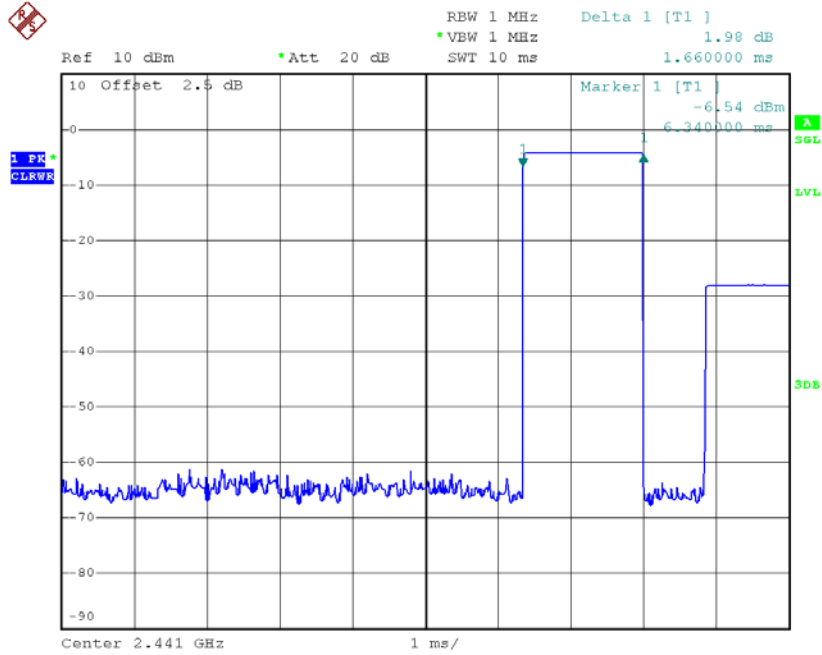

Date: 14.JUL.2018 10:31:01

### CH39-DH5

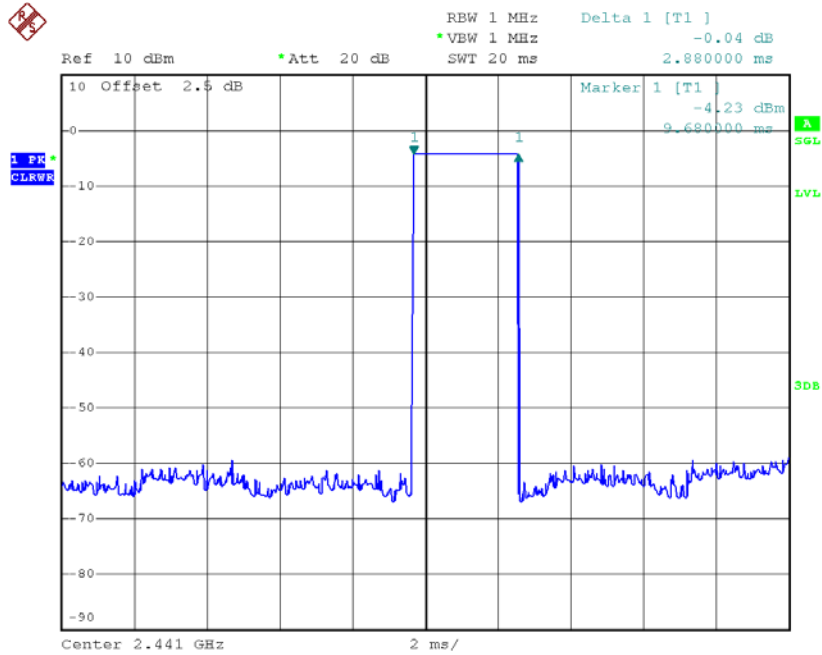

Date: 14.JUL.2018 10:32:55