

HOTT®

S602 User Manual

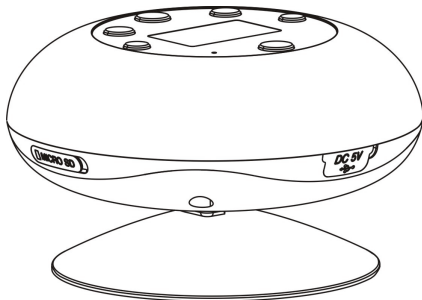

CONTENTS

PRODUCT OVERVIEW	4
BUTTONS	6
BLUETOOTH MODE	6
Bluetooth Pairing	6
Music playing in Bluetooth mode	10
Hands free calls	10
TF MODE	11
FM MODE	11
Search for FM Radio Stations	11
Switch FM Radio Station	11
Adjust Volume	12
CLOCK MODE	12
Adjust time	12
POWER	13
Power save function	13
Speaker Charging.....	13
Maintenance	13
FAQ.....	14
SPECIFICATIONS.....	15
WARNINGS	16
DISPOSAL.....	17

PRODUCT OVERVIEW

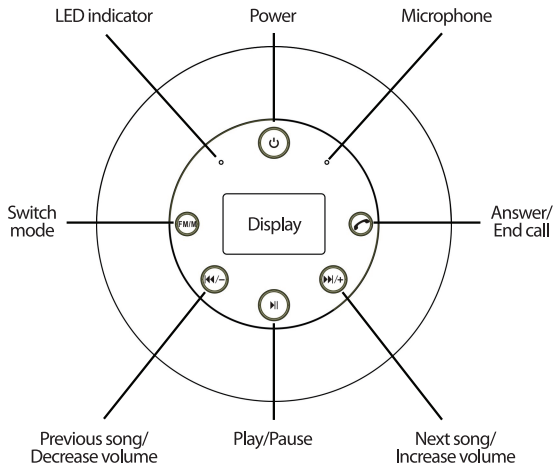





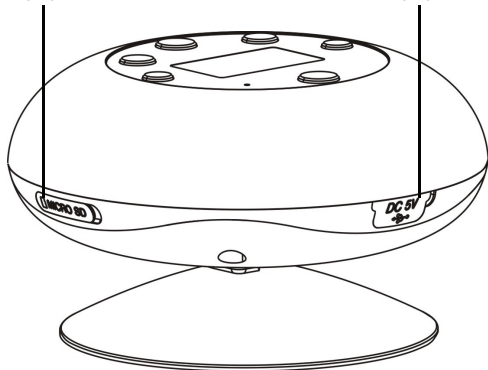

TF
charging port

USB
charging port



BUTTONS

BUTTON	USER ENTRY
	Hold down for three seconds to power on or off the Bluetooth speaker.
	Answer/End call.
	Long press to skip to next song, short press to increase volume
	Play/Pause or adjust clock.
	Long press to skip to previous song or short press to decrease volume
	Press to switch mode, choose between Bluetooth Mode, FM Radio Mode and Clock mode.

BLUETOOTH MODE

Bluetooth Pairing

If the Bluetooth speaker has never been connected to your phone/ tablet, you will need to follow the instructions below to connect to the Bluetooth speaker.

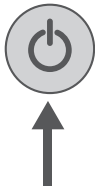
1

Power on the Bluetooth Speaker, by holding down the  button for 3 seconds. When the LED indicator light begins to flash rapidly, the speaker is in BT pairing mode and ready to pair with a Bluetooth enabled device.

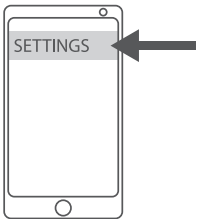
2

Go into settings on your phone/tablet.

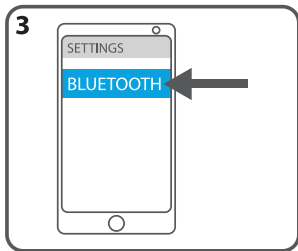

Proceed to go into Bluetooth, and enable Bluetooth on your phone/tablet.

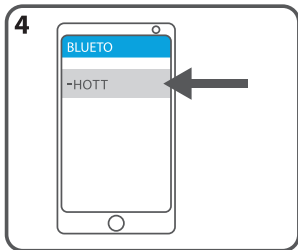

Search for the Bluetooth name: HOTT on the list and select it.

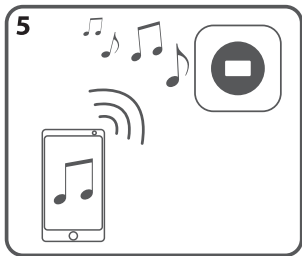





Your phone/tablet will now be connected to the Bluetooth Speaker, you can now listen to your favorite music and answer incoming phone calls.

Note: If the Bluetooth speaker has previously been connected to a phone/tablet, the speaker will automatically connect to the phone/tablet but only if Bluetooth is enabled on the phone/tablet and within range.

Note: If the speaker is connected to another phone/tablet, you will not be able to see it on the list of available bluetooth devices, and you will need to disable the Bluetooth connection on the currently connected phone/tablet and search for the speaker again.



Music playing in Bluetooth mode

When the Bluetooth speaker is connected to your phone/tablet, the following operations are available during music playback.

- Press once on the  button to play music, and press again to pause music.
- Long press the  button to skip to next song, or press the  button to return to previous song.
- Short press  or  to increase or decrease the volume.

Hands free calls

When you have connected your phone to the Bluetooth speaker, you will be able to conduct normal calls through the speaker. Music will automatically be paused if there is an incoming call.

Press on the  button to answer the phone call, and press on the  button again to end the call, and the music will automatically continue to play again.

To reject incoming calls hold the  button down for 3 seconds.
Double click the  button to redial the number of the last outgoing call.

TF MODE

Insert the TF card

- Press once on the ►|| button to play music, and press again to pause music.
- Long press ►||/+ button to skip to next song, or press the -/||◀ button to return to previous song.
- Short press ►||/+ or -/||◀ to increase or decrease the volume.

FM MODE

Long press  to enter FM Mode. Press  can delete the channel.

Long press  can save the channel

Search for FM Radio Stations

- Automatic search: Hold down the ►|| button for two seconds, the Bluetooth® speaker will automatically start to search for available radio stations and save them.
- Manual search: Click on the ►||/+ and -/||◀ buttons to manually adjust the frequency.

Switch FM Radio Station



Press the ►|| button to switch between the different radio stations saved during the automatic search.

Note: If the Bluetooth speaker runs out of power, the saved Radio Stations will no longer be available, and you will need to perform automatic search again.







Adjust Volume

Hold down  or  button to decrease or increase the volume.

CLOCK MODE

Power on the Bluetooth Speaker, by holding down the  button for 3 seconds. Click the  button until the speaker enters Clock Mode.

Adjust time

Once in the clock mode click the  button to start adjusting the time, hours will start to flash. Use the  or  buttons to adjust the hours. Once you are finished setting the hour, click on the  button again to switch to minutes, minutes will now start to flash. Use the  or  buttons to adjust the minutes.

Note: If the Bluetooth speaker runs out of power, the clock will be reset, and you will need to set the clock again.

POWER

Power save function

If the Bluetooth speaker is in Bluetooth mode and not connected to a Bluetooth device, it will automatically power off after five minutes, in order to save power.

Speaker Charging

The Bluetooth speaker has a built-in rechargeable battery and can be charged by connecting it to a USB charger or a computer. When the speaker is in charging, the red LED indicator light turns on. When the Bluetooth speaker is fully charge, the red LED light will turn off. Please disconnect the Bluetooth speaker from the power supply after it is fully charged.

Maintenance

If you do not use the Bluetooth speaker for a long period of time, please charge it before you use it again. We also recommend you charge it once a month, so you can protect the battery, to extend the life of the battery.

FAQ

Q: *I cannot find the Bluetooth speaker on the list of available Bluetooth devices on my phones/tablet.*

A: If the device has been connected to another Bluetooth device, then the Bluetooth speaker device will not appear in the list. You will need to disconnect the Bluetooth device from the Bluetooth speaker, and search for it once again.

A: The Bluetooth speaker is not in Bluetooth Mode, please use the  button to switch it into Bluetooth mode, indicated by the Bluetooth icon: .

Q: *My phone/tablet asks for a password when I try to connect to the Bluetooth speaker.*

A: If your device asks for a password, enter the number 0000 and select OK.

Q: *When paired with my computer, windows asks for new driver? Is this something you can supply?*

A: We cannot supply the Bluetooth driver required for this. The Bluetooth drivers may be required to play sound via Bluetooth connection. A driver is needed for the Bluetooth module in your PC, to connect to the Bluetooth speaker. Different Bluetooth modules may require different drivers. Please contact your PC or Bluetooth module's manufacturer for driver update.

SPECIFICATIONS

Bluetooth name: HOTT

Bluetooth version: BT5.0

Transmission distance up to 10M in open air

FM Radio

Output power: 3W

Built-in microphone

Built in battery: 1000mA

Playing time up to 10 hours

Talking time up to 8 hours

Charging time: 3-4H

Splashproof: IPX4

WARNINGS

This device complies with part 15 of the FCC Rules. Operation is subject to the following two conditions: (1) this device may not cause harmful interference, and (2) this device must accept any interference received, including interference that may cause undesired operation.

Any changes or modifications not expressly approved by the party responsible for compliance

could void the user's authority to operate the equipment.

NOTE: This equipment has been tested and found to comply with the limits for a Class B digital device, pursuant to Part 15 of the FCC Rules. These limits are designed to provide reasonable protection against harmful interference in a residential installation. This equipment generates, uses and can radiate radio frequency energy and, if not installed and used in accordance with the instructions, may cause harmful interference to radio communications. However, there is no guarantee that interference will not occur in a particular installation.

If this equipment does cause harmful interference to radio or television reception,

which can be determined by turning the equipment off and on, the user is encouraged to try to correct the interference by one or more of the following measures:

- Reorient or relocate the receiving antenna.
- Increase the separation between the equipment and receiver.
- Connect the equipment into an outlet on a circuit different from that to which the receiver is connected.
- Consult the dealer or an experienced radio/TV technician for help. The device has been evaluated to meet general RF exposure requirement. The device can be used in portable exposure condition without restriction

FCC ID:YB2-S602

DISPOSAL



Batteries, electrical and electronic equipment (EEE) contain materials, parts and substances, which can be dangerous to the environment and harmful to human health if waste of electrical and electronic equipment (WEEE) are not disposed of correctly.

Batteries, electrical and electronic equipment, which are marked with the WEEE logo (as shown on the left), should not be thrown away with your household waste. Contact your Local Authority Waste Disposal Department, as they will be able to provide details of the recycling options available in your area.