

Professional installation instruction

1. Installation personal

This product is designed for specific application and needs to be installed by a qualified personal who has RF and related rule knowledge. The general user shall not attempt to install or change the setting.

2. Installation location

The product shall be installed at a location where the radiating antenna can be kept 25cm from nearby person in normal operation condition to meet regulatory RF exposure requirement.

3. External antenna

Use only the antennas which have been approved by the applicant. The non-approved antenna(s) may produce unwanted spurious or excessive RF transmitting power which may lead to the violation of FCC limit and is prohibited.

4. Installation procedure

Please refer to user's manual for the detail.

Mount the PVS6

- (1). Select an installation location that is not in direct sunlight.
- (2). Mount the PVS6 bracket to the wall (+0 degree) using appropriate hardware for the mounting surface and that can support at least 6.8 kg (15 lbs).
- (3). Fit the PVS6 onto the bracket until the mounting holes at the bottom are aligned.
- (4). Use a screwdriver to secure the PVS6 to the bracket using the provided screws. Do not overtighten.

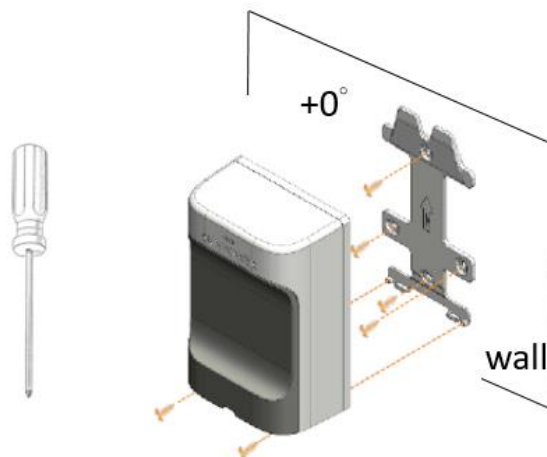

5. Warning

Please carefully select the installation position and make sure that the final output power does not exceed the limit set force in relevant rules. The violation of the rule could lead to serious federal penalty.