

APPLICATION FOR CERTIFICATION
On Behalf of

Shenzhen Contel Electronics Technology Co., Ltd.

Blu-ray Disc Player

Model Number: VBR220; VBR231

FCC ID: YAPVBR220

Prepared for : Shenzhen Contel Electronics Technology Co., Ltd.
13/F, Dawning BLDG, 12Keji Nan Rd., SHIP, Shenzhen,
China

Prepared By : Audix Technology (Shenzhen) Co., Ltd.
No. 6, Ke Feng Rd., 52 Block,
Shenzhen Science & Industrial Park,
Nantou, Shenzhen, Guangdong, China

Tel: (0755) 26639496

Report Number : ACS-F10075
Date of Test : Apr.01~13, 2010
Date of Report : Apr.14, 2010

TABLE OF CONTENTS

Description	Page
1. SUMMARY OF STANDARDS AND RESULTS.....	1-1
1.1. Description of Standards and Results	1-1
2. GENERAL INFORMATION	2-1
2.1. Description of Device (EUT)	2-1
2.2. Test information	2-2
2.3. Tested Supporting System Details	2-3
2.4. Test Facility	2-4
2.5. Measurement Uncertainty (95% confidence levels, k=2)	2-4
3. POWER LINE CONDUCTED EMISSION TEST	3-1
3.1. Test Equipments.....	3-1
3.2. Block Diagram of Test Setup.....	3-1
3.3. Power Line Conducted Emission Test Limits.....	3-1
3.4. Configuration of EUT on Test	3-2
3.5. Operating Condition of EUT.....	3-2
3.6. Test Procedure.....	3-2
3.7. Power Line Conducted Emission Test Results	3-2
4. RADIATED EMISSION TEST	4-1
4.1. Test Equipment	4-1
4.2. Block Diagram of Test Setup.....	4-1
4.3. Radiated Emission Limit.....	4-2
4.4. EUT Configuration on Test.....	4-3
4.5. Operating Condition of EUT.....	4-3
4.6. Test Procedure.....	4-3
4.7. Radiated Emission Test Results	4-4
5. CONDUCTED SPURIOUS EMISSIONS.....	5-1
5.1. Test Equipment	5-1
5.2. Limit.....	5-1
5.3. Test Procedure.....	5-1
5.4. Test result.....	5-1
6. BAND EDGE COMPLIANCE TEST	6-1
6.1. Test Equipment	6-1
6.2. Limit.....	6-1
6.3. Test Produce	6-1
6.4. Test Results	6-1
7. 6dB Bandwidth Test.....	7-1
7.1. Test Equipment	7-1
7.2. Limit.....	7-1
7.3. Test Procedure.....	7-1
7.4. Test Results	7-1
8. OUTPUT POWER TEST	8-1
8.1. Test Equipment	8-1
8.2. Limit.....	8-1
8.3. Test Procedure.....	8-1
8.4. Test Results	8-2
9. POWER SPECTRAL DENSITY TEST	9-1
9.1. Test Equipment	9-1

9.2.	Limit.....	9-1
9.3.	Test Procedure.....	9-1
9.4.	Test Results.....	9-2
10.	ANTENNA REQUIREMENT	10-1
11.	MPE ESTIMATION.....	11-1
11.1.	Limit for General Population/ Uncontrolled Exposures	11-1
11.2.	Estimation Result	11-1
12.	DEVIATION TO TEST SPECIFICATIONS.....	12-1
13.	PHOTOGRAPH OF TEST	13-1
13.1.	Photos of Power Line Conducted Emission Test.....	13-1
13.2.	Photos of Radiated Emission Test.....	13-2
14.	PHOTOGRAPH OF EUT	14-1

TEST REPORT CERTIFICATION

Applicant : Shenzhen Contel Electronics Technology Co., Ltd.
 Manufacturer : Dong Guan Contel Electronics Co., Ltd.
 EUT Description : Blu-ray Disc Player
 FCC ID : YAPVBR220
 (A)MODEL NO. : VBR220; VBR231
 (B)SERIAL NO. : N/A
 (C)POWER SUPPLY : DC 5V
 (D)TEST VOLTAGE : DC 5V

Test Procedure Used:

FCC Rules and Regulations Part 15 Subpart C 2008

The device described above is tested by AUDIX TECHNOLOGY (SHENZHEN) CO., LTD. to determine the maximum emission levels emanating from the device. The maximum emission levels are compared to the FCC Part 15 Subpart C limits both radiated and conducted emissions.

The test results are contained in this test report and AUDIX TECHNOLOGY (SHENZHEN) CO., LTD. is assumed full responsibility for the accuracy and completeness of these tests. Also, this report shows that the Equipment Under Test (EUT) is to be technically compliant with the FCC requirements.

This report applies to above tested sample only. This report shall not be reproduced in part without written approval of AUDIX TECHNOLOGY (SHENZHEN) CO., LTD.

Date of Test : Apr.01~13, 2010

Prepared by : Edie Huang
 Edie Huang / Assistant

Reviewer : Jamy Yu
 Jamy Yu / Supervisor

Approved & Authorized Signer :



Ken Lu
 Ken Lu / Manager

1. SUMMARY OF STANDARDS AND RESULTS

1.1. Description of Standards and Results

The EUT have been tested according to the applicable standards as referenced below.

EMISSION		
Description of Test Item	Standard	Results
Power Line Conducted Emission Test	FCC Part 15: 15.207 ANSI C63.10: 2009	PASS
Radiated Emission Test	FCC Part 15: 15.209 ANSI C63.10: 2009	PASS
Band Edge Compliance Test	FCC Part 15: 15.247 ANSI C63.10: 2009	PASS
Conducted spurious emissions test	FCC Part 15: 15.247 ANSI C63.10: 2009	PASS
6dB Bandwidth Test	FCC Part 15: 15.247 ANSI C63.10: 2009	PASS
Output Power Test	FCC Part 15: 15.247 ANSI C63.10: 2009	PASS
Power Spectral Density Test	FCC Part 15: 15.247 ANSI C63.10: 2009	PASS
Antenna requirement	FCC Part 15: 15.203	PASS

2. GENERAL INFORMATION

2.1. Description of Device (EUT)

Product Name	: Blu-ray Disc Player
Model Number	: VBR220; VBR231 Note: This device have two model numbers, and the actual device is same.
FCC ID	: YAPVBR220
Operation Frequency	: IEEE 802.11b/g, 802.11n HT20: 2412MHz---2462MHz IEEE802.11n HT40: 2422MHz---2452MHz
Channel Number	: IEEE 802.11b/g, 802.11n HT20: 11 Channels IEEE 802.11n HT40: 7 Channels
Modulation Technology	: IEEE 802.11b: DSSS(CCK,DQPSK,DBPSK) IEEE 802.11g: OFDM(64QAM, 16QAM, QPSK, BPSK) IEEE 802.11n HT20, HT40: OFDM (64QAM, 16QAM, QPSK,BPSK)
Output Power	: IEEE 802.11b: 23.54dBm IEEE 802.11g: 25.30dBm IEEE 802.11n HT20: 26.26dBm IEEE 802.11n HT40: 26.74dBm
Antenna Assembly and Gain	: Integral PCB antenna, MIMO 2X2; 1.74dBi Gain
Applicant	: Shenzhen Contel Electronics Technology Co., Ltd. 13/F, Dawning BLDG, 12Keji Nan Rd., SHIP, Shenzhen, China
Manufacturer	: Dong Guan Contel Electronics Co., Ltd. 2 nd Industrial Park, DiChong District, GaoBu Town, Dong Guan City, Guangdong Province, China
USB Cable	: Shielded, Detachable, 1m
Date of Test	: Apr.01~13, 2010
Date of Receipt	: Apr.01, 2010
Sample Type	: Prototype production

2.2. Test information

The test software “arcadyan_fcc_command” was used to control EUT work in Continuous TX mode (100% duty cycle), and select test channel, wireless mode and data rate.

Tested mode, channel, and data rate information			
Mode	data rate (Mbps)(see Note)	Channel	Frequency (MHz)
IEEE 802.11b	11	Low :CH1	2412
	11	Middle: CH6	2437
	11	High: CH11	2462
IEEE 802.11g	6	Low :CH1	2412
	6	Middle: CH6	2437
	6	High: CH11	2462
IEEE 802.11n HT20	6.5	Low :CH1	2412
	6.5	Middle: CH6	2437
	6.5	High: CH11	2462
IEEE 802.11n HT40	13.5	Low :CH1	2422
	13.5	Middle: CH4	2437
	13.5	High: CH7	2452
<p>Note1:According exploratory test, EUT will have maximum output power in those data rate, so those data rate were used for all test.</p> <p>Note2:This device use MIMO 2X2 antennas, for 802.11b/g mode, based exploratory test, when transmit with Chain 2 have worse emissions, so the final radiated emissions test for 802.11b/g mode were tested with chain 2 transmit mode.</p>			

2.3. Tested Supporting System Details

2.3.1. Notebook

M/N	:	PP09S
S/N	:	N/A
Manufacturer	:	DELL
Power Adaptor	:	Manufacturer: DELL, M/N: LA65NS1-00 Cable: Unshielded, Detachabled, 4.0m (Bond one ferrite core)

2.3.2. iPod

EMC CODE	:	ACS-EMC-IP01
M/N	:	A1199
S/N	:	YM706MLDVQ5
Manufacturer	:	APPLE
Data Cable	:	Shielded, Detachabled, 1.0m
FCC ID	:	By DoC
BSMI ID	:	R33057

2.3.3. TV

EMC CODE	:	ACS-EMC-TV01T
M/N	:	1419A
Manufacturer	:	TCL
Power cord	:	Unshielded, Undetachabled, 1.8m

2.4. Test Facility

Site Description

Name of Firm	:	Audix Technology (Shenzhen) Co., Ltd. No. 6, Ke Feng Rd., 52 Block, Shenzhen Science & Industrial Park, Nantou, Shenzhen, Guangdong, China
3m Anechoic Chamber	:	Mar.31, 2009 File on Federal Communication Commission Registration Number: 90454
3m & 10m Anechoic Chamber	:	Dec. 30, 2009 File on Federal Communication Commission Registration Number: 794232
EMC Lab.	:	Accredited by DATech, German Registration Number: DAT-P-091/99-01 Feb. 02, 2009 Accredited by NVLAP, USA NVLAP Code: 200372-0 Apr. 01, 2010

2.5. Measurement Uncertainty (95% confidence levels, k=2)

Test Item	Uncertainty
Uncertainty for Conduction emission test in No. 1 Conduction	2.40dB
Uncertainty for Radiation Emission test in 3m chamber	3.78 dB (Polarize: V)
	4.20 dB (Polarize: H)
Uncertainty for Radiated Spurious Emission test in RF chamber	2.70 dB (Bilog antenna 30M~1000MHz)
	2.27 dB (Horn antenna 1000M~25000MHz)
Uncertainty for Conduction Spurious emission test	2.10 dB
Uncertainty for Output power test	0.94 dB
Uncertainty for Power density test	2.10 dB
Uncertainty for Temperature and humidity test	2%
	1°C
Uncertainty for Bandwidth test	1×10^{-9}
Uncertainty for DC power test	0.038 %
Uncertainty for test site temperature and humidity	0.6°C
	3%

3. POWER LINE CONDUCTED EMISSION TEST

3.1. Test Equipments

Item	Equipment	Manufacturer	Model No.	Serial No.	Last Cal.	Cal. Interval
1	Test Receiver	Rohde & Schwarz	ESHS20	836600/006	May.08, 09	1 Year
2	L.I.S.N.#2	Kyoritsu	KNW-407	8-1636-1	May.08, 09	1 Year
3	L.I.S.N.#3	Kyoritsu	KNW-242C	8-1920-1	May.08, 09	1 Year
4	Terminator	Hubersuhner	50Ω	No. 1	May.08, 09	1 Year
5	RF Cable	Fujikura	3D-2W	LISN Cable 1#	May.08, 09	1 Year
6	Coaxial Switch	Anritsu	MP59B	M55367	May.08, 09	1 Year
7	Pulse Limiter	Rohde & Schwarz	ESH3-Z2	100341	May.08, 09	1 Year

3.2. Block Diagram of Test Setup

3.2.1. Block diagram of connection between the EUT and simulators

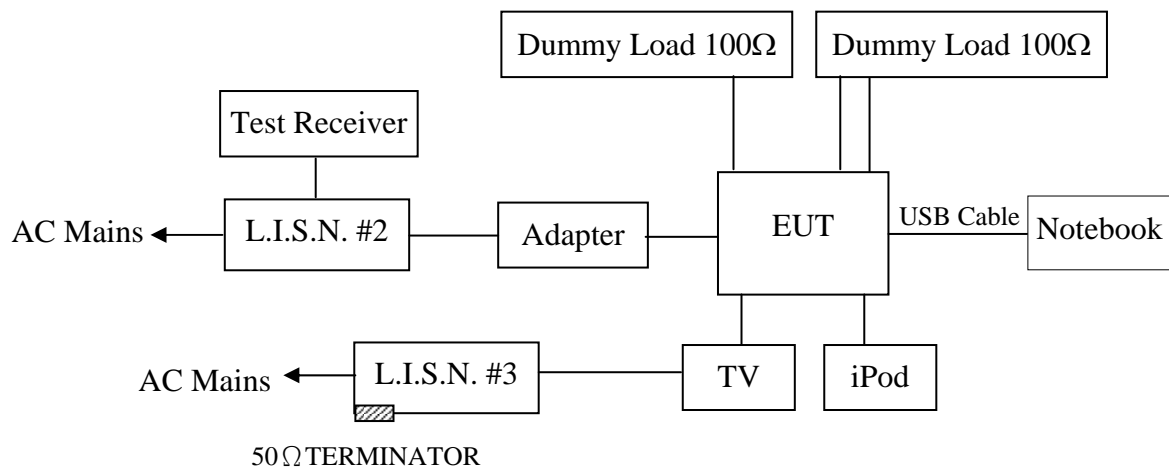

(EUT: Blu-ray Disc Player)

3.3. Power Line Conducted Emission Test Limits

Frequency	Maximum RF Line Voltage	
	Quasi-Peak Level dB(μV)	Average Level dB(μV)
150kHz ~ 500kHz	66 ~ 56*	56 ~ 46*
500kHz ~ 5MHz	56	46
5MHz ~ 30MHz	60	50

Notes: 1. * Decreasing linearly with logarithm of frequency.

2. The lower limit shall apply at the transition frequencies.

3.4.Configuration of EUT on Test

The following equipment are installed on Power Line Conducted Emission Test to meet the commission requirement and operating regulations in a manner which tends to maximize its emission characteristics in a normal application.

3.4.1.Blu-ray Disc Player (EUT)

Model Number : VBR220; VBR231
Serial Number : N/A

3.4.2.Support Equipment : As Tested Supporting System Detail, in Section 2.3.

3.5.Operating Condition of EUT

3.5.1.Setup the EUT and simulator as shown as Section 3.2.

3.5.2.Turned on the power of all equipment.

3.5.3.Notebook run test software to control EUT's Wi-Fi module work in Tx mode.

3.5.4.EUT Playing Blue-disc and reading music from iPod by USB port.

3.5.5. All other input and outputs of EUT were connected to dummy load.

3.6.Test Procedure

The EUT was placed on a non-metallic table, 80cm above the ground plane. The EUT Power Via Notebook connected to the power mains through a line impedance stabilization network (L.I.S.N. 2#). This provides a 50 ohm coupling impedance for the EUT (Please refer the block diagram of the test setup and photographs). The other peripheral devices power cord connected to the power mains through a line impedance stabilization network (L.I.S.N.#3). Both sides of power line are checked to find out the maximum conducted emission. In order to find the maximum emission levels, the relative positions of equipment and all of the interface cables shall be changed according to ANSI C63.10: 2009 on Conducted Emission Test.

The bandwidth of test receiver (R & S ESHS20) is set at 10kHz.

The frequency range from 150kHz to 30MHz is checked.

The test result are reported on Section 3.7.,

3.7.Power Line Conducted Emission Test Results

PASS. (All emissions not reported below are too low against the prescribed limits.)



NO.6 Ke Feng Road,Block 52,
Shenzhen Science&Industry Park
Nantou, Shenzhen,Guang dong, China.
Tel:+86-755-26639495
Fax:+86-755-26632877
Postcode:518057

Data: 2

File: D:\DATA\2010 REPORT\C\CONTEL\ACS10Q0594R2.EM6 (2)

Date: 2010-04-13

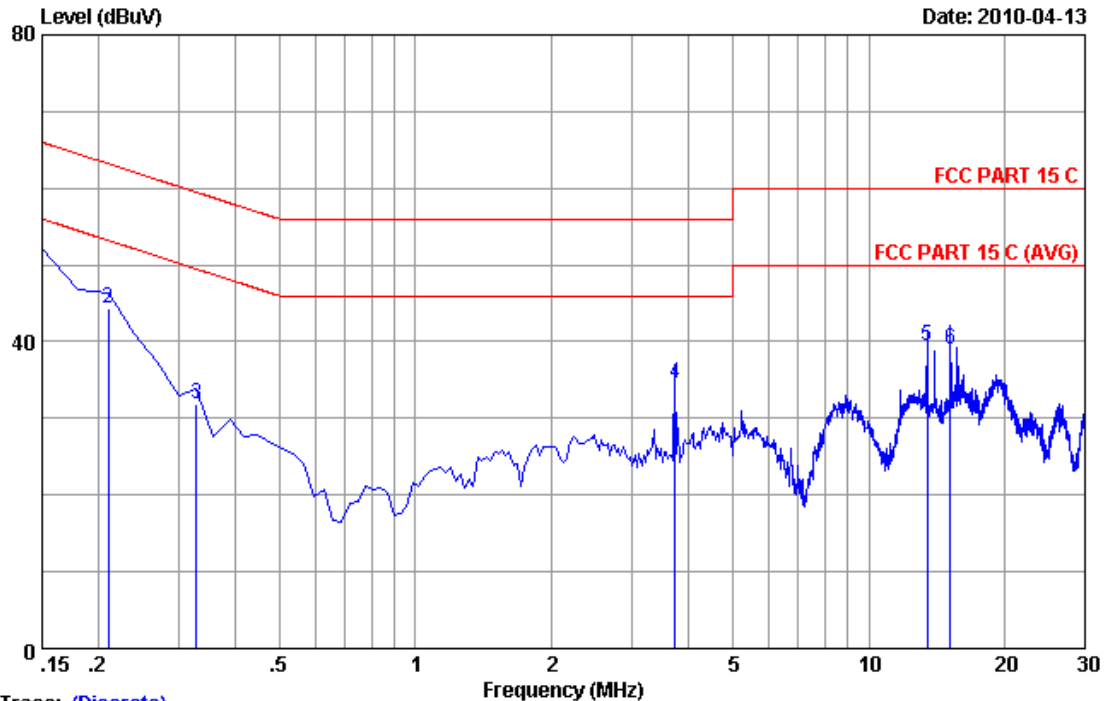

Trace: (Discrete)

Site no :Audix No.1 Conduction Data no :2
 Dis./Ant. :** 2009 ESH2-25 LINE
 Limit :FCC PART 15 C
 Env./Ins. :Temp:23'C Humi:54% Engineer :Paul Tian
 EUT :Blu-ray Disc Player M/N:VBR220
 Power Rating :DC 5V
 Test Mode :Tx Mode

No	Freq (MHz)	LISN Factor (dB)	Cable Loss (dB)	Reading (dBuV)	Emission Level (dBuV)	Limits (dBuV)	Margin (dB)	Remark
1	0.15000	0.21	9.88	40.10	50.19	66.00	15.81	QP
2	0.20970	0.18	9.88	34.32	44.38	63.22	18.84	QP
3	0.32910	0.18	9.89	21.82	31.89	59.47	27.58	QP
4	3.732	0.27	9.91	24.37	34.55	56.00	21.45	QP
5	13.463	0.41	9.96	29.12	39.49	60.00	20.51	QP
6	15.165	0.43	9.97	28.67	39.07	60.00	20.93	QP

Remarks: 1.Emission Level=LISN Factor+Cable Loss+Reading.
 2.If the average limit is met when using a quasi-peak detector.
 the EUT shall be deemed to meet both limits and measurement
 with average detector is unnecessary.



NO.6 Ke Feng Road,Block 52,
Shenzhen Science&Industry Park
Nantou, Shenzhen,Guang dong, China.
Tel:+86-755-26639495
Fax:+86-755-26632877
Postcode:518057

Data: 1

File: D:\DATA\2010 REPORT\C\CONTEL\ACS10Q0594R2.EM6 (2)

Date: 2010-04-13

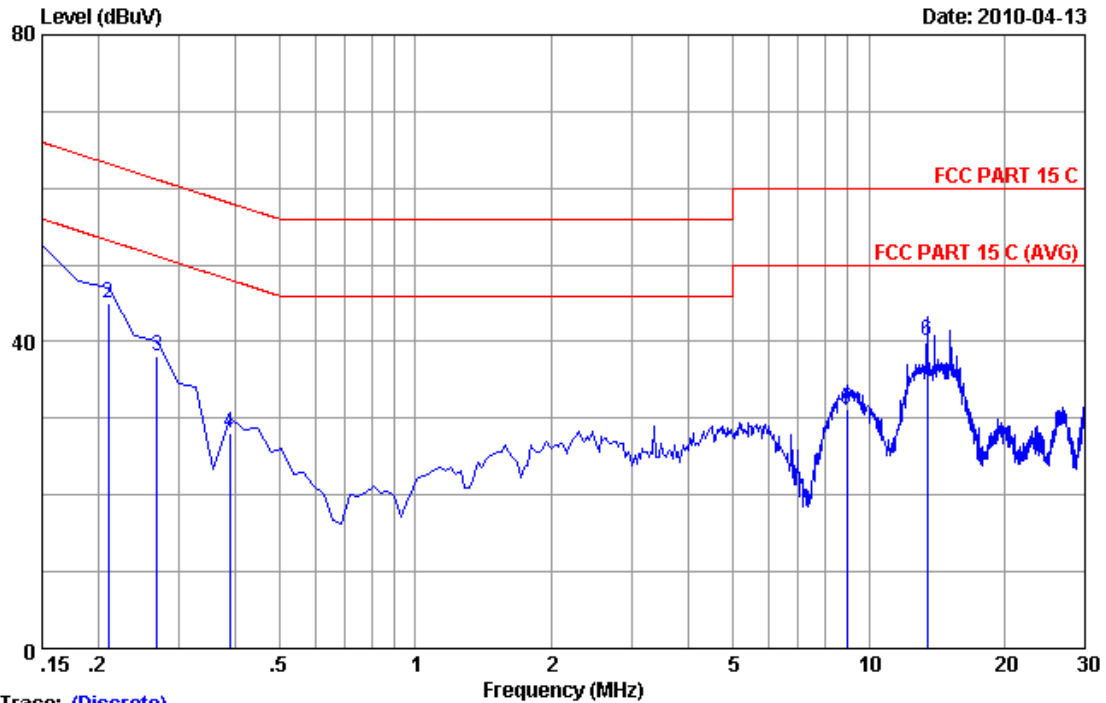

Trace: (Discrete)

Site no :Audix No.1 Conduction Data no :1
 Dis./Ant. **: 2009 ESH2-Z5 NEUTRAL
 Limit :FCC PART 15 C
 Env./Ins. :Temp:23'C Humi:54% Engineer :Paul Tian
 EUT :Blu-ray Disc Player M/N:VBR220
 Power Rating :DC 5V
 Test Mode :Tx Mode

No	Freq (MHz)	LISN Factor (dB)	Cable Loss (dB)	Reading (dBUV)	Emission Level (dBUV)	Limits (dBUV)	Margin (dB)	Remark
1	0.15000	0.20	9.88	40.48	50.56	66.00	15.44	QP
2	0.20970	0.20	9.88	34.94	45.02	63.22	18.20	QP
3	0.26940	0.20	9.88	28.03	38.11	61.14	23.03	QP
4	0.38880	0.20	9.89	18.02	28.11	58.09	29.98	QP
5	8.956	0.29	9.94	21.00	31.23	60.00	28.77	QP
6	13.463	0.32	9.96	29.89	40.17	60.00	19.83	QP

Remarks: 1.Emission Level=LISN Factor+Cable Loss+Reading.
 2.If the average limit is met when using a quasi-peak detector.
 the EUT shall be deemed to meet both limits and measurement
 with average detector is unnecessary.

4. RADIATED EMISSION TEST

4.1. Test Equipment

Frequency rang: 30~1000MHz

Item	Equipment	Manufacturer	Model No.	Serial No.	Last Cal.	Cal. Interval
1	3#Chamber	AUDIX	N/A	N/A	Dec.05,09	1 Year
2	EMI Spectrum	Agilent	E4407B	MY41440292	May.08, 09	1 Year
3	Test Receiver	Rohde & Schwarz	ESVS10	834468/011	May.08, 09	1 Year
4	Amplifier	HP	8447D	2648A04738	May.08, 09	1 Year
5	Bilog Antenna	Schaffner	CBL6111C	2598	Dec.14, 09	1 Year
6	RF Cable	MIYAZAKI	8D-FB	3# Chamber No.1	May.08, 09	1 Year
7	Coaxial Switch	Anritsu	MP59B	M73989	May.08, 09	1 Year

Frequency rang: above 1000MHz

Item	Equipment	Manufacturer	Model No.	Serial No.	Last Cal.	Cal. Interval
1	Spectrum Analyzer	Agilent	E4446A	US44300459	May.08, 09	1 Year
2	Horn Antenna	EMCO	3115	9607-4877	Nov.25, 09	1.5 Year
3	Horn Antenna	EMCO	3116	00060089	Dec.03, 09	1.5 Year
4	Amplifier	Agilent	8449B	3008A00863	May.08, 09	1 Year
5	RF Cable	Hubersuhner	SUCOFLEX102	28620/2	Nov.28, 09	1 Year
6	RF Cable	Hubersuhner	SUCOFLEX102	29091/2	Nov.28, 09	1 Year
7	RF Cable	Hubersuhner	SUCOFLEX102	28618/2	May.08, 09	1 Year

4.2. Block Diagram of Test Setup

4.2.1. Block diagram of connection between the EUT and simulators

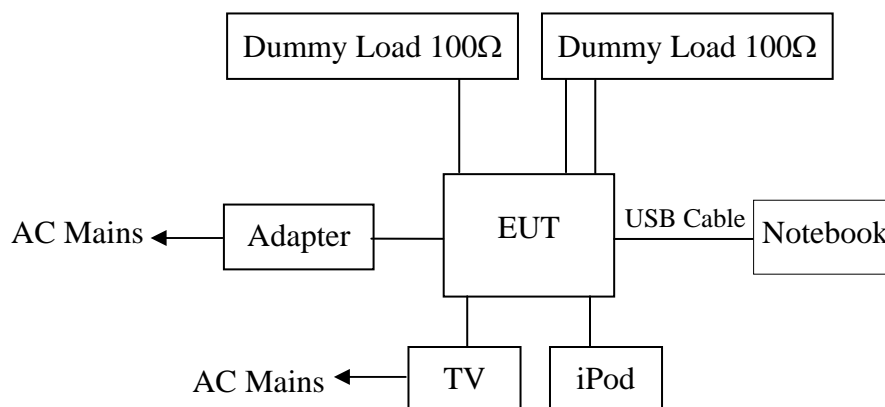

(EUT: Blu-ray Disc Player)

4.2.2.In Anechoic Chamber

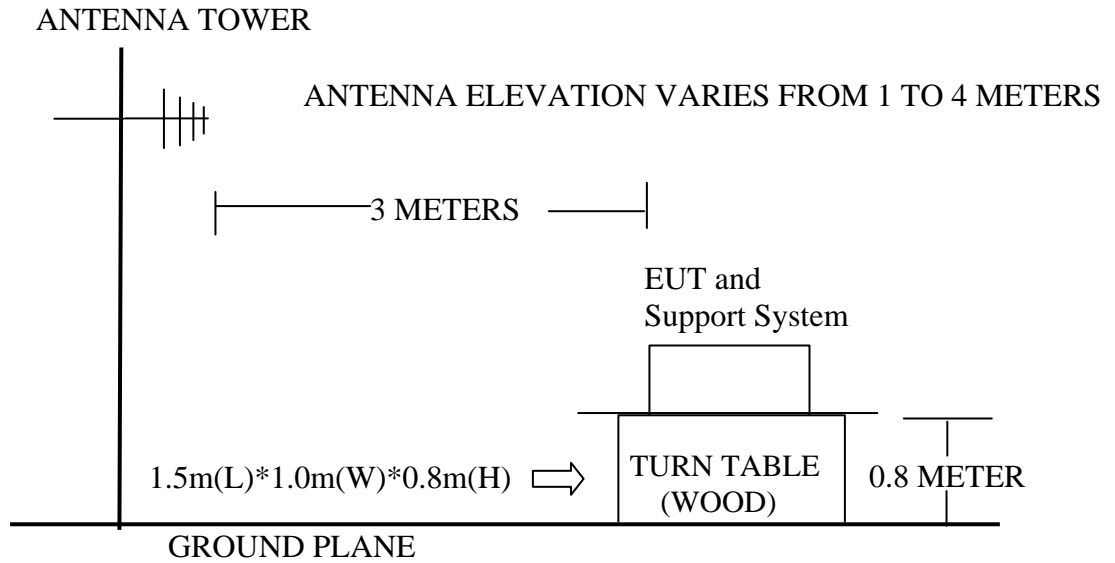

4.3.Radiated Emission Limit

4.3.1.15.209 limits

FREQUENCY MHz	DISTANCE Meters	FIELD STRENGTHS LIMIT	
		μV/m	dB(μV)/m
30 ~ 88	3	100	40.0
88 ~ 216	3	150	43.5
216 ~ 960	3	200	46.0
960 ~ 1000	3	500	54.0
Above 1000	3	74.0 dB(μV)/m (Peak) 54.0 dB(μV)/m (Average)	

- Remark :
- (1) Emission level dBμV = 20 log Emission level μV/m
 - (2) The smaller limit shall apply at the cross point between two frequency bands.
 - (3) Distance is the distance in meters between the measuring instrument, antenna and the closest point of any part of the device or system.

4.3.2.15.205 Restricted bands of operation

MHz	MHz	MHz	GHz
0.090 - 0.110	16.42 - 16.423	399.9 - 410	4.5 - 5.15
¹ 0.495 - 0.505	16.69475 - 16.69525	608 - 614	5.35 - 5.46
2.1735 - 2.1905	16.80425 - 16.80475	960 - 1240	7.25 - 7.75
4.125 - 4.128	25.5 - 25.67	1300 - 1427	8.025 - 8.5
4.17725 - 4.17775	37.5 - 38.25	1435 - 1626.5	9.0 - 9.2
4.20725 - 4.20775	73 - 74.6	1645.5 - 1646.5	9.3 - 9.5
6.215 - 6.218	74.8 - 75.2	1660 - 1710	10.6 - 12.7
6.26775 - 6.26825	108 - 121.94	1718.8 - 1722.2	13.25 - 13.4
6.31175 - 6.31225	123 - 138	2200 - 2300	14.47 - 14.5
8.291 - 8.294	149.9 - 150.05	2310 - 2390	15.35 - 16.2
8.362 - 8.366	156.52475 - 156.52525	2483.5 - 2500	17.7 - 21.4
8.37625 - 8.38675	156.7 - 156.9	2690 - 2900	22.01 - 23.12
8.41425 - 8.41475	162.0125 - 167.17	3260 - 3267	23.6 - 24.0
12.29 - 12.293	167.72 - 173.2	3332 - 3339	31.2 - 31.8
12.51975 - 12.52025	240 - 285	3345.8 - 3358	36.43 - 36.5
12.57675 - 12.57725	322 - 335.4	3600 - 4400	(²)

All the emissions appearing within 15.205 restricted frequency bands shall not exceed the limits shown in 15.209, all the other emissions shall be at least 20dB below the fundamental emissions, or comply with 15.209 limits.

4.4.EUT Configuration on Test

The following equipment are installed on Radiated Emission Test to meet the commission requirements and operating regulations in a manner which tends to maximize its emission characteristics in normal application.

4.4.1.Blu-ray Disc Player (EUT)

Model Number : VBR220; VBR231
Serial Number : N/A

4.4.2.Support Equipment : As Tested Supporting System Detail, in Section 2.3.

4.5.Operating Condition of EUT

4.5.1.Setup the EUT and simulator as shown as Section 4.2.

4.5.2.Turned on the power of all equipment.

4.5.3.Notebook run test software to control EUT's Wi-Fi module work in Tx mode.

4.5.4.EUT Playing Blue-disc and reading music from iPod by USB port.

4.5.5.All other input and outputs of EUT were connected to dummy load.

4.6.Test Procedure

EUT and its simulators are placed on a turn table, which is 0.8 meter high above ground. The turn table can rotate 360 degrees to determine the position of the maximum emission level. Power on the EUT and let it working in test mode, then test it. EUT is set 3 meters away from the receiving antenna, which is mounted on a antenna tower. The antenna can be moved up and down between 1 meter and 4 meters to find out the maximum emission level. Broadband antenna (calibrated bilog antenna) is used as receiving antenna. Both horizontal and vertical polarization of the antenna are set on test.

The bandwidth of the EMI test receiver (R&S ESVS10) is set at 120kHz for frequency range from 30MHz to 1000 MHz.

The bandwidth of the Spectrum's VBW is set at 3MHz and RBW is set at 1MHz for peak emissions measurement above 1GHz and 1MHz RBW, 10Hz VBW for average emissions measure above 1GHz

The frequency range from 30MHz to 10th harmonic (25GHz) are checked. and no any emissions were found from 18GHz to 25 GHz, So the radiated emissions from 18GHz to 25GHz were not record.

4.7.Radiated Emission Test Results

PASS.

All the emissions from 30MHz to 25 GHz were comply with 15.209 limits.

Frequency: 30MHz~1GHz



No.6 Ke Feng Road,Block 52,
ShenZhen Science & Industry Park
Noutou,ShenZhen,GuangDong,China
Tel:+86-755-26639495-7
Fax:+86-755-26632877
Postcode:518057

Data: 1 File: D:\2010 Reput Data\C\contel\ACS10Q0594R2.EM6 (2)

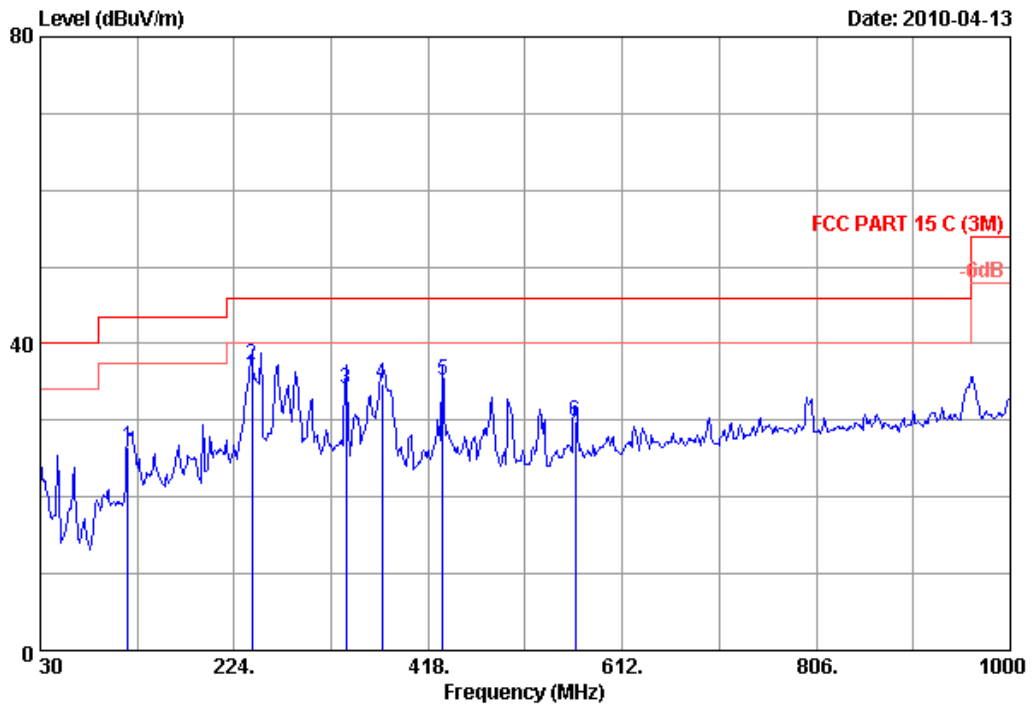

Site no. : 3m chamber Data no. : 1
 Dis. / Ant. : 3m 2009 CBL6111C Ant. pol. : HORIZONTAL
 Limit : FCC PART 15 C (3M)
 Env. / Ins. : 24°C/56% Engineer : Paul Tian
 EUT : Blu-ray Disc Player M/N:VBR220
 Power Rating : DC 5V
 Test Mode : Tx Mode

No.	Freq. (MHz)	Ant. Factor (dB/m)	Cable Loss (dB)	Reading (dBuV)	Emission Level (dBuV/m)	Limits (dBuV/m)	Margin (dB)	Remark
1	117.300	11.78	0.97	13.80	26.55	43.50	16.95	QP
2	241.460	11.93	1.58	23.62	37.13	46.00	8.87	QP
3	335.550	14.62	1.80	17.77	34.19	46.00	11.81	QP
4	371.440	15.52	1.87	17.28	34.67	46.00	11.33	QP
5	432.550	17.42	2.03	15.76	35.21	46.00	10.79	QP
6	565.440	19.61	2.41	7.94	29.96	46.00	16.04	QP

Remarks: 1. Emission Level= Antenna Factor + Cable Loss + Reading.
 2. The emission levels that are 20dB below the official limit are not reported.



No.6 Ke Feng Road,Block 52,
ShenZhen Science & Industry Park
Noutou,ShenZhen,GuangDong,China
Tel:+86-755-26639495-7
Fax:+86-755-26632877
Postcode:518057

Data: 2 File: D:\2010 Reput Data\C\contel\ACS10Q0594R2.EM6 (2)

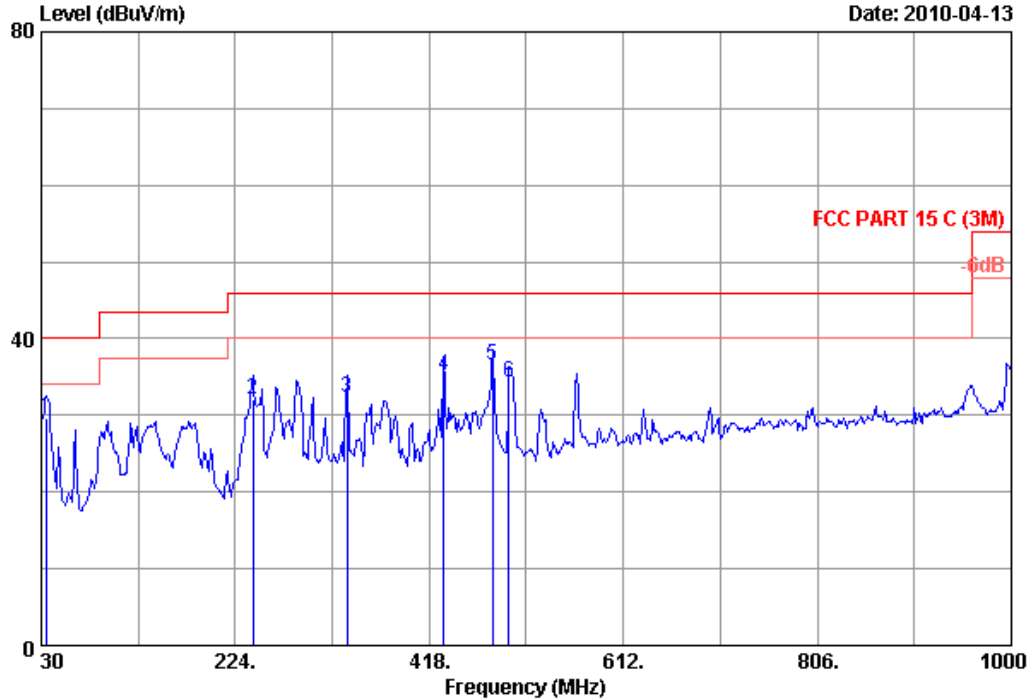

Site no. : 3m chamber	Data no. : 2
Dis. / Ant. : 3m 2009 CBL6111C	Ant. pol. : VERTICAL
Limit : FCC PART 15 C (3M)	
Env. / Ins. : 24°C/56%	Engineer : Paul Tian
EUT : Blu-ray Disc Player	M/N:VBR220
Power Rating : DC 5V	
Test Mode : Tx Mode	

No.	Freq. (MHz)	Ant. Factor (dB/m)	Cable Loss (dB)	Reading (dBuV)	Emission Level (dBuV/m)	Limits (dBuV/m)	Margin (dB)	Remark
1	34.850	17.20	0.55	11.84	29.59	40.00	10.41	QP
2	241.460	11.93	1.58	18.67	32.18	46.00	13.82	QP
3	335.550	14.62	1.80	15.88	32.30	46.00	13.70	QP
4	432.550	17.42	2.03	15.77	35.22	46.00	10.78	QP
5	481.050	18.11	2.19	16.17	36.47	46.00	9.53	QP
6	497.540	18.27	2.24	13.89	34.40	46.00	11.60	QP

Remarks: 1. Emission Level= Antenna Factor + Cable Loss + Reading.
2. The emission levels that are 20dB below the official limit are not reported.

Frequency: 1GHz~18GHz



No.6 Ke Feng Road,Block 52,
 ShenZhen Science & Industry Park
 Noutou,ShenZhen, GuangDong, China
 Tel:+86-755-26639495-7
 Fax:+86-755-26632877
 Postcode:518057

Data: 1 File: E:\2010 report data\C\contel\ACS10Q0594R2.EM6 (108)

Date: 2010-04-01

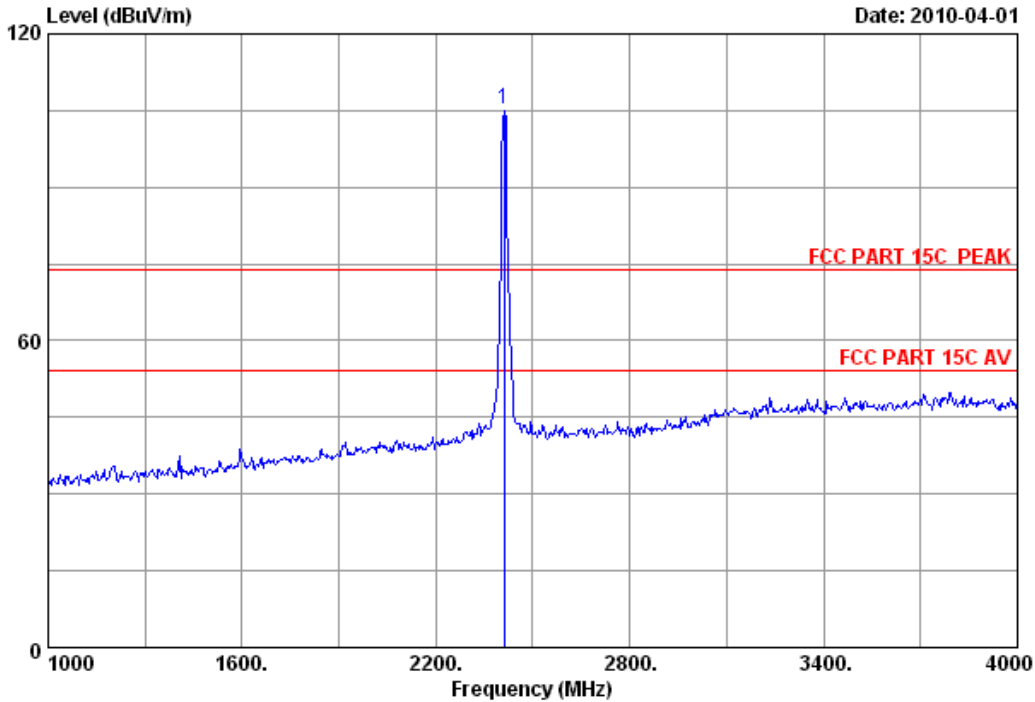

Site no. : 3m Chamber Data no. : 1
 Dis. / Ant. : 3m 3115(0911) Ant. pol. : VERTICAL
 Limit : FCC PART 15C PEAK
 Env. / Ins. : 23°C/54% Engineer : Paul
 EUT : Blu-ray Disc Player M/N:VBR220
 Power : DC 5V
 Test mode : Tx Mode 2412MHz

	Freq. (MHz)	Ant. Cable Amp.			Emission				
		Factor (dB/m)	loss (dB)	Factor (dB)	Reading (dBUV)	Level (dBUV/m)	Limits (dBUV/m)	Margin (dB)	Remark
1	2412.000	29.45	8.72	35.95	103.19	105.41	74.00	-31.41	Peak

Remarks:

1. Emission Level= Antenna Factor + Cable Loss -Amp Factor + Reading.
2. The emission levels that are 20dB below the official limit are not reported.



No.6 Ke Feng Road,Block 52,
 ShenZhen Science & Industry Park
 Noutou,ShenZhen,GuangDong,China
 Tel:+86-755-26639495-7
 Fax:+86-755-26632877
 Postcode:518057

Data: 2 File: E:\2010 report data\C\contel\ACS10Q0594R2.EM6 (108)

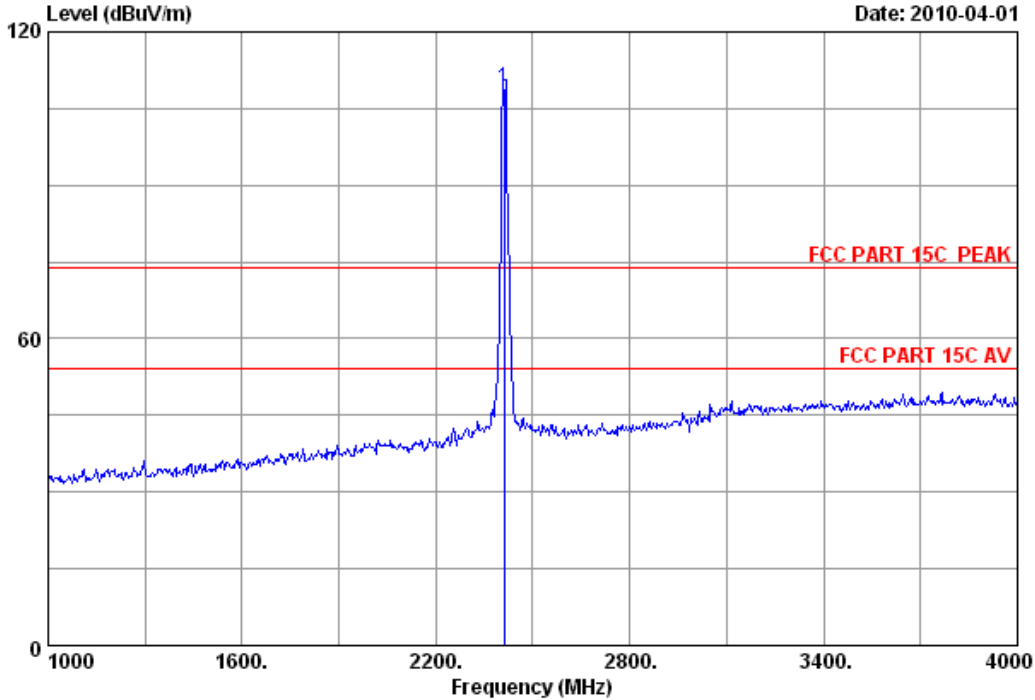

Site no. : 3m Chamber Data no. : 2
 Dis. / Ant. : 3m 3115(0911) Ant. pol. : HORIZONTAL
 Limit : FCC PART 15C PEAK
 Env. / Ins. : 23°C/54% Engineer : Paul
 EUT : Blu-ray Disc Player M/N:VBR220
 Power : DC 5V
 Test mode : Tx Mode 2412MHz

	Freq. (MHz)	Ant. Factor (dB/m)	Cable loss (dB)	Amp. Factor (dB)	Reading (dBuV)	Emission			Remark
						Level (dBuV/m)	Limits (dBuV/m)	Margin (dB)	
1	2412.000	29.45	8.72	35.95	106.79	109.01	74.00	-35.01	Peak

Remarks:

- Emission Level= Antenna Factor + Cable Loss -Amp Factor + Reading.
- The emission levels that are 20dB below the official limit are not reported.



No.6 Ke Feng Road,Block 52,
ShenZhen Science & Industry Park
Noutou,ShenZhen,GuangDong,China
Tel:+86-755-26639495-7
Fax:+86-755-26632877
Postcode:518057

Data: 7 File: E:\2010 report data\C\contel\ACS10Q0594R2.EM6 (108)

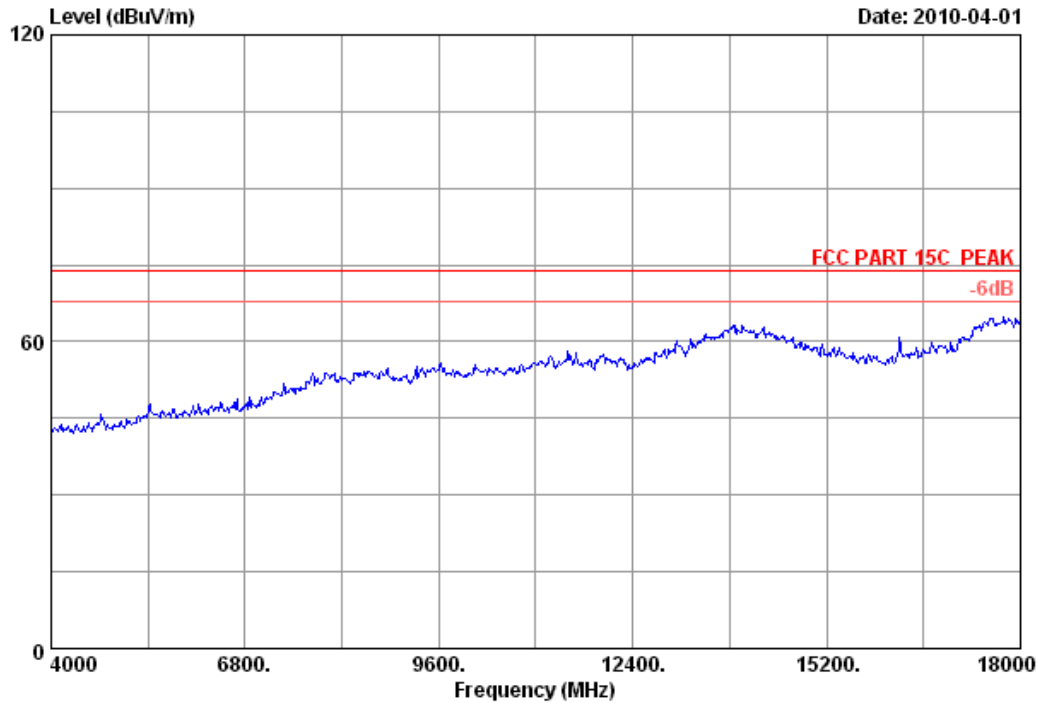

Site no.	: 3m Chamber	Data no.	: 7
Dis. / Ant.	: 3m 3115(0911)	Ant. pol.	: HORIZONTAL
Limit	: FCC PART 15C PEAK		
Env. / Ins.	: 23°C/54%	Engineer	: Paul
EUT	: Blu-ray Disc Player M/N:VBR220		
Power	: DC 5V		
Test mode	: Tx Mode 2412MHz		



No.6 Ke Feng Road,Block 52,
 ShenZhen Science & Industry Park
 Noutou,ShenZhen,GuangDong,China
 Tel:+86-755-26639495-7
 Fax:+86-755-26632877
 Postcode:518057

Data: 8 File: E:\2010 report data\C\contel\ACS10Q0594R2.EM6 (108)

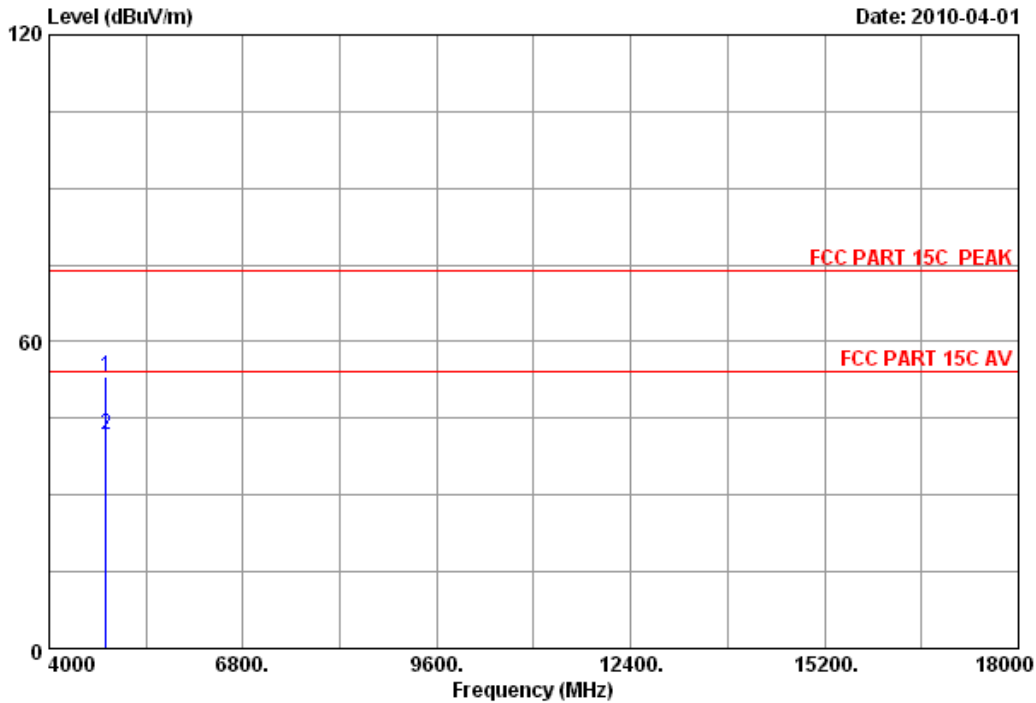

Site no. : 3m Chamber Data no. : 8
 Dis. / Ant. : 3m 3115(0911) Ant. pol. : HORIZONTAL
 Limit : FCC PART 15C PEAK
 Env. / Ins. : 23*C/54% Engineer : Paul
 EUT : Blu-ray Disc Player M/N:VBR220
 Power : DC 5V
 Test mode : Tx Mode 2412MHz

	Freq. (MHz)	Ant. Factor (dB/m)	Cable loss (dB)	Amp. Factor (dB)	Reading (dBuV)	Emission Level (dBuV/m)	Limits (dBuV/m)	Margin (dB)	Remark
1	4824.000	34.32	12.38	35.25	41.65	53.10	74.00	20.90	Peak
2	4824.000	34.32	12.38	35.25	30.28	41.73	54.00	12.27	Average

Remarks:

1. Emission Level= Antenna Factor + Cable Loss -Amp Factor + Reading.
2. The emission levels that are 20dB below the official limit are not reported.



No.6 Ke Feng Road,Block 52,
ShenZhen Science & Industry Park
Noutou,ShenZhen,GuangDong,China
Tel:+86-755-26639495-7
Fax:+86-755-26632877
Postcode:518057

Data: 9 File: E:\2010 report data\C\contel\ACS10Q0594R2.EM6 (108)

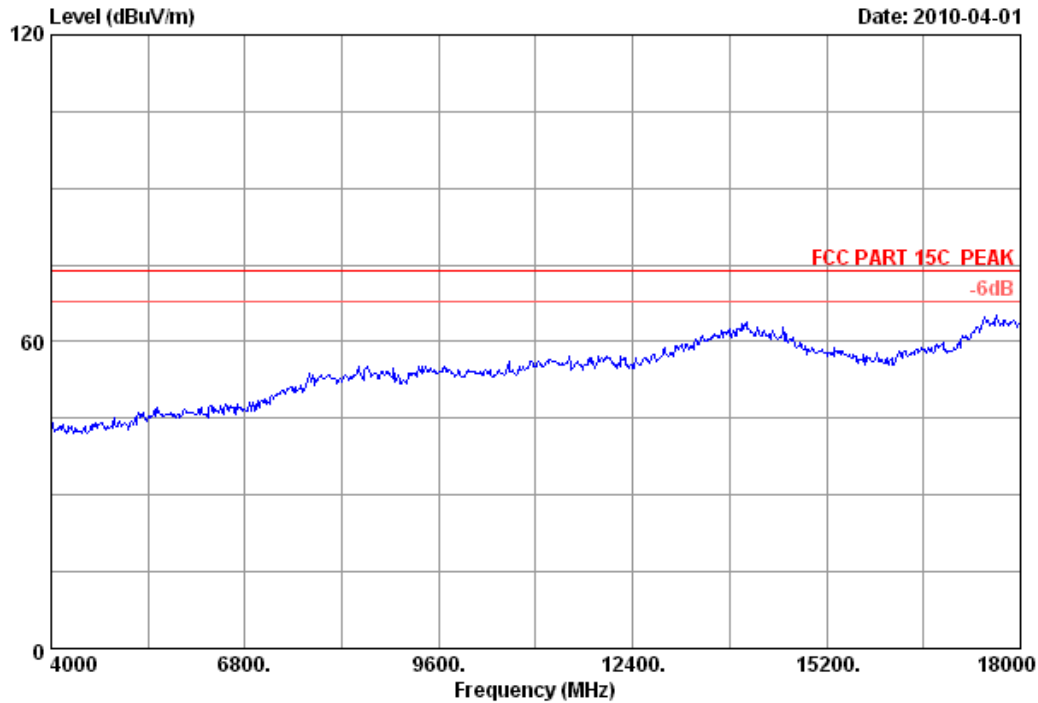

Site no.	: 3m Chamber	Data no.	: 9
Dis. / Ant.	: 3m 3115(0911)	Ant. pol.	: VERTICAL
Limit	: FCC PART 15C PEAK		
Env. / Ins.	: 23°C/54%	Engineer	: Paul
EUT	: Blu-ray Disc Player M/N:VBR220		
Power	: DC 5V		
Test mode	: Tx Mode 2412MHz		



No.6 Ke Feng Road,Block 52,
 ShenZhen Science & Industry Park
 Noutou,ShenZhen,GuangDong,China
 Tel:+86-755-26639495-7
 Fax:+86-755-26632877
 Postcode:518057

Data: 10 File: E:\2010 report data\C\contel\ACS10Q0594R2.EM6 (108)

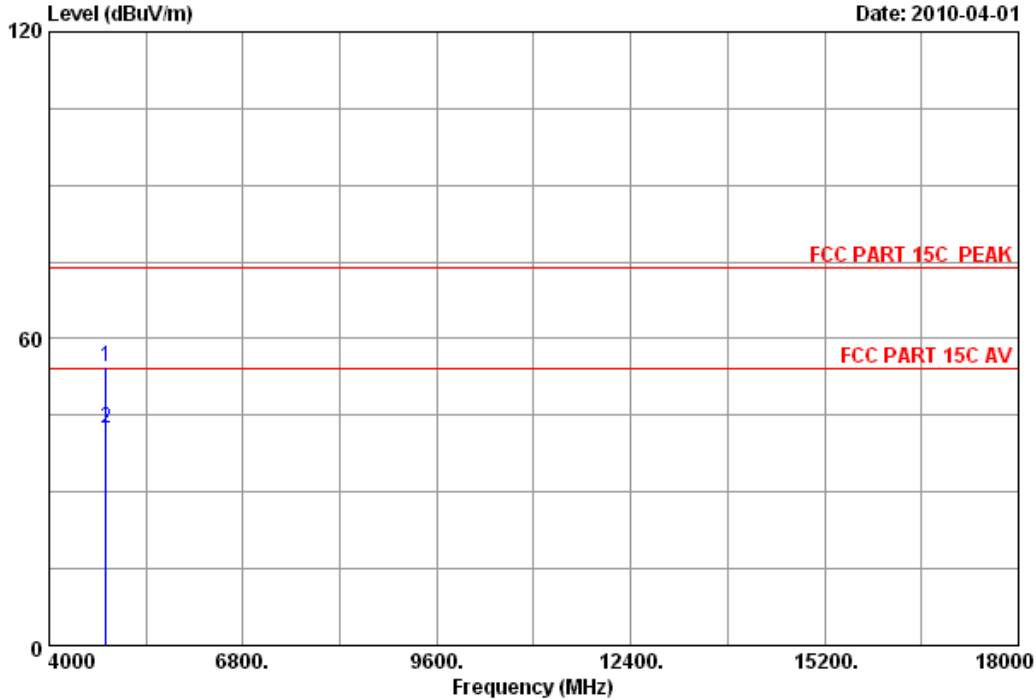

Site no. : 3m Chamber Data no. : 10
 Dis. / Ant. : 3m 3115(0911) Ant. pol. : VERTICAL
 Limit : FCC PART 15C PEAK
 Env. / Ins. : 23°C/54% Engineer : Paul
 EUT : Blu-ray Disc Player M/N:VBR220
 Power : DC 5V
 Test mode : Tx Mode 2412MHz

	Freq. (MHz)	Ant. Factor (dB/m)	Cable loss (dB)	Amp. Factor (dB)	Reading (dBuV)	Emission Level (dBuV/m)	Limits (dBuV/m)	Margin (dB)	Remark
1	4824.000	34.32	12.38	35.25	42.95	54.40	74.00	19.60	Peak
2	4824.000	34.32	12.38	35.25	31.15	42.60	54.00	11.40	Average

Remarks:

1. Emission Level= Antenna Factor + Cable Loss -Amp Factor + Reading.
2. The emission levels that are 20dB below the official limit are not reported.



No.6 Ke Feng Road,Block 52,
 ShenZhen Science & Industry Park
 Noutou,ShenZhen,GuangDong,China
 Tel:+86-755-26639495-7
 Fax:+86-755-26632877
 Postcode:518057

Data: 11 File: E:\2010 report data\C\contel\ACS10Q0594R2.EM6 (108)

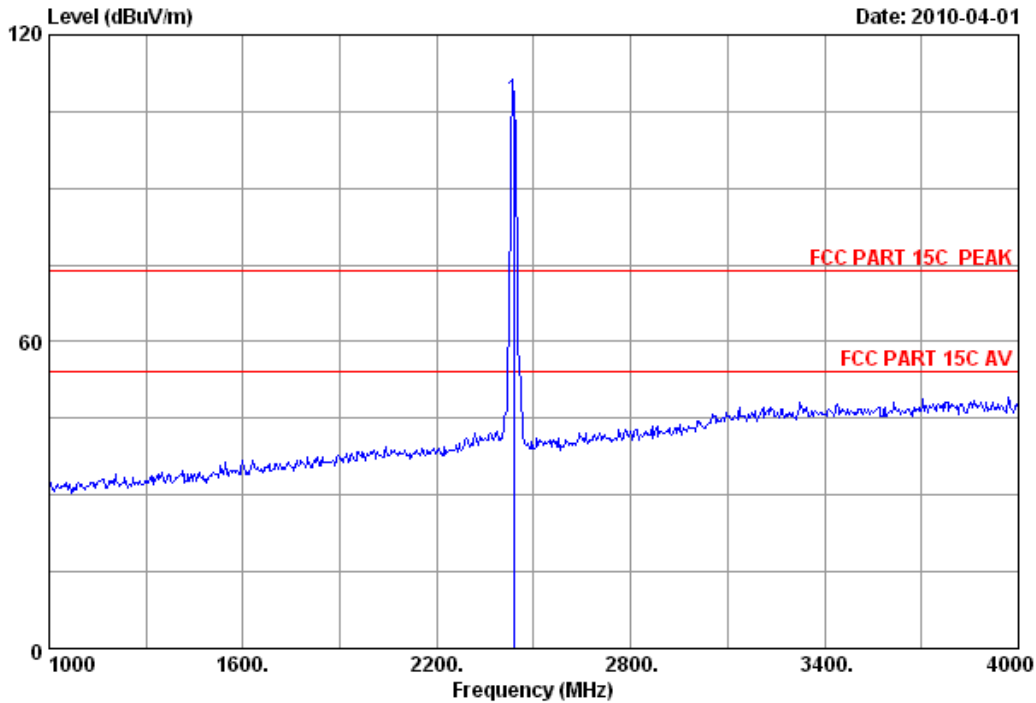

Site no. : 3m Chamber Data no. : 11
 Dis. / Ant. : 3m 3115(0911) Ant. pol. : VERTICAL
 Limit : FCC PART 15C PEAK
 Env. / Ins. : 23°C/54% Engineer : Paul
 EUT : Blu-ray Disc Player M/N:VBR220
 Power : DC 5V
 Test mode : Tx Mode 11b CH6 2437MHz

	Freq. (MHz)	Ant. Factor (dB/m)	Cable loss (dB)	Amp. Factor (dB)	Reading (dBuV)	Emission			Remark
						Level (dBuV/m)	Limits (dBuV/m)	Margin (dB)	
1	2437.000	29.47	8.77	36.06	105.21	107.39	74.00	-33.39	Peak

Remarks:

- Emission Level= Antenna Factor + Cable Loss -Amp Factor + Reading.
- The emission levels that are 20dB below the official limit are not reported.



No.6 Ke Feng Road,Block 52,
 ShenZhen Science & Industry Park
 Noutou,ShenZhen,GuangDong,China
 Tel:+86-755-26639495-7
 Fax:+86-755-26632877
 Postcode:518057

Data: 12 File: E:\2010 report data\C\contel\ACS10Q0594R2.EM6 (108)

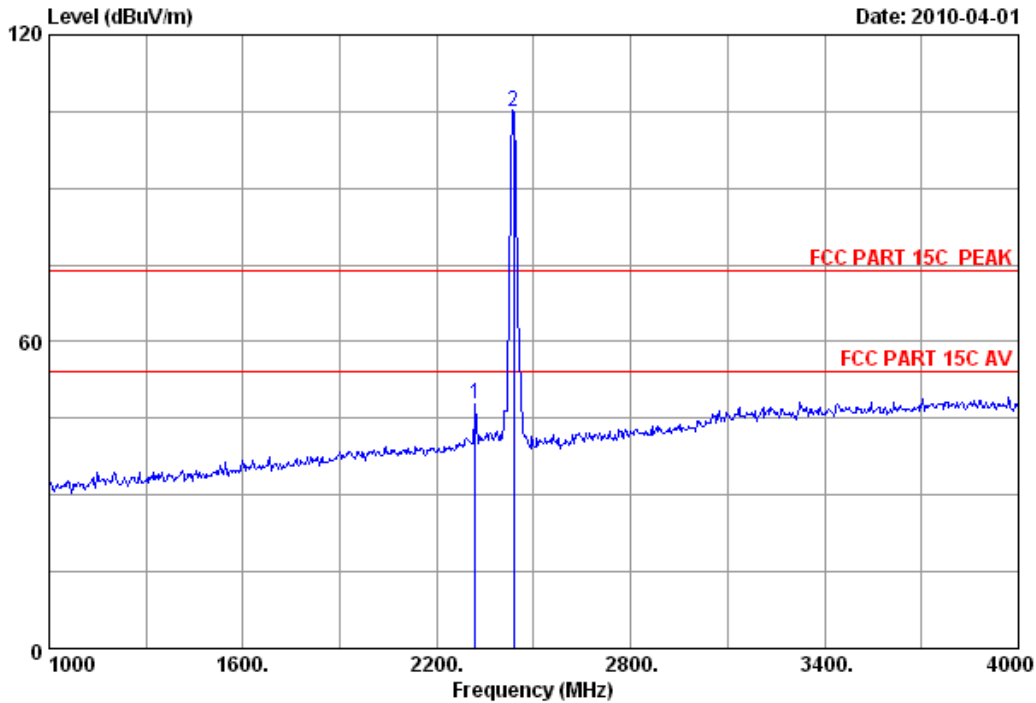

Site no. : 3m Chamber Data no. : 12
 Dis. / Ant. : 3m 3115(0911) Ant. pol. : HORIZONTAL
 Limit : FCC PART 15C PEAK
 Env. / Ins. : 23°C/54% Engineer : Paul
 EUT : Blu-ray Disc Player M/N:VBR220
 Power : DC 5V
 Test mode : Tx Mode 11b CH6 2437MHz

	Freq. (MHz)	Ant. Factor (dB/m)	Cable loss (dB)	Amp. Factor (dB)	Reading (dBuV)	Emission Level (dBuV/m)	Limits (dBuV/m)	Margin (dB)	Remark
1	2320.000	29.40	8.52	36.06	45.93	47.79	74.00	26.21	Peak
2	2437.000	29.47	8.77	36.06	102.74	104.92	74.00	-30.92	Peak

Remarks:

1. Emission Level= Antenna Factor + Cable Loss -Amp Factor + Reading.
2. The emission levels that are 20dB below the official limit are not reported.



No.6 Ke Feng Road,Block 52,
ShenZhen Science & Industry Park
Noutou,ShenZhen,GuangDong,China
Tel:+86-755-26639495-7
Fax:+86-755-26632877
Postcode:518057

Data: 13 File: E:\2010 report data\C\contel\ACS10Q0594R2.EM6 (108)

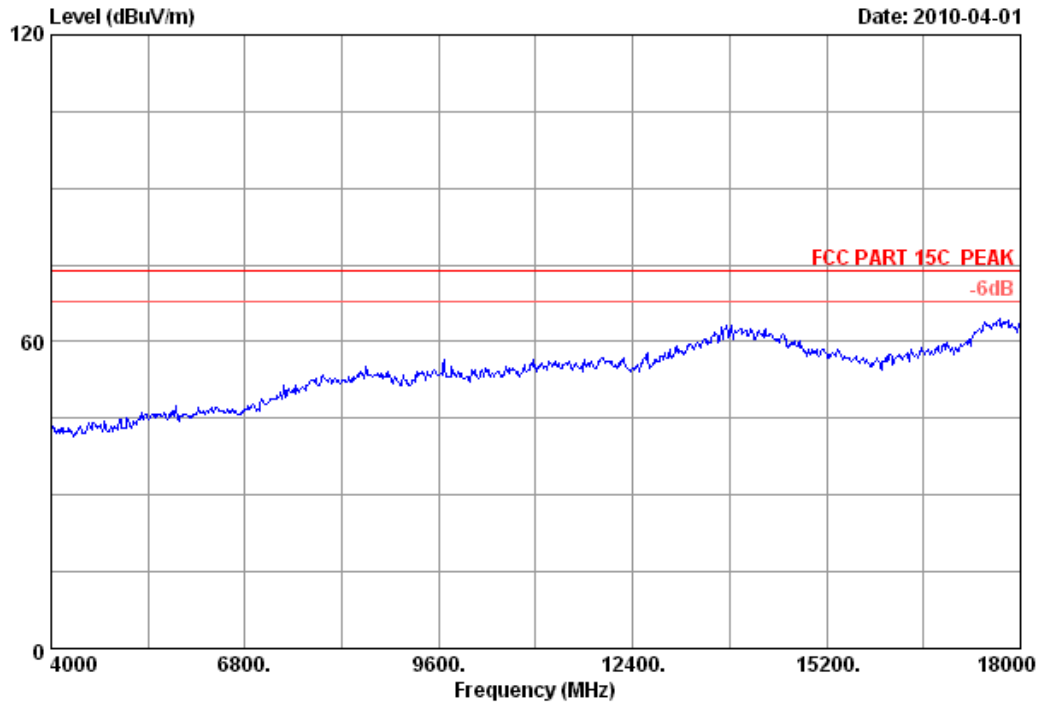

Site no.	: 3m Chamber	Data no.	: 13
Dis. / Ant.	: 3m 3115(0911)	Ant. pol.	: HORIZONTAL
Limit	: FCC PART 15C PEAK		
Env. / Ins.	: 23°C/54%	Engineer	: Paul
EUT	: Blu-ray Disc Player M/N:VBR220		
Power	: DC 5V		
Test mode	: Tx Mode 11b CH6 2437MHz		



No.6 Ke Feng Road,Block 52,
 ShenZhen Science & Industry Park
 Noutou,ShenZhen,GuangDong,China
 Tel:+86-755-26639495-7
 Fax:+86-755-26632877
 Postcode:518057

Data: 14 File: E:\2010 report data\C\contel\ACS10Q0594R2.EM6 (108)

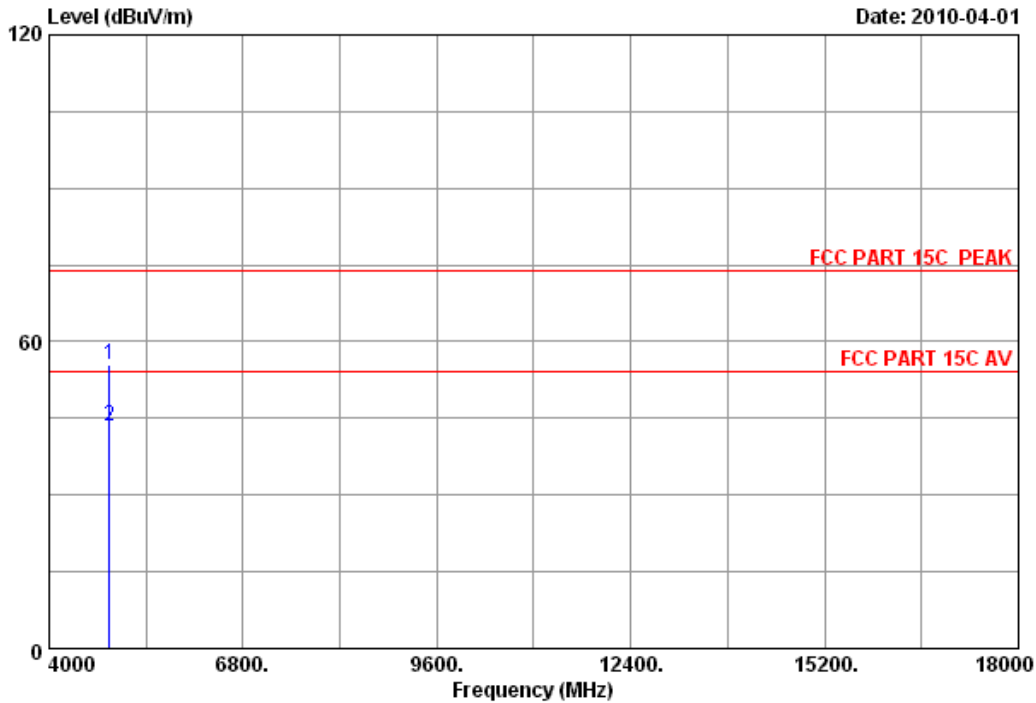

Site no. : 3m Chamber Data no. : 14
 Dis. / Ant. : 3m 3115(0911) Ant. pol. : HORIZONTAL
 Limit : FCC PART 15C PEAK
 Env. / Ins. : 23*C/54% Engineer : Paul
 EUT : Blu-ray Disc Player M/N:VBR220
 Power : DC 5V
 Test mode : Tx Mode 11b CH6 2437MHz

	Freq. (MHz)	Ant. Factor (dB/m)	Cable loss (dB)	Amp. Factor (dB)	Reading (dBuV)	Emission Level (dBuV/m)	Limits (dBuV/m)	Margin (dB)	Remark
1	4874.000	34.41	12.44	35.36	44.00	55.49	74.00	18.51	Peak
2	4874.000	34.41	12.44	35.36	31.96	43.45	54.00	10.55	Average

Remarks:

1. Emission Level= Antenna Factor + Cable Loss -Amp Factor + Reading.
2. The emission levels that are 20dB below the official limit are not reported.



No.6 Ke Feng Road,Block 52,
 ShenZhen Science & Industry Park
 Noutou,ShenZhen,GuangDong,China
 Tel:+86-755-26639495-7
 Fax:+86-755-26632877
 Postcode:518057

Data: 15 File: E:\2010 report data\C\contel\ACS10Q0594R2.EM6 (108)

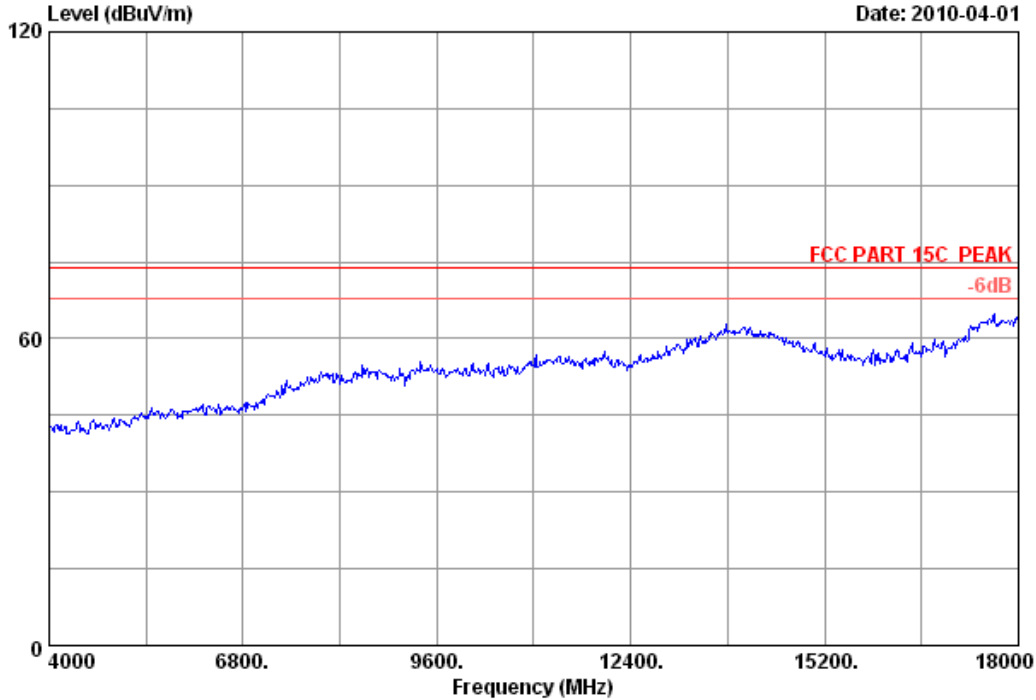

Site no.	: 3m Chamber	Data no.	: 15
Dis. / Ant.	: 3m 3115(0911)	Ant. pol.	: VERTICAL
Limit	: FCC PART 15C PEAK		
Env. / Ins.	: 23°C/54%	Engineer	: Paul
EUT	: Blu-ray Disc Player M/N:VBR220		
Power	: DC 5V		
Test mode	: Tx Mode 11b CH6 2437MHz		



No.6 Ke Feng Road,Block 52,
 ShenZhen Science & Industry Park
 Noutou,ShenZhen,GuangDong,China
 Tel:+86-755-26639495-7
 Fax:+86-755-26632877
 Postcode:518057

Data: 16 File: E:\2010 report data\C\contel\ACS10Q0594R2.EM6 (108)

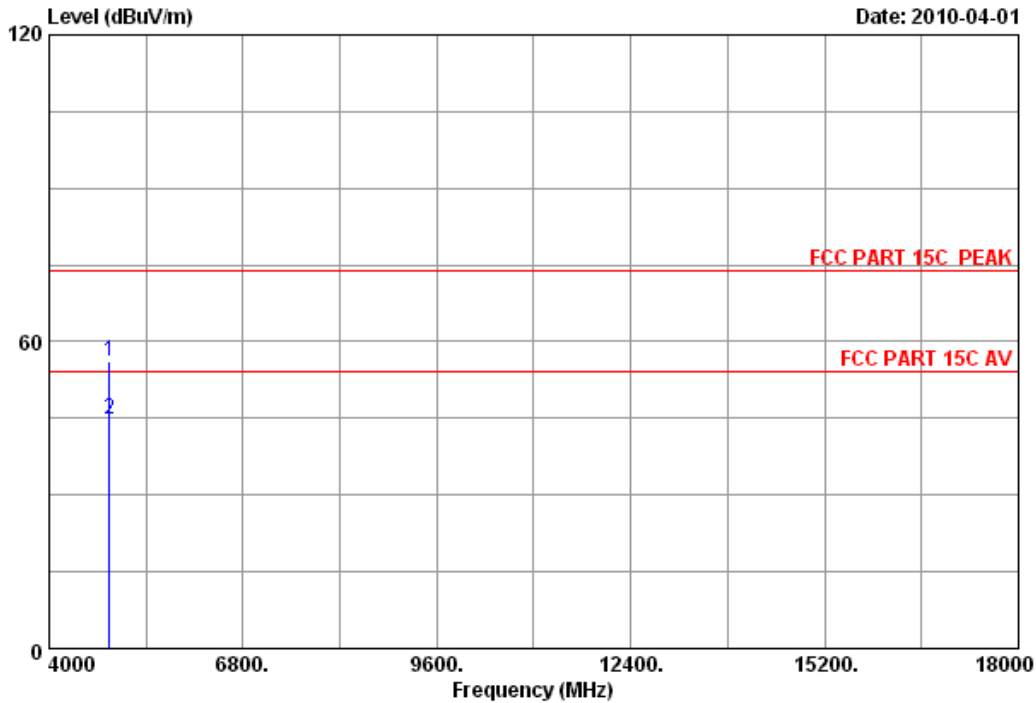

Site no. : 3m Chamber Data no. : 16
 Dis. / Ant. : 3m 3115(0911) Ant. pol. : VERTICAL
 Limit : FCC PART 15C PEAK
 Env. / Ins. : 23*C/54% Engineer : Paul
 EUT : Blu-ray Disc Player M/N:VBR220
 Power : DC 5V
 Test mode : Tx Mode 11b CH6 2437MHz

	Freq. (MHz)	Ant. Factor (dB/m)	Cable loss (dB)	Amp. Factor (dB)	Reading (dBuV)	Emission Level (dBuV/m)	Limits (dBuV/m)	Margin (dB)	Remark
1	4874.000	34.41	12.44	35.36	44.53	56.02	74.00	17.98	Peak
2	4874.000	34.41	12.44	35.36	33.25	44.74	54.00	9.26	Average

Remarks:

1. Emission Level= Antenna Factor + Cable Loss -Amp Factor + Reading.
2. The emission levels that are 20dB below the official limit are not reported.



No.6 Ke Feng Road,Block 52,
ShenZhen Science & Industry Park
Noutou,ShenZhen,GuangDong,China
Tel:+86-755-26639495-7
Fax:+86-755-26632877
Postcode:518057

Data: 17 File: E:\2010 report data\C\contel\ACS10Q0594R2.EM6 (108)

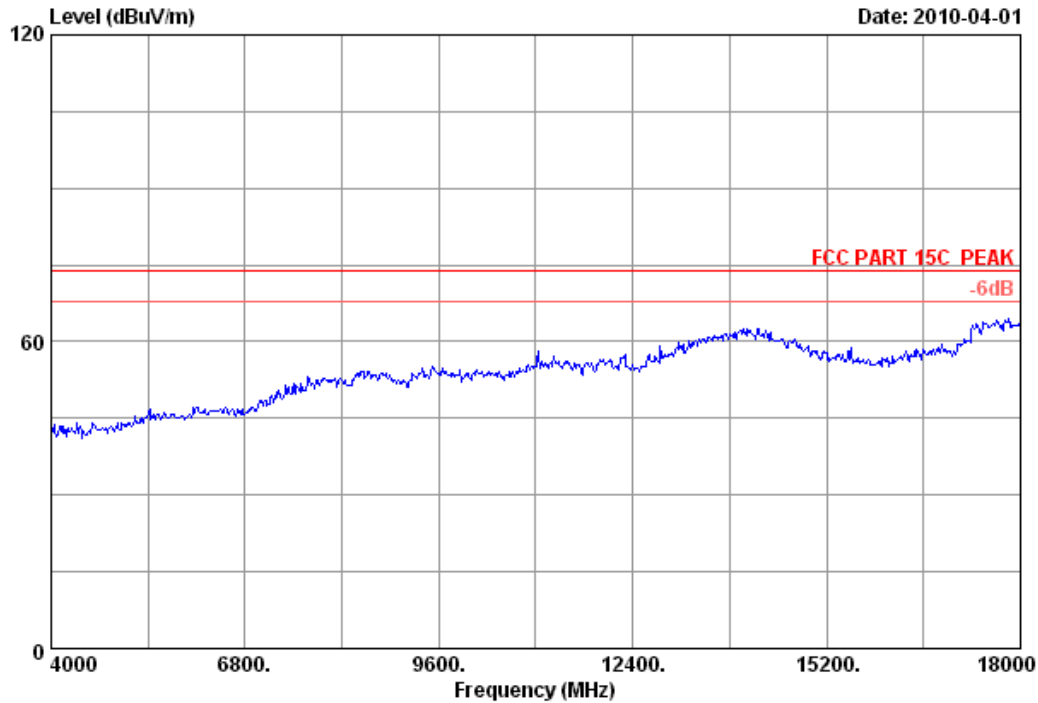

Site no.	: 3m Chamber	Data no.	: 17
Dis. / Ant.	: 3m 3115(0911)	Ant. pol.	: VERTICAL
Limit	: FCC PART 15C PEAK		
Env. / Ins.	: 23°C/54%	Engineer	: Paul
EUT	: Blu-ray Disc Player M/N:VBR220		
Power	: DC 5V		
Test mode	: Tx Mode 11b CH11	2462MHz	



No.6 Ke Feng Road,Block 52,
ShenZhen Science & Industry Park
Noutou,ShenZhen,GuangDong,China
Tel:+86-755-26639495-7
Fax:+86-755-26632877
Postcode:518057

Data: 18 File: E:\2010 report data\C\contel\ACS10Q0594R2.EM6 (108)

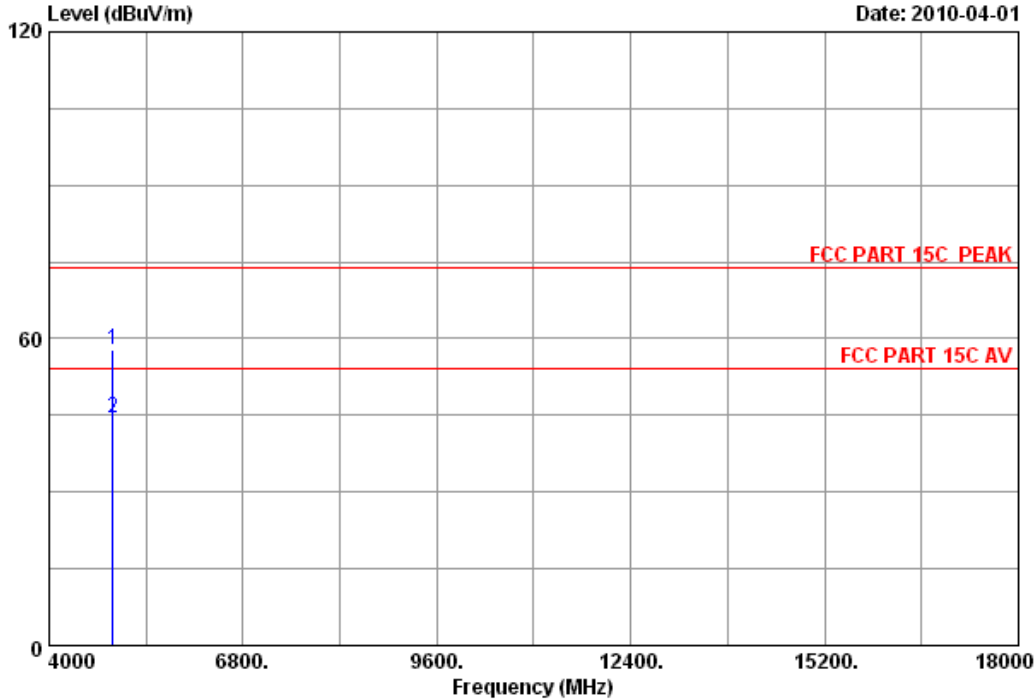

Site no. : 3m Chamber Data no. : 18
 Dis. / Ant. : 3m 3115(0911) Ant. pol. : VERTICAL
 Limit : FCC PART 15C PEAK
 Env. / Ins. : 23*C/54% Engineer : Paul
 EUT : Blu-ray Disc Player M/N:VBR220
 Power : DC 5V
 Test mode : Tx Mode 11b CH11 2462MHz

	Freq. (MHz)	Ant. Factor (dB/m)	Cable loss (dB)	Amp. Factor (dB)	Reading (dBuV)	Emission Level (dBuV/m)	Limits (dBuV/m)	Margin (dB)	Remark
1	4924.000	34.49	12.50	35.34	46.15	57.80	74.00	16.20	Peak
2	4924.000	34.49	12.50	35.34	32.64	44.29	54.00	9.71	Average

Remarks:

1. Emission Level= Antenna Factor + Cable Loss -Amp Factor + Reading.
2. The emission levels that are 20dB below the official limit are not reported.



No.6 Ke Feng Road,Block 52,
ShenZhen Science & Industry Park
Noutou,ShenZhen,GuangDong,China
Tel:+86-755-26639495-7
Fax:+86-755-26632877
Postcode:518057

Data: 19 File: E:\2010 report data\C\contel\ACS10Q0594R2.EM6 (108)

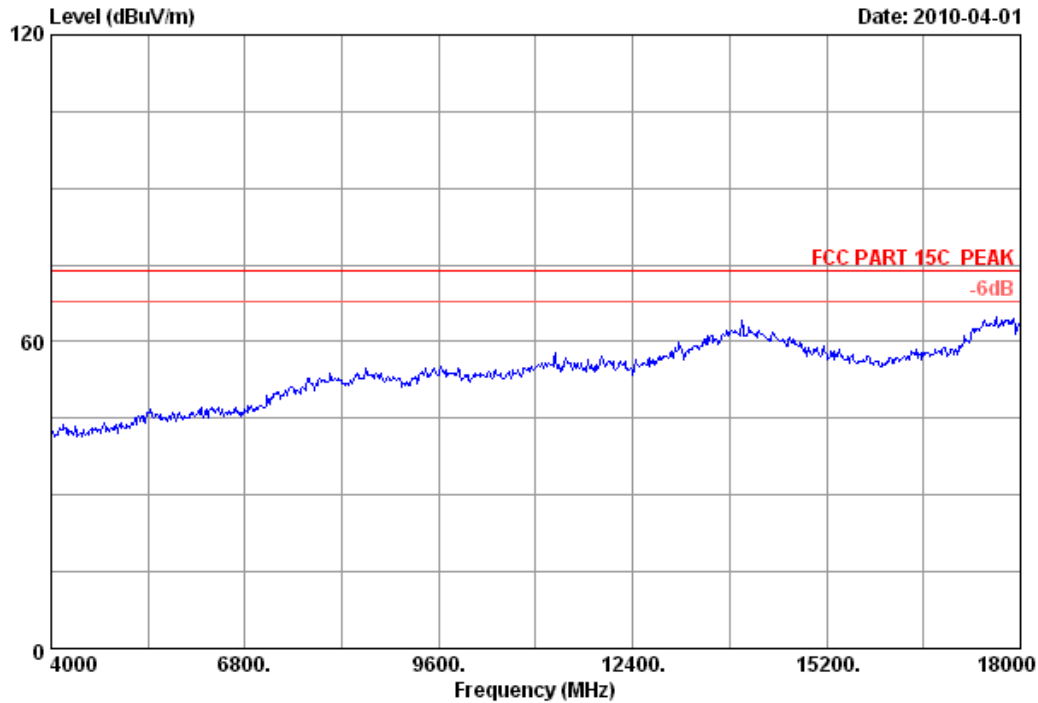

Site no.	: 3m Chamber	Data no.	: 19
Dis. / Ant.	: 3m 3115(0911)	Ant. pol.	: HORIZONTAL
Limit	: FCC PART 15C PEAK		
Env. / Ins.	: 23°C/54%	Engineer	: Paul
EUT	: Blu-ray Disc Player M/N:VBR220		
Power	: DC 5V		
Test mode	: Tx Mode 11b CH11	2462MHz	



No.6 Ke Feng Road,Block 52,
 ShenZhen Science & Industry Park
 Noutou,ShenZhen,GuangDong,China
 Tel:+86-755-26639495-7
 Fax:+86-755-26632877
 Postcode:518057

Data: 20 File: E:\2010 report data\C\contel\ACS10Q0594R2.EM6 (108)

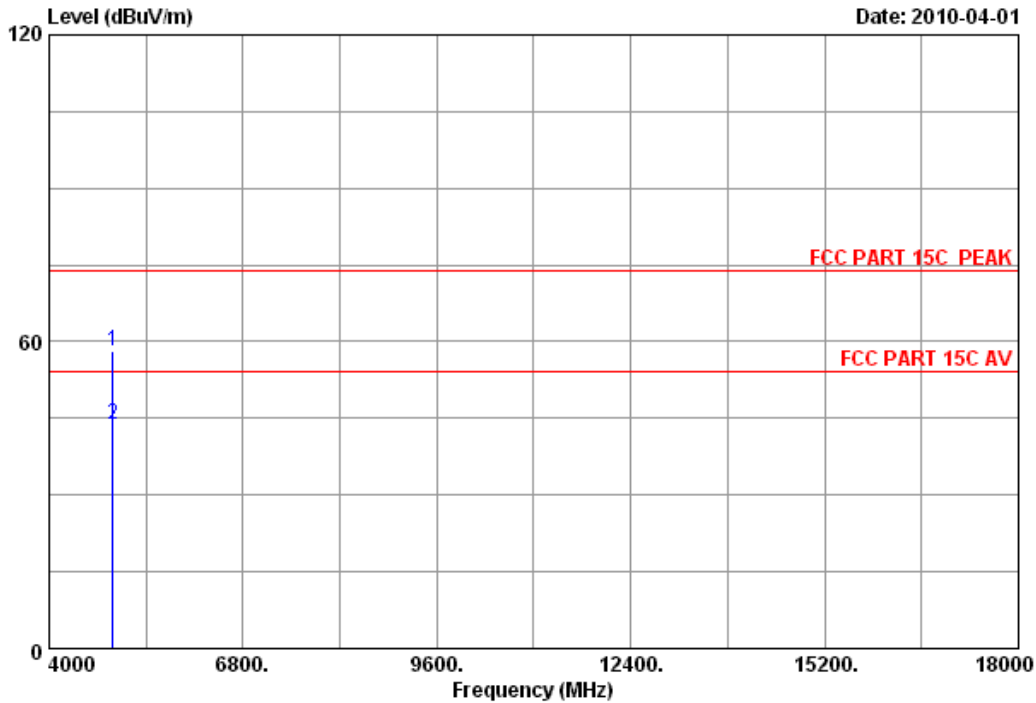

Site no. : 3m Chamber Data no. : 20
 Dis. / Ant. : 3m 3115(0911) Ant. pol. : HORIZONTAL
 Limit : FCC PART 15C PEAK
 Env. / Ins. : 23*C/54% Engineer : Paul
 EUT : Blu-ray Disc Player M/N:VBR220
 Power : DC 5V
 Test mode : Tx Mode 11b CH11 2462MHz

	Freq. (MHz)	Ant. Factor (dB/m)	Cable loss (dB)	Amp. Factor (dB)	Reading (dBuV)	Emission Level (dBuV/m)	Limits (dBuV/m)	Margin (dB)	Remark
1	4924.000	34.49	12.50	35.34	46.51	58.16	74.00	15.84	Peak
2	4924.000	34.49	12.50	35.34	32.19	43.84	54.00	10.16	Average

Remarks:

1. Emission Level= Antenna Factor + Cable Loss -Amp Factor + Reading.
2. The emission levels that are 20dB below the official limit are not reported.



No.6 Ke Feng Road,Block 52,
 ShenZhen Science & Industry Park
 Noutou,ShenZhen,GuangDong,China
 Tel:+86-755-26639495-7
 Fax:+86-755-26632877
 Postcode:518057

Data: 21 File: E:\2010 report data\C\contel\ACS10Q0594R2.EM6 (108)

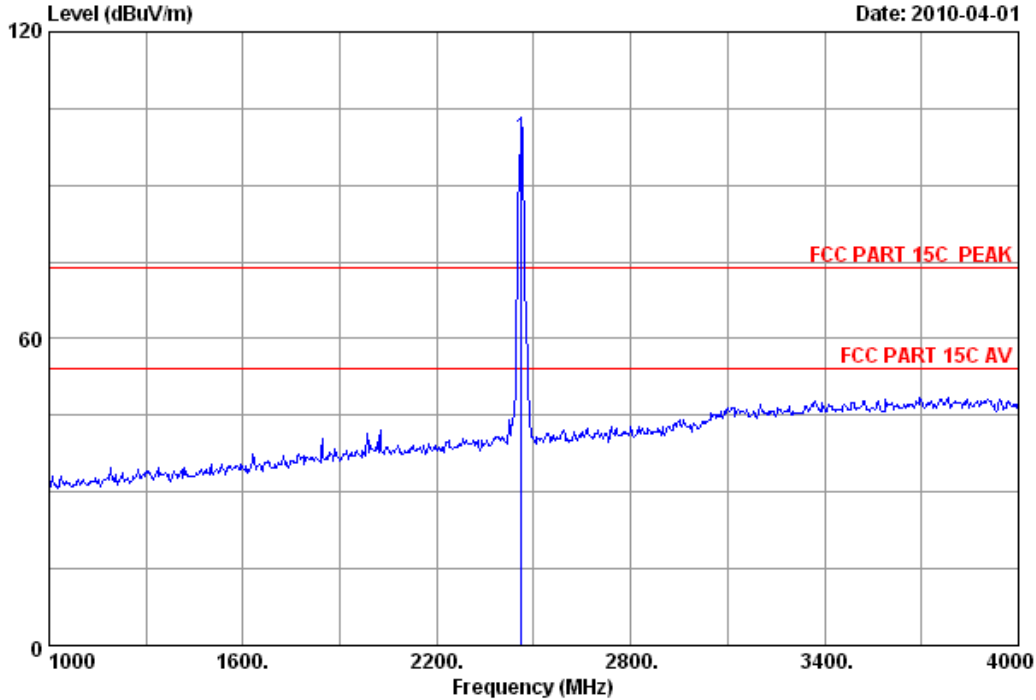

Site no. : 3m Chamber Data no. : 21
 Dis. / Ant. : 3m 3115(0911) Ant. pol. : HORIZONTAL
 Limit : FCC PART 15C PEAK
 Env. / Ins. : 23°C/54% Engineer : Paul
 EUT : Blu-ray Disc Player M/N:VBR220
 Power : DC 5V
 Test mode : Tx Mode 11b CH11 2462MHz

	Freq. (MHz)	Ant. Factor (dB/m)	Cable loss (dB)	Amp. Factor (dB)	Reading (dBuV)	Emission			Remark
						Level (dBuV/m)	Limits (dBuV/m)	Margin (dB)	
1	2462.000	29.48	8.82	36.02	96.98	99.26	74.00	-25.26	Peak

Remarks:

1. Emission Level= Antenna Factor + Cable Loss -Amp Factor + Reading.
2. The emission levels that are 20dB below the official limit are not reported.



No.6 Ke Feng Road,Block 52,
 ShenZhen Science & Industry Park
 Noutou,ShenZhen,GuangDong,China
 Tel:+86-755-26639495-7
 Fax:+86-755-26632877
 Postcode:518057

Data: 22 File: E:\2010 report data\C\contel\ACS10Q0594R2.EM6 (108)

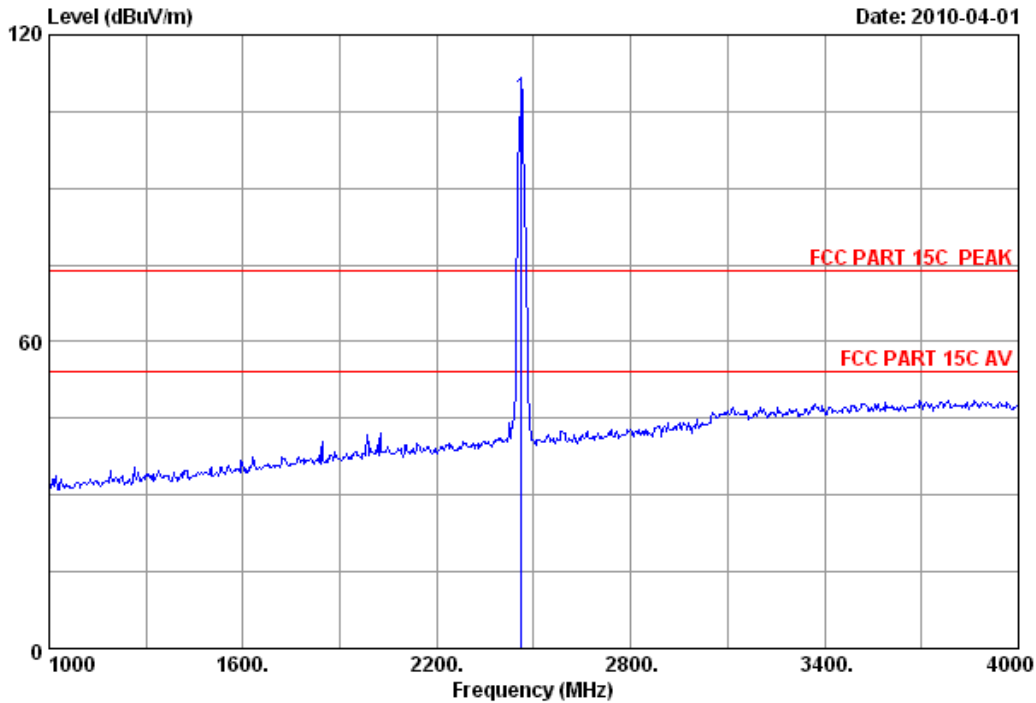

Site no. : 3m Chamber Data no. : 22
 Dis. / Ant. : 3m 3115(0911) Ant. pol. : VERTICAL
 Limit : FCC PART 15C PEAK
 Env. / Ins. : 23°C/54% Engineer : Paul
 EUT : Blu-ray Disc Player M/N:VBR220
 Power : DC 5V
 Test mode : Tx Mode 11b CH11 2462MHz

	Freq. (MHz)	Ant. Factor (dB/m)	Cable loss (dB)	Amp. Factor (dB)	Reading (dBuV)	Emission			
						Level (dBuV/m)	Limits (dBuV/m)	Margin (dB)	
1	2462.000	29.48	8.82	36.02	105.38	107.66	74.00	-33.66	Peak

Remarks:

- Emission Level= Antenna Factor + Cable Loss -Amp Factor + Reading.
- The emission levels that are 20dB below the official limit are not reported.



No.6 Ke Feng Road,Block 52,
 ShenZhen Science & Industry Park
 Noutou,ShenZhen,GuangDong,China
 Tel:+86-755-26639495-7
 Fax:+86-755-26632877
 Postcode:518057

Data: 31 File: E:\2010 report data\C\contel\ACS10Q0594R2.EM6 (108)

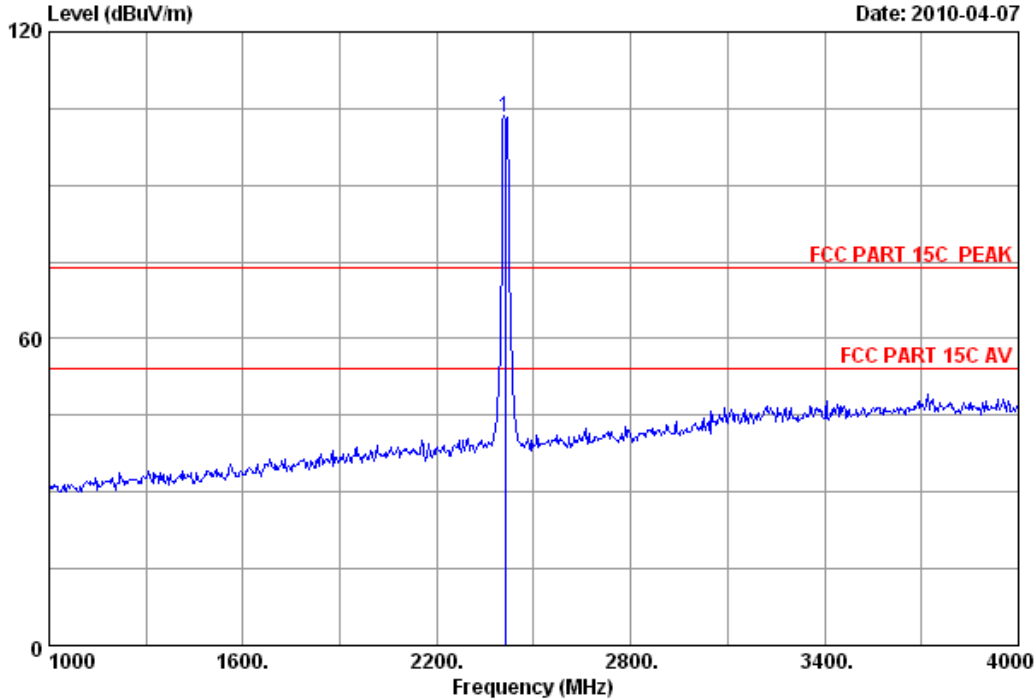

Site no. : 3m Chamber Data no. : 31
 Dis. / Ant. : 3m 3115(0911) Ant. pol. : VERTICAL
 Limit : FCC PART 15C PEAK
 Env. / Ins. : 23°C/54% Engineer : Paul
 EUT : Blu-ray Disc Player M/N:VBR220
 Power : DC 5V
 Test mode : Tx Mode 11g CH1 2412MHz

	Freq. (MHz)	Ant. Factor (dB/m)	Cable loss (dB)	Amp. Factor (dB)	Reading (dBUV)	Emission			Remark
						Level (dBUV/m)	Limits (dBUV/m)	Margin (dB)	
1	2412.000	29.45	8.72	35.95	100.99	103.21	74.00	-29.21	Peak

Remarks:

1. Emission Level= Antenna Factor + Cable Loss -Amp Factor + Reading.
2. The emission levels that are 20dB below the official limit are not reported.



No.6 Ke Feng Road,Block 52,
 ShenZhen Science & Industry Park
 Noutou,ShenZhen,GuangDong,China
 Tel:+86-755-26639495-7
 Fax:+86-755-26632877
 Postcode:518057

Data: 32 File: E:\2010 report data\C\contel\ACS10Q0594R2.EM6 (108)

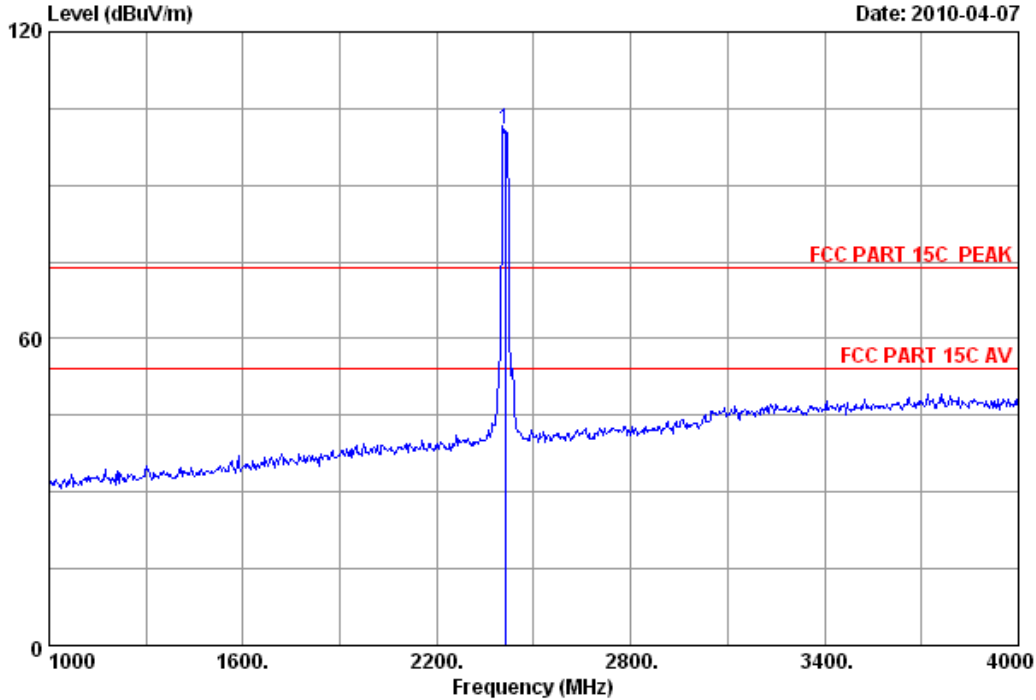

Site no. : 3m Chamber Data no. : 32
 Dis. / Ant. : 3m 3115(0911) Ant. pol. : HORIZONTAL
 Limit : FCC PART 15C PEAK
 Env. / Ins. : 23°C/54% Engineer : Paul
 EUT : Blu-ray Disc Player M/N:VBR220
 Power : DC 5V
 Test mode : Tx Mode 11g CH1 2412MHz

	Freq. (MHz)	Ant. Factor (dB/m)	Cable loss (dB)	Amp. Factor (dB)	Reading (dBuV)	Emission			Remark
						Level (dBuV/m)	Limits (dBuV/m)	Margin (dB)	
1	2412.000	29.45	8.72	35.95	98.68	100.90	74.00	-26.90	Peak

Remarks:

1. Emission Level= Antenna Factor + Cable Loss -Amp Factor + Reading.
2. The emission levels that are 20dB below the official limit are not reported.



No.6 Ke Feng Road,Block 52,
ShenZhen Science & Industry Park
Noutou,ShenZhen,GuangDong,China
Tel:+86-755-26639495-7
Fax:+86-755-26632877
Postcode:518057

Data: 33

File: E:\2010 report data\C\contel\ACS10Q0594R2.EM6 (108)

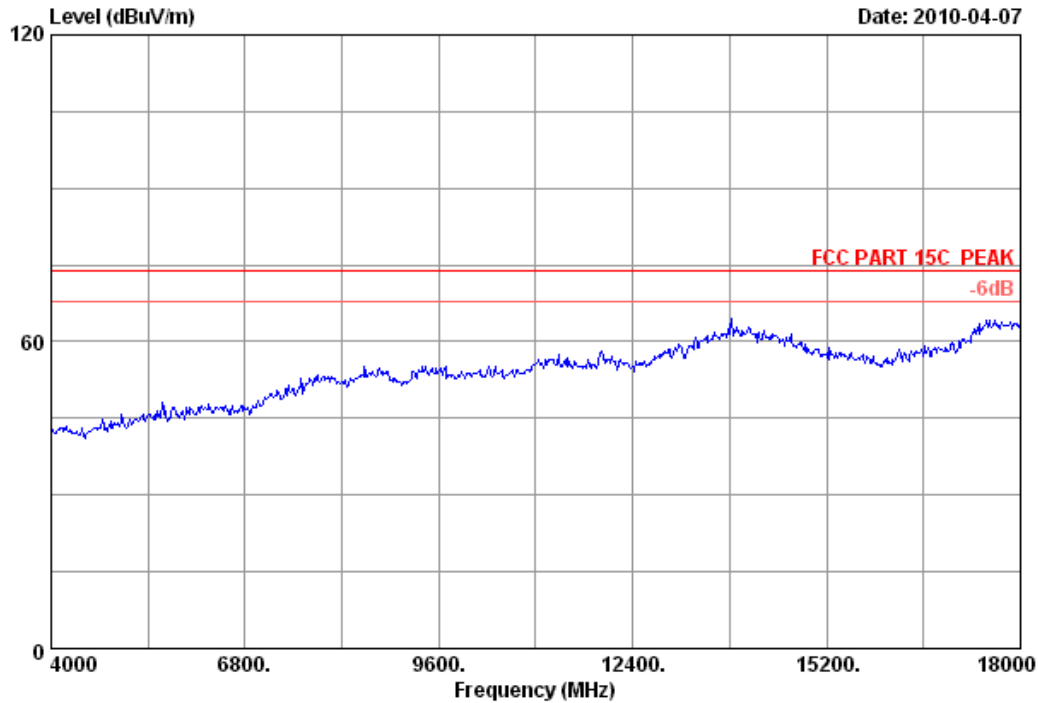

Site no.	: 3m Chamber	Data no.	: 33
Dis. / Ant.	: 3m 3115(0911)	Ant. pol.	: HORIZONTAL
Limit	: FCC PART 15C PEAK		
Env. / Ins.	: 23°C/54%	Engineer	: Paul
EUT	: Blu-ray Disc Player M/N:VBR220		
Power	: DC 5V		
Test mode	: Tx Mode 11g CH1 2412MHz		



No.6 Ke Feng Road,Block 52,
 ShenZhen Science & Industry Park
 Noutou,ShenZhen,GuangDong,China
 Tel:+86-755-26639495-7
 Fax:+86-755-26632877
 Postcode:518057

Data: 34 File: E:\2010 report data\C\contel\ACS10Q0594R2.EM6 (108)

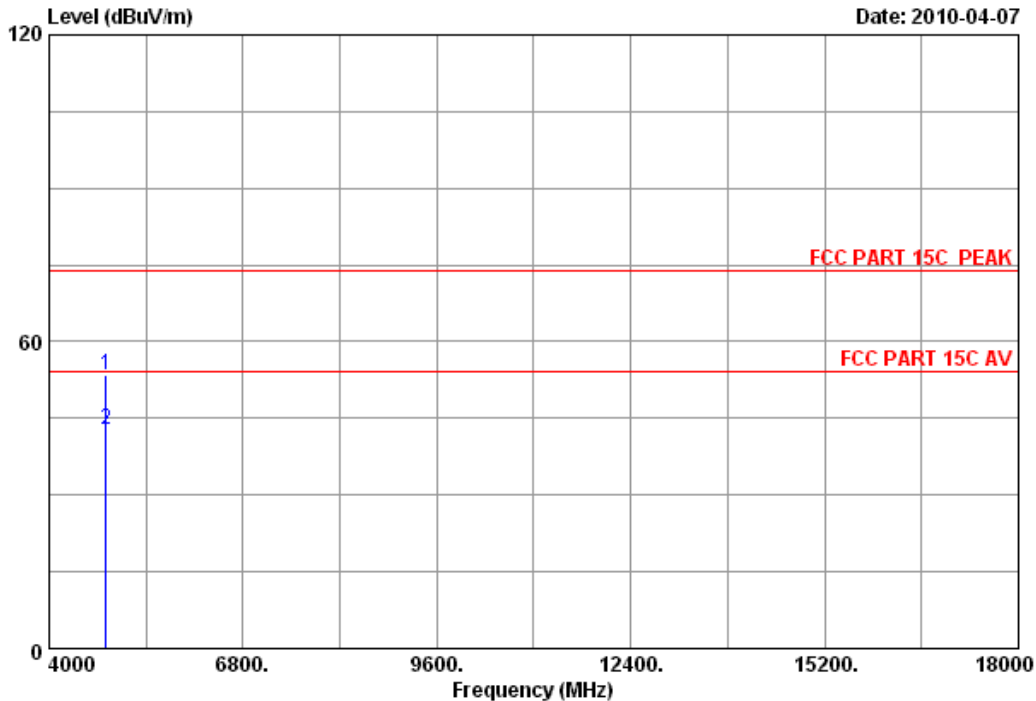

Site no. : 3m Chamber Data no. : 34
 Dis. / Ant. : 3m 3115(0911) Ant. pol. : HORIZONTAL
 Limit : FCC PART 15C PEAK
 Env. / Ins. : 23°C/54% Engineer : Paul
 EUT : Blu-ray Disc Player M/N:VBR220
 Power : DC 5V
 Test mode : Tx Mode 11g CH1 2412MHz

	Freq. (MHz)	Ant. Factor (dB/m)	Cable loss (dB)	Amp. Factor (dB)	Reading (dBuV)	Emission Level (dBuV/m)	Limits (dBuV/m)	Margin (dB)	Remark
1	4824.000	34.32	12.38	35.25	41.94	53.39	74.00	20.61	Peak
2	4824.000	34.32	12.38	35.25	31.25	42.70	54.00	11.30	Average

Remarks:

1. Emission Level= Antenna Factor + Cable Loss -Amp Factor + Reading.
2. The emission levels that are 20dB below the official limit are not reported.



No.6 Ke Feng Road,Block 52,
 ShenZhen Science & Industry Park
 Noutou,ShenZhen,GuangDong,China
 Tel:+86-755-26639495-7
 Fax:+86-755-26632877
 Postcode:518057

Data: 35 File: E:\2010 report data\C\contel\ACS10Q0594R2.EM6 (108)

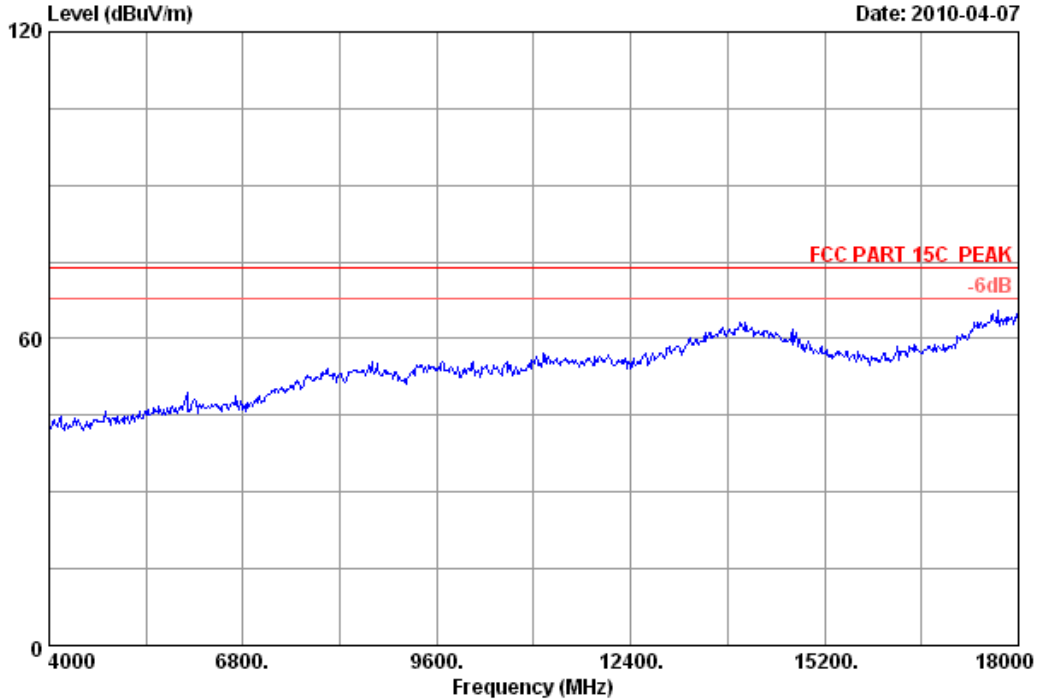

Site no.	: 3m Chamber	Data no.	: 35
Dis. / Ant.	: 3m 3115(0911)	Ant. pol.	: VERTICAL
Limit	: FCC PART 15C PEAK		
Env. / Ins.	: 23°C/54%	Engineer	: Paul
EUT	: Blu-ray Disc Player M/N:VBR220		
Power	: DC 5V		
Test mode	: Tx Mode 11g CH1 2412MHz		



No.6 Ke Feng Road,Block 52,
 ShenZhen Science & Industry Park
 Noutou,ShenZhen,GuangDong,China
 Tel:+86-755-26639495-7
 Fax:+86-755-26632877
 Postcode:518057

Data: 36 File: E:\2010 report data\C\contel\ACS10Q0594R2.EM6 (108)

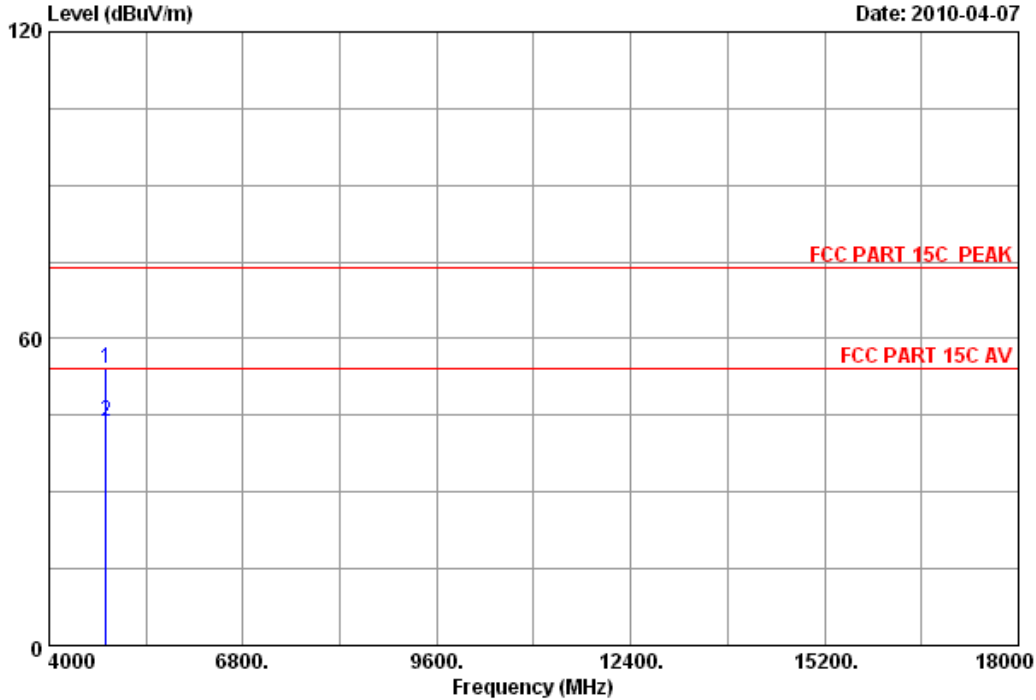

Site no. : 3m Chamber Data no. : 36
 Dis. / Ant. : 3m 3115(0911) Ant. pol. : VERTICAL
 Limit : FCC PART 15C PEAK
 Env. / Ins. : 23°C/54% Engineer : Paul
 EUT : Blu-ray Disc Player M/N:VBR220
 Power : DC 5V
 Test mode : Tx Mode 11g CH1 2412MHz

	Freq. (MHz)	Ant. Factor (dB/m)	Cable loss (dB)	Amp. Factor (dB)	Reading (dBuV)	Emission Level (dBuV/m)	Limits (dBuV/m)	Margin (dB)	Remark
1	4824.000	34.32	12.38	35.25	42.82	54.27	74.00	19.73	Peak
2	4824.000	34.32	12.38	35.25	32.47	43.92	54.00	10.08	Average

Remarks:
 1. Emission Level= Antenna Factor + Cable Loss -Amp Factor + Reading.
 2. The emission levels that are 20dB below the official limit are not reported.



No.6 Ke Feng Road,Block 52,
ShenZhen Science & Industry Park
Noutou,ShenZhen,GuangDong,China
Tel:+86-755-26639495-7
Fax:+86-755-26632877
Postcode:518057

Data: 37

File: E:\2010 report data\C\contel\ACS10Q0594R2.EM6 (108)

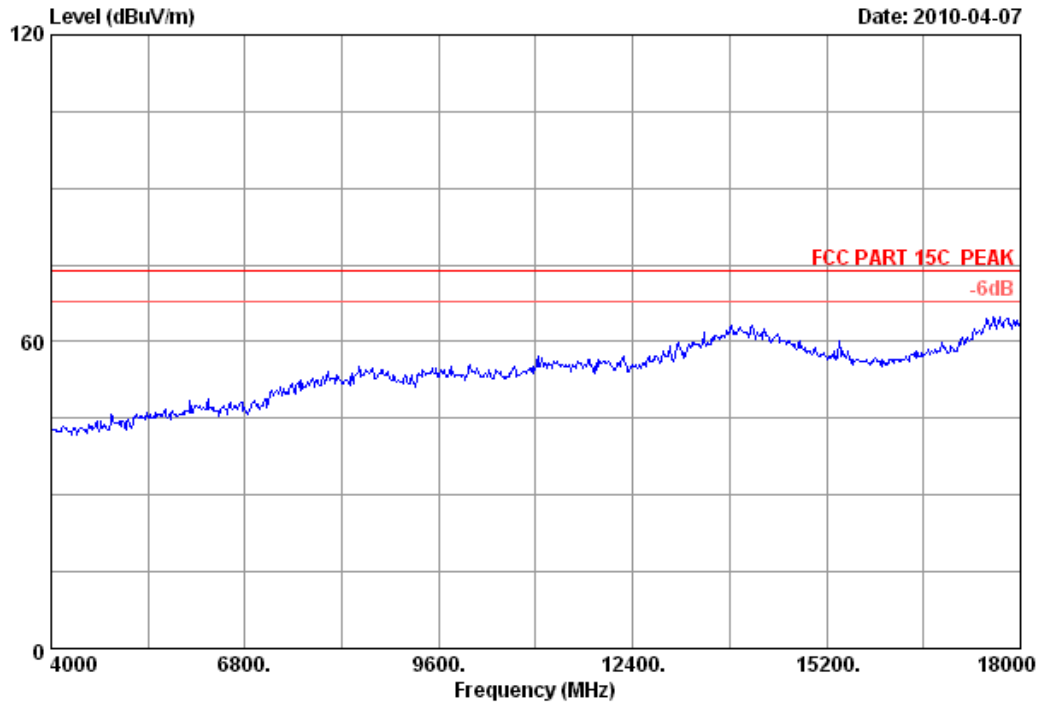

Site no.	: 3m Chamber	Data no.	: 37
Dis. / Ant.	: 3m 3115(0911)	Ant. pol.	: VERTICAL
Limit	: FCC PART 15C PEAK		
Env. / Ins.	: 23°C/54%	Engineer	: Paul
EUT	: Blu-ray Disc Player M/N:VBR220		
Power	: DC 5V		
Test mode	: Tx Mode 11g CH6 2437MHz		



No.6 Ke Feng Road,Block 52,
 ShenZhen Science & Industry Park
 Noutou,ShenZhen,GuangDong,China
 Tel:+86-755-26639495-7
 Fax:+86-755-26632877
 Postcode:518057

Data: 38 File: E:\2010 report data\C\contel\ACS10Q0594R2.EM6 (108)

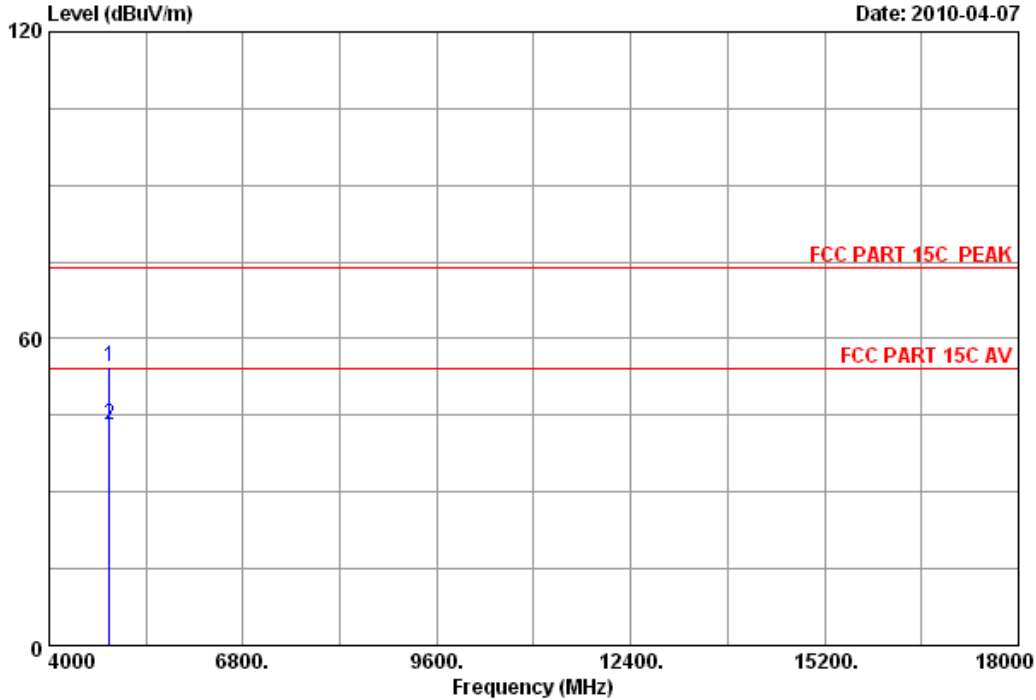

Site no. : 3m Chamber Data no. : 38
 Dis. / Ant. : 3m 3115(0911) Ant. pol. : VERTICAL
 Limit : FCC PART 15C PEAK
 Env. / Ins. : 23*C/54% Engineer : Paul
 EUT : Blu-ray Disc Player M/N:VBR220
 Power : DC 5V
 Test mode : Tx Mode 11g CH6 2437MHz

	Freq. (MHz)	Ant. Factor (dB/m)	Cable loss (dB)	Amp. Factor (dB)	Reading (dBuV)	Emission Level (dBuV/m)	Limits (dBuV/m)	Margin (dB)	Remark
1	4874.000	34.41	12.44	35.36	43.14	54.63	74.00	19.37	Peak
2	4874.000	34.41	12.44	35.36	31.47	42.96	54.00	11.04	Average

Remarks:
 1. Emission Level= Antenna Factor + Cable Loss -Amp Factor + Reading.
 2. The emission levels that are 20dB below the official limit are not reported.



No.6 Ke Feng Road,Block 52,
ShenZhen Science & Industry Park
Noutou,ShenZhen,GuangDong,China
Tel:+86-755-26639495-7
Fax:+86-755-26632877
Postcode:518057

Data: 39

File: E:\2010 report data\C\contel\ACS10Q0594R2.EM6 (108)

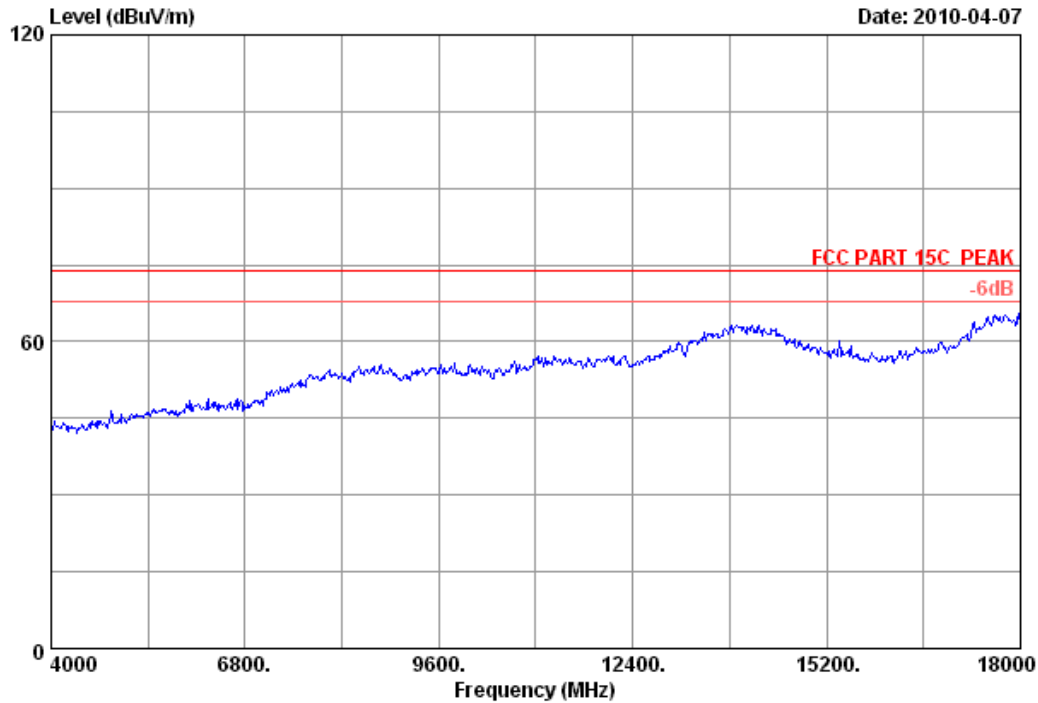

Site no.	: 3m Chamber	Data no.	: 39
Dis. / Ant.	: 3m 3115(0911)	Ant. pol.	: HORIZONTAL
Limit	: FCC PART 15C PEAK		
Env. / Ins.	: 23°C/54%	Engineer	: Paul
EUT	: Blu-ray Disc Player M/N:VBR220		
Power	: DC 5V		
Test mode	: Tx Mode 11g CH6 2437MHz		



No.6 Ke Feng Road,Block 52,
ShenZhen Science & Industry Park
Noutou,ShenZhen,GuangDong,China
Tel:+86-755-26639495-7
Fax:+86-755-26632877
Postcode:518057

Data: 40 File: E:\2010 report data\C\contel\ACS10Q0594R2.EM6 (108)

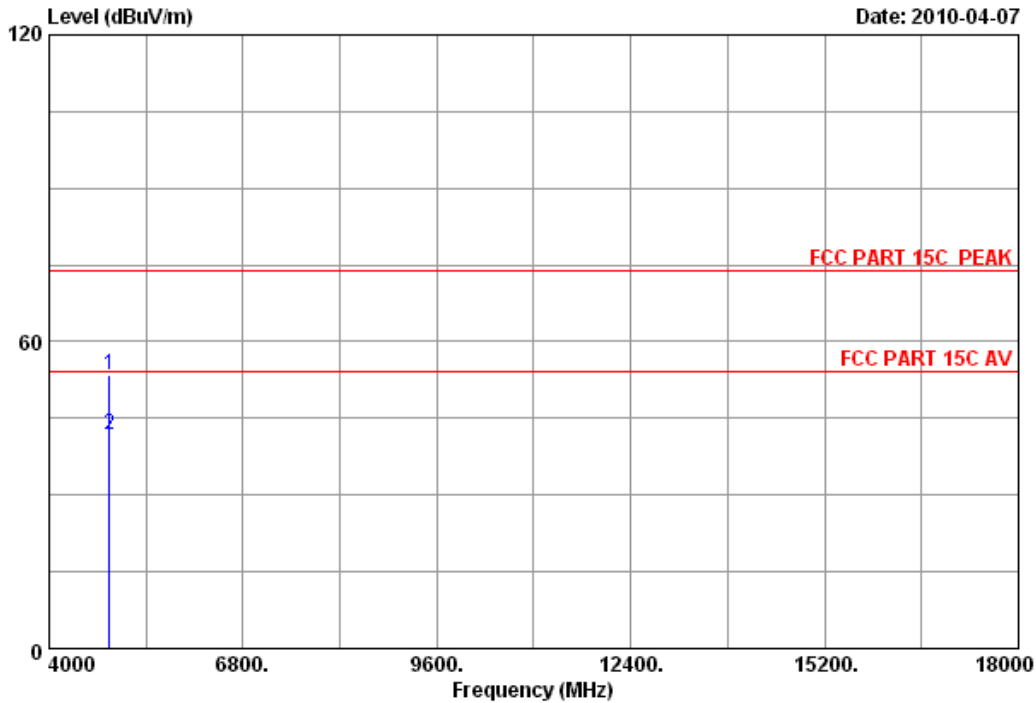

Site no. : 3m Chamber Data no. : 40
 Dis. / Ant. : 3m 3115(0911) Ant. pol. : HORIZONTAL
 Limit : FCC PART 15C PEAK
 Env. / Ins. : 23*C/54% Engineer : Paul
 EUT : Blu-ray Disc Player M/N:VBR220
 Power : DC 5V
 Test mode : Tx Mode 11g CH6 2437MHz

	Freq. (MHz)	Ant. Factor (dB/m)	Cable loss (dB)	Amp. Factor (dB)	Reading (dBuV)	Emission Level (dBuV/m)	Limits (dBuV/m)	Margin (dB)	Remark
1	4874.000	34.41	12.44	35.36	41.99	53.48	74.00	20.52	Peak
2	4874.000	34.41	12.44	35.36	30.27	41.76	54.00	12.24	Average

Remarks:

1. Emission Level= Antenna Factor + Cable Loss -Amp Factor + Reading.
2. The emission levels that are 20dB below the official limit are not reported.



No.6 Ke Feng Road,Block 52,
 ShenZhen Science & Industry Park
 Noutou,ShenZhen,GuangDong,China
 Tel:+86-755-26639495-7
 Fax:+86-755-26632877
 Postcode:518057

Data: 41 File: E:\2010 report data\C\contel\ACS10Q0594R2.EM6 (108)

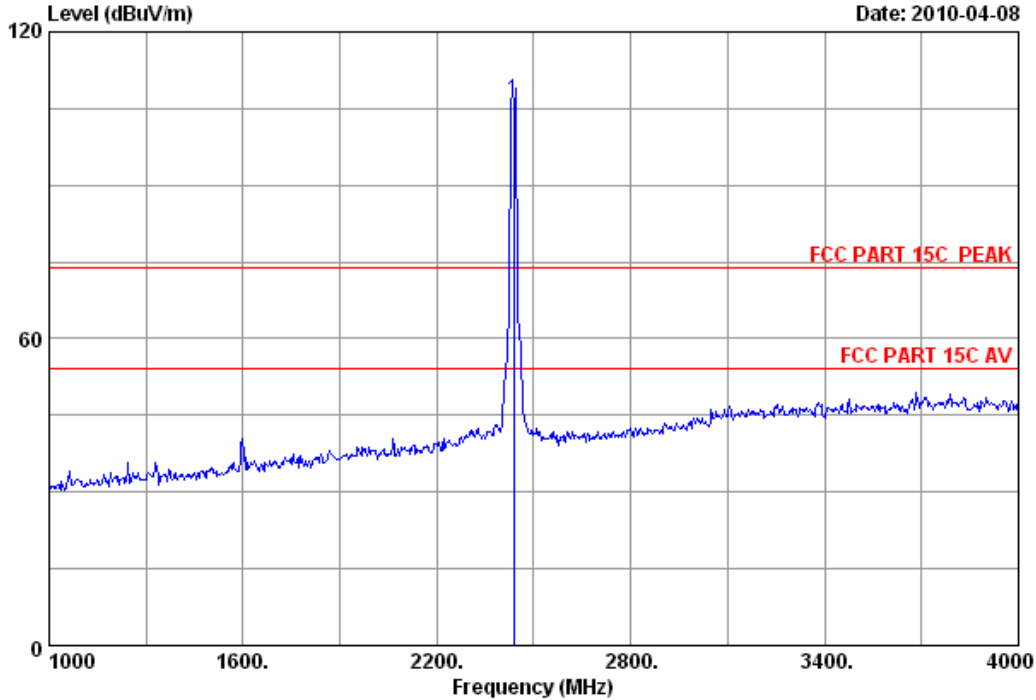

Site no. : 3m Chamber Data no. : 41
 Dis. / Ant. : 3m 3115(0911) Ant. pol. : VERTICAL
 Limit : FCC PART 15C PEAK
 Env. / Ins. : 23°C/54% Engineer : Paul
 EUT : Blu-ray Disc Player M/N:VBR220
 Power : DC 5V
 Test mode : Tx Mode 11g CH6 2437MHz

	Freq. (MHz)	Ant. Factor (dB/m)	Cable loss (dB)	Amp. Factor (dB)	Reading (dBuV)	Emission			
						Level (dBuV/m)	Limits (dBuV/m)	Margin (dB)	
1	2437.000	29.47	8.77	36.06	104.45	106.63	74.00	-32.63	Peak

Remarks:

- Emission Level= Antenna Factor + Cable Loss -Amp Factor + Reading.
- The emission levels that are 20dB below the official limit are not reported.



No.6 Ke Feng Road,Block 52,
 ShenZhen Science & Industry Park
 Noutou,ShenZhen,GuangDong,China
 Tel:+86-755-26639495-7
 Fax:+86-755-26632877
 Postcode:518057

Data: 42 File: E:\2010 report data\C\contel\ACS10Q0594R2.EM6 (108)

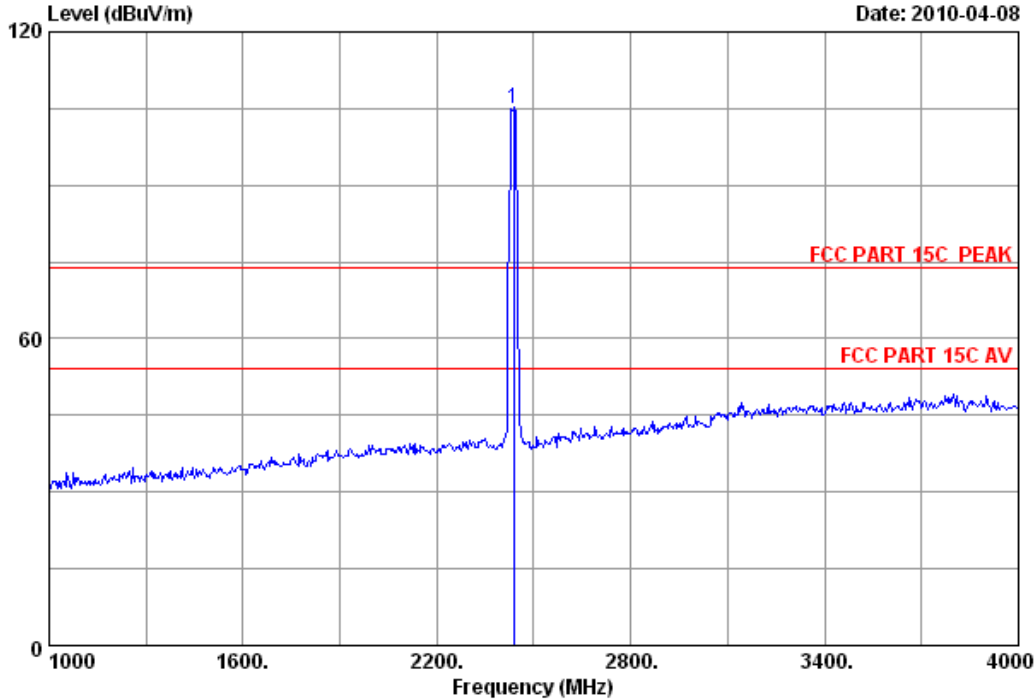

Site no. : 3m Chamber Data no. : 42
 Dis. / Ant. : 3m 3115(0911) Ant. pol. : HORIZONTAL
 Limit : FCC PART 15C PEAK
 Env. / Ins. : 23°C/54% Engineer : Paul
 EUT : Blu-ray Disc Player M/N:VBR220
 Power : DC 5V
 Test mode : Tx Mode 11g CH6 2437MHz

	Freq. (MHz)	Ant. Factor (dB/m)	Cable loss (dB)	Amp. Factor (dB)	Reading (dBuV)	Emission			Remark
						Level (dBuV/m)	Limits (dBuV/m)	Margin (dB)	
1	2437.000	29.47	8.77	36.06	102.89	105.07	74.00	-31.07	Peak

Remarks:

1. Emission Level= Antenna Factor + Cable Loss -Amp Factor + Reading.
2. The emission levels that are 20dB below the official limit are not reported.



No.6 Ke Feng Road,Block 52,
 ShenZhen Science & Industry Park
 Noutou,ShenZhen,GuangDong,China
 Tel:+86-755-26639495-7
 Fax:+86-755-26632877
 Postcode:518057

Data: 43 File: E:\2010 report data\C\contel\ACS10Q0594R2.EM6 (108)

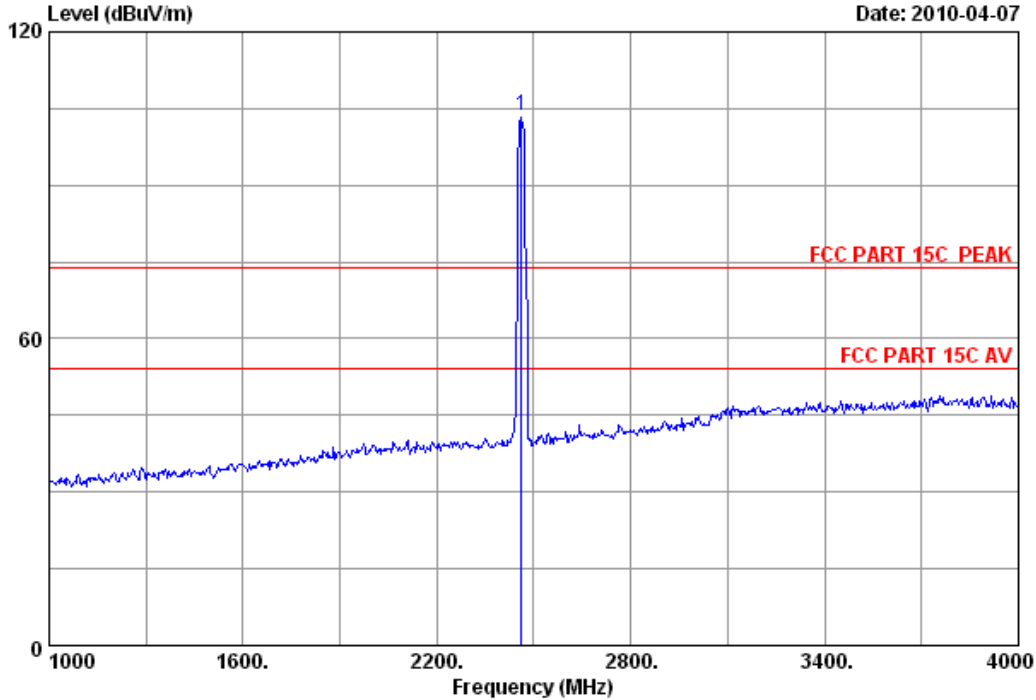

Site no. : 3m Chamber Data no. : 43
 Dis. / Ant. : 3m 3115(0911) Ant. pol. : VERTICAL
 Limit : FCC PART 15C PEAK
 Env. / Ins. : 23°C/54% Engineer : Paul
 EUT : Blu-ray Disc Player M/N:VBR220
 Power : DC 5V
 Test mode : Tx Mode 11g CH11 2462MHz

	Freq. (MHz)	Ant. Factor (dB/m)	Cable loss (dB)	Amp. Factor (dB)	Reading (dBuV)	Emission			
						Level (dBuV/m)	Limits (dBuV/m)	Margin (dB)	
1	2462.000	29.48	8.82	36.02	101.25	103.53	74.00	-29.53	Peak

Remarks:

- Emission Level= Antenna Factor + Cable Loss -Amp Factor + Reading.
- The emission levels that are 20dB below the official limit are not reported.



No.6 Ke Feng Road,Block 52,
ShenZhen Science & Industry Park
Noutou,ShenZhen,GuangDong,China
Tel:+86-755-26639495-7
Fax:+86-755-26632877
Postcode:518057

Data: 44

File: E:\2010 report data\C\contel\ACS10Q0594R2.EM6 (108)

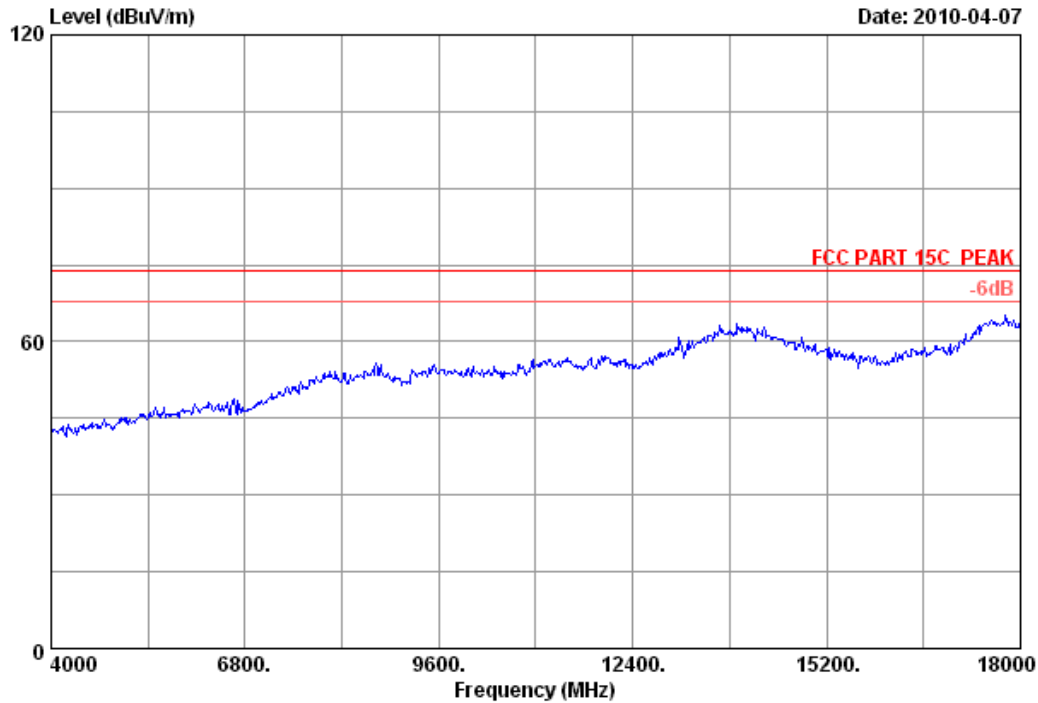

Site no.	: 3m Chamber	Data no.	: 44
Dis. / Ant.	: 3m 3115(0911)	Ant. pol.	: HORIZONTAL
Limit	: FCC PART 15C PEAK		
Env. / Ins.	: 23°C/54%	Engineer	: Paul
EUT	: Blu-ray Disc Player M/N:VBR220		
Power	: DC 5V		
Test mode	: Tx Mode 11g CH11 2462MHz		



No.6 Ke Feng Road,Block 52,
 ShenZhen Science & Industry Park
 Noutou,ShenZhen,GuangDong,China
 Tel:+86-755-26639495-7
 Fax:+86-755-26632877
 Postcode:518057

Data: 45 File: E:\2010 report data\C\contel\ACS10Q0594R2.EM6 (108)

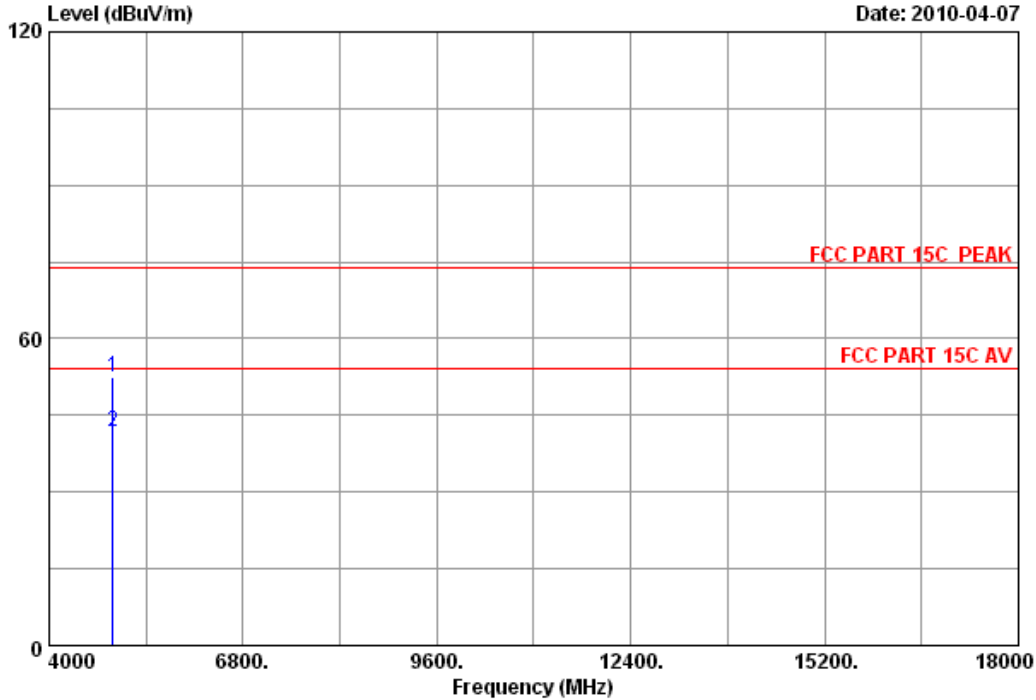

Site no. : 3m Chamber Data no. : 45
 Dis. / Ant. : 3m 3115(0911) Ant. pol. : HORIZONTAL
 Limit : FCC PART 15C PEAK
 Env. / Ins. : 23*C/54% Engineer : Paul
 EUT : Blu-ray Disc Player M/N:VBR220
 Power : DC 5V
 Test mode : Tx Mode 11g CH11 2462MHz

	Freq. (MHz)	Ant. Factor (dB/m)	Cable loss (dB)	Amp. Factor (dB)	Reading (dBuV)	Emission Level (dBuV/m)	Limits (dBuV/m)	Margin (dB)	Remark
1	4924.000	34.49	12.50	35.34	40.79	52.44	74.00	21.56	Peak
2	4924.000	34.49	12.50	35.34	30.18	41.83	54.00	12.17	Average

Remarks:

1. Emission Level= Antenna Factor + Cable Loss -Amp Factor + Reading.
2. The emission levels that are 20dB below the official limit are not reported.



No.6 Ke Feng Road,Block 52,
ShenZhen Science & Industry Park
Noutou,ShenZhen,GuangDong,China
Tel:+86-755-26639495-7
Fax:+86-755-26632877
Postcode:518057

Data: 46

File: E:\2010 report data\C\contel\ACS10Q0594R2.EM6 (108)

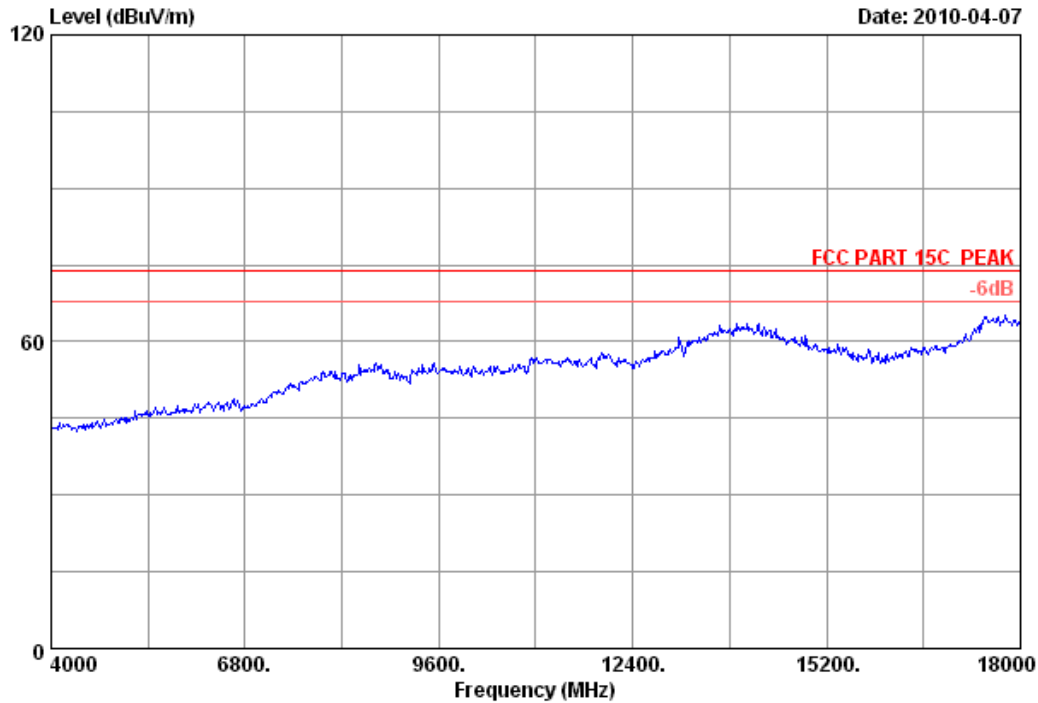

Site no.	: 3m Chamber	Data no.	: 46
Dis. / Ant.	: 3m 3115(0911)	Ant. pol.	: VERTICAL
Limit	: FCC PART 15C PEAK		
Env. / Ins.	: 23°C/54%	Engineer	: Paul
EUT	: Blu-ray Disc Player M/N:VBR220		
Power	: DC 5V		
Test mode	: Tx Mode 11g CH11 2462MHz		



No.6 Ke Feng Road,Block 52,
 ShenZhen Science & Industry Park
 Noutou,ShenZhen,GuangDong,China
 Tel:+86-755-26639495-7
 Fax:+86-755-26632877
 Postcode:518057

Data: 47 File: E:\2010 report data\C\contel\ACS10Q0594R2.EM6 (108)

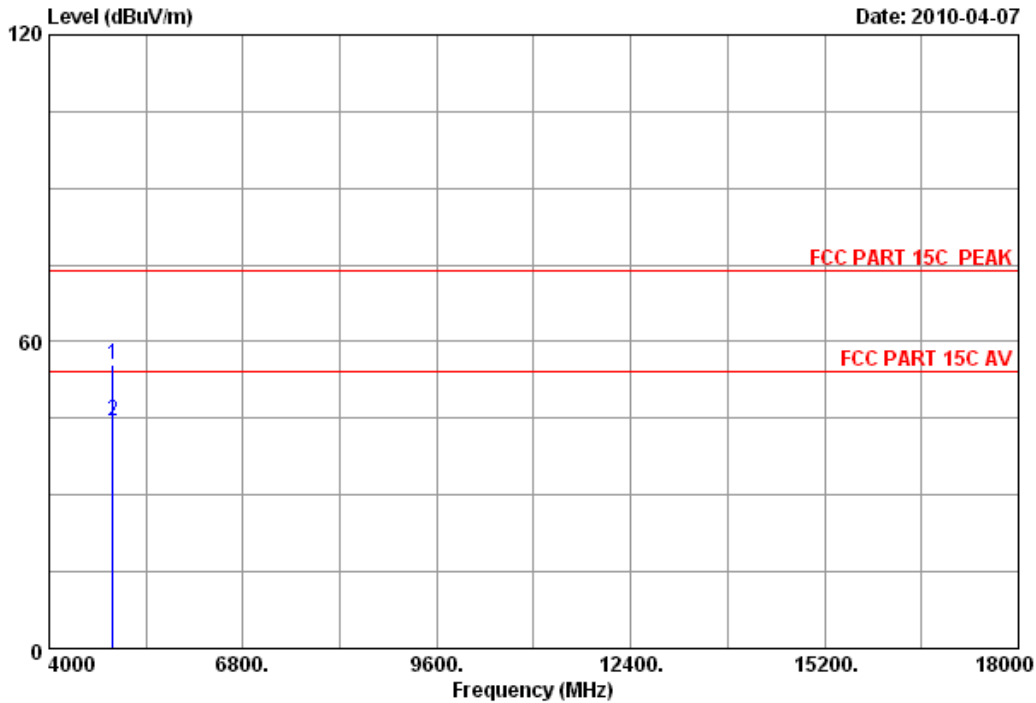

Site no. : 3m Chamber Data no. : 47
 Dis. / Ant. : 3m 3115(0911) Ant. pol. : VERTICAL
 Limit : FCC PART 15C PEAK
 Env. / Ins. : 23*C/54% Engineer : Paul
 EUT : Blu-ray Disc Player M/N:VBR220
 Power : DC 5V
 Test mode : Tx Mode 11g CH11 2462MHz

	Freq. (MHz)	Ant. Factor (dB/m)	Cable loss (dB)	Amp. Factor (dB)	Reading (dBuV)	Emission Level (dBuV/m)	Limits (dBuV/m)	Margin (dB)	Remark
1	4924.000	34.49	12.50	35.34	43.91	55.56	74.00	18.44	Peak
2	4924.000	34.49	12.50	35.34	32.81	44.46	54.00	9.54	Average

Remarks:

1. Emission Level= Antenna Factor + Cable Loss -Amp Factor + Reading.
2. The emission levels that are 20dB below the official limit are not reported.



No.6 Ke Feng Road,Block 52,
 ShenZhen Science & Industry Park
 Noutou,ShenZhen,GuangDong,China
 Tel:+86-755-26639495-7
 Fax:+86-755-26632877
 Postcode:518057

Data: 52 File: E:\2010 report data\C\contel\ACS10Q0594R2.EM6 (108)

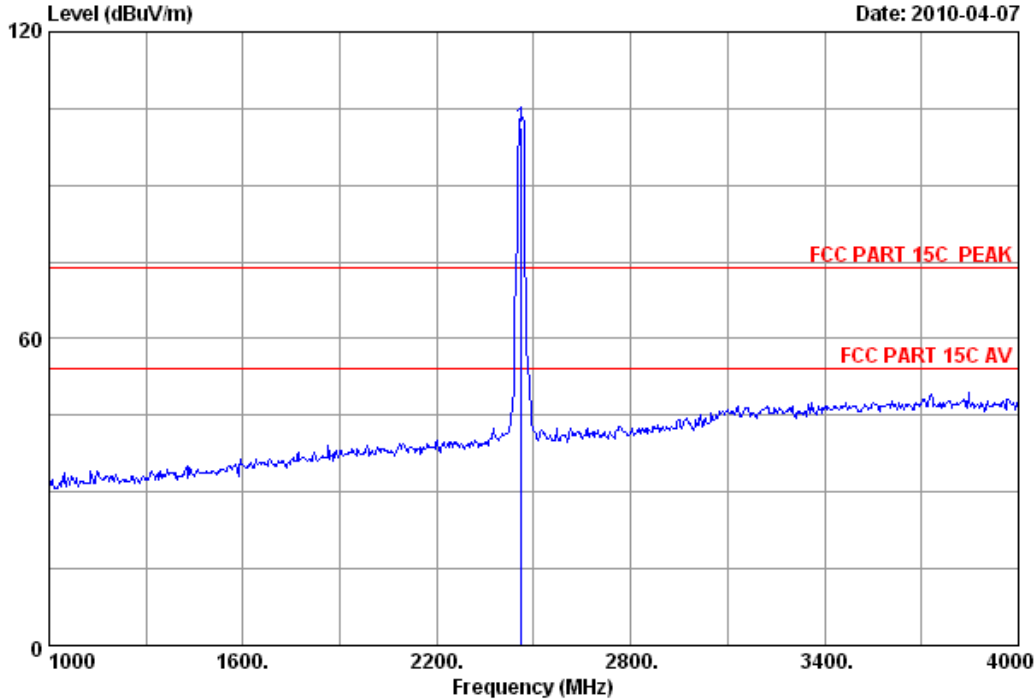

Site no. : 3m Chamber Data no. : 52
 Dis. / Ant. : 3m 3115(0911) Ant. pol. : HORIZONTAL
 Limit : FCC PART 15C PEAK
 Env. / Ins. : 23°C/54% Engineer : Paul
 EUT : Blu-ray Disc Player M/N:VBR220
 Power : DC 5V
 Test mode : Tx Mode 11g CH11 2462MHz

	Freq. (MHz)	Ant. Factor (dB/m)	Cable loss (dB)	Amp. Factor (dB)	Reading (dBuV)	Emission			Remark
						Level (dBuV/m)	Limits (dBuV/m)	Margin (dB)	
1	2462.000	29.48	8.82	36.02	99.12	101.40	74.00	-27.40	Peak

Remarks:

1. Emission Level= Antenna Factor + Cable Loss -Amp Factor + Reading.
2. The emission levels that are 20dB below the official limit are not reported.



No.6 Ke Feng Road,Block 52,
 ShenZhen Science & Industry Park
 Noutou,ShenZhen,GuangDong,China
 Tel:+86-755-26639495-7
 Fax:+86-755-26632877
 Postcode:518057

Data: 53 File: E:\2010 report data\C\contel\ACS10Q0594R2.EM6 (108)

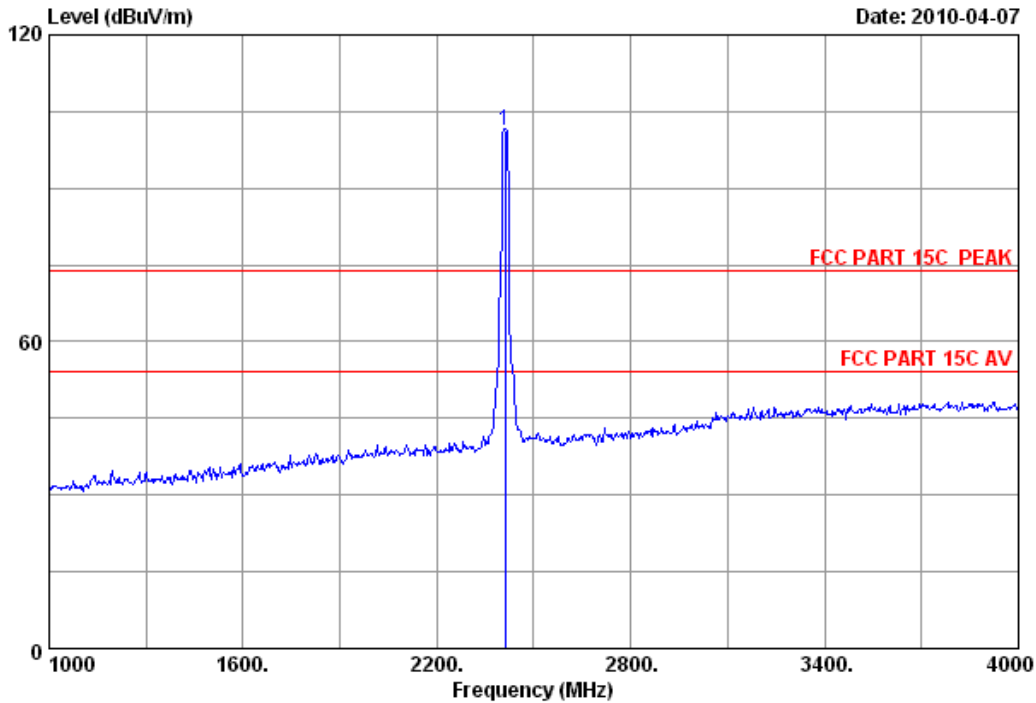

Site no. : 3m Chamber Data no. : 53
 Dis. / Ant. : 3m 3115(0911) Ant. pol. : HORIZONTAL
 Limit : FCC PART 15C PEAK
 Env. / Ins. : 23°C/54% Engineer : Paul
 EUT : Blu-ray Disc Player M/N:VBR220
 Power : DC 5V
 Test mode : Tx Mode 11nHT20 CH1 2412MHz

	Freq. (MHz)	Ant. Factor (dB/m)	Cable loss (dB)	Amp. Factor (dB)	Reading (dBuV)	Emission			Remark
						Level (dBuV/m)	Limits (dBuV/m)	Margin (dB)	
1	2412.000	29.45	8.72	35.95	99.19	101.41	74.00	-27.41	Peak

Remarks:

1. Emission Level= Antenna Factor + Cable Loss -Amp Factor + Reading.
2. The emission levels that are 20dB below the official limit are not reported.



No.6 Ke Feng Road,Block 52,
 ShenZhen Science & Industry Park
 Noutou,ShenZhen,GuangDong,China
 Tel:+86-755-26639495-7
 Fax:+86-755-26632877
 Postcode:518057

Data: 54 File: E:\2010 report data\C\contel\ACS10Q0594R2.EM6 (108)

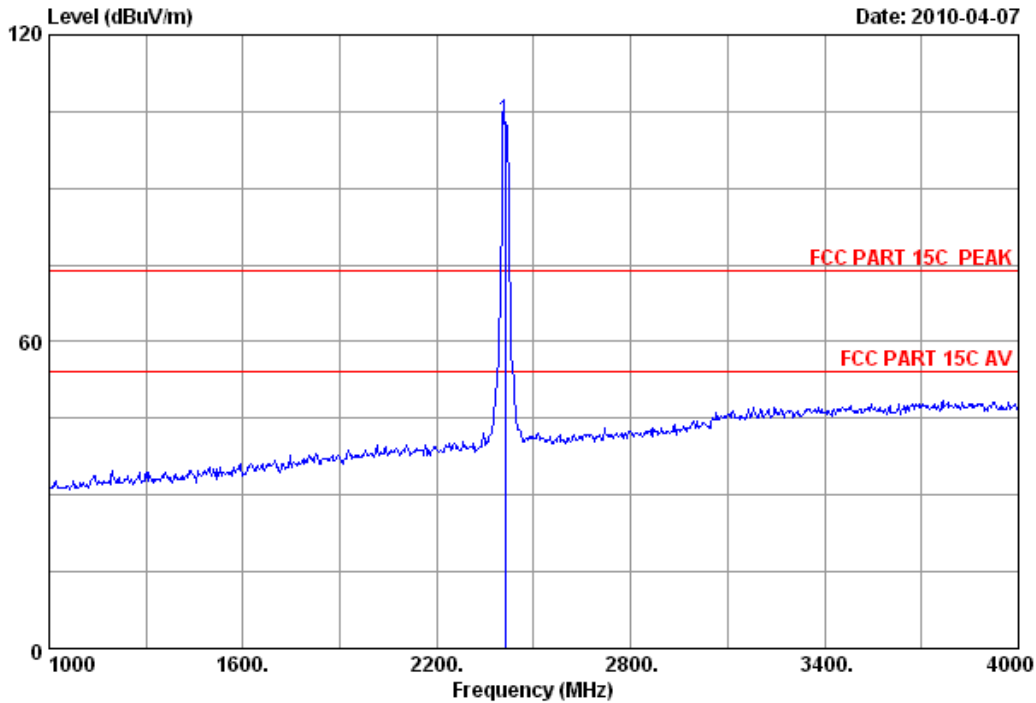

Site no. : 3m Chamber Data no. : 54
 Dis. / Ant. : 3m 3115(0911) Ant. pol. : VERTICAL
 Limit : FCC PART 15C PEAK
 Env. / Ins. : 23°C/54% Engineer : Paul
 EUT : Blu-ray Disc Player M/N:VBR220
 Power : DC 5V
 Test mode : Tx Mode 11nHT20 CH1 2412MHz

	Freq. (MHz)	Ant. Factor (dB/m)	Cable loss (dB)	Amp. Factor (dB)	Reading (dBuV)	Emission			
						Level (dBuV/m)	Limits (dBuV/m)	Margin (dB)	
1	2412.000	29.45	8.72	35.95	101.19	103.41	74.00	-29.41	Peak

Remarks:

1. Emission Level= Antenna Factor + Cable Loss -Amp Factor + Reading.
2. The emission levels that are 20dB below the official limit are not reported.



No.6 Ke Feng Road,Block 52,
 ShenZhen Science & Industry Park
 Noutou,ShenZhen,GuangDong,China
 Tel:+86-755-26639495-7
 Fax:+86-755-26632877
 Postcode:518057

Data: 55 File: E:\2010 report data\C\contel\ACS10Q0594R2.EM6 (108)

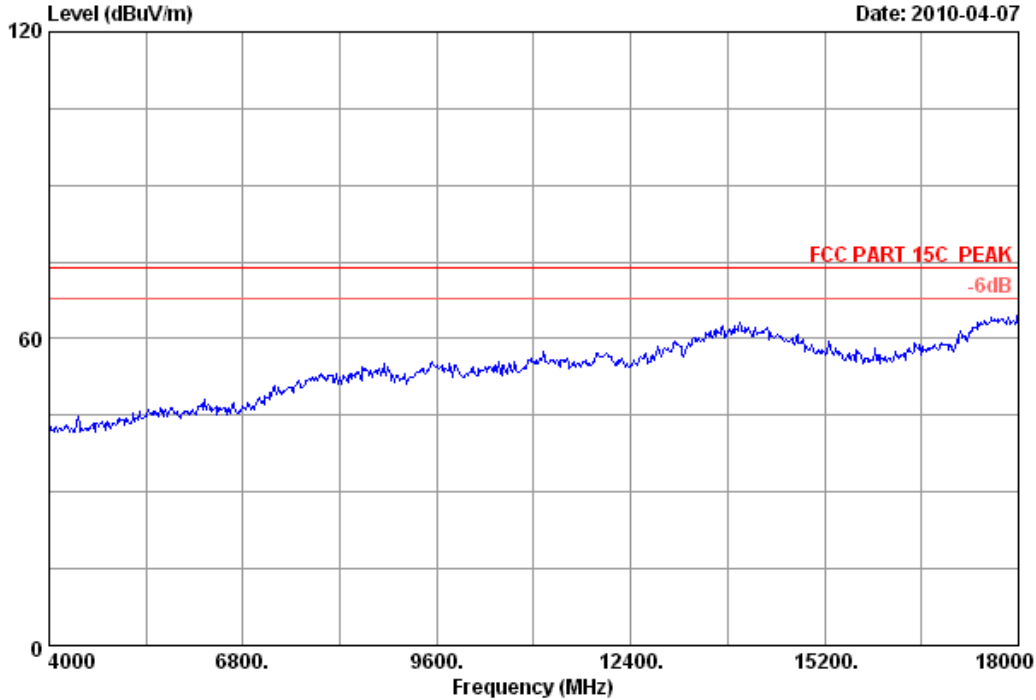

Site no.	: 3m Chamber	Data no.	: 55
Dis. / Ant.	: 3m 3115(0911)	Ant. pol.	: HORIZONTAL
Limit	: FCC PART 15C PEAK		
Env. / Ins.	: 23°C/54%	Engineer	: Paul
EUT	: Blu-ray Disc Player M/N:VBR220		
Power	: DC 5V		
Test mode	: Tx Mode 11nHT20 CH1 2412MHz		



No.6 Ke Feng Road,Block 52,
 ShenZhen Science & Industry Park
 Noutou,ShenZhen,GuangDong,China
 Tel:+86-755-26639495-7
 Fax:+86-755-26632877
 Postcode:518057

Data: 56 File: E:\2010 report data\C\contel\ACS10Q0594R2.EM6 (108)

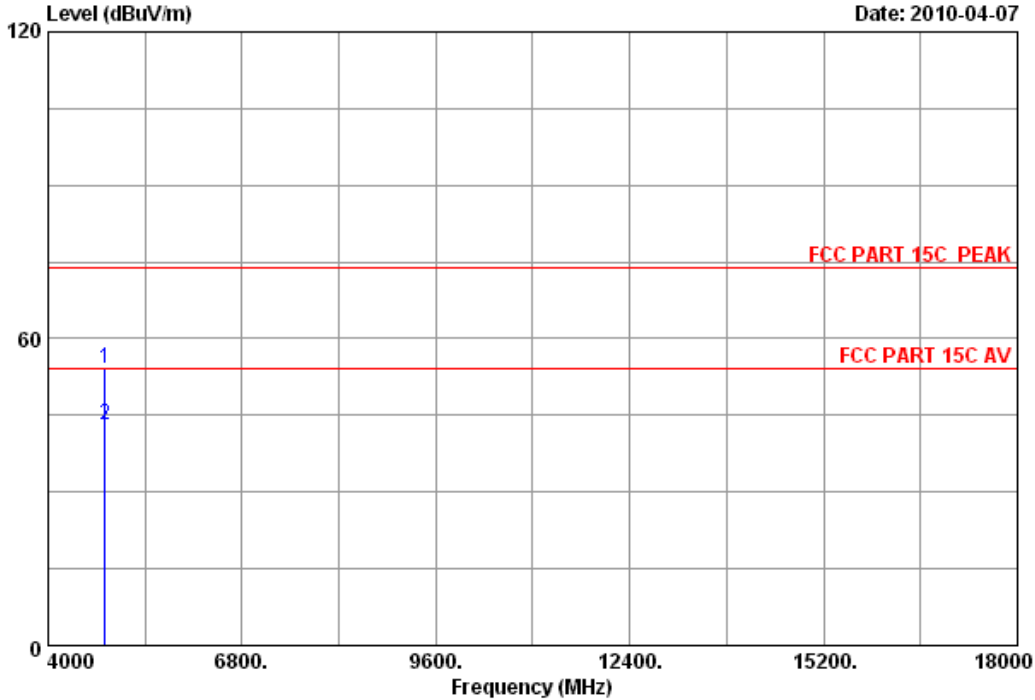

Site no. : 3m Chamber Data no. : 56
 Dis. / Ant. : 3m 3115(0911) Ant. pol. : HORIZONTAL
 Limit : FCC PART 15C PEAK
 Env. / Ins. : 23*C/54% Engineer : Paul
 EUT : Blu-ray Disc Player M/N:VBR220
 Power : DC 5V
 Test mode : Tx Mode 11nHT20 CH1 2412MHz

	Freq. (MHz)	Ant. Factor (dB/m)	Cable loss (dB)	Amp. Factor (dB)	Reading (dBuV)	Emission Level (dBuV/m)	Limits (dBuV/m)	Margin (dB)	Remark
1	4824.000	34.32	12.38	35.25	42.75	54.20	74.00	19.80	Peak
2	4824.000	34.32	12.38	35.25	31.53	42.98	54.00	11.02	Average

Remarks:
 1. Emission Level= Antenna Factor + Cable Loss -Amp Factor + Reading.
 2. The emission levels that are 20dB below the official limit are not reported.



No.6 Ke Feng Road,Block 52,
 ShenZhen Science & Industry Park
 Noutou,ShenZhen,GuangDong,China
 Tel:+86-755-26639495-7
 Fax:+86-755-26632877
 Postcode:518057

Data: 57 File: E:\2010 report data\C\contel\ACS10Q0594R2.EM6 (108)

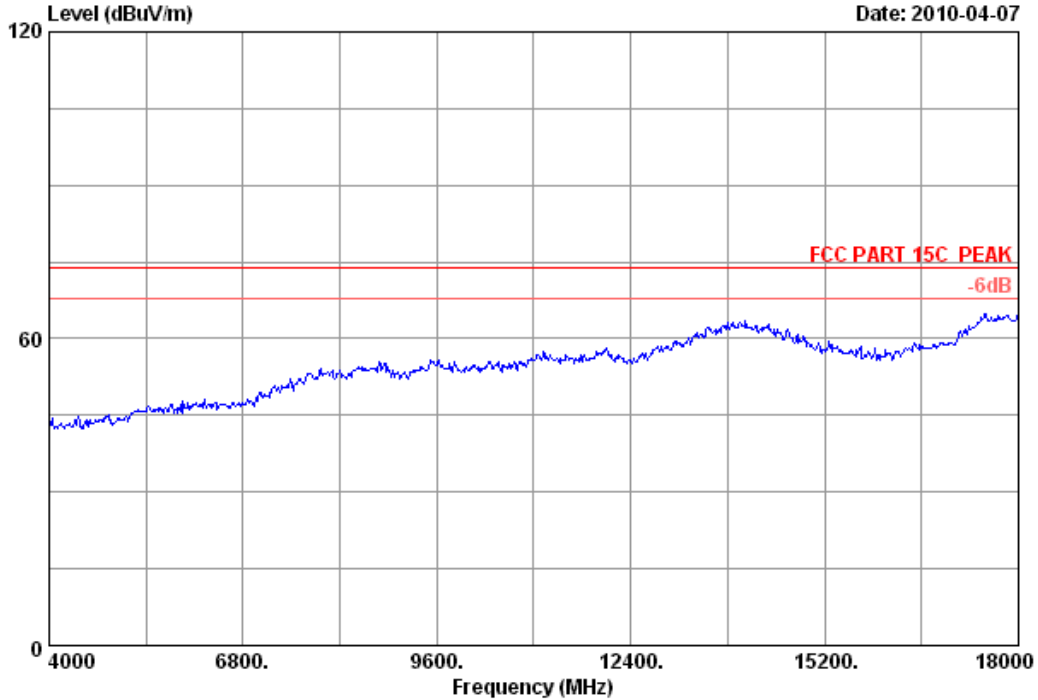

Site no.	: 3m Chamber	Data no.	: 57
Dis. / Ant.	: 3m 3115(0911)	Ant. pol.	: VERTICAL
Limit	: FCC PART 15C PEAK		
Env. / Ins.	: 23°C/54%	Engineer	: Paul
EUT	: Blu-ray Disc Player M/N:VBR220		
Power	: DC 5V		
Test mode	: Tx Mode 11nHT20 CH1 2412MHz		



No.6 Ke Feng Road,Block 52,
 ShenZhen Science & Industry Park
 Noutou,ShenZhen,GuangDong,China
 Tel:+86-755-26639495-7
 Fax:+86-755-26632877
 Postcode:518057

Data: 58 File: E:\2010 report data\C\contel\ACS10Q0594R2.EM6 (108)

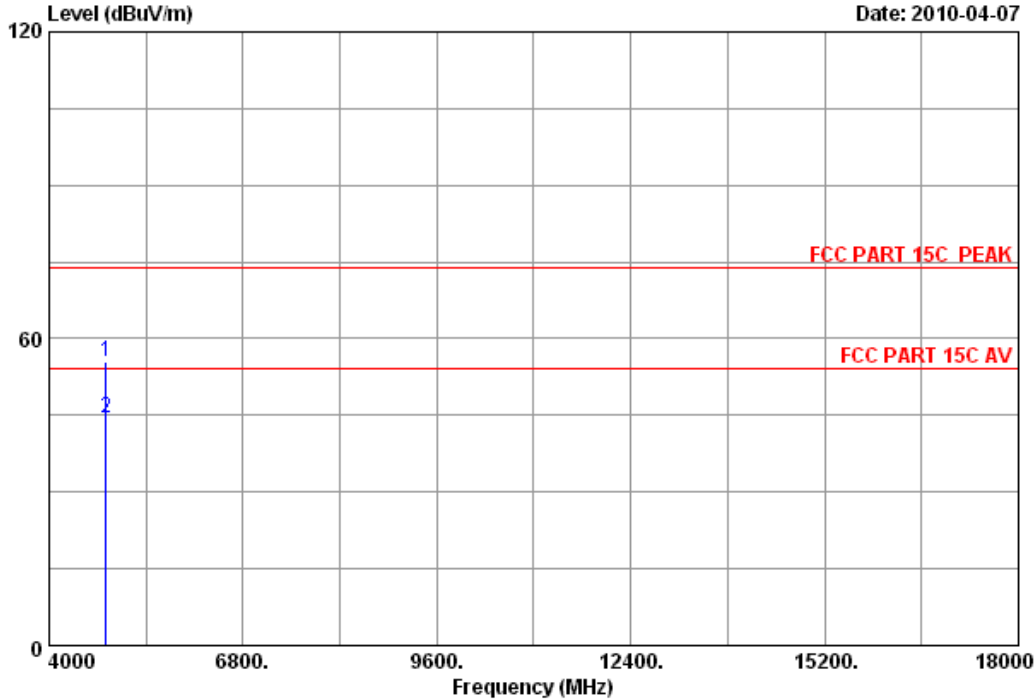

Site no. : 3m Chamber Data no. : 58
 Dis. / Ant. : 3m 3115(0911) Ant. pol. : VERTICAL
 Limit : FCC PART 15C PEAK
 Env. / Ins. : 23°C/54% Engineer : Paul
 EUT : Blu-ray Disc Player M/N:VBR220
 Power : DC 5V
 Test mode : Tx Mode 11nHT20 CH1 2412MHz

	Freq. (MHz)	Ant. Factor (dB/m)	Cable loss (dB)	Amp. Factor (dB)	Reading (dBuV)	Emission Level (dBuV/m)	Limits (dBuV/m)	Margin (dB)	Remark
1	4824.000	34.32	12.38	35.25	43.90	55.35	74.00	18.65	Peak
2	4824.000	34.32	12.38	35.25	33.08	44.53	54.00	9.47	Average

Remarks:

1. Emission Level= Antenna Factor + Cable Loss -Amp Factor + Reading.
2. The emission levels that are 20dB below the official limit are not reported.



No.6 Ke Feng Road,Block 52,
ShenZhen Science & Industry Park
Noutou, ShenZhen, GuangDong, China
Tel:+86-755-26639495-7
Fax:+86-755-26632877
Postcode:518057

Data: 63 File: E:\2010 report data\C\contel\ACS10Q0594R2.EM6 (108)

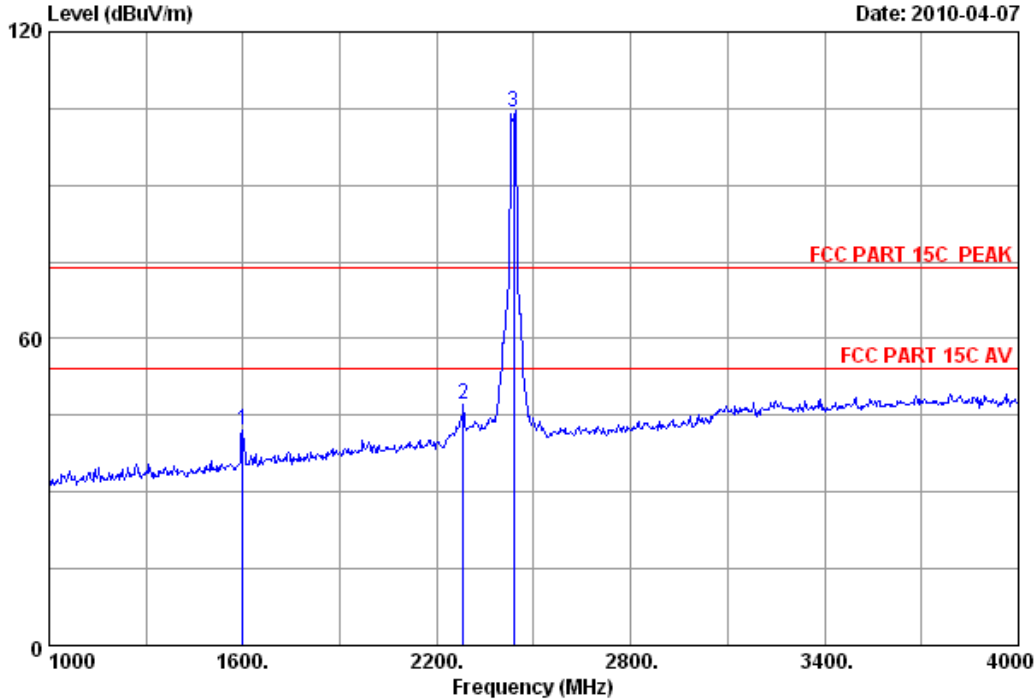

Site no. : 3m Chamber Data no. : 63
 Dis. / Ant. : 3m 3115(0911) Ant. pol. : HORIZONTAL
 Limit : FCC PART 15C PEAK
 Env. / Ins. : 23°C/54% Engineer : Paul
 EUT : Blu-ray Disc Player M/N:VBR220
 Power : DC 5V
 Test mode : Tx Mode 11nHT20 CH6 2437MHz

	Ant. Factor (dB/m)	Cable loss (dB)	Amp. Factor (dB)	Reading (dBuV)	Emission Level (dBuV/m)	Limits (dBuV/m)	Margin (dB)	Remark
1	26.96	6.98	36.43	44.73	42.24	74.00	31.76	Peak
2	29.37	8.47	35.98	45.27	47.13	74.00	26.87	Peak
3	29.47	8.77	36.06	102.25	104.43	74.00	-30.43	Peak

Remarks:

1. Emission Level= Antenna Factor + Cable Loss -Amp Factor + Reading.
2. The emission levels that are 20dB below the official limit are not reported.



No.6 Ke Feng Road,Block 52,
 ShenZhen Science & Industry Park
 Noutou,ShenZhen,GuangDong,China
 Tel:+86-755-26639495-7
 Fax:+86-755-26632877
 Postcode:518057

Data: 64 File: E:\2010 report data\C\contel\ACS10Q0594R2.EM6 (108)

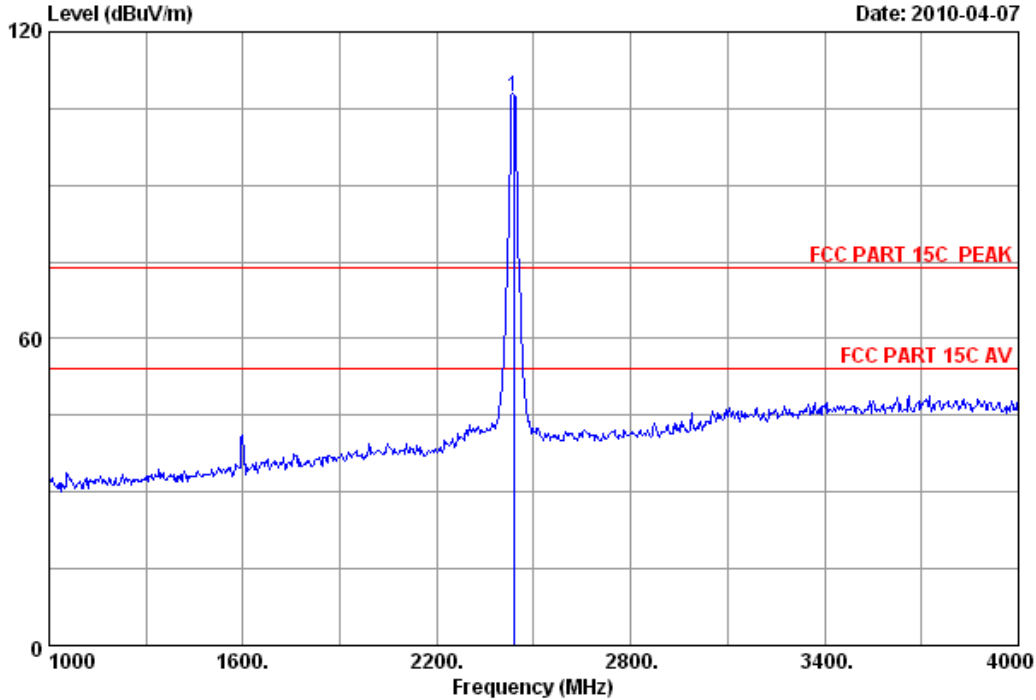

Site no. : 3m Chamber Data no. : 64
 Dis. / Ant. : 3m 3115(0911) Ant. pol. : VERTICAL
 Limit : FCC PART 15C PEAK
 Env. / Ins. : 23°C/54% Engineer : Paul
 EUT : Blu-ray Disc Player M/N:VBR220
 Power : DC 5V
 Test mode : Tx Mode 11nHT20 CH6 2437MHz

	Freq. (MHz)	Ant. Factor (dB/m)	Cable loss (dB)	Amp. Factor (dB)	Reading (dBuV)	Emission			Remark
						Level (dBuV/m)	Limits (dBuV/m)	Margin (dB)	
1	2437.000	29.47	8.77	36.06	105.19	107.37	74.00	-33.37	Peak

Remarks:

1. Emission Level= Antenna Factor + Cable Loss -Amp Factor + Reading.
2. The emission levels that are 20dB below the official limit are not reported.



No.6 Ke Feng Road,Block 52,
 ShenZhen Science & Industry Park
 Noutou,ShenZhen,GuangDong,China
 Tel:+86-755-26639495-7
 Fax:+86-755-26632877
 Postcode:518057

Data: 65

File: E:\2010 report data\C\contel\ACS10Q0594R2.EM6 (108)

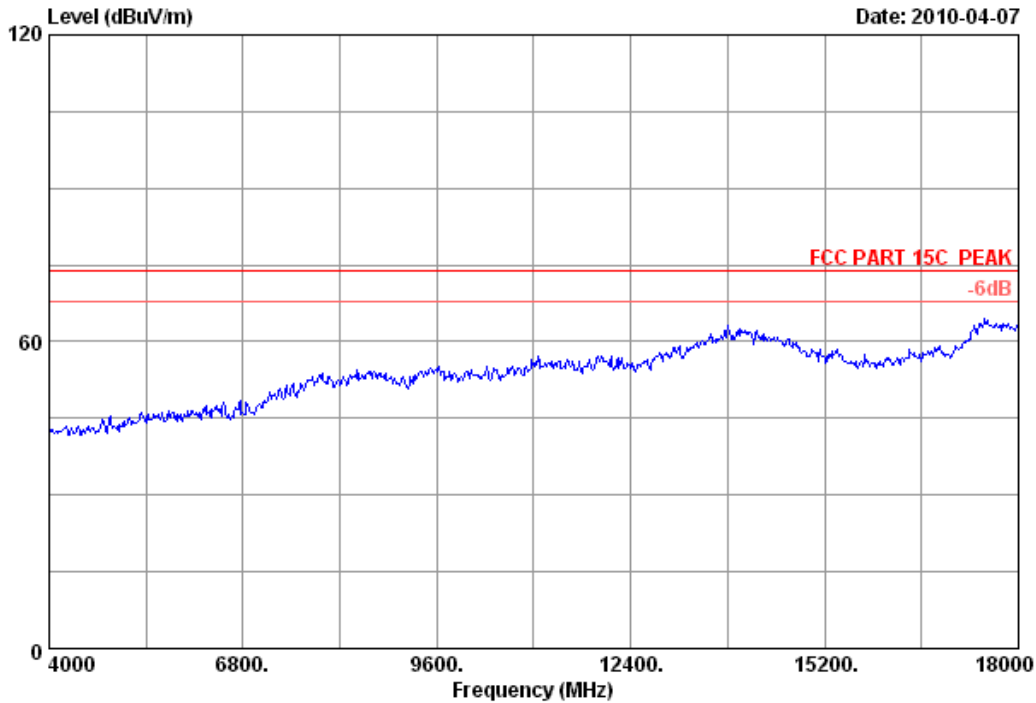

Site no.	: 3m Chamber	Data no.	: 65
Dis. / Ant.	: 3m 3115(0911)	Ant. pol.	: VERTICAL
Limit	: FCC PART 15C PEAK		
Env. / Ins.	: 23°C/54%	Engineer	: Paul
EUT	: Blu-ray Disc Player M/N:VBR220		
Power	: DC 5V		
Test mode	: Tx Mode 11nHT20 CH6 2437MHz		



No.6 Ke Feng Road,Block 52,
 ShenZhen Science & Industry Park
 Noutou,ShenZhen,GuangDong,China
 Tel:+86-755-26639495-7
 Fax:+86-755-26632877
 Postcode:518057

Data: 66 File: E:\2010 report data\C\contel\ACS10Q0594R2.EM6 (108)

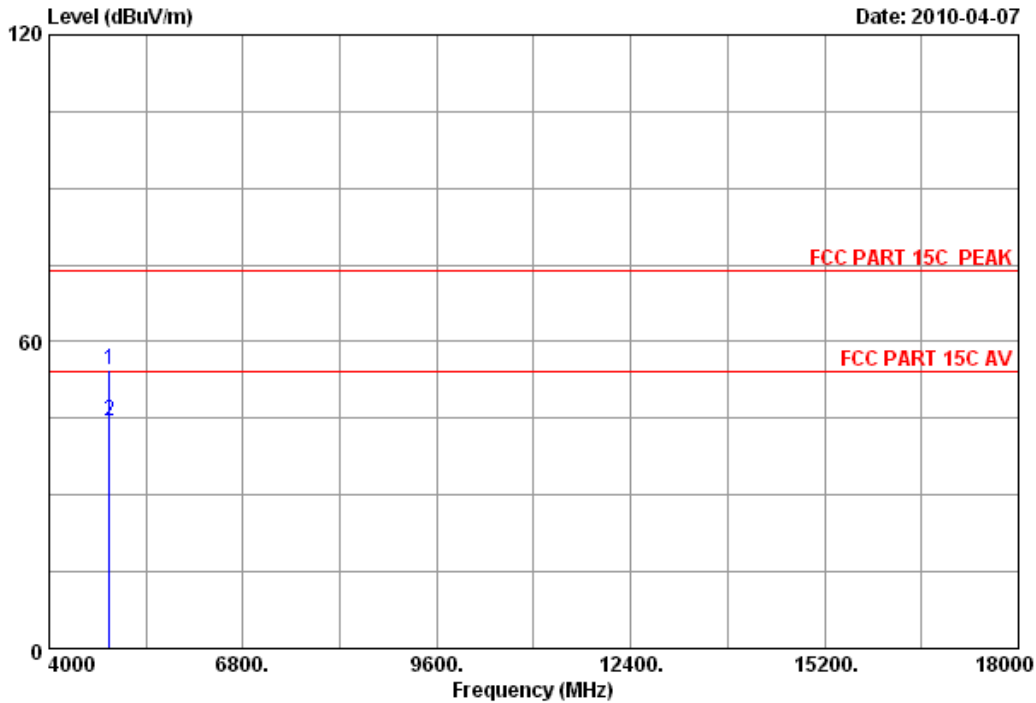

Site no. : 3m Chamber Data no. : 66
 Dis. / Ant. : 3m 3115(0911) Ant. pol. : VERTICAL
 Limit : FCC PART 15C PEAK
 Env. / Ins. : 23*C/54% Engineer : Paul
 EUT : Blu-ray Disc Player M/N:VBR220
 Power : DC 5V
 Test mode : Tx Mode 11nHT20 CH6 2437MHz

	Freq. (MHz)	Ant. Factor (dB/m)	Cable loss (dB)	Amp. Factor (dB)	Reading (dBuV)	Emission Level (dBuV/m)	Limits (dBuV/m)	Margin (dB)	Remark
1	4874.000	34.41	12.44	35.36	42.92	54.41	74.00	19.59	Peak
2	4874.000	34.41	12.44	35.36	33.08	44.57	54.00	9.43	Average

Remarks:

1. Emission Level= Antenna Factor + Cable Loss -Amp Factor + Reading.
2. The emission levels that are 20dB below the official limit are not reported.



No.6 Ke Feng Road,Block 52,
ShenZhen Science & Industry Park
Noutou,ShenZhen,GuangDong,China
Tel:+86-755-26639495-7
Fax:+86-755-26632877
Postcode:518057

Data: 67 File: E:\2010 report data\C\contel\ACS10Q0594R2.EM6 (108)

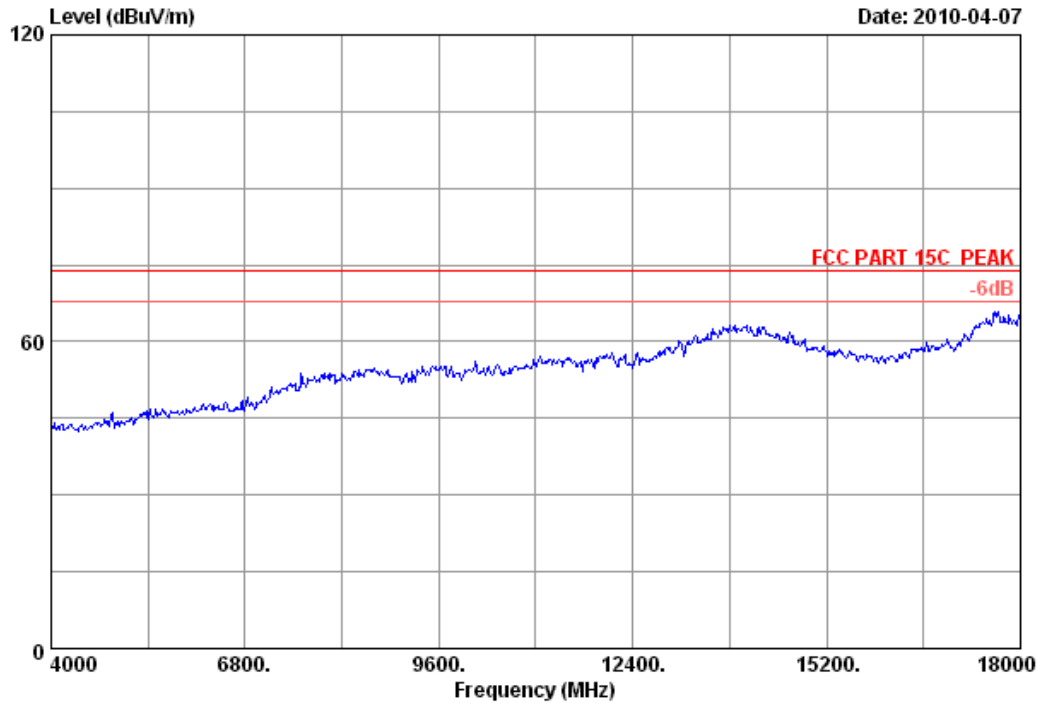

Site no.	: 3m Chamber	Data no.	: 67
Dis. / Ant.	: 3m 3115(0911)	Ant. pol.	: HORIZONTAL
Limit	: FCC PART 15C PEAK		
Env. / Ins.	: 23°C/54%	Engineer	: Paul
EUT	: Blu-ray Disc Player M/N:VBR220		
Power	: DC 5V		
Test mode	: Tx Mode 11nHT20 CH6 2437MHz		



No.6 Ke Feng Road,Block 52,
ShenZhen Science & Industry Park
Noutou,ShenZhen,GuangDong,China
Tel:+86-755-26639495-7
Fax:+86-755-26632877
Postcode:518057

Data: 68 File: E:\2010 report data\C\contel\ACS10Q0594R2.EM6 (108)

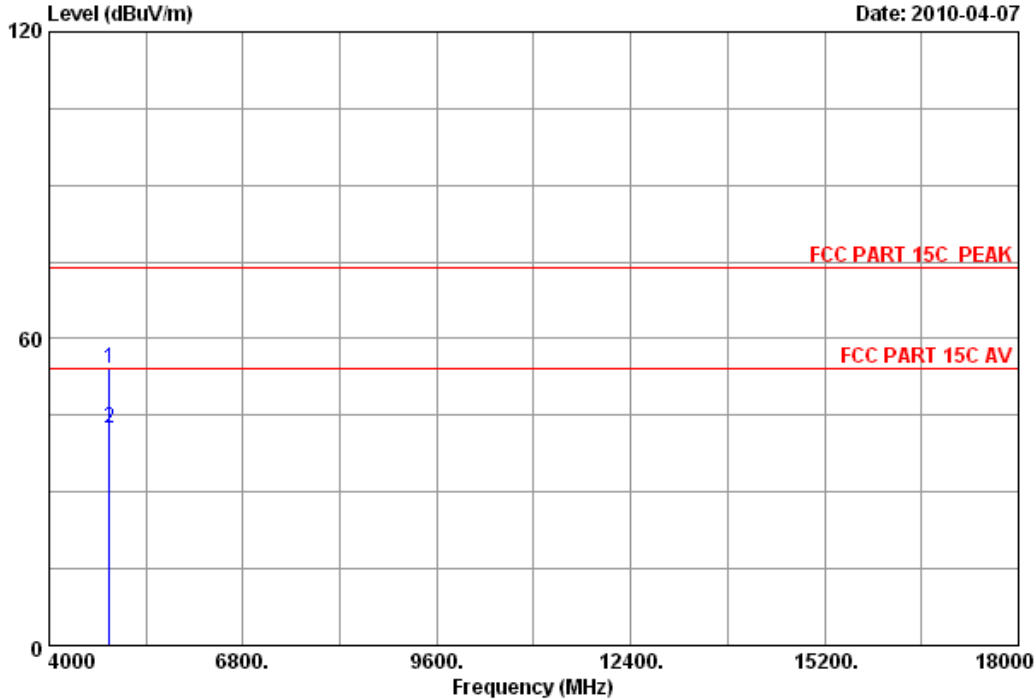

Site no. : 3m Chamber Data no. : 68
 Dis. / Ant. : 3m 3115(0911) Ant. pol. : HORIZONTAL
 Limit : FCC PART 15C PEAK
 Env. / Ins. : 23*C/54% Engineer : Paul
 EUT : Blu-ray Disc Player M/N:VBR220
 Power : DC 5V
 Test mode : Tx Mode 11nHT20 CH6 2437MHz

	Freq. (MHz)	Ant. Factor (dB/m)	Cable loss (dB)	Amp. Factor (dB)	Reading (dBuV)	Emission Level (dBuV/m)	Limits (dBuV/m)	Margin (dB)	Remark
1	4874.000	34.41	12.44	35.36	42.49	53.98	74.00	20.02	Peak
2	4874.000	34.41	12.44	35.36	31.01	42.50	54.00	11.50	Average

Remarks:

1. Emission Level= Antenna Factor + Cable Loss -Amp Factor + Reading.
2. The emission levels that are 20dB below the official limit are not reported.



No.6 Ke Feng Road,Block 52,
ShenZhen Science & Industry Park
Noutou,ShenZhen,GuangDong,China
Tel:+86-755-26639495-7
Fax:+86-755-26632877
Postcode:518057

Data: 69

File: E:\2010 report data\C\contel\ACS10Q0594R2.EM6 (108)

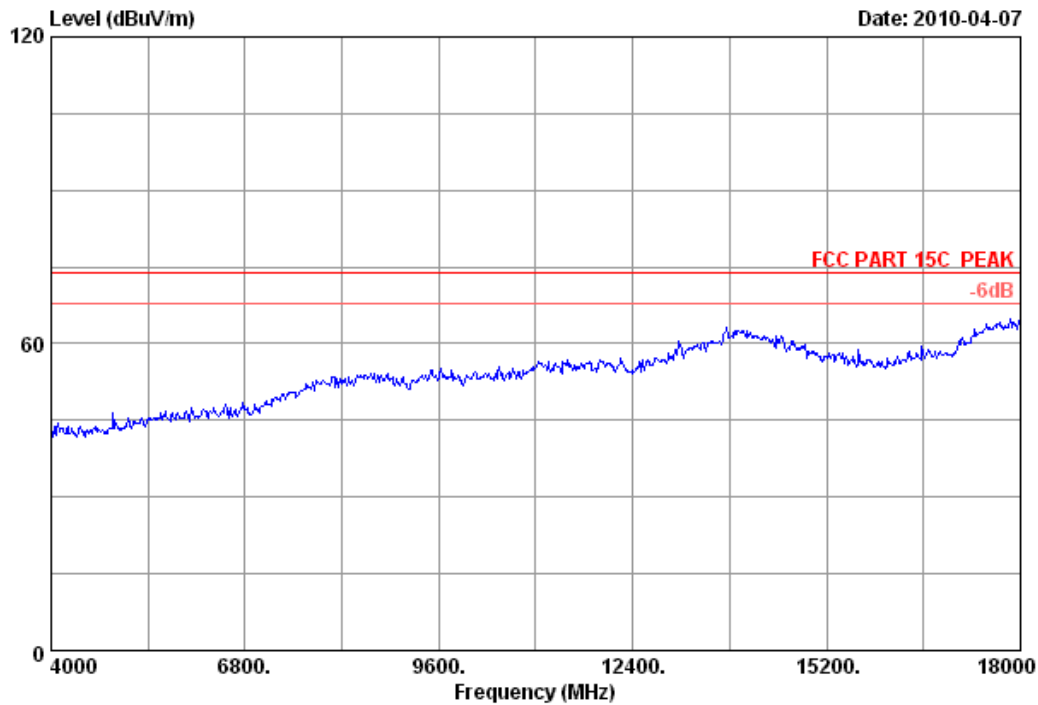

Site no.	: 3m Chamber	Data no.	: 69
Dis. / Ant.	: 3m 3115(0911)	Ant. pol.	: VERTICAL
Limit	: FCC PART 15C PEAK		
Env. / Ins.	: 23°C/54%	Engineer	: Paul
EUT	: Blu-ray Disc Player M/N:VBR220		
Power	: DC 5V		
Test mode	: Tx Mode 11nHT20 CH11 2462MHz		



No.6 Ke Feng Road,Block 52,
ShenZhen Science & Industry Park
Noutou,ShenZhen,GuangDong,China
Tel:+86-755-26639495-7
Fax:+86-755-26632877
Postcode:518057

Data: 70 File: E:\2010 report data\C\contel\ACS10Q0594R2.EM6 (108)

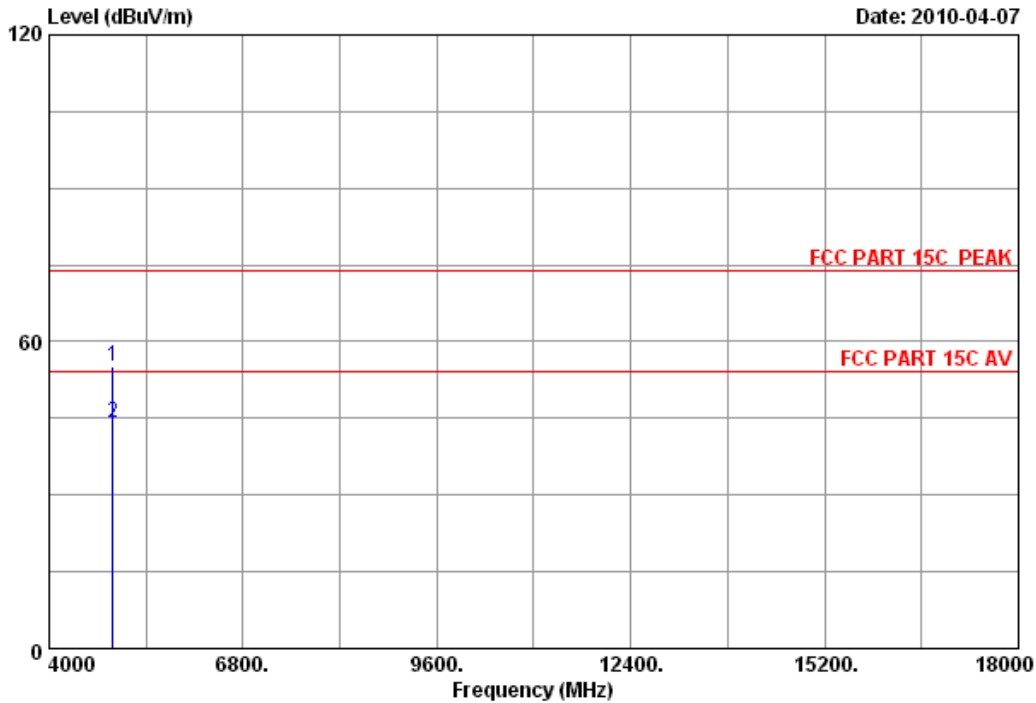

Site no. : 3m Chamber Data no. : 70
 Dis. / Ant. : 3m 3115(0911) Ant. pol. : VERTICAL
 Limit : FCC PART 15C PEAK
 Env. / Ins. : 23*C/54% Engineer : Paul
 EUT : Blu-ray Disc Player M/N:VBR220
 Power : DC 5V
 Test mode : Tx Mode 11nHT20 CH11 2462MHz

	Freq. (MHz)	Ant. Factor (dB/m)	Cable loss (dB)	Amp. Factor (dB)	Reading (dBuV)	Emission Level (dBuV/m)	Limits (dBuV/m)	Margin (dB)	Remark
1	4924.000	34.49	12.50	35.34	43.55	55.20	74.00	18.80	Peak
2	4924.000	34.49	12.50	35.34	32.46	44.11	54.00	9.89	Average

Remarks:

1. Emission Level= Antenna Factor + Cable Loss -Amp Factor + Reading.
2. The emission levels that are 20dB below the official limit are not reported.



No.6 Ke Feng Road,Block 52,
ShenZhen Science & Industry Park
Noutou,ShenZhen,GuangDong,China
Tel:+86-755-26639495-7
Fax:+86-755-26632877
Postcode:518057

Data: 71

File: E:\2010 report data\C\contel\ACS10Q0594R2.EM6 (108)

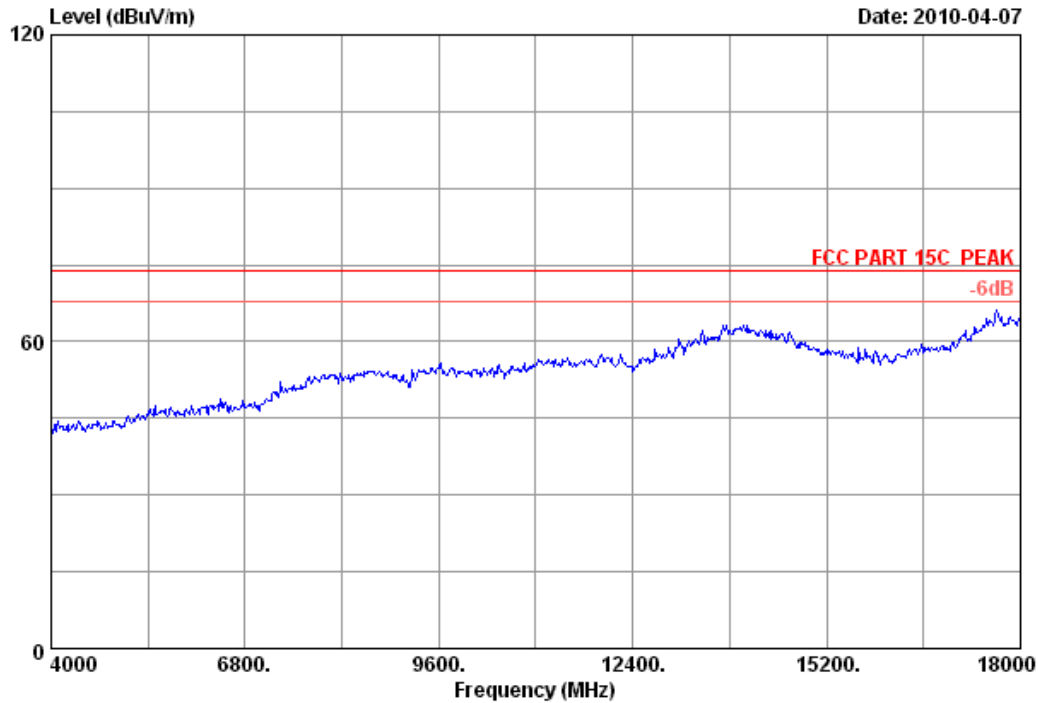

Site no.	: 3m Chamber	Data no.	: 71
Dis. / Ant.	: 3m 3115(0911)	Ant. pol.	: HORIZONTAL
Limit	: FCC PART 15C PEAK		
Env. / Ins.	: 23°C/54%	Engineer	: Paul
EUT	: Blu-ray Disc Player M/N:VBR220		
Power	: DC 5V		
Test mode	: Tx Mode 11nHT20 CH11 2462MHz		



No.6 Ke Feng Road,Block 52,
ShenZhen Science & Industry Park
Noutou,ShenZhen,GuangDong,China
Tel:+86-755-26639495-7
Fax:+86-755-26632877
Postcode:518057

Data: 72 File: E:\2010 report data\C\contel\ACS10Q0594R2.EM6 (108)

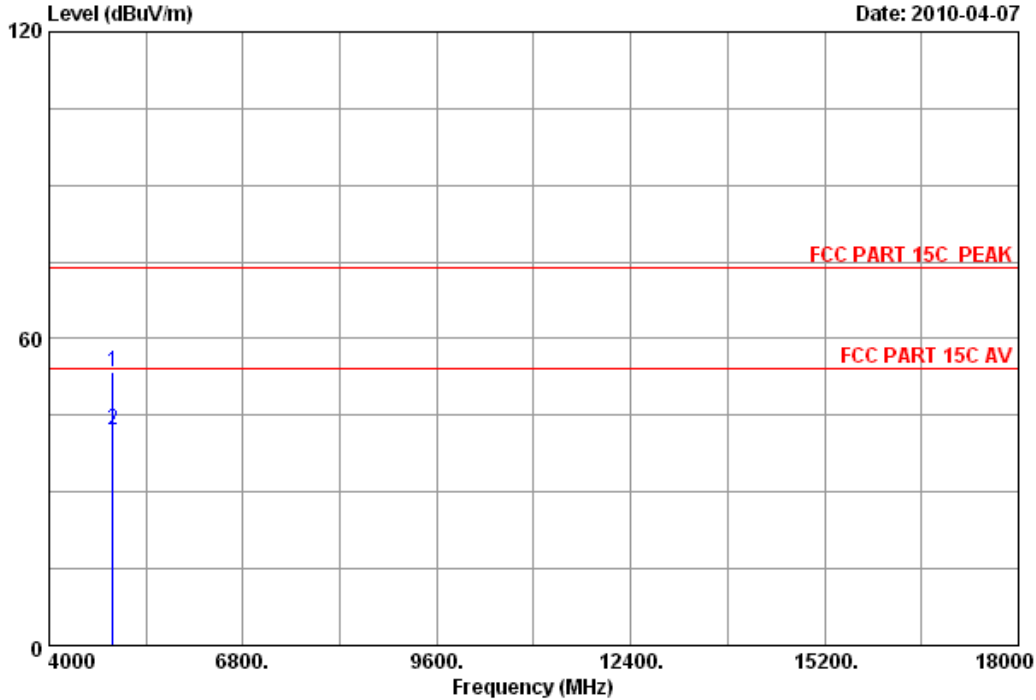

Site no. : 3m Chamber Data no. : 72
 Dis. / Ant. : 3m 3115(0911) Ant. pol. : HORIZONTAL
 Limit : FCC PART 15C PEAK
 Env. / Ins. : 23*C/54% Engineer : Paul
 EUT : Blu-ray Disc Player M/N:VBR220
 Power : DC 5V
 Test mode : Tx Mode 11nHT20 CH11 2462MHz

	Freq. (MHz)	Ant. Factor (dB/m)	Cable loss (dB)	Amp. Factor (dB)	Reading (dBuV)	Emission Level (dBuV/m)	Limits (dBuV/m)	Margin (dB)	Remark
1	4924.000	34.49	12.50	35.34	41.84	53.49	74.00	20.51	Peak
2	4924.000	34.49	12.50	35.34	30.42	42.07	54.00	11.93	Average

Remarks:

1. Emission Level= Antenna Factor + Cable Loss -Amp Factor + Reading.
2. The emission levels that are 20dB below the official limit are not reported.



No.6 Ke Feng Road,Block 52,
 ShenZhen Science & Industry Park
 Noutou,ShenZhen,GuangDong,China
 Tel:+86-755-26639495-7
 Fax:+86-755-26632877
 Postcode:518057

Data: 73 File: E:\2010 report data\C\contel\ACS10Q0594R2.EM6 (108)

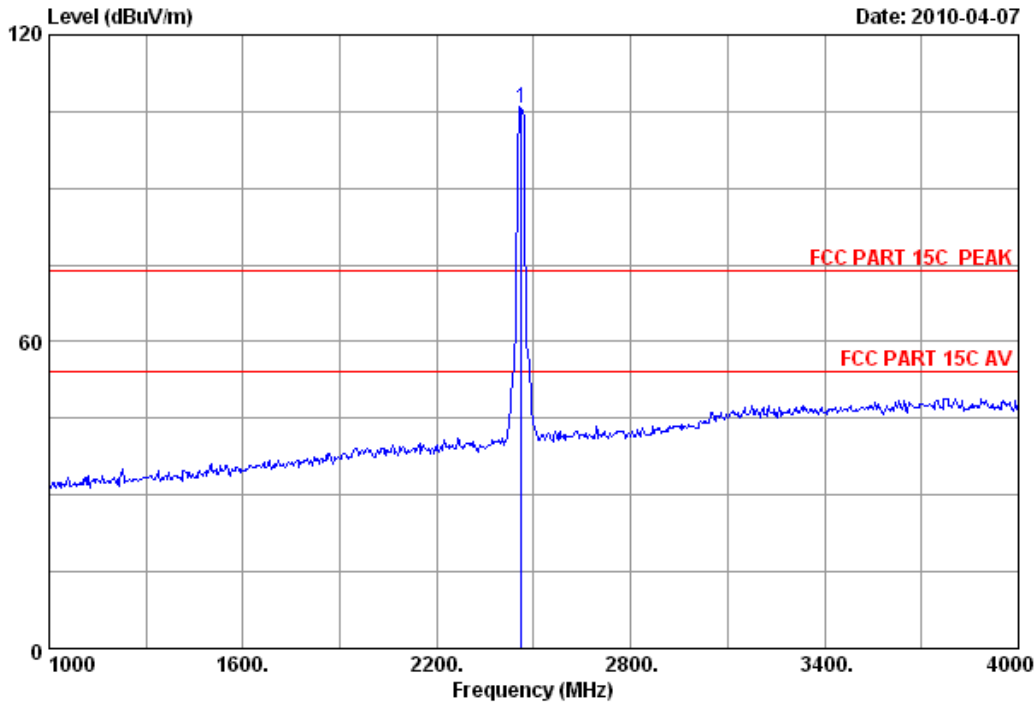

Site no. : 3m Chamber Data no. : 73
 Dis. / Ant. : 3m 3115(0911) Ant. pol. : VERTICAL
 Limit : FCC PART 15C PEAK
 Env. / Ins. : 23°C/54% Engineer : Paul
 EUT : Blu-ray Disc Player M/N:VBR220
 Power : DC 5V
 Test mode : Tx Mode 11nHT20 CH11 2462MHz

	Freq. (MHz)	Ant. Factor (dB/m)	Cable loss (dB)	Amp. Factor (dB)	Reading (dBuV)	Emission			
						Level (dBuV/m)	Limits (dBuV/m)	Margin (dB)	
1	2462.000	29.48	8.82	36.02	103.25	105.53	74.00	-31.53	Peak

Remarks:

1. Emission Level= Antenna Factor + Cable Loss -Amp Factor + Reading.
2. The emission levels that are 20dB below the official limit are not reported.



No.6 Ke Feng Road,Block 52,
 ShenZhen Science & Industry Park
 Noutou,ShenZhen,GuangDong,China
 Tel:+86-755-26639495-7
 Fax:+86-755-26632877
 Postcode:518057

Data: 74 File: E:\2010 report data\C\contel\ACS10Q0594R2.EM6 (108)

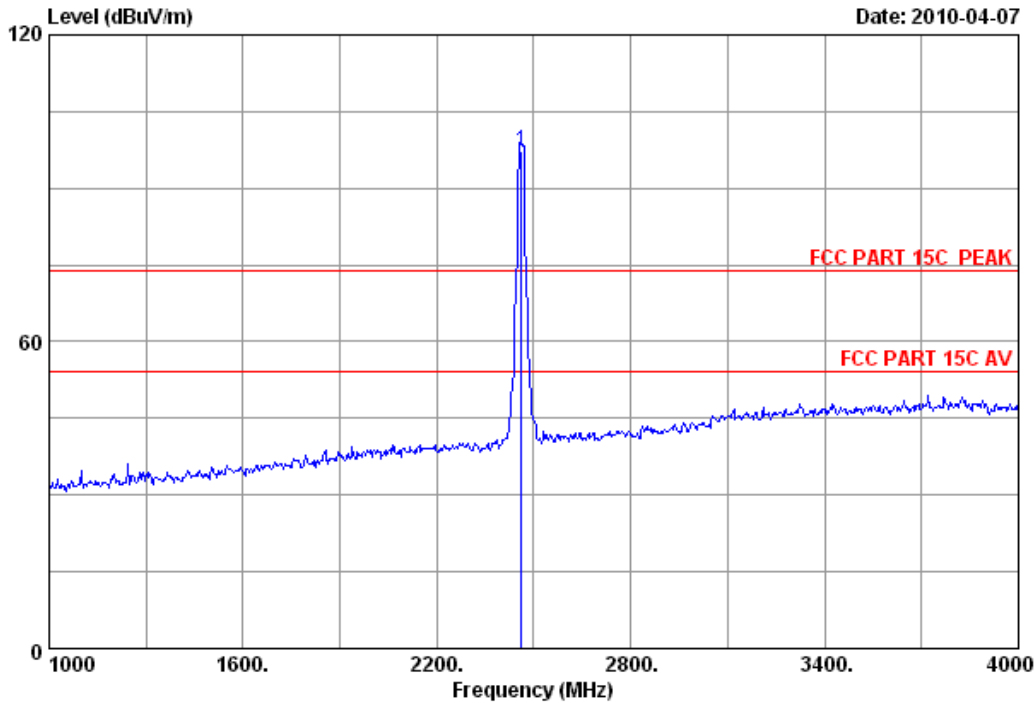

Site no. : 3m Chamber Data no. : 74
 Dis. / Ant. : 3m 3115(0911) Ant. pol. : HORIZONTAL
 Limit : FCC PART 15C PEAK
 Env. / Ins. : 23°C/54% Engineer : Paul
 EUT : Blu-ray Disc Player M/N:VBR220
 Power : DC 5V
 Test mode : Tx Mode 11nHT20 CH11 2462MHz

	Freq. (MHz)	Ant. Factor (dB/m)	Cable loss (dB)	Amp. Factor (dB)	Reading (dBuV)	Emission			
						Level (dBuV/m)	Limits (dBuV/m)	Margin (dB)	Remark
1	2462.000	29.48	8.82	36.02	95.09	97.37	74.00	-23.37	Peak

Remarks:

- Emission Level= Antenna Factor + Cable Loss -Amp Factor + Reading.
- The emission levels that are 20dB below the official limit are not reported.



No.6 Ke Feng Road,Block 52,
 ShenZhen Science & Industry Park
 Noutou,ShenZhen,GuangDong,China
 Tel:+86-755-26639495-7
 Fax:+86-755-26632877
 Postcode:518057

Data: 79 File: E:\2010 report data\C\contel\ACS10Q0594R2.EM6 (108)

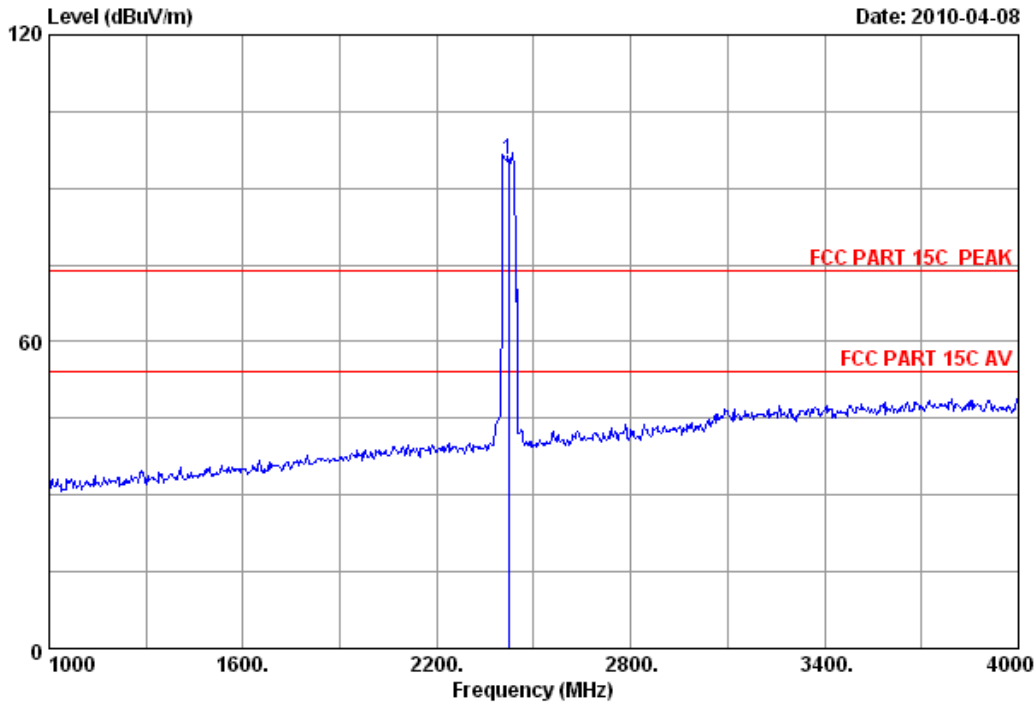

Site no. : 3m Chamber Data no. : 79
 Dis. / Ant. : 3m 3115(0911) Ant. pol. : HORIZONTAL
 Limit : FCC PART 15C PEAK
 Env. / Ins. : 23°C/54% Engineer : Paul
 EUT : Blu-ray Disc Player M/N:VBR220
 Power : DC 5V
 Test mode : Tx Mode 11nHT40 CH1 2422MHz

	Freq. (MHz)	Ant. Factor (dB/m)	Cable loss (dB)	Amp. Factor (dB)	Reading (dBuV)	Emission			Remark
						Level (dBuV/m)	Limits (dBuV/m)	Margin (dB)	
1	2422.000	29.46	8.77	36.01	93.25	95.47	74.00	-21.47	Peak

Remarks:

1. Emission Level= Antenna Factor + Cable Loss -Amp Factor + Reading.
2. The emission levels that are 20dB below the official limit are not reported.



No.6 Ke Feng Road,Block 52,
ShenZhen Science & Industry Park
Noutou,ShenZhen,GuangDong,China
Tel:+86-755-26639495-7
Fax:+86-755-26632877
Postcode:518057

Data: 80 File: E:\2010 report data\C\contel\ACS10Q0594R2.EM6 (108)

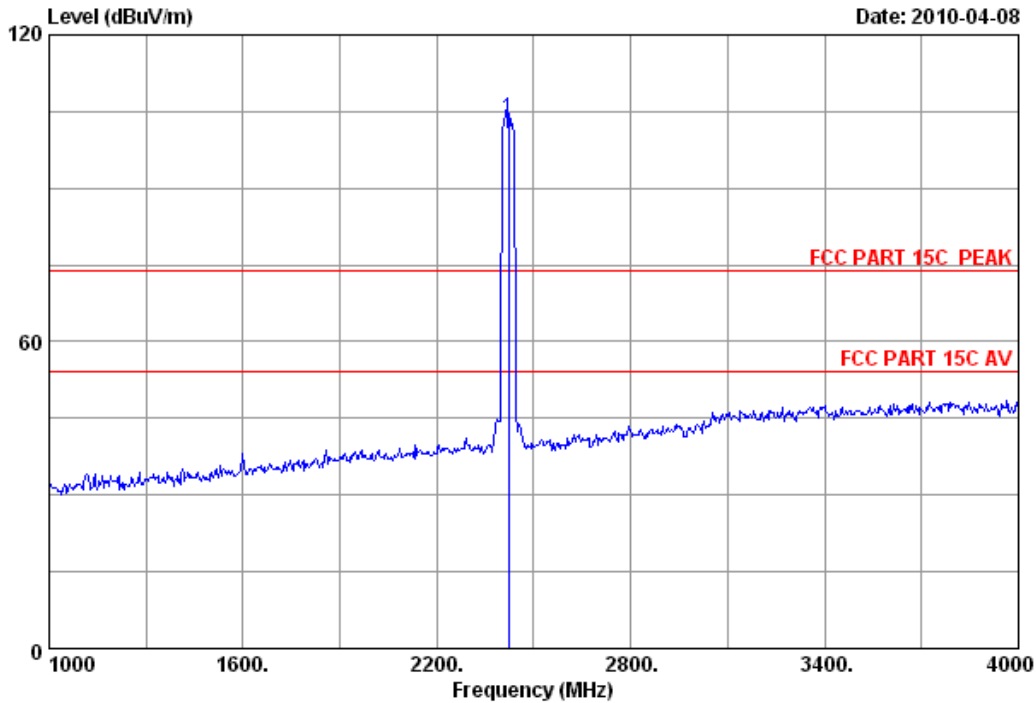

Site no. : 3m Chamber Data no. : 80
 Dis. / Ant. : 3m 3115(0911) Ant. pol. : VERTICAL
 Limit : FCC PART 15C PEAK
 Env. / Ins. : 23°C/54% Engineer : Paul
 EUT : Blu-ray Disc Player M/N:VBR220
 Power : DC 5V
 Test mode : Tx Mode 11nHT40 CH1 2422MHz

	Freq. (MHz)	Ant. Factor (dB/m)	Cable loss (dB)	Amp. Factor (dB)	Reading (dBuV)	Emission			
						Level (dBuV/m)	Limits (dBuV/m)	Margin (dB)	Remark
1	2422.000	29.46	8.77	36.01	101.50	103.72	74.00	-29.72	Peak

Remarks:

1. Emission Level= Antenna Factor + Cable Loss -Amp Factor + Reading.
2. The emission levels that are 20dB below the official limit are not reported.



No.6 Ke Feng Road,Block 52,
ShenZhen Science & Industry Park
Noutou,ShenZhen,GuangDong,China
Tel:+86-755-26639495-7
Fax:+86-755-26632877
Postcode:518057

Data: 85

File: E:\2010 report data\C\contel\ACS10Q0594R2.EM6 (108)

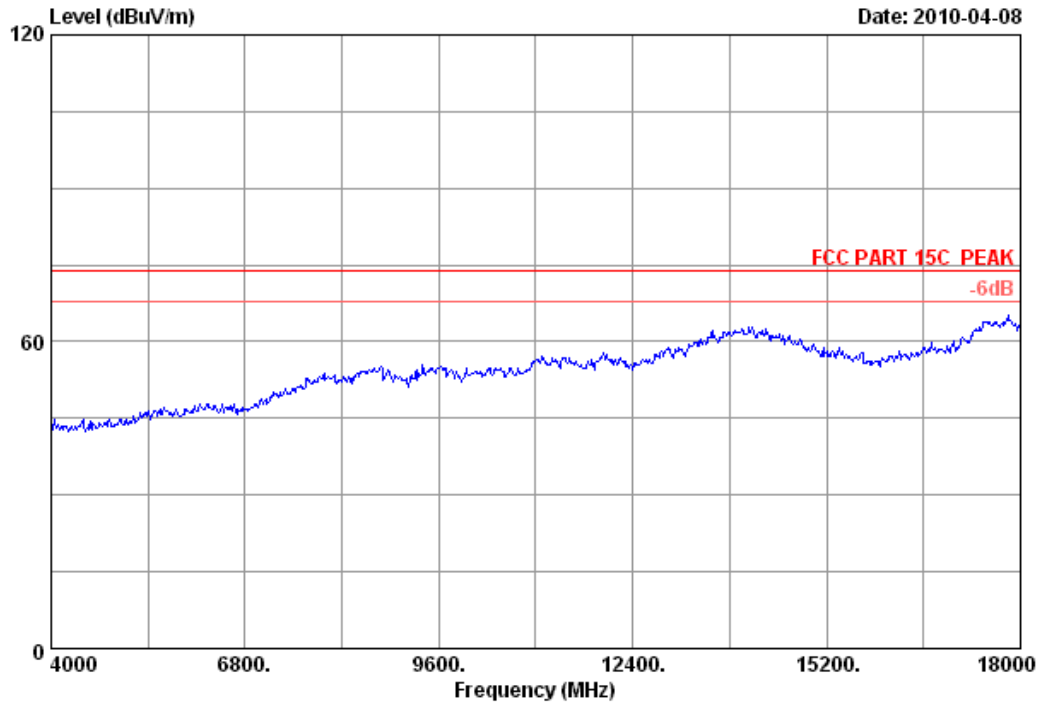

Site no.	: 3m Chamber	Data no.	: 85
Dis. / Ant.	: 3m 3115(0911)	Ant. pol.	: HORIZONTAL
Limit	: FCC PART 15C PEAK		
Env. / Ins.	: 23°C/54%	Engineer	: Paul
EUT	: Blu-ray Disc Player M/N:VBR220		
Power	: DC 5V		
Test mode	: Tx Mode 11nHT40 CH1 2422MHz		



No.6 Ke Feng Road,Block 52,
ShenZhen Science & Industry Park
Noutou,ShenZhen,GuangDong,China
Tel:+86-755-26639495-7
Fax:+86-755-26632877
Postcode:518057

Data: 86 File: E:\2010 report data\C\contel\ACS10Q0594R2.EM6 (108)

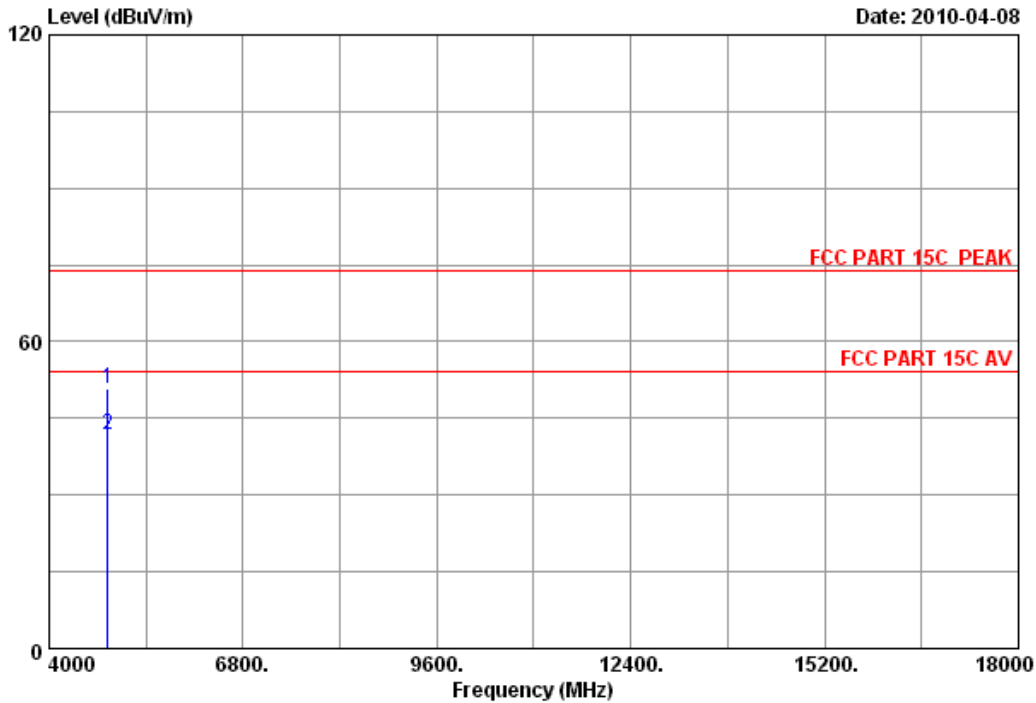

Site no. : 3m Chamber Data no. : 86
 Dis. / Ant. : 3m 3115(0911) Ant. pol. : HORIZONTAL
 Limit : FCC PART 15C PEAK
 Env. / Ins. : 23°C/54% Engineer : Paul
 EUT : Blu-ray Disc Player M/N:VBR220
 Power : DC 5V
 Test mode : Tx Mode 11nHT40 CH1 2422MHz

	Freq. (MHz)	Ant. Factor (dB/m)	Cable loss (dB)	Amp. Factor (dB)	Reading (dBuV)	Emission Level (dBuV/m)	Limits (dBuV/m)	Margin (dB)	Remark
1	4844.000	34.35	12.38	35.25	39.35	50.83	74.00	23.17	Peak
2	4844.000	34.35	12.38	35.25	30.25	41.73	54.00	12.27	Average

Remarks:

1. Emission Level= Antenna Factor + Cable Loss -Amp Factor + Reading.
2. The emission levels that are 20dB below the official limit are not reported.



No.6 Ke Feng Road,Block 52,
 ShenZhen Science & Industry Park
 Noutou,ShenZhen,GuangDong,China
 Tel:+86-755-26639495-7
 Fax:+86-755-26632877
 Postcode:518057

Data: 87 File: E:\2010 report data\C\contel\ACS10Q0594R2.EM6 (108)

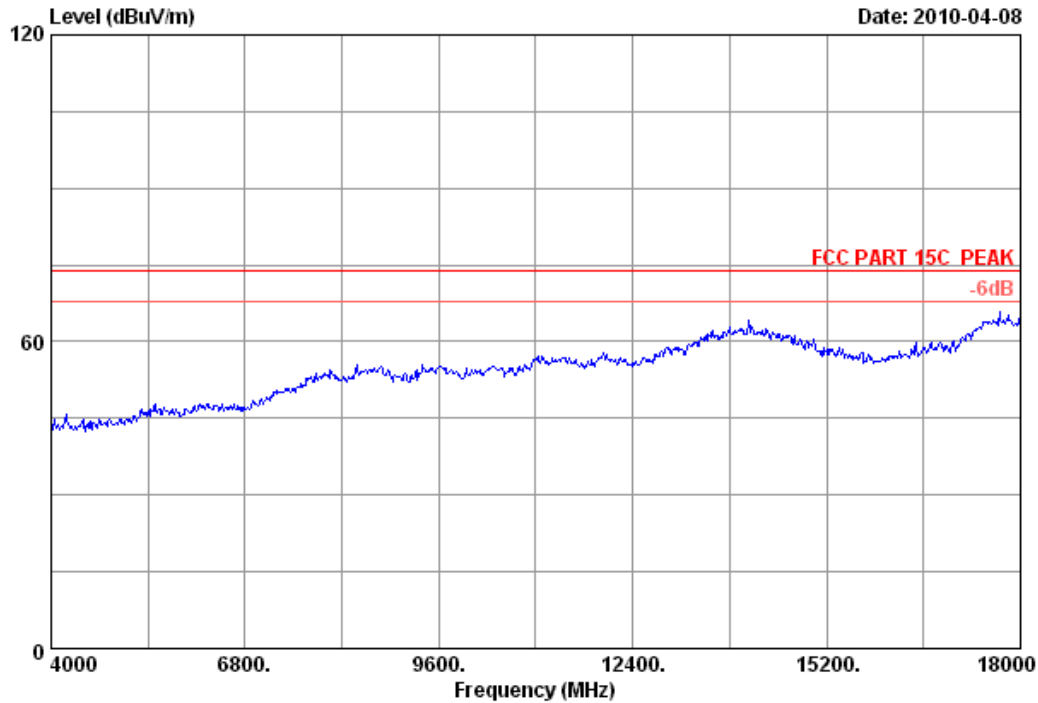

Site no.	: 3m Chamber	Data no.	: 87
Dis. / Ant.	: 3m 3115(0911)	Ant. pol.	: VERTICAL
Limit	: FCC PART 15C PEAK		
Env. / Ins.	: 23°C/54%	Engineer	: Paul
EUT	: Blu-ray Disc Player M/N:VBR220		
Power	: DC 5V		
Test mode	: Tx Mode 11nHT40 CH1	2422MHz	



No.6 Ke Feng Road,Block 52,
 ShenZhen Science & Industry Park
 Noutou,ShenZhen,GuangDong,China
 Tel:+86-755-26639495-7
 Fax:+86-755-26632877
 Postcode:518057

Data: 88 File: E:\2010 report data\C\contel\ACS10Q0594R2.EM6 (108)

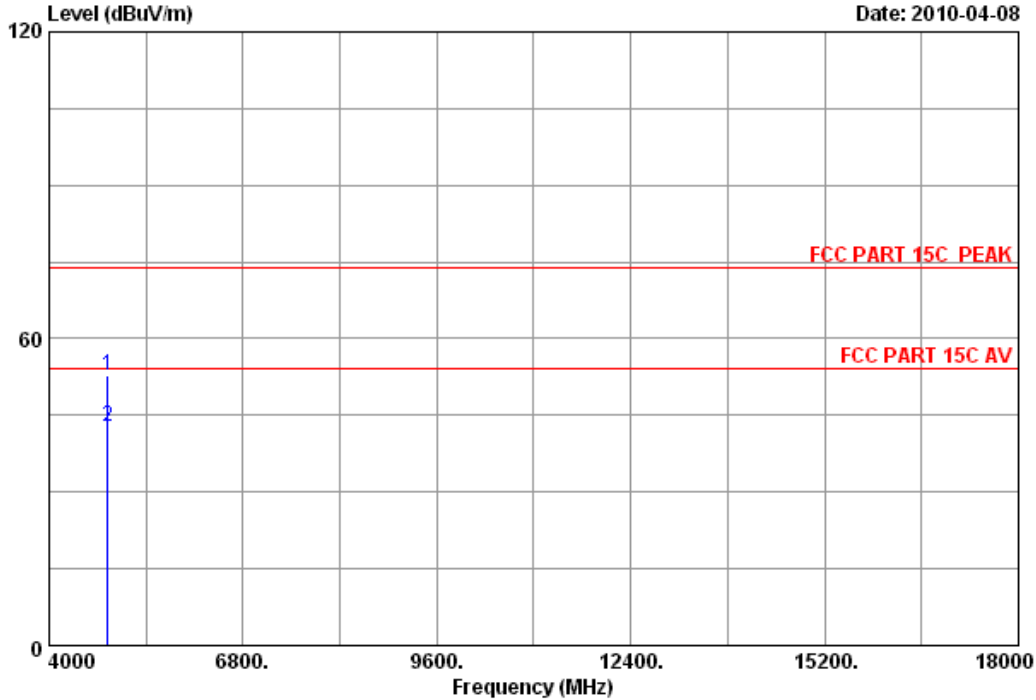

Site no. : 3m Chamber Data no. : 88
 Dis. / Ant. : 3m 3115(0911) Ant. pol. : VERTICAL
 Limit : FCC PART 15C PEAK
 Env. / Ins. : 23*C/54% Engineer : Paul
 EUT : Blu-ray Disc Player M/N:VBR220
 Power : DC 5V
 Test mode : Tx Mode 11nHT40 CH1 2422MHz

	Freq. (MHz)	Ant. Factor (dB/m)	Cable loss (dB)	Amp. Factor (dB)	Reading (dBuV)	Emission Level (dBuV/m)	Limits (dBuV/m)	Margin (dB)	Remark
1	4844.000	34.35	12.38	35.25	41.35	52.83	74.00	21.17	Peak
2	4844.000	34.35	12.38	35.25	31.46	42.94	54.00	11.06	Average

Remarks:

1. Emission Level= Antenna Factor + Cable Loss -Amp Factor + Reading.
2. The emission levels that are 20dB below the official limit are not reported.



No.6 Ke Feng Road,Block 52,
ShenZhen Science & Industry Park
Noutou,ShenZhen,GuangDong,China
Tel:+86-755-26639495-7
Fax:+86-755-26632877
Postcode:518057

Data: 89

File: E:\2010 report data\C\contel\ACS10Q0594R2.EM6 (108)

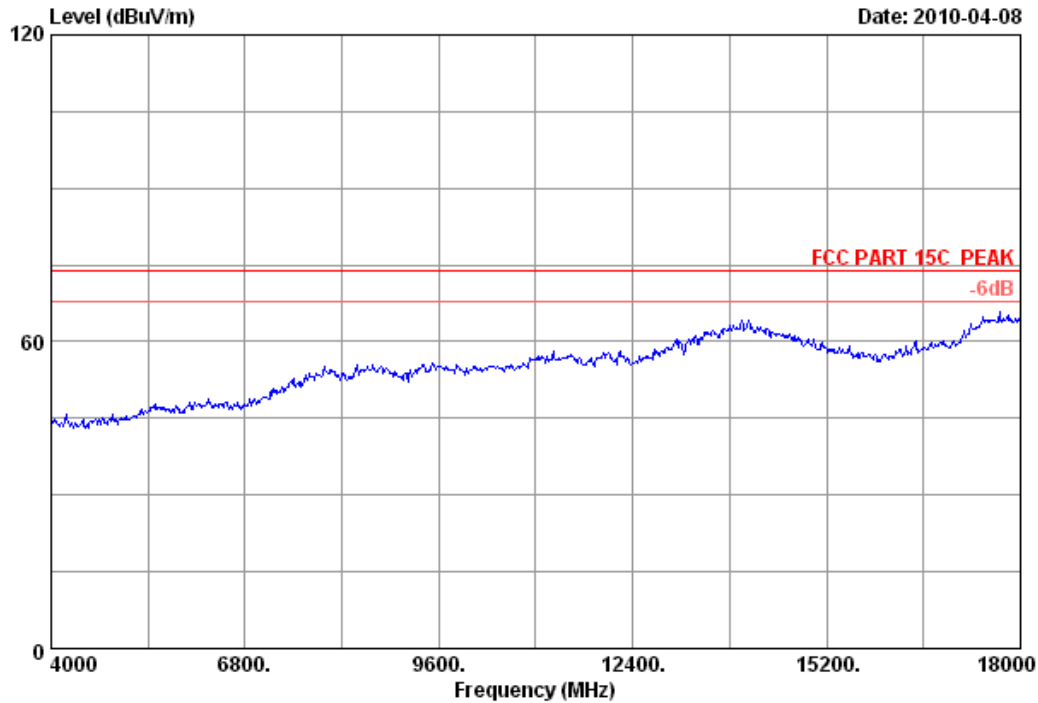

Site no.	: 3m Chamber	Data no.	: 89
Dis. / Ant.	: 3m 3115(0911)	Ant. pol.	: VERTICAL
Limit	: FCC PART 15C PEAK		
Env. / Ins.	: 23°C/54%	Engineer	: Paul
EUT	: Blu-ray Disc Player M/N:VBR220		
Power	: DC 5V		
Test mode	: Tx Mode 11nHT40 CH4	2437MHz	



No.6 Ke Feng Road,Block 52,
 ShenZhen Science & Industry Park
 Noutou,ShenZhen,GuangDong,China
 Tel:+86-755-26639495-7
 Fax:+86-755-26632877
 Postcode:518057

Data: 90 File: E:\2010 report data\C\contel\ACS10Q0594R2.EM6 (108)

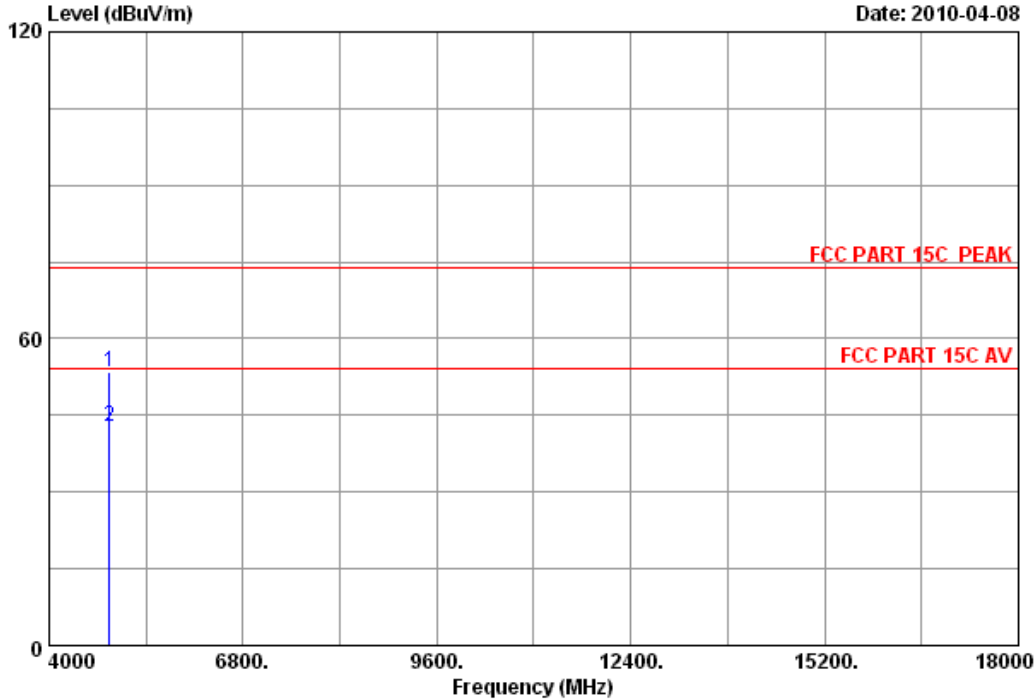

Site no. : 3m Chamber Data no. : 90
 Dis. / Ant. : 3m 3115(0911) Ant. pol. : VERTICAL
 Limit : FCC PART 15C PEAK
 Env. / Ins. : 23*C/54% Engineer : Paul
 EUT : Blu-ray Disc Player M/N:VBR220
 Power : DC 5V
 Test mode : Tx Mode 11nHT40 CH4 2437MHz

	Freq. (MHz)	Ant. Factor (dB/m)	Cable loss (dB)	Amp. Factor (dB)	Reading (dBuV)	Emission Level (dBuV/m)	Limits (dBuV/m)	Margin (dB)	Remark
1	4874.000	34.41	12.44	35.36	42.01	53.50	74.00	20.50	Peak
2	4874.000	34.41	12.44	35.36	31.28	42.77	54.00	11.23	Average

Remarks:

1. Emission Level= Antenna Factor + Cable Loss -Amp Factor + Reading.
2. The emission levels that are 20dB below the official limit are not reported.



No.6 Ke Feng Road,Block 52,
ShenZhen Science & Industry Park
Noutou,ShenZhen,GuangDong,China
Tel:+86-755-26639495-7
Fax:+86-755-26632877
Postcode:518057

Data: 91

File: E:\2010 report data\C\contel\ACS10Q0594R2.EM6 (108)

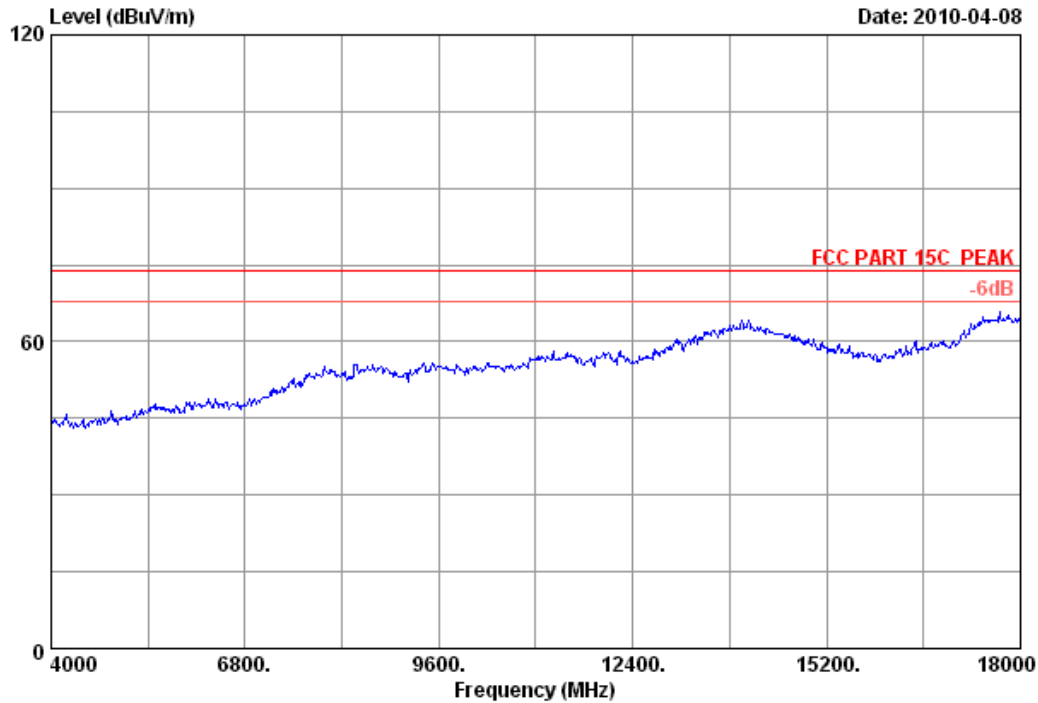

Site no.	: 3m Chamber	Data no.	: 91
Dis. / Ant.	: 3m 3115(0911)	Ant. pol.	: HORIZONTAL
Limit	: FCC PART 15C PEAK		
Env. / Ins.	: 23°C/54%	Engineer	: Paul
EUT	: Blu-ray Disc Player M/N:VBR220		
Power	: DC 5V		
Test mode	: Tx Mode 11nHT40 CH4 2437MHz		



No.6 Ke Feng Road,Block 52,
 ShenZhen Science & Industry Park
 Noutou,ShenZhen,GuangDong,China
 Tel:+86-755-26639495-7
 Fax:+86-755-26632877
 Postcode:518057

Data: 92 File: E:\2010 report data\C\contel\ACS10Q0594R2.EM6 (108)

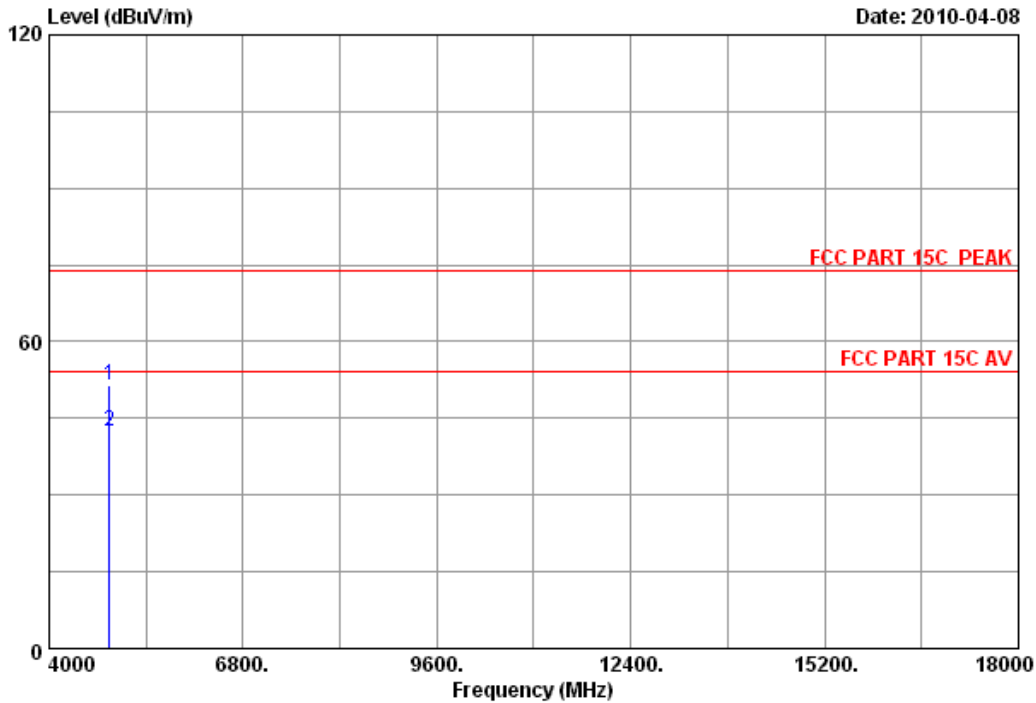

Site no. : 3m Chamber Data no. : 92
 Dis. / Ant. : 3m 3115(0911) Ant. pol. : HORIZONTAL
 Limit : FCC PART 15C PEAK
 Env. / Ins. : 23*C/54% Engineer : Paul
 EUT : Blu-ray Disc Player M/N:VBR220
 Power : DC 5V
 Test mode : Tx Mode 11nHT40 CH4 2437MHz

	Freq. (MHz)	Ant. Factor (dB/m)	Cable loss (dB)	Amp. Factor (dB)	Reading (dBuV)	Emission Level (dBuV/m)	Limits (dBuV/m)	Margin (dB)	Remark
1	4874.000	34.41	12.44	35.36	39.85	51.34	74.00	22.66	Peak
2	4874.000	34.41	12.44	35.36	30.80	42.29	54.00	11.71	Average

Remarks:

1. Emission Level= Antenna Factor + Cable Loss -Amp Factor + Reading.
2. The emission levels that are 20dB below the official limit are not reported.



No.6 Ke Feng Road,Block 52,
 ShenZhen Science & Industry Park
 Noutou,ShenZhen,GuangDong,China
 Tel:+86-755-26639495-7
 Fax:+86-755-26632877
 Postcode:518057

Data: 93 File: E:\2010 report data\C\contel\ACS10Q0594R2.EM6 (108)

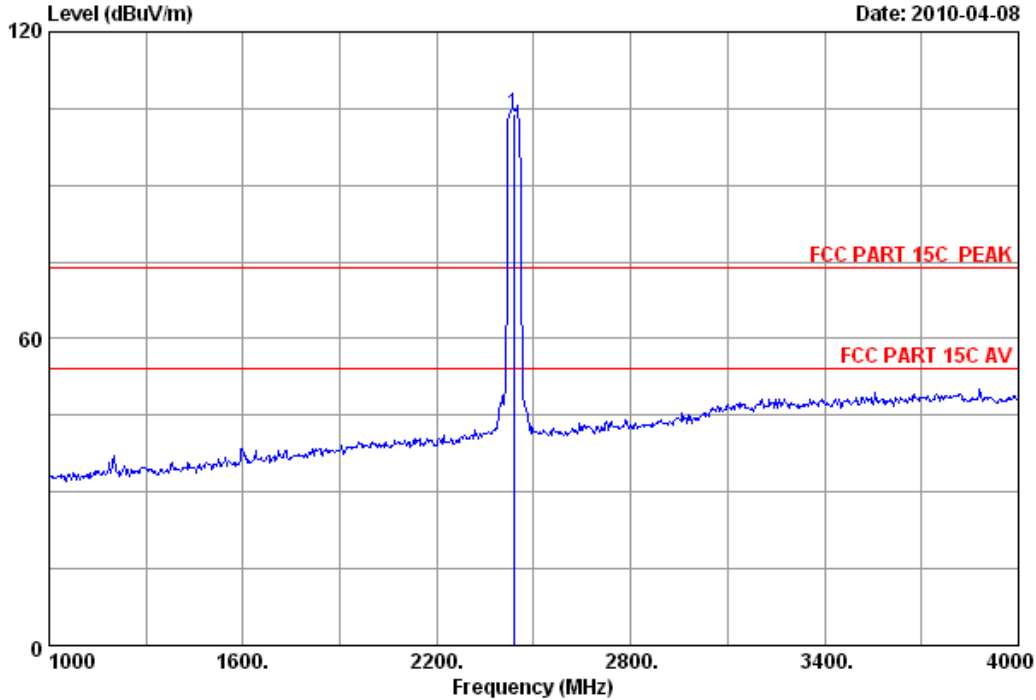

Site no. : 3m Chamber Data no. : 93
 Dis. / Ant. : 3m 3115(0911) Ant. pol. : VERTICAL
 Limit : FCC PART 15C PEAK
 Env. / Ins. : 23°C/54% Engineer : Paul
 EUT : Blu-ray Disc Player M/N:VBR220
 Power : DC 5V
 Test mode : Tx Mode 11nHT40 CH4 2437MHz

	Freq. (MHz)	Ant. Factor (dB/m)	Cable loss (dB)	Amp. Factor (dB)	Reading (dBuV)	Emission			Remark
						Level (dBuV/m)	Limits (dBuV/m)	Margin (dB)	
1	2437.000	29.47	8.77	36.06	101.86	104.04	74.00	-30.04	Peak

Remarks:

1. Emission Level= Antenna Factor + Cable Loss -Amp Factor + Reading.
2. The emission levels that are 20dB below the official limit are not reported.



No.6 Ke Feng Road,Block 52,
 ShenZhen Science & Industry Park
 Noutou,ShenZhen,GuangDong,China
 Tel:+86-755-26639495-7
 Fax:+86-755-26632877
 Postcode:518057

Data: 94 File: E:\2010 report data\C\contel\ACS10Q0594R2.EM6 (108)

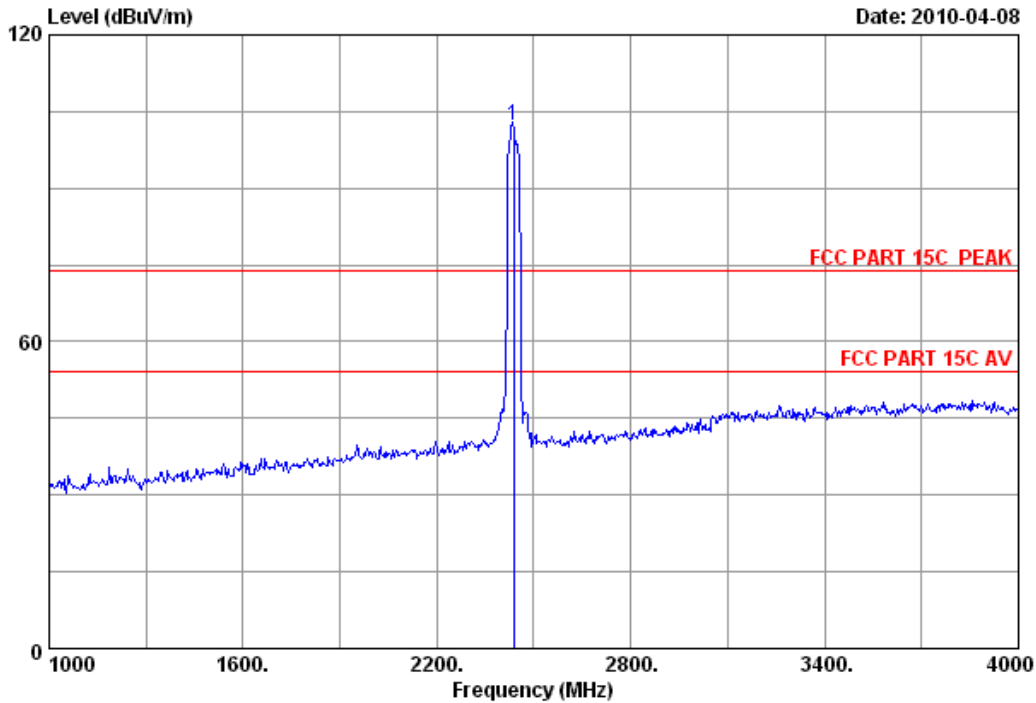

Site no. : 3m Chamber Data no. : 94
 Dis. / Ant. : 3m 3115(0911) Ant. pol. : HORIZONTAL
 Limit : FCC PART 15C PEAK
 Env. / Ins. : 23°C/54% Engineer : Paul
 EUT : Blu-ray Disc Player M/N:VBR220
 Power : DC 5V
 Test mode : Tx Mode 11nHT40 CH4 2437MHz

	Freq. (MHz)	Ant. Factor (dB/m)	Cable loss (dB)	Amp. Factor (dB)	Reading (dBuV)	Emission			
						Level (dBuV/m)	Limits (dBuV/m)	Margin (dB)	
1	2437.000	29.47	8.77	36.06	100.25	102.43	74.00	-28.43	Peak

Remarks:

- Emission Level= Antenna Factor + Cable Loss -Amp Factor + Reading.
- The emission levels that are 20dB below the official limit are not reported.



No.6 Ke Feng Road,Block 52,
 ShenZhen Science & Industry Park
 Noutou,ShenZhen,GuangDong,China
 Tel:+86-755-26639495-7
 Fax:+86-755-26632877
 Postcode:518057

Data: 95 File: E:\2010 report data\C\contel\ACS10Q0594R2.EM6 (108)

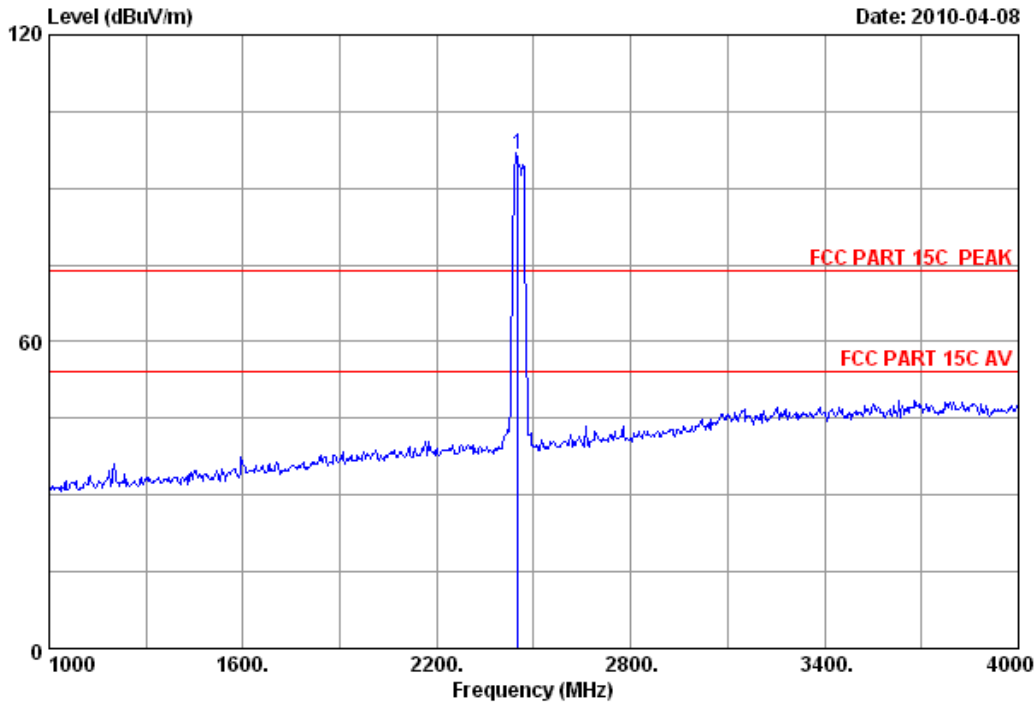

Site no. : 3m Chamber Data no. : 95
 Dis. / Ant. : 3m 3115(0911) Ant. pol. : HORIZONTAL
 Limit : FCC PART 15C PEAK
 Env. / Ins. : 23°C/54% Engineer : Paul
 EUT : Blu-ray Disc Player M/N:VBR220
 Power : DC 5V
 Test mode : Tx Mode 11nHT40 CH7 2452MHz

	Freq. (MHz)	Ant. Factor (dB/m)	Cable loss (dB)	Amp. Factor (dB)	Reading (dBuV)	Emission			Remark
						Level (dBuV/m)	Limits (dBuV/m)	Margin (dB)	
1	2452.000	29.47	8.82	36.06	94.25	96.48	74.00	-22.48	Peak

Remarks:

1. Emission Level= Antenna Factor + Cable Loss -Amp Factor + Reading.
2. The emission levels that are 20dB below the official limit are not reported.



No.6 Ke Feng Road,Block 52,
 ShenZhen Science & Industry Park
 Noutou,ShenZhen,GuangDong,China
 Tel:+86-755-26639495-7
 Fax:+86-755-26632877
 Postcode:518057

Data: 96 File: E:\2010 report data\C\contel\ACS10Q0594R2.EM6 (108)

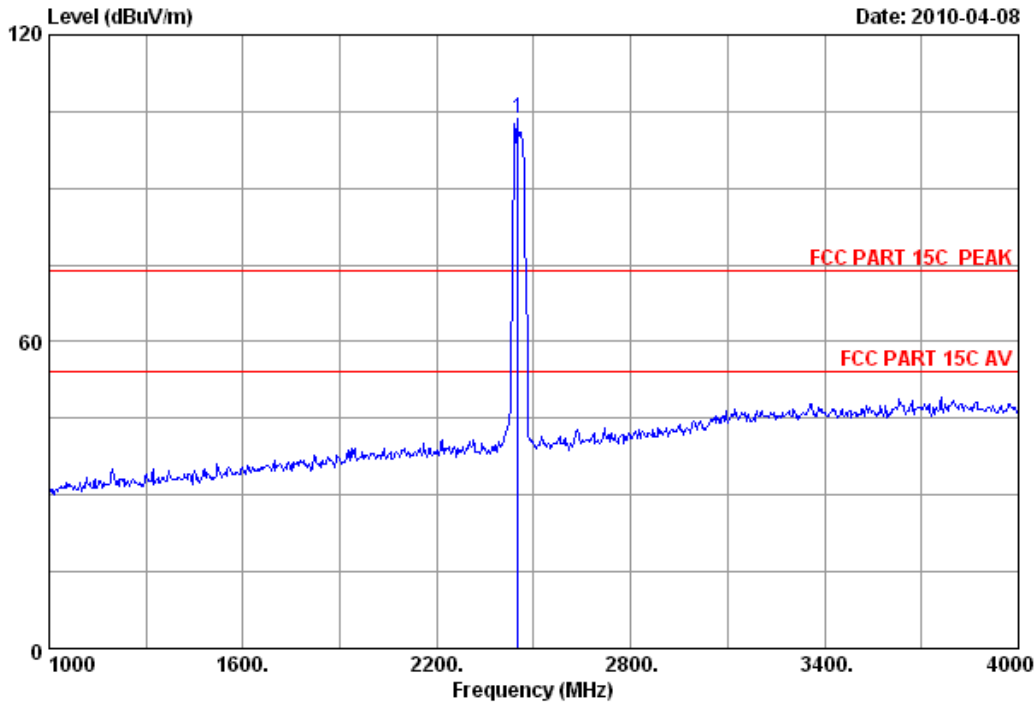

Site no. : 3m Chamber Data no. : 96
 Dis. / Ant. : 3m 3115(0911) Ant. pol. : VERTICAL
 Limit : FCC PART 15C PEAK
 Env. / Ins. : 23°C/54% Engineer : Paul
 EUT : Blu-ray Disc Player M/N:VBR220
 Power : DC 5V
 Test mode : Tx Mode 11nHT40 CH7 2452MHz

	Freq. (MHz)	Ant. Factor (dB/m)	Cable loss (dB)	Amp. Factor (dB)	Reading (dBUV)	Emission			
						Level (dBUV/m)	Limits (dBUV/m)	Margin (dB)	Remark
1	2452.000	29.47	8.82	36.06	101.26	103.49	74.00	-29.49	Peak

Remarks:

- Emission Level= Antenna Factor + Cable Loss -Amp Factor + Reading.
- The emission levels that are 20dB below the official limit are not reported.



No.6 Ke Feng Road,Block 52,
ShenZhen Science & Industry Park
Noutou,ShenZhen,GuangDong,China
Tel:+86-755-26639495-7
Fax:+86-755-26632877
Postcode:518057

Data: 101 File: E:\2010 report data\C\contel\ACS10Q0594R2.EM6 (108)

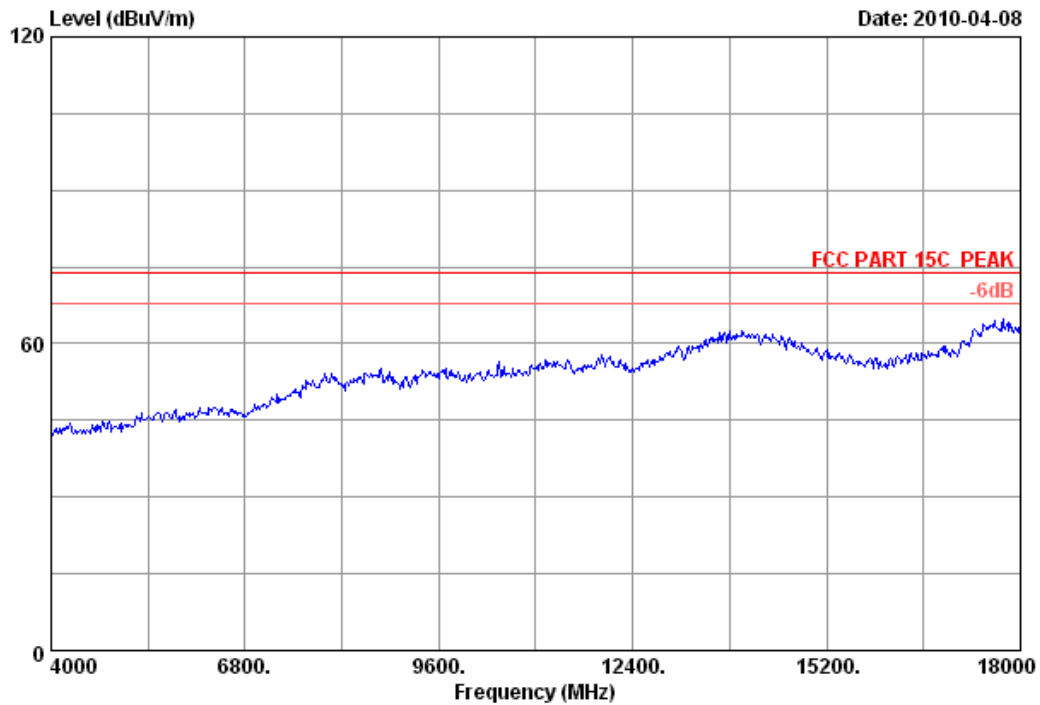

Site no.	: 3m Chamber	Data no.	: 101
Dis. / Ant.	: 3m 3115(0911)	Ant. pol.	: HORIZONTAL
Limit	: FCC PART 15C PEAK		
Env. / Ins.	: 23°C/54%	Engineer	: Paul
EUT	: Blu-ray Disc Player M/N:VBR220		
Power	: DC 5V		
Test mode	: Tx Mode 11nHT40 CH7 2452MHz		



No.6 Ke Feng Road,Block 52,
 ShenZhen Science & Industry Park
 Noutou,ShenZhen,GuangDong,China
 Tel:+86-755-26639495-7
 Fax:+86-755-26632877
 Postcode:518057

Data: 102 File: E:\2010 report data\C\contel\ACS10Q0594R2.EM6 (108)

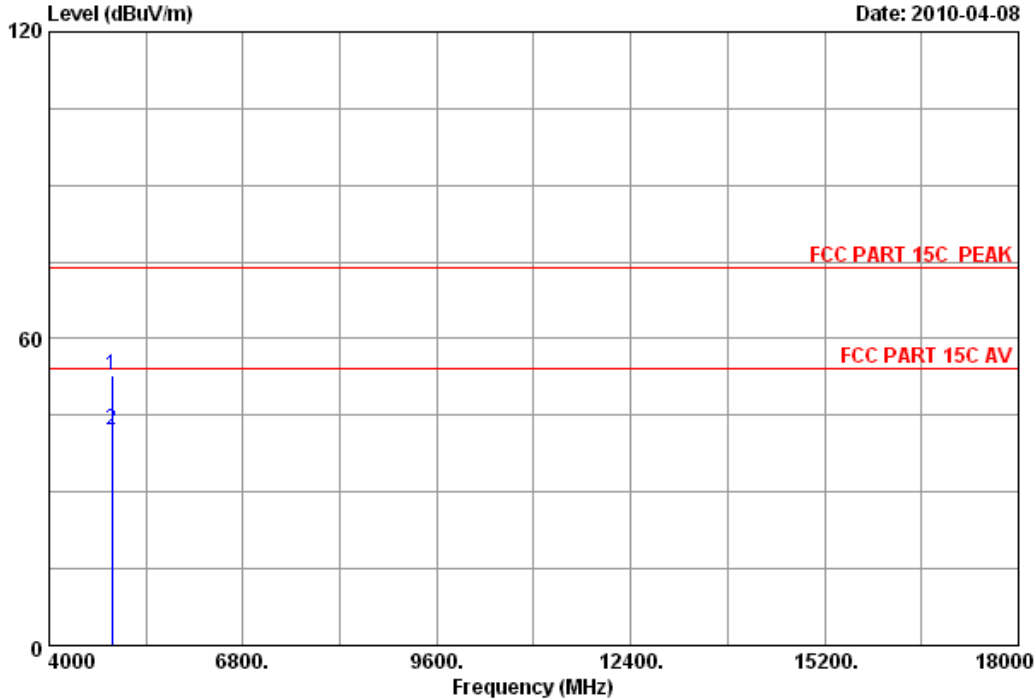

Site no. : 3m Chamber Data no. : 102
 Dis. / Ant. : 3m 3115(0911) Ant. pol. : HORIZONTAL
 Limit : FCC PART 15C PEAK
 Env. / Ins. : 23*C/54% Engineer : Paul
 EUT : Blu-ray Disc Player M/N:VBR220
 Power : DC 5V
 Test mode : Tx Mode 11nHT40 CH7 2452MHz

	Freq. (MHz)	Ant. Factor (dB/m)	Cable loss (dB)	Amp. Factor (dB)	Reading (dBuV)	Emission Level (dBuV/m)	Limits (dBuV/m)	Margin (dB)	Remark
1	4904.000	34.46	12.47	35.27	41.22	52.88	74.00	21.12	Peak
2	4904.000	34.46	12.47	35.27	30.52	42.18	54.00	11.82	Average

Remarks:

1. Emission Level= Antenna Factor + Cable Loss -Amp Factor + Reading.
2. The emission levels that are 20dB below the official limit are not reported.



No.6 Ke Feng Road,Block 52,
ShenZhen Science & Industry Park
Noutou,ShenZhen,GuangDong,China
Tel:+86-755-26639495-7
Fax:+86-755-26632877
Postcode:518057

Data: 103 File: E:\2010 report data\C\contel\ACS10Q0594R2.EM6 (108)

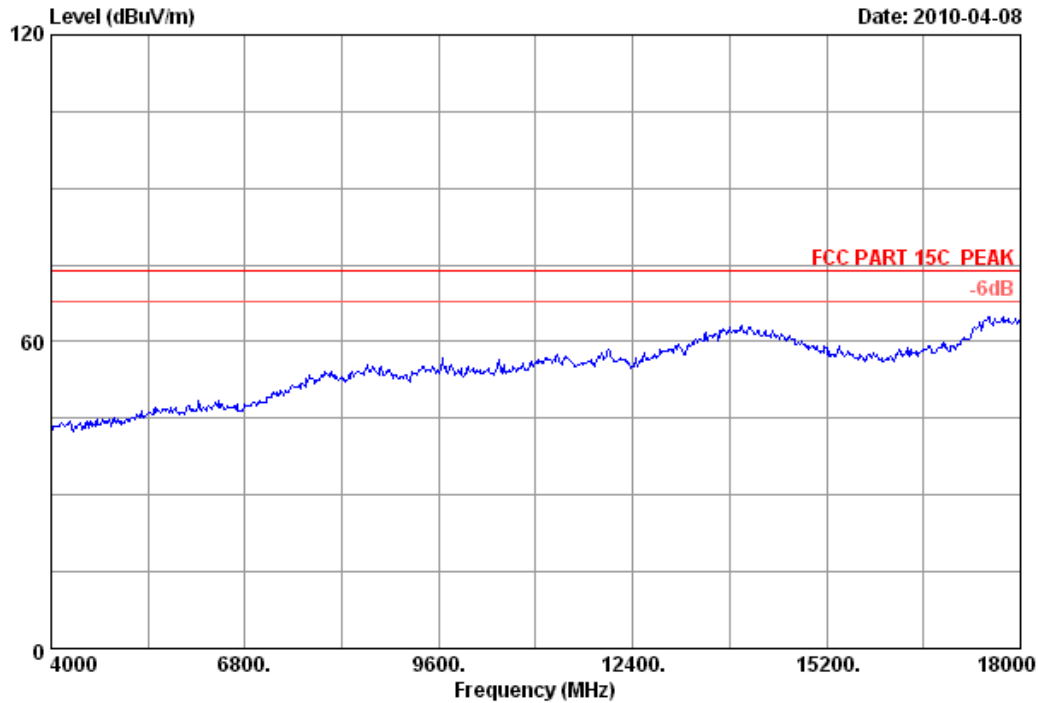

Site no.	: 3m Chamber	Data no.	: 103
Dis. / Ant.	: 3m 3115(0911)	Ant. pol.	: VERTICAL
Limit	: FCC PART 15C PEAK		
Env. / Ins.	: 23°C/54%	Engineer	: Paul
EUT	: Blu-ray Disc Player M/N:VBR220		
Power	: DC 5V		
Test mode	: Tx Mode 11nHT40 CH7	2452MHz	



No.6 Ke Feng Road,Block 52,
 ShenZhen Science & Industry Park
 Noutou,ShenZhen,GuangDong,China
 Tel:+86-755-26639495-7
 Fax:+86-755-26632877
 Postcode:518057

Data: 104 File: E:\2010 report data\C\contel\ACS10Q0594R2.EM6 (108)

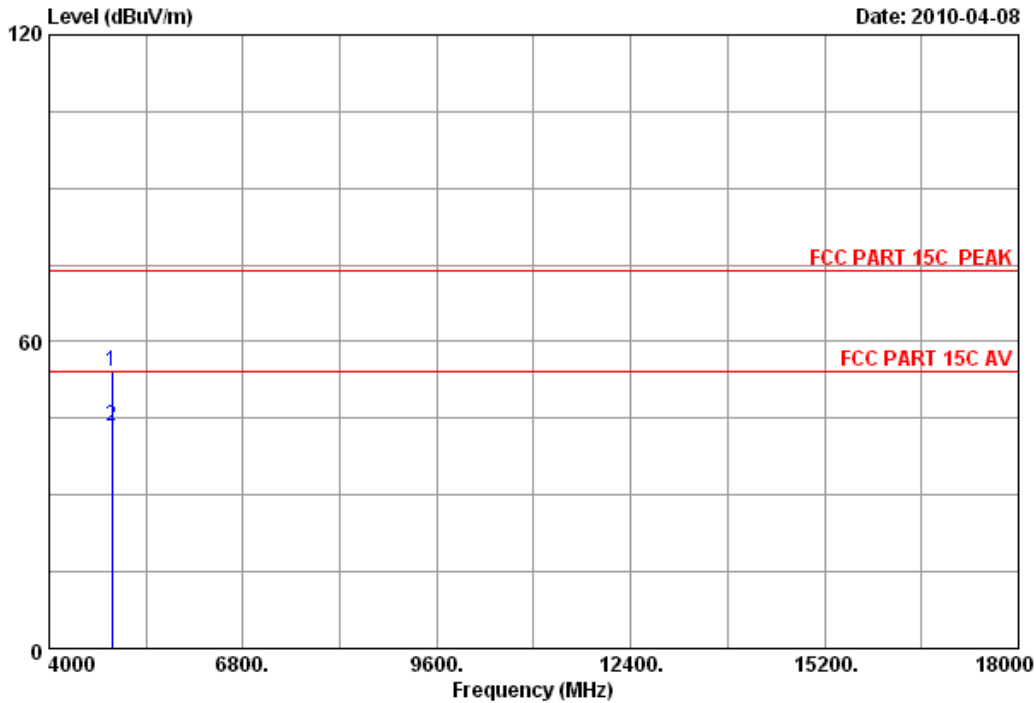

Site no. : 3m Chamber Data no. : 104
 Dis. / Ant. : 3m 3115(0911) Ant. pol. : VERTICAL
 Limit : FCC PART 15C PEAK
 Env. / Ins. : 23*C/54% Engineer : Paul
 EUT : Blu-ray Disc Player M/N:VBR220
 Power : DC 5V
 Test mode : Tx Mode 11nHT40 CH7 2452MHz

	Freq. (MHz)	Ant. Factor (dB/m)	Cable loss (dB)	Amp. Factor (dB)	Reading (dBuV)	Emission Level (dBuV/m)	Limits (dBuV/m)	Margin (dB)	Remark
1	4904.000	34.46	12.47	35.27	42.40	54.06	74.00	19.94	Peak
2	4904.000	34.46	12.47	35.27	31.76	43.42	54.00	10.58	Average

Remarks:

1. Emission Level= Antenna Factor + Cable Loss -Amp Factor + Reading.
2. The emission levels that are 20dB below the official limit are not reported.

5. CONDUCTED SPURIOUS EMISSIONS

5.1. Test Equipment

Item	Equipment	Manufacturer	Model No.	Serial No.	Last Cal.	Cal. Interval
1.	Spectrum Analyzer	Agilent	E4446A	US44300459	May.08, 09	1 Year
2.	Attenuator	Agilent	8491B	MY39262165	May.08, 09	1 Year
3.	RF Cable	Hubersuhner	SUCOFLEX 102	28618/2	May.08, 09	1Year

5.2. Limit

In any 100kHz bandwidth outside the frequency bands in which the spread spectrum intentional radiator is operating, the radio frequency power that is produced by the intentional radiator shall be at least 20dB below that in the 100kHz bandwidth within the band that contains the highest level of the desired power, In addition, radiated emissions which fall in the restricted bands, as defined in §15.205(a), must also comply with the radiated emission limits specified in 15.209(a).

5.3. Test Procedure

The transmitter output was connected to a spectrum analyzer, The resolution bandwidth is set to 100 kHz, The video bandwidth is set to 300 kHz and measure all the emissions detected.

5.4. Test result

PASS (The testing data was attached in the next pages.)

Conducted emission test data:

Chain 1:

Test Mode: IEEE 802.11b TX (CH1)

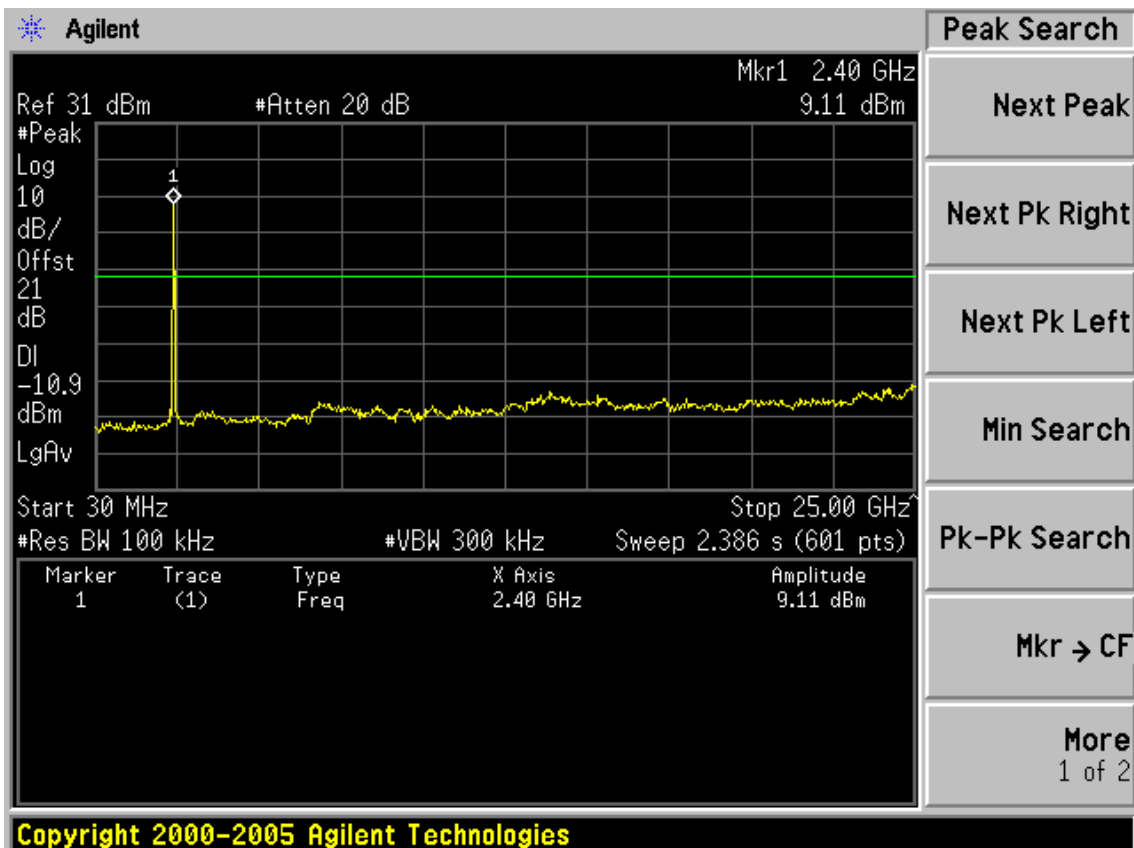
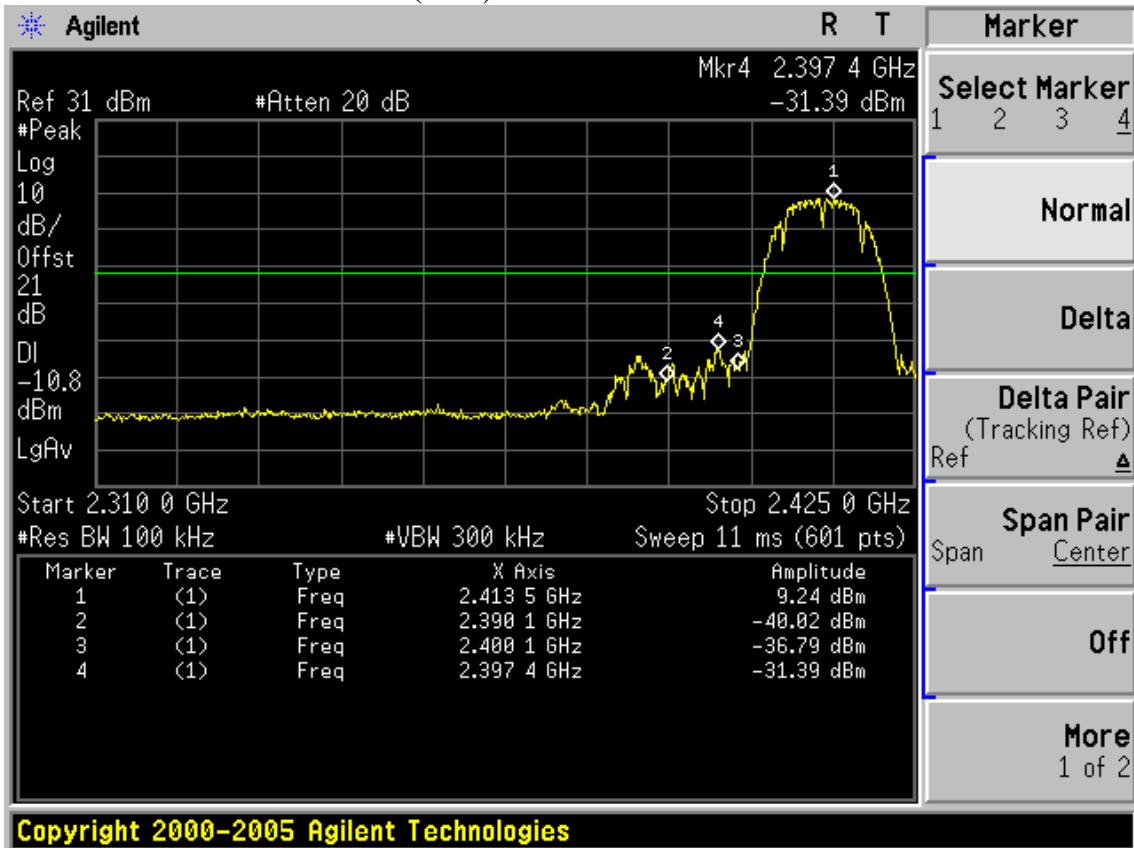

(CH6)

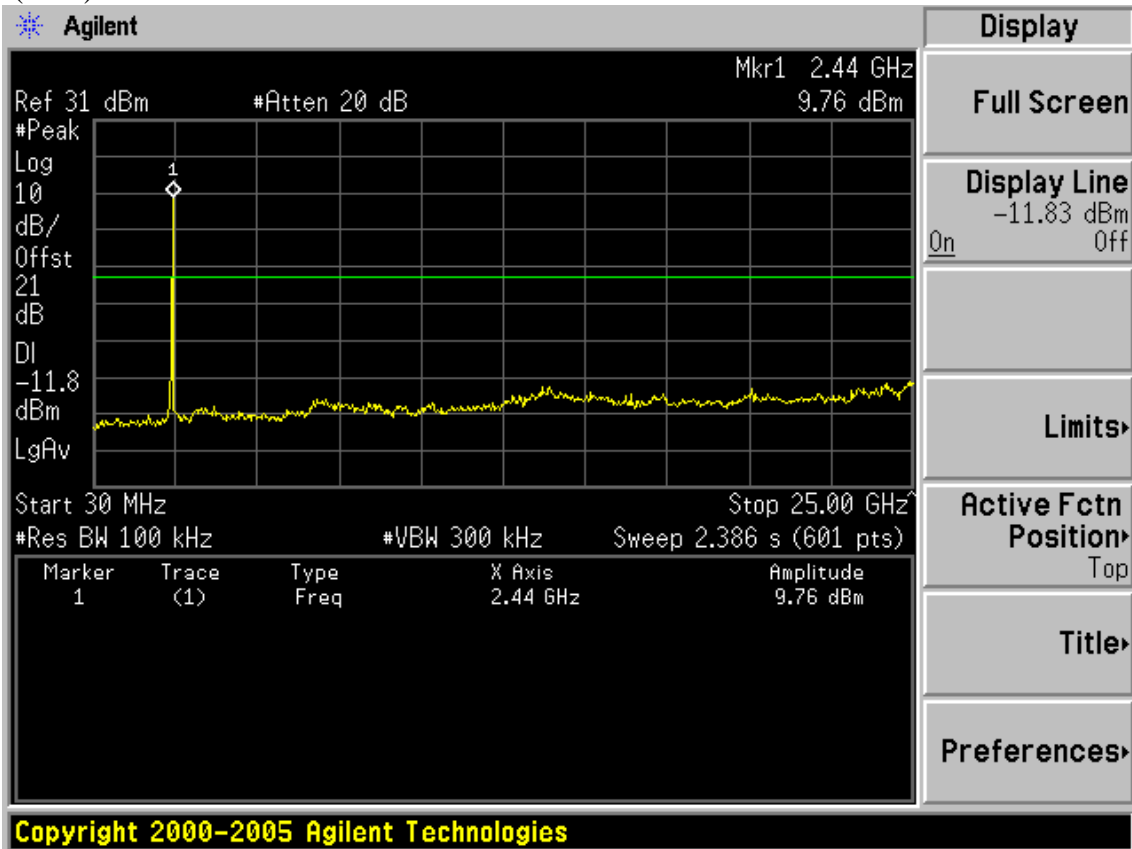

(CH11)

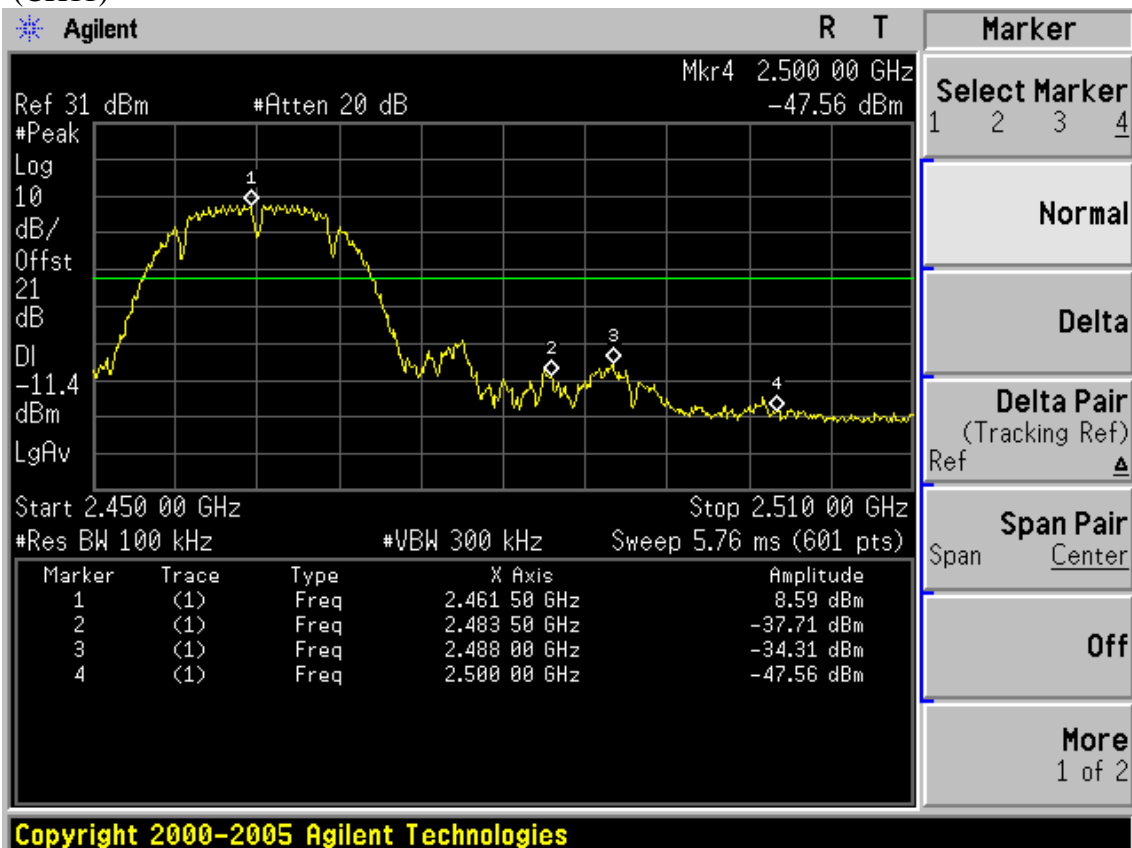

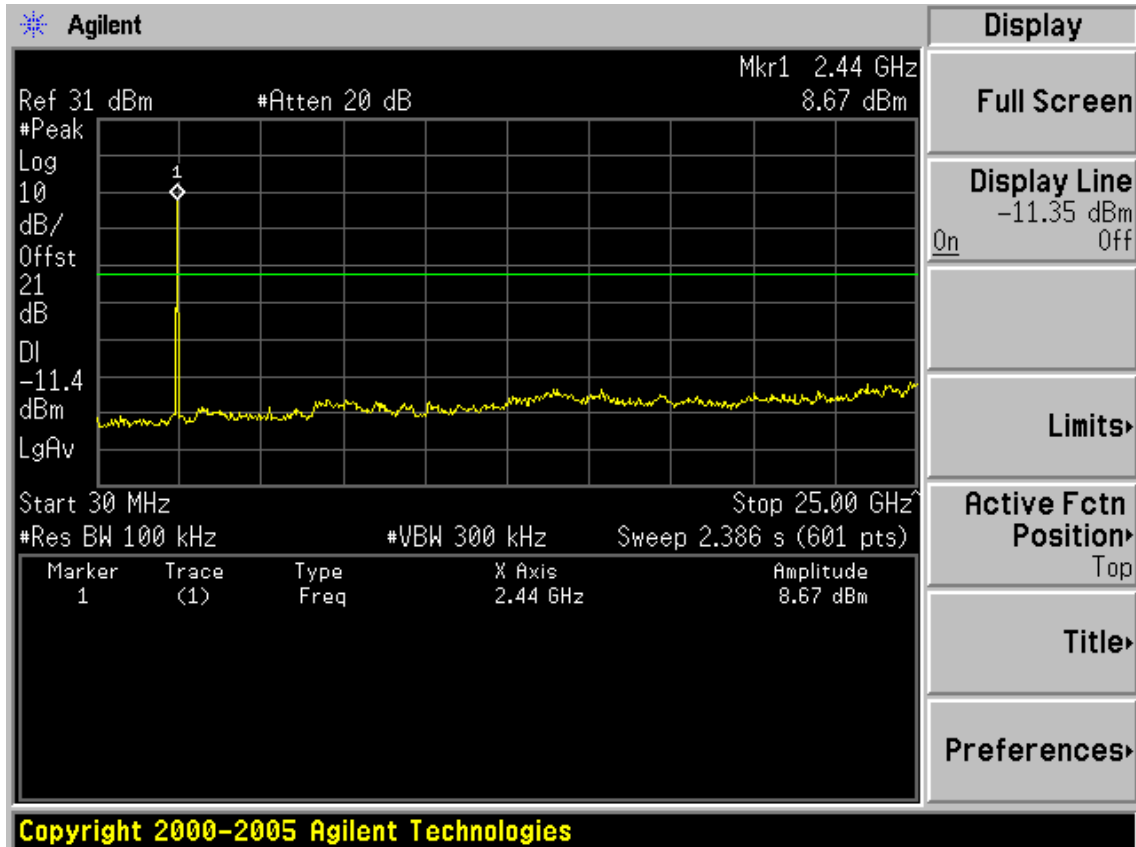

Test Mode: IEEE 802.11g TX (CH1)

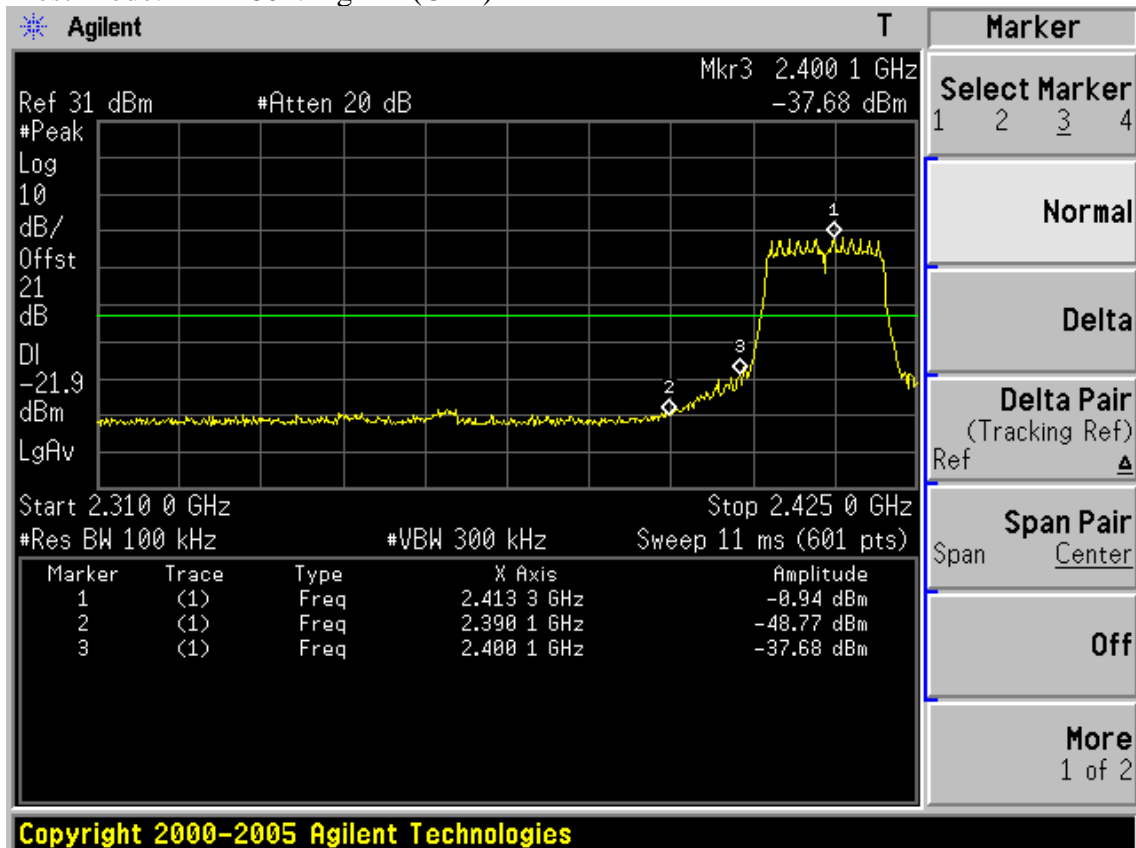

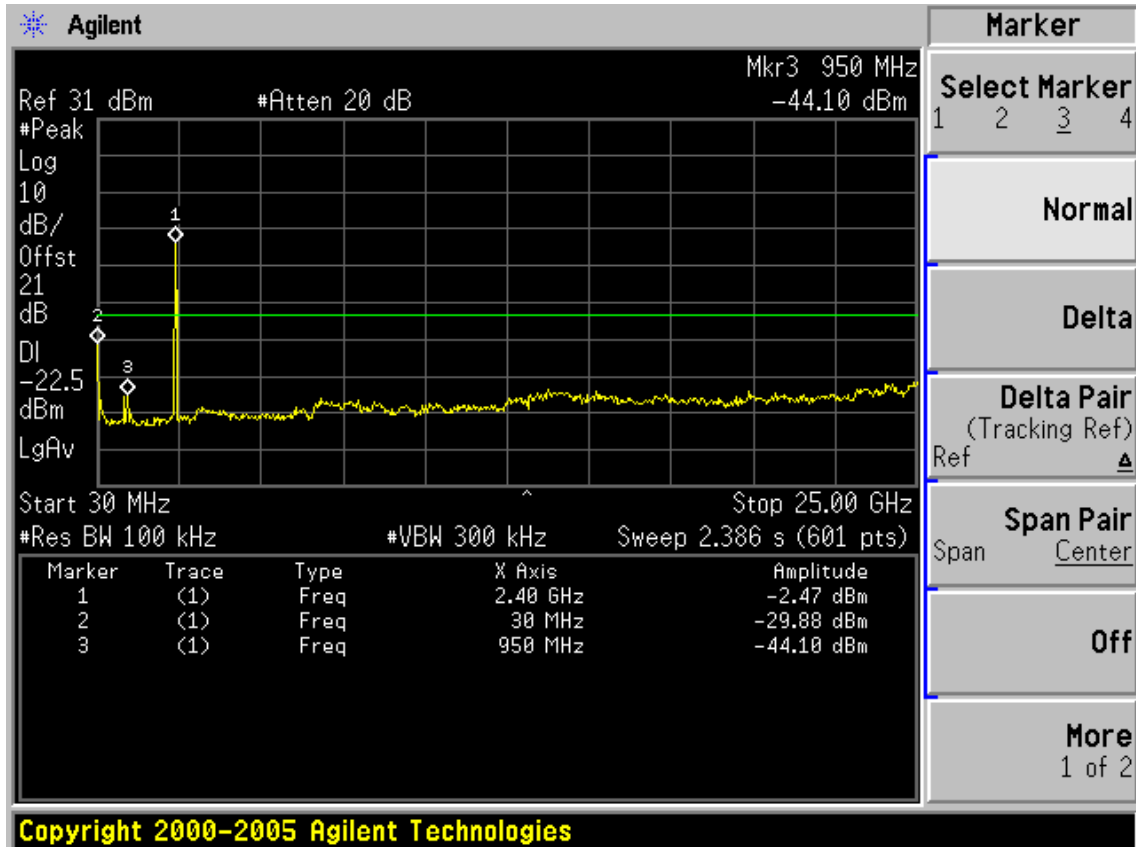

(CH6)

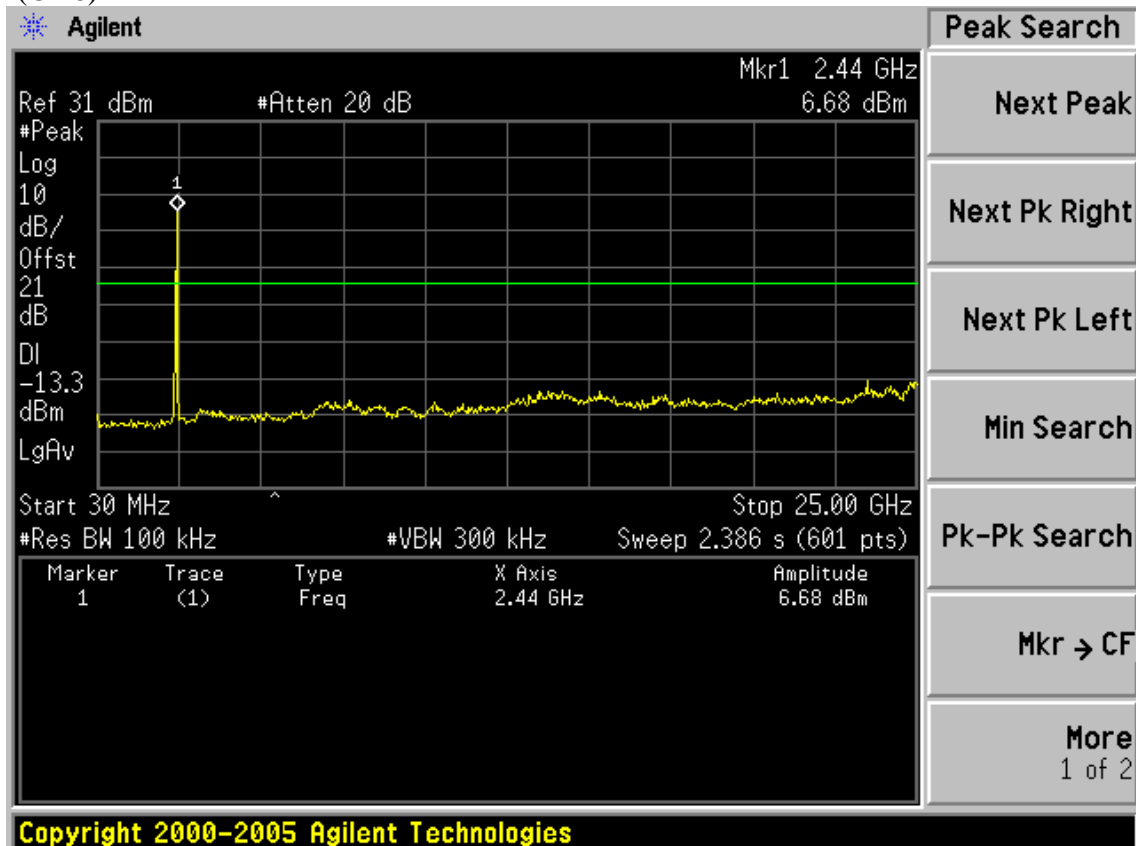

(CH11)

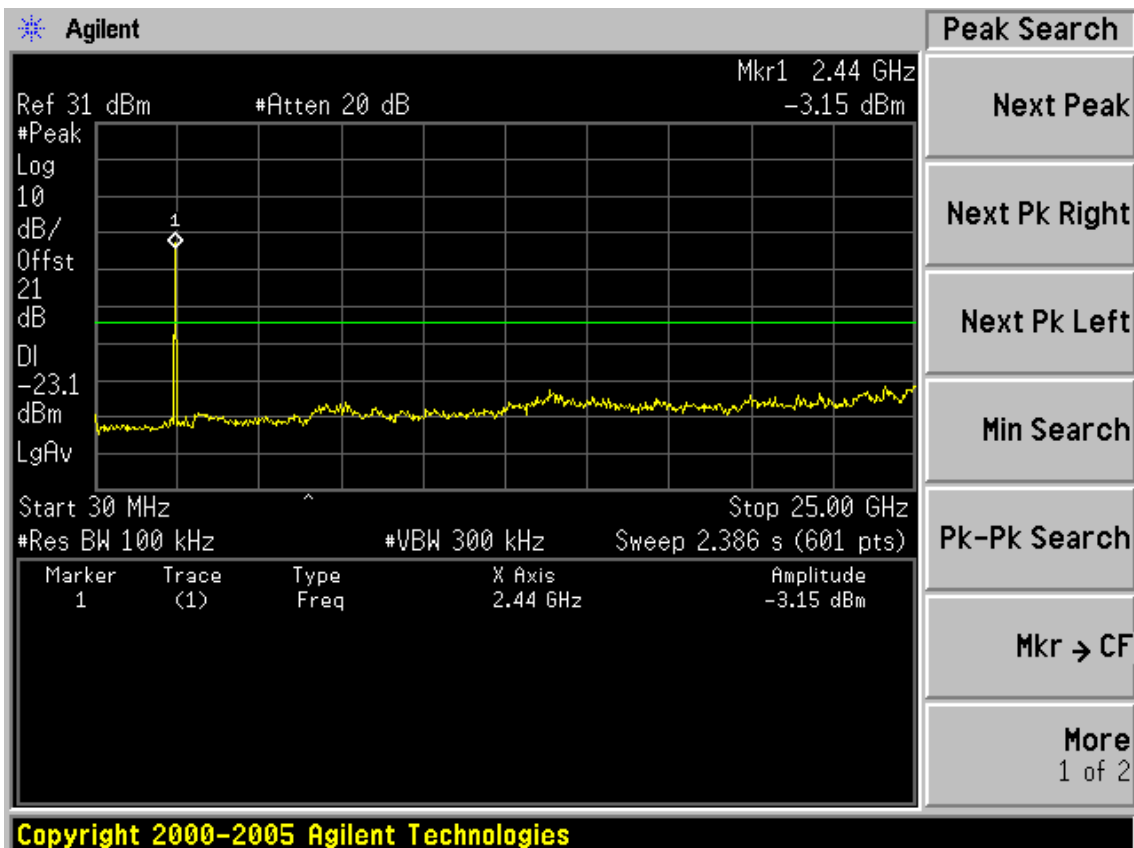
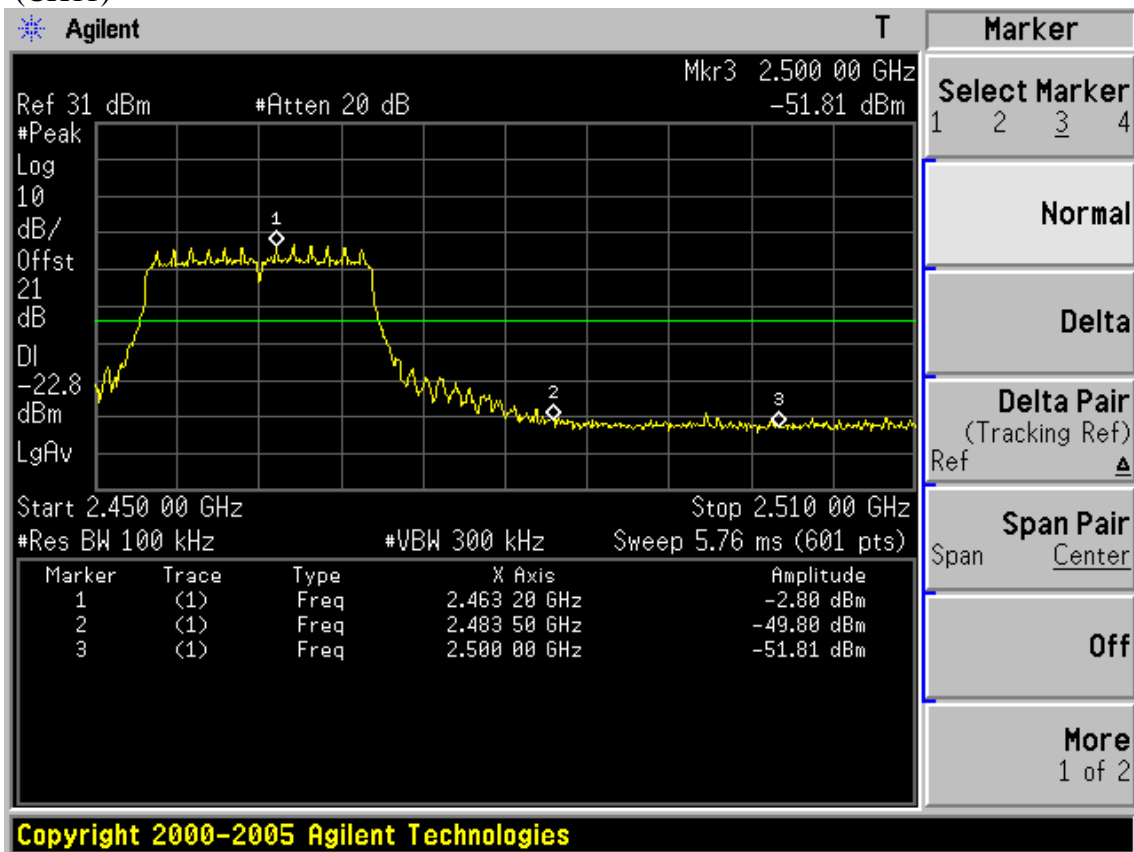

Test Mode: IEEE 802.11n HT20 TX (CH1)

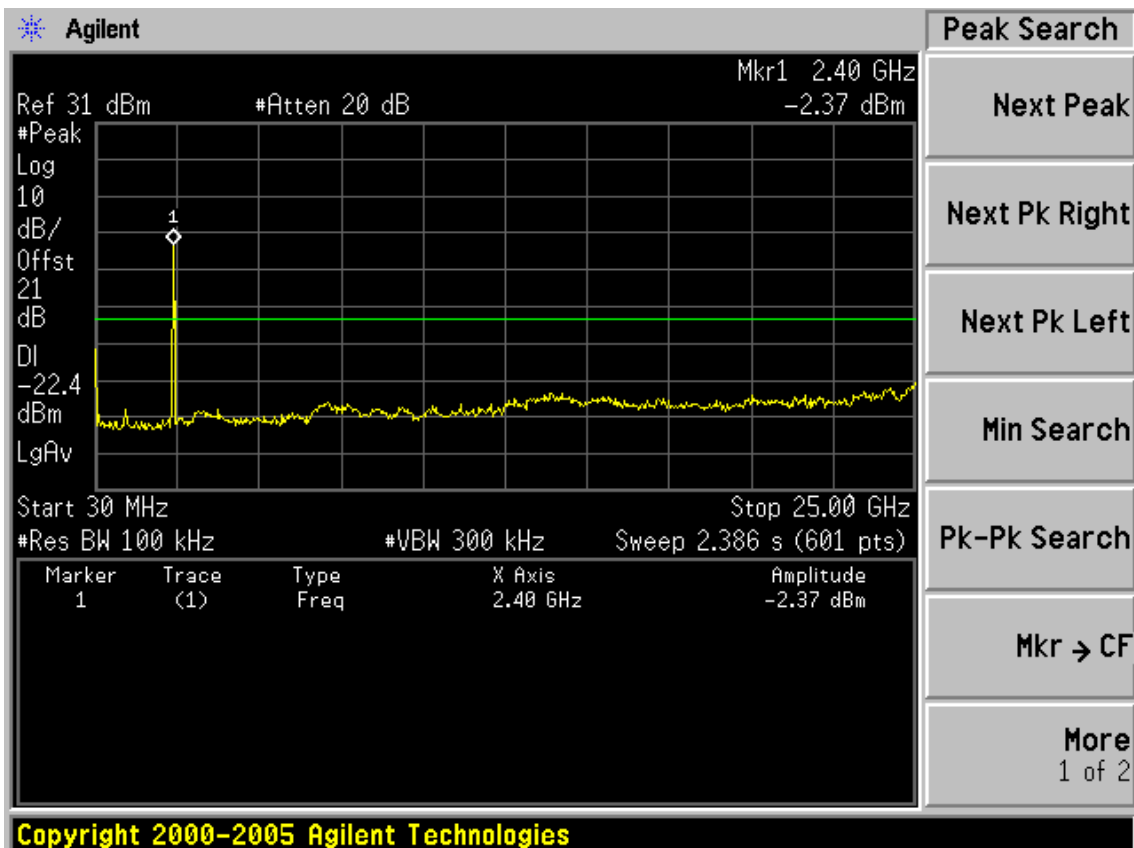
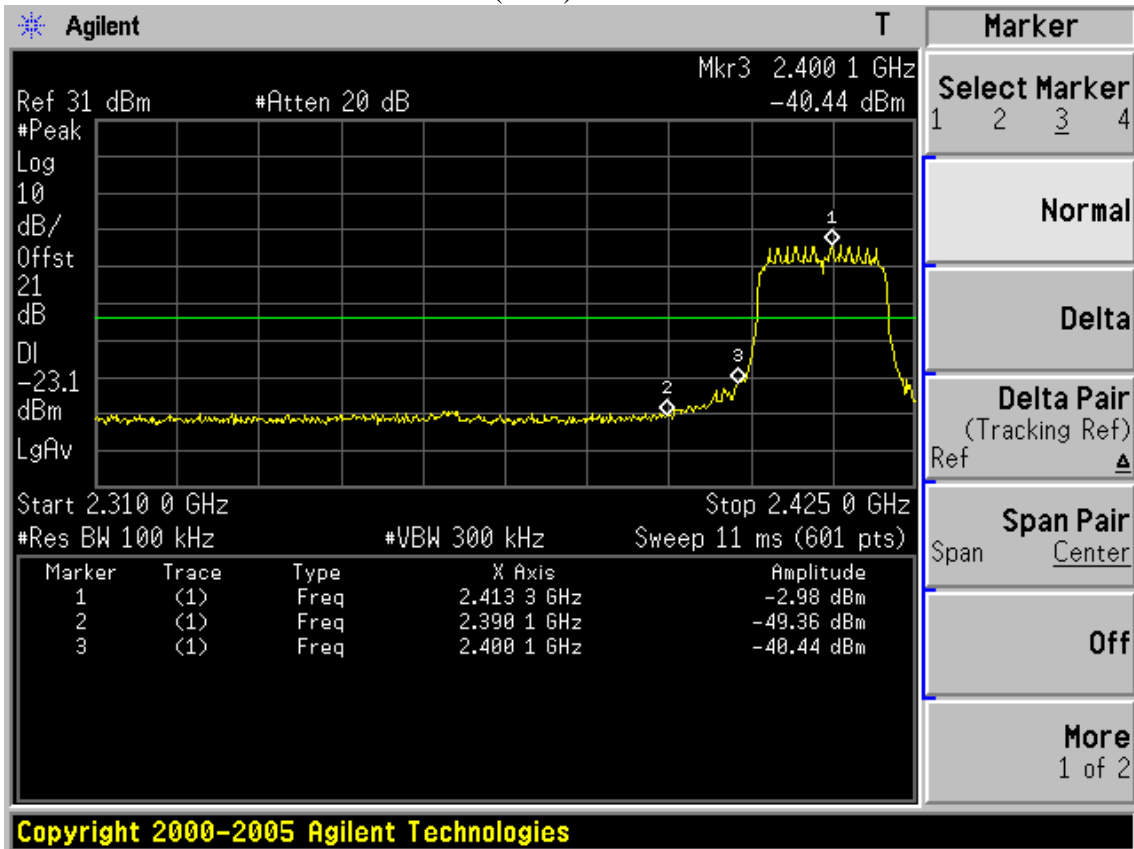

(CH6)

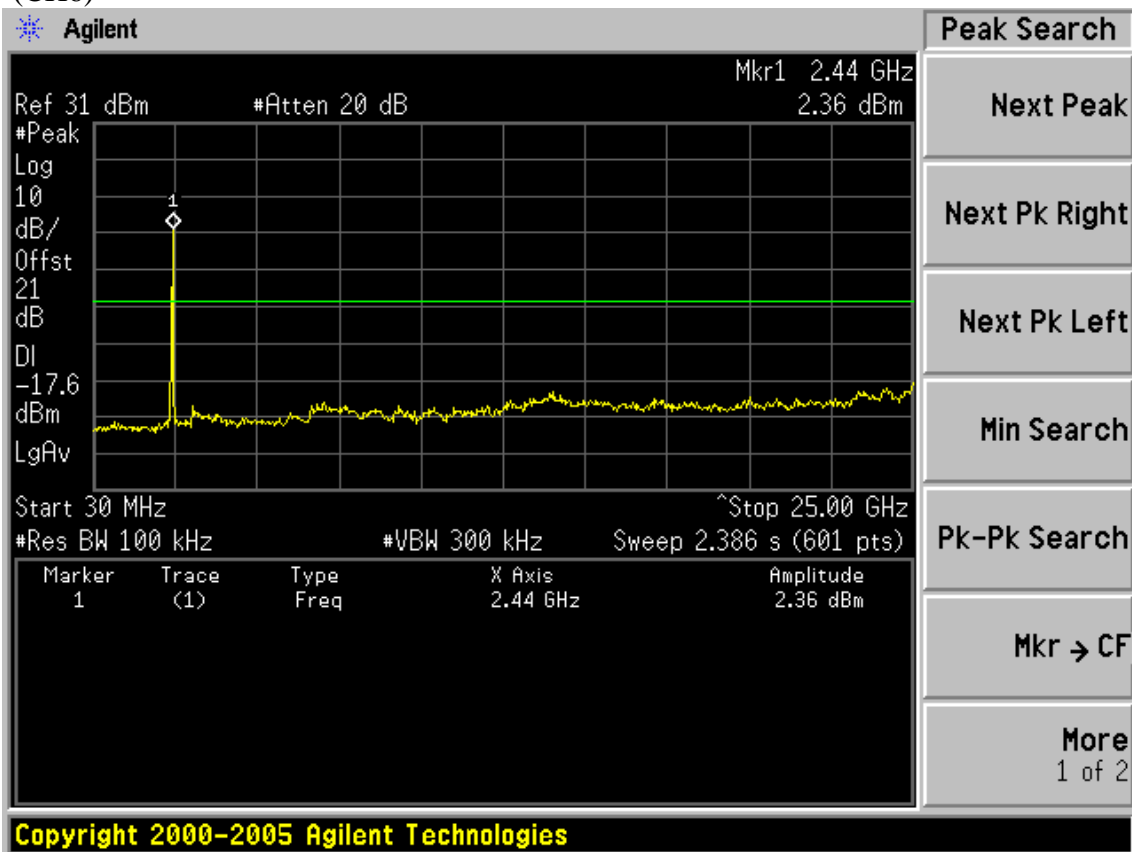

(CH11)

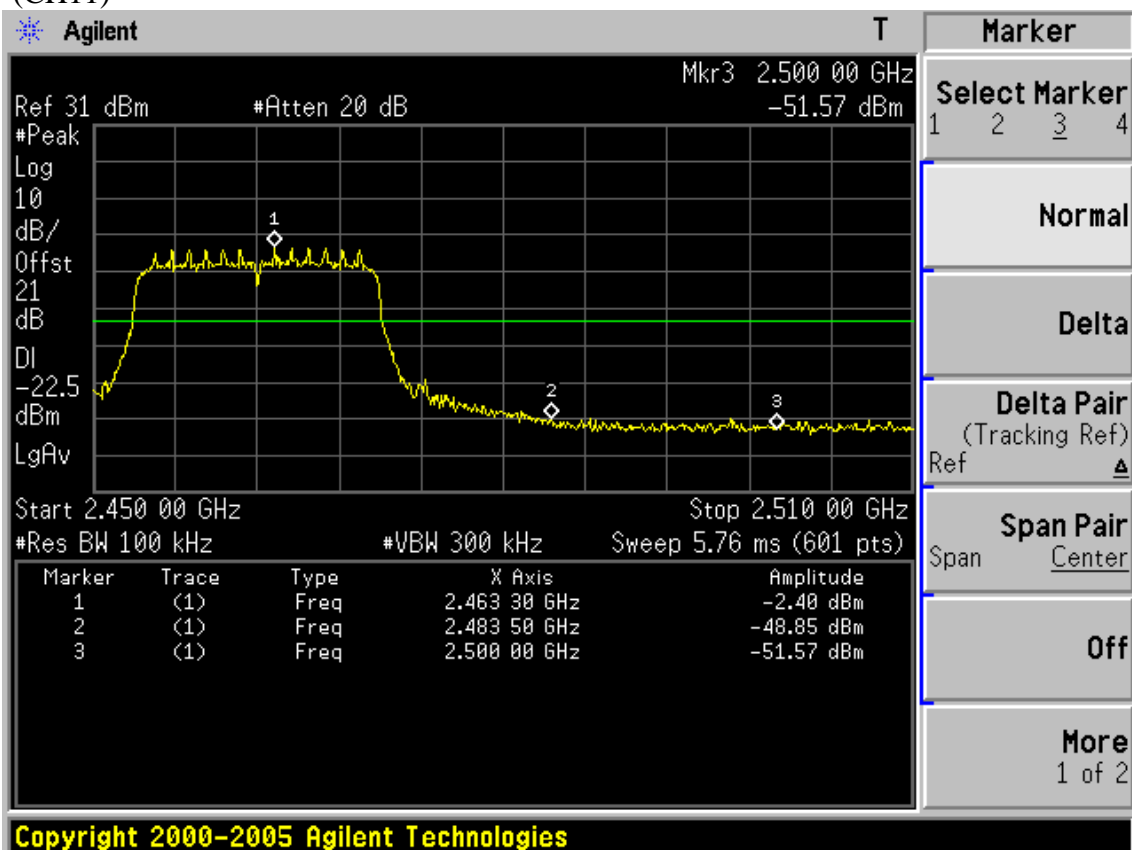

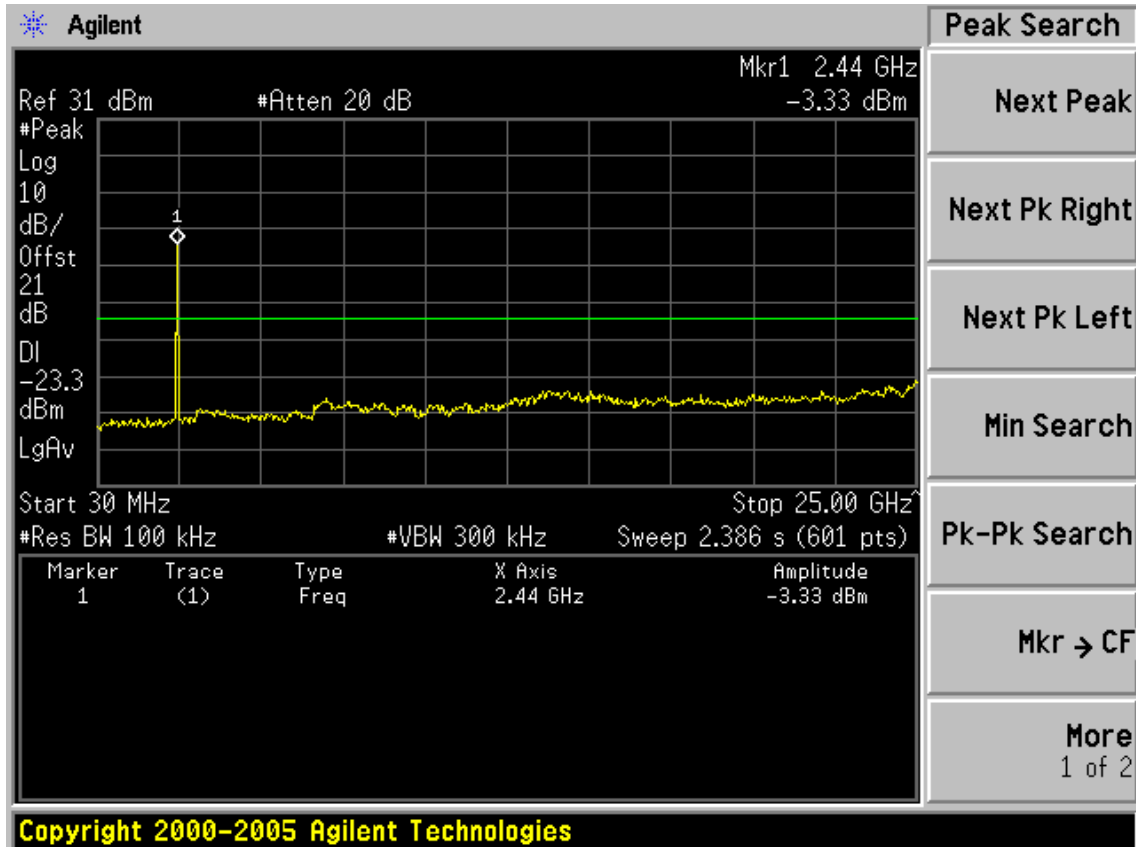

Test Mode: IEEE 802.11n HT40 TX (CH1)

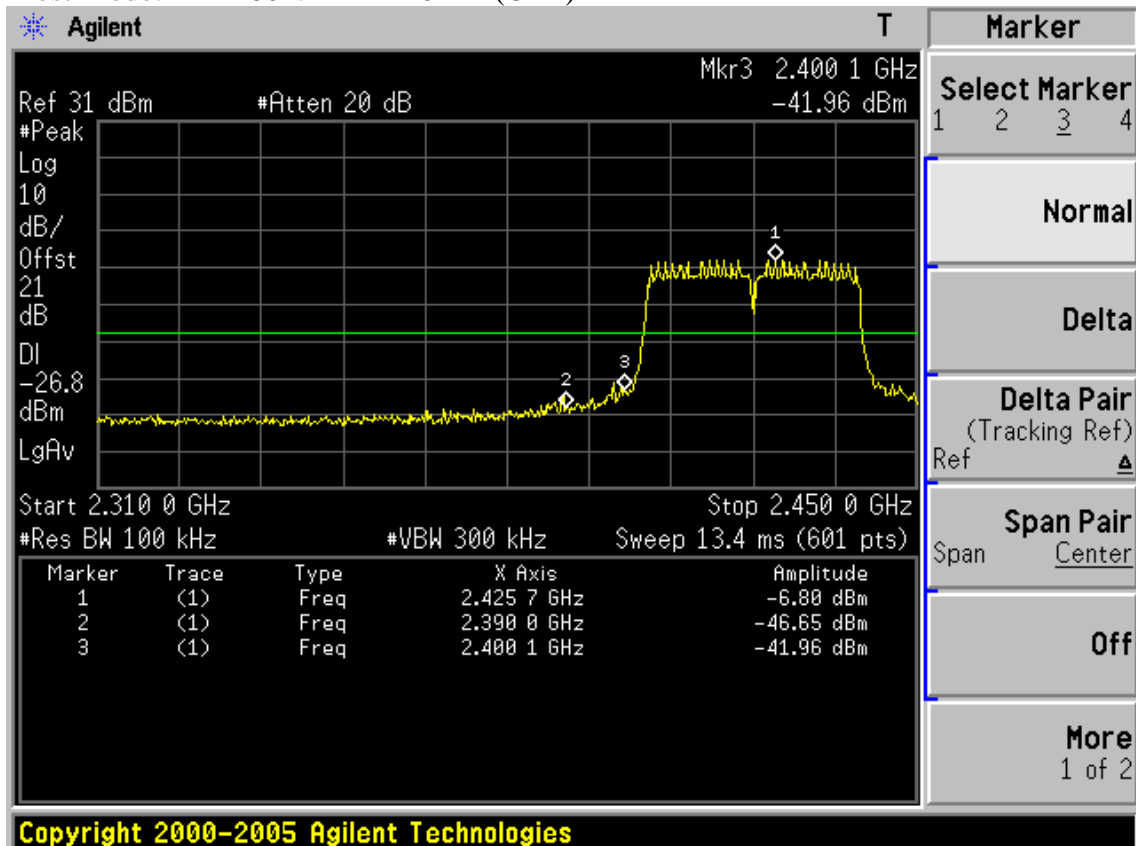

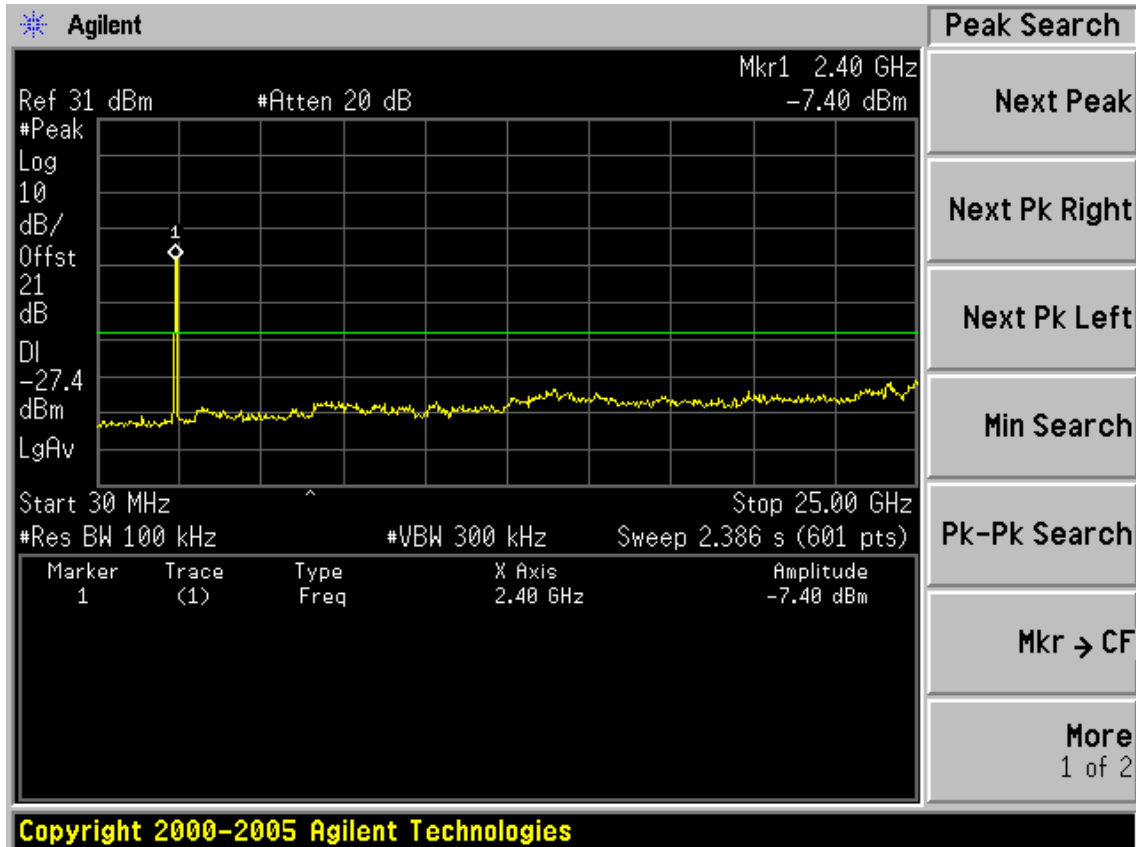

(CH4)

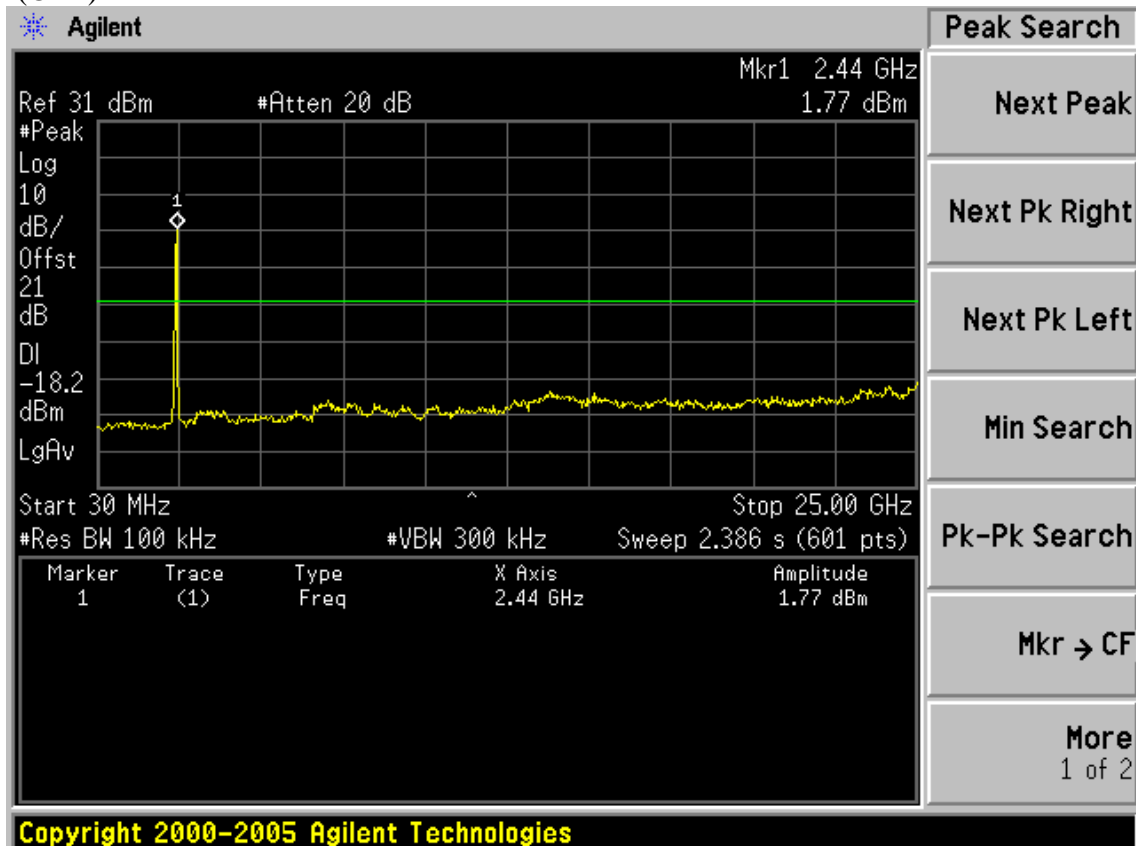

(CH7)

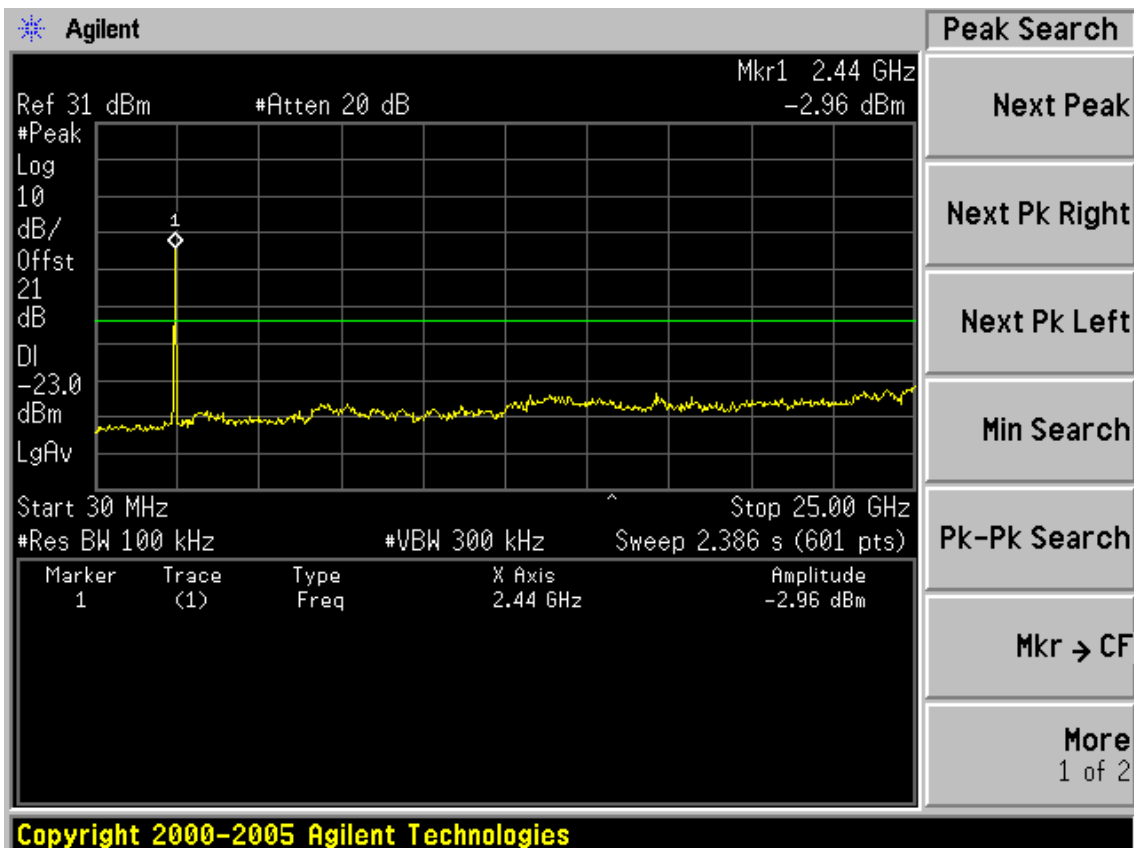
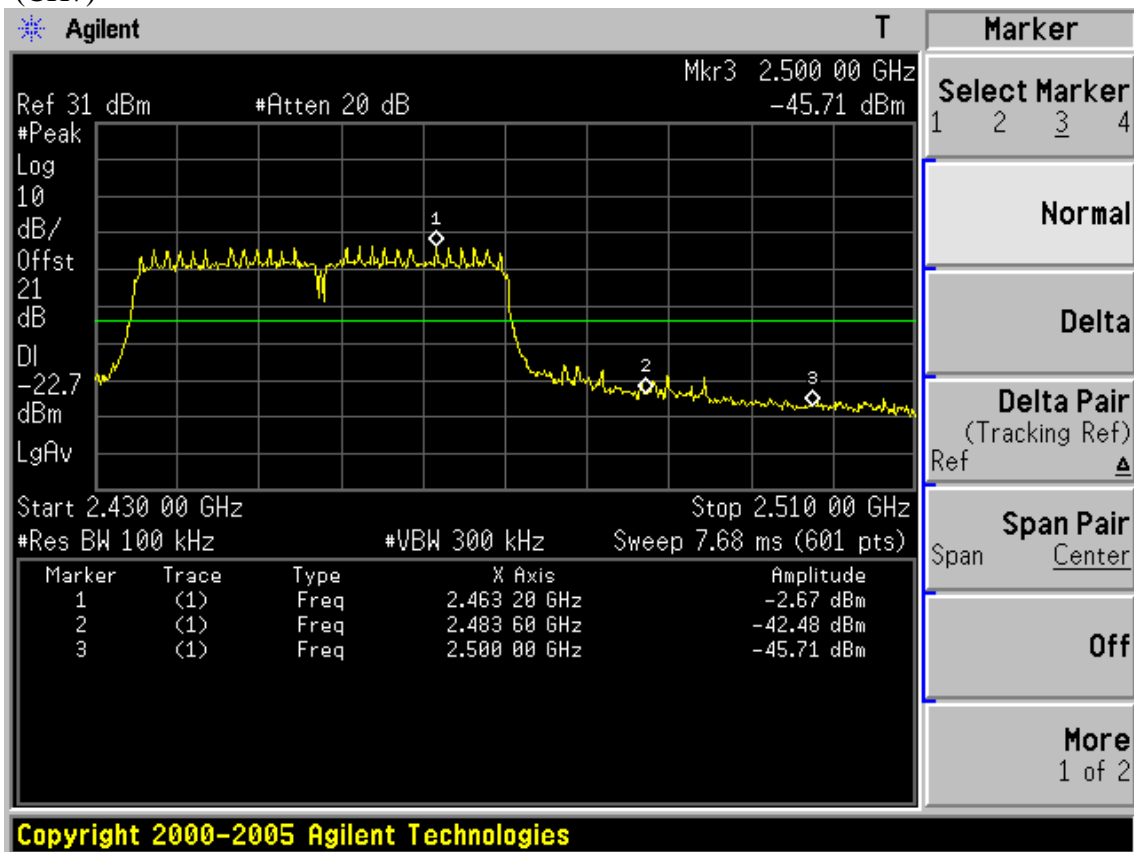

Chain 2:

Test Mode: IEEE 802.11b TX (CH1)

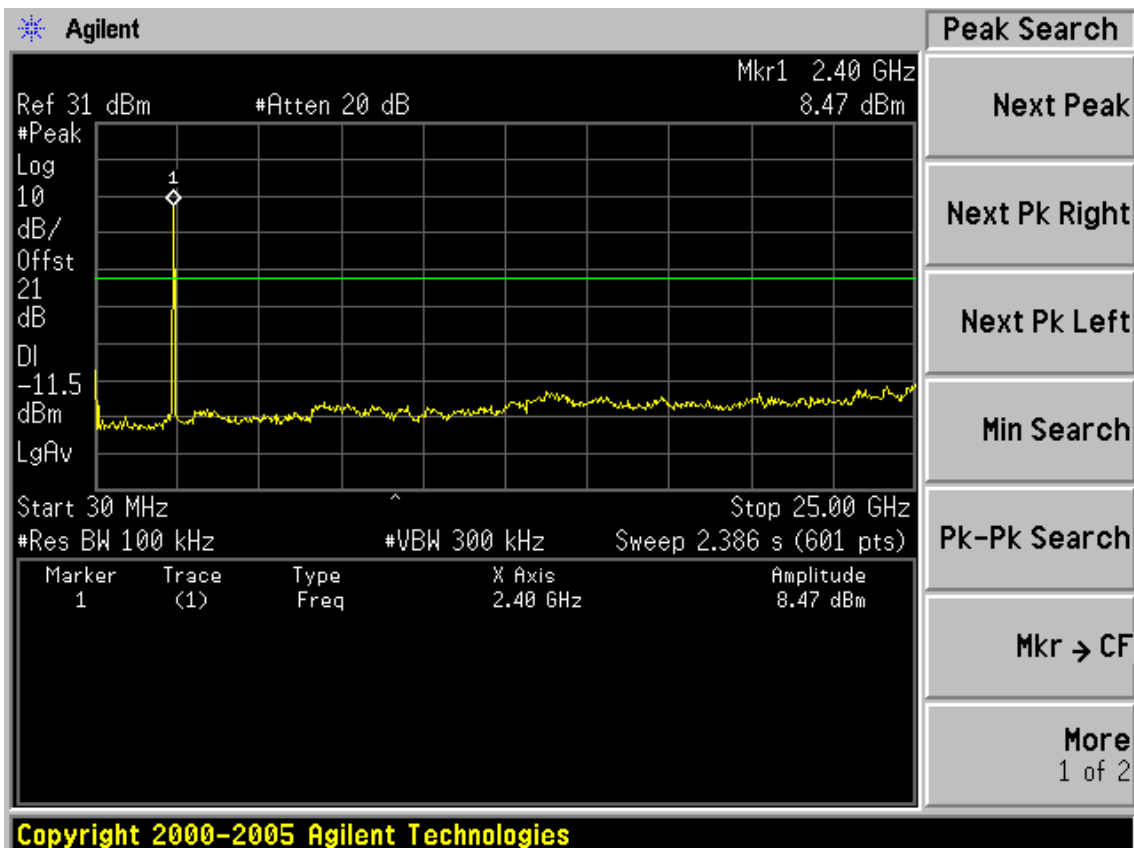
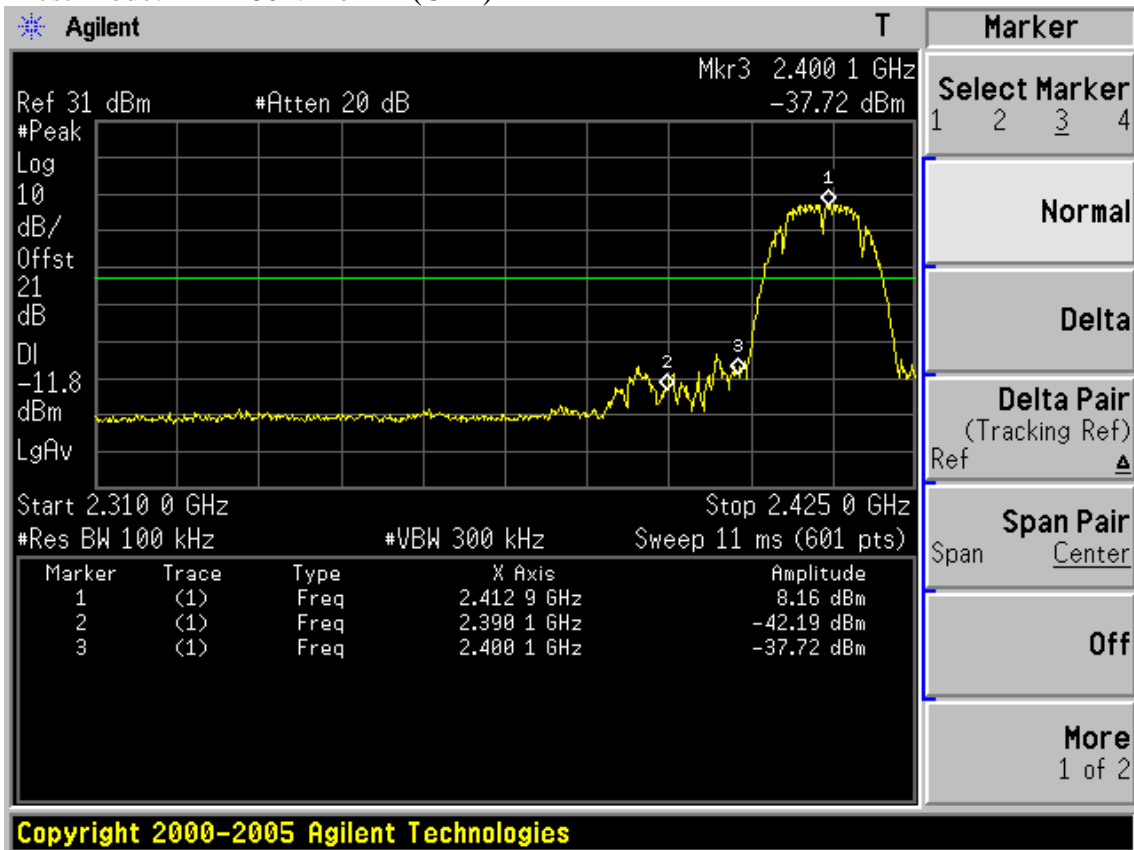

(CH6)

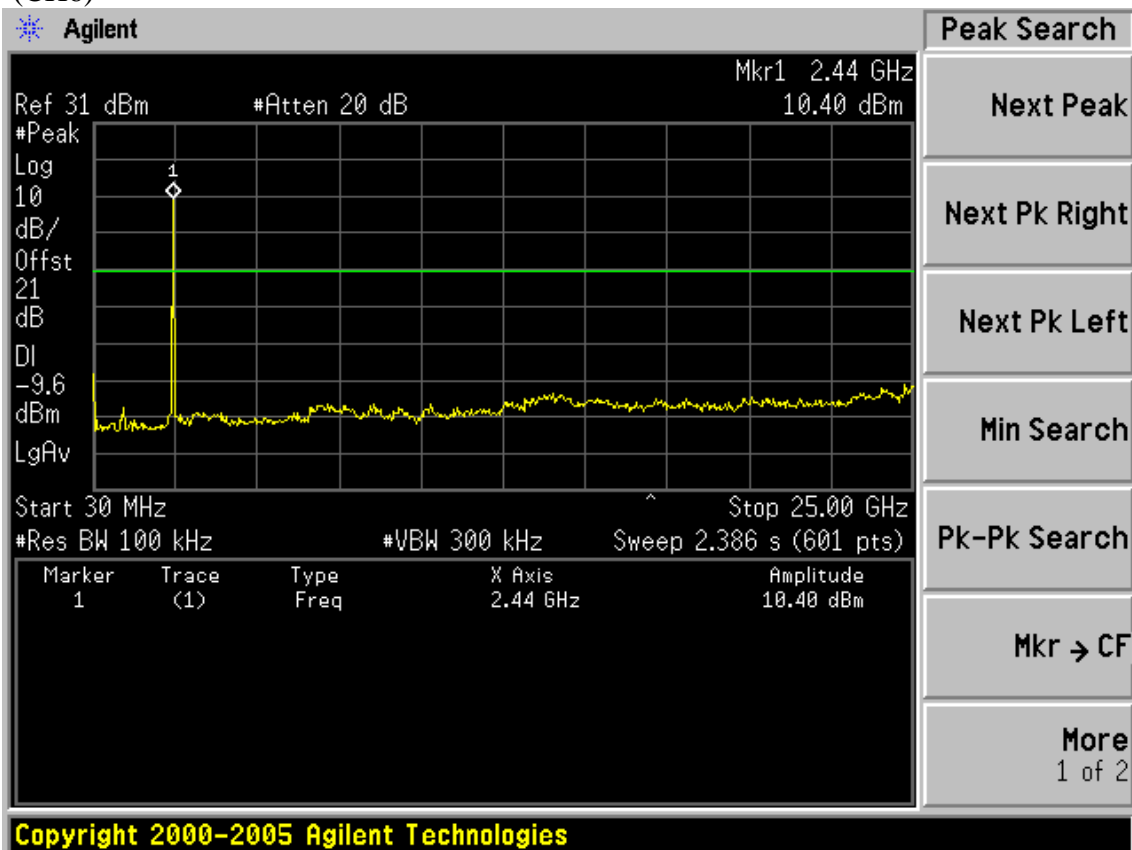

(CH11)

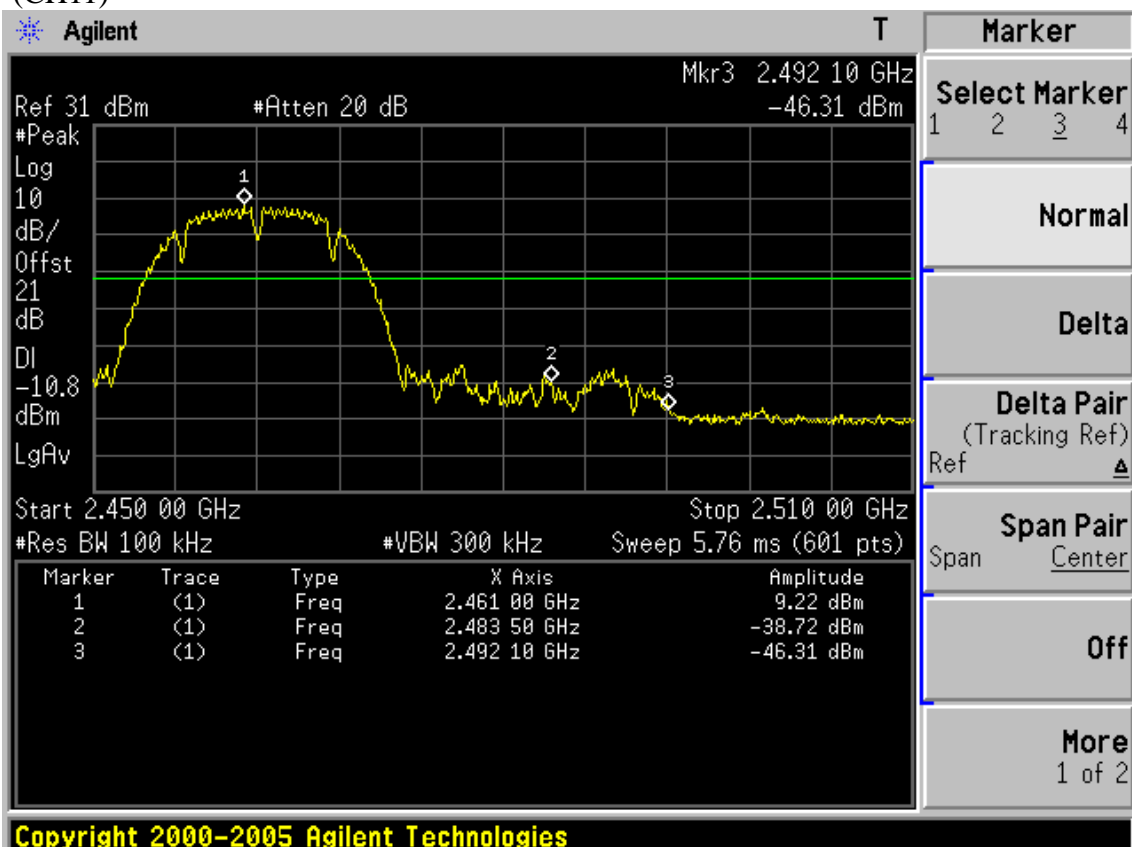

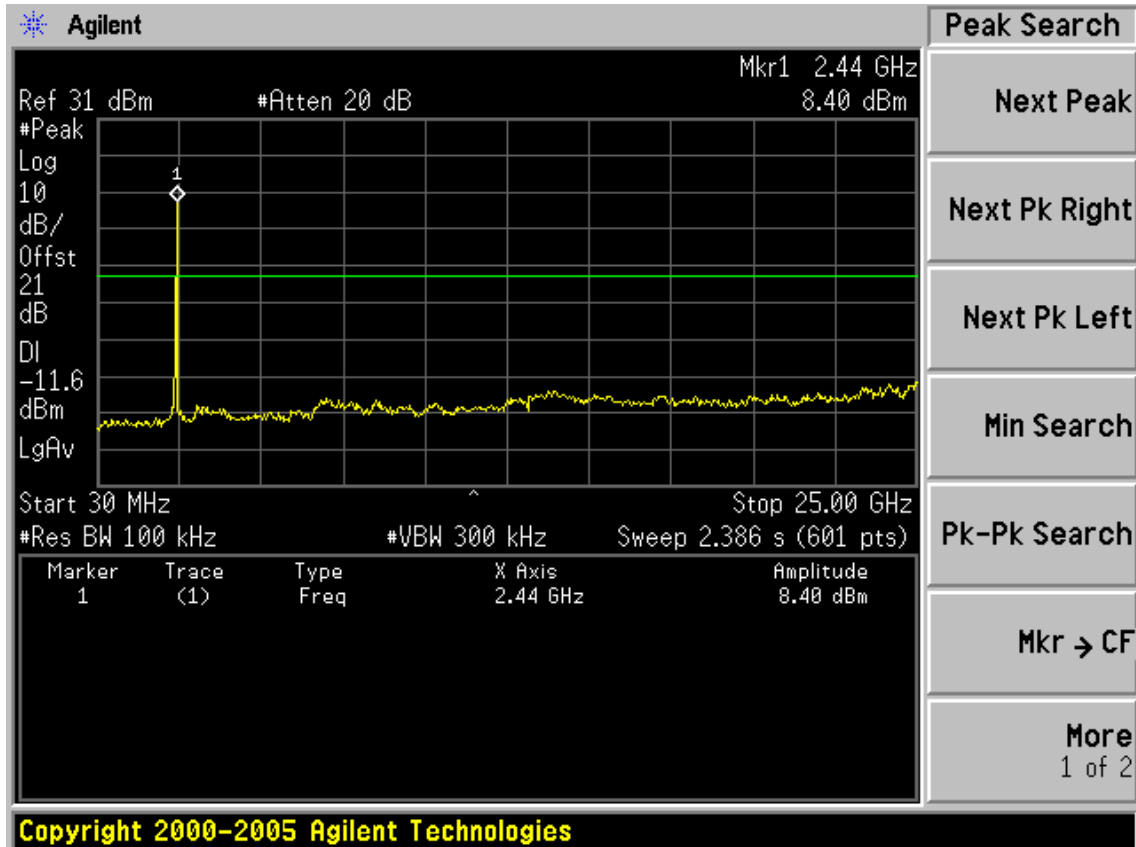

Test Mode: IEEE 802.11g TX (CH1)

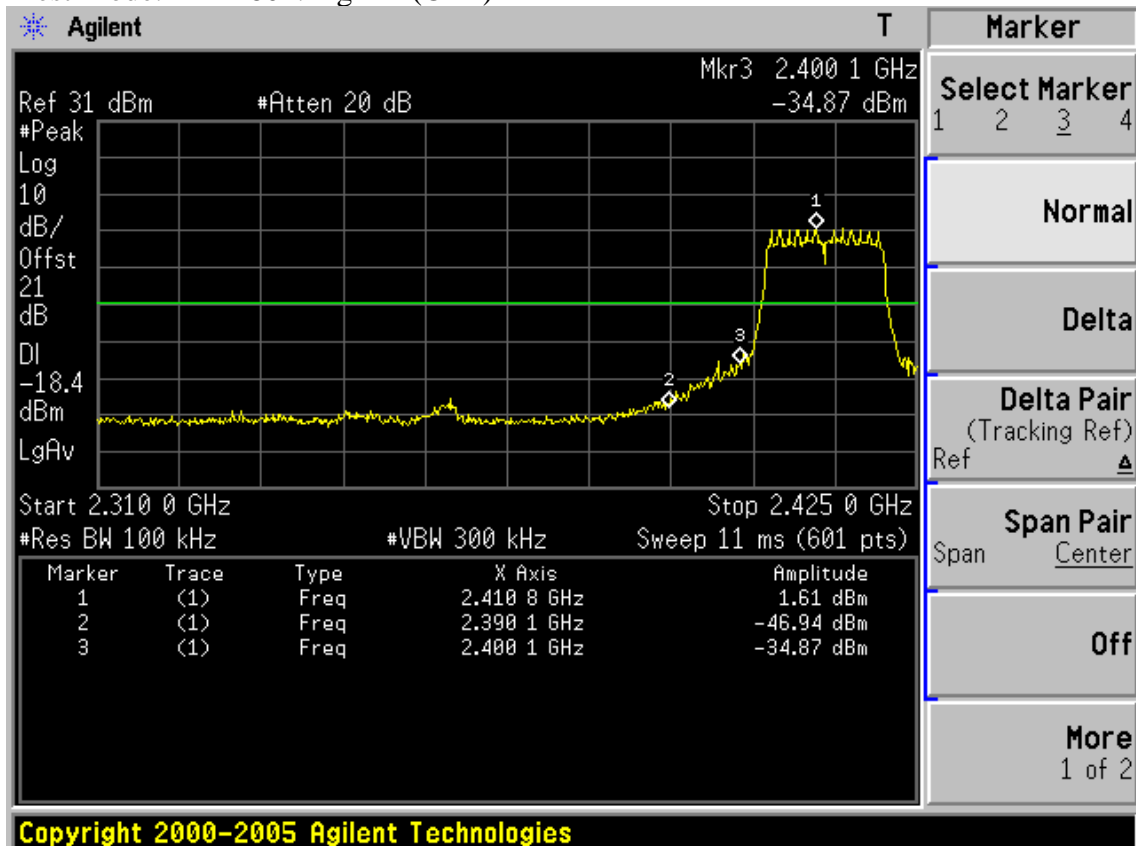

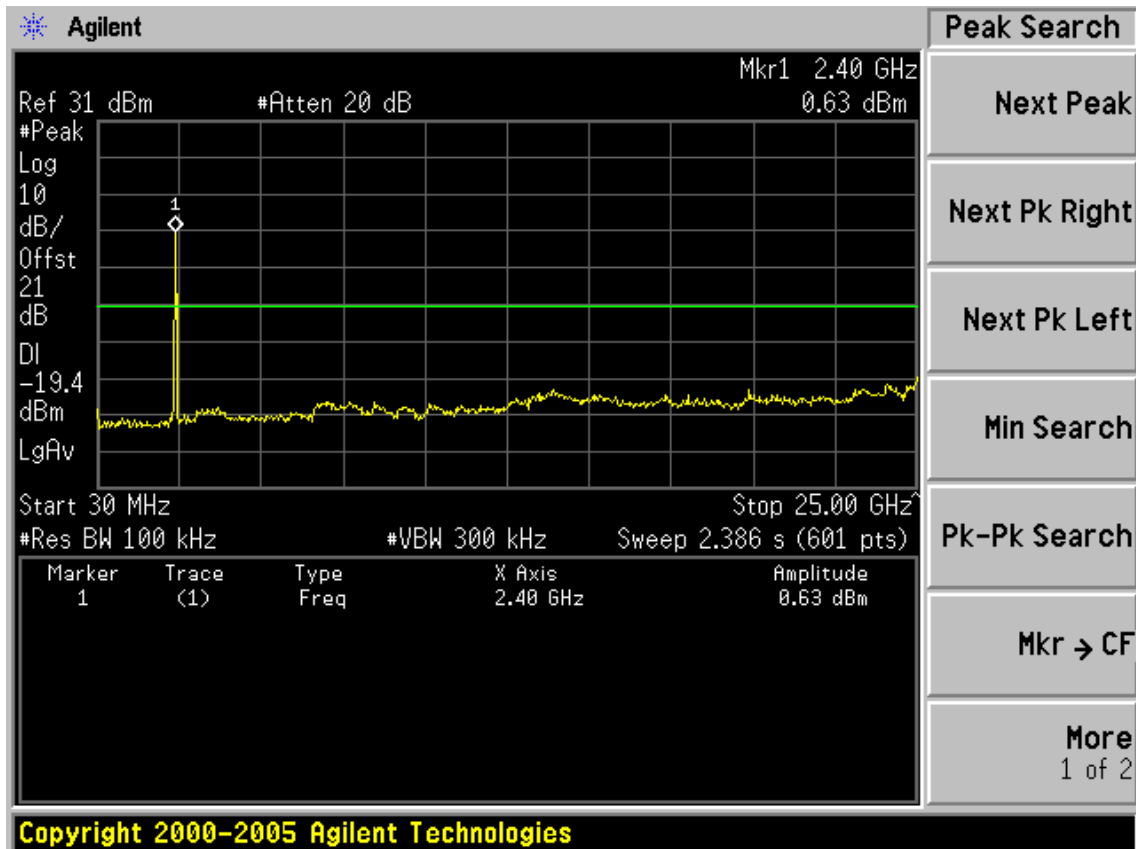

(CH6)

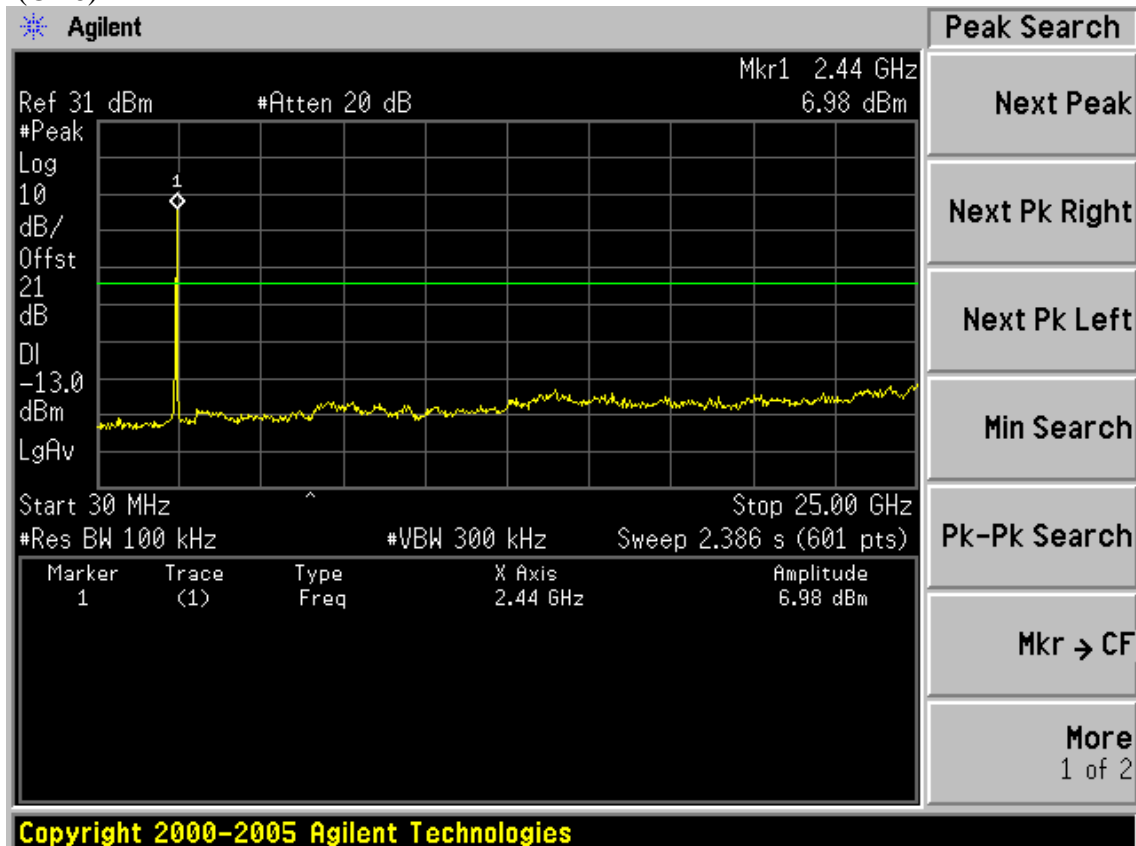

(CH11)

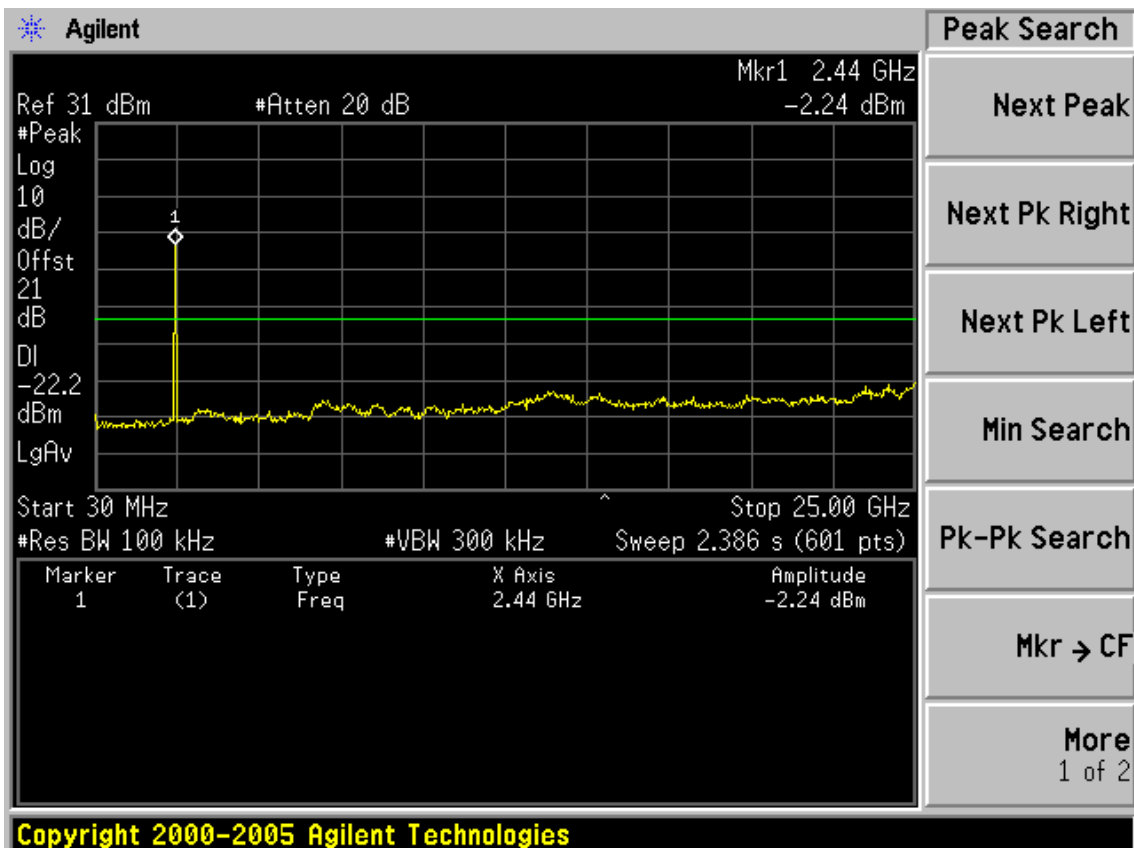
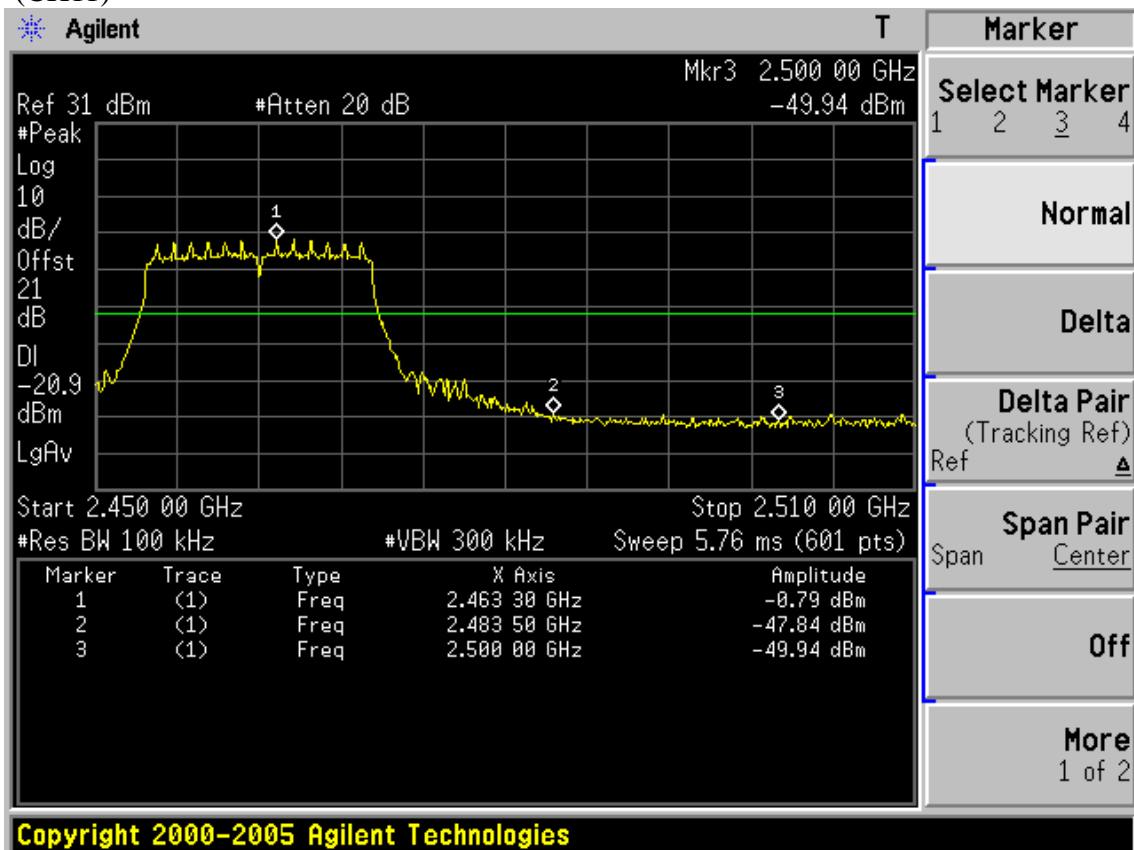

Test Mode: IEEE 802.11n HT20 TX (CH1)

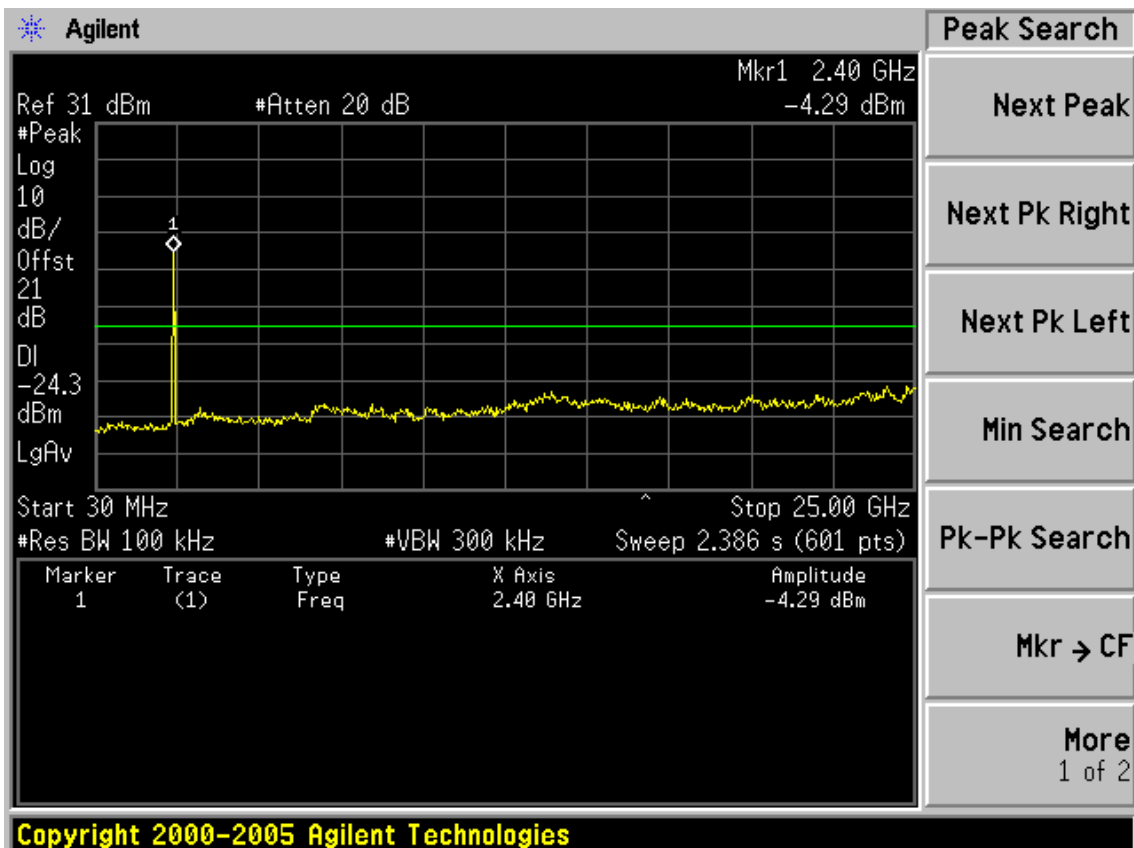
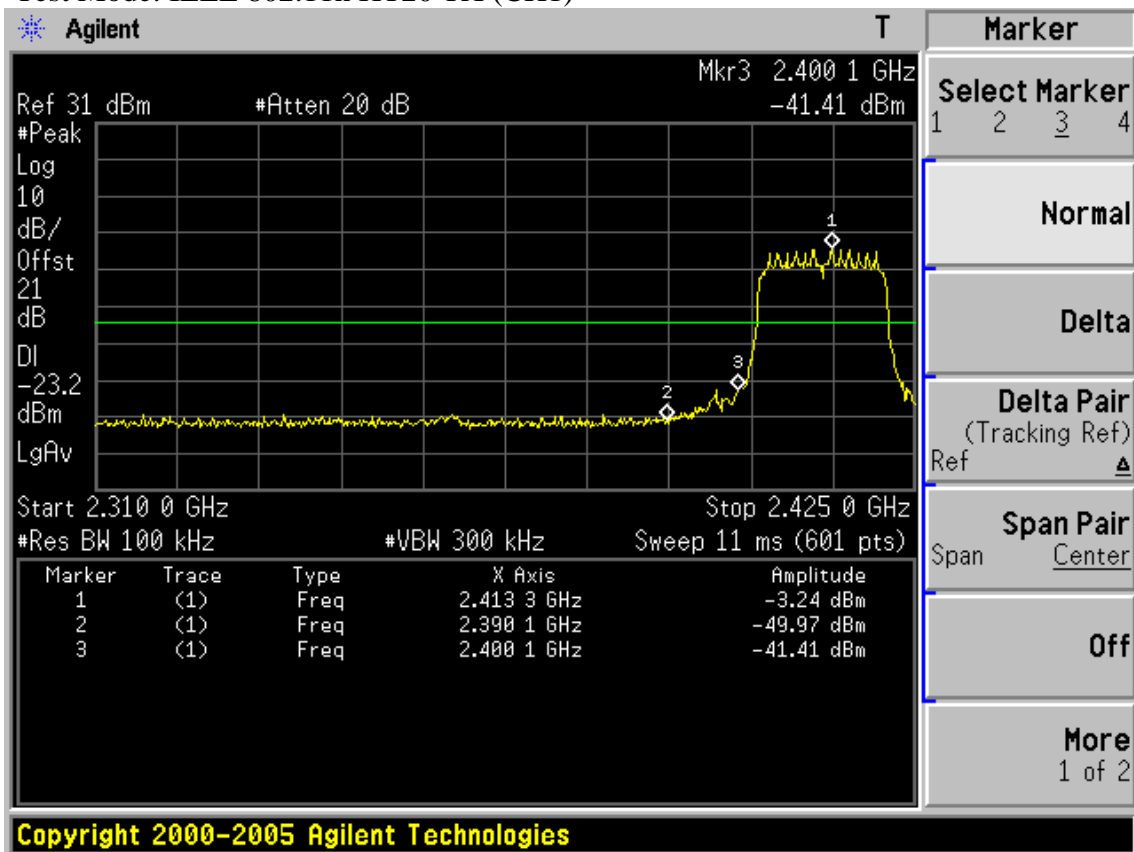

(CH6)

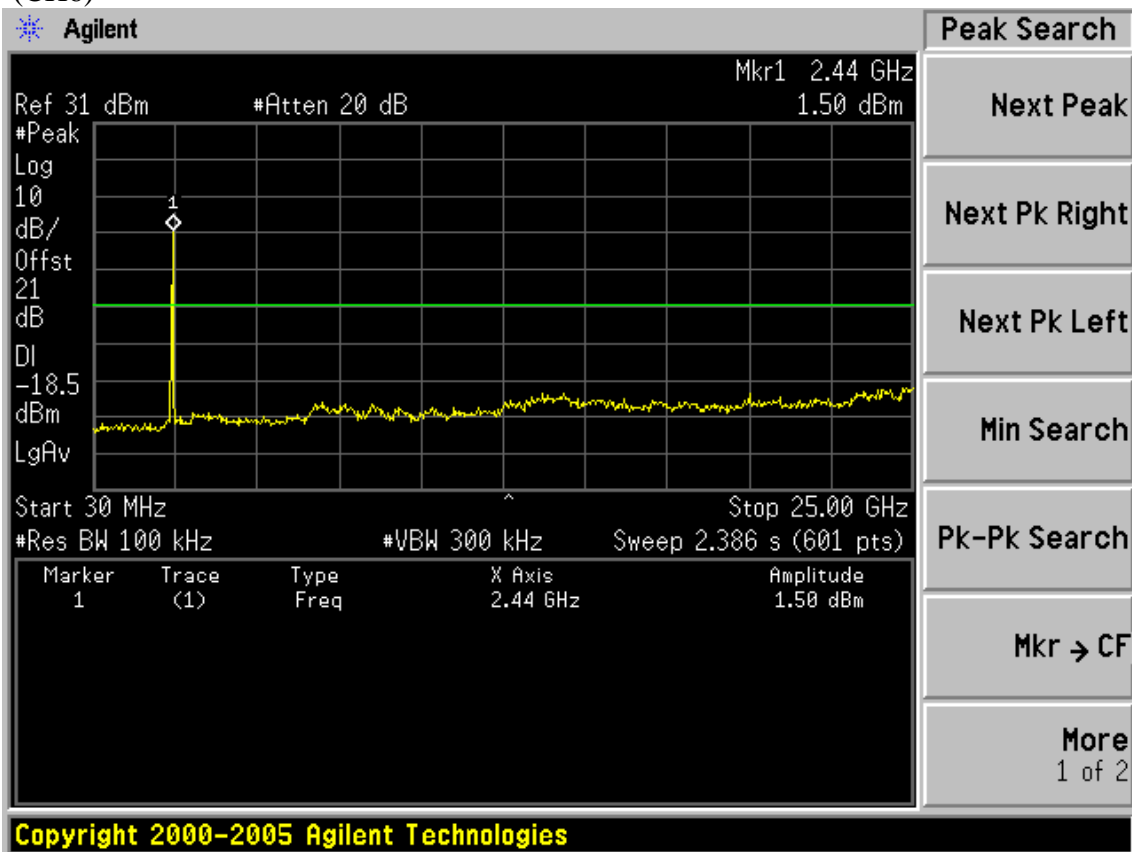

(CH11)

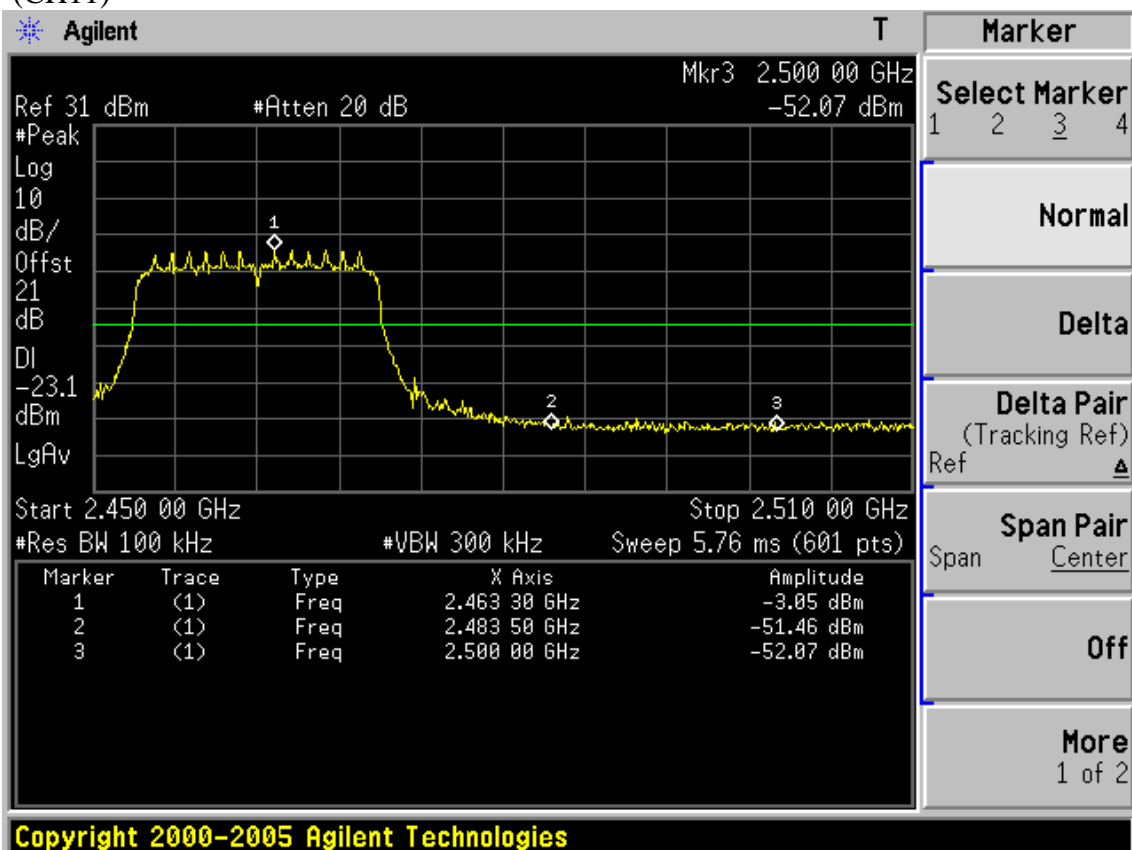

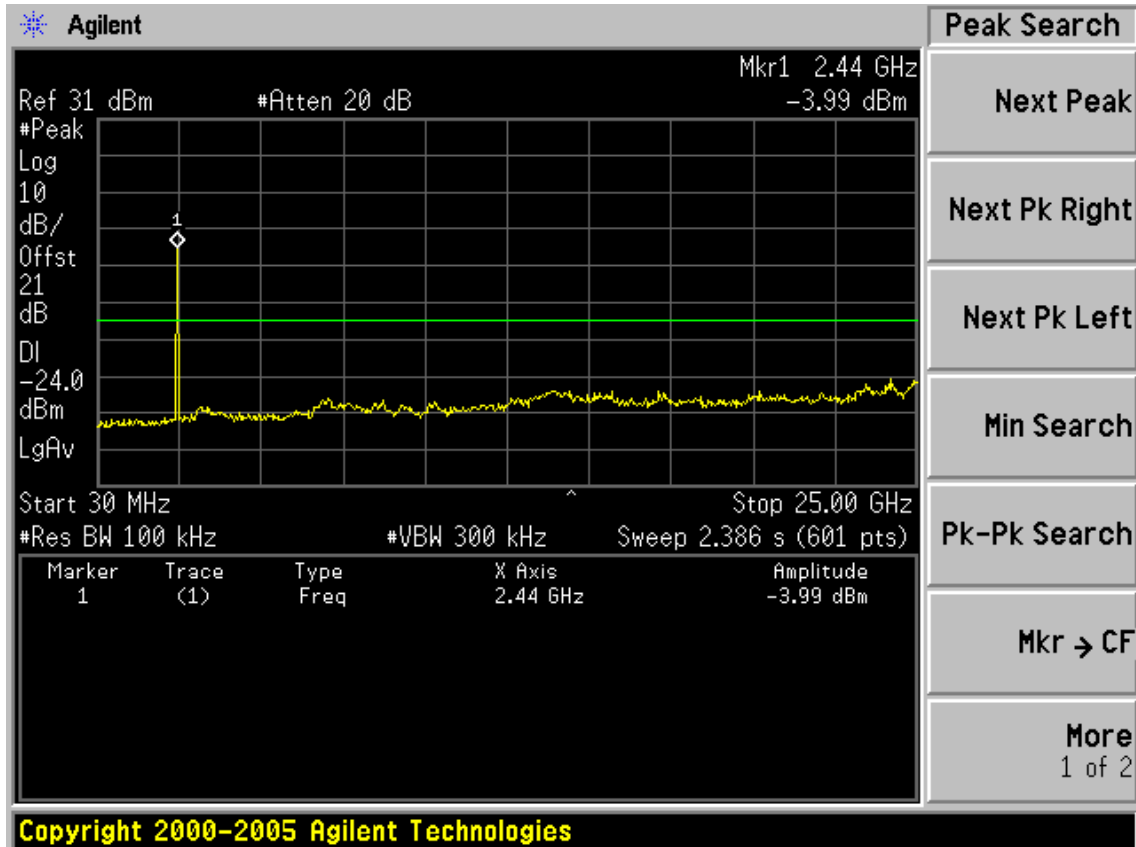

Test Mode: IEEE 802.11n HT40 TX (CH1)

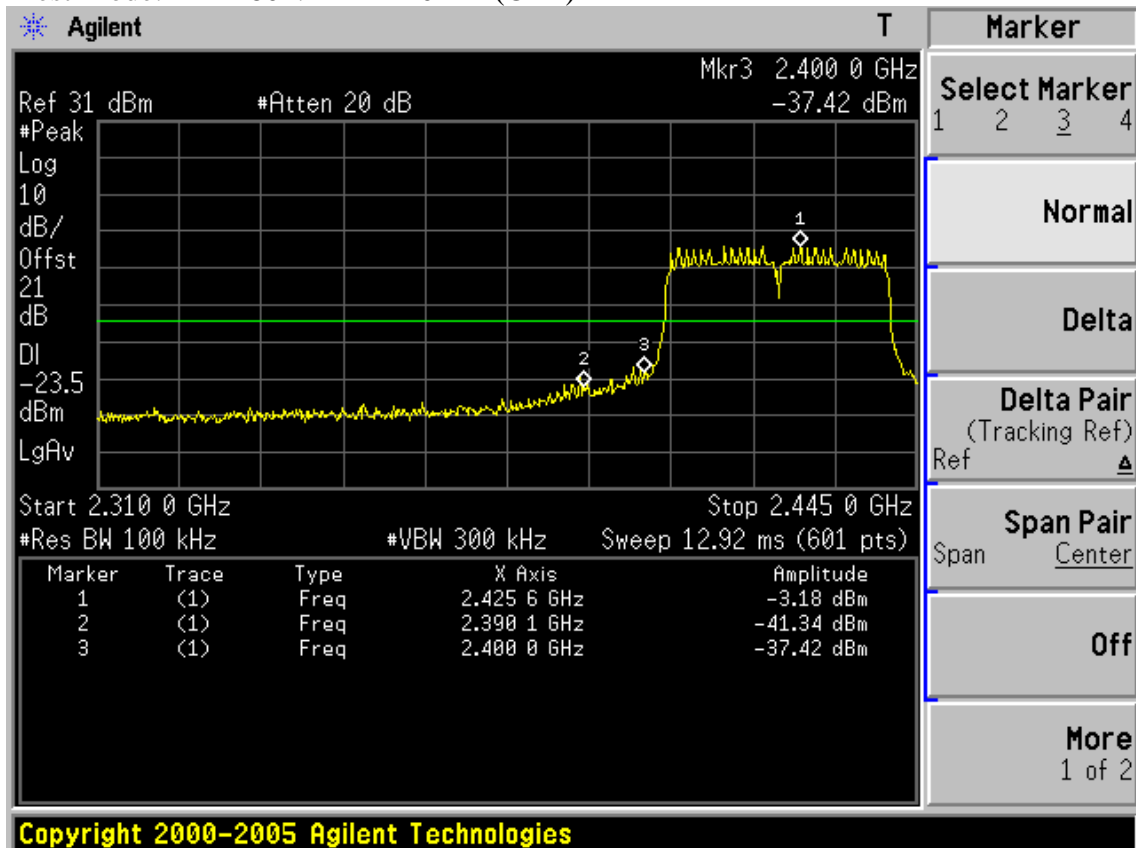

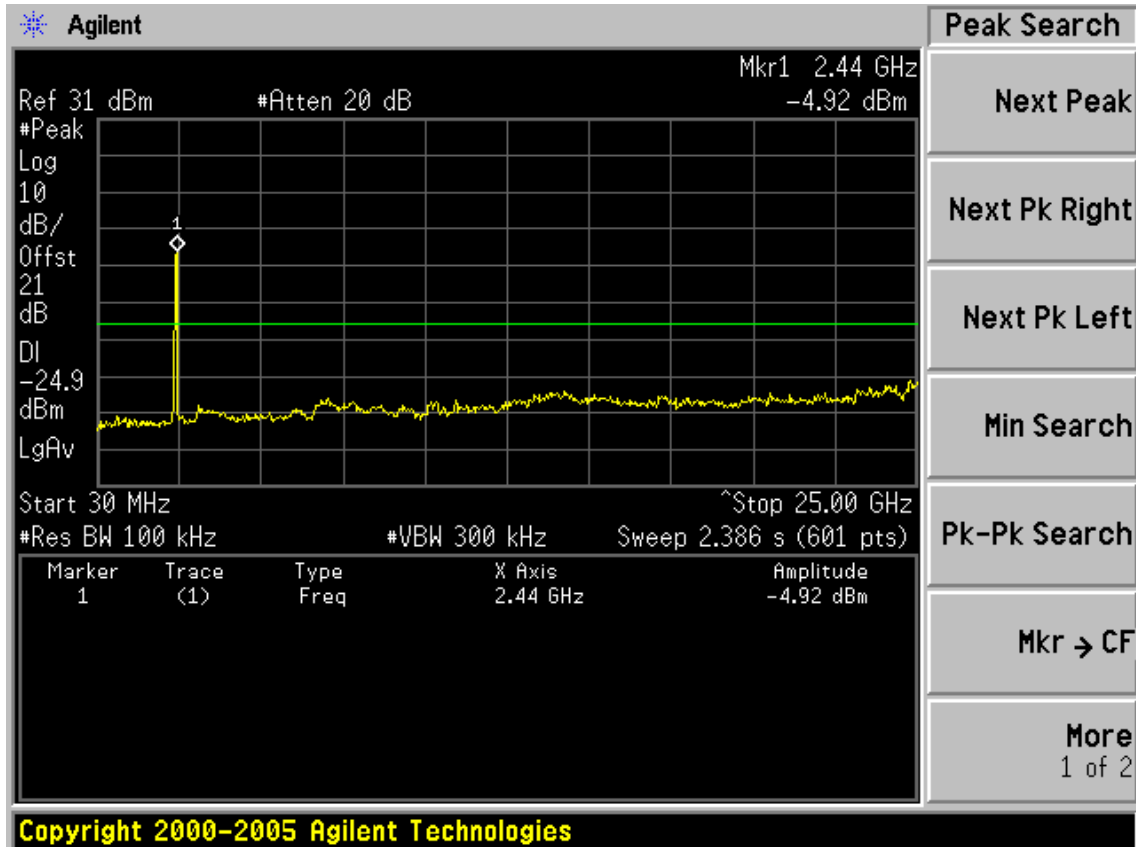

(CH4)

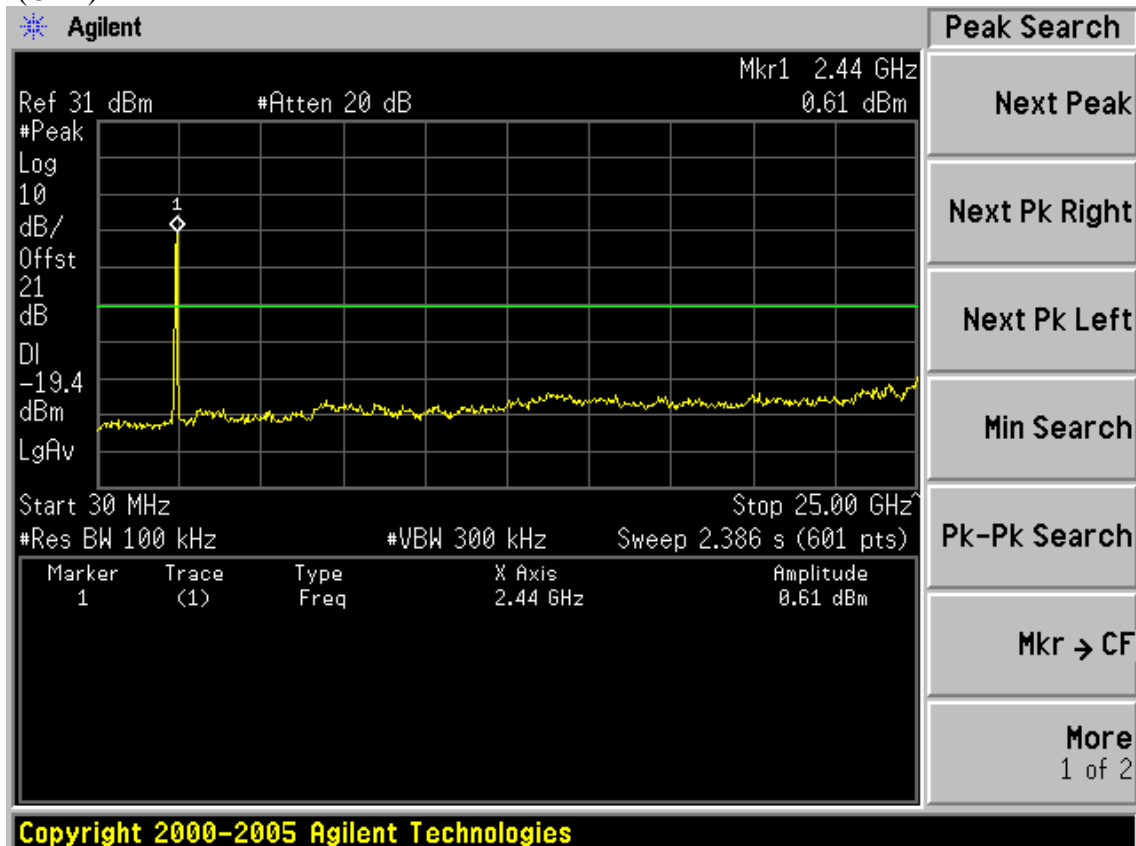

(CH7)

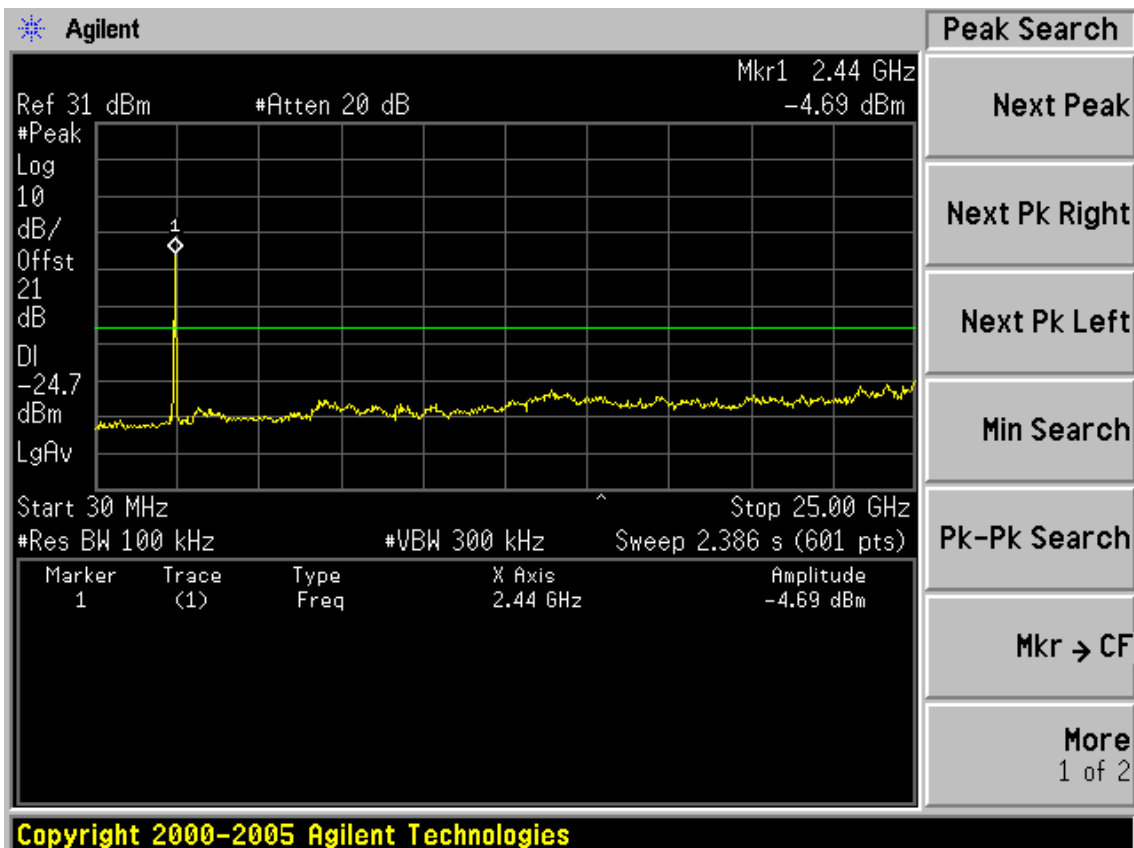
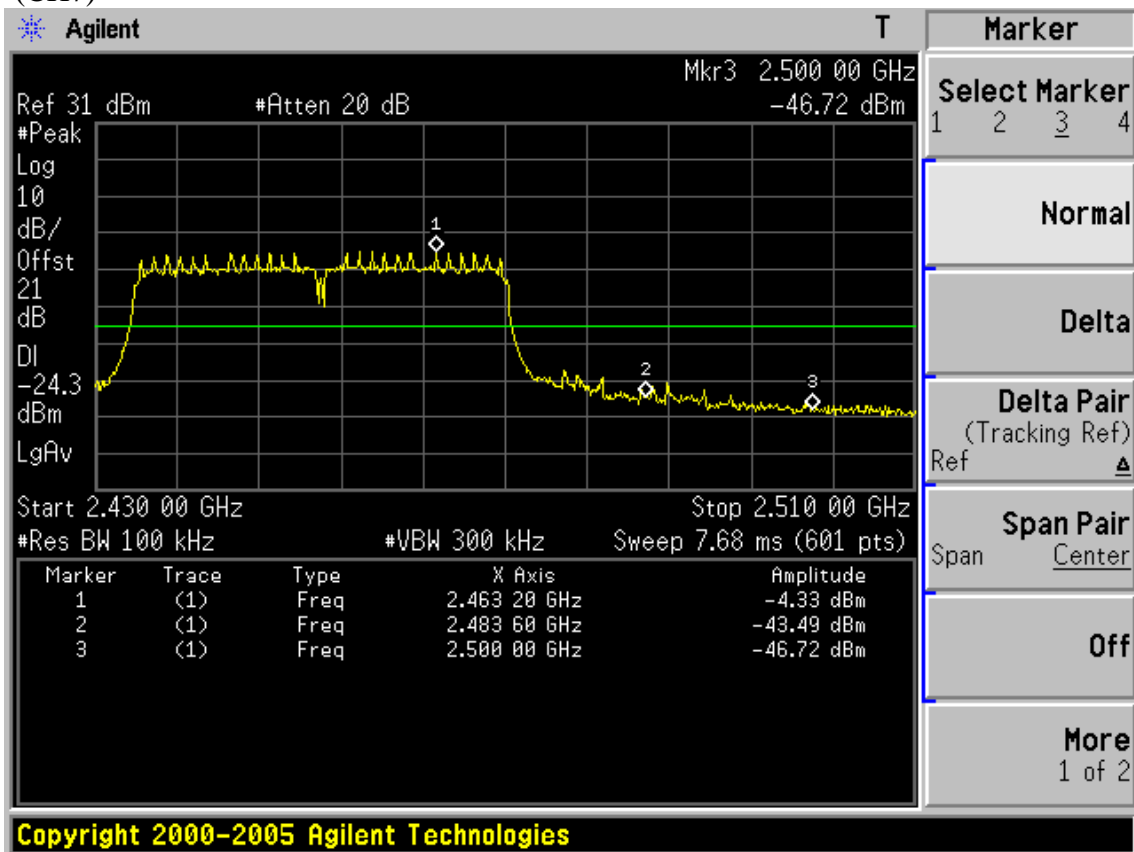

6. BAND EDGE COMPLIANCE TEST

6.1. Test Equipment

Item	Equipment	Manufacturer	Model No.	Serial No.	Last Cal.	Cal. Interval
1.	Spectrum Analyzer	Agilent	E4446A	US44300459	May.08, 09	1 Year
2.	Horn Antenna	EMCO	3115	9607-4877	Nov.25, 09	1.5 Year
3.	Amplifier	Agilent	8449B	3008A02495	May.08, 09	1 Year
4.	RF Cable	Hubersuhner	SUCOFLEX 102	28620/2	May.08, 09	1 Year
5.	RF Cable	Hubersuhner	SUCOFLEX 102	271471/4	May.08, 09	1 Year
6.	RF Cable	Hubersuhner	SUCOFLEX 102	29086/2	May.08, 09	1 Year

6.2. Limit

All the lower and upper band-edges emissions appearing within 2310MHz to 2390MHz and 2483.5MHz to 2500MHz restricted frequency bands shall not exceed the limits shown in 15.209, all the other emissions outside operation frequency band 2400MHz to 2483.5MHz shall be at least 20dB below the fundamental emissions, or comply with 15.209 limits.

6.3. Test Produce

1. The EUT is placed on a turntable, which is 0.8m above the ground plane and worked at highest radiated power.
2. The turntable was rotated for 360 degrees to determine the position of maximum emission level.
3. EUT is set 3m away from the receiving antenna, which is varied from 1m to 4m to find out the highest emission.
4. Set the spectrum analyzer in the following setting in order to capture the lower and upperband-edges of the emission:
 - (a) PEAK: RBW=1MHz; VBW=3MHz ;Sweep=AUTO
 - (b) AVERAGE: RBW=1MHz ;VBW=10Hz ; Sweep=AUTO

6.4. Test Results

Pass (The testing data was attached in the next pages.)



No.6 Ke Feng Road,Block 52,
ShenZhen Science & Industry Park
Noutou,ShenZhen,GuangDong,China
Tel:+86-755-26639495-7
Fax:+86-755-26632877
Postcode:518057

Data: 3 File: E:\2010 report data\C\contel\ACS10Q0594R2.EM6 (108)

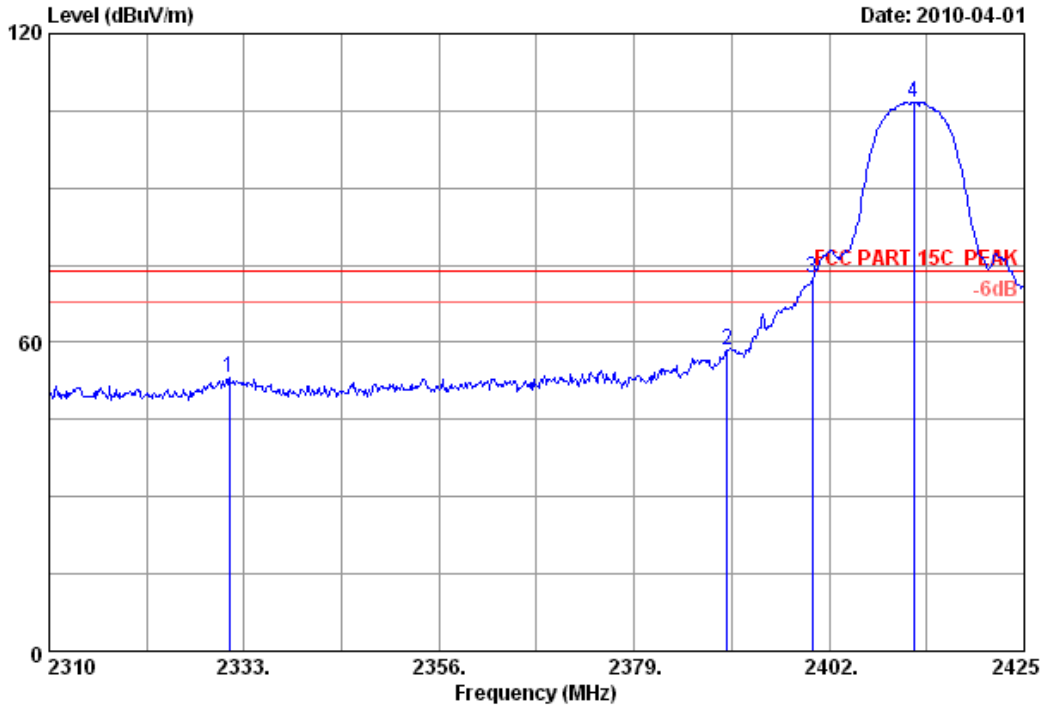

Site no. : 3m Chamber Data no. : 3
 Dis. / Ant. : 3m 3115(0911) Ant. pol. : VERTICAL
 Limit : FCC PART 15C PEAK
 Env. / Ins. : 23°C/54% Engineer : Paul
 EUT : Blu-ray Disc Player M/N:VBR220
 Power : DC 5V
 Test mode : Tx Mode 2412MHz

	Ant.	Cable	Amp.	Emission					
Freq.	Factor	loss	Factor	Reading	Level	Limits	Margin	Remark	
(MHz)	(dB/m)	(dB)	(dB)	(dBuV)	(dBuV/m)	(dBuV/m)	(dB)		
1	2331.275	29.40	8.57	36.06	51.12	53.03	74.00	20.97	Peak
2	2390.000	29.44	8.67	36.09	56.39	58.41	74.00	15.59	Peak
3	2400.000	29.44	8.72	36.09	70.59	72.66	74.00	1.34	Peak
4	2412.005	29.45	8.72	35.95	104.55	106.77	74.00	-32.77	Peak

Remarks:

1. Emission Level= Antenna Factor + Cable Loss -Amp Factor + Reading.
2. The emission levels that are 20dB below the official limit are not reported.



No.6 Ke Feng Road,Block 52,
ShenZhen Science & Industry Park
Noutou,ShenZhen,GuangDong,China
Tel:+86-755-26639495-7
Fax:+86-755-26632877
Postcode:518057

Data: 4 File: E:\2010 report data\C\contel\ACS10Q0594R2.EM6 (108)

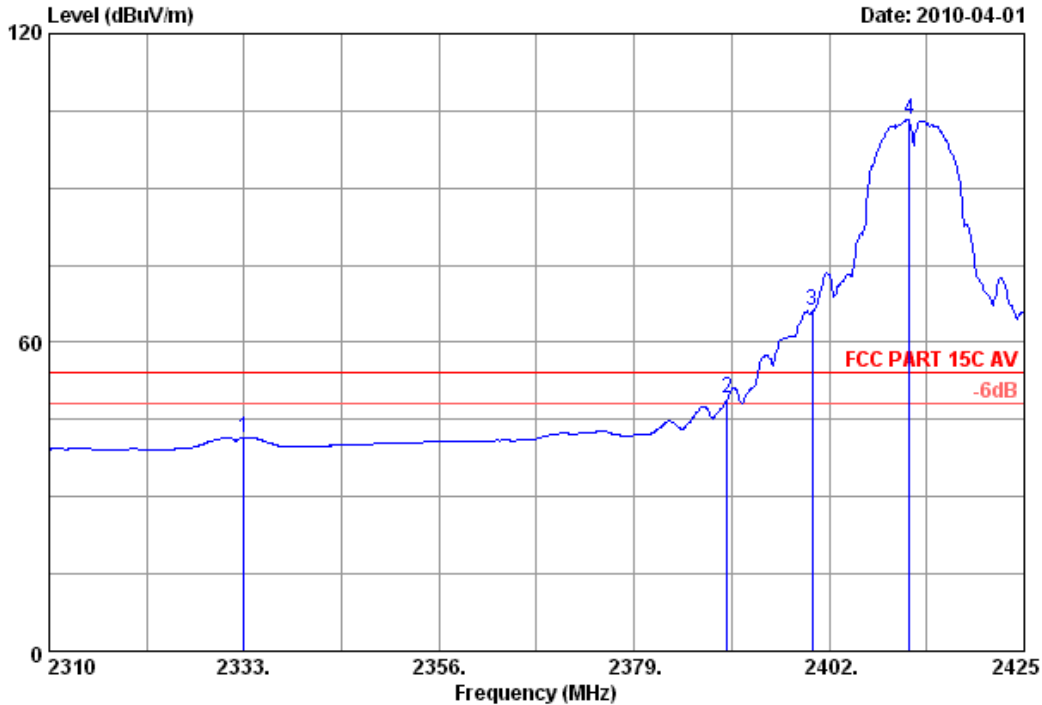

Site no. : 3m Chamber Data no. : 4
 Dis. / Ant. : 3m 3115(0911) Ant. pol. : VERTICAL
 Limit : FCC PART 15C AV
 Env. / Ins. : 23°C/54% Engineer : Paul
 EUT : Blu-ray Disc Player M/N:VBR220
 Power : DC 5V
 Test mode : Tx Mode 2412MHz

	Freq. (MHz)	Ant. Factor (dB/m)	Cable loss (dB)	Amp. Factor (dB)	Reading (dBuV)	Emission Level (dBuV/m)	Limits (dBuV/m)	Margin (dB)	Remark
1	2333.000	29.40	8.57	36.06	39.70	41.61	54.00	12.39	Average
2	2390.000	29.44	8.67	36.09	47.06	49.08	54.00	4.92	Average
3	2400.000	29.44	8.72	36.09	64.12	66.19	54.00	-12.19	Average
4	2411.430	29.45	8.72	35.95	100.93	103.15	54.00	-49.15	Average

Remarks:

1. Emission Level= Antenna Factor + Cable Loss -Amp Factor + Reading.
2. The emission levels that are 20dB below the official limit are not reported.



No.6 Ke Feng Road,Block 52,
ShenZhen Science & Industry Park
Noutou,ShenZhen,GuangDong,China
Tel:+86-755-26639495-7
Fax:+86-755-26632877
Postcode:518057

Data: 5 File: E:\2010 report data\C\contel\ACS10Q0594R2.EM6 (108)

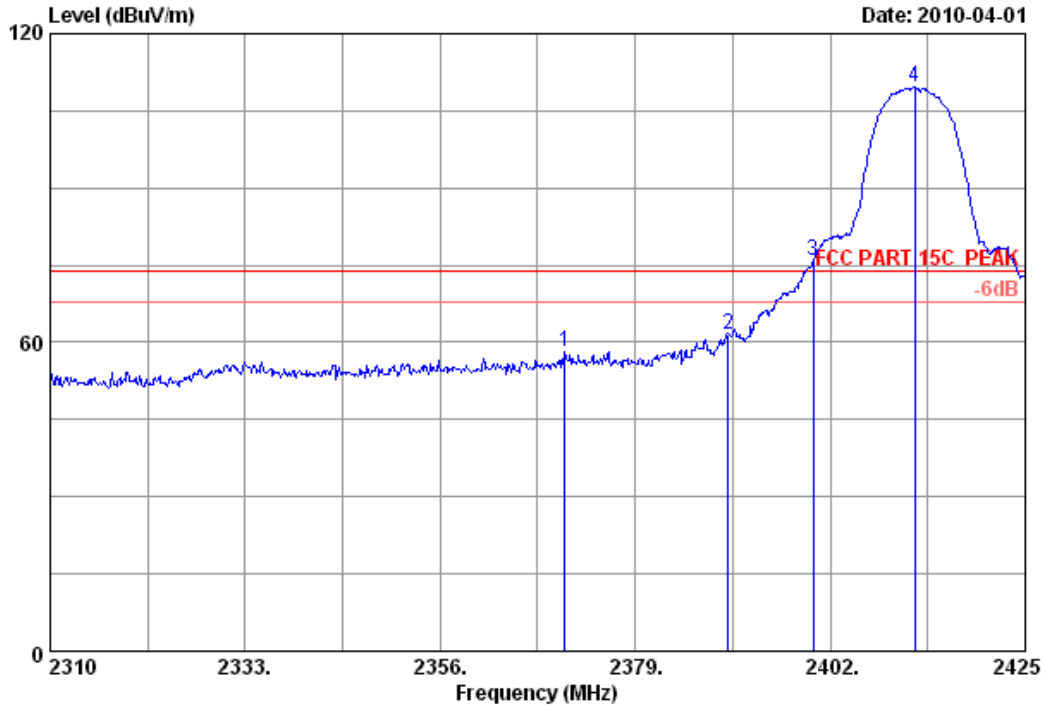

Site no. : 3m Chamber Data no. : 5
 Dis. / Ant. : 3m 3115(0911) Ant. pol. : HORIZONTAL
 Limit : FCC PART 15C PEAK
 Env. / Ins. : 23°C/54% Engineer : Paul
 EUT : Blu-ray Disc Player M/N:VBR220
 Power : DC 5V
 Test mode : Tx Mode 2412MHz

	Ant.	Cable	Amp.	Emission					
Freq.	Factor	loss	Factor	Reading	Level	Limits	Margin	Remark	
(MHz)	(dB/m)	(dB)	(dB)	(dBuV)	(dBuV/m)	(dBuV/m)	(dB)		
1	2370.720	29.43	8.62	36.00	56.16	58.21	74.00	15.79	Peak
2	2390.000	29.44	8.67	36.09	59.50	61.52	74.00	12.48	Peak
3	2400.000	29.44	8.72	36.09	73.84	75.91	74.00	-1.91	Peak
4	2412.005	29.45	8.72	35.95	107.32	109.54	74.00	-35.54	Peak

Remarks:

1. Emission Level= Antenna Factor + Cable Loss -Amp Factor + Reading.
2. The emission levels that are 20dB below the official limit are not reported.



No.6 Ke Feng Road,Block 52,
ShenZhen Science & Industry Park
Noutou,ShenZhen,GuangDong,China
Tel:+86-755-26639495-7
Fax:+86-755-26632877
Postcode:518057

Data: 6 File: E:\2010 report data\C\contel\ACS10Q0594R2.EM6 (108)

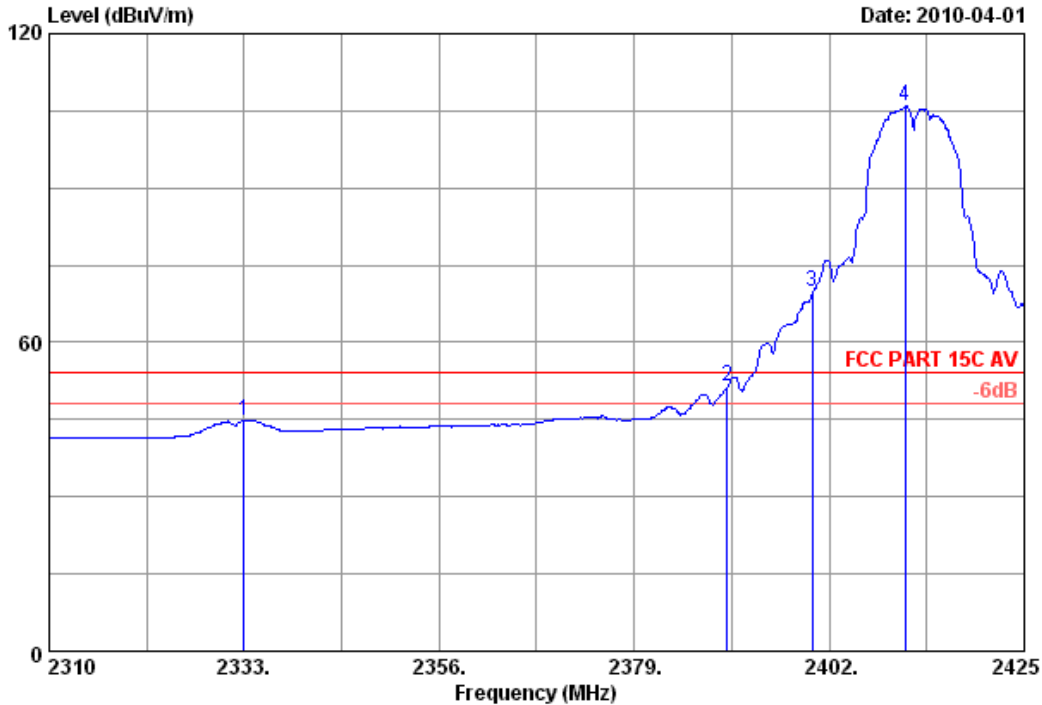

Site no. : 3m Chamber Data no. : 6
 Dis. / Ant. : 3m 3115(0911) Ant. pol. : HORIZONTAL
 Limit : FCC PART 15C AV
 Env. / Ins. : 23°C/54% Engineer : Paul
 EUT : Blu-ray Disc Player M/N:VBR220
 Power : DC 5V
 Test mode : Tx Mode 2412MHz

	Freq. (MHz)	Ant. Factor (dB/m)	Cable loss (dB)	Amp. Factor (dB)	Reading (dBUV)	Emission Level (dBUV/m)	Limits (dBUV/m)	Margin (dB)	Remark
1	2333.000	29.40	8.57	36.06	42.96	44.87	54.00	9.13	Average
2	2390.000	29.44	8.67	36.09	49.51	51.53	54.00	2.47	Average
3	2400.000	29.44	8.72	36.09	67.68	69.75	54.00	-15.75	Average
4	2410.970	29.45	8.72	35.95	103.61	105.83	54.00	-51.83	Average

Remarks:
 1. Emission Level= Antenna Factor + Cable Loss -Amp Factor + Reading.
 2. The emission levels that are 20dB below the official limit are not reported.



No.6 Ke Feng Road,Block 52,
ShenZhen Science & Industry Park
Noutou,ShenZhen,GuangDong,China
Tel:+86-755-26639495-7
Fax:+86-755-26632877
Postcode:518057

Data: 23

File: E:\2010 report data\C\contel\ACS10Q0594R2.EM6 (108)

Date: 2010-04-01

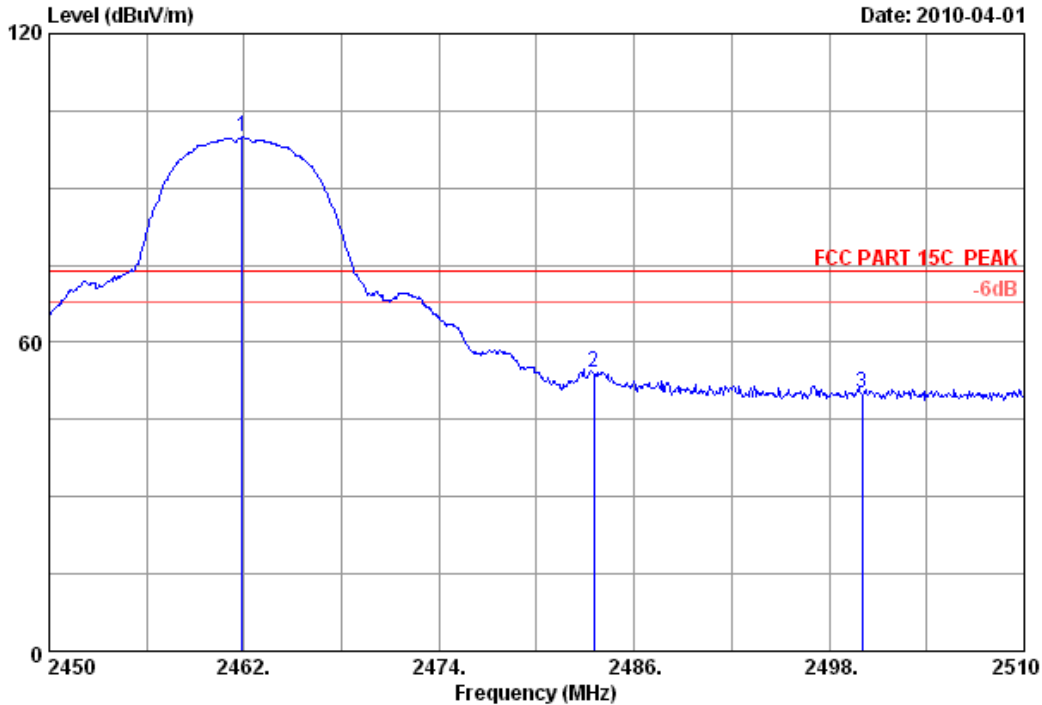

Site no. : 3m Chamber Data no. : 23
 Dis. / Ant. : 3m 3115(0911) Ant. pol. : HORIZONTAL
 Limit : FCC PART 15C PEAK
 Env. / Ins. : 23°C/54% Engineer : Paul
 EUT : Blu-ray Disc Player M/N:VBR220
 Power : DC 5V
 Test mode : Tx Mode 11b CH11 2462MHz

	Freq. (MHz)	Ant. Factor (dB/m)	Cable loss (dB)	Amp. Factor (dB)	Reading (dBUV)	Emission Level (dBUV/m)	Limits (dBUV/m)	Margin (dB)	Remark
1	2461.880	29.48	8.82	36.02	97.51	99.79	74.00	-25.79	Peak
2	2483.500	29.49	8.87	35.97	51.61	54.00	74.00	20.00	Peak
3	2500.000	29.50	8.92	36.00	47.71	50.13	74.00	23.87	Peak

Remarks:

1. Emission Level= Antenna Factor + Cable Loss -Amp Factor + Reading.
2. The emission levels that are 20dB below the official limit are not reported.



No.6 Ke Feng Road,Block 52,
ShenZhen Science & Industry Park
Noutou,ShenZhen,GuangDong,China
Tel:+86-755-26639495-7
Fax:+86-755-26632877
Postcode:518057

Data: 24 File: E:\2010 report data\C\contel\ACS10Q0594R2.EM6 (108)

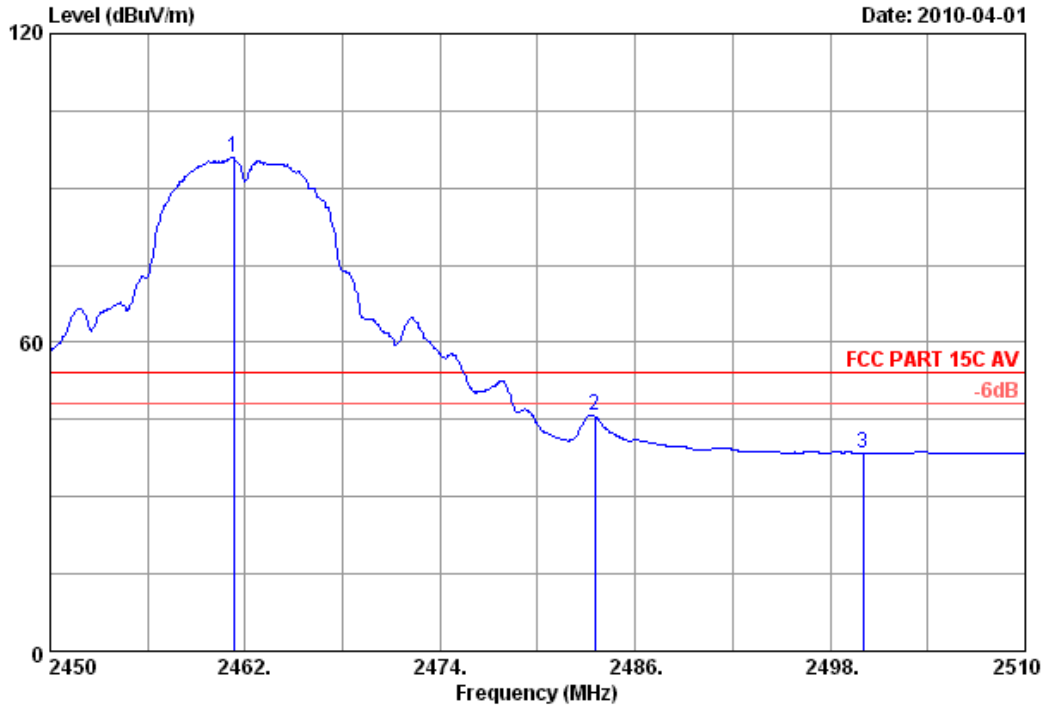

Site no. : 3m Chamber Data no. : 24
 Dis. / Ant. : 3m 3115(0911) Ant. pol. : HORIZONTAL
 Limit : FCC PART 15C AV
 Env. / Ins. : 23°C/54% Engineer : Paul
 EUT : Blu-ray Disc Player M/N:VBR220
 Power : DC 5V
 Test mode : Tx Mode 11b CH11 2462MHz

	Freq. (MHz)	Ant. Factor (dB/m)	Cable loss (dB)	Amp. Factor (dB)	Reading (dBuV)	Emission Level (dBuV/m)	Limits (dBuV/m)	Margin (dB)	Remark
1	2461.280	29.48	8.82	36.02	93.58	95.86	54.00	-41.86	Average
2	2483.500	29.49	8.87	35.97	43.24	45.63	54.00	8.37	Average
3	2500.000	29.50	8.92	36.00	36.14	38.56	54.00	15.44	Average

Remarks:

1. Emission Level= Antenna Factor + Cable Loss -Amp Factor + Reading.
2. The emission levels that are 20dB below the official limit are not reported.



No.6 Ke Feng Road,Block 52,
ShenZhen Science & Industry Park
Noutou,ShenZhen,GuangDong,China
Tel:+86-755-26639495-7
Fax:+86-755-26632877
Postcode:518057

Data: 25

File: E:\2010 report data\C\contel\ACS10Q0594R2.EM6 (108)

Date: 2010-04-01

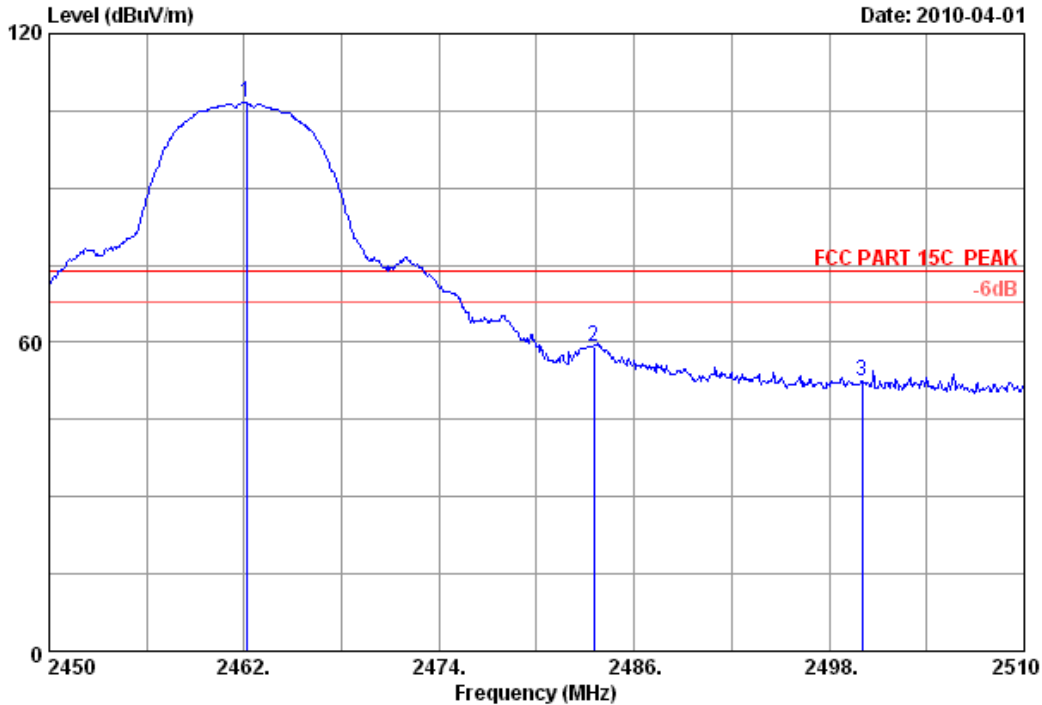

Site no. : 3m Chamber Data no. : 25
 Dis. / Ant. : 3m 3115(0911) Ant. pol. : VERTICAL
 Limit : FCC PART 15C PEAK
 Env. / Ins. : 23°C/54% Engineer : Paul
 EUT : Blu-ray Disc Player M/N:VBR220
 Power : DC 5V
 Test mode : Tx Mode 11b CH11 2462MHz

	Freq. (MHz)	Ant. Factor (dB/m)	Cable loss (dB)	Amp. Factor (dB)	Reading (dBuV)	Emission Level (dBuV/m)	Limits (dBuV/m)	Margin (dB)	Remark
1	2462.120	29.48	8.82	36.02	104.28	106.56	74.00	-32.56	Peak
2	2483.500	29.49	8.87	35.97	56.89	59.28	74.00	14.72	Peak
3	2500.000	29.50	8.92	36.00	49.97	52.39	74.00	21.61	Peak

Remarks:

1. Emission Level= Antenna Factor + Cable Loss -Amp Factor + Reading.
2. The emission levels that are 20dB below the official limit are not reported.



No.6 Ke Feng Road,Block 52,
ShenZhen Science & Industry Park
Noutou,ShenZhen,GuangDong,China
Tel:+86-755-26639495-7
Fax:+86-755-26632877
Postcode:518057

Data: 26 File: E:\2010 report data\C\contel\ACS10Q0594R2.EM6 (108)

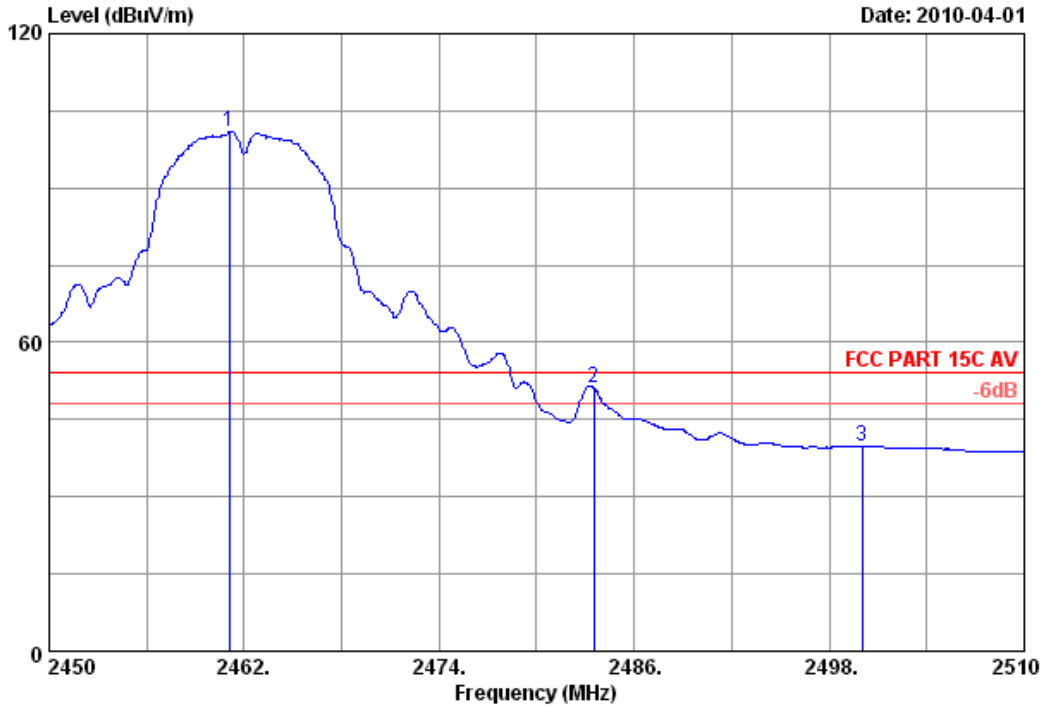

Site no. : 3m Chamber Data no. : 26
 Dis. / Ant. : 3m 3115(0911) Ant. pol. : VERTICAL
 Limit : FCC PART 15C AV
 Env. / Ins. : 23°C/54% Engineer : Paul
 EUT : Blu-ray Disc Player M/N:VBR220
 Power : DC 5V
 Test mode : Tx Mode 11b CH11 2462MHz

	Ant.	Cable	Amp.	Emission					
Freq.	Factor	loss	Factor	Reading	Level	Limits	Margin	Remark	
(MHz)	(dB/m)	(dB)	(dB)	(dBuV)	(dBuV/m)	(dBuV/m)	(dB)		
1 2461.100	29.48	8.82	36.02	98.73	101.01	54.00	-47.01	Average	
2 2483.500	29.49	8.87	35.97	48.74	51.13	54.00	2.87	Average	
3 2500.000	29.50	8.92	36.00	37.44	39.86	54.00	14.14	Average	

Remarks:

1. Emission Level= Antenna Factor + Cable Loss -Amp Factor + Reading.
2. The emission levels that are 20dB below the official limit are not reported.



No.6 Ke Feng Road,Block 52,
ShenZhen Science & Industry Park
Noutou,ShenZhen,GuangDong,China
Tel:+86-755-26639495-7
Fax:+86-755-26632877
Postcode:518057

Data: 27 File: E:\2010 report data\C\contel\ACS10Q0594R2.EM6 (108)

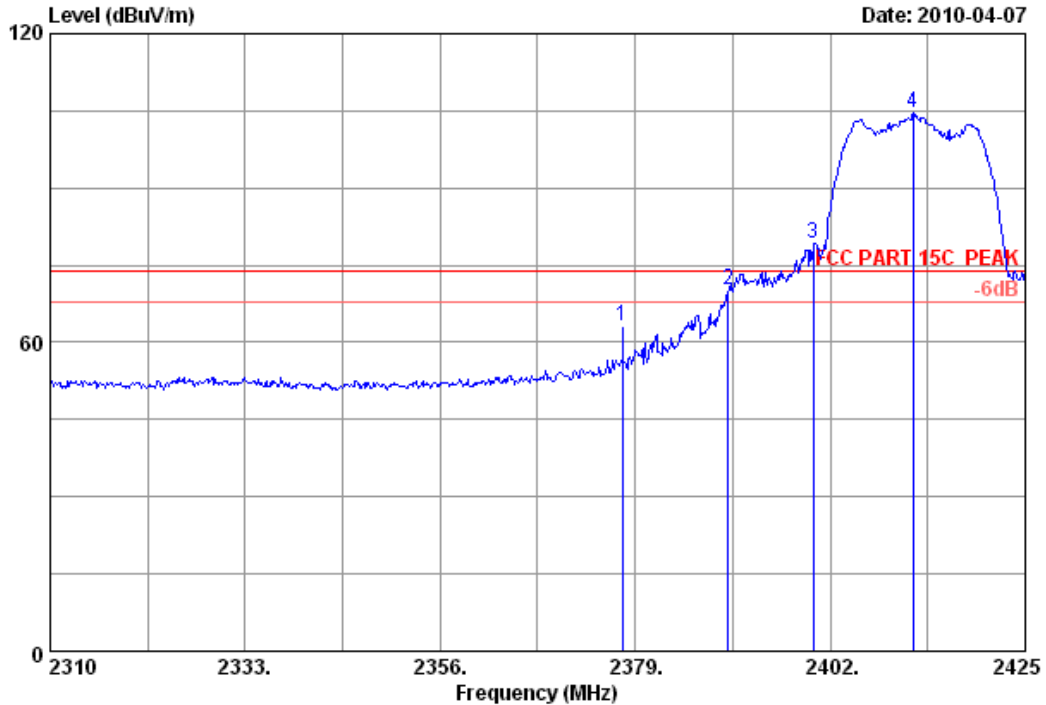

Site no. : 3m Chamber Data no. : 27
 Dis. / Ant. : 3m 3115(0911) Ant. pol. : VERTICAL
 Limit : FCC PART 15C PEAK
 Env. / Ins. : 23°C/54% Engineer : Paul
 EUT : Blu-ray Disc Player M/N:VBR220
 Power : DC 5V
 Test mode : Tx Mode 11g CH1 2412MHz

	Ant.	Cable	Amp.	Emission					
Freq.	Factor	loss	Factor	Reading	Level	Limits	Margin	Remark	
(MHz)	(dB/m)	(dB)	(dB)	(dBuV)	(dBuV/m)	(dBuV/m)	(dB)		
1	2377.505	29.43	8.67	36.00	61.19	63.29	74.00	10.71	Peak
2	2390.000	29.44	8.67	36.09	68.14	70.16	74.00	3.84	Peak
3	2400.000	29.44	8.72	36.09	77.12	79.19	74.00	-5.19	Peak
4	2411.775	29.45	8.72	35.95	102.36	104.58	74.00	-30.58	Peak

Remarks:

1. Emission Level= Antenna Factor + Cable Loss -Amp Factor + Reading.
2. The emission levels that are 20dB below the official limit are not reported.



No.6 Ke Feng Road,Block 52,
ShenZhen Science & Industry Park
Noutou,ShenZhen,GuangDong,China
Tel:+86-755-26639495-7
Fax:+86-755-26632877
Postcode:518057

Data: 28

File: E:\2010 report data\C\contel\ACS10Q0594R2.EM6 (108)

Date: 2010-04-07

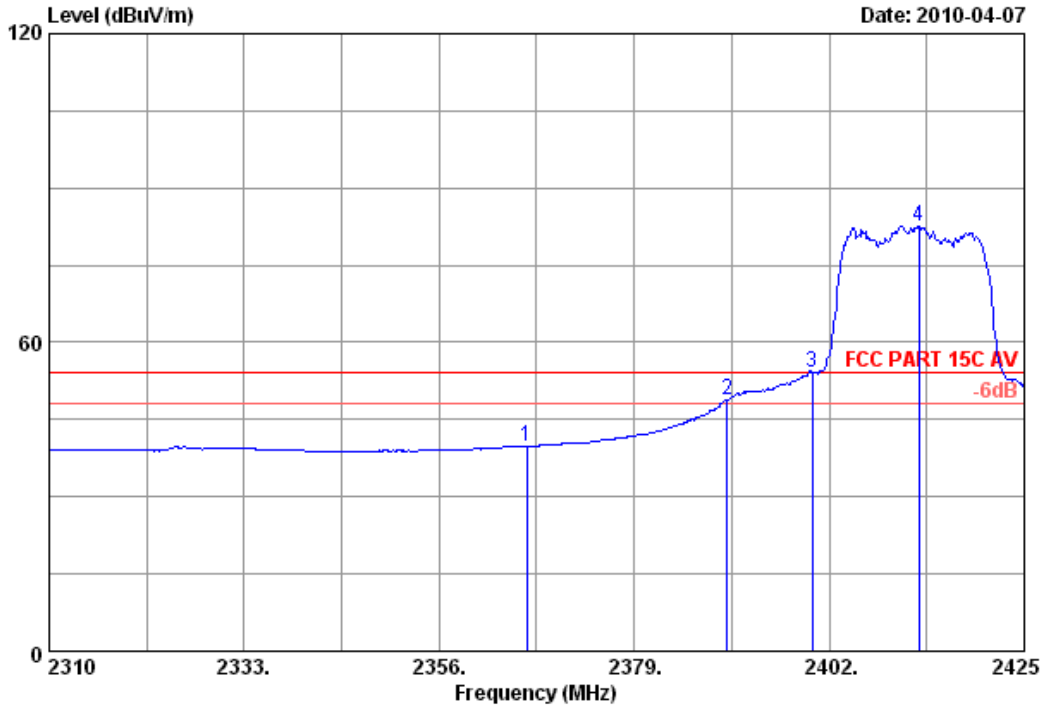

Site no. : 3m Chamber Data no. : 28
 Dis. / Ant. : 3m 3115(0911) Ant. pol. : VERTICAL
 Limit : FCC PART 15C AV
 Env. / Ins. : 23°C/54% Engineer : Paul
 EUT : Blu-ray Disc Player M/N:VBR220
 Power : DC 5V
 Test mode : Tx Mode 11g CH1 2412MHz

	Ant. Freq. (MHz)	Ant. Factor (dB/m)	Cable loss (dB)	Amp. Factor (dB)	Reading (dBuV)	Emission Level (dBuV/m)	Limits (dBuV/m)	Margin (dB)	Remark
1	2366.350	29.42	8.62	35.91	37.71	39.84	54.00	14.16	Average
2	2390.000	29.44	8.67	36.09	46.78	48.80	54.00	5.20	Average
3	2400.000	29.44	8.72	36.09	51.99	54.06	54.00	-0.06	Average
4	2412.580	29.45	8.72	35.95	80.47	82.69	54.00	-28.69	Average

Remarks:

1. Emission Level= Antenna Factor + Cable Loss -Amp Factor + Reading.
2. The emission levels that are 20dB below the official limit are not reported.



No.6 Ke Feng Road,Block 52,
ShenZhen Science & Industry Park
Noutou,ShenZhen,GuangDong,China
Tel:+86-755-26639495-7
Fax:+86-755-26632877
Postcode:518057

Data: 29 File: E:\2010 report data\C\contel\ACS10Q0594R2.EM6 (108)

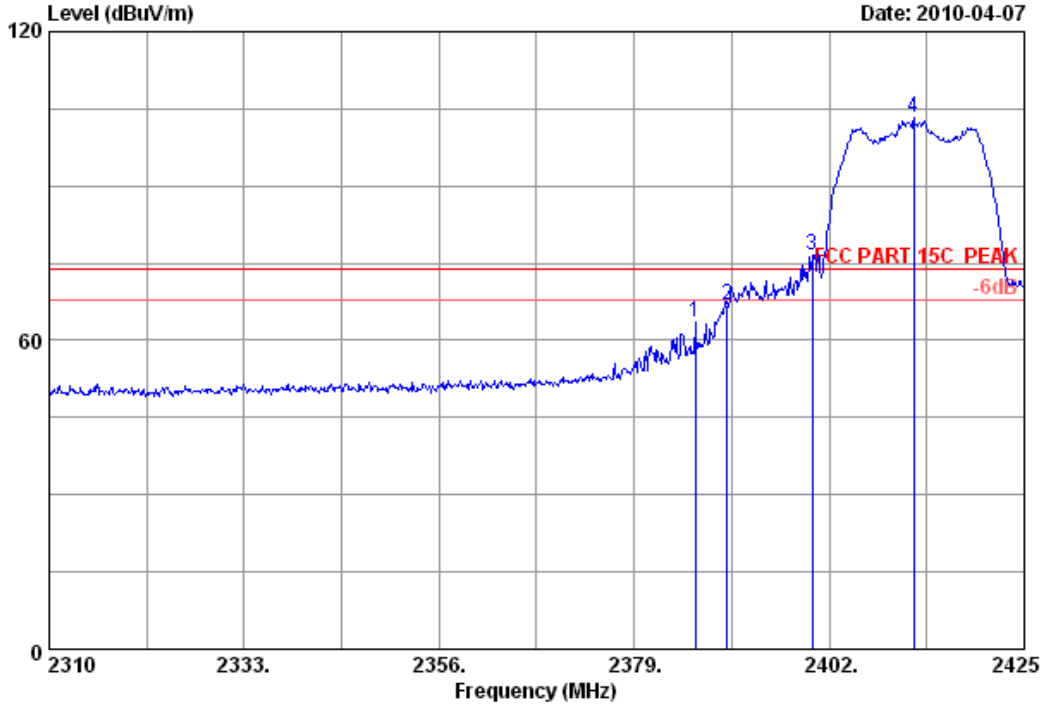

Site no. : 3m Chamber Data no. : 29
 Dis. / Ant. : 3m 3115(0911) Ant. pol. : HORIZONTAL
 Limit : FCC PART 15C PEAK
 Env. / Ins. : 23°C/54% Engineer : Paul
 EUT : Blu-ray Disc Player M/N:VBR220
 Power : DC 5V
 Test mode : Tx Mode 11g CH1 2412MHz

	Freq. (MHz)	Ant. Factor (dB/m)	Cable loss (dB)	Amp. Factor (dB)	Reading (dBUV)	Emission Level (dBUV/m)	Limits (dBUV/m)	Margin (dB)	Remark
1	2386.245	29.44	8.67	36.09	61.43	63.45	74.00	10.55	Peak
2	2390.000	29.44	8.67	36.09	64.93	66.95	74.00	7.05	Peak
3	2400.000	29.44	8.72	36.09	74.59	76.66	74.00	-2.66	Peak
4	2412.005	29.45	8.72	35.95	101.04	103.26	74.00	-29.26	Peak

Remarks:

1. Emission Level= Antenna Factor + Cable Loss -Amp Factor + Reading.
2. The emission levels that are 20dB below the official limit are not reported.



No.6 Ke Feng Road,Block 52,
ShenZhen Science & Industry Park
Noutou,ShenZhen,GuangDong,China
Tel:+86-755-26639495-7
Fax:+86-755-26632877
Postcode:518057

Data: 30 File: E:\2010 report data\C\contel\ACS10Q0594R2.EM6 (108)

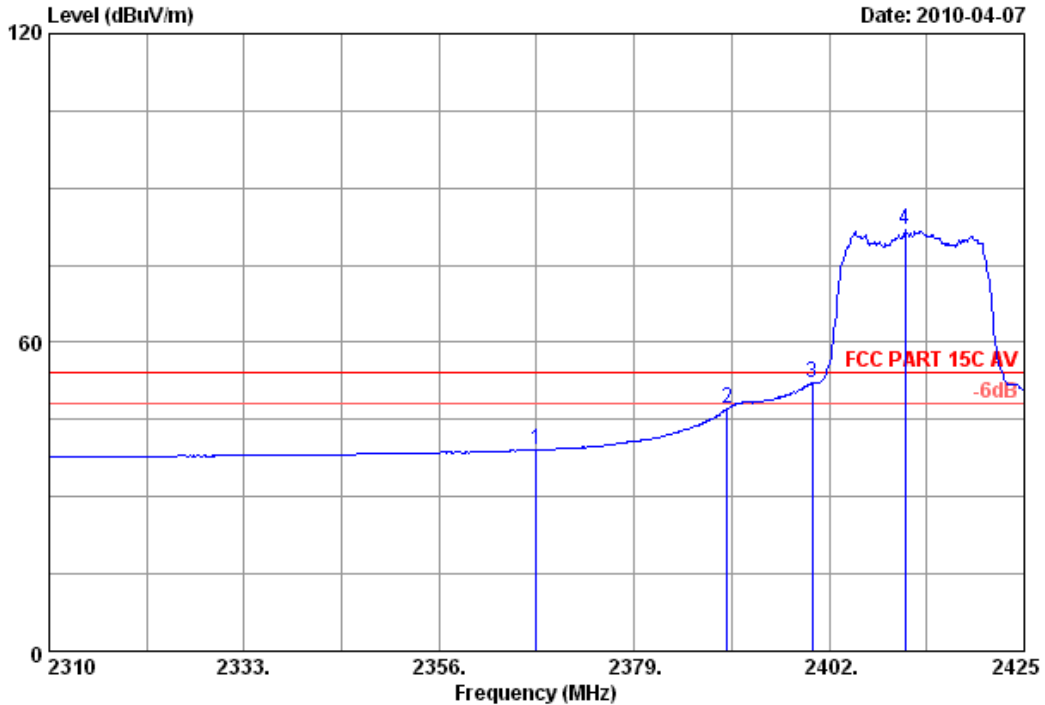

Site no. : 3m Chamber Data no. : 30
 Dis. / Ant. : 3m 3115(0911) Ant. pol. : HORIZONTAL
 Limit : FCC PART 15C AV
 Env. / Ins. : 23°C/54% Engineer : Paul
 EUT : Blu-ray Disc Player M/N:VBR220
 Power : DC 5V
 Test mode : Tx Mode 11g CH1 2412MHz

	Freq. (MHz)	Ant. Factor (dB/m)	Cable loss (dB)	Amp. Factor (dB)	Reading (dBuV)	Emission Level (dBuV/m)	Limits (dBuV/m)	Margin (dB)	Remark
1	2367.500	29.42	8.62	35.91	36.93	39.06	54.00	14.94	Average
2	2390.000	29.44	8.67	36.09	45.06	47.08	54.00	6.92	Average
3	2400.000	29.44	8.72	36.09	50.19	52.26	54.00	1.74	Average
4	2410.970	29.45	8.72	35.95	79.54	81.76	54.00	-27.76	Average

Remarks:
 1. Emission Level= Antenna Factor + Cable Loss -Amp Factor + Reading.
 2. The emission levels that are 20dB below the official limit are not reported.



No.6 Ke Feng Road,Block 52,
ShenZhen Science & Industry Park
Noutou,ShenZhen,GuangDong,China
Tel:+86-755-26639495-7
Fax:+86-755-26632877
Postcode:518057

Data: 48 File: E:\2010 report data\C\contel\ACS10Q0594R2.EM6 (108)

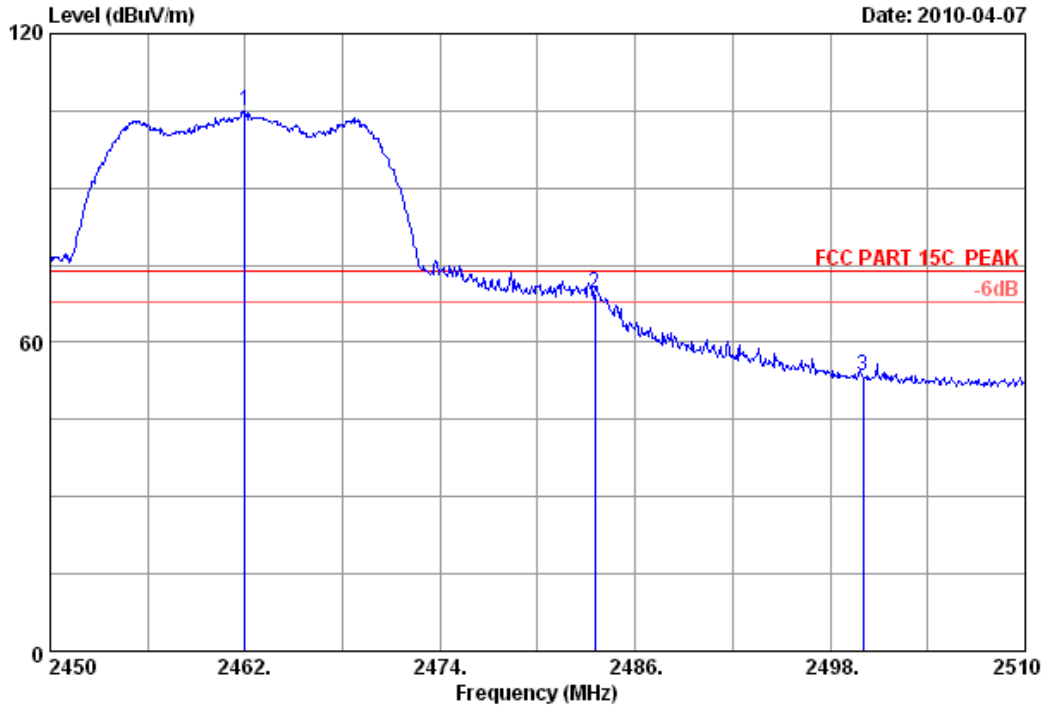

Site no. : 3m Chamber Data no. : 48
 Dis. / Ant. : 3m 3115(0911) Ant. pol. : VERTICAL
 Limit : FCC PART 15C PEAK
 Env. / Ins. : 23°C/54% Engineer : Paul
 EUT : Blu-ray Disc Player M/N:VBR220
 Power : DC 5V
 Test mode : Tx Mode 11g CH11 2462MHz

	Ant. Freq. (MHz)	Ant. Factor (dB/m)	Cable loss (dB)	Amp. Factor (dB)	Reading (dBuV)	Emission Level (dBuV/m)	Limits (dBuV/m)	Margin (dB)	Remark
1	2462.000	29.48	8.82	36.02	102.71	104.99	74.00	-30.99	Peak
2	2483.500	29.49	8.87	35.97	67.02	69.41	74.00	4.59	Peak
3	2500.000	29.50	8.92	36.00	51.20	53.62	74.00	20.38	Peak

Remarks:

1. Emission Level= Antenna Factor + Cable Loss -Amp Factor + Reading.
2. The emission levels that are 20dB below the official limit are not reported.



No.6 Ke Feng Road,Block 52,
Shenzhen Science & Industry Park
Noutou,Shenzhen,GuangDong,China
Tel:+86-755-26639495-7
Fax:+86-755-26632877
Postcode:518057

Data: 49

File: E:\2010 report data\C\contel\ACS10Q0594R2.EM6 (108)

Date: 2010-04-07

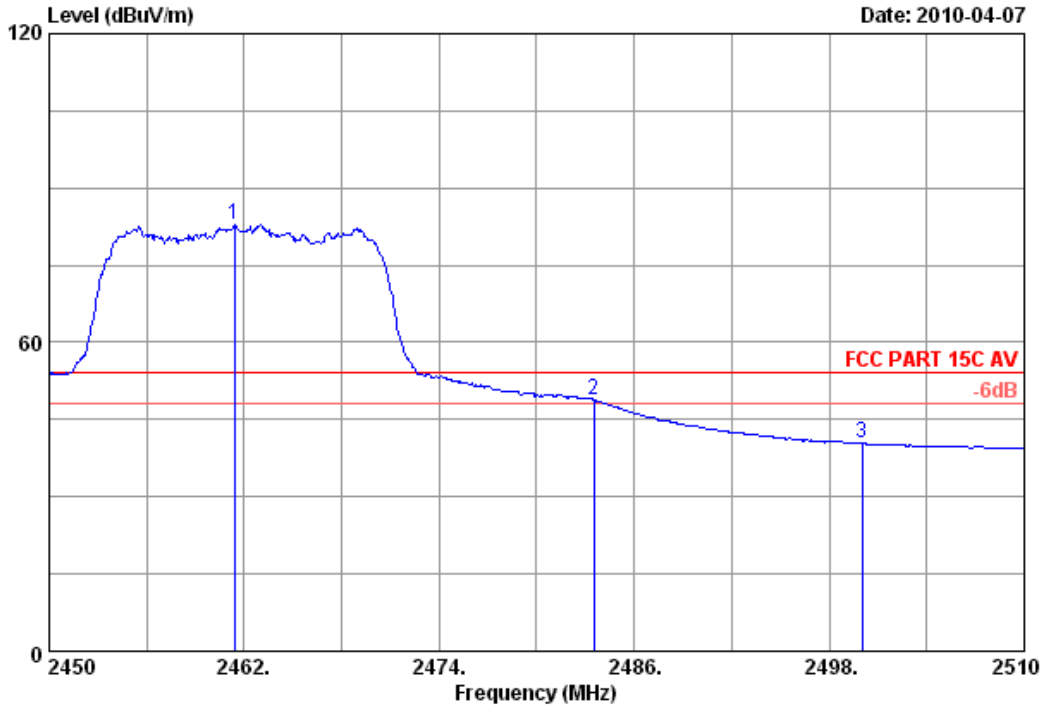

Site no. : 3m Chamber Data no. : 49
 Dis. / Ant. : 3m 3115(0911) Ant. pol. : VERTICAL
 Limit : FCC PART 15C AV
 Env. / Ins. : 23°C/54% Engineer : Paul
 EUT : Blu-ray Disc Player M/N:VBR220
 Power : DC 5V
 Test mode : Tx Mode 11g CH11 2462MHz

	Ant.	Cable	Amp.	Emission					
Freq.	Factor	loss	Factor	Reading	Level	Limits	Margin	Remark	
(MHz)	(dB/m)	(dB)	(dB)	(dBUV)	(dBUV/m)	(dBUV/m)	(dB)		
1 2461.400	29.48	8.82	36.02	80.50	82.78	54.00	-28.78	Average	
2 2483.500	29.49	8.87	35.97	46.35	48.74	54.00	5.26	Average	
3 2500.000	29.50	8.92	36.00	37.97	40.39	54.00	13.61	Average	

Remarks:

1. Emission Level= Antenna Factor + Cable Loss -Amp Factor + Reading.
2. The emission levels that are 20dB below the official limit are not reported.



No.6 Ke Feng Road,Block 52,
ShenZhen Science & Industry Park
Noutou,ShenZhen,GuangDong,China
Tel:+86-755-26639495-7
Fax:+86-755-26632877
Postcode:518057

Data: 50 File: E:\2010 report data\C\contel\ACS10Q0594R2.EM6 (108)

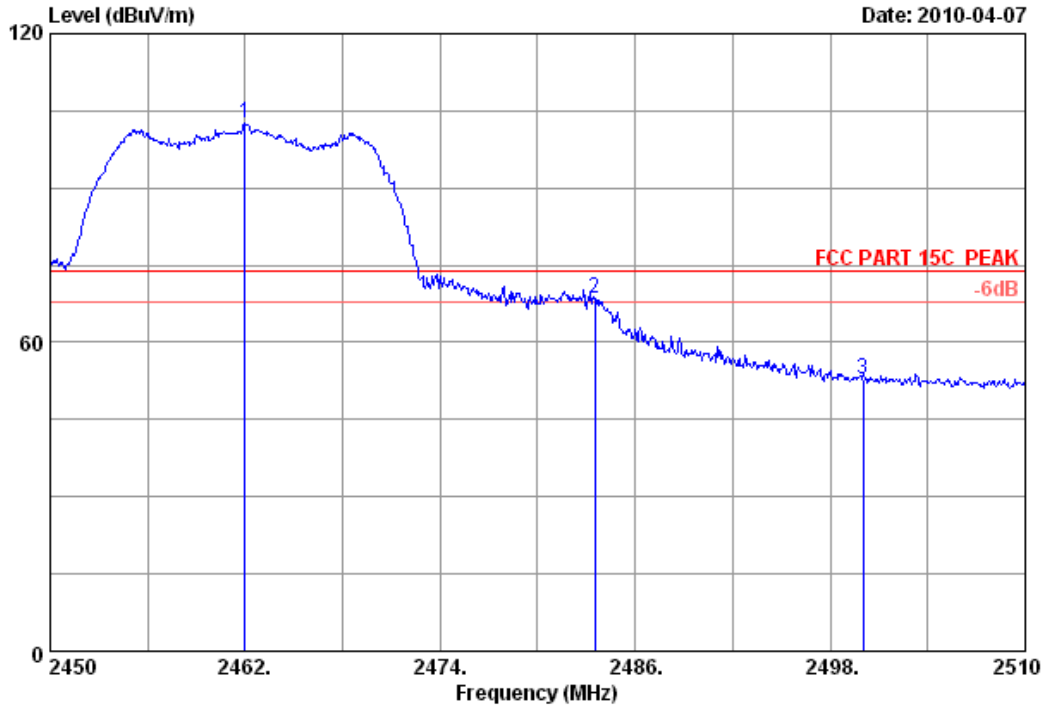

Site no. : 3m Chamber Data no. : 50
 Dis. / Ant. : 3m 3115(0911) Ant. pol. : HORIZONTAL
 Limit : FCC PART 15C PEAK
 Env. / Ins. : 23°C/54% Engineer : Paul
 EUT : Blu-ray Disc Player M/N:VBR220
 Power : DC 5V
 Test mode : Tx Mode 11g CH11 2462MHz

	Freq. (MHz)	Ant. Factor (dB/m)	Cable loss (dB)	Amp. Factor (dB)	Reading (dBuV)	Emission Level (dBuV/m)	Limits (dBuV/m)	Margin (dB)	Remark
1	2462.000	29.48	8.82	36.02	100.27	102.55	74.00	-28.55	Peak
2	2483.500	29.49	8.87	35.97	66.12	68.51	74.00	5.49	Peak
3	2500.000	29.50	8.92	36.00	50.40	52.82	74.00	21.18	Peak

Remarks:

1. Emission Level= Antenna Factor + Cable Loss -Amp Factor + Reading.
2. The emission levels that are 20dB below the official limit are not reported.



No.6 Ke Feng Road,Block 52,
Shenzhen Science & Industry Park
Noutou,Shenzhen,GuangDong,China
Tel:+86-755-26639495-7
Fax:+86-755-26632877
Postcode:518057

Data: 51

File: E:\2010 report data\C\contel\ACS10Q0594R2.EM6 (108)

Date: 2010-04-07

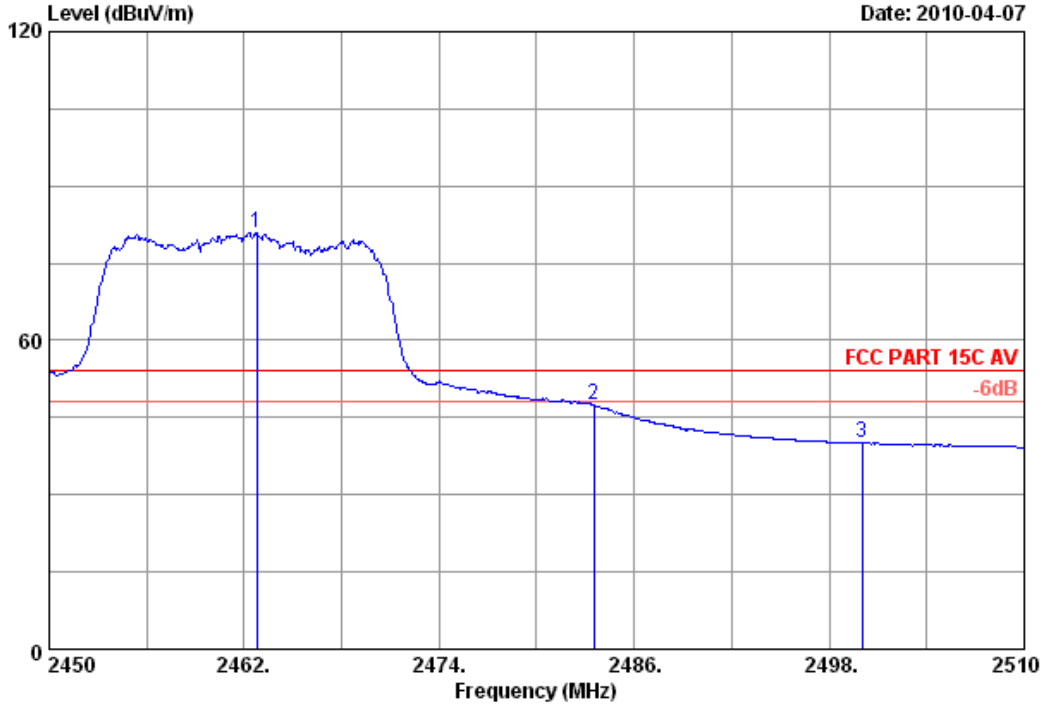

Site no. : 3m Chamber Data no. : 51
 Dis. / Ant. : 3m 3115(0911) Ant. pol. : HORIZONTAL
 Limit : FCC PART 15C AV
 Env. / Ins. : 23°C/54% Engineer : Paul
 EUT : Blu-ray Disc Player M/N:VBR220
 Power : DC 5V
 Test mode : Tx Mode 11g CH11 2462MHz

	Ant. Freq. (MHz)	Ant. Factor (dB/m)	Cable loss (dB)	Amp. Factor (dB)	Reading (dBUV)	Emission Level (dBUV/m)	Limits (dBUV/m)	Margin (dB)	Remark
1	2462.780	29.48	8.82	36.02	78.70	80.98	54.00	-26.98	Average
2	2483.500	29.49	8.87	35.97	45.03	47.42	54.00	6.58	Average
3	2500.000	29.50	8.92	36.00	37.59	40.01	54.00	13.99	Average

Remarks:

1. Emission Level= Antenna Factor + Cable Loss -Amp Factor + Reading.
2. The emission levels that are 20dB below the official limit are not reported.



No.6 Ke Feng Road,Block 52,
 ShenZhen Science & Industry Park
 Noutou,ShenZhen,GuangDong,China
 Tel:+86-755-26639495-7
 Fax:+86-755-26632877
 Postcode:518057

Data: 59 File: E:\2010 report data\C\contel\ACS10Q0594R2.EM6 (108)

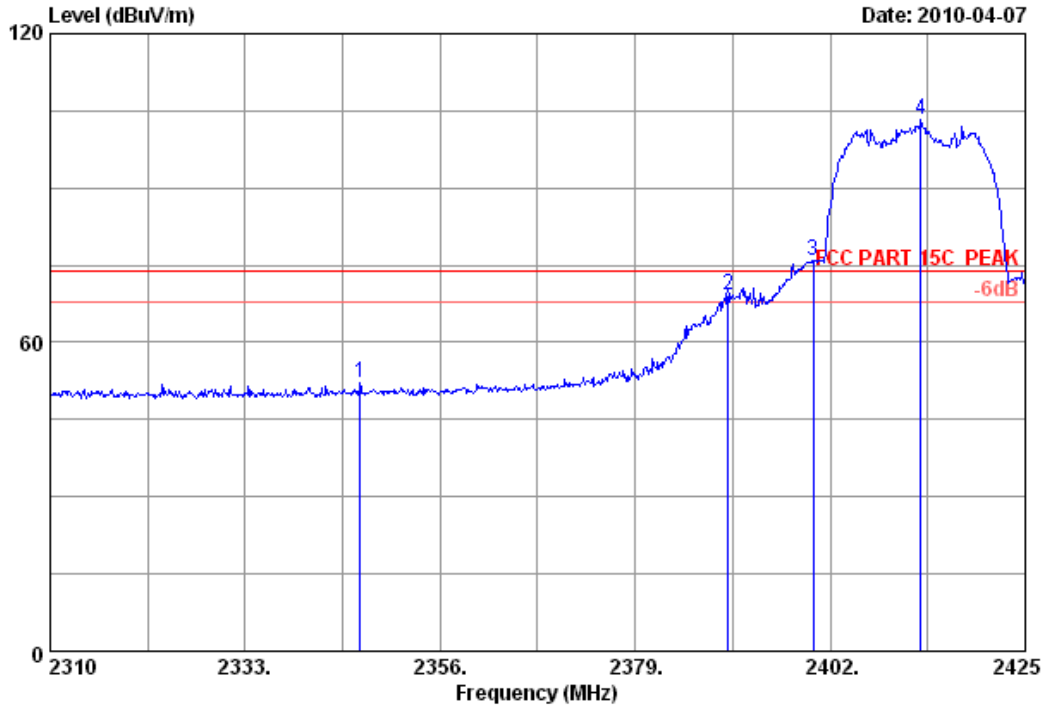

Site no. : 3m Chamber Data no. : 59
 Dis. / Ant. : 3m 3115(0911) Ant. pol. : HORIZONTAL
 Limit : FCC PART 15C PEAK
 Env. / Ins. : 23°C/54% Engineer : Paul
 EUT : Blu-ray Disc Player M/N:VBR220
 Power : DC 5V
 Test mode : Tx Mode 11nHT20 CH1 2412MHz

	Freq. (MHz)	Ant. Factor (dB/m)	Cable loss (dB)	Amp. Factor (dB)	Reading (dBuV)	Emission Level (dBuV/m)	Limits (dBuV/m)	Margin (dB)	Remark
1	2346.570	29.41	8.62	35.99	50.02	52.06	74.00	21.94	Peak
2	2390.000	29.44	8.67	36.09	67.03	69.05	74.00	4.95	Peak
3	2400.000	29.44	8.72	36.09	73.72	75.79	74.00	-1.79	Peak
4	2412.695	29.45	8.72	35.95	101.13	103.35	74.00	-29.35	Peak

Remarks:

1. Emission Level= Antenna Factor + Cable Loss -Amp Factor + Reading.
2. The emission levels that are 20dB below the official limit are not reported.



No.6 Ke Feng Road,Block 52,
ShenZhen Science & Industry Park
Noutou,ShenZhen,GuangDong,China
Tel:+86-755-26639495-7
Fax:+86-755-26632877
Postcode:518057

Data: 60 File: E:\2010 report data\C\intel\ACS10Q0594R2.EM6 (108)

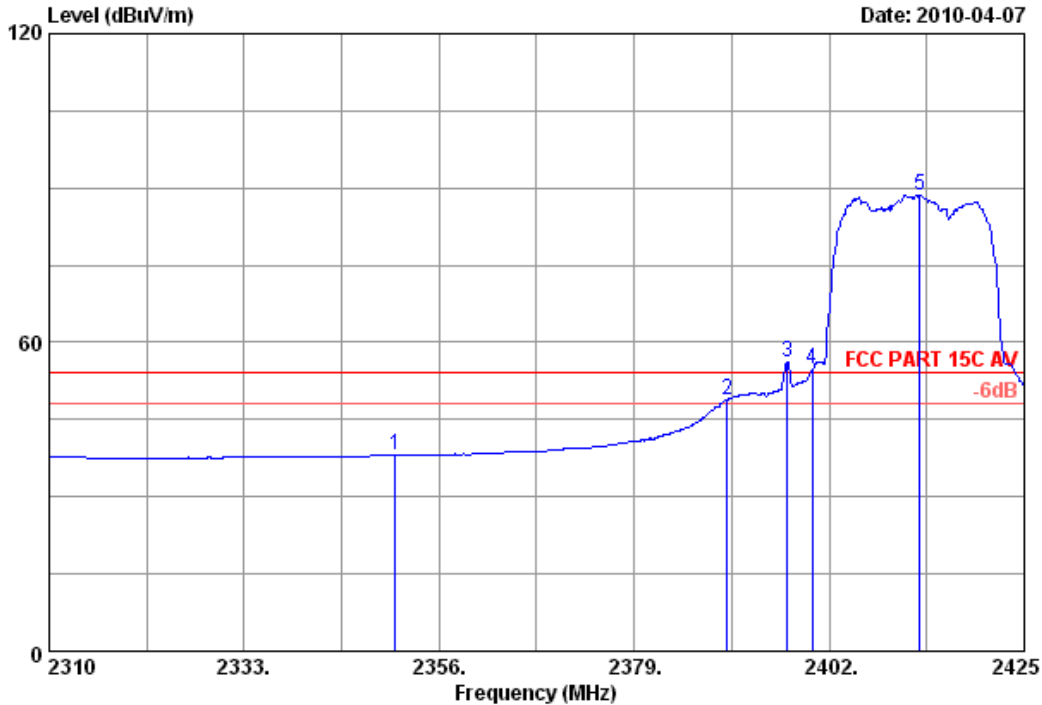

Site no. : 3m Chamber Data no. : 60
 Dis. / Ant. : 3m 3115(0911) Ant. pol. : HORIZONTAL
 Limit : FCC PART 15C AV
 Env. / Ins. : 23°C/54% Engineer : Paul
 EUT : Blu-ray Disc Player M/N:VBR220
 Power : DC 5V
 Test mode : Tx Mode 11nHT20 CH1 2412MHz

	Freq. (MHz)	Ant. Factor (dB/m)	Cable loss (dB)	Amp. Factor (dB)	Reading (dBuV)	Emission Level (dBuV/m)	Limits (dBuV/m)	Margin (dB)	Remark
1	2350.825	29.41	8.62	35.99	36.03	38.07	54.00	15.93	Average
2	2390.000	29.44	8.67	36.09	46.85	48.87	54.00	5.13	Average
3	2397.055	29.44	8.72	36.09	54.23	56.30	54.00	-2.30	Average
4	2400.000	29.44	8.72	36.09	52.83	54.90	54.00	-0.90	Average
5	2412.695	29.45	8.72	35.95	86.39	88.61	54.00	-34.61	Average

Remarks:

1. Emission Level= Antenna Factor + Cable Loss -Amp Factor + Reading.
2. The emission levels that are 20dB below the official limit are not reported.



No.6 Ke Feng Road,Block 52,
ShenZhen Science & Industry Park
Noutou,ShenZhen,GuangDong,China
Tel:+86-755-26639495-7
Fax:+86-755-26632877
Postcode:518057

Data: 61 File: E:\2010 report data\C\contel\ACS10Q0594R2.EM6 (108)

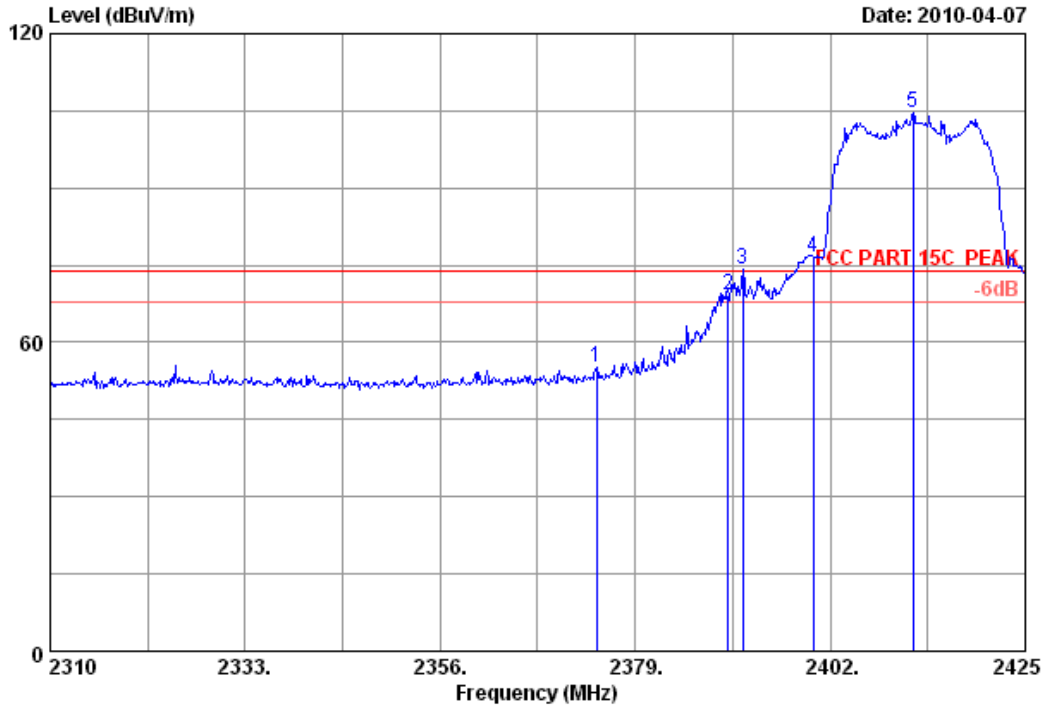

Site no. : 3m Chamber Data no. : 61
 Dis. / Ant. : 3m 3115(0911) Ant. pol. : VERTICAL
 Limit : FCC PART 15C PEAK
 Env. / Ins. : 23°C/54% Engineer : Paul
 EUT : Blu-ray Disc Player M/N:VBR220
 Power : DC 5V
 Test mode : Tx Mode 11nHT20 CH1 2412MHz

	Freq. (MHz)	Ant. Factor (dB/m)	Cable loss (dB)	Amp. Factor (dB)	Reading (dBuV)	Emission Level (dBuV/m)	Limits (dBuV/m)	Margin (dB)	Remark
1	2374.400	29.43	8.67	36.00	52.96	55.06	74.00	18.94	Peak
2	2390.000	29.44	8.67	36.09	67.31	69.33	74.00	4.67	Peak
3	2391.650	29.44	8.67	36.09	72.07	74.09	74.00	-0.09	Peak
4	2400.000	29.44	8.72	36.09	74.56	76.63	74.00	-2.63	Peak
5	2411.775	29.45	8.72	35.95	102.48	104.70	74.00	-30.70	Peak

Remarks:

1. Emission Level= Antenna Factor + Cable Loss -Amp Factor + Reading.
2. The emission levels that are 20dB below the official limit are not reported.



No.6 Ke Feng Road,Block 52,
ShenZhen Science & Industry Park
Noutou,ShenZhen,GuangDong,China
Tel:+86-755-26639495-7
Fax:+86-755-26632877
Postcode:518057

Data: 62 File: E:\2010 report data\C\contel\ACS10Q0594R2.EM6 (108)

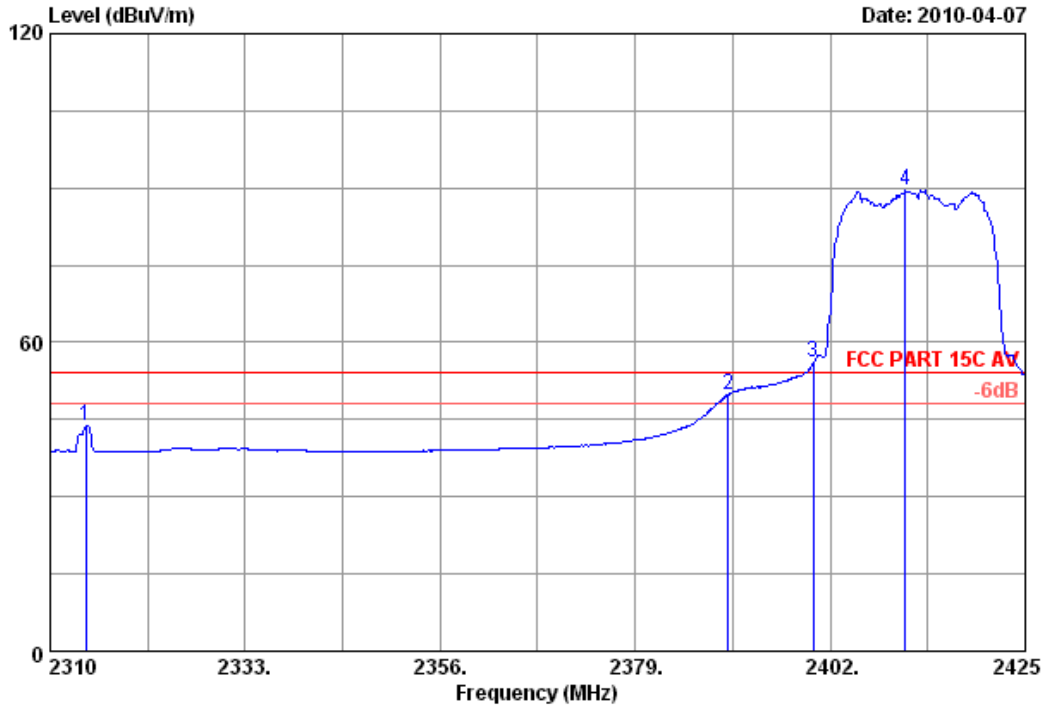

Site no. : 3m Chamber Data no. : 62
 Dis. / Ant. : 3m 3115(0911) Ant. pol. : VERTICAL
 Limit : FCC PART 15C AV
 Env. / Ins. : 23°C/54% Engineer : Paul
 EUT : Blu-ray Disc Player M/N:VBR220
 Power : DC 5V
 Test mode : Tx Mode 11nHT20 CH1 2412MHz

	Freq. (MHz)	Ant. Factor (dB/m)	Cable loss (dB)	Amp. Factor (dB)	Reading (dBuV)	Emission Level (dBuV/m)	Limits (dBuV/m)	Margin (dB)	Remark
1	2314.255	29.39	8.52	35.86	41.75	43.80	54.00	10.20	Average
2	2390.000	29.44	8.67	36.09	47.88	49.90	54.00	4.10	Average
3	2400.000	29.44	8.72	36.09	54.02	56.09	54.00	-2.09	Average
4	2410.855	29.45	8.72	35.95	87.34	89.56	54.00	-35.56	Average

Remarks:
 1. Emission Level= Antenna Factor + Cable Loss -Amp Factor + Reading.
 2. The emission levels that are 20dB below the official limit are not reported.



No.6 Ke Feng Road,Block 52,
Shenzhen Science & Industry Park
Noutou,Shenzhen,GuangDong,China
Tel:+86-755-26639495-7
Fax:+86-755-26632877
Postcode:518057

Data: 75

File: E:\2010 report data\C\contel\ACS10Q0594R2.EM6 (108)

Date: 2010-04-07

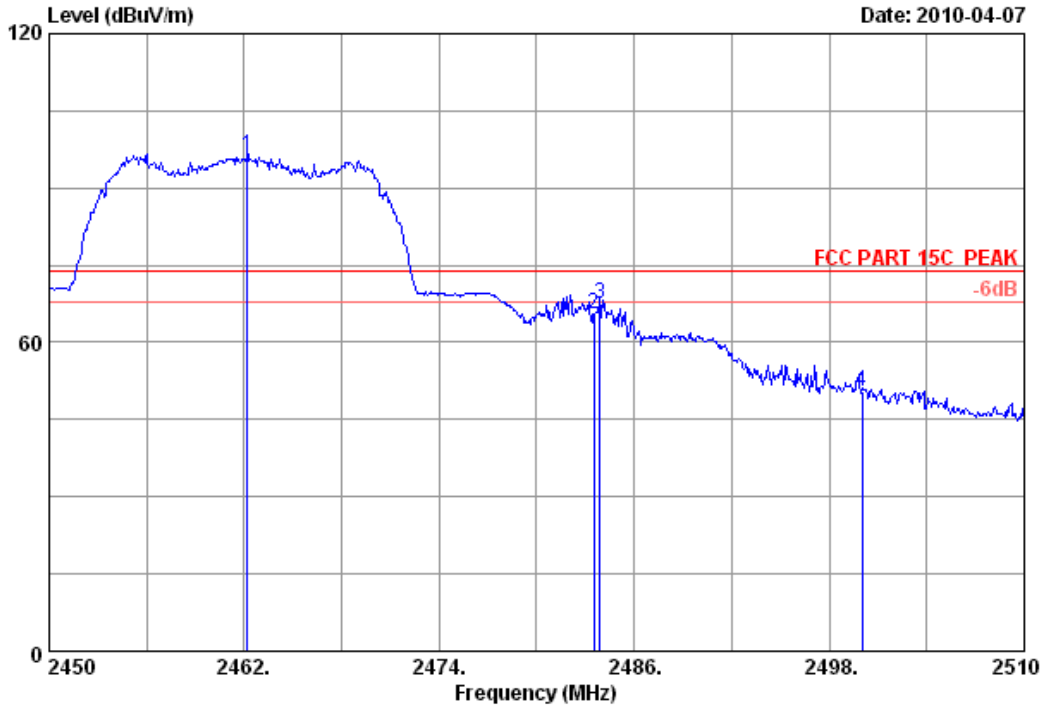

Site no. : 3m Chamber Data no. : 75
 Dis. / Ant. : 3m 3115(0911) Ant. pol. : HORIZONTAL
 Limit : FCC PART 15C PEAK
 Env. / Ins. : 23°C/54% Engineer : Paul
 EUT : Blu-ray Disc Player M/N:VBR220
 Power : DC 5V
 Test mode : Tx Mode 11nHT20 CH11 2462MHz

	Freq. (MHz)	Ant. Factor (dB/m)	Cable loss (dB)	Amp. Factor (dB)	Reading (dBuV)	Emission Level (dBuV/m)	Limits (dBuV/m)	Margin (dB)	Remark
1	2462.180	29.48	8.82	36.02	93.94	96.22	74.00	-22.22	Peak
2	2483.500	29.49	8.87	35.97	63.01	65.40	74.00	8.60	Peak
3	2483.900	29.49	8.87	35.97	65.02	67.41	74.00	6.59	Peak
4	2500.000	29.50	8.92	36.00	48.00	50.42	74.00	23.58	Peak

Remarks:

1. Emission Level= Antenna Factor + Cable Loss -Amp Factor + Reading.
2. The emission levels that are 20dB below the official limit are not reported.



No.6 Ke Feng Road,Block 52,
Shenzhen Science & Industry Park
Noutou,Shenzhen,GuangDong,China
Tel:+86-755-26639495-7
Fax:+86-755-26632877
Postcode:518057

Data: 76

File: E:\2010 report data\C\intel\ACS10Q0594R2.EM6 (108)

Date: 2010-04-07

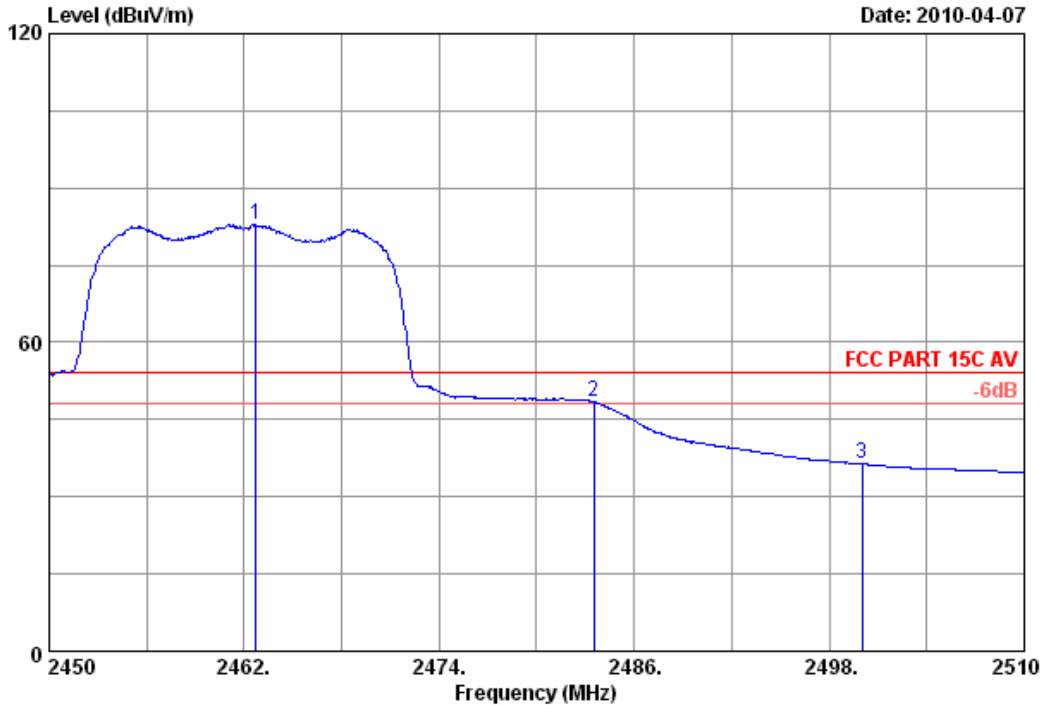

Site no. : 3m Chamber Data no. : 76
 Dis. / Ant. : 3m 3115(0911) Ant. pol. : HORIZONTAL
 Limit : FCC PART 15C AV
 Env. / Ins. : 23°C/54% Engineer : Paul
 EUT : Blu-ray Disc Player M/N:VBR220
 Power : DC 5V
 Test mode : Tx Mode 11nHT20 CH11 2462MHz

	Freq. (MHz)	Ant. Factor (dB/m)	Cable loss (dB)	Amp. Factor (dB)	Reading (dBuV)	Emission Level (dBuV/m)	Limits (dBuV/m)	Margin (dB)	Remark
1	2462.720	29.48	8.82	36.02	80.76	83.04	54.00	-29.04	Average
2	2483.500	29.49	8.87	35.97	46.06	48.45	54.00	5.55	Average
3	2500.000	29.50	8.92	36.00	33.96	36.38	54.00	17.62	Average

Remarks:

1. Emission Level= Antenna Factor + Cable Loss -Amp Factor + Reading.
2. The emission levels that are 20dB below the official limit are not reported.



No.6 Ke Feng Road,Block 52,
ShenZhen Science & Industry Park
Noutou,ShenZhen,GuangDong,China
Tel:+86-755-26639495-7
Fax:+86-755-26632877
Postcode:518057

Data: 77

File: E:\2010 report data\C\contel\ACS10Q0594R2.EM6 (108)

Date: 2010-04-07

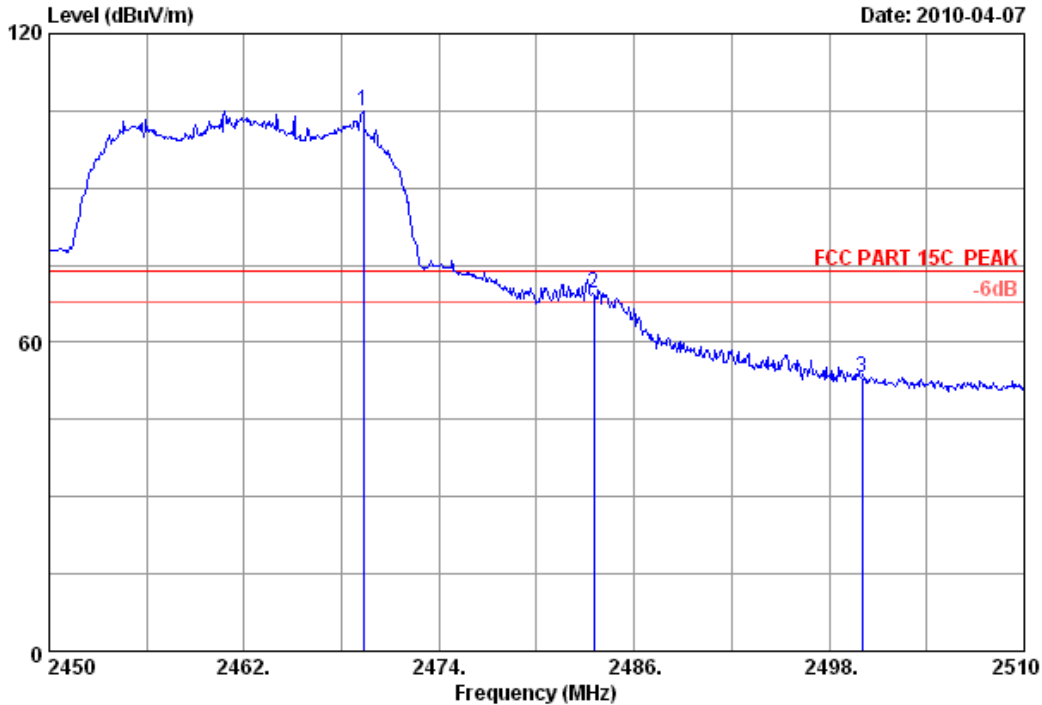

Site no. : 3m Chamber Data no. : 77
 Dis. / Ant. : 3m 3115(0911) Ant. pol. : VERTICAL
 Limit : FCC PART 15C PEAK
 Env. / Ins. : 23°C/54% Engineer : Paul
 EUT : Blu-ray Disc Player M/N:VBR220
 Power : DC 5V
 Test mode : Tx Mode 11nHT20 CH11 2462MHz

	Freq. (MHz)	Ant. Factor (dB/m)	Cable loss (dB)	Amp. Factor (dB)	Reading (dBuV)	Emission Level (dBuV/m)	Limits (dBuV/m)	Margin (dB)	Remark
1	2469.320	29.48	8.82	36.02	102.62	104.90	74.00	-30.90	Peak
2	2483.500	29.49	8.87	35.97	67.05	69.44	74.00	4.56	Peak
3	2500.000	29.50	8.92	36.00	50.68	53.10	74.00	20.90	Peak

Remarks:

1. Emission Level= Antenna Factor + Cable Loss -Amp Factor + Reading.
2. The emission levels that are 20dB below the official limit are not reported.



No.6 Ke Feng Road,Block 52,
ShenZhen Science & Industry Park
Noutou,ShenZhen,GuangDong,China
Tel:+86-755-26639495-7
Fax:+86-755-26632877
Postcode:518057

Data: 78

File: E:\2010 report data\C\contel\ACS10Q0594R2.EM6 (108)

Date: 2010-04-07

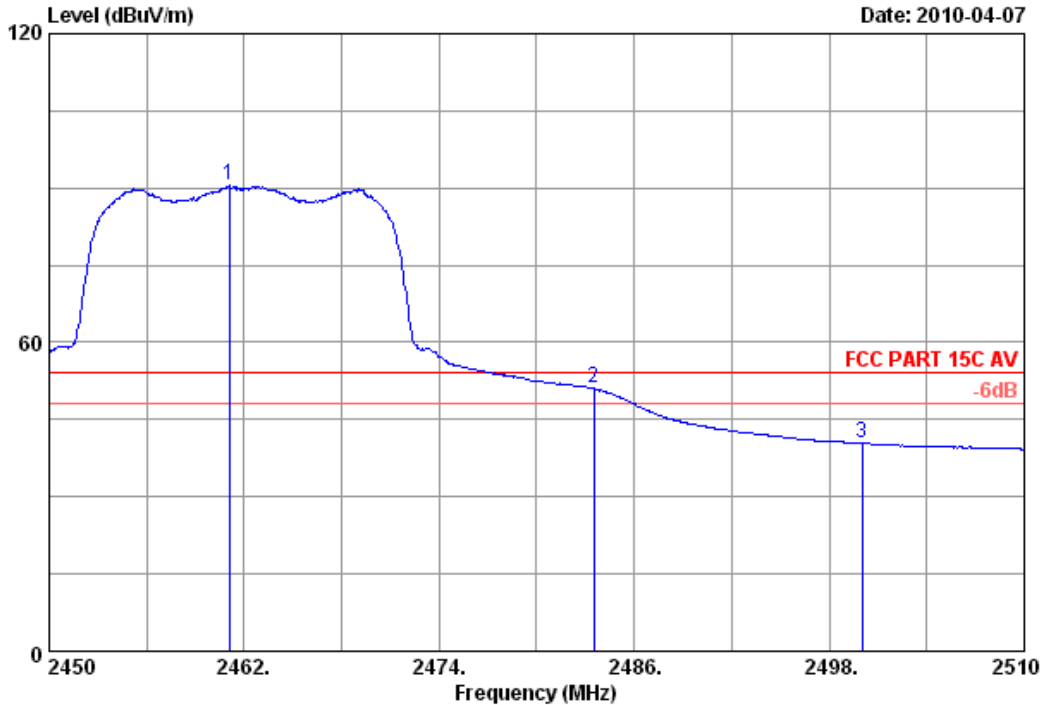

Site no. : 3m Chamber Data no. : 78
 Dis. / Ant. : 3m 3115(0911) Ant. pol. : VERTICAL
 Limit : FCC PART 15C AV
 Env. / Ins. : 23°C/54% Engineer : Paul
 EUT : Blu-ray Disc Player M/N:VBR220
 Power : DC 5V
 Test mode : Tx Mode 11nHT20 CH11 2462MHz

	Ant.	Cable	Amp.	Emission					
Freq.	Factor	loss	Factor	Reading	Level	Limits	Margin	Remark	
(MHz)	(dB/m)	(dB)	(dB)	(dBuV)	(dBuV/m)	(dBuV/m)	(dB)		
1 2461.100	29.48	8.82	36.02	88.19	90.47	54.00	-36.47	Average	
2 2483.500	29.49	8.87	35.97	48.71	51.10	54.00	2.90	Average	
3 2500.000	29.50	8.92	36.00	38.04	40.46	54.00	13.54	Average	

Remarks:

1. Emission Level= Antenna Factor + Cable Loss -Amp Factor + Reading.
2. The emission levels that are 20dB below the official limit are not reported.



No.6 Ke Feng Road,Block 52,
ShenZhen Science & Industry Park
Noutou,ShenZhen,GuangDong,China
Tel:+86-755-26639495-7
Fax:+86-755-26632877
Postcode:518057

Data: 81 File: E:\2010 report data\C\contel\ACS10Q0594R2.EM6 (108)

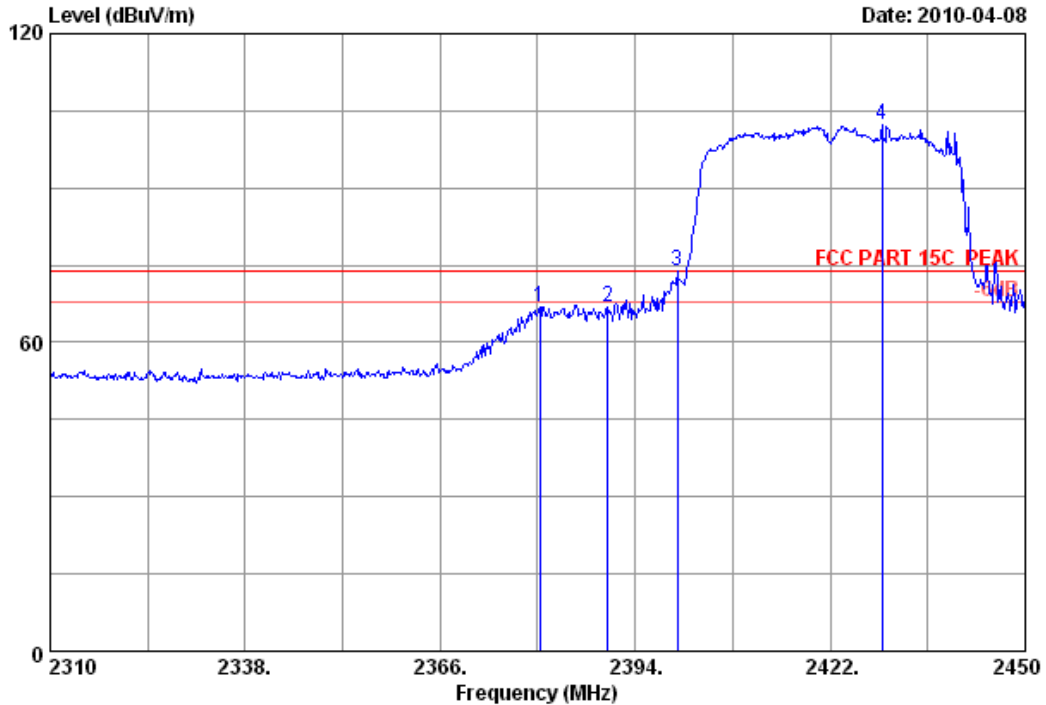

Site no. : 3m Chamber Data no. : 81
 Dis. / Ant. : 3m 3115(0911) Ant. pol. : VERTICAL
 Limit : FCC PART 15C PEAK
 Env. / Ins. : 23°C/54% Engineer : Paul
 EUT : Blu-ray Disc Player M/N:VBR220
 Power : DC 5V
 Test mode : Tx Mode 11nHT40 CH1 2422MHz

	Freq. (MHz)	Ant. Factor (dB/m)	Cable loss (dB)	Amp. Factor (dB)	Reading (dBuV)	Emission Level (dBuV/m)	Limits (dBuV/m)	Margin (dB)	Remark
1	2380.280	29.43	8.67	36.00	64.83	66.93	74.00	7.07	Peak
2	2390.000	29.44	8.67	36.09	64.69	66.71	74.00	7.29	Peak
3	2400.000	29.44	8.72	36.09	71.79	73.86	74.00	0.14	Peak
4	2429.420	29.46	8.77	36.01	100.07	102.29	74.00	-28.29	Peak

Remarks:

1. Emission Level= Antenna Factor + Cable Loss -Amp Factor + Reading.
2. The emission levels that are 20dB below the official limit are not reported.



No.6 Ke Feng Road,Block 52,
ShenZhen Science & Industry Park
Noutou,ShenZhen,GuangDong,China
Tel:+86-755-26639495-7
Fax:+86-755-26632877
Postcode:518057

Data: 82 File: E:\2010 report data\C\contel\ACS10Q0594R2.EM6 (108)

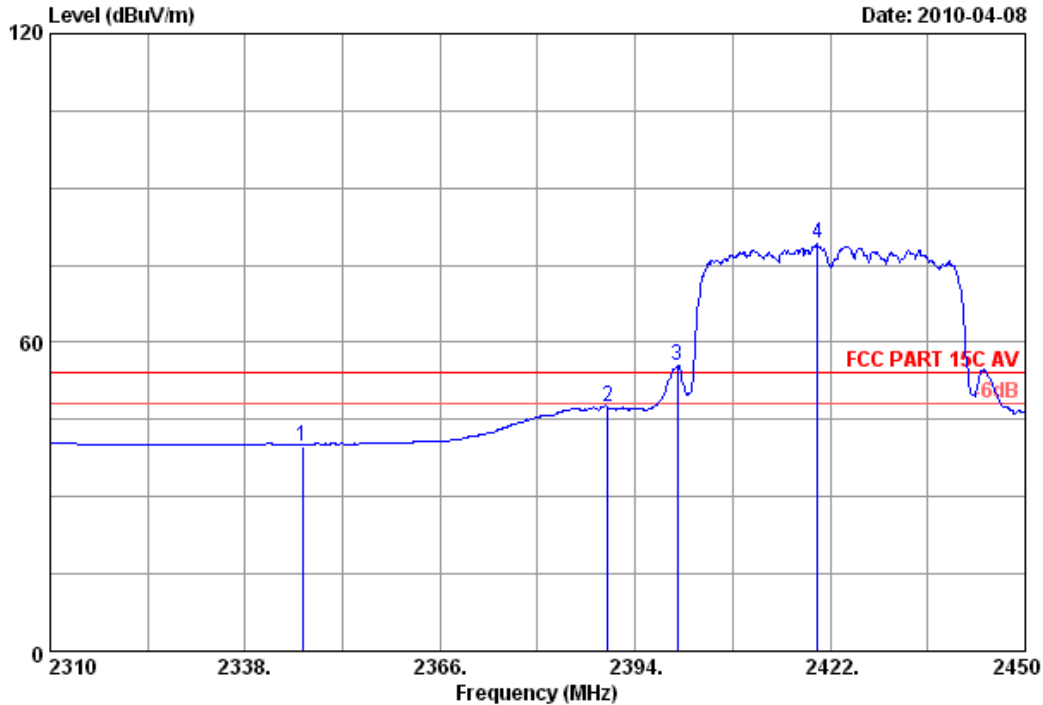

Site no. : 3m Chamber Data no. : 82
 Dis. / Ant. : 3m 3115(0911) Ant. pol. : VERTICAL
 Limit : FCC PART 15C AV
 Env. / Ins. : 23°C/54% Engineer : Paul
 EUT : Blu-ray Disc Player M/N:VBR220
 Power : DC 5V
 Test mode : Tx Mode 11nHT40 CH1 2422MHz

	Freq. (MHz)	Ant. Factor (dB/m)	Cable loss (dB)	Amp. Factor (dB)	Reading (dBuV)	Emission Level (dBuV/m)	Limits (dBuV/m)	Margin (dB)	Remark
1	2346.260	29.41	8.57	35.99	37.82	39.81	54.00	14.19	Average
2	2390.000	29.44	8.67	36.09	45.43	47.45	54.00	6.55	Average
3	2400.000	29.44	8.72	36.09	53.49	55.56	54.00	-1.56	Average
4	2420.180	29.46	8.72	36.01	76.91	79.08	54.00	-25.08	Average

Remarks:
 1. Emission Level= Antenna Factor + Cable Loss -Amp Factor + Reading.
 2. The emission levels that are 20dB below the official limit are not reported.



No.6 Ke Feng Road,Block 52,
ShenZhen Science & Industry Park
Noutou,ShenZhen,GuangDong,China
Tel:+86-755-26639495-7
Fax:+86-755-26632877
Postcode:518057

Data: 83 File: E:\2010 report data\C\contel\ACS10Q0594R2.EM6 (108)

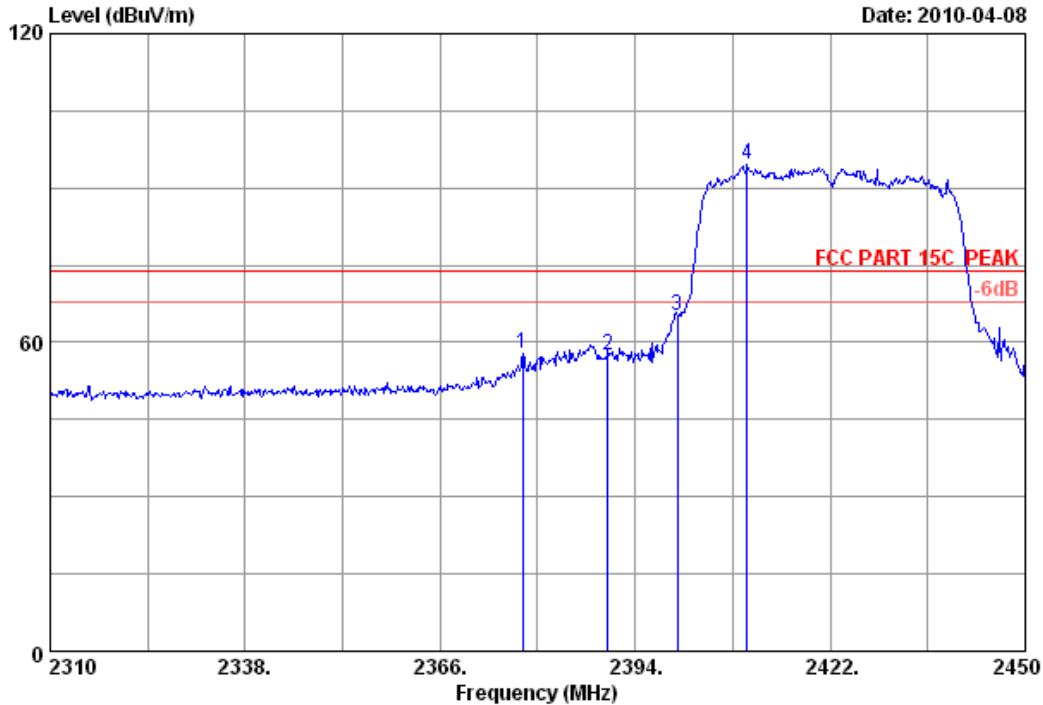

Site no. : 3m Chamber Data no. : 83
 Dis. / Ant. : 3m 3115(0911) Ant. pol. : HORIZONTAL
 Limit : FCC PART 15C PEAK
 Env. / Ins. : 23°C/54% Engineer : Paul
 EUT : Blu-ray Disc Player M/N:VBR220
 Power : DC 5V
 Test mode : Tx Mode 11nHT40 CH1 2422MHz

	Ant. Freq. (MHz)	Ant. Factor (dB/m)	Cable loss (dB)	Amp. Factor (dB)	Reading (dBuV)	Emission Level (dBuV/m)	Limits (dBuV/m)	Margin (dB)	Remark
1	2377.900	29.43	8.67	36.00	55.79	57.89	74.00	16.11	Peak
2	2390.000	29.44	8.67	36.09	55.58	57.60	74.00	16.40	Peak
3	2400.000	29.44	8.72	36.09	63.03	65.10	74.00	8.90	Peak
4	2410.100	29.45	8.72	35.95	92.36	94.58	74.00	-20.58	Peak

Remarks:
 1. Emission Level= Antenna Factor + Cable Loss -Amp Factor + Reading.
 2. The emission levels that are 20dB below the official limit are not reported.



No.6 Ke Feng Road,Block 52,
ShenZhen Science & Industry Park
Noutou,ShenZhen,GuangDong,China
Tel:+86-755-26639495-7
Fax:+86-755-26632877
Postcode:518057

Data: 84 File: E:\2010 report data\C\contel\ACS10Q0594R2.EM6 (108)

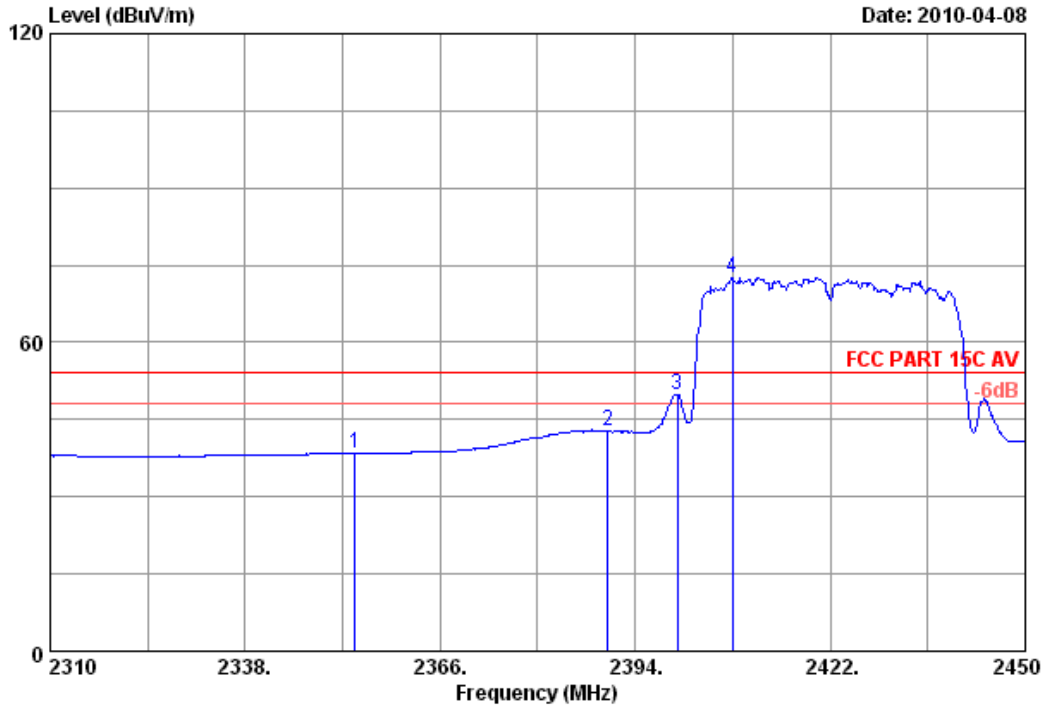

Site no. : 3m Chamber Data no. : 84
 Dis. / Ant. : 3m 3115(0911) Ant. pol. : HORIZONTAL
 Limit : FCC PART 15C AV
 Env. / Ins. : 23°C/54% Engineer : Paul
 EUT : Blu-ray Disc Player M/N:VBR220
 Power : DC 5V
 Test mode : Tx Mode 11nHT40 CH1 2422MHz

	Freq. (MHz)	Ant. Factor (dB/m)	Cable loss (dB)	Amp. Factor (dB)	Reading (dBuV)	Emission Level (dBuV/m)	Limits (dBuV/m)	Margin (dB)	Remark
1	2353.820	29.42	8.62	35.91	36.30	38.43	54.00	15.57	Average
2	2390.000	29.44	8.67	36.09	40.84	42.86	54.00	11.14	Average
3	2400.000	29.44	8.72	36.09	47.87	49.94	54.00	4.06	Average
4	2408.000	29.45	8.72	35.95	70.40	72.62	54.00	-18.62	Average

Remarks:

1. Emission Level= Antenna Factor + Cable Loss -Amp Factor + Reading.
2. The emission levels that are 20dB below the official limit are not reported.



No.6 Ke Feng Road,Block 52,
ShenZhen Science & Industry Park
Noutou,ShenZhen,GuangDong,China
Tel:+86-755-26639495-7
Fax:+86-755-26632877
Postcode:518057

Data: 97 File: E:\2010 report data\C\contel\ACS10Q0594R2.EM6 (108)

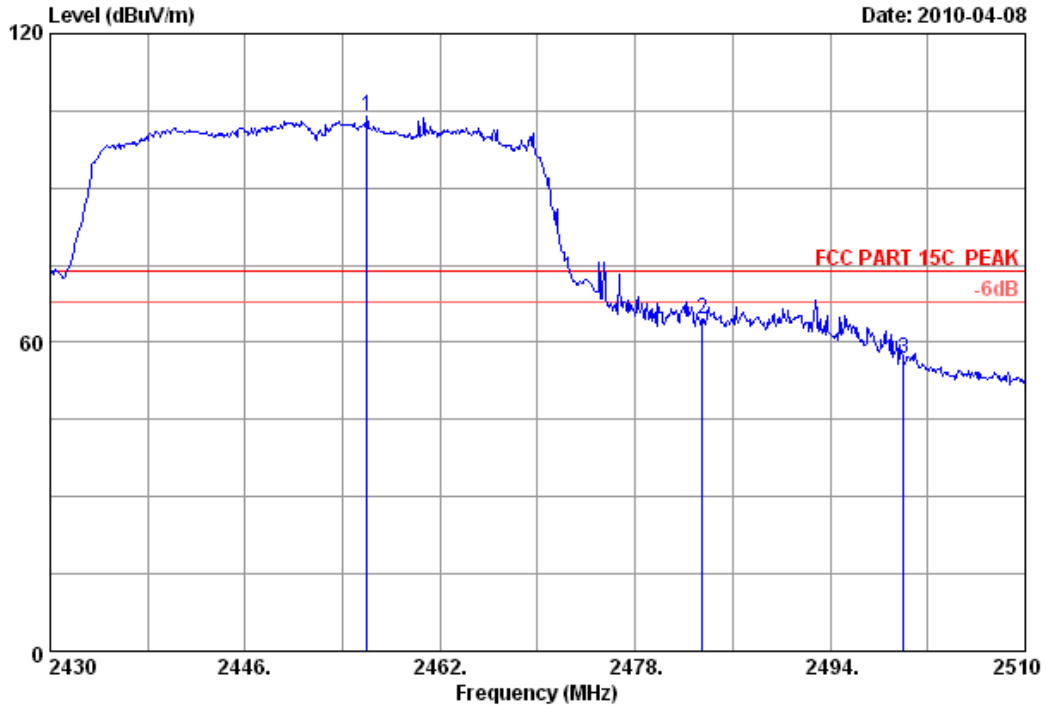

Site no. : 3m Chamber Data no. : 97
 Dis. / Ant. : 3m 3115(0911) Ant. pol. : VERTICAL
 Limit : FCC PART 15C PEAK
 Env. / Ins. : 23°C/54% Engineer : Paul
 EUT : Blu-ray Disc Player M/N:VBR220
 Power : DC 5V
 Test mode : Tx Mode 11nHT40 CH7 2452MHz

	Freq. (MHz)	Ant. Factor (dB/m)	Cable loss (dB)	Amp. Factor (dB)	Reading (dBuV)	Emission Level (dBuV/m)	Limits (dBuV/m)	Margin (dB)	Remark
1	2456.000	29.48	8.82	36.02	101.73	104.01	74.00	-30.01	Peak
2	2483.500	29.49	8.87	35.97	62.18	64.57	74.00	9.43	Peak
3	2500.000	29.50	8.92	36.00	54.42	56.84	74.00	17.16	Peak

Remarks:

1. Emission Level= Antenna Factor + Cable Loss -Amp Factor + Reading.
2. The emission levels that are 20dB below the official limit are not reported.



No.6 Ke Feng Road,Block 52,
ShenZhen Science & Industry Park
Noutou,ShenZhen,GuangDong,China
Tel:+86-755-26639495-7
Fax:+86-755-26632877
Postcode:518057

Data: 98

File: E:\2010 report data\C\contel\ACS10Q0594R2.EM6 (108)

Date: 2010-04-08

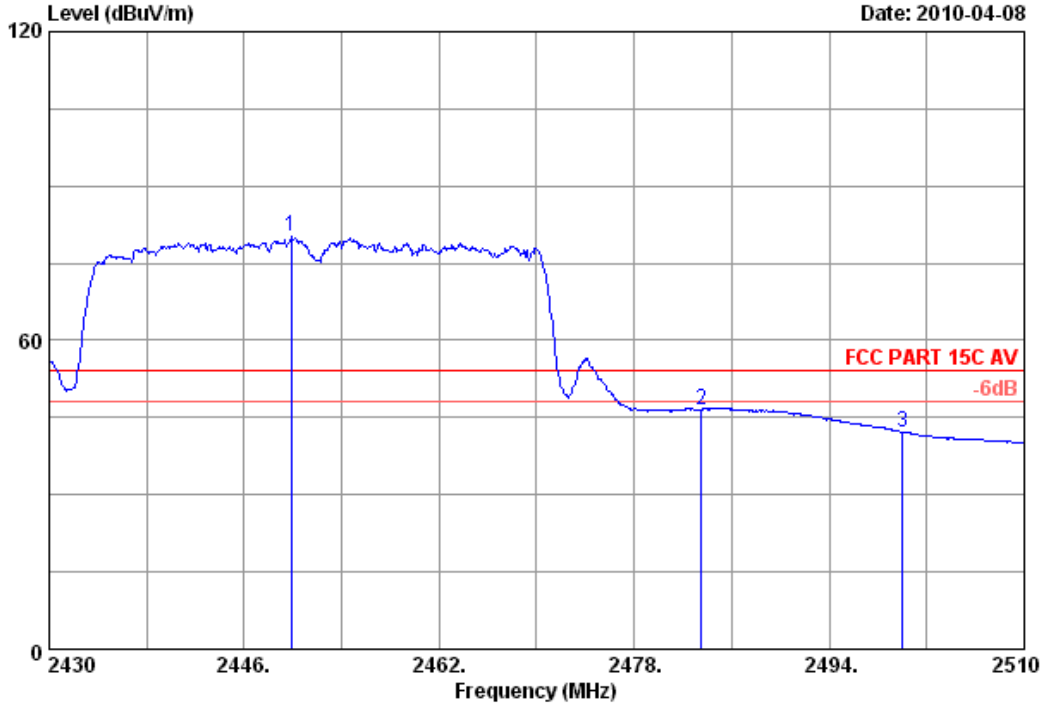

Site no. : 3m Chamber Data no. : 98
 Dis. / Ant. : 3m 3115(0911) Ant. pol. : VERTICAL
 Limit : FCC PART 15C AV
 Env. / Ins. : 23°C/54% Engineer : Paul
 EUT : Blu-ray Disc Player M/N:VBR220
 Power : DC 5V
 Test mode : Tx Mode 11nHT40 CH7 2452MHz

	Ant.	Cable	Amp.	Emission					
Freq.	Factor	loss	Factor	Reading	Level	Limits	Margin	Remark	
(MHz)	(dB/m)	(dB)	(dB)	(dBuV)	(dBuV/m)	(dBuV/m)	(dB)		
1 2449.840	29.47	8.82	36.06	77.86	80.09	54.00	-26.09	Average	
2 2483.500	29.49	8.87	35.97	44.21	46.60	54.00	7.40	Average	
3 2500.000	29.50	8.92	36.00	39.75	42.17	54.00	11.83	Average	

Remarks:

1. Emission Level= Antenna Factor + Cable Loss -Amp Factor + Reading.
2. The emission levels that are 20dB below the official limit are not reported.



No.6 Ke Feng Road,Block 52,
Shenzhen Science & Industry Park
Noutou,Shenzhen,GuangDong,China
Tel:+86-755-26639495-7
Fax:+86-755-26632877
Postcode:518057

Data: 99

File: E:\2010 report data\C\contel\ACS10Q0594R2.EM6 (108)

Date: 2010-04-08

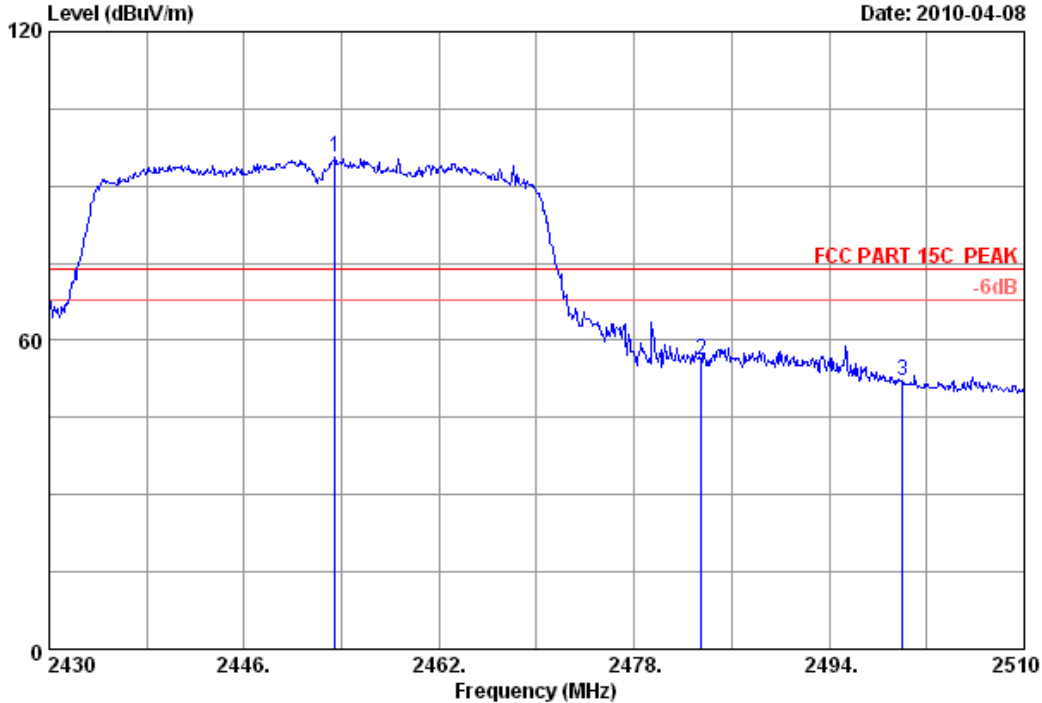

Site no. : 3m Chamber Data no. : 99
 Dis. / Ant. : 3m 3115(0911) Ant. pol. : HORIZONTAL
 Limit : FCC PART 15C PEAK
 Env. / Ins. : 23°C/54% Engineer : Paul
 EUT : Blu-ray Disc Player M/N:VBR220
 Power : DC 5V
 Test mode : Tx Mode 11nHT40 CH7 2452MHz

	Ant. Freq. (MHz)	Ant. Factor (dB/m)	Cable loss (dB)	Amp. Factor (dB)	Reading (dBuV)	Emission Level (dBuV/m)	Limits (dBuV/m)	Margin (dB)	Remark
1	2453.440	29.47	8.82	36.06	93.20	95.43	74.00	-21.43	Peak
2	2483.500	29.49	8.87	35.97	53.85	56.24	74.00	17.76	Peak
3	2500.000	29.50	8.92	36.00	49.79	52.21	74.00	21.79	Peak

Remarks:

1. Emission Level= Antenna Factor + Cable Loss -Amp Factor + Reading.
2. The emission levels that are 20dB below the official limit are not reported.



No.6 Ke Feng Road,Block 52,
ShenZhen Science & Industry Park
Noutou,ShenZhen,GuangDong,China
Tel:+86-755-26639495-7
Fax:+86-755-26632877
Postcode:518057

Data: 100 File: E:\2010 report data\C\contel\ACS10Q0594R2.EM6 (108)

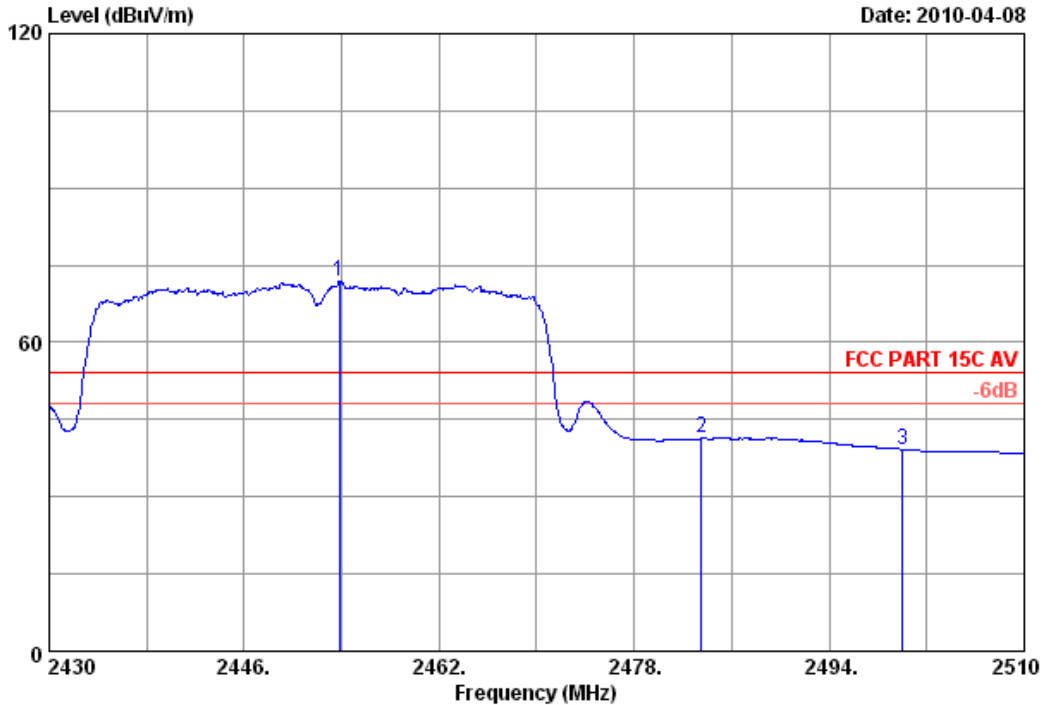

Site no. : 3m Chamber Data no. : 100
 Dis. / Ant. : 3m 3115(0911) Ant. pol. : HORIZONTAL
 Limit : FCC PART 15C AV
 Env. / Ins. : 23°C/54% Engineer : Paul
 EUT : Blu-ray Disc Player M/N:VBR220
 Power : DC 5V
 Test mode : Tx Mode 11nHT40 CH7 2452MHz

	Freq. (MHz)	Ant. Factor (dB/m)	Cable loss (dB)	Amp. Factor (dB)	Reading (dBuV)	Emission Level (dBuV/m)	Limits (dBuV/m)	Margin (dB)	Remark
1	2453.840	29.48	8.82	36.02	69.58	71.86	54.00	-17.86	Average
2	2483.500	29.49	8.87	35.97	38.90	41.29	54.00	12.71	Average
3	2500.000	29.50	8.92	36.00	36.82	39.24	54.00	14.76	Average

Remarks:

1. Emission Level= Antenna Factor + Cable Loss -Amp Factor + Reading.
2. The emission levels that are 20dB below the official limit are not reported.

7. 6dB Bandwidth Test

7.1. Test Equipment

Item	Equipment	Manufacturer	Model No.	Serial No.	Last Cal.	Cal. Interval
1.	Spectrum Analyzer	Agilent	E4446A	US44300459	May.08, 09	1 Year
2.	Attenuator	Agilent	8491B	MY39262165	May.08, 09	1 Year
3.	RF Cable	Hubersuhner	SUCOFLEX 102	28618/2	May.08, 09	1Year

7.2. Limit

For direct sequence systems, the minimum 6dB bandwidth shall be at least 500kHz

7.3. Test Procedure

The transmitter output was connected to a spectrum analyzer, The bandwidth of the fundamental frequency was measured by spectrum analyzer with 100kHz RBW and 300 kHz VBW. The 6dB bandwidth is defined as the total spectrum the power of which is higher than peak power minus 6dB.

7.4. Test Results

EUT: Blu-ray Disc Player		
M/N: VBR220		
Test date: 2010-04-01	Pressure:100.6 kpa	Humidity:60%
Tested by: Sunny-lu	Test site: RF site	Temperature : 25°C

Test Mode	CH	Result		Limit (KHz)
		Chain 1 6dB bandwidth (MHz)	Chain 2 6dB bandwidth (MHz)	
11b	CH1	8.172	8.154	>500
	CH6	8.126	8.134	>500
	CH11	8.146	8.093	>500
11g	CH1	16.169	15.531	>500
	CH6	16.195	15.151	>500
	CH11	15.526	16.335	>500
11n HT20	CH1	16.367	16.038	>500
	CH6	15.852	15.195	>500
	CH11	15.782	15.743	>500
11n HT40	CH1	32.702	32.544	>500
	CH4	35.233	35.193	>500
	CH7	35.151	30.151	>500
Conclusion : PASS				

Chain 1:

Test Mode: IEEE 802.11b TX

Test CH1: 2412MHz

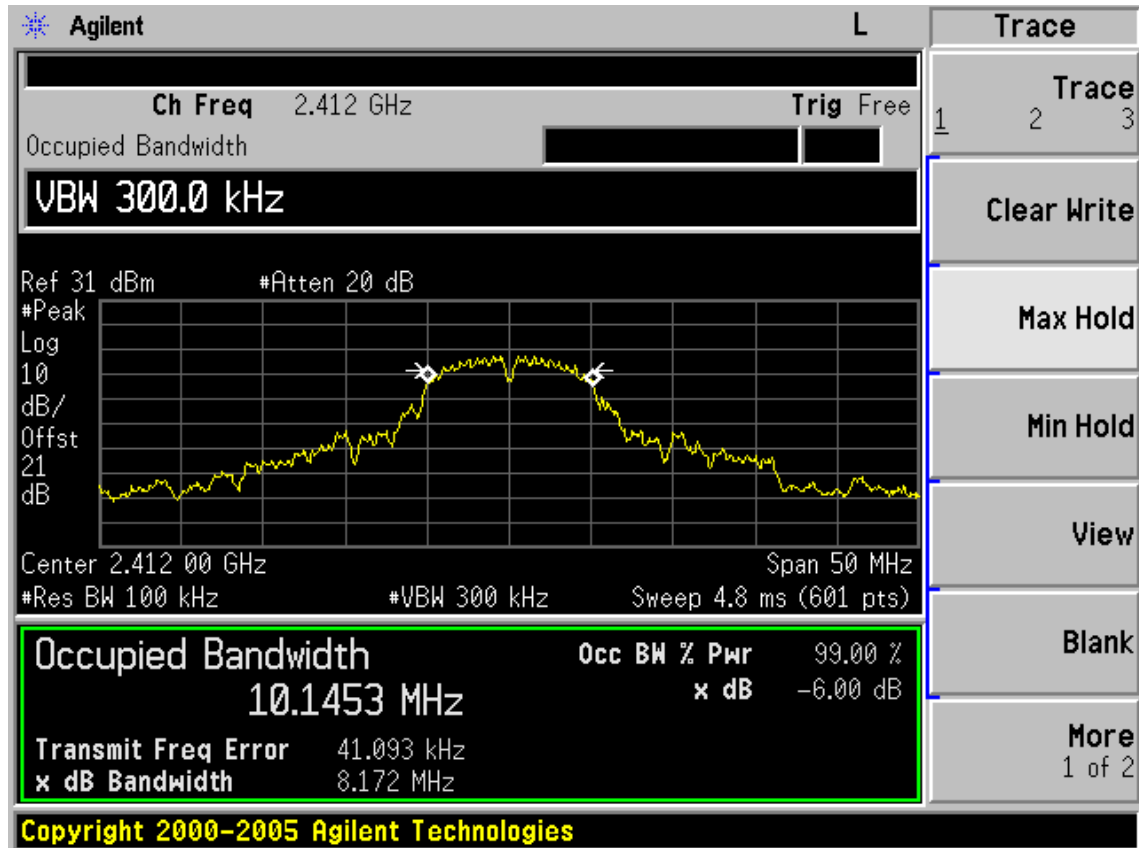

Test CH6: 2437MHz

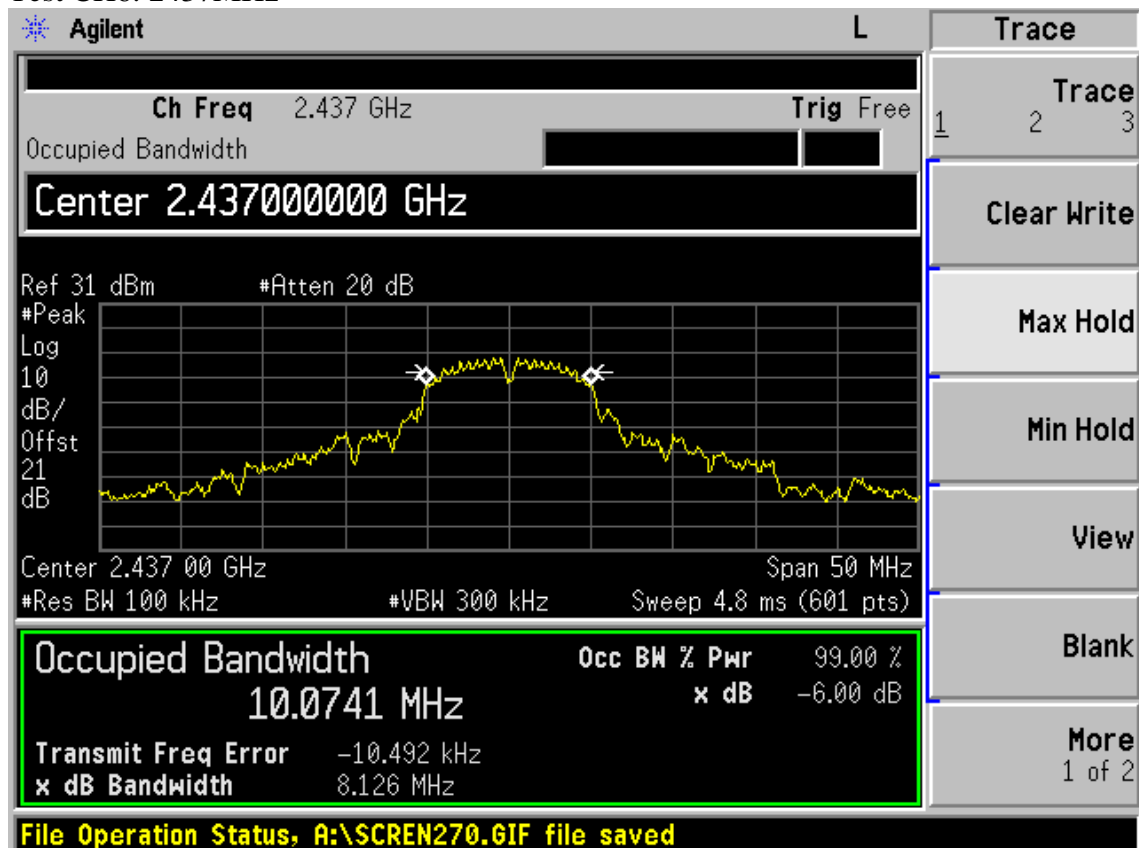

Test CH1: 2462MHz

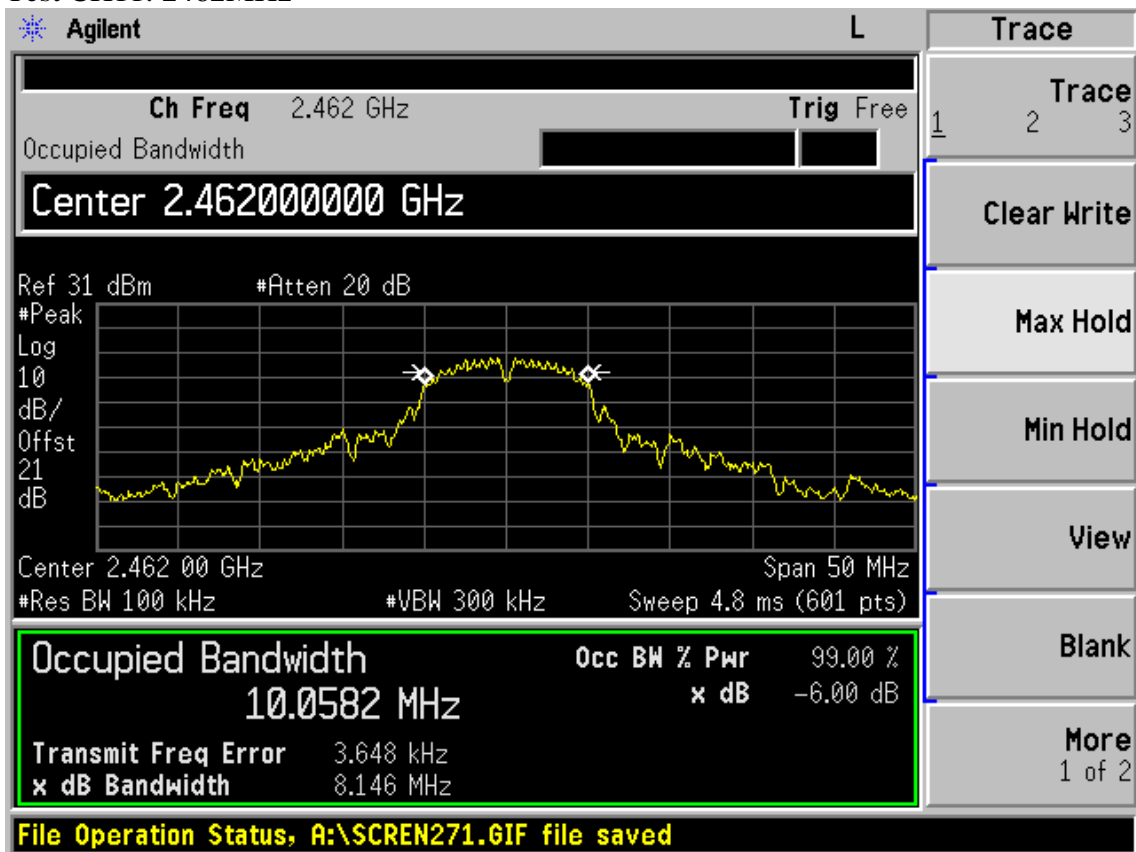

Test Mode: IEEE 802.11g TX

Test CH1: 2412MHz

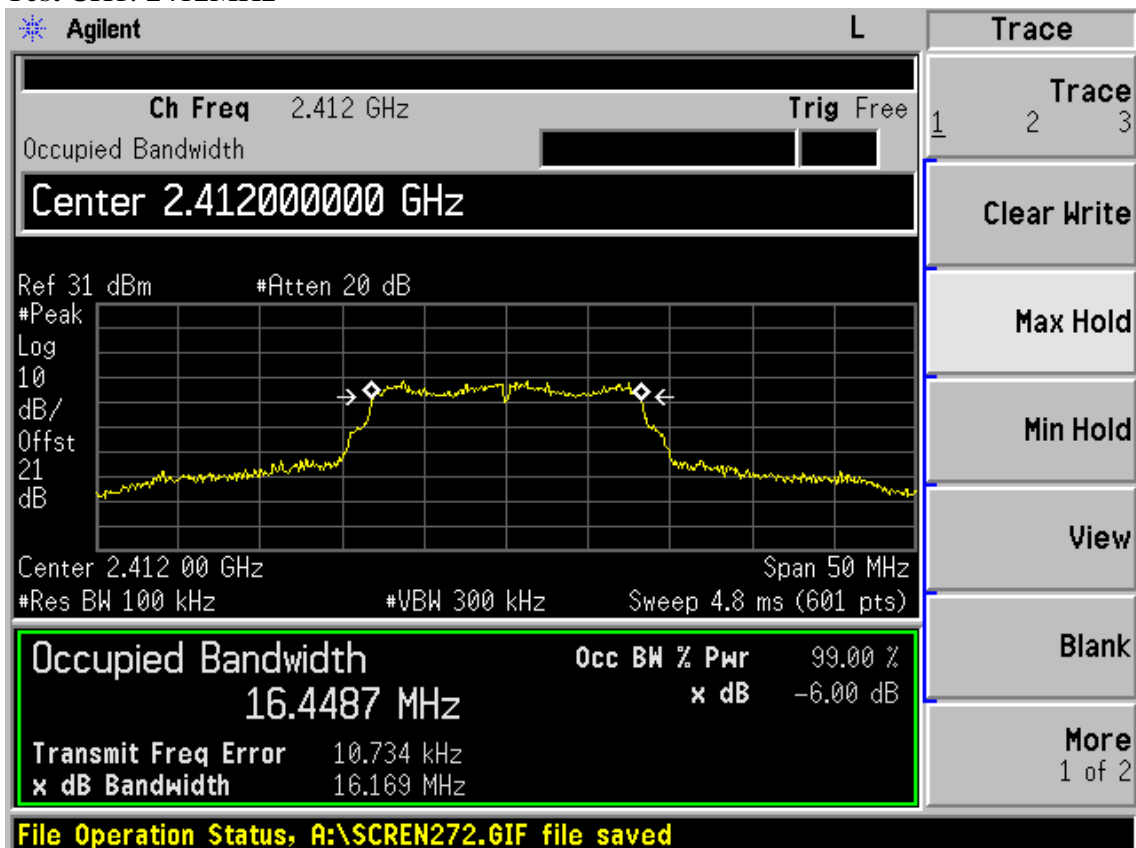

Test CH6: 2437MHz

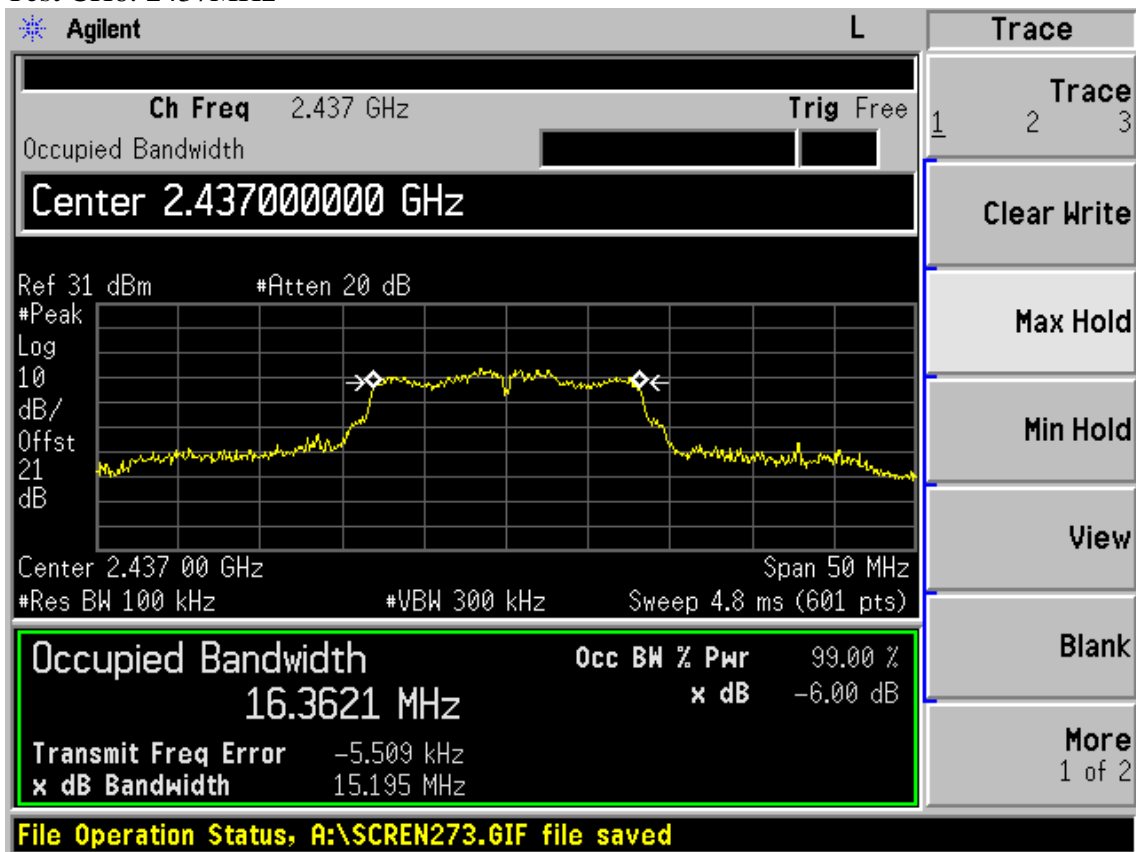

Test CH11: 2462MHz

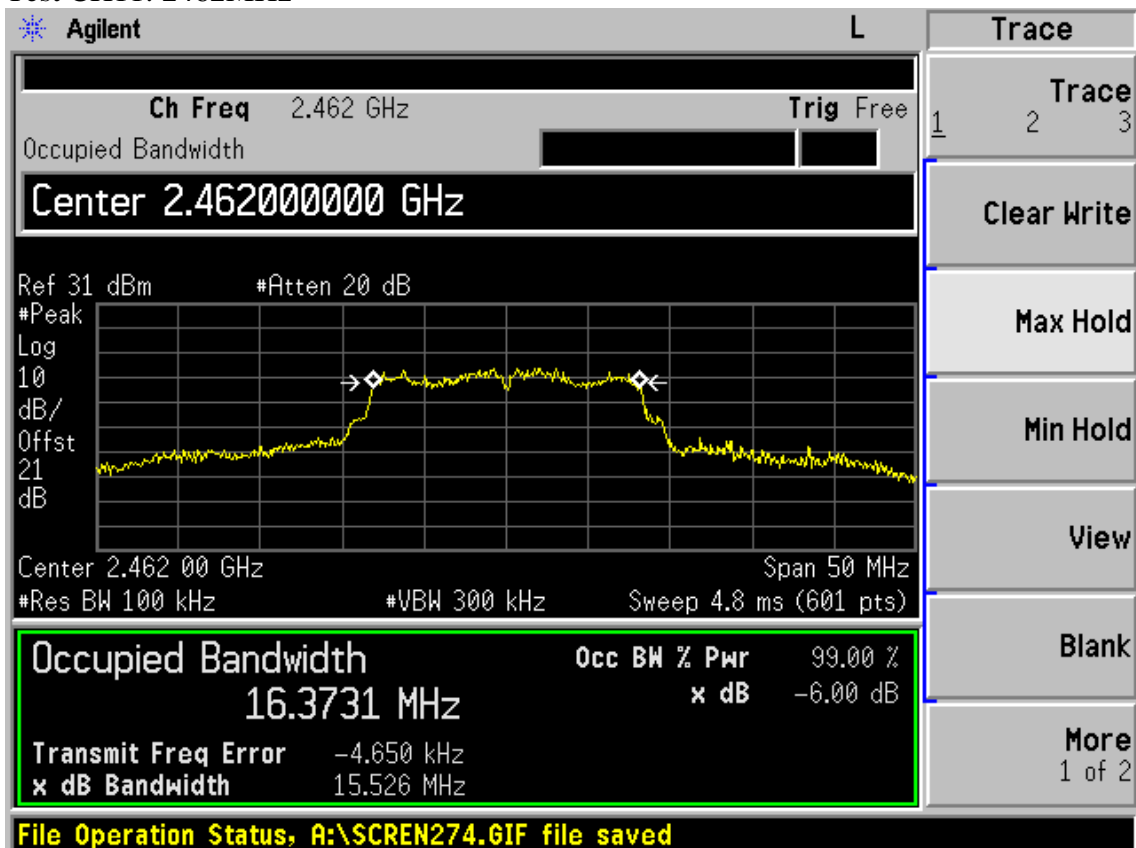

Test Mode: IEEE 802.11n HT20 TX

Test CH1: 2412MHz

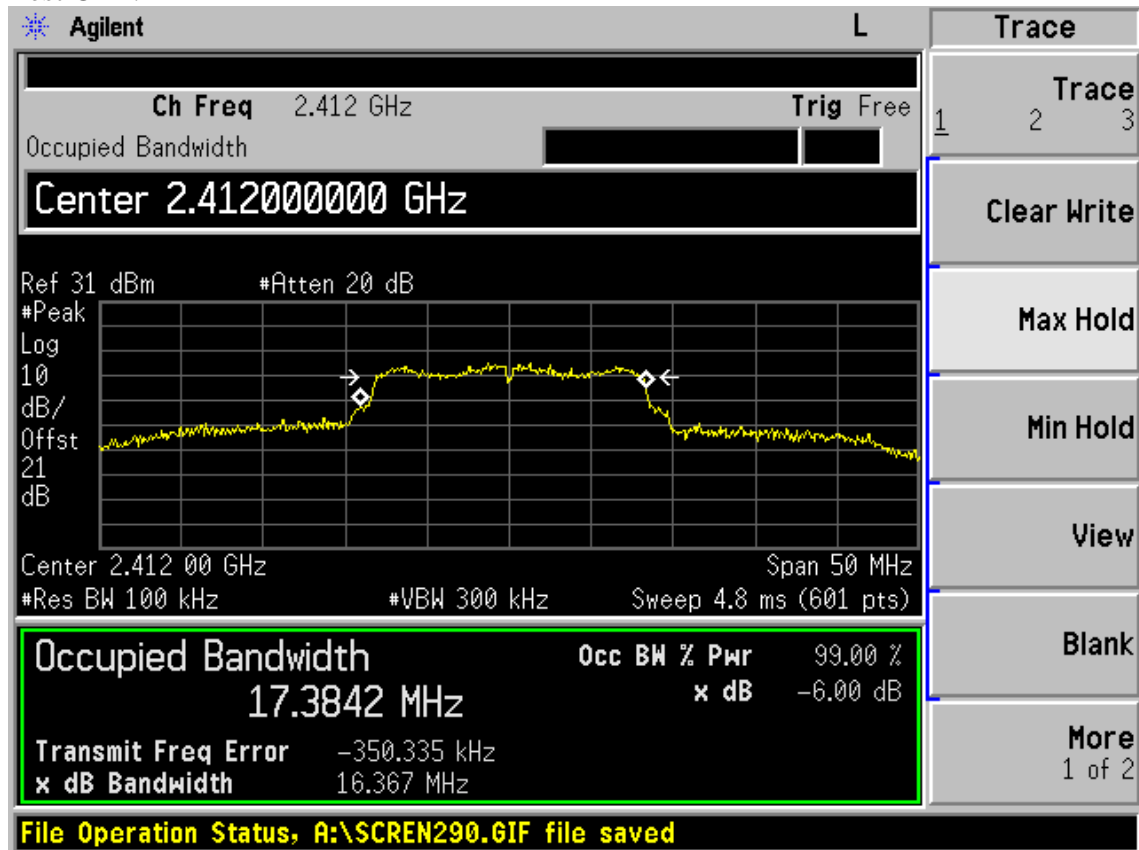

Test CH6: 2437MHz

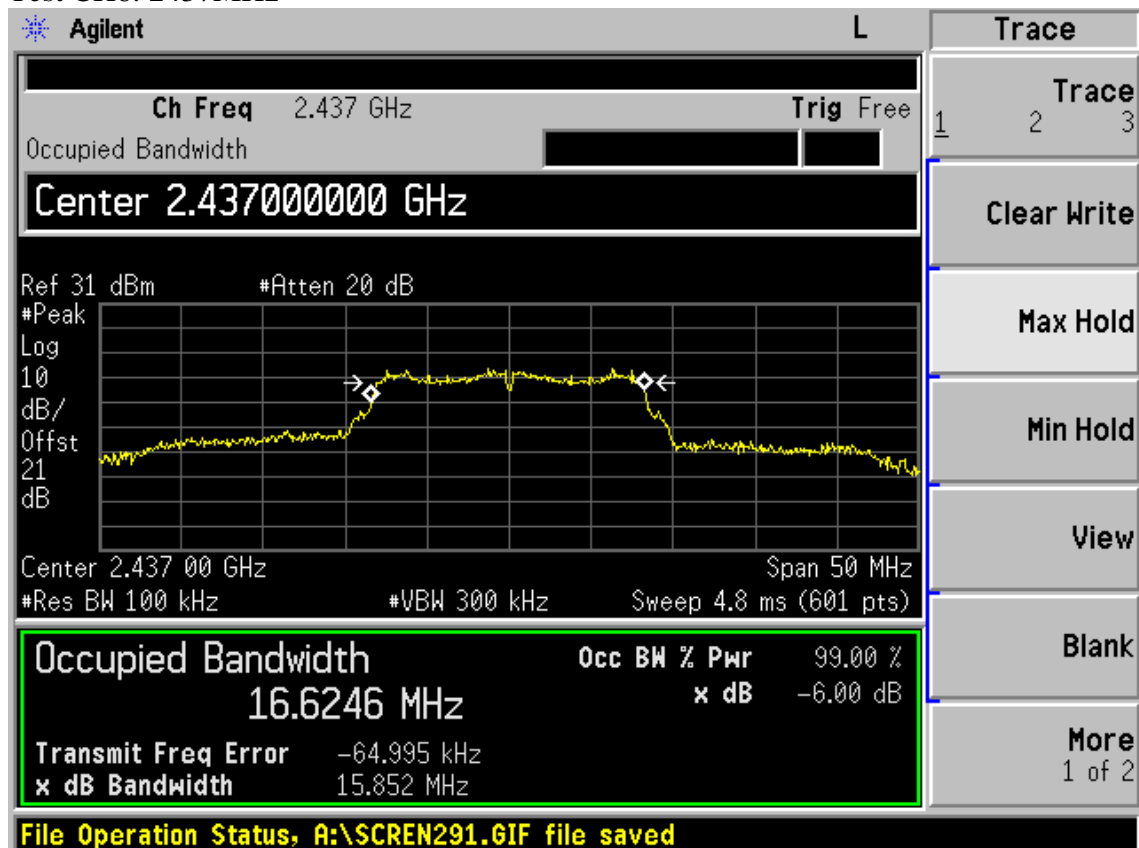

Test CH1: 2462MHz

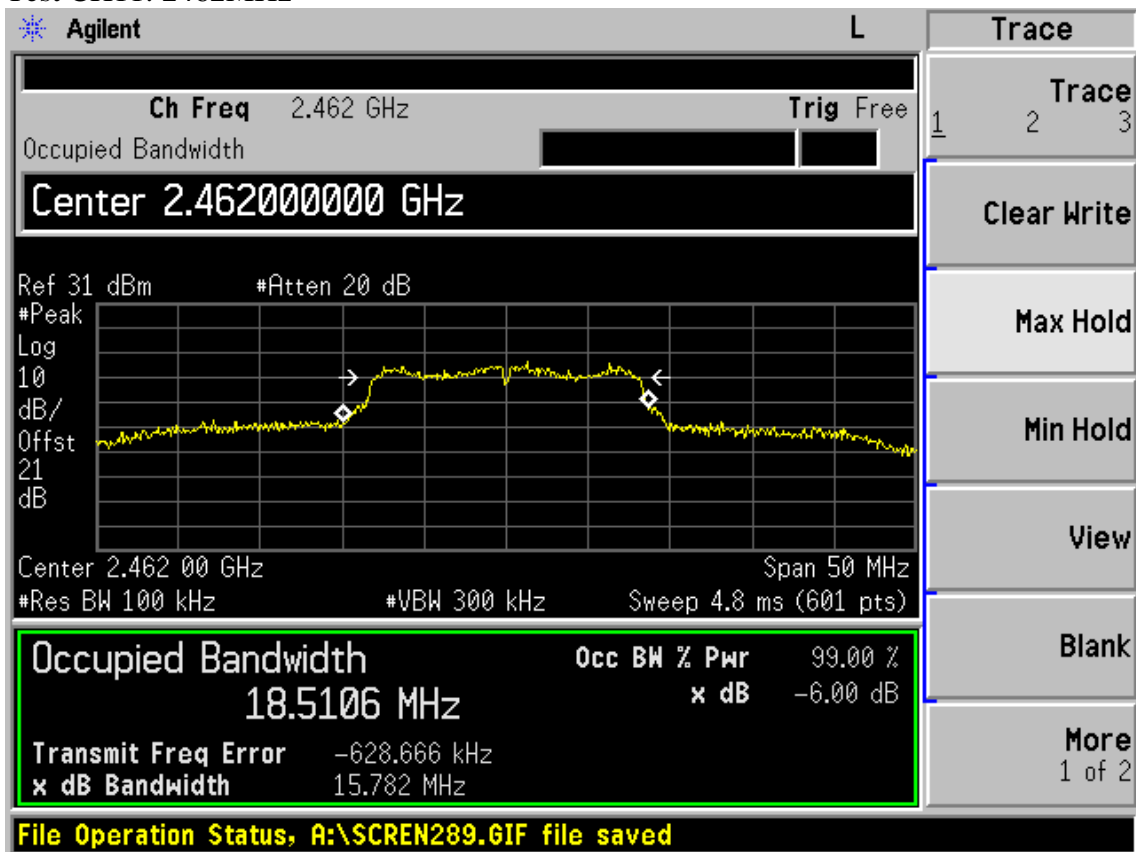

Test Mode: IEEE 802.11n HT40 TX

Test CH1: 2422MHz

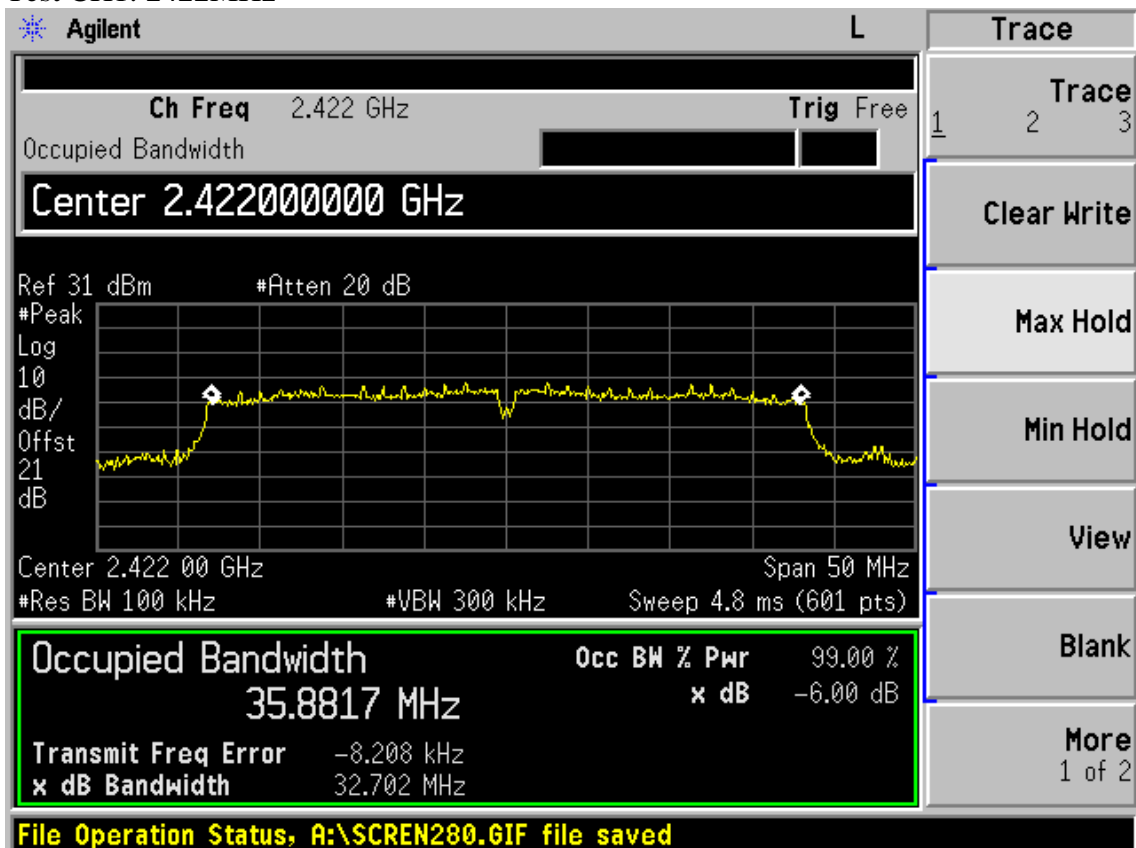

Test CH4: 2437MHz

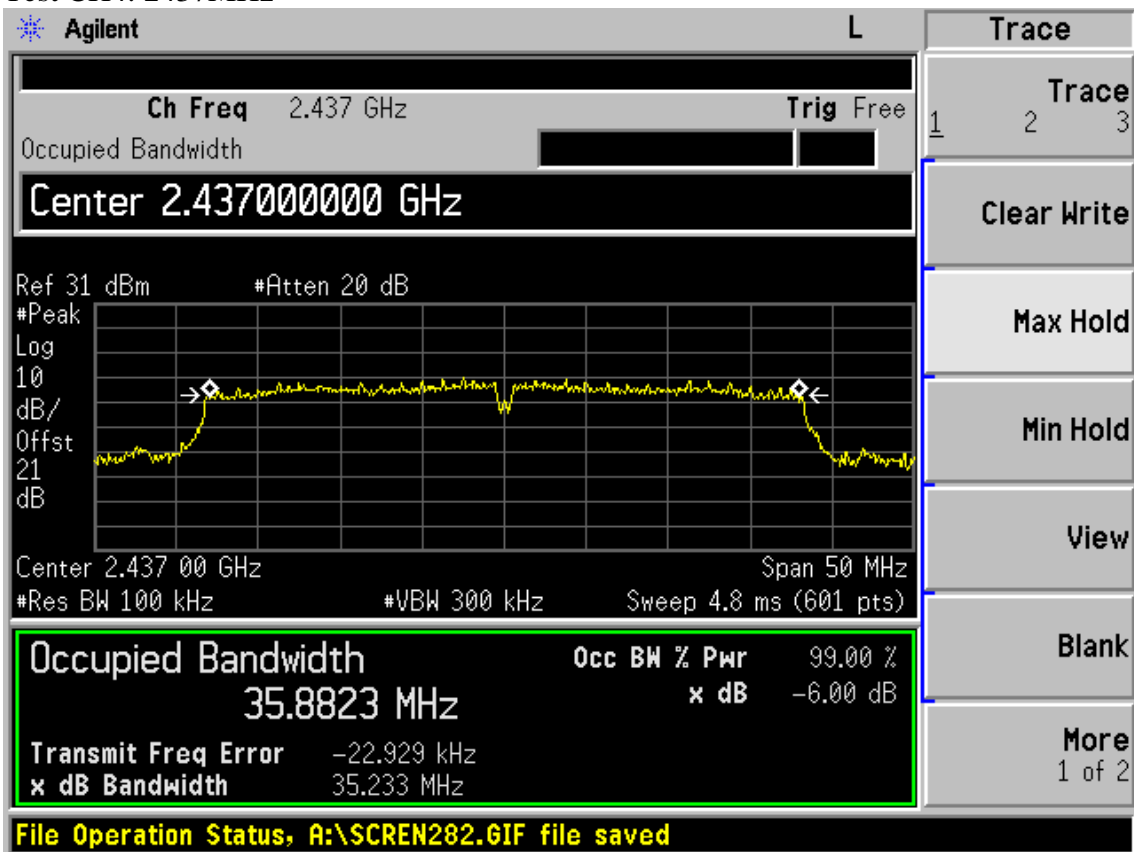

Test CH7: 2452MHz

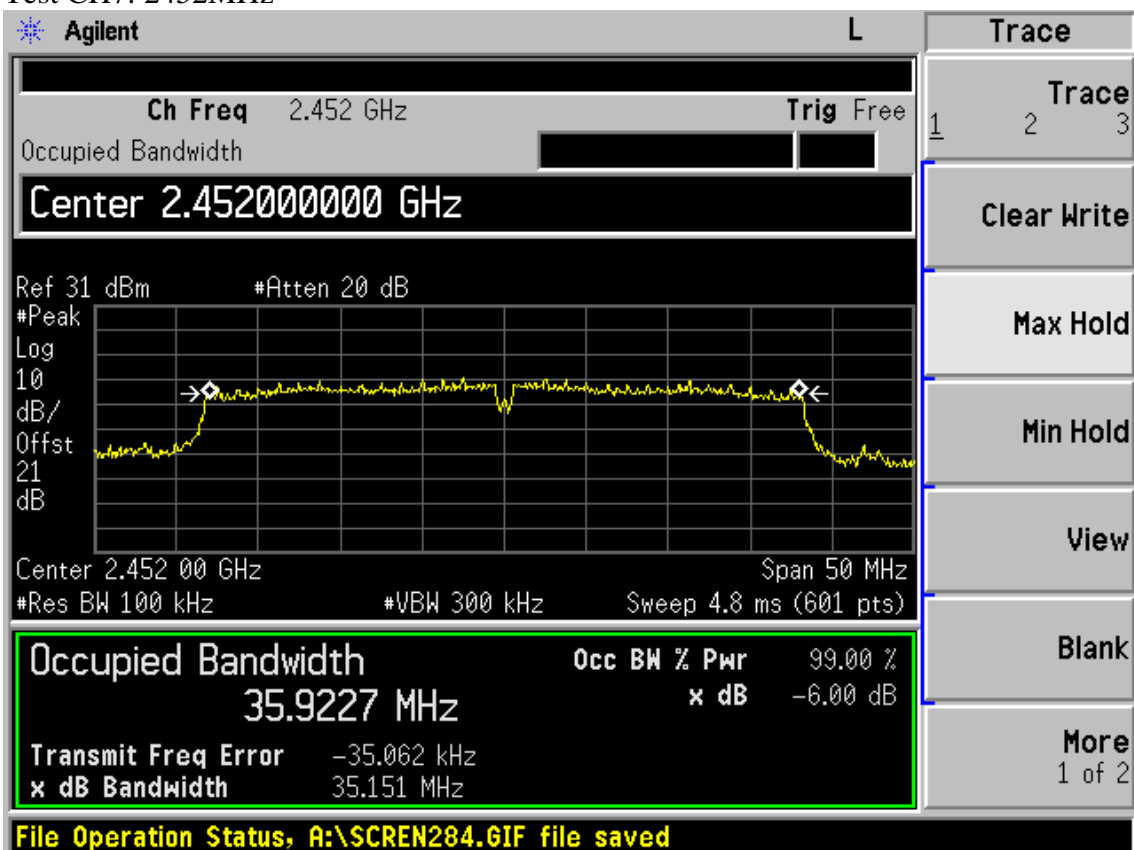

Chain 2:

Test Mode: IEEE 802.11b TX

Test CH1: 2412MHz

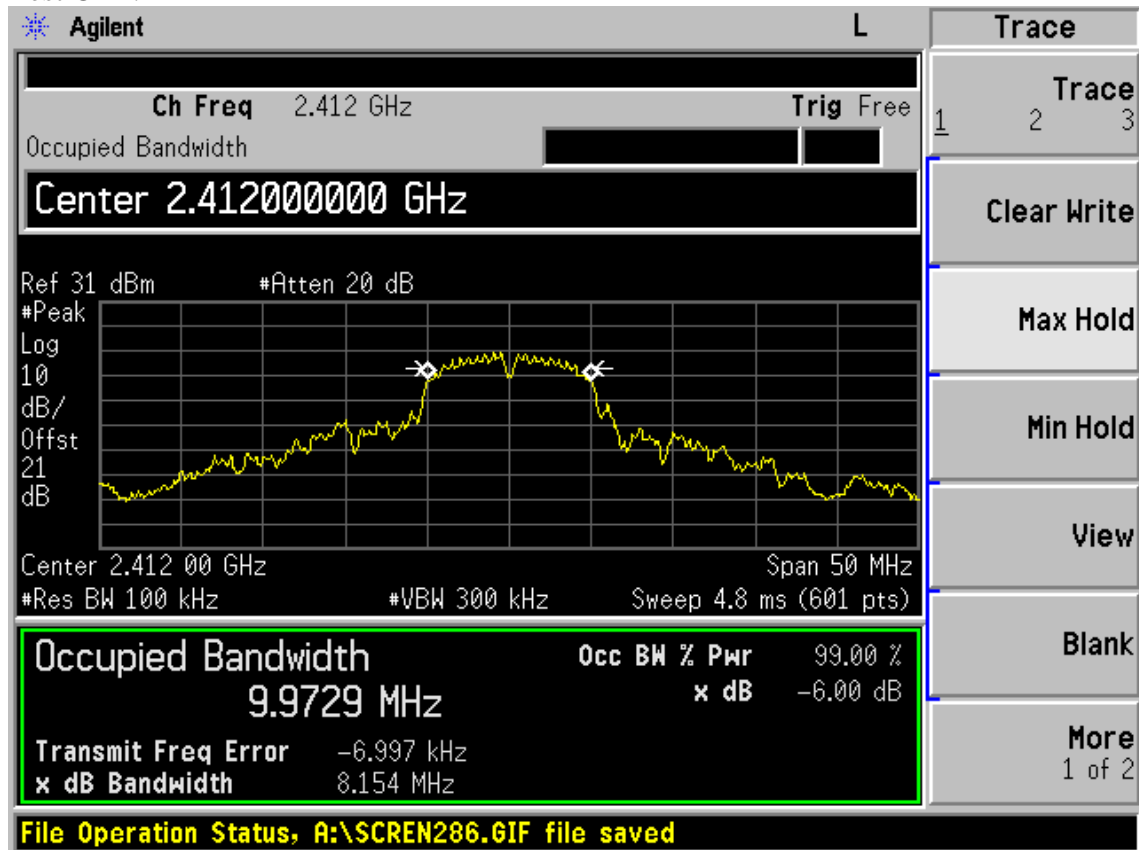

Test CH6: 2437MHz

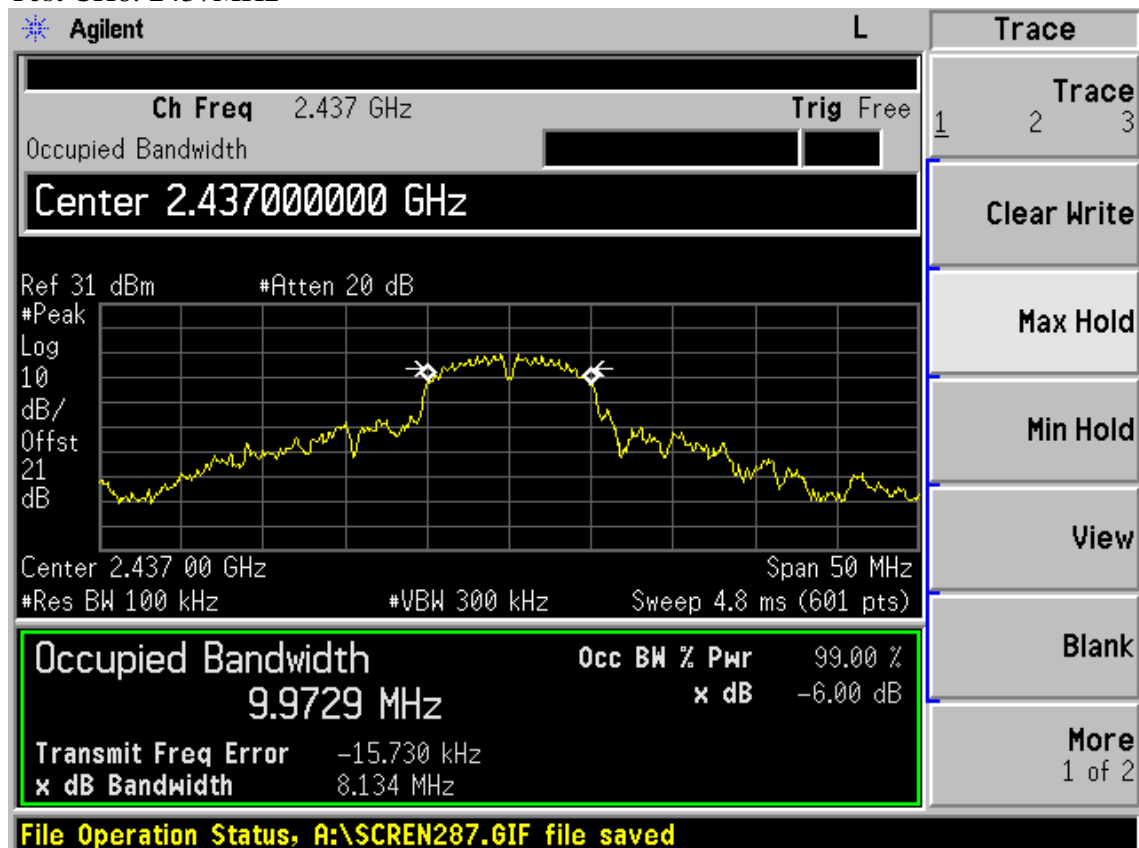

Test CH1: 2462MHz

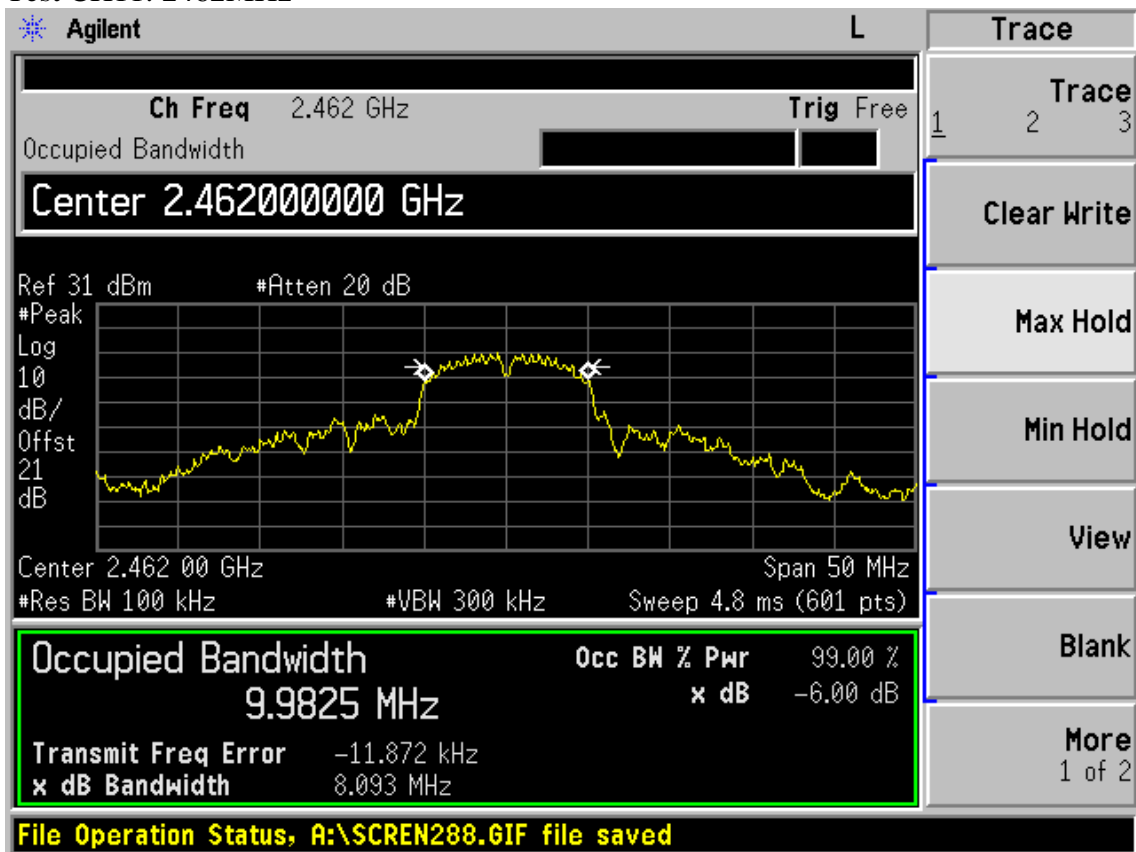

Test Mode: IEEE 802.11g TX

Test CH1: 2412MHz

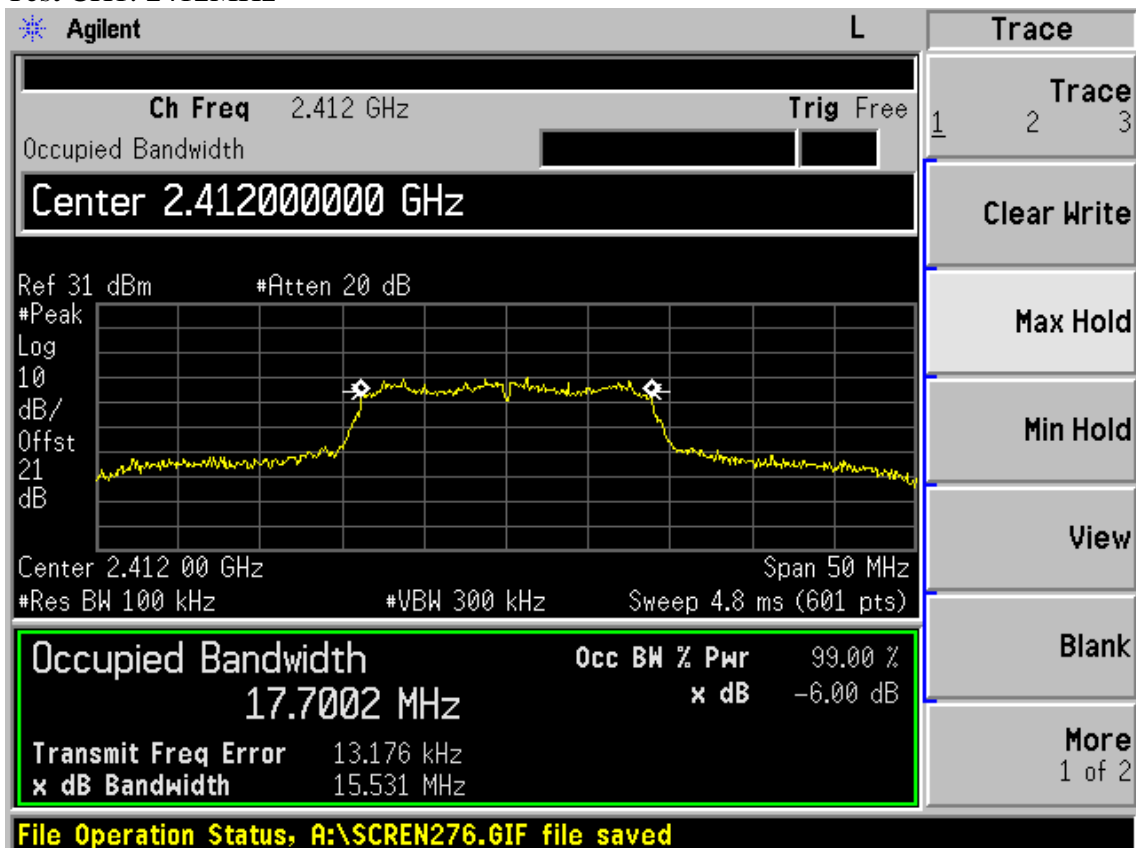

Test CH6: 2437MHz

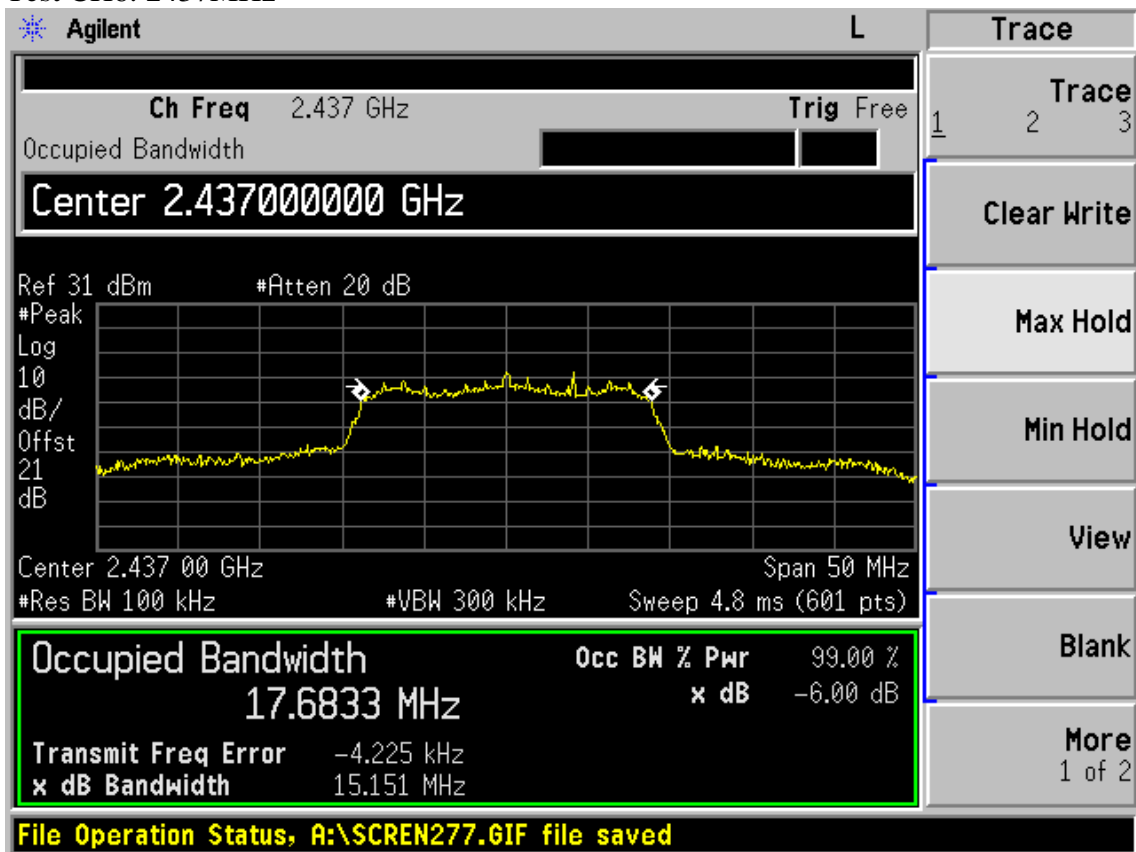

Test CH11: 2462MHz

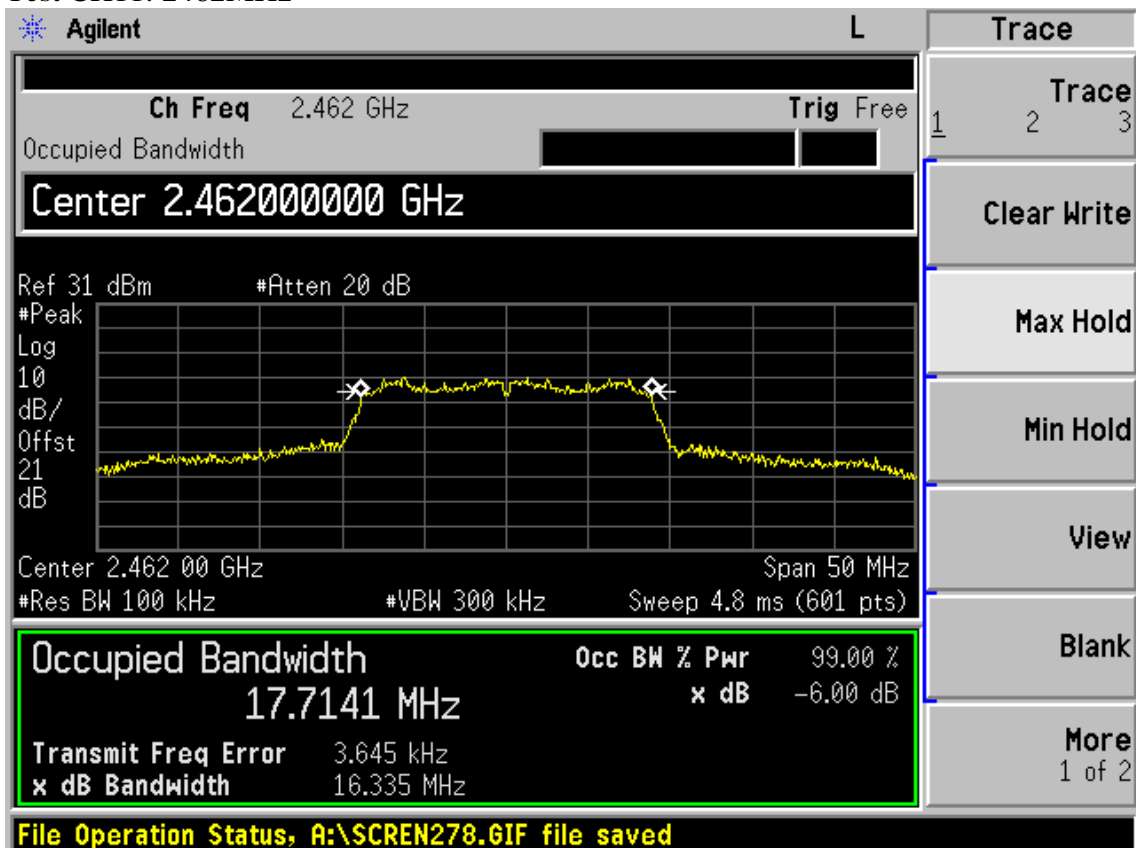

Test Mode: IEEE 802.11n HT20 TX

Test CH1: 2412MHz

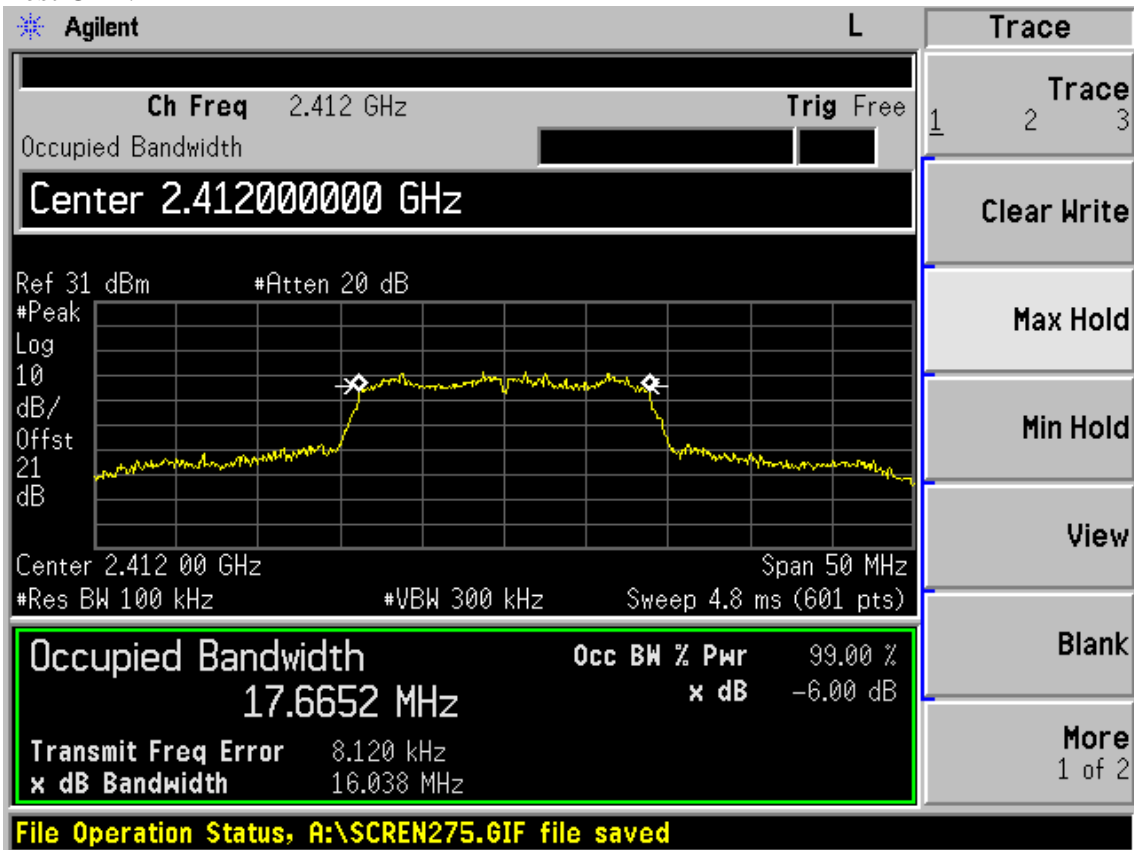

Test CH6: 2437MHz

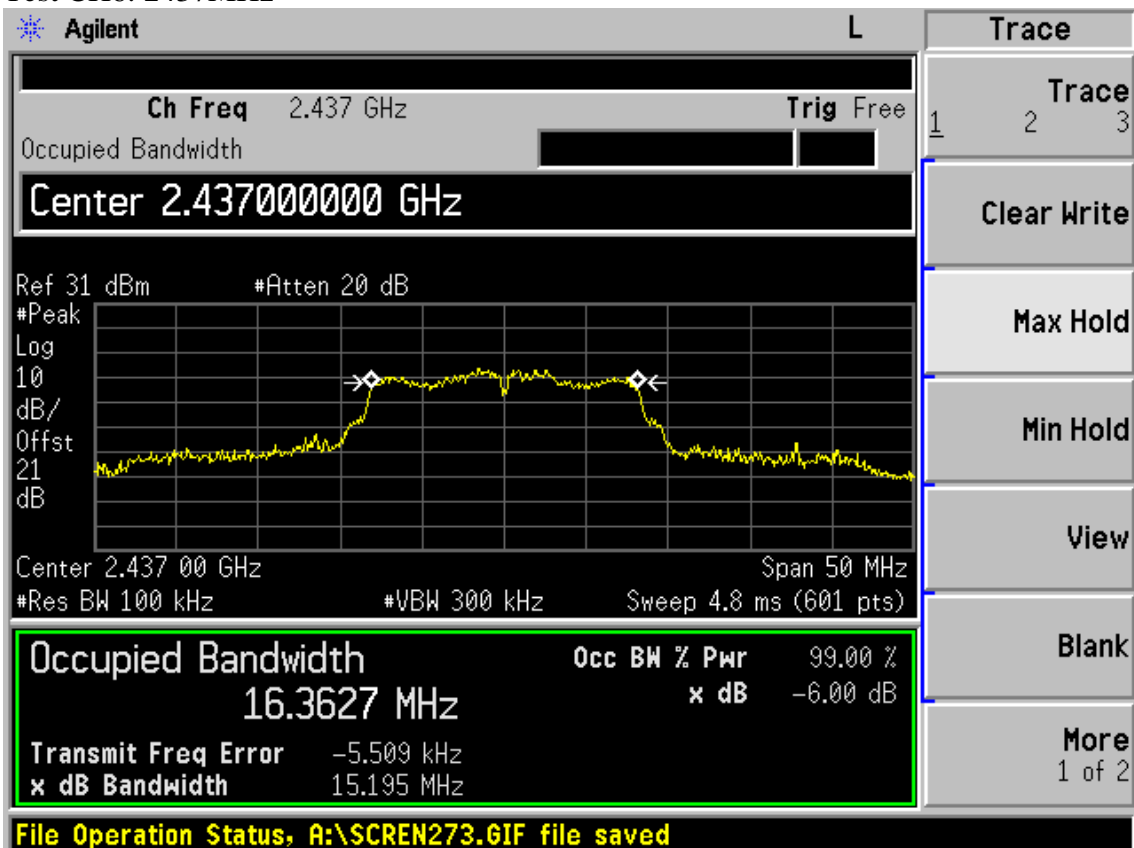

Test CH1: 2462MHz

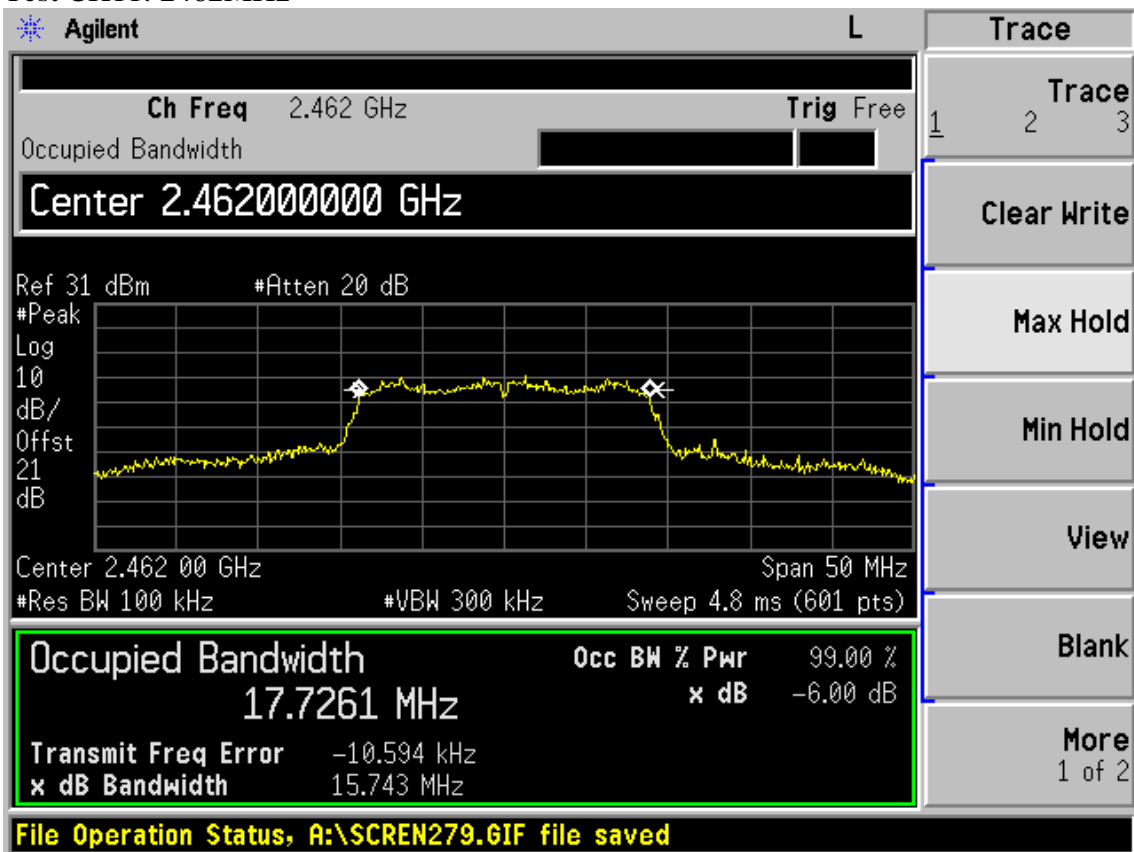

Test Mode: IEEE 802.11n HT40 TX

Test CH1: 2422MHz

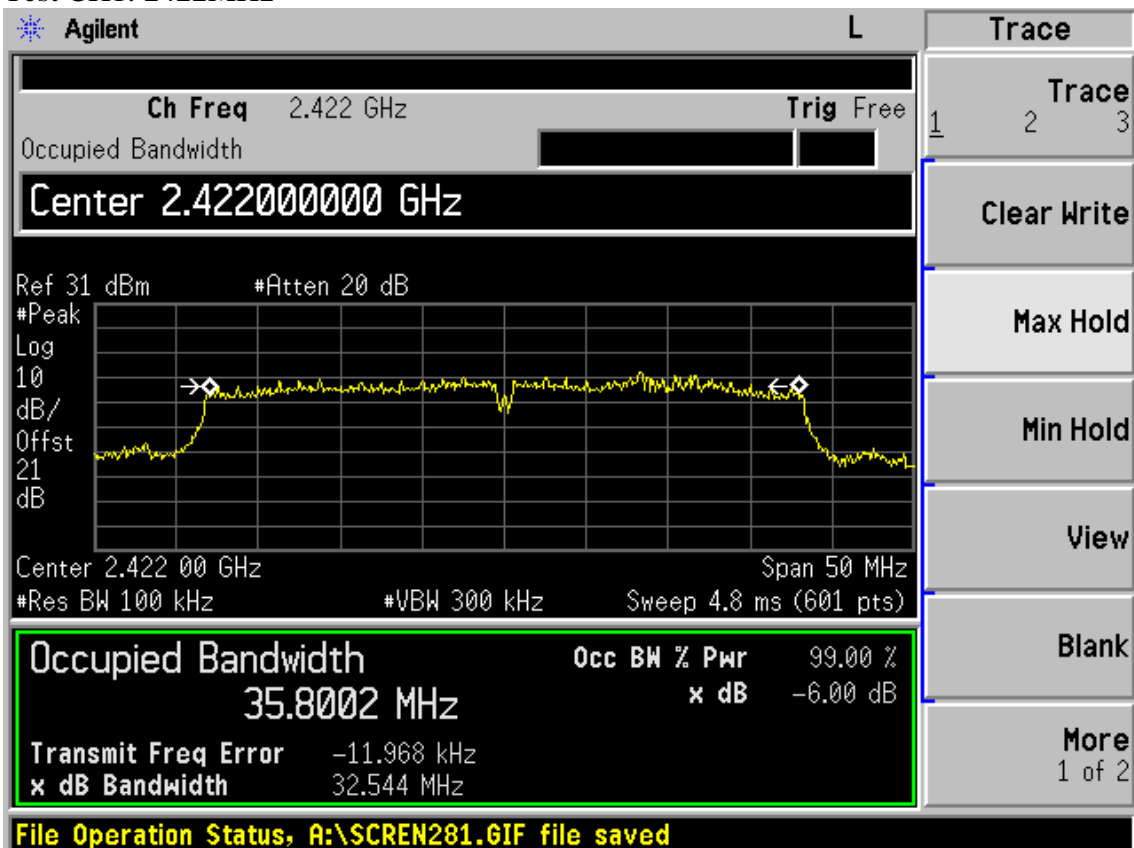

Test CH4: 2437MHz

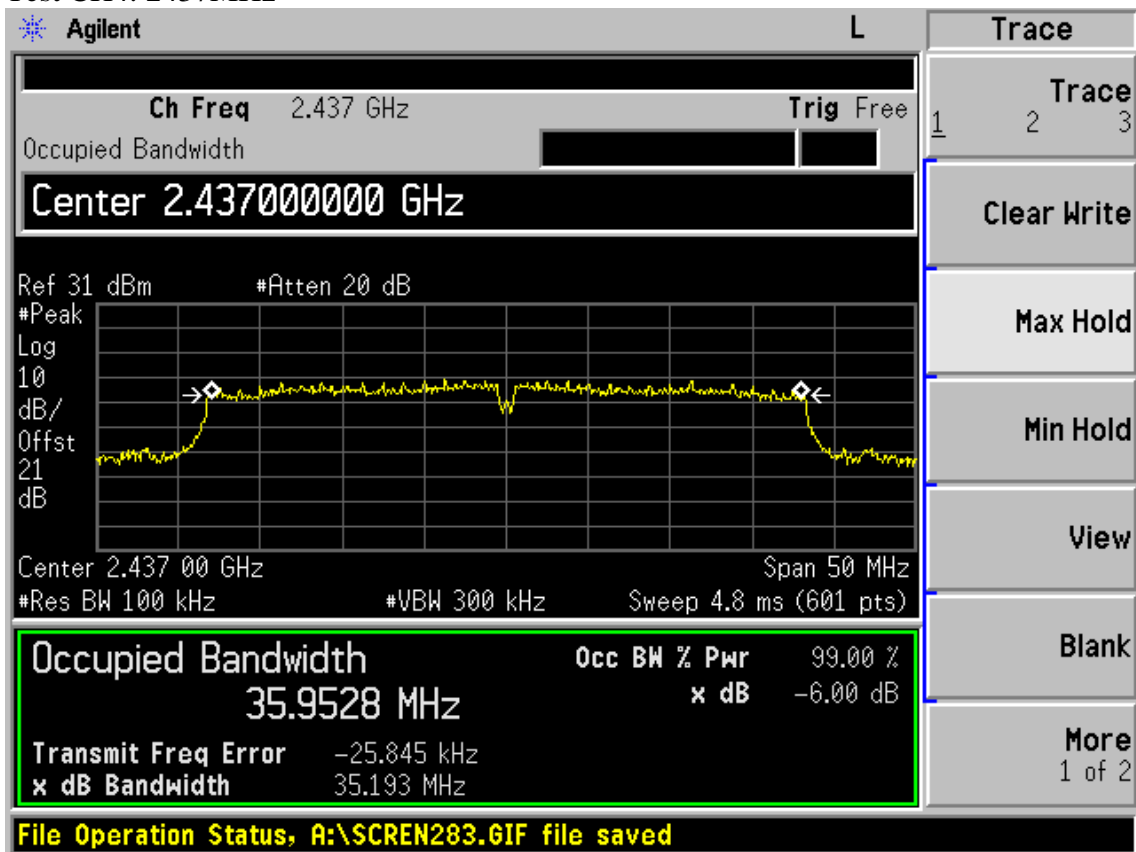

Test CH7: 2452MHz

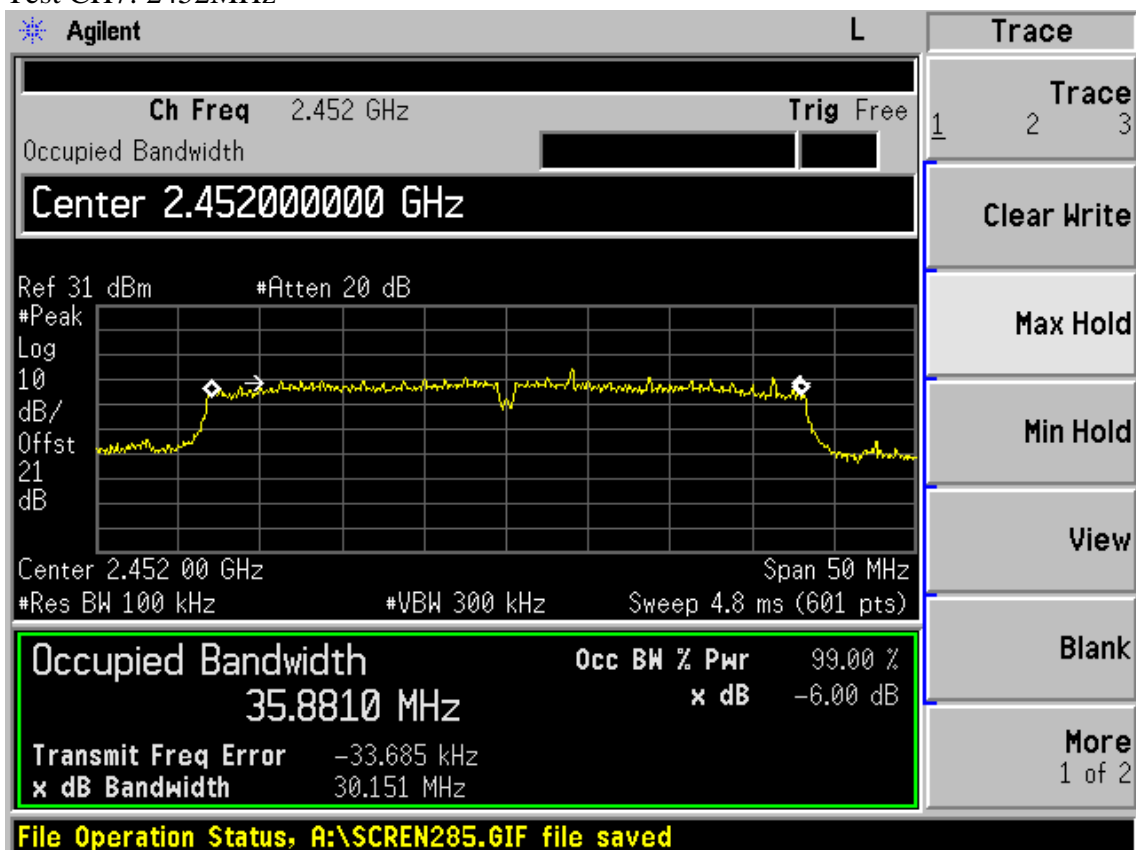

8. OUTPUT POWER TEST

8.1. Test Equipment

Item	Equipment	Manufacturer	Model No.	Serial No.	Last Cal.	Cal. Interval
1	Spectrum Analyzer	Agilent	E4446A	US44300459	May.08, 09	1 Year
2	Power meter	Anritsu	ML2487A	6K00002472	Oct.20.09	1Year
3	Power sensor	Anritsu	MA2491A	0033005	Oct.20.09	1Year
4	Attenuator	Agilent	8491B	MY39262165	May.08, 09	1 Year
5	RF Cable	Hubersuhner	SUCOFLEX 102	28618/2	May.08, 09	1Year

8.2. Limit

For systems using digital modulation in the 2400—2483.5MHz, The Peak out put Power shall not exceed 1W(30dBm)

8.3. Test Procedure

- 1, Connected the EUT's antenna port to measure device by 20dB attenuator.
- 2, For IEEE 802.11b/g and IEEE802.11n HT20 mode, use a PK power meter which's bandwidth is above 6dB bandwidth of signal to measure out each each test modes and chain's PK output power.
- 3, For IEEE802.11n HT40 mode, because the signal's bandwidth is about 40MHz and above 20MHz bandwidth of power sensor ML2491A. So the channel power measure function of Spectrum Analyzer was used to measure out the PK output power of each test modes and chain's.
- 4, For IEEE802.11n mode, it's MIMO technology, so account total PK output power by add each chain's PK output power.

Note: The cable loss and attenuator loss were offset into measure device as an amplitude offset.

8.4. Test Results

EUT: Blu-ray Disc Player		
M/N: VBR220		
Test date:2010-04-11	Pressure:100.6 kpa	Humidity:60%
Tested by:Paul Tian	Test site: RF site	Temperature : 25°C

Cable loss: 1.0dB		Attenuator loss:20dB		Antenna Gain: 1.74 dBi	
Mode	CH	Result			Limit
		Chain 1 PK Output power(dBm)	Chain 2 PK Output power(dBm)	Total PK Output power(dBm)	(dBm)
11b	CH1	21.56	22.87	N/A	30
	CH6	21.76	22.78	N/A	30
	CH11	21.93	23.54	N/A	30
11g	CH1	19.82	20.84	N/A	30
	CH6	24.37	25.30	N/A	30
	CH11	18.81	20.08	N/A	30
11n HT20	CH1	17.78	18.85	21.36	30
	CH6	22.15	24.13	26.26	30
	CH11	16.58	16.92	19.76	30
11n HT40	CH1	14.13	15.94	18.14	30
	CH4	22.68	24.58	26.74	30
	CH7	13.48	15.27	17.48	30
Conclusion: PASS					

9. POWER SPECTRAL DENSITY TEST

9.1. Test Equipment

Item	Equipment	Manufacturer	Model No.	Serial No.	Last Cal.	Cal. Interval
1.	Spectrum Analyzer	Agilent	E4446A	US44300459	May.08, 09	1 Year
2.	Attenuator	Agilent	8491B	MY39262165	May.08, 09	1 Year
3.	RF Cable	Hubersuhner	SUCOFLEX 102	28618/2	May.08, 09	1Year

9.2. Limit

For digitally modulated systems, the power spectral density conducted from the intentional radiator to the antenna shall not be greater than 8dBm in any 3kHz band during any time interval of continuous transmission.

9.3. Test Procedure

- 1, Connected the EUT's antenna port to spectrum analyzer device by 20dB attenuator.
- 2, Follow the test procedure as described in ANSI C.10: 2009 Clause 6.11.2.3 to measure out each test modes and chain's power density with 3KHz.
- 3, For IEEE802.11n mode, it's MIMO technology, so account total power density by add each chain's power density.

Note: The cable loss and attenuator loss were offset into measure device as an amplitude offset.

9.4.Test Results

EUT:Blu-ray Disc Player		
M/N: VBR220		
Test date:2010-04-11	Pressure:100.6kpa	Humidity:69%
Tested by:Paul Tian	Test site: RF site	Temperature : 24°C

Cable loss:1.0dB		Attenuator loss: 20dB		Antenna Gain: dBi	
Mode	CH	Result			Limit
		Chain 1 Power density (dBm/3KHz)	Chain 2 Power density (dBm/3KHz)	Total Power density (dBm/3KHz)	(dBm/3KHz)
11b	CH1	-3.81	-4.01	N/A	8.00
	CH6	-3.01	-2.49	N/A	8.00
	CH11	-1.13	-1.17	N/A	8.00
11g	CH1	-10.8	-10.63	N/A	8.00
	CH6	-6.93	-6.84	N/A	8.00
	CH11	-11.04	-12.78	N/A	8.00
11n HT20	CH1	-13.0	-13.07	-10.02	8.00
	CH6	-9.23	-8.39	-5.78	8.00
	CH11	-14.02	-14.11	-11.05	8.00
11n HT40	CH1	-17.82	-18.50	-15.14	8.00
	CH5	-11.80	-11.28	-8.52	8.00
	CH9	-18.07	-17.73	-14.89	8.00
Conclusion: PASS					

Chain 1:

Test Mode: IEEE 802.11b TX

Test CH1: 2412MHz

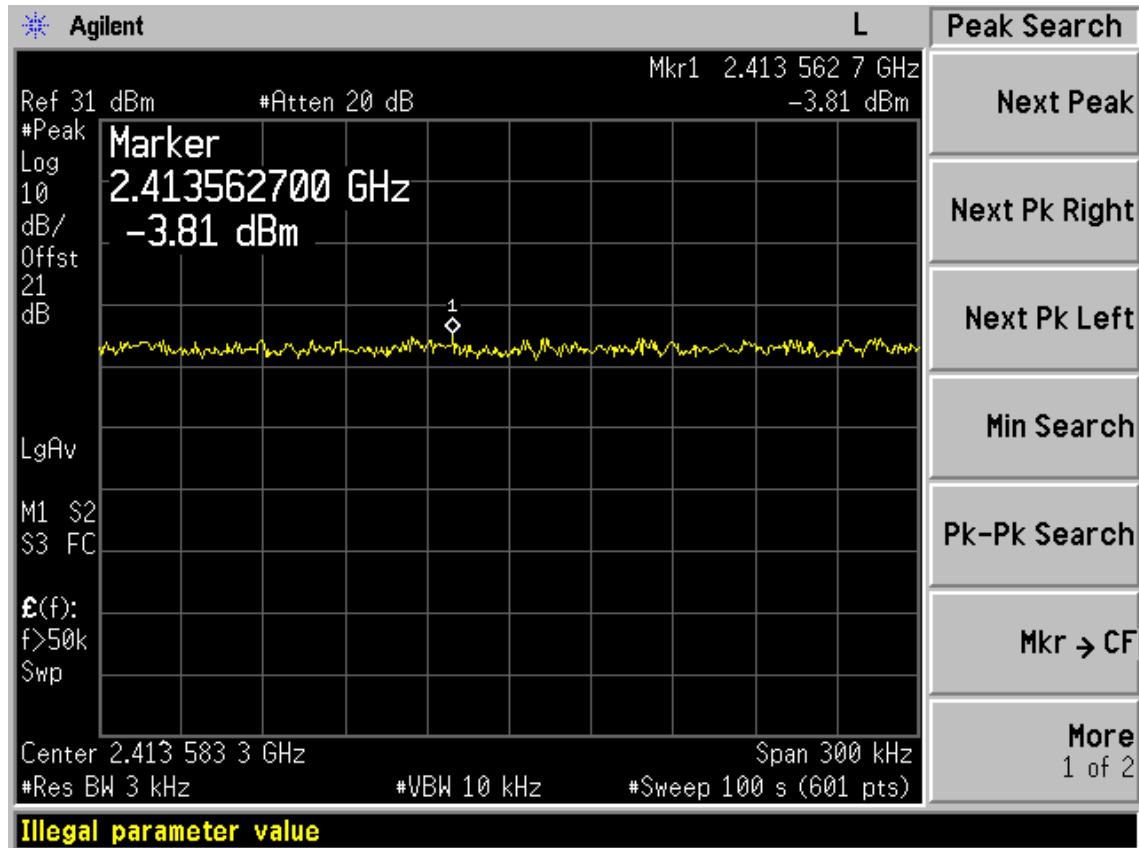

Test CH6: 2437MHz

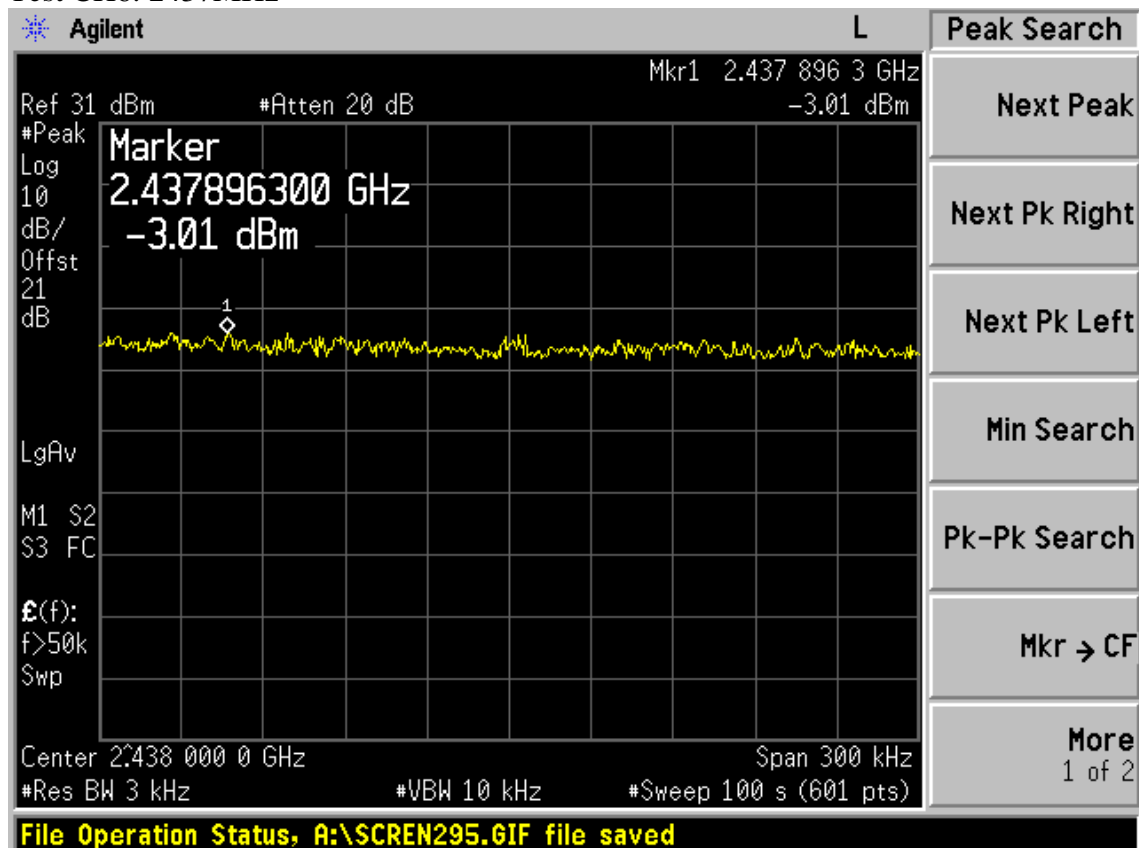

Test CH1: 2462MHz

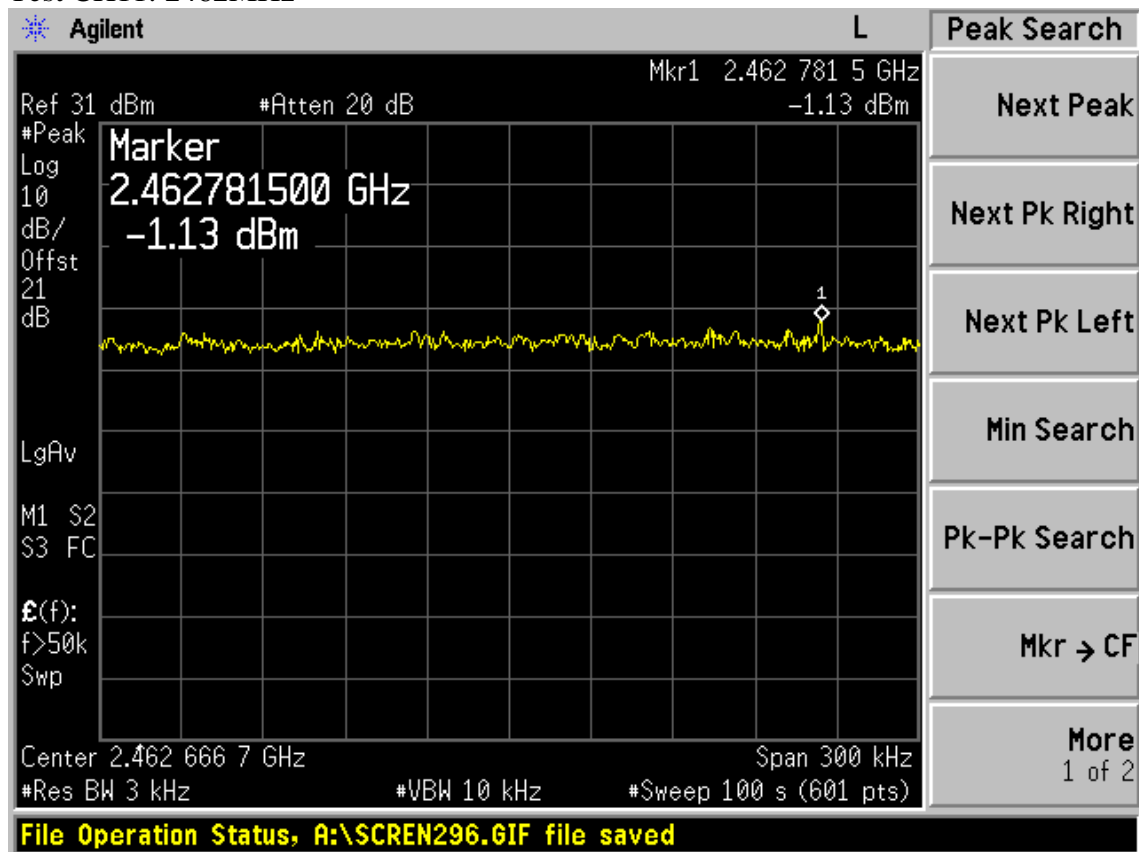

Test Mode: IEEE 802.11g TX

Test CH1: 2412MHz

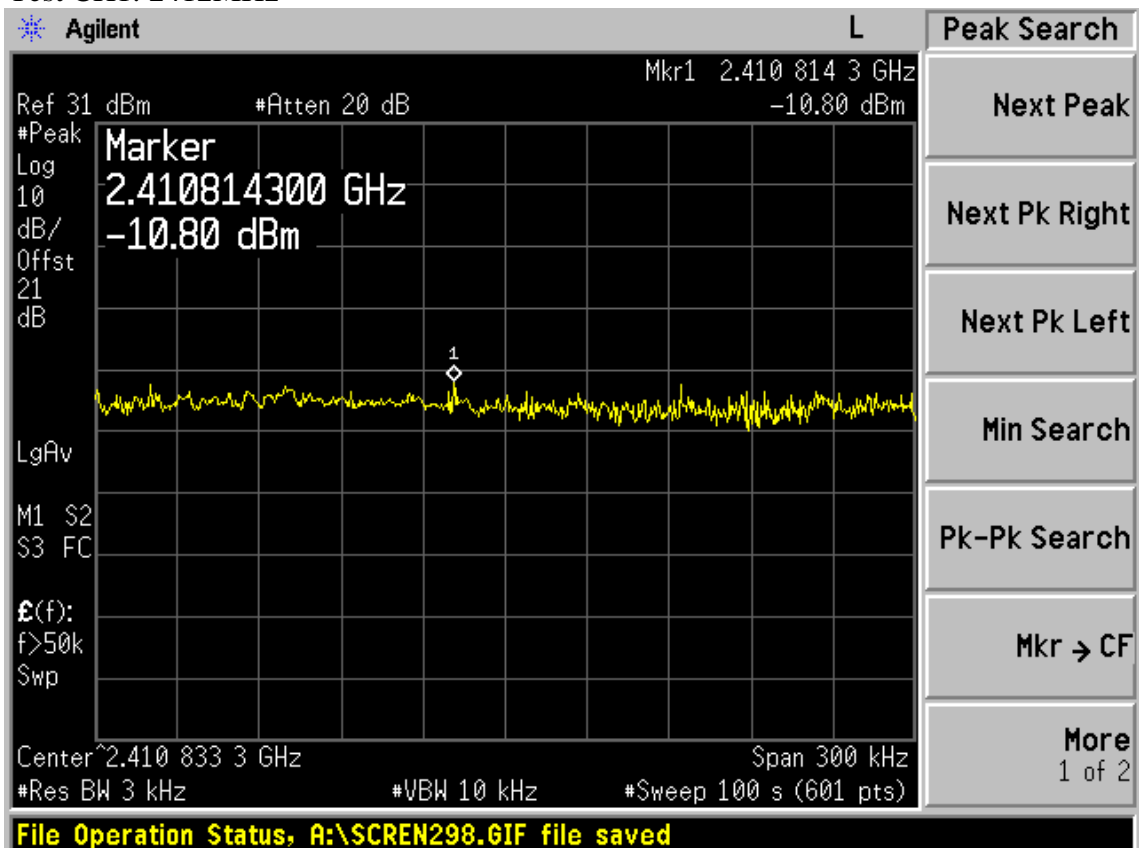

Test CH6: 2437MHz

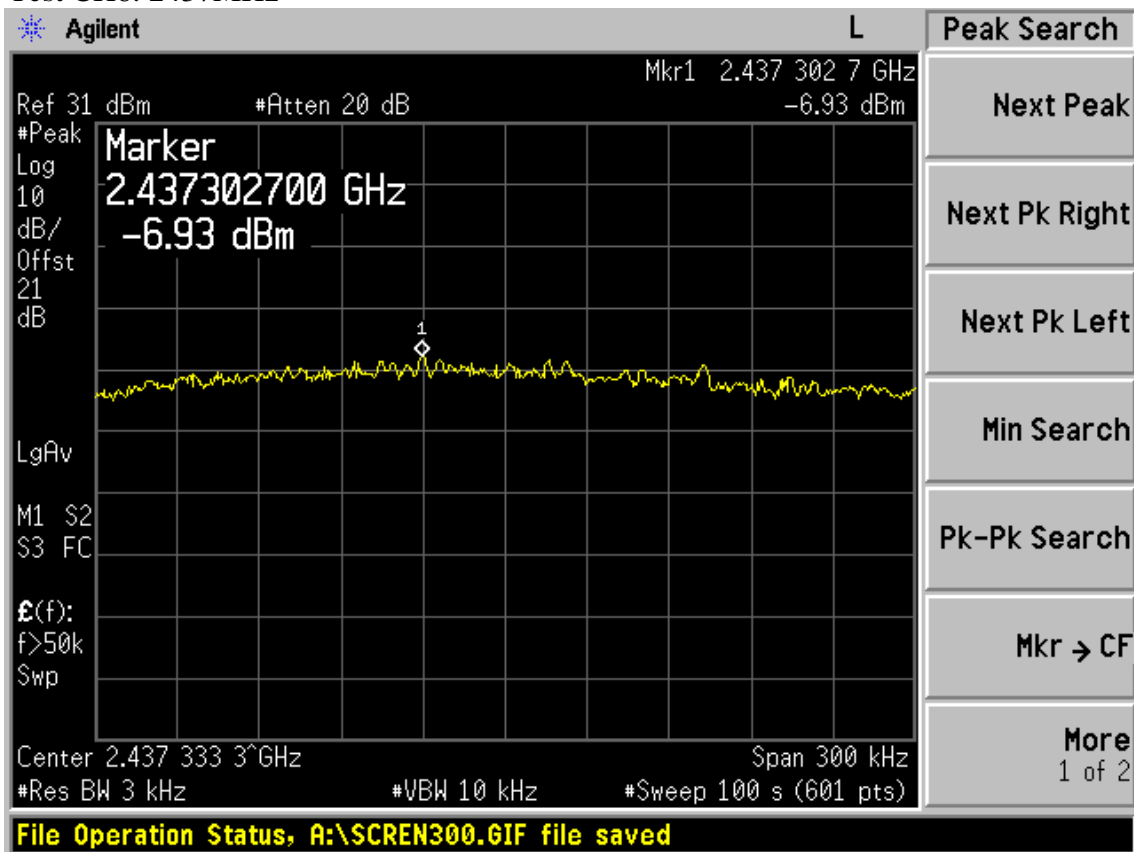

Test CH11: 2462MHz

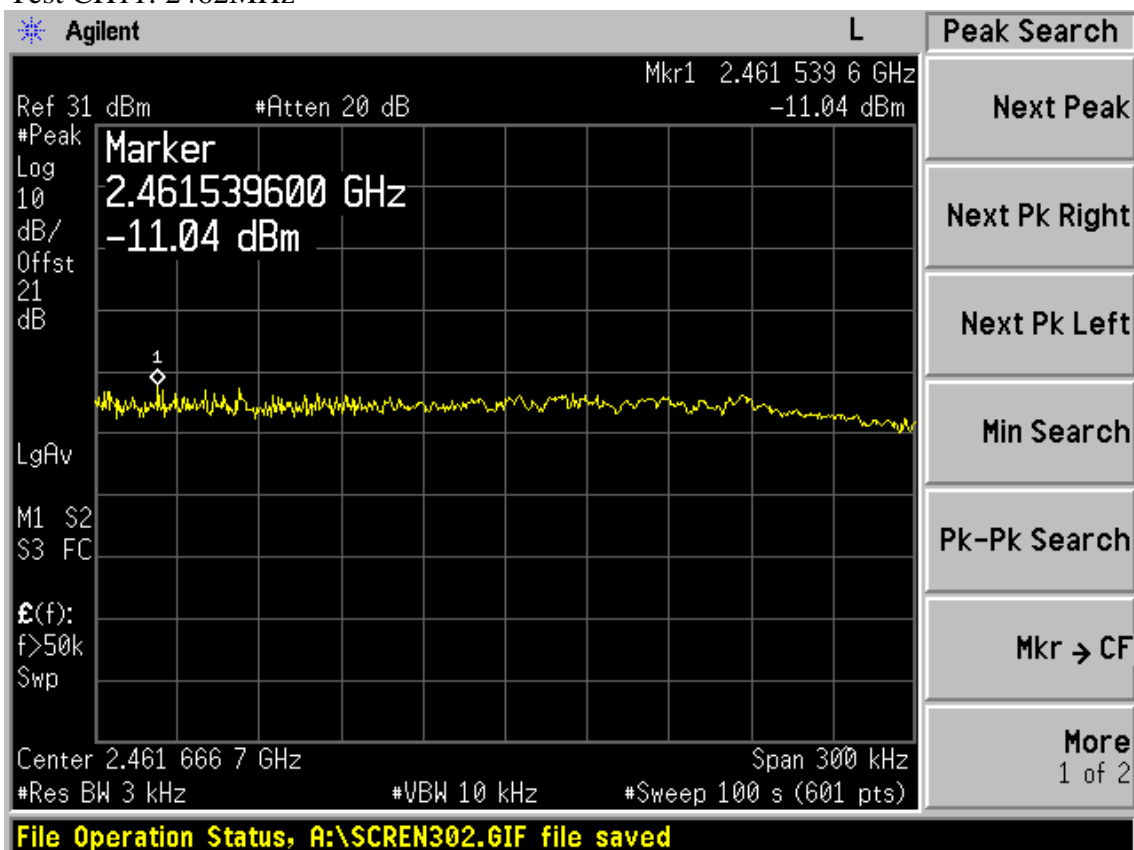

Test Mode: IEEE 802.11n HT20 TX

Test CH1: 2412MHz

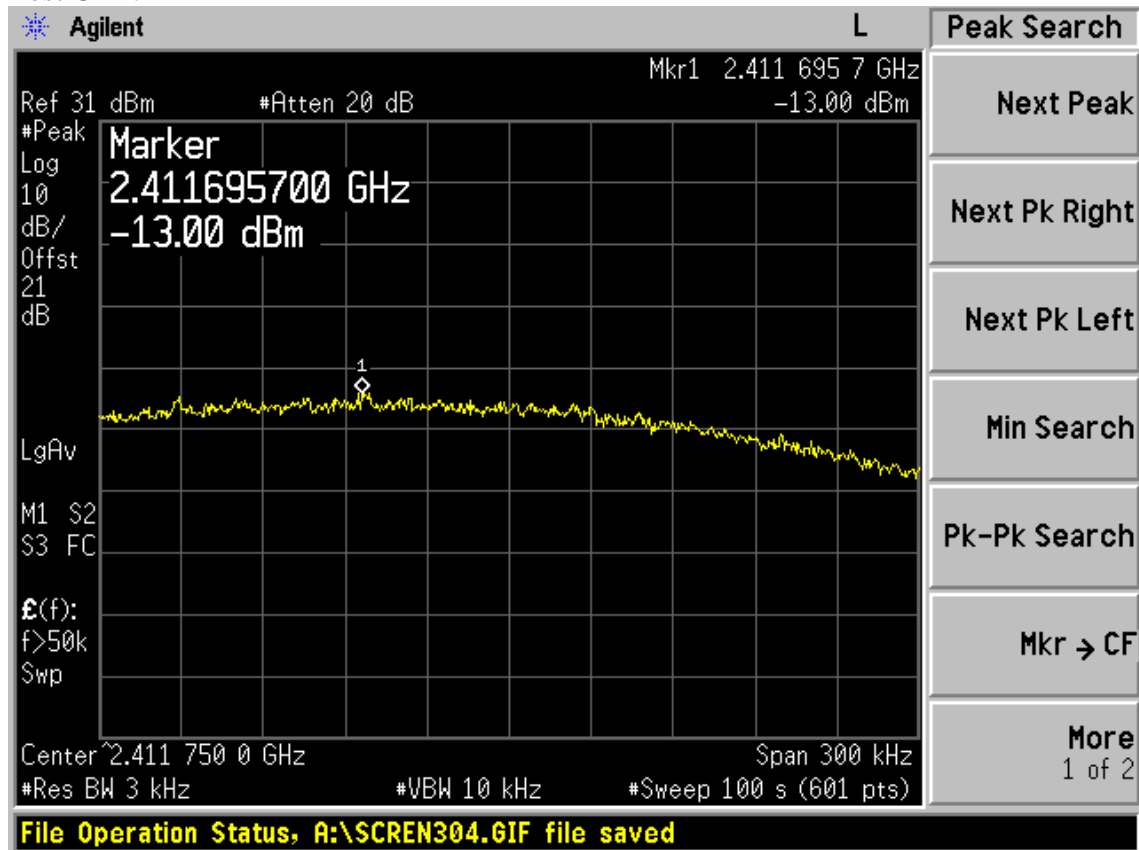

Test CH6: 2437MHz

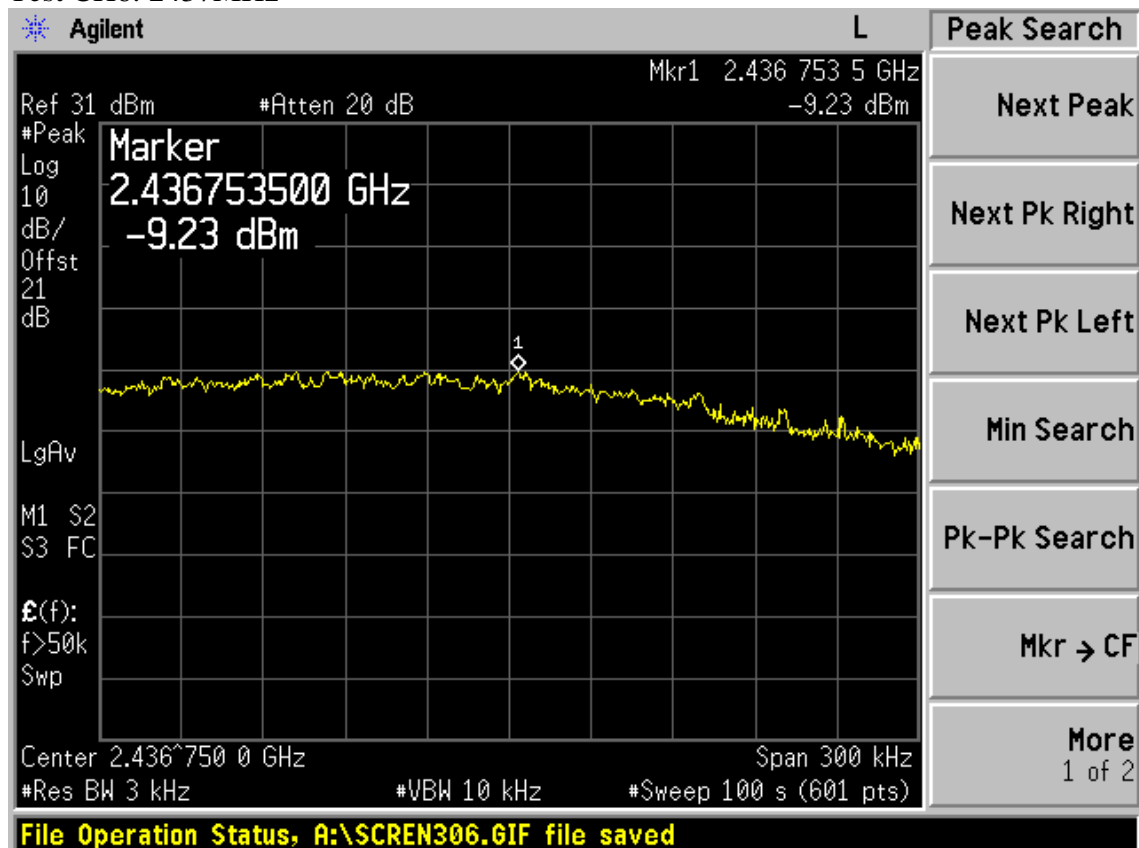

Test CH1: 2462MHz

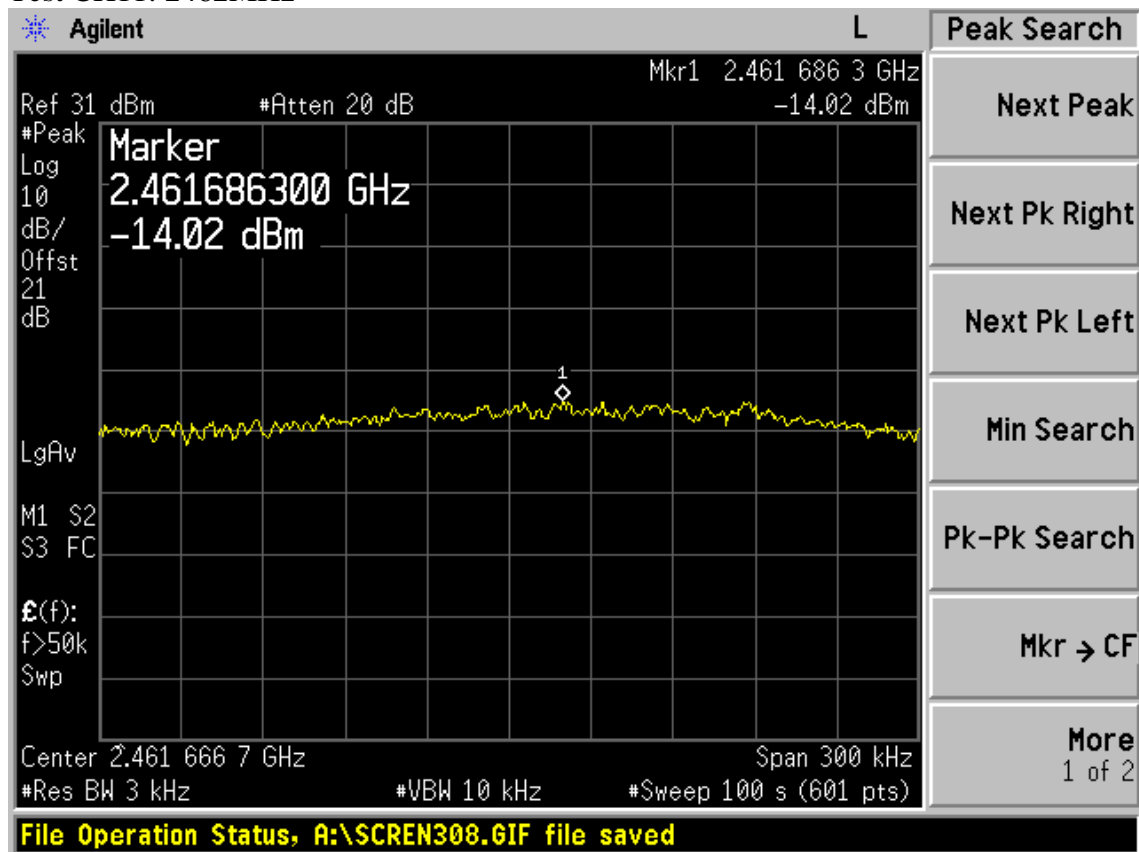

Test Mode: IEEE 802.11n HT40 TX

Test CH1: 2422MHz

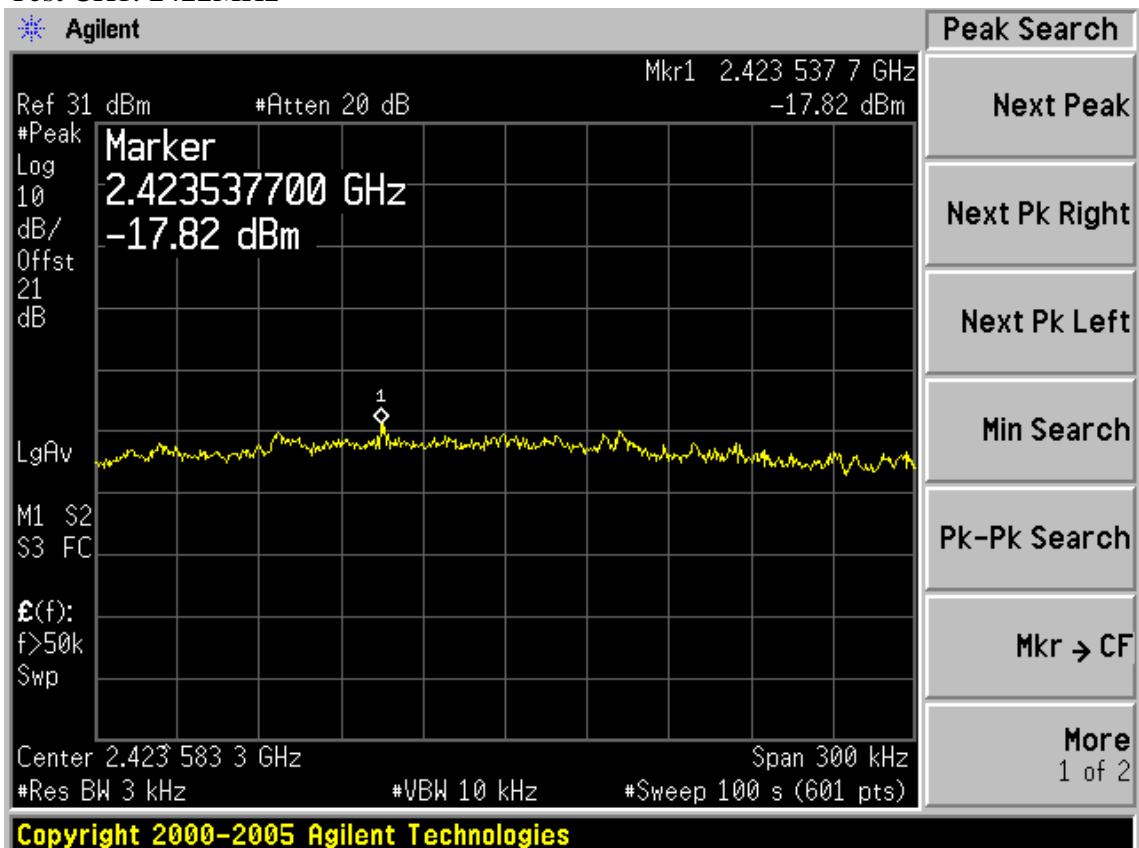

Test CH4: 2437MHz

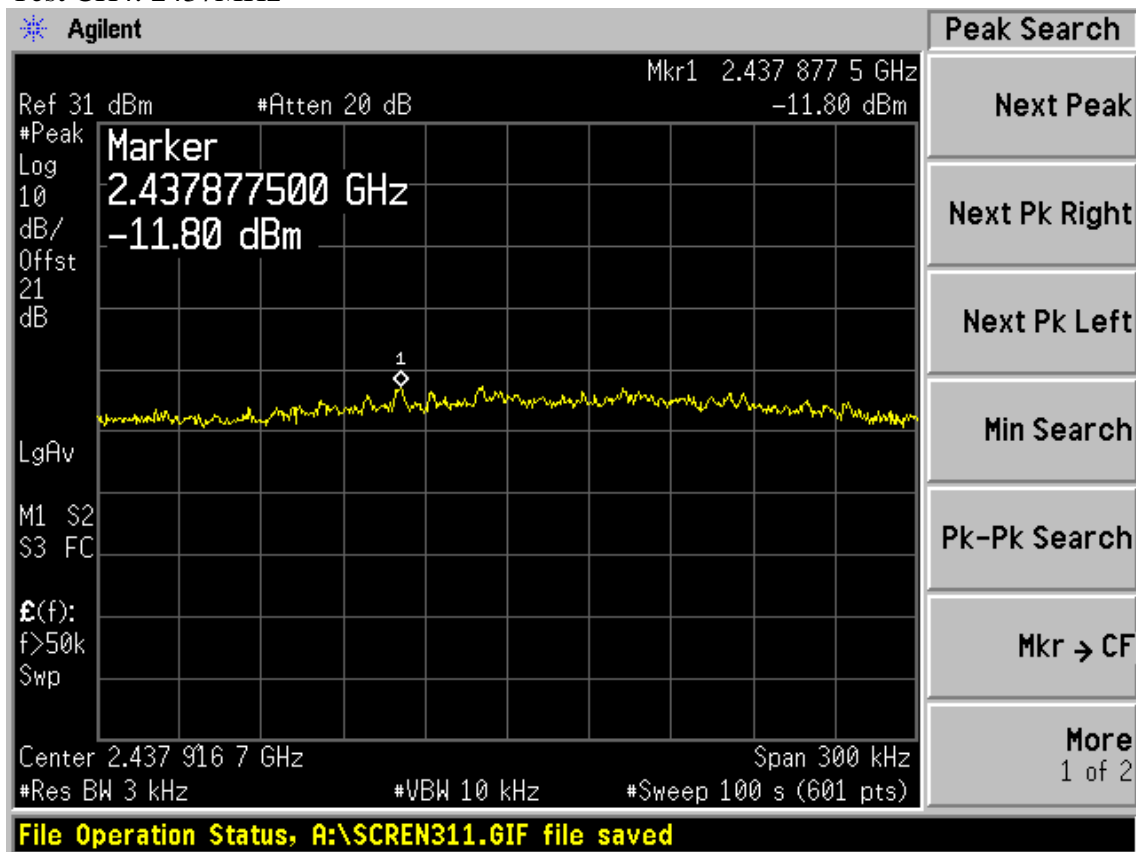

Test CH7: 2452MHz

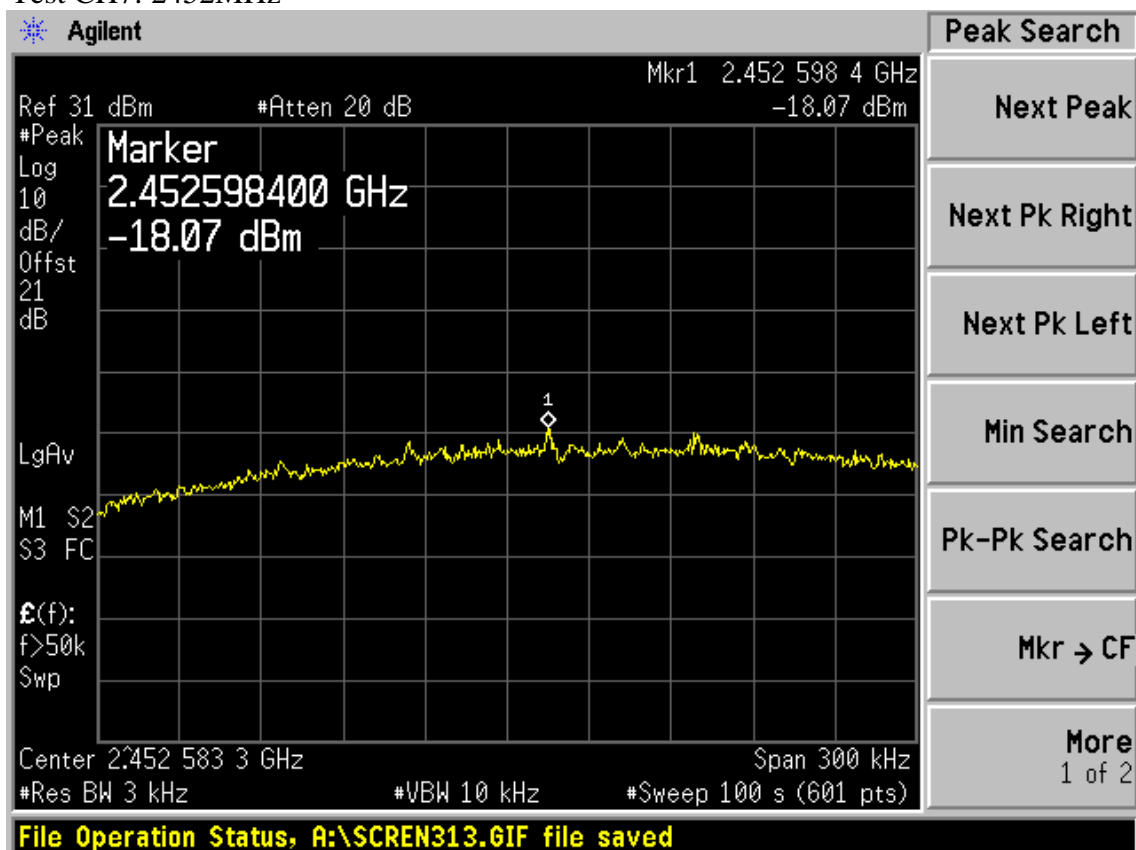

10. ANTENNA REQUIREMENT

10.1 STANDARD APPLICABLE

For intentional device, according to FCC 47 CFR Section 15.203, an intentional radiator shall be designed to ensure that no antenna other than that furnished by the responsible party shall be used with the device. And according to FCC 47 CFR Section 15.247 (b), if transmitting antennas of directional gain greater than 6dBi are used, the power shall be reduced by the amount in dB that the directional gain of the antenna exceeds 6dBi.

10.2 ANTENNA CONNECTED CONSTRUCTION

The antennas used for this product are integrated MIMO 2X2 PCB antenna that no antenna other than that furnished by the responsible party shall be used with the device, the maximum peak gain of the transmit antenna is only 1.74dBi.

11.MPE ESTIMATION

11.1.Limit for General Population/ Uncontrolled Exposures

Frequency	Power density (mW/ cm ²)	Averaging time(minutes)
300MHz----1.5GHz	F/1500	30
1.5GHz---100GHz	1.0	30

Frequency(MHz)	Power density (mW/ cm ²)	Averaging time(minutes)
2412	1	30
2437	1	30
2462	1	30

Note: F= Frequency in MHz

11.2.Estimation Result

Mode	CH	Frequency (MHz)	PK Output power (dBm)	Output power (mW)	antenna Gain (dBi)	antenna Gain(linear)	MPE
11b	1	2412	22.87	193.64	1.74	1.49	0.0575
	6	2437	22.78	189.67	1.74	1.49	0.0564
	11	2462	23.54	225.94	1.74	1.49	0.0671
11g	1	2412	20.84	121.34	1.74	1.49	0.0361
	6	2437	25.30	338.84	1.74	1.49	0.1007
	11	2462	20.08	101.86	1.74	1.49	0.0303
11n HT20	1	2412	21.36	136.77	1.74	1.49	0.0406
	6	2437	26.26	422.67	1.74	1.49	0.1256
	11	2462	19.76	94.62	1.74	1.49	0.0281
11n HT40	1	2422	18.14	65.16	1.74	1.49	0.0194
	4	2437	26.74	472.06	1.74	1.49	0.1403
	7	2452	17.48	55.98	1.74	1.49	0.0166

Note: The estimation distance is 20cm

12.DEVIATION TO TEST SPECIFICATIONS

[NONE]