

Preface

Thanks for your favor in our product. This manual provides guidance for you to quickly know how to use the product. For detailed features and operations, see the corresponding *Hytera TETRA Terminal Series Basic Feature Book*.

To help you ward off bodily injury and property loss resulting from improper operation, please read the *Safety Information Booklet* before using the product.

This manual is applicable to the following product:

[PT790Ex F4 Intrinsically Safe Portable Terminal](#)

Copyright Information

Hytera is the trademark or registered trademark of Hytera Communications Corporation Limited. (the Company) in PRC and/or other countries or areas. The Company retains the ownership of its trademarks and product names. All other trademarks and/or product names that may be used in this manual are properties of their respective owners.

The product described in this manual may include the Company's computer programs stored in memory or other media. Laws in PRC and/or other countries or areas protect the exclusive rights of the Company with respect to its computer programs. The purchase of this product shall not be deemed to grant, either directly or by implication, any rights to the purchaser regarding the Company's computer programs. Any of the Company's computer programs may not be copied, modified, distributed, decompiled, or reverse-engineered in any manner without the prior written consent of the Company.

Disclaimer

The Company endeavors to achieve the accuracy and completeness of this manual, but no warranty of accuracy or reliability is given. All the specifications and designs are subject to change without notice due to continuous technology development. No part of this manual shall be copied, modified, translated, or distributed in any manner without the prior written consent of the Company.

We do not guarantee, for any particular purpose, the accuracy, validity, timeliness, legitimacy or completeness of the Third Party products and contents involved in this manual.

If you have any suggestion or would like to learn more details, please visit our website at:

<http://www.hytera.com>.

FCC Regulations

Federal Communication Commission (FCC) requires that all radio communication products should meet the requirements set forth in the FCC Radio Frequency (RF) exposure limits before they can be marketed in the U.S., and the manufacturer shall post an RF label on the product to inform users of operational instructions, so as to enhance their occupational health against exposure to RF energy.

Operational Instructions and Training Guidelines

To ensure optimal performance and compliance with the occupational/controlled environment requirements in the FCC RF exposure limits, users should transmit no more than 50% of the time and note the following cautions:

- RF energy will be generated only when the terminal is transmitting.
- The terminal must be at least 2.5 centimeters away from mouth during transmitting.

EU Regulatory Conformance

As certified by the qualified laboratory, the product is in compliance with the essential requirements and other relevant provisions of the following directives:

- 1999/5/EC or 2014/53/EU
- 2006/66/EC
- 2011/65/EU
- 2012/19/EU

Please note that the above information is applicable to EU countries only.

FCC Statement

Any Changes or modifications not expressly approved by the party responsible for compliance could void the user's authority to operate the equipment.

This device complies with part 15 of the FCC Rules. Operation is subject to the following two conditions: (1) This device may not cause harmful interference, and (2) this device must accept any interference received, including interference that may cause undesired operation.

Note: This equipment has been tested and found to comply with the limits for a Class B digital device, pursuant to part 15 of the FCC Rules. These limits are designed to provide reasonable protection against harmful interference in a residential installation. This equipment generates uses and can radiate radio frequency energy and, if not installed and used in accordance with the instructions, may cause harmful interference to radio communications. However, there is no guarantee that interference will not occur in a particular installation. If this equipment does cause harmful interference to radio or television reception, which can be determined by turning the equipment off and on, the user is encouraged to try to correct the interference by one or more of the following measures:

—Reorient or relocate the receiving antenna.

—Increase the separation between the equipment and receiver.

—Connect the equipment into an outlet on a circuit different from that to which the receiver is connected.

—Consult the dealer or an experienced radio/TV technician for help.

IC statement

The device has been tested and compliance with SAR limits, users can obtain Canadian information on RF exposure and compliance

Après examen de ce matériel aux conformité aux limites DAS et/ou aux limites d'intensité de champ RF, les utilisateurs peuvent sur l'exposition aux radiofréquences et la conformité and compliance d'acquérir les informations correspondantes

This device complies with Industry Canada licence-exempt RSS standard(s). Operation is subject to the following two conditions:

- (1) this device may not cause interference, and
- (2) this device must accept any interference, including interference that may cause undesired operation of the device.

Le présent appareil est conforme aux CNR d'Industrie Canada applicables aux appareils radio exempts de licence. L'exploitation est autorisée aux deux conditions suivantes : (1) l'appareil ne doit pas produire de brouillage, et (2) l'utilisateur de l'appareil doit accepter tout brouillage radioélectrique subi, même si le brouillage est susceptible d'en compromettre le fonctionnement

Contents

1. Intrinsically Safe Terminal Information	3
1.1 No Misoperations	3
1.2 Safety Instructions	3
1.3 Compliance Standards.....	4
2. Items in the Package	6
3. Product Overview	7
3.1 Product Controls	7
3.2 LCD Icon.....	8
3.3 LED Indicator	10
4. Before Use	11
4.1 Attaching the Antenna.....	11
4.2 Installing the SIM Card.....	11
4.3 Attaching the Battery.....	12
4.4 Attaching the Belt Clip.....	13
4.5 Attaching the Accessories.....	14
4.6 Charging the Battery	15
5. Basic Operations	16
5.1 Powering On/Off the Terminal	16
5.2 Switching the Operation Mode.....	16
5.3 Adjusting the Call Volume	17
5.4 Selecting a Group	17
5.5 Inputting via Keypad	17
5.6 Locking/Unlocking the Keypad.....	17
5.7 PIN Code Protection	18
5.8 Managing the PhoneBook.....	18
6. TMO Services.....	19
6.1 Individual Call	19
6.2 Group Call.....	20
6.3 PABX/PSTN Call.....	20
6.4 Emergency Call	20
6.5 Message	21
7. DMO Services	22
7.1 Individual Call	22
7.2 Group Call.....	22
7.3 Emergency Call	22
7.4 Message	23
8. Troubleshooting	24

9. Care and Cleaning26
10. Optional Accessories.....27
11. Specifications28

1. Intrinsically Safe Terminal Information

Caution

- Observe the following safety instructions when using the product, so as to ensure safe and reliable operations. Failure to observe the instructions may result in danger or violation of applicable regulations.
- To avoid possible interference with blasting operations, turn off the product before entering an area where you may be close to electrical blasting caps. Obey all signs and instructions in a blasting area or an area with "Turn off two-way radios" posted.

1.1 No Misoperations

Stop operating the product and leave the blasting area immediately when the intrinsic safety or integrity of the product is endangered, and deliver it to your local dealer for examination.

The safety or reliability of the product may be endangered when:

- The product is stored improperly.
- The product is faulty.
- The product works with overload.
- The product operates beyond the tolerance or threshold.
- The product is damaged during transportation.
- The product's housing is obviously damaged or cracked.
- The logo or characters on the product are hard to be recognized.

1.2 Safety Instructions

- Before using the product in a hazardous atmosphere, ensure that the two screws fixing the battery are correctly tightened.
- Ensure that the product is used only with the BL1813-Ex battery.
- Ensure that the product is used only with the following accessories: SM18N8-Ex remote speaker microphone, EHN12-Ex earpiece, BC19 belt clip, RO04 strap, and LCY008, LCY009, LCY010, or LCY011 leather case.
- Do not replace the battery or accessories in a hazardous atmosphere.

- Charge the battery using the designated charger in a non-hazardous atmosphere with a maximum ambient temperature of 40°C.
- Do not carry any backup battery in a hazardous atmosphere.
- Do not use the product if its housing is damaged or cracked.
- Do not block or open the pressure adjustment hole on the product.
- Do not use a damaged antenna. A minor burn may be caused when you touch a damaged antenna.
- Do not expose the product to direct sunlight for a long time, nor place it close to a heating source.
- Do not disassemble or modify the product. Unauthorized modification may negate the approval rating of the product.
- Do not attempt to disassemble, destroy, or short-circuit the battery. Never dispose of it in fire.
- Hold the product upright and keep its microphone 2.5 to 5 centimeters away from your mouth during use.
- If you wear the product, ensure that its antenna is at least 0 centimeters away from your body during transmission.

1.3 Compliance Standards

- ATEX

II 1 G Ex ia IIC T3 -20°C < Ta < +55°C

I M1 Ex ia I -20°C < Ta < +50°C,IP5X

II 1 G Ex ia IIC T3 -20°C < Ta < +50°C,IP5X

II 1 D Ex ia IIIC T160°C -20°C < Ta < +50°C,IP5X

I M2 Ex ib I -20°C < Ta < +50°C,IP5X

II 2 G Ex ib IIC T4 -20°C < Ta < +50°C,IP5X

II 2 D Ex ib IIIC T120°C -20°C < Ta < +50°C,IP5X

- IEC Ex

Ex ia IIC T3 Ga -20°C < Ta < +55°C

Ex ia I Ma -20°C < Ta < +50°C,IP5X

Ex ia IIC T3 Ga -20°C < Ta < +50°C,IP5X

Ex ia IIIC T160°C Da -20°C < Ta < +50°C,IP5X

Ex ib I Mb -20°C < Ta < +50°C,IP5X

Ex ib IIC T4 Gb -20°C < Ta < +50°C,IP5X

Ex ib IIIC T120°C Db -20°C < Ta < +50°C,IP5X

- FM US

Class I,Zone 0 AEX ia IIC T3B Ta= -20°C to +55°C

Class I,Zone 0 AEX ia IIC T3C Ta= -20°C to +50°C IP5X

Class I,Zone 1 AEX ib IIC T4 Ta= -20°C to +50°C IP5X

Class II,III Zone 0 AEX ia IIIC T160 °C Ta= -20°C to +50°C IP5X

Class II,III Zone 1 AEX ib IIIC T120 °C Ta= -20°C to +50°C IP5X

Class I,Div 1,Group A,B,C,D T3B Ta= -20°C to +55°C

Class I,Div 1,Group A,B,C,D T3C Ta= -20°C to +50°C IP5X

Class I,Div 2,Group A,B,C,D T4 Ta= -20°C to +50°C IP5X

Class II,III Div 1,Group E,F,G T3C Ta= -20°C to +50°C IP5X

Class II,III Div 2,Group E,F,G T4A Ta= -20°C to +50°C IP5X

- FM CA

Class I,Zone 0 EX ia IIC T3B Ga Ta= -20°C to +55°C

Class I,Zone 0 EX ia IIC T3C Ga Ta= -20°C to +50°C IP5X

Class I,Zone 1 EX ib IIC T4 Gb Ta= -20°C to +50°C IP5X

Class II,III Zone 0 EX ia IIIC T160 °C Da Ta= -20°C to +50°C IP5X

Class II,III Zone 1 EX ib IIIC T120 °C Db Ta= -20°C to +50°C IP5X

Class I,Div 1,Group A,B,C,D T3B Ga Ta= -20°C to +55°C

Class I,Div 1,Group A,B,C,D T3C Ga Ta= -20°C to +50°C IP5X







Class I,Div 2,Group A,B,C,D T4 Gb Ta= -20°C to +50°C IP5X

Class II,III Div 1,Group E,F,G T3C Da Ta= -20°C to +50°C IP5X

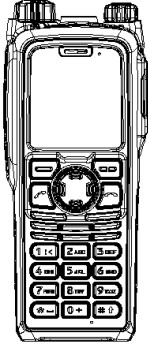
Class II,III Div 2,Group E,F,G T4A Db Ta= -20°C to +50°C IP5X

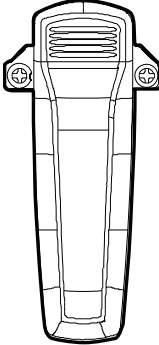
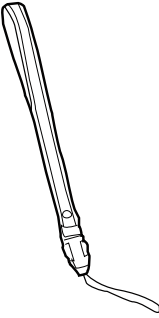
2. Items in the Package

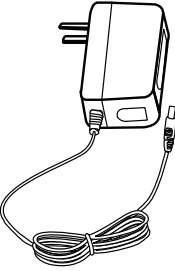
Please unpack carefully and check if all items listed below are received. If any item is missing or damaged, please contact your dealer.

		
<p>Portable Terminal</p>	<p>Antenna</p>	<p>Belt Clip</p>
		
<p>Strap</p>	<p>Charger</p>	<p>Battery</p>
		
<p>Power Adapter</p>	<p>Documentation Kit</p>	

Note

- The pictures in this manual are for reference only.
- The frequency band is marked on the label of antenna; if it is unavailable there, see the label on the terminal for frequency band information.

3. Product Overview



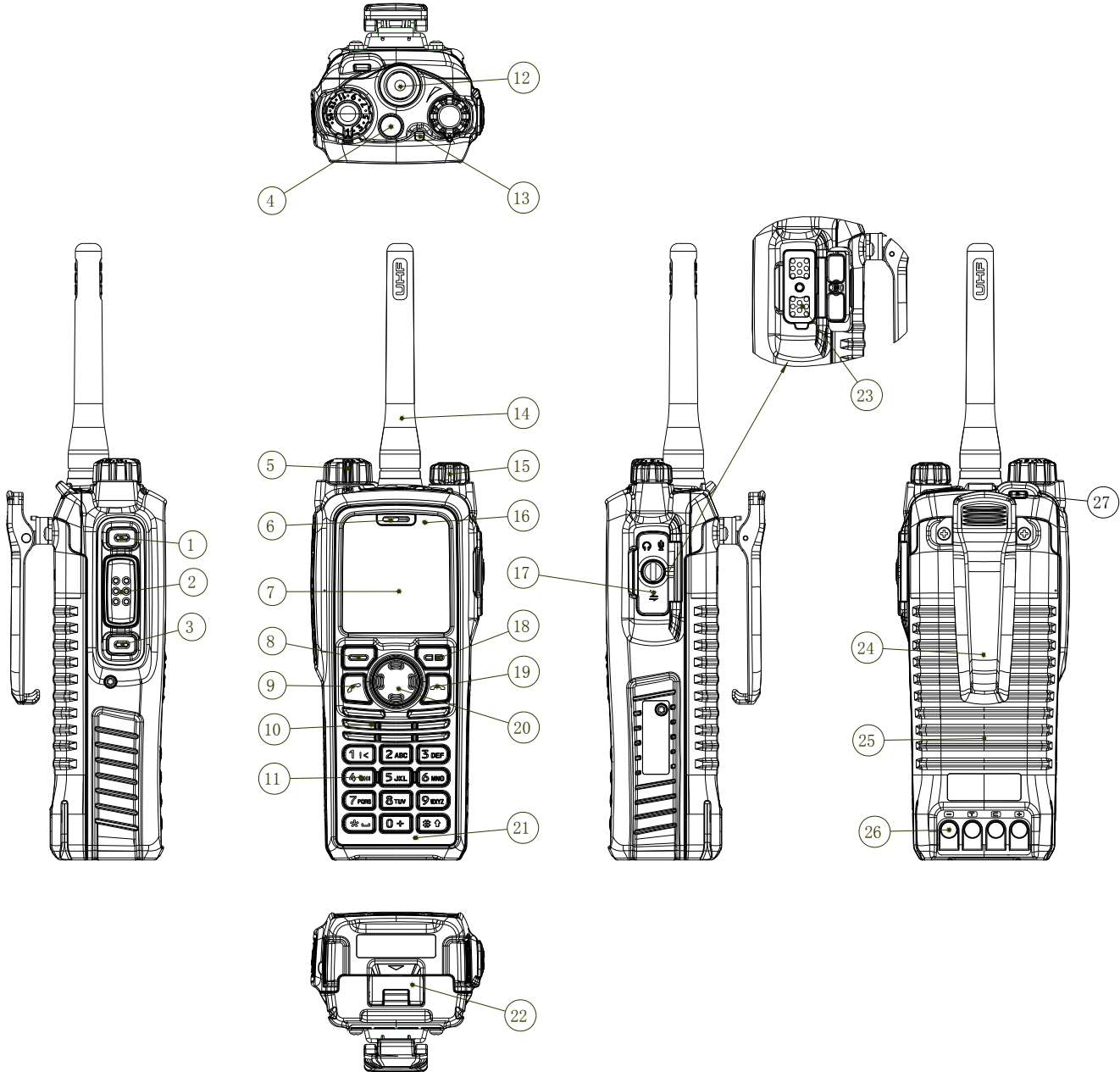

3.1 Product Controls









No.	Part Name	No.	Part Name
1	Side Key 1 (SK1)	15	Power On-Off/Volume Control Knob
2	Push-to-Talk (PTT) Key	16	Upper Microphone
3	Side Key 2 (SK2)	17	Accessory Connector Cover
4	Emergency Key	18	Options/Back Key

























No.	Part Name	No.	Part Name
5	Group Selector Knob	19	End Key
6	Full-duplex Receiver	20	Navigation Key
7	LCD Display	21	Lower Microphone
8	Func/OK Key	22	Battery Latch
9	Answer/Call Key	23	Accessory Connector
10	Half-duplex Speaker	24	Belt Clip
11	Numeric Keypad	25	Battery
12	Antenna Connector	26	Charging Piece
13	LED Indicator	27	Strap Hole
14	Antenna	/	/









Note

For enhanced convenience, you may request your dealer to program the keys (**SK1**, **SK2**, navigation keys, **Answer/Call** key, numeric keys 1–9, , , , and ) as shortcuts to certain menus and features. For the detailed introduction, see the corresponding *Hytera TETRA Terminal Series Basic Feature Book*.

3.2 LCD Icon

Icon	Terminal Status
	The terminal is not registered with the system (applicable to TMO only).
	The terminal is registered with the system, and more bars indicate stronger signal strength.
	The terminal is not registered with the system while the WAP browser is running.
	The terminal is registered with the system while the WAP browser is running, and more bars indicate stronger signal strength.
	There is/are unread message(s).
	The Inbox is full.
	The terminal is operating in TMO.

Icon	Terminal Status
	The terminal is operating in DMO.
	The terminal is operating in fallback mode.
	The scan feature is enabled in TMO.
	The scan feature is enabled in fallback mode.
	The terminal is operating in silent mode.
	The terminal is operating in normal (ring and vibration) mode.
	The terminal is operating in vibration mode.
	An audio accessory is connected.
	An audio accessory is connected but unavailable for use.
	The GPS feature is active, and valid GPS data is received.
	The GPS feature is active, but no valid GPS data is received.
	A call is in progress.
	The terminal is selecting a group.
	A gateway device is available and connected in DMO.
	A gateway device is available but unconnected in DMO.
	A repeater is available and connected in DMO.
	A repeater is available but unconnected in DMO.
	The keypad is locked.
	SIM card-based End-to-End Encryption (E2EE) is in use.
	Air Interface Encryption (AIE) is in use.
	E2EE is in use.
	Both AIE and E2EE are in use.
	The ongoing call is assigned with a pre-emptive priority.
	The ongoing call is assigned with a higher priority.
	The ongoing call is assigned with a lower priority.

Icon	Terminal Status
	The terminal is prohibited from transmitting.
	A call via gateway is in progress.
	An AIE call is in progress.
	A call via repeater is in progress.
	An E2EE call via repeater is in progress.
	An AIE call via repeater is in progress.
	An AIE and E2EE call via repeater is in progress.
	An Emergency call is in progress.
	A broadcast call is in progress.

3.3 LED Indicator

LED Indicator	Terminal Status
Glows red	The terminal is in transmitting status.
Flashes red slowly	The terminal is under low-voltage protection. Please replace or recharge the battery.
Flashes red	The terminal detects an invalid battery. Please replace the battery with a Hytera-supplied intrinsically safe battery.
Glows green	The terminal is in receiving status.
Flashes green slowly	The channel is idle in DMO.
Glows orange	<ul style="list-style-type: none"> ● The channel is busy in DMO. ● The terminal is prohibited from transmitting.
Flashes orange slowly	In TMO, the terminal fails to find or connect to the BS with which it is registered.

4. Before Use

4.1 Attaching the Antenna

Caution

Do not hold the terminal by its antenna; otherwise, the performance may be lowered and the life span of the antenna may be shortened.

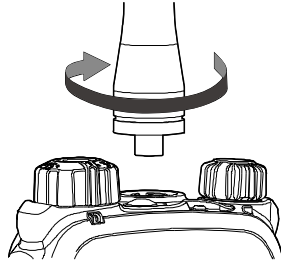

4.2 Installing the SIM Card

If a SIM card is required to implement the E2EE feature, please prepare it separately and install it as follows:

Step 1 Remove the battery.

Step 2 Loosen the screw fixing the SIM card cover, remove the cover, and then place the card in the holder properly as shown below.

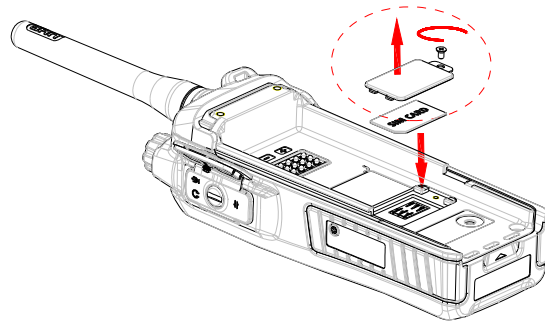

Step 3 Replace the cover and tighten the screw as shown below.

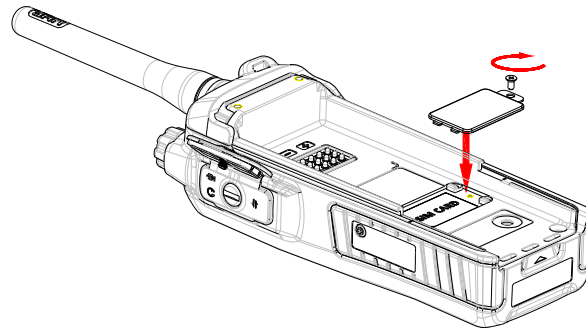

4.3 Attaching the Battery

Step 1 Align the battery slots with the guide rails on the terminal as shown below.

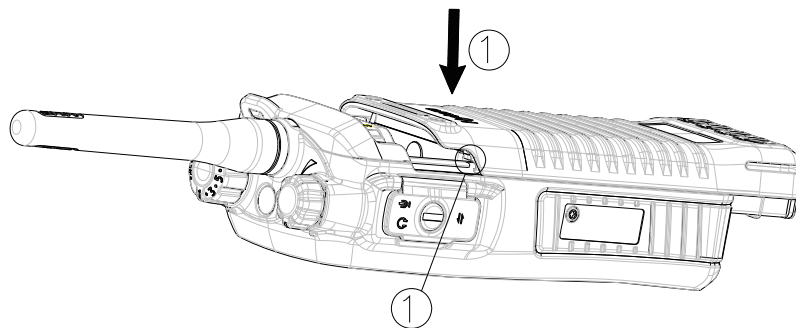

Step 2 Open the battery latch and exert force on it to retract the metal lock into the battery housing completely as shown below.

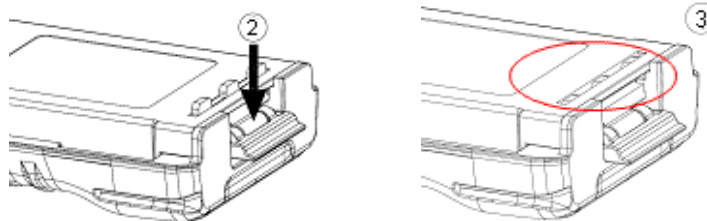

Step 3 Push the battery as shown below until it is fully fitted into the slot, and then release the battery latch.

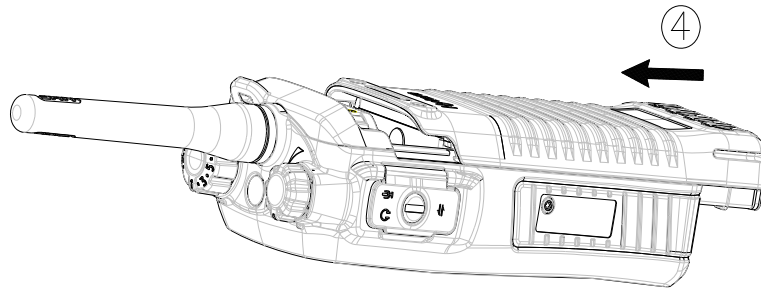

 **Note**

To remove the battery, power off the terminal, open the battery latch, and slide the battery out while exerting force on the battery latch.

Step 4 Tighten the two screws on the back of the terminal as shown below.

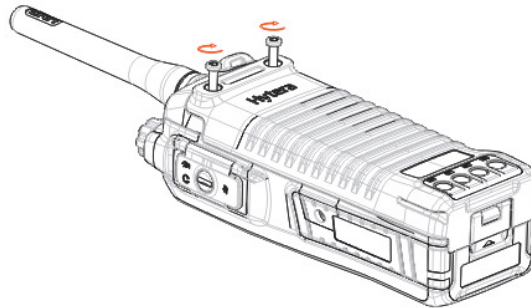

4.4 Attaching the Belt Clip

Step 1 Remove the two screws on the back of the terminal.

Step 2 Align the screw holes on the belt clip with those on the terminal, and then tighten the screws as shown below.

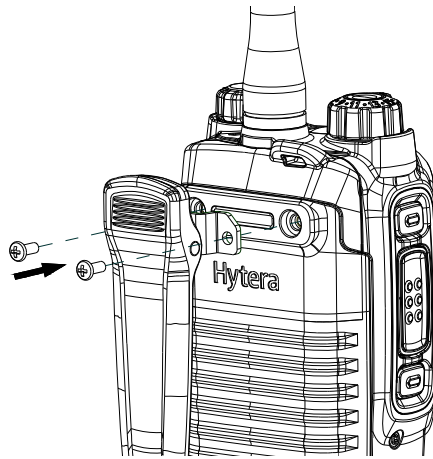

4.5 Attaching the Accessories

Caution

To ensure the waterproof and dustproof performance of the terminal:

- Do not scrape the silicone waterproof pad surrounding the screw hold of the accessory connector.
- Do close the accessory connector cover and fasten the screw after removing the accessory.

Step 1 Loosen the screw fixing the accessory connector cover, and open the cover as shown below.

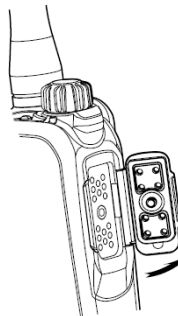

Step 2 Align the accessory (such as an audio accessory, or a programming cable) plug with the accessory connector.

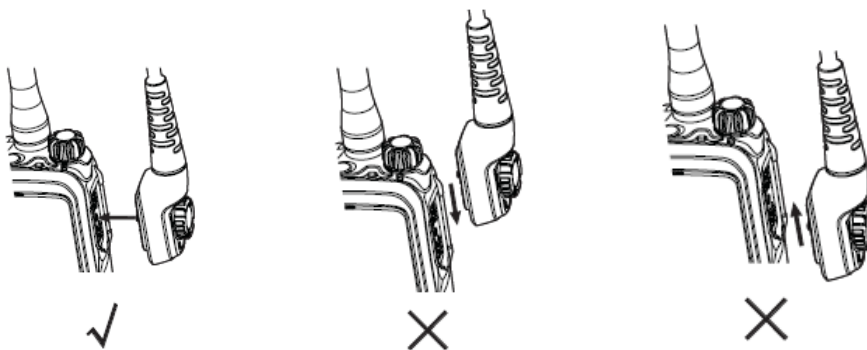

Step 3 Tighten the screw on the plug.

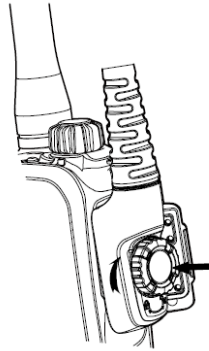

4.6 Charging the Battery

Caution

- Use the charger and battery specified by the Company only.
- You are advised to power off the terminal and read the *Safety Information Booklet* for necessary safety information before charging the terminal with battery attached.

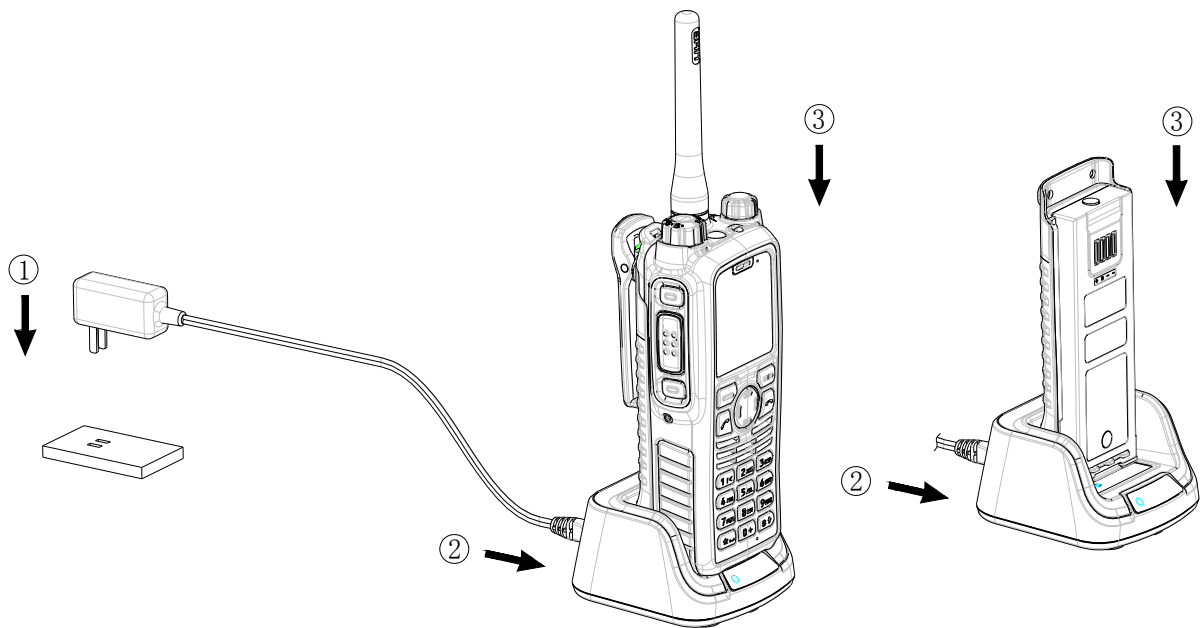

The LED indicator on the charger indicates the charging status. For details, see the following table.

LED Indicator	Charging Status
Flashes red slowly	The terminal is standby (no load).
Glow red	The battery is being charged.
Glow orange	The battery is charged to 90%.
Glow green	The battery is fully charged.
Flashes red rapidly	The battery fails to be charged.

5. Basic Operations

5.1 Powering On/Off the Terminal

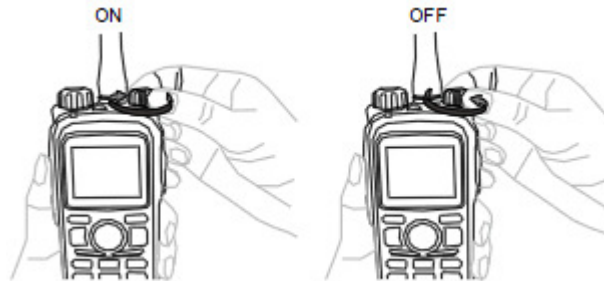

5.2 Switching the Operation Mode

The terminal can operate in either TMO or DMO.

On the home screen, press  to enter the menu, select "Mode", and then select "TMO" or "DMO" to switch the operation mode.

5.3 Adjusting the Call Volume







5.4 Selecting a Group



5.5 Inputting via Keypad



You can enter user alias, call numbers and messages via the keypad. In the editing mode, you may do as follows:

- Press  to switch the input method between alphabetic mode and numeric mode.
- In the alphabetic mode, press  to enter special characters.
In the numeric mode, long press  to enter special characters.
- Press  to enter an asterisk (*).
- Long press  to enter a space.

5.6 Locking/Unlocking the Keypad

When the keypad is not in use, you can lock it to avoid misoperations. The locking and unlocking methods are described as follows:

- Enable or disable the Auto Lock feature
On the home screen, press  , go to "Settings -> Radio -> Keypad -> Auto Lock", and then select "On" or "Off".
- Lock/unlock the keypad

On the home screen, press  and then press  to lock or unlock the keypad.

5.7 PIN Code Protection

PIN code can prevent an unidentified user from using your terminal.

- Enable or disable the PIN Code feature

On the home screen, press  and go to "Settings -> Function -> Security -> PIN Enable". Select "On" or "Off", and enter the PIN code ("1234" by default), to enable or disable the PIN Code feature.

The terminal will be locked if you fail to enter the correct PIN code for three consecutive times. In this case, you need to enter the PUK code ("12345678" by default) to reset the PIN code.

- Change the PIN code

On the home screen, press  and go to "Settings -> Function -> Security -> PIN Edit". Enter the current PIN code, and then set a new PIN code.

5.8 Managing the PhoneBook

You can use the PhoneBook to save private, PABX and PSTN numbers. The PhoneBook feature allows you to add, view, search for, call, modify, and delete a contact, delete all contacts, and check the PhoneBook space.

On the home screen, press  to enter the menu, and select "PhoneBook" to perform related operations.

6. TMO Services

TMO supports either half-duplex or full-duplex operation and allows terminals to communicate via the TETRA network. For successful voice and data services in TMO, the terminal must register with the network at first, and then operates within the network coverage.

6.1 Individual Call

An individual call is a half-duplex or full-duplex call initiated by an individual user to another individual user. You can initiate or receive an individual call to or from an individual contact.

Initiating an Individual Call

- Half-duplex Individual Call

Step 1 On the home screen, press  and go to "PhoneBook" to select an individual contact.

Step 2 Hold down the **PTT** key to initiate a half-duplex individual call.

Step 3 Hold down the **PTT** key to speak after the call is established.

- Full-duplex Individual Call

Step 4 On the home screen, press  and go to "PhoneBook" to select an individual contact.

Step 5 Press  to initiate a full-duplex individual call.

Step 6 Speak at any time without any operation after the call is established.

Answering an Individual Call

- Half-duplex Individual Call

- In case of an incoming call with Direct Signaling, the terminal will emit an alert tone to indicate that the call is established successfully. At this time, no operation is required to answer the call.
- In case of an incoming call with Hook Signaling, the terminal will ring and vibrate to indicate this incoming call. At this time, press the **PTT** key to answer the call.

Hold down the **PTT** key to speak after the call is established.

- Full-duplex Individual Call

- In case of an incoming call with Direct Signaling, the terminal will emit an alert tone to indicate that the call is established successfully. At this time, no operation is required to answer the call.
- In case of an incoming call with Hook Signaling, the terminal will ring and vibrate to indicate this incoming call. At this time, press the **PTT** key to answer the call.

Speak at any time without any operation after the call is established.

Ending an Individual Call

Press  to end the call.

6.2 Group Call

A group call is a half-duplex call initiated by an individual user to a group. You can initiate a group call to the default group, and receive group calls from other members in the group.



Initiating a Group Call

On the home screen, rotate the **Group Selector** knob to select a group, and hold down the **PTT** key to initiate a call to this group.

Answering a Group Call

You can answer a group call without any operation.

Ending/Exiting a Group Call

- Press  to end an outgoing group call.
- Press  to exit an incoming group call.

6.3 PABX/PSTN Call

A PABX/PSTN call is a full-duplex individual call with Hook Signaling established between an individual user and a PABX or PSTN user outside the TETRA network.

For the operations of answering or ending a PABX/PSTN call, see [6.1 Individual Call](#). The operations for initiating a PABX/PSTN call are as follows:

Initiating a PABX/PSTN Call

Step 1 On the home screen, press  and go to "Settings -> Network -> PABX GW/PSTN GW".

Step 2 Enter a PABX or PSTN number on the home screen.

Step 3 If  is available, press  to select "PABX" or "PSTN".

Skip this step if  is unavailable.

Step 4 Press  to initiate the call.

6.4 Emergency Call

An emergency call is a call initiated by an individual user to the predefined contact for summoning help in urgent situations. With the highest priority, it can interrupt any other ongoing calls with lower priority if no resource is available.

Initiating an Emergency Call

Press the **Emergency** key to initiate an emergency call to the predefined contact that can be an individual user, a group, or a PABX/PSTN user.

Answering an Emergency Call

You can answer an emergency call without any operation.

As for an emergency PABX/PSTN call, you need to press the **PTT** key to answer the call.

Ending/Exiting an Emergency Call

The operations of ending or exiting an emergency call vary with the type of the predefined contact. For details, see [6.1 Individual Call](#), [6.2 Group Call](#), and [6.3 PABX/PSTN Call](#).

6.5 Message

Message is a type of data service that includes status message and user message. Status message, which can be programmed by your dealer only, facilitates instant messaging of the frequently-used messages; you can only send or view rather than edit such messages. User message can be created, edited and sent in the form of text freely.

Sending a Message

Step 1 On the home screen, press  and go to "Message -> New Msg".

Step 2 Select "Status Msg" to choose an appropriate status code, and then go to "View -> Options" to select "Individual" or "Group"; or
select "User Msg", edit the text, and then press  to select "Individual" or "Group".

Step 3 Enter the individual number or select a group contact, and press  to send the message.

Viewing a Message

Step 1 On the home screen, press , go to "Message -> Inbox", and select the appropriate message.

Step 2 Press  to view the content.

7. DMO Services

DMO supports half-duplex operation only and allows terminals to communicate directly.

7.1 Individual Call

An individual call is a half-duplex call initiated by an individual user to another individual user. You can initiate or receive an individual call to or from an individual contact.

Initiating an Individual Call

Step 1 On the home screen, press  and go to "PhoneBook" to select an individual contact.

Step 2 Hold down the **PTT** key to initiate the call.

Step 3 Hold down the **PTT** key to speak after the call is established.

Answering an Individual Call

You can answer an individual call without any operation.

Ending an Individual Call

Press  to end the call.

7.2 Group Call

A group call is a half-duplex call initiated by an individual user to a group. The group call operation in DMO is similar to that in TMO. For details, see [6.2 Group Call](#).

7.3 Emergency Call

An emergency call is a call initiated by an individual user to the default group for summoning help in urgent situations. With the highest priority, it can interrupt any other ongoing calls with lower priority if no resource is available.



Initiating an Emergency Call

Press the **Emergency** key to initiate an emergency call to the default group.

Answering an Emergency Call

You can answer an emergency call without any operation.

Ending/Exiting an Emergency Call

- Press  to end an outgoing emergency call.
- Press  to exit an incoming emergency call.

7.4 Message

The message operation in DMO is similar to that in TMO. For details, see [6.5 Message](#).

8. Troubleshooting

Phenomenon	Analysis	Solution
The terminal cannot be powered on.	The battery power gets too low to supply the terminal.	Charge the battery.
Network registration fails or no network is found.	The terminal is operating in DMO.	Switch to TMO.
	The terminal gets out of the network coverage.	Check the signal strength. Make sure the terminal is within the network coverage.
	The terminal is not granted access to the network.	Contact the network operator for terminal authorization.
Calls cannot be initiated.	The terminal or the target terminal (the called party) is not within the network coverage.	Check the signal strength. Make sure the terminals are within the network coverage.
	The terminal operates in an improper mode.	Check the operation mode. Make sure the terminals work in the proper mode.
A group call cannot be initiated or received.	The terminal is not a member of the group.	Contact your dealer to add the terminal to the group.
	The terminal is not authorized to access the target group.	Contact the network operator for terminal authorization.
Calls are always interrupted.	The current channel is assigned to emergency calls or other calls with higher priority.	Wait until the channel becomes available and try again.
A half-duplex call cannot be established.	The predefined time period for establishing a call expires.	Make sure the call is established within the predefined time period.
	The channel is occupied by another terminal with higher call priority.	Wait until the channel becomes available and try again.
	The channel resources are allocated	Wait until the channel becomes

	to other services due to overloaded network.	available and try again.
Abnormal disconnection occurs during a call.	The terminal gets out of the network coverage.	Check the signal strength. Make sure the terminal is within the network coverage.
	The terminal operates at an unfavorable position where communication may be blocked by high buildings or frustrated in the underground areas (in DMO).	Move to an open and flat area, and restart the terminal.
As for the same status message ID, the content displayed at the receiving party is different from that displayed at the sending party.	The same status message ID has been assigned with different contents.	Make sure the status message ID is assigned with the same content.

If the above solutions cannot fix your problems, or you have some other queries, please contact us or your local dealer for more technical support.

9. Care and Cleaning

To guarantee optimal performance as well as a long service life of the product, please follow the tips below.

Product Care

- Do not pierce or scrape the product.
- Keep the product far away from substances that can corrode the circuit.
- Do not hold the product by its antenna or earpiece cable.
- Close the accessory connector cover when no accessory is in use.

Product Cleaning



Caution

Power off the product and remove the battery before cleaning.

- Clean up the dust and fine particles on the product surface and charging piece with a clean and dry lint-free cloth or a brush regularly.
- Use neutral cleanser and a non-woven fabric to clean the keys, control knobs and front case after long-time use. Do not use chemical preparations such as stain removers, alcohol, sprays or oil preparations, so as to avoid surface damage.
- Make sure the product is completely dry before use.

10. Optional Accessories

Contact your local dealer for the optional accessories of the product.

Caution

Use the accessories specified by the Company only; otherwise, we shall not be liable for any losses or damages arising out of use of unauthorized accessories.