



# RF TEST REPORT

**Applicant** Hytera Communications  
Corporation Limited

**FCC ID** YAMPNC380S

**Product** PoC Radio

**Brand** Hytera

**Model** PNC380S

**Report No.** R2004A0208-R5

**Issue Date** June 12, 2020

TA Technology (Shanghai) Co., Ltd. tested the above equipment in accordance with the requirements in **FCC CFR47 Part 15C (2019)**. The test results show that the equipment tested is capable of demonstrating compliance with the requirements as documented in this report.

Performed by: Peng Tao

Approved by: Kai Xu

---

**TA Technology (Shanghai) Co., Ltd.**

No.145, Jintang Rd, Tangzhen Industry Park, Pudong Shanghai, China

TEL: +86-021-50791141/2/3

FAX: +86-021-50791141/2/3-8000



# TABLE OF CONTENT

- 1. Test Laboratory ..... 4
  - 1.1. Notes of the test report..... 4
  - 1.2. Test facility ..... 4
  - 1.3. Testing Location..... 4
- 2. General Description of Equipment under Test..... 5
  - 2.1. Applicant and Manufacturer Information..... 5
  - 2.2. General information..... 5
- 3. Applied Standards ..... 7
- 4. Test Configuration ..... 8
- 5. Test Case Results ..... 9
  - 5.1. Maximum output power ..... 9
  - 5.2. Unwanted Emission ..... 11
  - 5.3. Conducted Emission ..... 43
- 6. Main Test Instruments..... 46



## Summary of measurement results

Number	Test Case	Clause in FCC rules	Verdict
1	Maximum conducted output power	15.247(b)(3)	PASS
2	Unwanted Emissions	15.247(d),15.205,15.209	PASS
3	Conducted Emissions	15.207	PASS
Date of Testing: April 25, 2020~ June 4, 2020			
Note: All indications of Pass/Fail in this report are opinions expressed by TA Technology (Shanghai) Co., Ltd. based on interpretations and/or observations of test results. Measurement Uncertainties were not taken into account and are published for informational purposes only.			

**There is only tested Maximum conducted output power, Unwanted Emissions and Conducted Emissions in this report. For other conducted test results please refers to the module report(Report No.: FR741007C).**



## 1. Test Laboratory

### 1.1. Notes of the test report

This report shall not be reproduced in full or partial, without the written approval of **TA technology (shanghai) co., Ltd.** The results documented in this report apply only to the tested sample, under the conditions and modes of operation as described herein .Measurement Uncertainties were not taken into account and are published for informational purposes only. This report is written to support regulatory compliance of the applicable standards stated above.

### 1.2. Test facility

#### **FCC (Designation number: CN1179, Test Firm Registration Number: 446626)**

TA Technology (Shanghai) Co., Ltd. has been listed on the US Federal Communications Commission list of test facilities recognized to perform electromagnetic emissions measurements.

#### **A2LA (Certificate Number: 3857.01)**

TA Technology (Shanghai) Co., Ltd. has been listed by American Association for Laboratory Accreditation to perform electromagnetic emission measurement.

### 1.3. Testing Location

Company: TA Technology (Shanghai) Co., Ltd.  
Address: No.145, Jintang Rd, Tangzhen Industry Park, Pudong  
City: Shanghai  
Post code: 201201  
Country: P. R. China  
Contact: Xu Kai  
Telephone: +86-021-50791141/2/3  
Fax: +86-021-50791141/2/3-8000  
Website: <http://www.ta-shanghai.com>  
E-mail: [xukai@ta-shanghai.com](mailto:xukai@ta-shanghai.com)

## 2. General Description of Equipment under Test

### 2.1. Applicant and Manufacturer Information

Applicant	Hytera Communications Corporation Limited
Applicant address	Hytera Tower, Hi-Tech Industrial Park North, 9108# Beihuan Road, Nanshan District, Shenzhen, People's Republic of China
Manufacturer	Hytera Communications Corporation Limited
Manufacturer address	Hytera Tower, Hi-Tech Industrial Park North, 9108# Beihuan Road, Nanshan District, Shenzhen, People's Republic of China

### 2.2. General information

EUT Description	
Model	PNC380S
IMEI	860046040051346
Hardware Version	5001010053083
Software Version	V1.0.02.000.01
Power Supply	Battery/AC adapter
Antenna Type	Internal Antenna
Antenna Connector	A permanently attached antenna (meet with the standard FCC Part 15.203 requirement)
Antenna Gain	0.1 dBi
additional beamforming gain	NA
Test Mode	802.11b 802.11g, 802.11n(HT20/HT40);
Modulation Type	802.11b: DSSS; 802.11g/n(HT20/HT40): OFDM
Max. Conducted Power	Wi-Fi 2.4G :19.05dBm
Operating Frequency Range(s)	802.11b/g/n(HT20): 2412 ~ 2462 MHz 802.11n(HT40): 2422 ~ 2452 MHz
EUT Accessory	
Adapter	Manufacturer: HUIZHOU GOLDEN LAKE INDUSTRIAL CO., LTD. Model: S010WU0500200
Battery	Manufacturer: FPR Connectivity Technology Inc. Model: BP4006
USB Cable	10cm Cable, Shielded



Note: 1. The EUT is sent from the applicant to TA and the information of the EUT is declared by the applicant.



### 3. Applied Standards

According to the specifications of the manufacturer, it must comply with the requirements of the following standards:

**Test standards:**

**FCC CFR47 Part 15C (2019) Radio Frequency Devices**

**ANSI C63.10 (2013)**

**Reference standard:**

**KDB 558074 D01 15.247 Meas Guidance v05r02**

## 4. Test Configuration

### Test Mode

The EUT has been associated with peripherals and configuration operated in a manner tended to maximize its emission characteristics in a typical application.

The radiated emission was measured in the following position: EUT stand-up position (Z axis), lie-down position (X, Y axis). The worst emission was found in lie-down position (X axis) and the loop antenna is vertical, the others are vertical and horizontal. and the worst case was recorded.

In order to find the worst case condition, Pre-tests are needed at the presence of different data rate. Preliminary tests have been done on all the configuration for confirming worst case. Data rate below means worst-case rate of each test item.

Worst-case data rates are shown as following table.

Band	Data Rate
802.11b	1 Mbps
802.11g	6 Mbps
802.11n HT20	MCS0
802.11n HT40	MCS0



## 5. Test Case Results

### 5.1. Maximum output power

#### Ambient condition

Temperature	Relative humidity	Pressure
23°C ~25°C	45%~50%	101.5kPa

#### Methods of Measurement

During the process of the testing, The EUT was connected to Power meter with a known loss. The EUT is max power transmission with proper modulation.

#### Test Setup

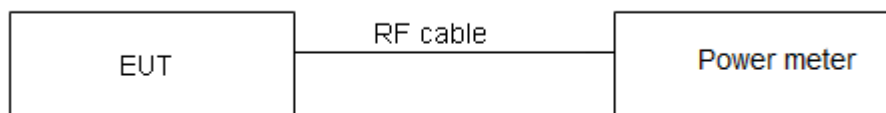

#### Limits

Rule Part 15.247 (b) (3) specifies that " For systems using digital modulation in the 902–928 MHz, 2400–2483.5 MHz: 1 Watt."

Peak Conducted Power	$\leq 1W$ (30dBm)
----------------------	-------------------

#### Measurement Uncertainty

The assessed measurement uncertainty to ensure 95% confidence level for the normal distribution is with the coverage factor  $k = 2$ ,  $U = 0.44$  dB.



## Test Results

Single Antenna Power Index			
Packet Type	CH1	CH6	CH11
802.11b	17	17	17
802.11g	14.5	14.5	14.5
802.11n HT20	14.5	14.5	14.5
Packet Type	CH3	CH6	CH9
802.11n HT40	14	14	14

Network Standards	Carrier frequency (MHz)	Peak Conducted Power (dBm)	Limit (dBm)	Conclusion
802.11b	2412	15.09	30	PASS
	2437	15.48	30	PASS
	2462	16.09	30	PASS
802.11g	2412	18.18	30	PASS
	2437	18.29	30	PASS
	2462	18.72	30	PASS
802.11n HT20	2412	18.21	30	PASS
	2437	18.41	30	PASS
	2462	18.54	30	PASS
802.11n HT40	2422	19.05	30	PASS
	2437	18.48	30	PASS
	2452	18.74	30	PASS

## 5.2. Unwanted Emission

### Ambient condition

Temperature	Relative humidity	Pressure
23°C ~25°C	45%~50%	102.5kPa

### Method of Measurement

The test set-up was made in accordance to the general provisions of ANSI C63.10-2013.

The Equipment Under Test (EUT) was set up on a non-conductive table in the semi-anechoic chamber. The test was performed at the distance of 3 m between the EUT and the receiving antenna.

The turntable shall be rotated from 0 to 360 degrees for detecting the maximum of radiated spurious signal level. The measurements shall be repeated with orthogonal polarization of the test antenna. The data of cable loss and antenna factor has been calibrated in full testing frequency range before the testing. Sweep the Restricted Band and the emissions less than 20 dB below the permissible value are reported.

The radiated emissions measurements were made in a typical installation configuration.

Sweep the whole frequency band through the range from 9 kHz to the 10th harmonic of the carrier, and the emissions less than 20 dB below the permissible value are reported.

This method refer to ANSI C63.10-2013.

The procedure for peak unwanted emissions measurements above 1000 MHz is as follows:

Set the spectrum analyzer in the following:

9kHz~150 kHz

RBW=200Hz, VBW=1kHz/ Sweep=AUTO

150 kHz~30MHz

RBW=9KHz, VBW=30KHz,/ Sweep=AUTO

Below 1GHz

RBW=100kHz / VBW=300kHz / Sweep=AUTO

a) Peak emission levels are measured by setting the instrument as follows:

Above 1GHz

PEAK: RBW=1MHz VBW=3MHz/ Sweep=AUTO

b) Average emission levels are measured by setting the instrument as follows:

Above 1GHz

AVERAGE: RBW=1MHz / VBW=3MHz / Sweep=AUTO

c) Detector: The measurements employing a CISPR quasi-peak detector except for the frequency bands 9-90 kHz, 110-490 kHz and above 1000 MHz. Radiated emission limits in these three bands are based on measurements employing an average detector.

d) Averaging type = power (i.e., rms) (As an alternative, the detector and averaging type may be set for linear voltage averaging. Some instruments require linear display mode to use linear voltage



averaging. Log or dB averaging shall not be used.)

e) Sweep time = auto.

f) Perform a trace average of at least 100 traces if the transmission is continuous. If the transmission is not continuous, then the number of traces shall be increased by a factor of  $1 / D$ , where  $D$  is the duty cycle. For example, with 50% duty cycle, at least 200 traces shall be averaged. (If a specific emission is demonstrated to be continuous—i.e., 100% duty cycle—then rather than turning ON and OFF with the transmit cycle, at least 100 traces shall be averaged.)

g) If tests are performed with the EUT transmitting at a duty cycle less than 98%, then a correction factor shall be added to the measurement results prior to comparing with the emission limit, to compute the emission level that would have been measured had the test been performed at 100% duty cycle. The correction factor is computed as follows:

1) If power averaging (rms) mode was used in the preceding step e), then the correction factor is  $[10 \log (1 / D)]$ , where  $D$  is the duty cycle. For example, if the transmit duty cycle was 50%, then 3 dB shall be added to the measured emission levels.

2) If linear voltage averaging mode was used in the preceding step e), then the correction factor is  $[20 \log (1 / D)]$ , where  $D$  is the duty cycle. For example, if the transmit duty cycle was 50%, then 6 dB shall be added to the measured emission levels.

3) If a specific emission is demonstrated to be continuous (100% duty cycle) rather than turning ON and OFF with the transmit cycle, then no duty cycle correction is required for that emission.

The test is in transmitting mode.

**Test setup**

**9KHz ~ 30MHz**

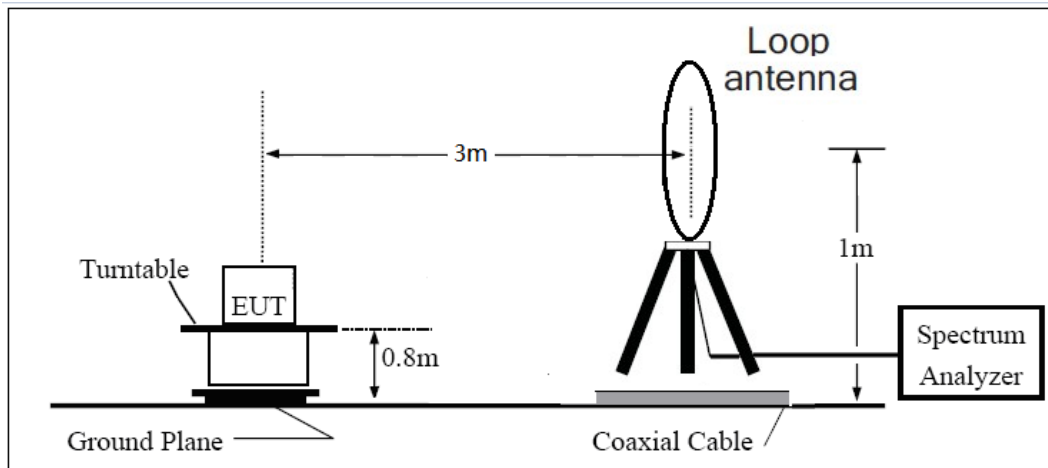

**30MHz ~ 1GHz**

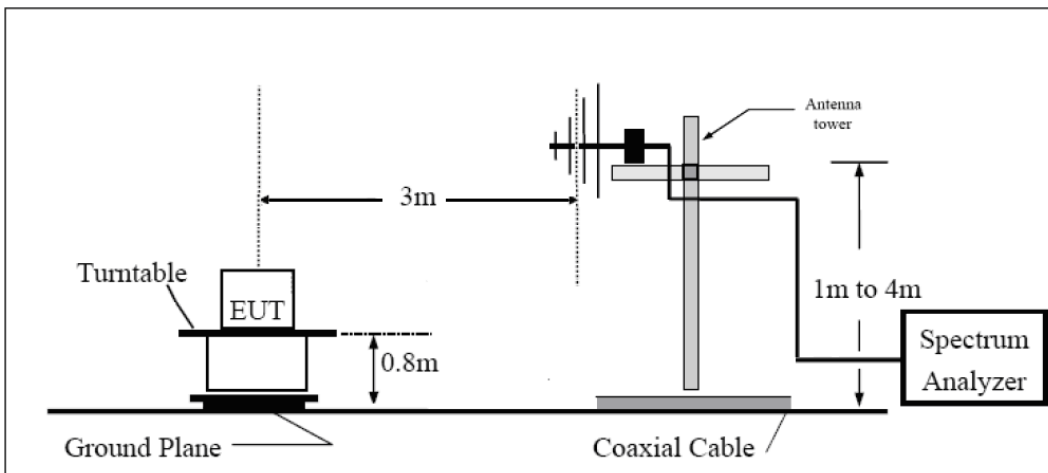

**Above 1GHz**

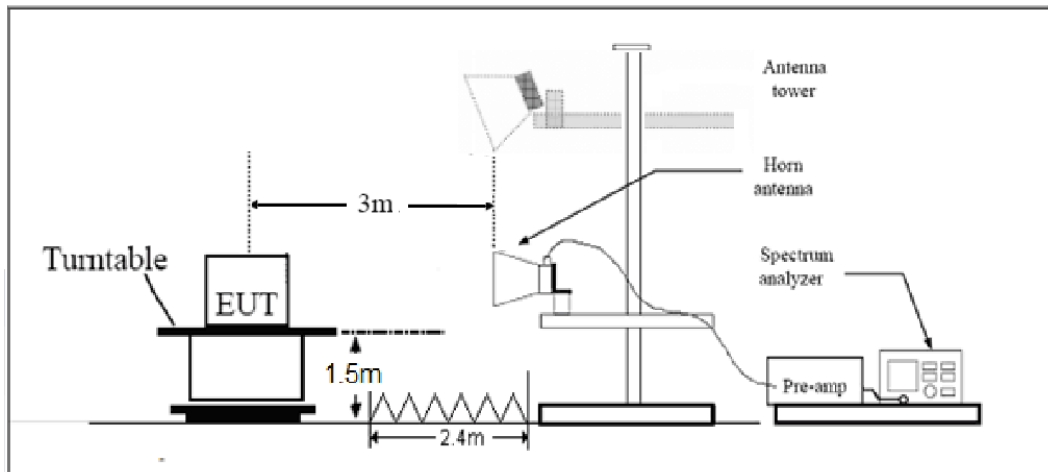

Note: Area side:2.4mX3.6m

**Limits**

Rule Part 15.247(d) specifies that "In addition, radiated emissions which fall in the restricted bands, as defined in § 15.205(a), must also comply with the radiated emission limits specified in § 15.209(a) (see § 15.205(c))."

Limit in restricted band

Frequency of emission (MHz)	Field strength(uV/m)	Field strength(dBuV/m)
0.009–0.490	2400/F(kHz)	/
0.490–1.705	24000/F(kHz)	/
1.705–30.0	30	/
30-88	100	40
88-216	150	43.5
216-960	200	46
Above960	500	54

## §15.35(b)

There is also a limit on the radio frequency emissions, as measured using instrumentation with a peak detector function, corresponding to 20 dB above the maximum permitted average limit.

Peak Limit=74 dBuV/m

Average Limit=54 dBuV/m

Spurious Radiated Emissions are permitted in any of the frequency bands listed below:

MHz	MHz	MHz	GHz
0.090 - 0.110	16.42 - 16.423	399.9 - 410	4.5 - 5.15
<sup>1</sup> 0.495 - 0.505	16.69475 - 16.69525	608 - 614	5.35 - 5.46
2.1735 - 2.1905	16.80425 - 16.80475	960 - 1240	7.25 - 7.75
4.125 - 4.128	25.5 - 25.67	1300 - 1427	8.025 - 8.5
4.17725 - 4.17775	37.5 - 38.25	1435 - 1626.5	9.0 - 9.2
4.20725 - 4.20775	73 - 74.6	1645.5 - 1646.5	9.3 - 9.5
6.215 - 6.218	74.8 - 75.2	1660 - 1710	10.6 - 12.7
6.26775 - 6.26825	108 - 121.94	1718.8 - 1722.2	13.25 - 13.4
6.31175 - 6.31225	123 - 138	2200 - 2300	14.47 - 14.5
8.291 - 8.294	149.9 - 150.05	2310 - 2390	15.35 - 16.2
8.362 - 8.366	156.52475 - 156.52525	2483.5 - 2500	17.7 - 21.4
8.37625 - 8.38675	156.7 - 156.9	2690 - 2900	22.01 - 23.12
8.41425 - 8.41475	162.0125 - 167.17	3260 - 3267	23.6 - 24.0
12.29 - 12.293	167.72 - 173.2	3332 - 3339	31.2 - 31.8
12.51975 - 12.52025	240 - 285	3345.8 - 3358	36.43 - 36.5
12.57675 - 12.57725	322 - 335.4	3600 - 4400	( <sup>2</sup> )
13.36 - 13.41			

**Measurement Uncertainty**

The assessed measurement uncertainty to ensure 95% confidence level for the normal distribution is with the coverage factor  $k = 1.96$ .

Frequency	Uncertainty
9KHz-30MHz	3.55 dB
30MHz-200MHz	4.17 dB
200MHz-1GHz	4.84 dB
1-18GHz	4.35 dB
18-26.5GHz	5.90 dB
26.5GHz~40GHz	5.92 dB



Test Results:

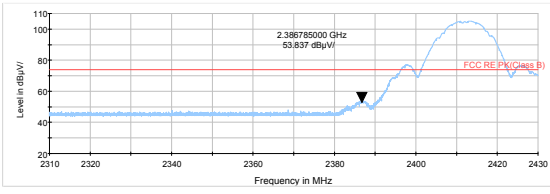

802.11b-Channel 1 Peak

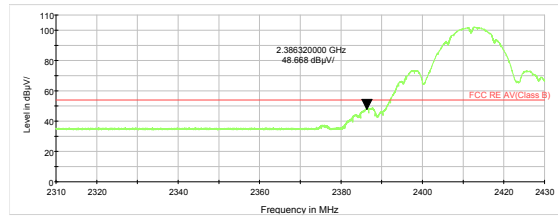

802.11b-Channel 1 Average

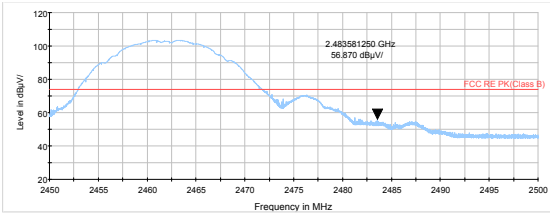

802.11b-Channel 11 Peak

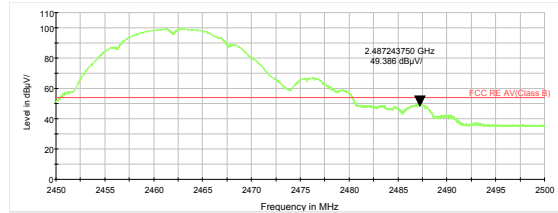

802.11b-Channel 11 Average

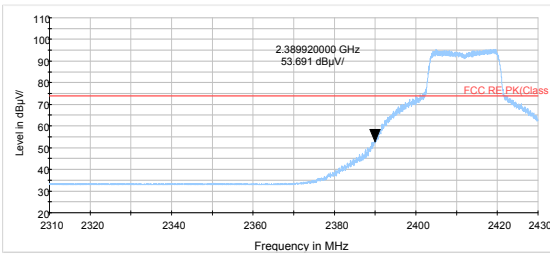

802.11g-Channel 1 Peak

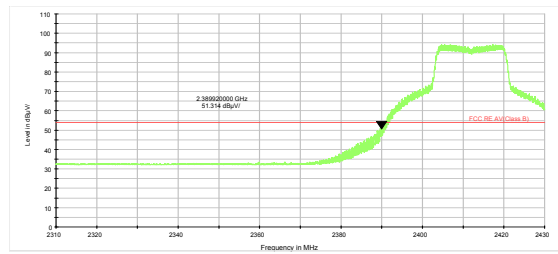

802.11g-Channel 1 Average

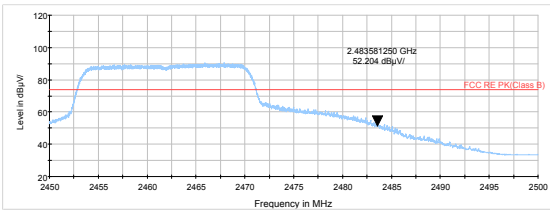

802.11g-Channel 11 Peak

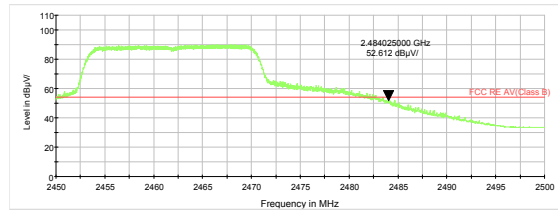

802.11g-Channel 11 Average

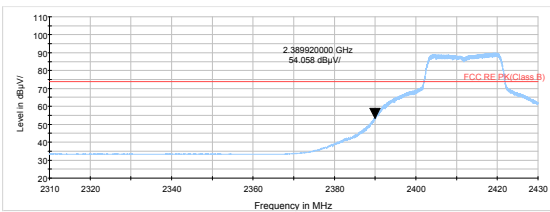

802.11n HT20 -Channel 1 Peak

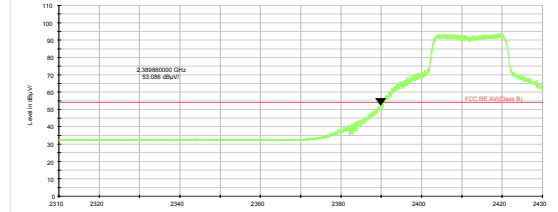

802.11n HT20 -Channel 1 Average

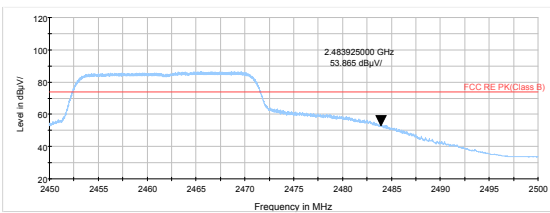

802.11n HT20 -Channel 11 Peak

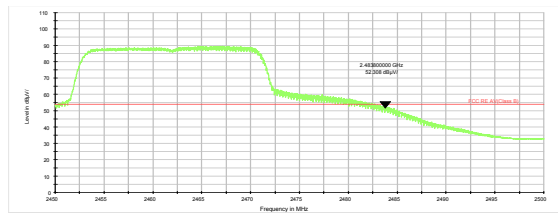

802.11n HT20 -Channel 11 Average



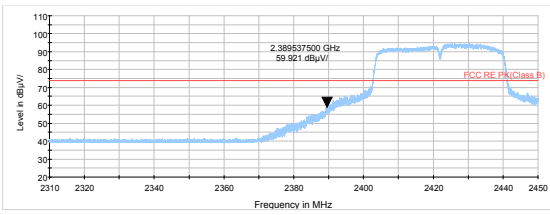

802.11n HT40 -Channel 3 Peak

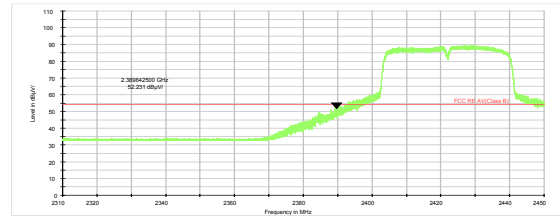

802.11n HT40 -Channel 3 Average

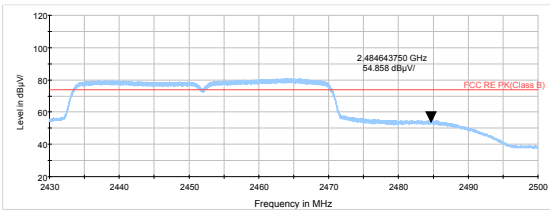

802.11n HT40 -Channel 9 Peak

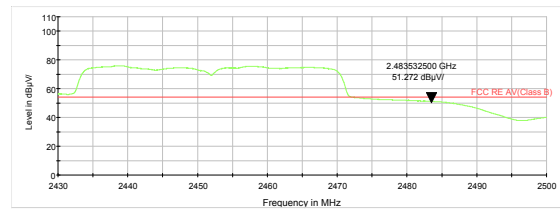

802.11n HT40 -Channel 9 Average

**Result of RE**

**Test result**

Sweep the whole frequency band through the range from 9kHz to the 10th harmonic of the carrier, the Emissions in the frequency band 9kHz-30MHz and 18GHz-26.5GHz are more than 20dB below the limit are not reported.

The following graphs display the maximum values of horizontal and vertical by software. For above 1GHz, Blue trace uses the peak detection, Green trace uses the average detection.

During the test, the Radiates Emission from 30MHz to 1GHz was performed in all modes with all channels, 802.11g, Channel 1 are selected as the worst condition. The test data of the worst-case condition was recorded in this report.

**Continuous TX mode:**

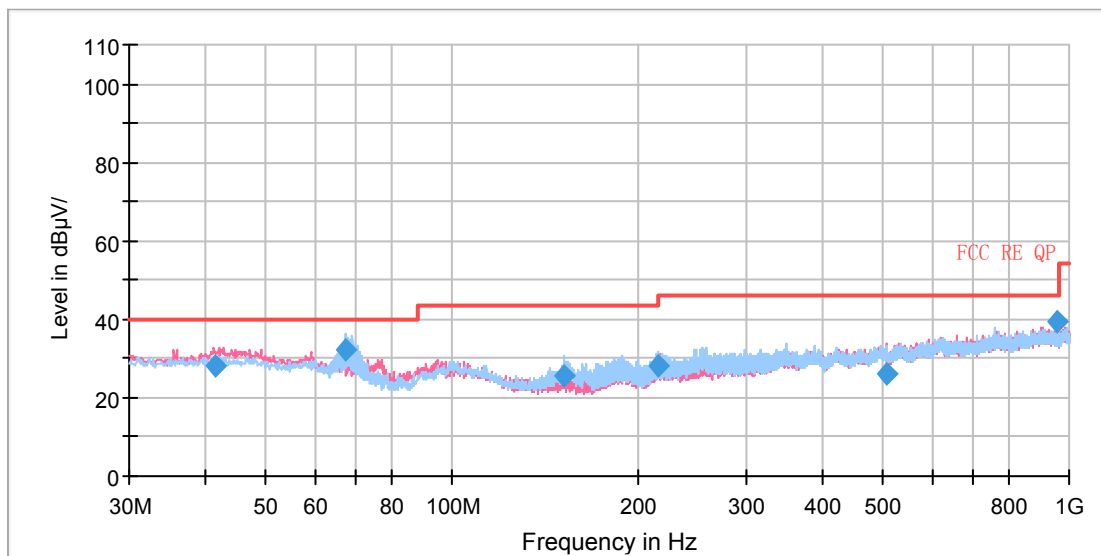

Radiates Emission from 30MHz to 1GHz

Frequency (MHz)	Quasi-Peak (dBuV/m)	Height (cm)	Polarization	Azimuth (deg)	Correct Factor (dB)	Margin (dB)	Limit (dBuV/m)
41.257888	27.99	100.0	V	298.0	1.1	12.01	40.00
67.336638	32.42	222.0	H	155.0	-4.4	7.58	40.00
152.239450	25.69	203.0	H	173.0	-7.9	17.81	43.50
215.856750	28.26	125.0	H	72.0	-4.9	15.24	43.50
505.770000	26.33	175.0	V	0.0	1.6	19.67	46.00
959.666750	39.43	100.0	V	212.0	6.5	6.57	46.00

- Remark: 1. Correction Factor = Antenna factor+ Insertion loss(cable loss+amplifier gain)
- 2. Margin = Limit – Quasi-Peak

## 802.11b CH1

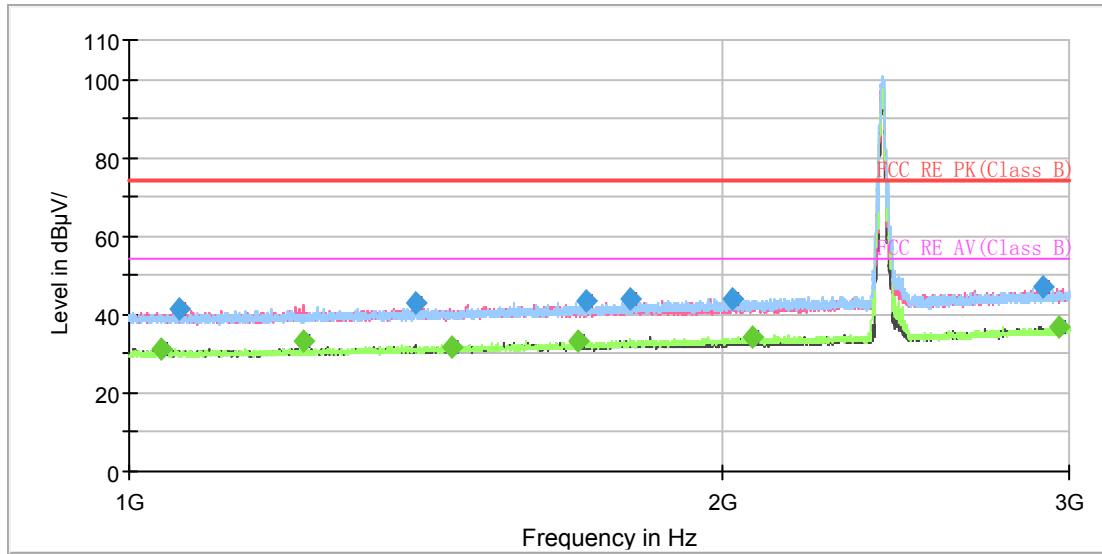

Note: The signal beyond the limit is carrier.  
Radiates Emission from 1GHz to 3GHz

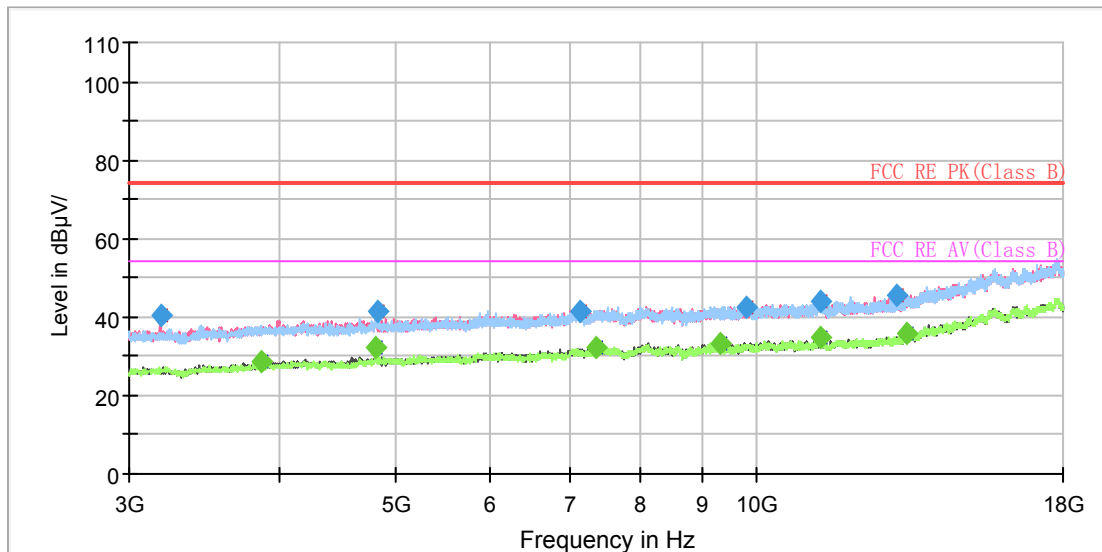

Radiates Emission from 3GHz to 18GHz



Frequency (MHz)	MaxPeak (dB $\mu$ V/m)	Average (dB $\mu$ V/m)	Limit (dB $\mu$ V/m)	Margin (dB)	Meas. Time (ms)	Height (cm)	Pol	Azimuth (deg)	Corr. (dB/m)
1038.500000	---	31.19	54.00	22.81	200.0	200.0	V	60.0	-8.6
1060.250000	41.40	---	74.00	32.60	200.0	100.0	V	5.0	-8.5
1225.500000	---	33.23	54.00	20.77	200.0	100.0	V	202.0	-7.7
1398.750000	43.11	---	74.00	30.89	200.0	200.0	V	0.0	-6.7
1457.250000	---	31.73	54.00	22.27	200.0	200.0	V	334.0	-6.4
1688.250000	---	33.06	54.00	20.94	200.0	100.0	H	348.0	-5.1
1706.750000	43.48	---	74.00	30.52	200.0	200.0	H	123.0	-5.0
1796.000000	44.25	---	74.00	29.75	200.0	200.0	H	232.0	-4.5
2024.750000	43.84	---	74.00	30.16	200.0	200.0	H	0.0	-3.3
2071.500000	---	34.19	54.00	19.81	200.0	200.0	H	33.0	-3.1
2910.000000	46.93	---	74.00	27.07	200.0	100.0	H	23.0	0.6
2967.250000	---	36.98	54.00	17.02	200.0	100.0	H	325.0	0.9

**Remark: 1. Correction Factor = Antenna factor+ Insertion loss (cable loss + amplifier gain)**

802.11b CH6

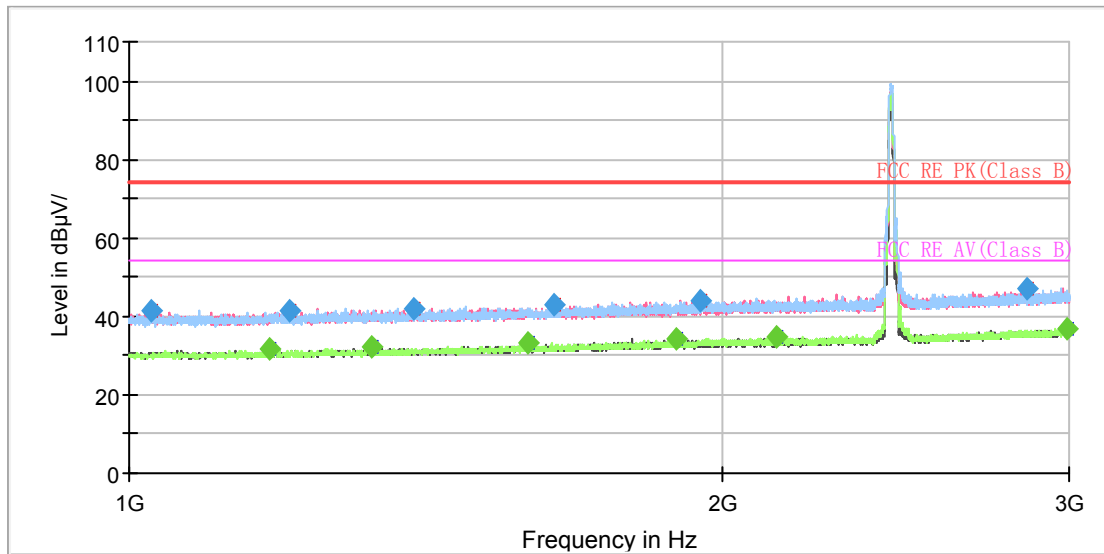

Note: The signal beyond the limit is carrier.  
Radiates Emission from 1GHz to 3GHz

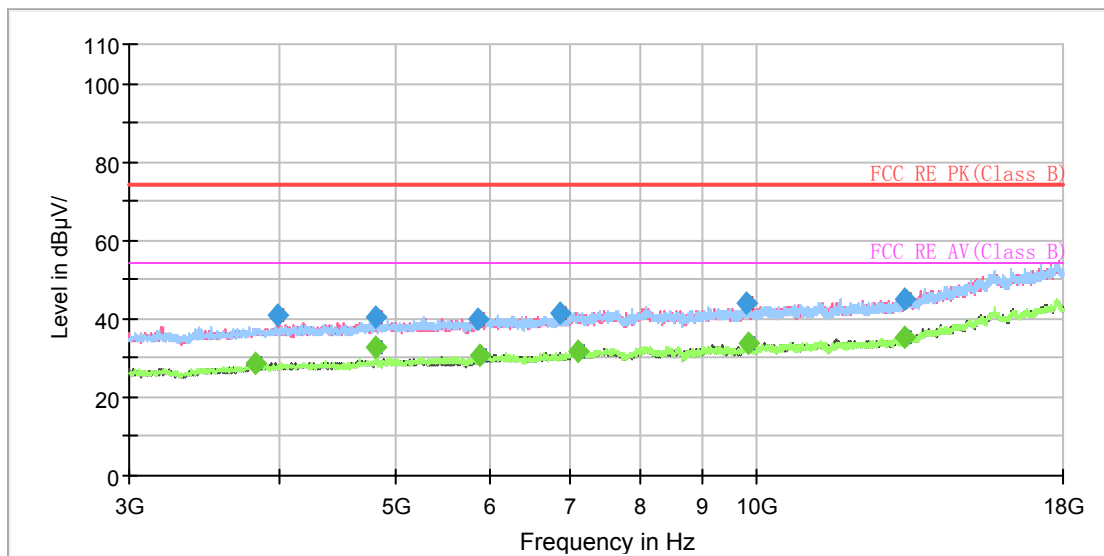

Radiates Emission from 3GHz to 18GHz



Frequency (MHz)	MaxPeak (dB $\mu$ V/m)	Average (dB $\mu$ V/m)	Limit (dB $\mu$ V/m)	Margin (dB)	Meas. Time (ms)	Height (cm)	Pol	Azimuth (deg)	Corr. (dB/m)
1027.250000	41.21	---	74.00	32.79	200.0	200.0	V	153.0	-8.8
1178.500000	---	31.48	54.00	22.52	200.0	100.0	V	124.0	-7.9
1207.500000	41.63	---	74.00	32.37	200.0	200.0	V	198.0	-7.8
1327.750000	---	32.01	54.00	21.99	200.0	200.0	H	220.0	-7.1
1396.250000	42.04	---	74.00	31.96	200.0	200.0	V	317.0	-6.7
1594.000000	---	33.20	54.00	20.80	200.0	100.0	H	31.0	-5.6
1643.750000	43.21	---	74.00	30.79	200.0	100.0	V	168.0	-5.4
1895.500000	---	34.47	54.00	19.53	200.0	100.0	H	0.0	-3.9
1950.250000	43.96	---	74.00	30.04	200.0	100.0	V	0.0	-3.6
2133.500000	---	34.58	54.00	19.42	200.0	100.0	V	219.0	-2.8
2855.750000	47.15	---	74.00	26.85	200.0	100.0	H	238.0	0.4
2993.250000	---	37.02	54.00	16.98	200.0	100.0	H	92.0	1.1

**Remark: 1. Correction Factor = Antenna factor+ Insertion loss (cable loss + amplifier gain)**

## 802.11b CH11

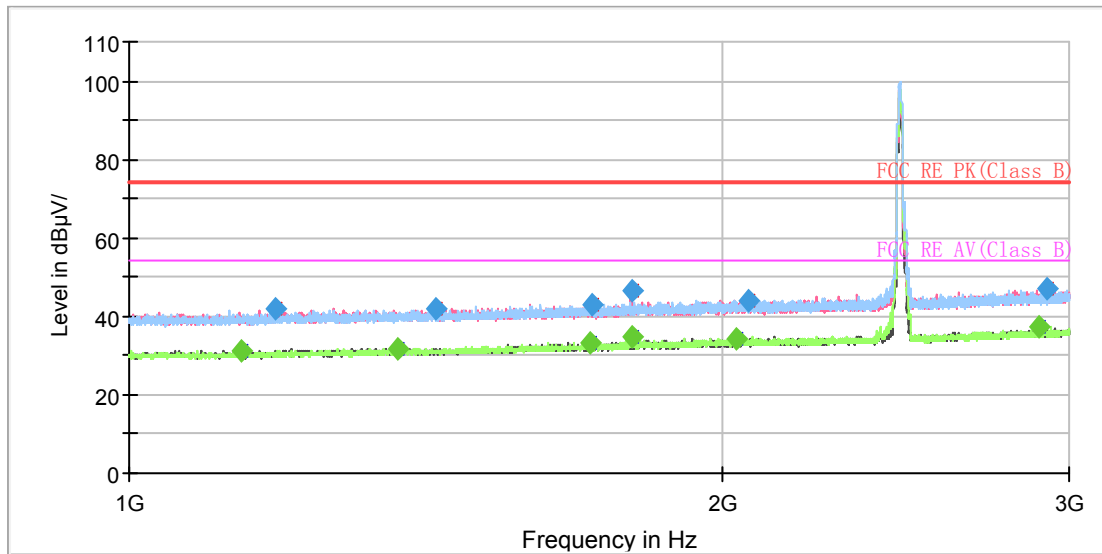

Note: The signal beyond the limit is carrier.  
Radiates Emission from 1GHz to 3GHz

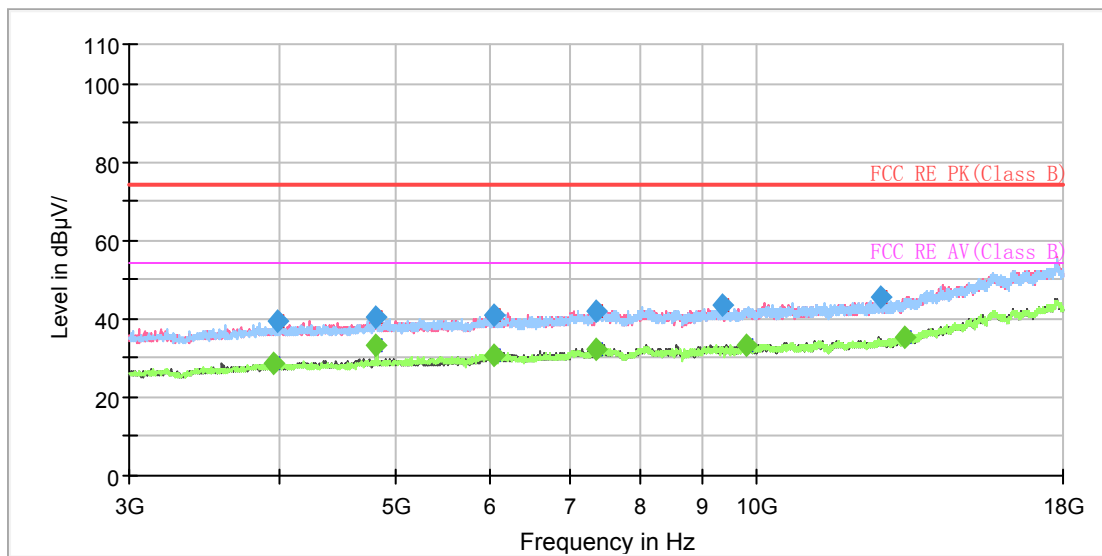

Radiates Emission from 3GHz to 18GHz



Frequency (MHz)	MaxPeak (dB $\mu$ V/m)	Average (dB $\mu$ V/m)	Limit (dB $\mu$ V/m)	Margin (dB)	Meas. Time (ms)	Height (cm)	Pol	Azimuth (deg)	Corr. (dB/m)
1139.500000	---	31.37	54.00	22.63	200.0	100.0	H	226.0	-8.2
1186.750000	41.89	---	74.00	32.11	200.0	100.0	V	166.0	-7.8
1369.000000	---	31.87	54.00	22.13	200.0	200.0	V	0.0	-6.9
1432.500000	42.15	---	74.00	31.85	200.0	200.0	V	127.0	-6.5
1714.000000	---	33.16	54.00	20.84	200.0	200.0	H	321.0	-5.0
1716.250000	42.84	---	74.00	31.16	200.0	100.0	V	332.0	-5.0
1798.250000	46.45	---	74.00	27.55	200.0	200.0	V	193.0	-4.5
1798.250000	---	35.04	54.00	18.96	200.0	200.0	V	193.0	-4.5
2034.250000	---	34.29	54.00	19.71	200.0	100.0	V	0.0	-3.2
2062.250000	44.18	---	74.00	29.82	200.0	200.0	H	204.0	-3.1
2899.500000	---	37.16	54.00	16.84	200.0	100.0	V	10.0	0.5
2926.750000	47.01	---	74.00	26.99	200.0	100.0	V	184.0	0.7

**Remark: 1. Correction Factor = Antenna factor+ Insertion loss (cable loss + amplifier gain)**





802.11g CH1

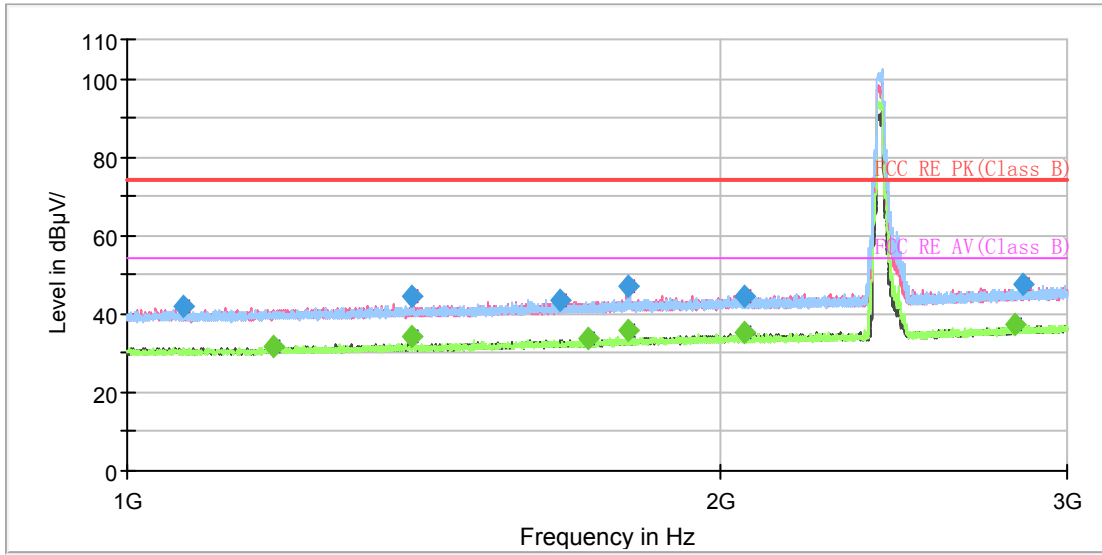

Note: The signal beyond the limit is carrier.  
Radiates Emission from 1GHz to 3GHz

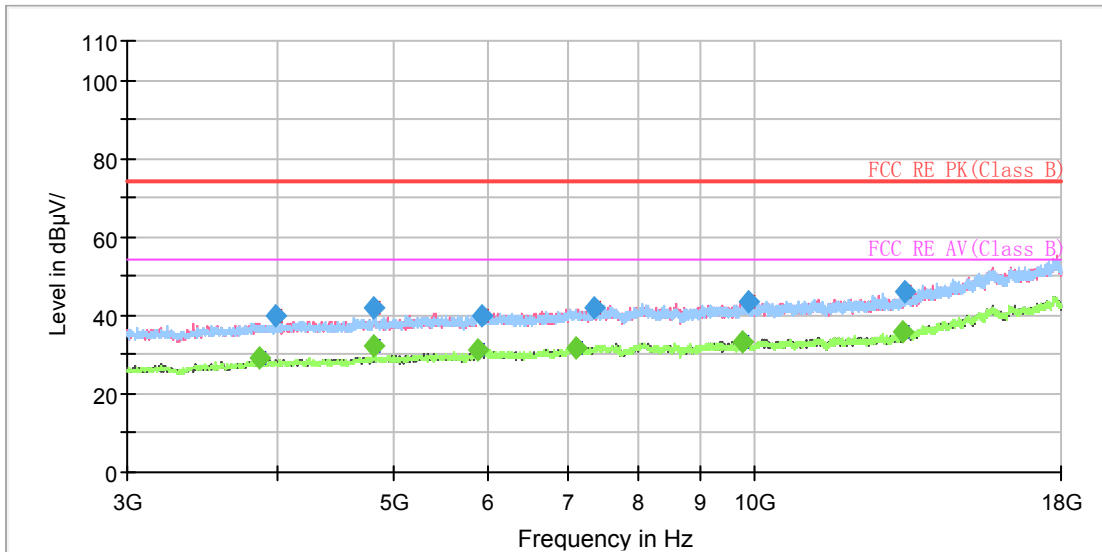

Radiates Emission from 3GHz to 18GHz



Frequency (MHz)	MaxPeak (dB $\mu$ V/m)	Average (dB $\mu$ V/m)	Limit (dB $\mu$ V/m)	Margin (dB)	Meas. Time (ms)	Height (cm)	Pol	Azimuth (deg)	Corr. (dB/m)
1066.750000	41.91	---	74.00	32.09	200.0	200.0	V	153.0	-8.5
1186.000000	---	31.74	54.00	22.26	200.0	200.0	H	0.0	-7.8
1393.500000	---	34.32	54.00	19.68	200.0	200.0	V	213.0	-6.7
1395.250000	44.41	---	74.00	29.59	200.0	200.0	V	213.0	-6.7
1659.750000	43.59	---	74.00	30.41	200.0	100.0	V	41.0	-5.2
1715.250000	---	33.56	54.00	20.44	200.0	100.0	V	127.0	-5.0
1795.000000	46.86	---	74.00	27.14	200.0	200.0	V	220.0	-4.5
1795.000000	---	35.86	54.00	18.14	200.0	200.0	V	220.0	-4.5
2057.000000	44.53	---	74.00	29.47	200.0	100.0	V	237.0	-3.1
2057.000000	---	35.06	54.00	18.94	200.0	100.0	V	237.0	-3.1
2823.750000	---	37.34	54.00	16.66	200.0	200.0	H	213.0	0.2
2846.500000	47.79	---	74.00	26.21	200.0	100.0	V	130.0	0.4

**Remark: 1. Correction Factor = Antenna factor+ Insertion loss (cable loss + amplifier gain)**

802.11g CH6

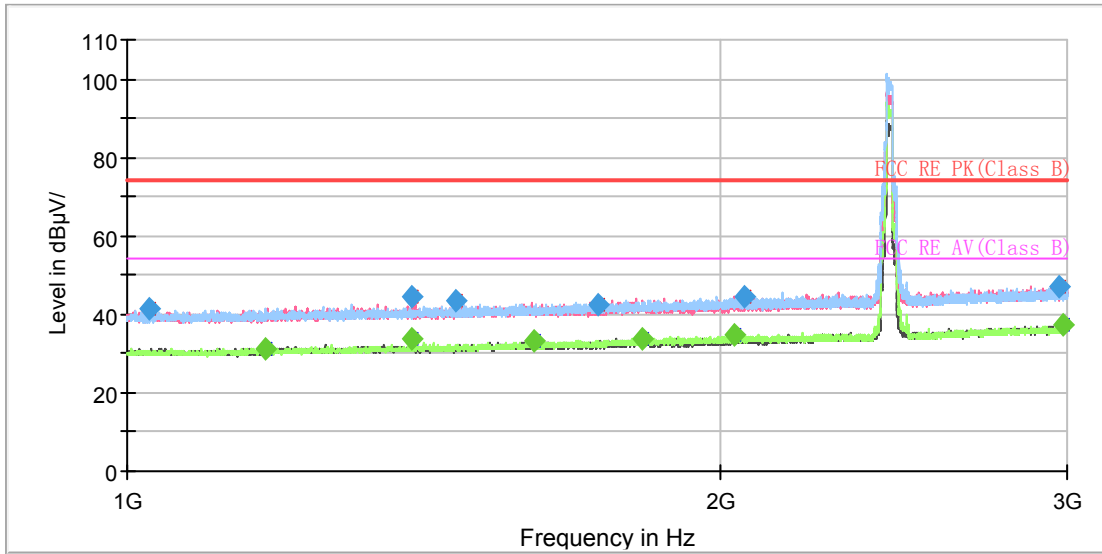

Note: The signal beyond the limit is carrier.  
Radiates Emission from 1GHz to 3GHz

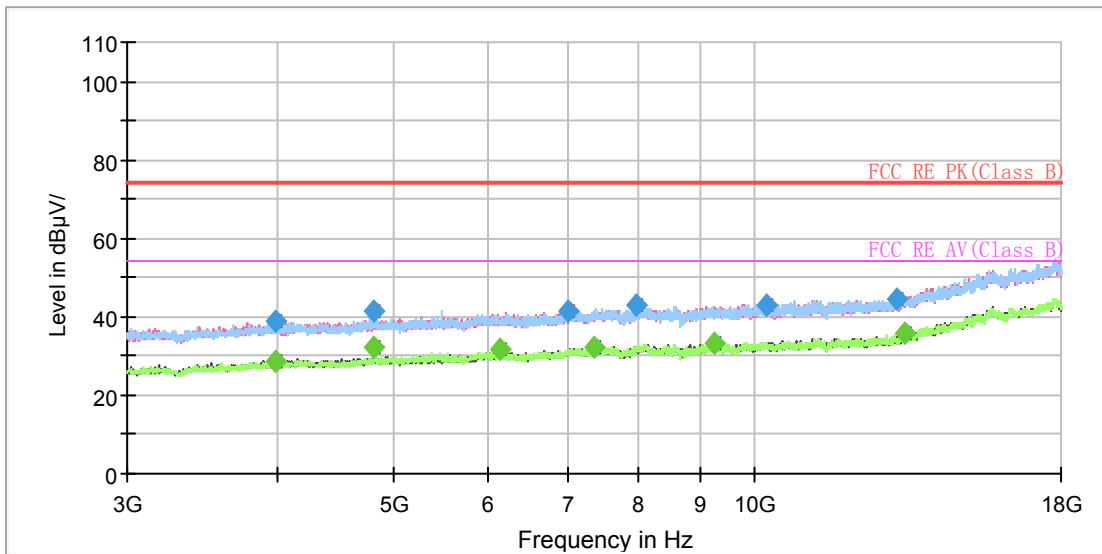

Radiates Emission from 3GHz to 18GHz



Frequency (MHz)	MaxPeak (dB $\mu$ V/m)	Average (dB $\mu$ V/m)	Limit (dB $\mu$ V/m)	Margin (dB)	Meas. Time (ms)	Height (cm)	Pol	Azimuth (deg)	Corr. (dB/m)
1026.750000	41.59	---	74.00	32.41	200.0	100.0	V	86.0	-8.8
1174.500000	---	31.44	54.00	22.56	200.0	100.0	V	86.0	-7.9
1396.000000	---	33.62	54.00	20.38	200.0	200.0	V	345.0	-6.7
1396.000000	44.33	---	74.00	29.67	200.0	200.0	V	345.0	-6.7
1467.750000	43.39	---	74.00	30.61	200.0	100.0	H	32.0	-6.4
1608.250000	---	33.45	54.00	20.55	200.0	200.0	H	191.0	-5.5
1736.000000	42.65	---	74.00	31.35	200.0	100.0	V	14.0	-4.8
1826.500000	---	33.85	54.00	20.15	200.0	200.0	V	351.0	-4.2
2035.500000	---	34.73	54.00	19.27	200.0	100.0	H	0.0	-3.2
2059.500000	44.45	---	74.00	29.55	200.0	200.0	H	252.0	-3.1
2970.750000	46.89	---	74.00	27.11	200.0	100.0	V	198.0	0.9
2985.250000	---	37.12	54.00	16.88	200.0	100.0	V	203.0	1.0

**Remark: 1. Correction Factor = Antenna factor+ Insertion loss (cable loss + amplifier gain)**

802.11g CH11

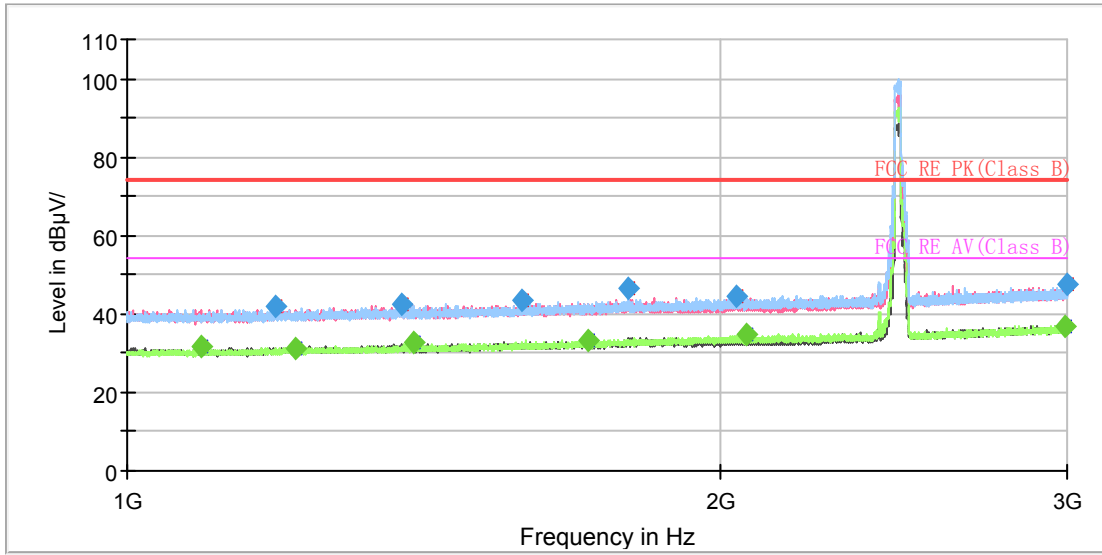

Note: The signal beyond the limit is carrier.  
Radiates Emission from 1GHz to 3GHz

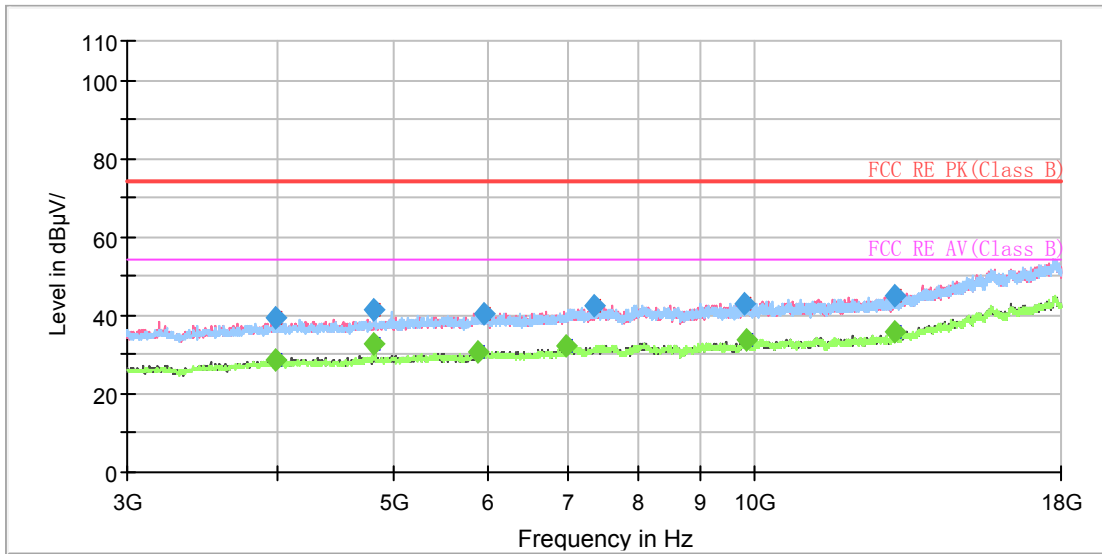

Radiates Emission from 3GHz to 18GHz



Frequency (MHz)	MaxPeak (dB $\mu$ V/m)	Average (dB $\mu$ V/m)	Limit (dB $\mu$ V/m)	Margin (dB)	Meas. Time (ms)	Height (cm)	Pol	Azimuth (deg)	Corr. (dB/m)
1090.500000	---	31.58	54.00	22.42	200.0	200.0	V	155.0	-8.4
1190.000000	41.78	---	74.00	32.22	200.0	100.0	V	0.0	-7.8
1216.250000	---	31.17	54.00	22.83	200.0	200.0	V	62.0	-7.7
1378.750000	42.40	---	74.00	31.60	200.0	100.0	V	254.0	-6.8
1398.500000	---	32.91	54.00	21.09	200.0	200.0	V	350.0	-6.7
1584.750000	43.40	---	74.00	30.60	200.0	100.0	V	260.0	-5.7
1714.250000	---	33.45	54.00	20.55	200.0	200.0	V	211.0	-5.0
1795.000000	46.60	---	74.00	27.40	200.0	200.0	V	232.0	-4.5
2038.500000	44.67	---	74.00	29.33	200.0	100.0	V	211.0	-3.2
2060.500000	---	34.54	54.00	19.46	200.0	200.0	H	232.0	-3.1
2993.000000	---	37.04	54.00	16.96	200.0	200.0	V	300.0	1.1
2999.500000	47.81	---	74.00	26.19	200.0	200.0	V	346.0	1.1

**Remark: 1. Correction Factor = Antenna factor+ Insertion loss (cable loss + amplifier gain)**

802.11n (HT20) CH1

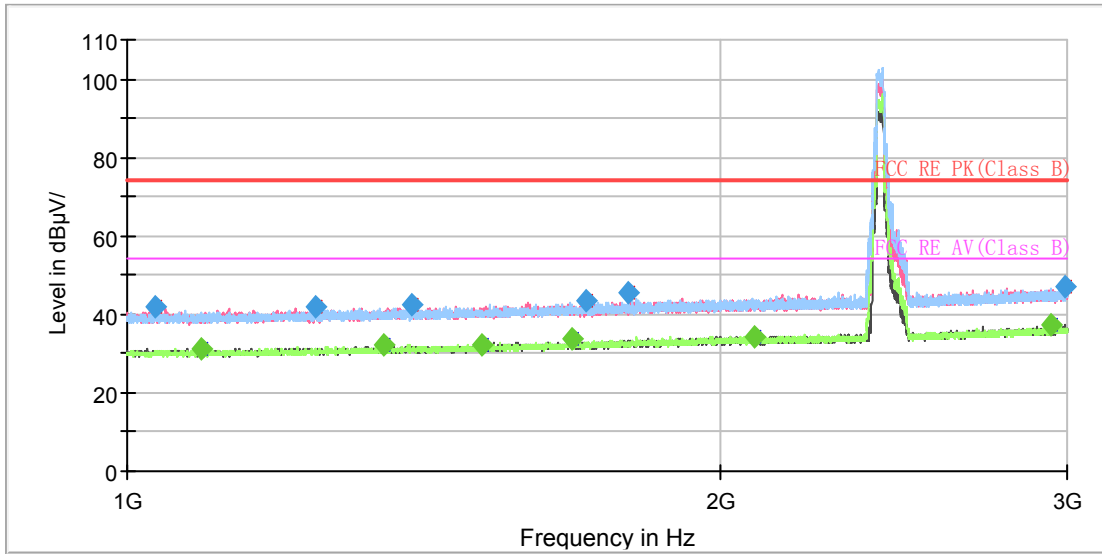

Note: The signal beyond the limit is carrier.  
Radiates Emission from 1GHz to 3GHz

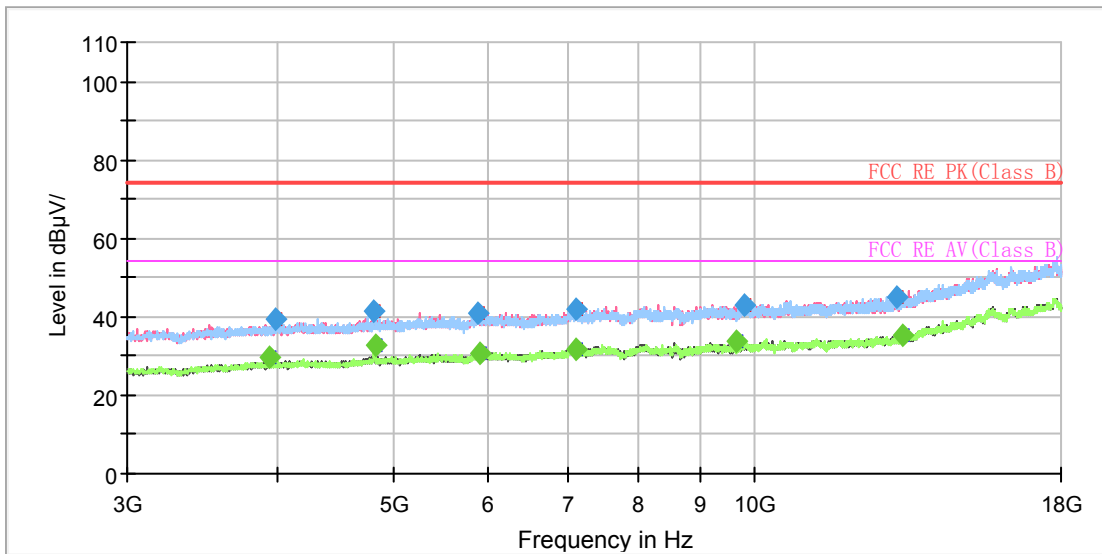

Radiates Emission from 3GHz to 18GHz



Frequency (MHz)	MaxPeak (dB $\mu$ V/m)	Average (dB $\mu$ V/m)	Limit (dB $\mu$ V/m)	Margin (dB)	Meas. Time (ms)	Height (cm)	Pol	Azimuth (deg)	Corr. (dB/m)
1033.000000	41.83	---	74.00	32.17	200.0	200.0	V	212.0	-8.7
1090.250000	---	31.41	54.00	22.59	200.0	200.0	H	118.0	-8.4
1245.500000	41.92	---	74.00	32.08	200.0	200.0	V	232.0	-7.5
1350.750000	---	32.26	54.00	21.74	200.0	100.0	V	349.0	-7.0
1396.250000	42.26	---	74.00	31.74	200.0	200.0	V	186.0	-6.7
1515.000000	---	32.32	54.00	21.68	200.0	200.0	H	150.0	-6.1
1682.250000	---	33.88	54.00	20.12	200.0	200.0	H	0.0	-5.1
1709.250000	43.40	---	74.00	30.60	200.0	200.0	H	0.0	-5.0
1796.500000	45.30	---	74.00	28.70	200.0	200.0	V	232.0	-4.5
2079.750000	---	34.43	54.00	19.57	200.0	100.0	H	221.0	-3.1
2944.750000	---	37.21	54.00	16.79	200.0	100.0	V	208.0	0.8
2994.250000	46.92	---	74.00	27.08	200.0	200.0	V	331.0	1.1

**Remark: 1. Correction Factor = Antenna factor+ Insertion loss (cable loss + amplifier gain)**



802.11n (HT20) CH6

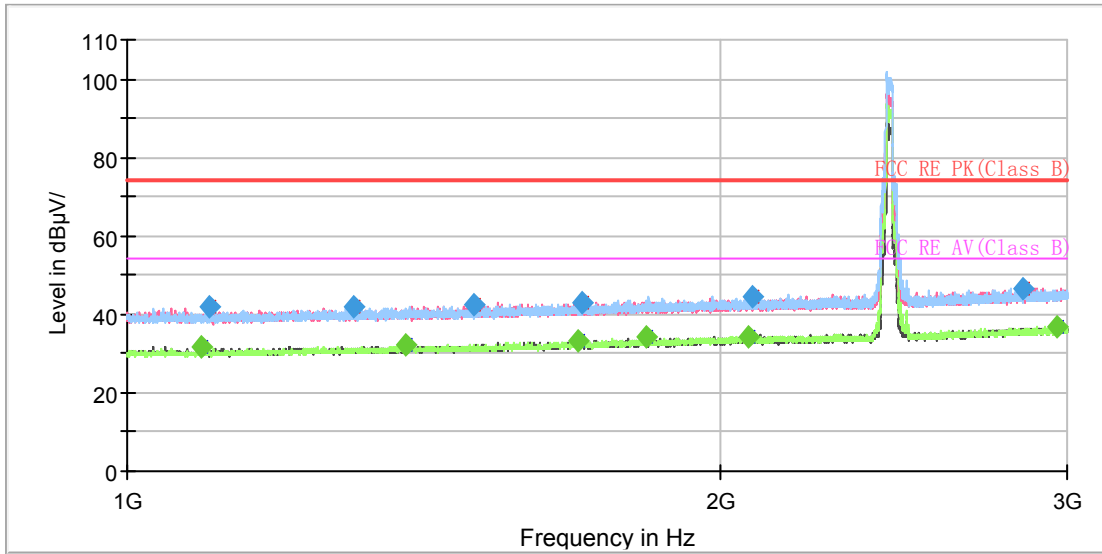

Note: The signal beyond the limit is carrier.  
Radiates Emission from 1GHz to 3GHz

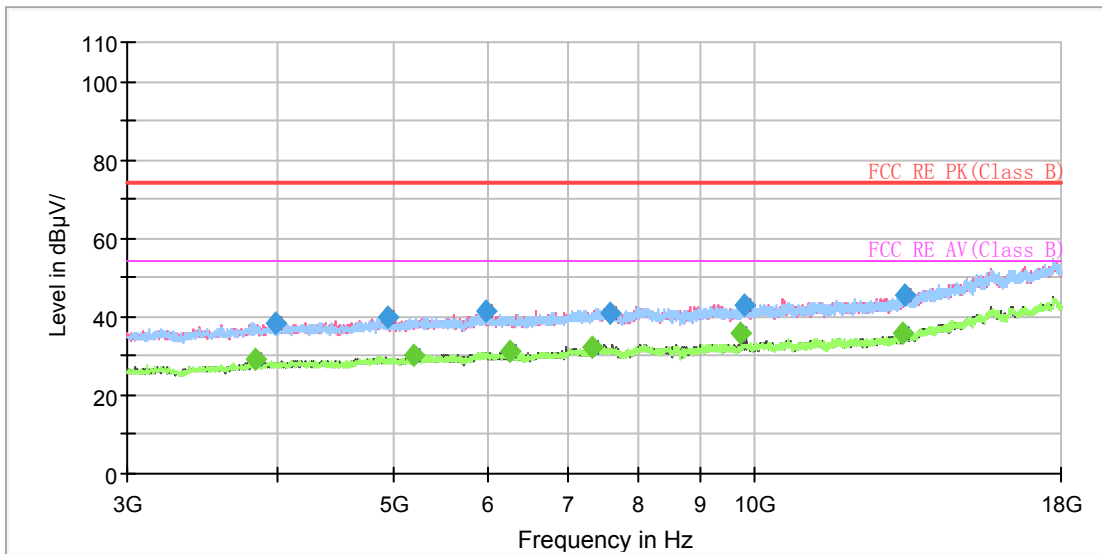

Radiates Emission from 3GHz to 18GHz



Frequency (MHz)	MaxPeak (dB $\mu$ V/m)	Average (dB $\mu$ V/m)	Limit (dB $\mu$ V/m)	Margin (dB)	Meas. Time (ms)	Height (cm)	Pol	Azimuth (deg)	Corr. (dB/m)
1091.750000	---	31.57	54.00	22.43	200.0	100.0	H	245.0	-8.4
1101.000000	42.08	---	74.00	31.92	200.0	100.0	H	71.0	-8.4
1303.500000	42.21	---	74.00	31.79	200.0	100.0	V	290.0	-7.2
1383.500000	---	31.99	54.00	22.01	200.0	100.0	H	296.0	-6.8
1500.500000	42.50	---	74.00	31.50	200.0	200.0	H	233.0	-6.2
1693.000000	---	33.20	54.00	20.80	200.0	100.0	H	63.0	-5.1
1703.250000	43.04	---	74.00	30.96	200.0	200.0	V	107.0	-5.0
1836.000000	---	34.14	54.00	19.86	200.0	100.0	V	286.0	-4.2
2064.750000	---	34.15	54.00	19.85	200.0	200.0	H	15.0	-3.1
2076.750000	44.46	---	74.00	29.54	200.0	200.0	V	350.0	-3.1
2849.750000	46.53	---	74.00	27.47	200.0	100.0	V	0.0	0.4
2963.250000	---	36.99	54.00	17.01	200.0	200.0	V	0.0	0.9

**Remark: 1. Correction Factor = Antenna factor+ Insertion loss (cable loss + amplifier gain)**

802.11n (HT20) CH11

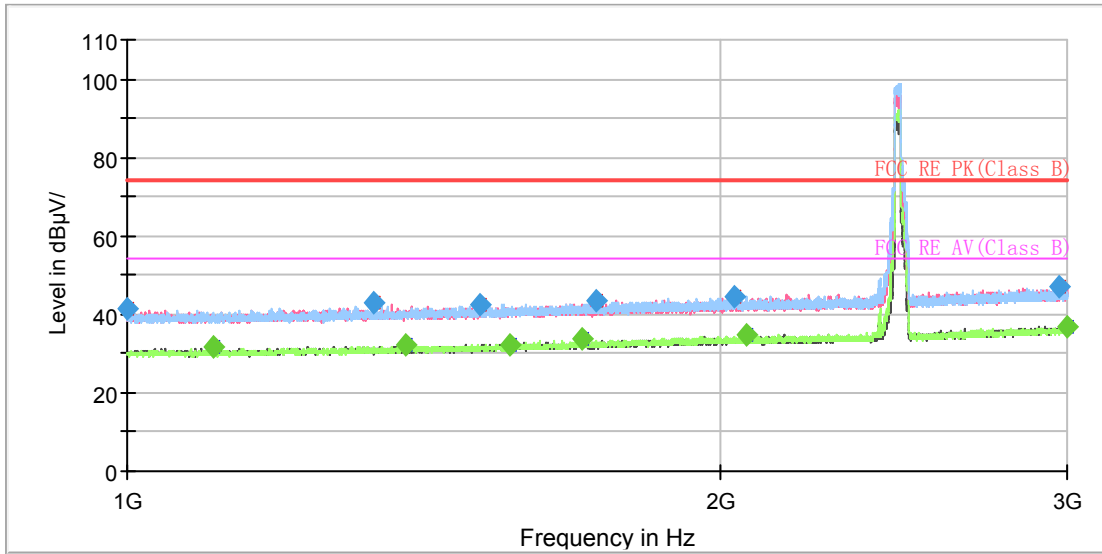

Note: The signal beyond the limit is carrier.  
Radiates Emission from 1GHz to 3GHz

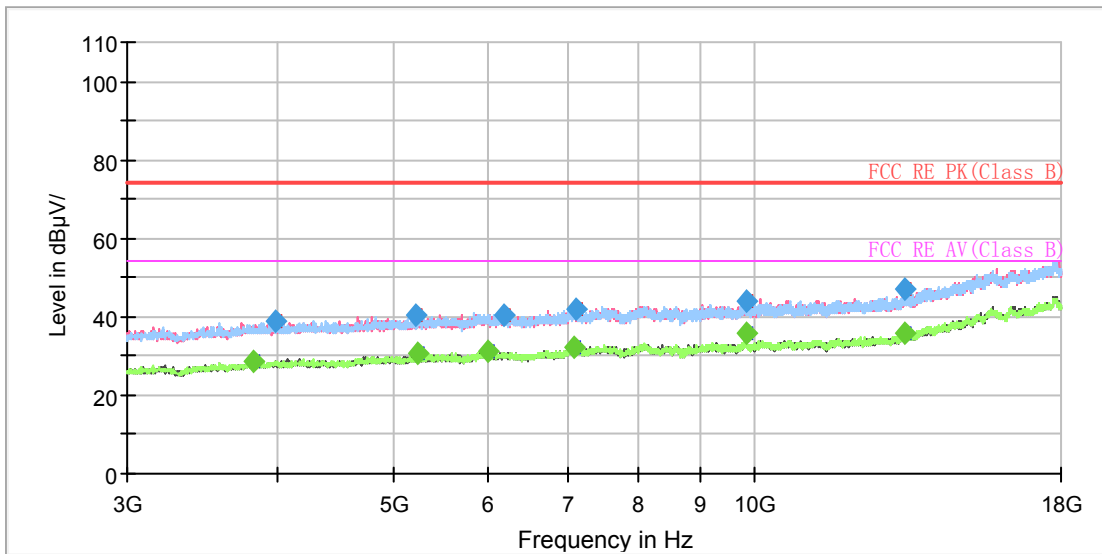

Radiates Emission from 3GHz to 18GHz



Frequency (MHz)	MaxPeak (dB $\mu$ V/m)	Average (dB $\mu$ V/m)	Limit (dB $\mu$ V/m)	Margin (dB)	Meas. Time (ms)	Height (cm)	Pol	Azimuth (deg)	Corr. (dB/m)
1001.000000	41.64	---	74.00	32.36	200.0	100.0	V	168.0	-8.9
1106.500000	---	31.48	54.00	22.52	200.0	100.0	V	277.0	-8.3
1335.000000	43.02	---	74.00	30.98	200.0	200.0	H	96.0	-7.1
1385.750000	---	32.14	54.00	21.86	200.0	100.0	V	0.0	-6.8
1511.250000	42.35	---	74.00	31.65	200.0	100.0	V	277.0	-6.1
1562.500000	---	32.39	54.00	21.61	200.0	100.0	V	42.0	-5.8
1702.500000	---	33.59	54.00	20.41	200.0	200.0	H	133.0	-5.0
1728.750000	43.25	---	74.00	30.75	200.0	200.0	H	85.0	-4.9
2031.750000	44.51	---	74.00	29.49	200.0	200.0	H	232.0	-3.2
2060.750000	---	34.54	54.00	19.46	200.0	100.0	V	277.0	-3.1
2975.500000	47.03	---	74.00	26.97	200.0	100.0	V	213.0	0.9
2997.250000	---	36.73	54.00	17.27	200.0	200.0	V	272.0	1.1

**Remark: 1. Correction Factor = Antenna factor+ Insertion loss (cable loss + amplifier gain)**

802.11n (HT40) CH3

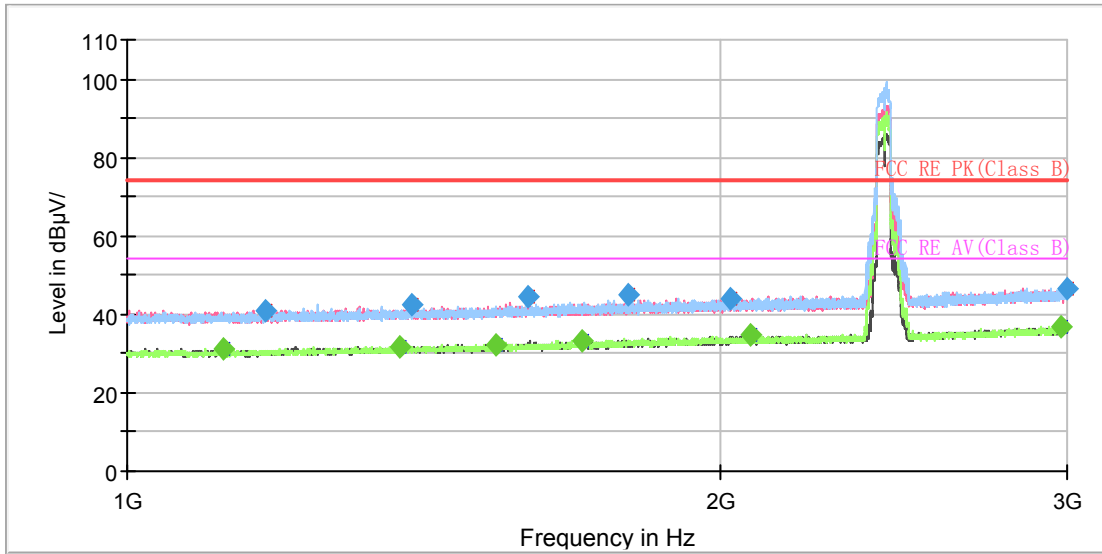

Note: The signal beyond the limit is carrier.  
Radiates Emission from 1GHz to 3GHz

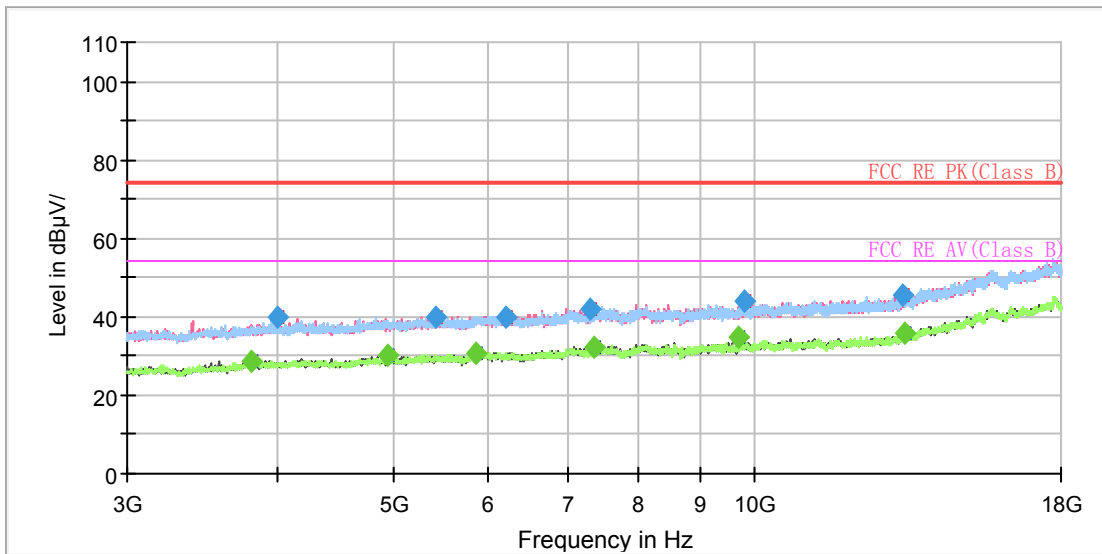

Radiates Emission from 3GHz to 18GHz



Frequency (MHz)	MaxPeak (dB $\mu$ V/m)	Average (dB $\mu$ V/m)	Limit (dB $\mu$ V/m)	Margin (dB)	Meas. Time (ms)	Height (cm)	Pol	Azimuth (deg)	Corr. (dB/m)
1119.750000	---	31.43	54.00	22.57	200.0	200.0	H	84.0	-8.2
1174.500000	41.17	---	74.00	32.83	200.0	200.0	V	0.0	-7.9
1373.750000	---	31.94	54.00	22.06	200.0	200.0	V	251.0	-6.9
1395.500000	42.60	---	74.00	31.40	200.0	200.0	V	187.0	-6.7
1538.000000	---	32.25	54.00	21.75	200.0	100.0	H	260.0	-6.0
1596.750000	44.73	---	74.00	29.27	200.0	200.0	V	176.0	-5.6
1702.000000	---	33.35	54.00	20.65	200.0	100.0	H	44.0	-5.0
1795.750000	44.91	---	74.00	29.09	200.0	200.0	V	181.0	-4.5
2022.750000	44.20	---	74.00	29.80	200.0	200.0	H	20.0	-3.3
2072.250000	---	34.57	54.00	19.43	200.0	100.0	H	233.0	-3.1
2977.750000	---	36.75	54.00	17.25	200.0	100.0	H	29.0	0.9
2999.500000	46.75	---	74.00	27.25	200.0	200.0	V	299.0	1.1

**Remark: 1. Correction Factor = Antenna factor+ Insertion loss (cable loss + amplifier gain)**

802.11n (HT40) CH6

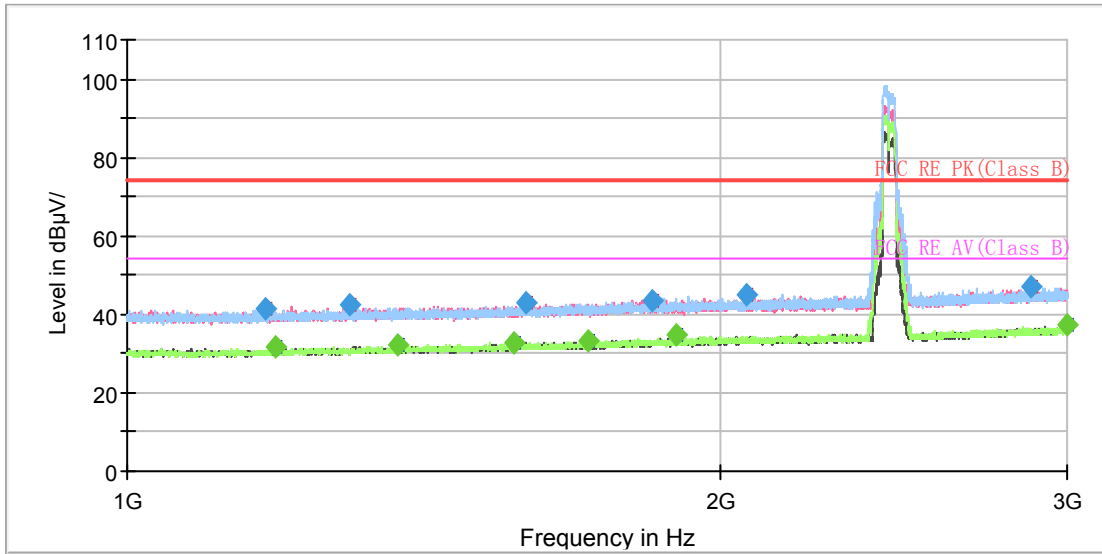

Note: The signal beyond the limit is carrier.  
Radiates Emission from 1GHz to 3GHz

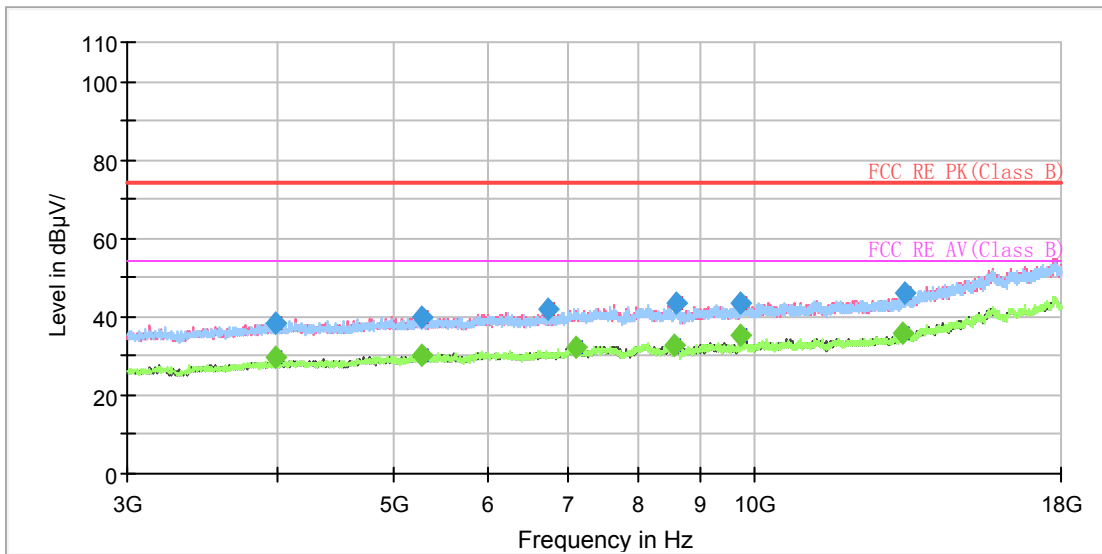

Radiates Emission from 3GHz to 18GHz



Frequency (MHz)	MaxPeak (dB $\mu$ V/m)	Average (dB $\mu$ V/m)	Limit (dB $\mu$ V/m)	Margin (dB)	Meas. Time (ms)	Height (cm)	Pol	Azimuth (deg)	Corr. (dB/m)
1174.750000	41.57	---	74.00	32.43	200.0	100.0	H	250.0	-7.9
1190.000000	---	31.48	54.00	22.52	200.0	200.0	H	104.0	-7.8
1297.250000	42.35	---	74.00	31.65	200.0	100.0	V	74.0	-7.3
1373.250000	---	32.05	54.00	21.95	200.0	100.0	H	45.0	-6.9
1570.000000	---	32.72	54.00	21.28	200.0	100.0	V	184.0	-5.7
1594.250000	43.06	---	74.00	30.94	200.0	200.0	V	191.0	-5.6
1712.500000	---	33.22	54.00	20.78	200.0	100.0	H	104.0	-5.0
1848.500000	43.57	---	74.00	30.43	200.0	100.0	H	163.0	-4.3
1902.000000	---	34.84	54.00	19.16	200.0	100.0	V	205.0	-3.9
2062.000000	45.05	---	74.00	28.95	200.0	100.0	V	63.0	-3.1
2879.000000	47.24	---	74.00	26.76	200.0	100.0	V	248.0	0.5
2999.750000	---	37.17	54.00	16.83	200.0	200.0	H	114.0	1.1

**Remark: 1. Correction Factor = Antenna factor+ Insertion loss (cable loss + amplifier gain)**



802.11n (HT40) CH9

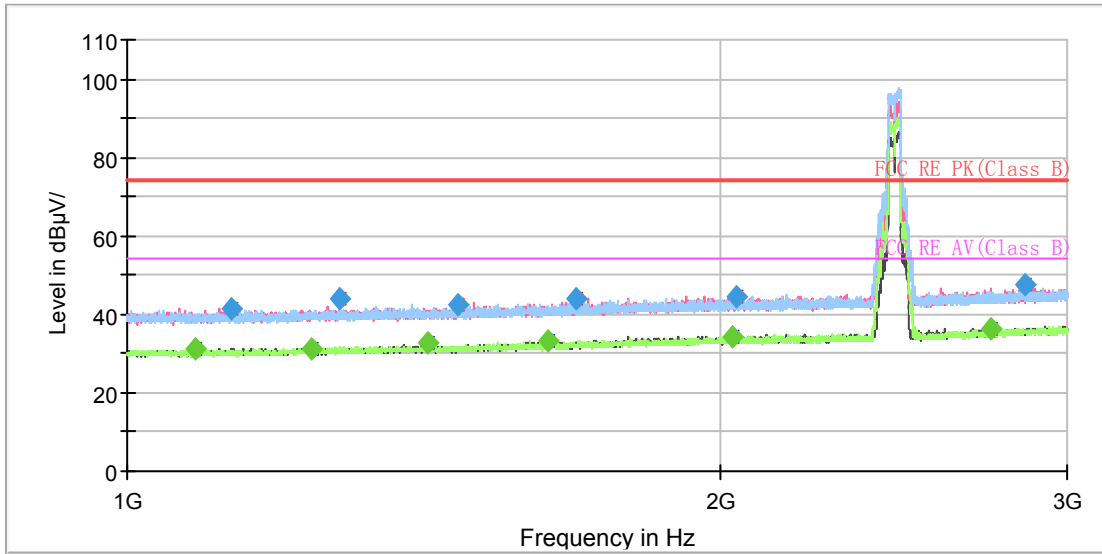

Note: The signal beyond the limit is carrier.  
Radiates Emission from 1GHz to 3GHz

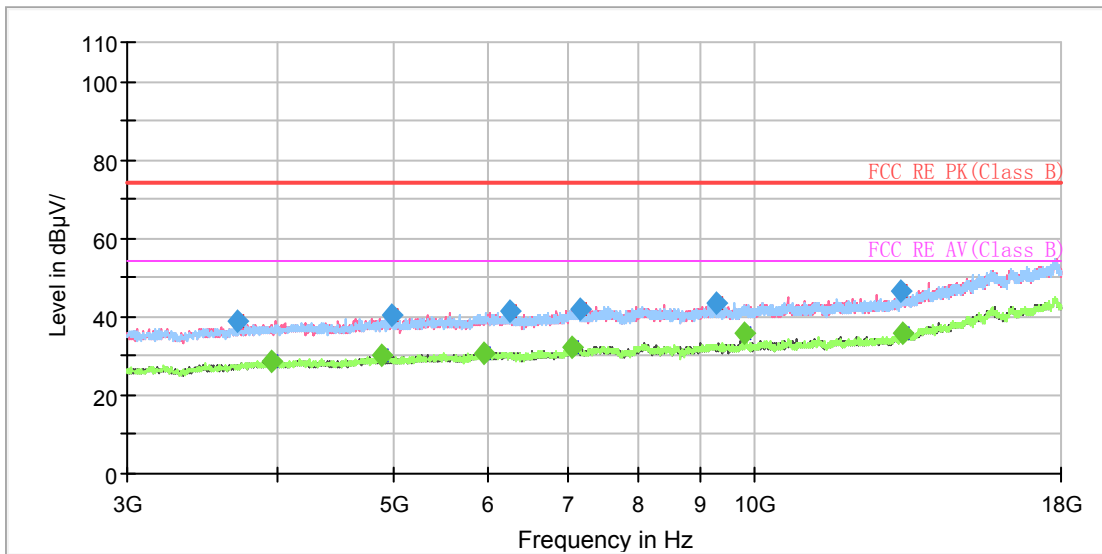

Radiates Emission from 3GHz to 18GHz



Frequency (MHz)	MaxPeak (dB $\mu$ V/m)	Average (dB $\mu$ V/m)	Limit (dB $\mu$ V/m)	Margin (dB)	Meas. Time (ms)	Height (cm)	Pol	Azimuth (deg)	Corr. (dB/m)
1082.000000	---	31.33	54.00	22.67	200.0	200.0	V	46.0	-8.4
1130.500000	41.40	---	74.00	32.60	200.0	100.0	H	26.0	-8.2
1241.500000	---	31.24	54.00	22.76	200.0	100.0	V	48.0	-7.6
1281.250000	43.90	---	74.00	30.10	200.0	100.0	H	321.0	-7.3
1422.500000	---	32.51	54.00	21.49	200.0	100.0	V	208.0	-6.6
1471.000000	42.41	---	74.00	31.59	200.0	200.0	V	224.0	-6.4
1636.000000	---	33.26	54.00	20.74	200.0	100.0	V	136.0	-5.4
1688.750000	43.86	---	74.00	30.14	200.0	100.0	H	95.0	-5.1
2030.500000	---	34.45	54.00	19.55	200.0	200.0	H	223.0	-3.2
2037.500000	44.54	---	74.00	29.46	200.0	100.0	V	48.0	-3.2
2746.250000	---	36.38	54.00	17.62	200.0	100.0	V	351.0	-0.2
2859.000000	47.55	---	74.00	26.45	200.0	200.0	H	143.0	0.4

**Remark: 1. Correction Factor = Antenna factor+ Insertion loss (cable loss + amplifier gain)**

### 5.3. Conducted Emission

#### Ambient condition

Temperature	Relative humidity	Pressure
23°C ~25°C	45%~50%	101.5kPa

#### Methods of Measurement

The EUT is placed on a non-metallic table of 80cm height above the horizontal metal reference ground plane. During the test, the EUT was operating in its typical mode. The test method is according to ANSI C63.10-2013. Connect the AC power line of the EUT to the L.I.S.N. Use EMI receiver to detect the average and Quasi-peak value. RBW is set to 9 kHz, VBW is set to 30kHz. The measurement result should include both L line and N line.

The test is in transmitting mode.

#### Test Setup

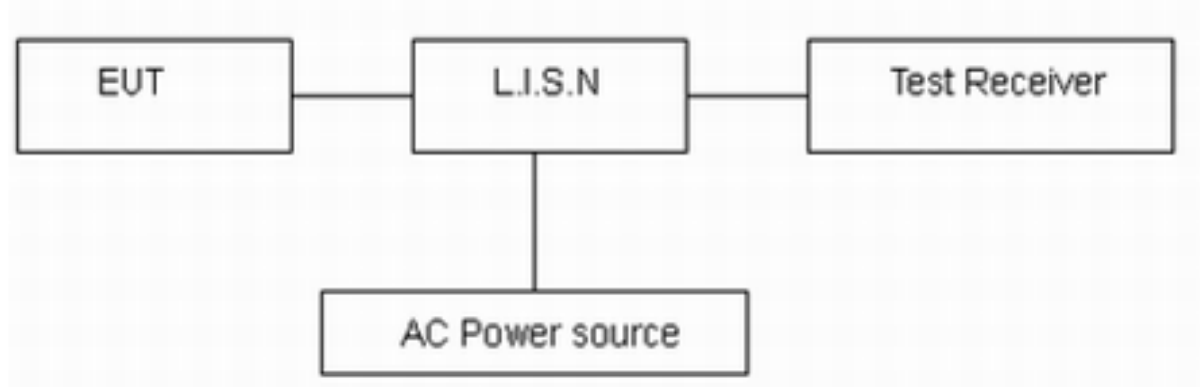

Note: AC Power source is used to change the voltage 110V/60Hz.

#### Limits

Frequency (MHz)	Conducted Limits(dBμV)	
	Quasi-peak	Average
0.15 - 0.5	66 to 56 *	56 to 46 *
0.5 - 5	56	46
5 - 30	60	50

\*: Decreases with the logarithm of the frequency.

#### Measurement Uncertainty

The assessed measurement uncertainty to ensure 95% confidence level for the normal distribution is with the coverage factor  $k = 1.96$ ,  $U = 2.69$  dB.

**Test Results:**

Following plots, Blue trace uses the peak detection and Green trace uses the average detection. During the test, the Conducted Emission was performed in all modes with all channels, 802.11g, Channel 1 are selected as the worst condition. The test data of the worst-case condition was recorded in this report.

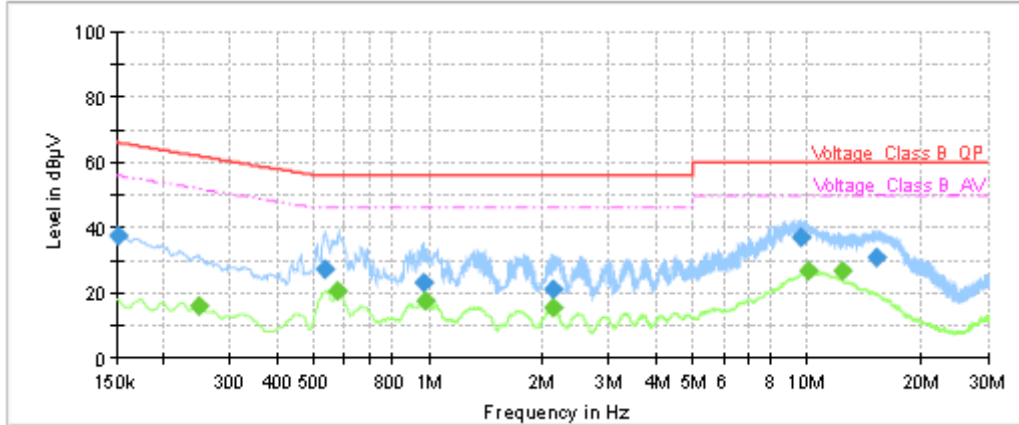

Frequency (MHz)	QuasiPeak (dBµV)	Average (dBµV)	Limit (dBµV)	Margin (dB)	Meas. Time (ms)	Bandwidth (kHz)	Line	Filter	Corr. (dB)
0.15	37.55	---	65.88	28.33	1000.0	9.000	L1	ON	19
0.25	---	15.76	51.87	36.11	1000.0	9.000	L1	ON	19
0.53	27.35	---	56.00	28.65	1000.0	9.000	L1	ON	19
0.58	---	20.43	46.00	25.57	1000.0	9.000	L1	ON	19
0.97	23.07	---	56.00	32.93	1000.0	9.000	L1	ON	19
0.98	---	17.40	46.00	28.60	1000.0	9.000	L1	ON	19
2.14	21.24	---	56.00	34.76	1000.0	9.000	L1	ON	19
2.14	---	15.48	46.00	30.52	1000.0	9.000	L1	ON	19
9.64	36.76	---	60.00	23.24	1000.0	9.000	L1	ON	19
10.03	---	26.44	50.00	23.56	1000.0	9.000	L1	ON	19
12.41	---	26.90	50.00	23.10	1000.0	9.000	L1	ON	19
15.30	30.90	---	60.00	29.10	1000.0	9.000	L1	ON	19

**Remark: Correct factor=cable loss + LISN factor**

L line Conducted Emission from 150 KHz to 30 MHz

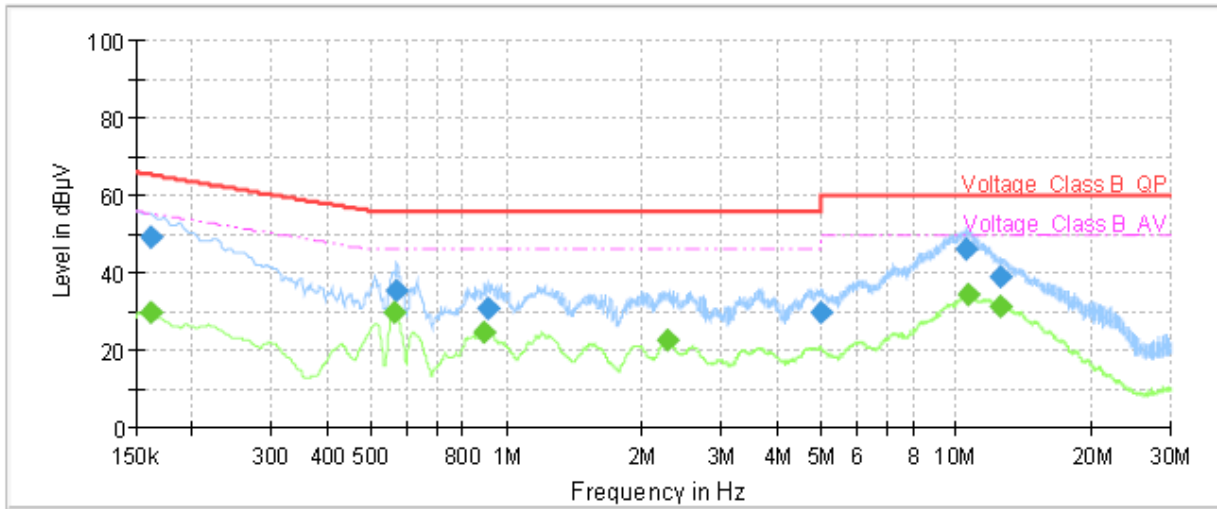

Frequency (MHz)	QuasiPeak (dBµV)	Average (dBµV)	Limit (dBµV)	Margin (dB)	Meas. Time (ms)	Bandwidth (kHz)	Line	Filter	Corr. (dB)
0.16	---	29.78	55.40	25.62	1000.0	9.000	N	ON	19
0.16	48.99	---	65.40	16.41	1000.0	9.000	N	ON	19
0.56	---	29.72	46.00	16.28	1000.0	9.000	N	ON	19
0.57	35.28	---	56.00	20.72	1000.0	9.000	N	ON	19
0.89	---	24.53	46.00	21.47	1000.0	9.000	N	ON	19
0.91	30.84	---	56.00	25.16	1000.0	9.000	N	ON	19
2.27	---	22.58	46.00	23.42	1000.0	9.000	N	ON	19
4.99	29.94	---	56.00	26.06	1000.0	9.000	N	ON	19
10.49	45.94	---	60.00	14.06	1000.0	9.000	N	ON	19
10.63	---	34.17	50.00	15.83	1000.0	9.000	N	ON	19
12.50	39.08	---	60.00	20.92	1000.0	9.000	N	ON	19
12.55	---	31.46	50.00	18.54	1000.0	9.000	N	ON	19

Remark: Correct factor=cable loss + LISN factor

N line Conducted Emission from 150 KHz to 30 MHz



## 6. Main Test Instruments

Name	Manufacturer	Type	Serial Number	Calibration Date	Expiration Date
Spectrum Analyzer	R&S	FSV30	100815	2019-12-15	2020-12-14
EMI Test Receiver	R&S	ESCI	100948	2019-05-19	2020-05-18
EMI Test Receiver	R&S	ESCI	100948	2020-05-18	2021-05-17
Loop Antenna	SCHWARZBECK	FMZB1519	1519-047	2017-09-26	2020-09-25
TRILOG Broadband Antenna	Schwarzbeck	VULB 9163	9163-201	2017-11-18	2020-11-17
Double Ridged Waveguide Horn Antenna	R&S	HF907	100126	2018-07-07	2020-07-06
Standard Gain Horn	ETS-Lindgren	3160-09	00102643	2018-06-20	2020-06-19
EMI Test Receiver	R&S	ESR	101667	2019-05-19	2020-05-18
EMI Test Receiver	R&S	ESR	101667	2020-05-18	2021-05-17
LISN	R&S	ENV216	101171	2018-12-15	2021-12-14
Spectrum Analyzer	Agilent	N9010A	MY47191109	2019-05-19	2020-05-18
Spectrum Analyzer	Agilent	N9010A	MY47191109	2020-05-18	2021-05-17
Power Meter	R&S	NRP2	104306	2019-05-19	2020-05-18
Power Meter	R&S	NRP2	104306	2020-05-18	2021-05-17
Power Sensor	R&S	NRP-Z21	104799	2019-05-19	2020-05-18
Power Sensor	R&S	NRP-Z21	104799	2020-05-18	2021-05-17
20dB Attenuator	Star River Highlight	UCL-TS2S-20	18013001	2019-12-15	2020-12-14
RF Cable	Agilent	SMA 15cm	0001	2019-12-13	2020-06-12
Software	R&S	EMC32	9.26.0	/	/

\*\*\*\*\*END OF REPORT \*\*\*\*\*